

Issue 202a EUROPEAN, ASIAN AND
BRITISH BUILT MACHINES

THE WORLD'S LARGEST RANGE OF PREMIUM MOTORCYCLE BRAKES AND CLUTCHES

Full range of UK-made
stainless steel braided
brake lines now in stock

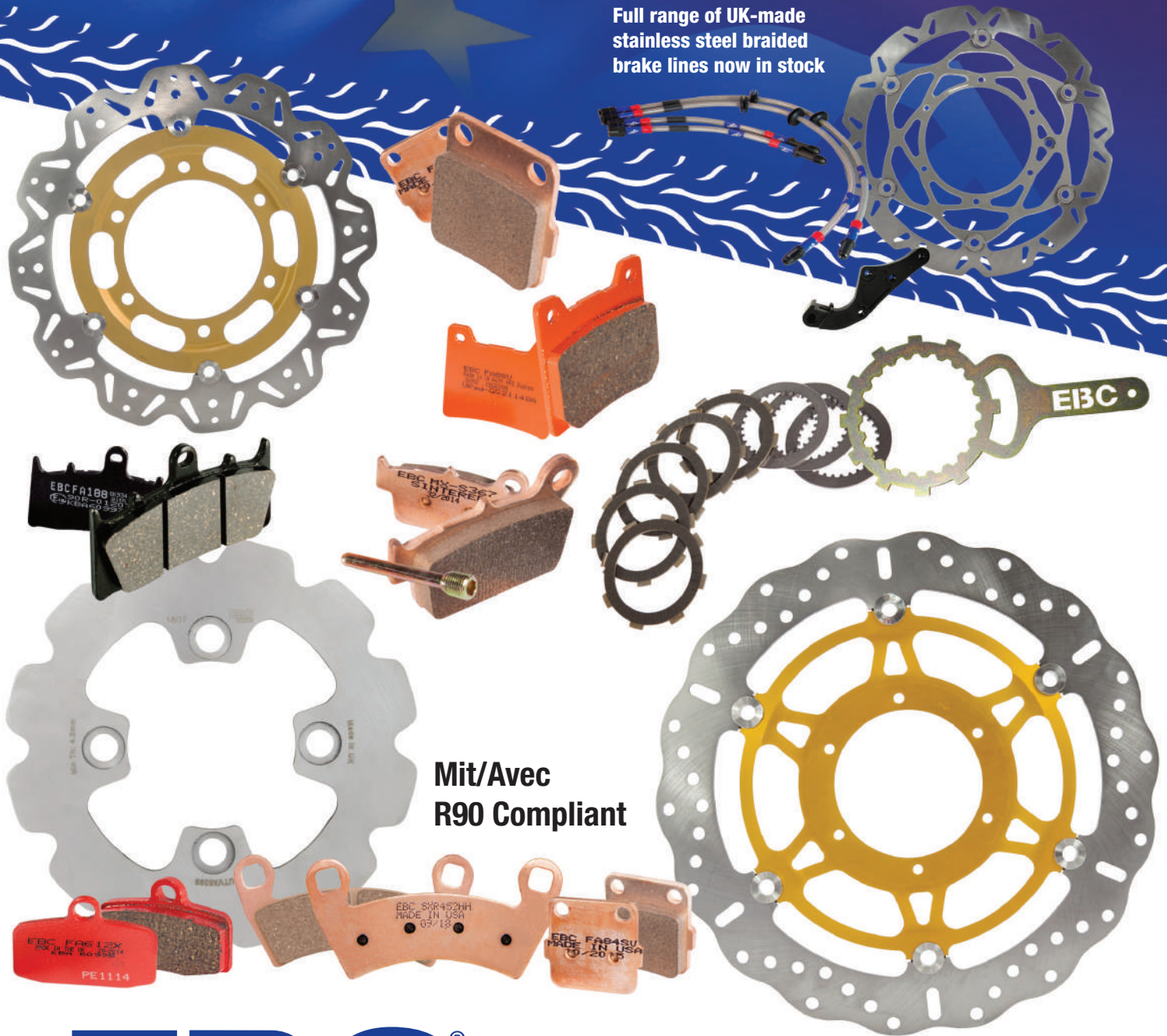

Mit/Avec
R90 Compliant

EBC[®]

BRAKES

Brake pads, discs, braided stainless brake lines,
clutches and much more, with four manufacturing
plants in the UK and USA producing over 10 million
components each year.

www.ebcbrakes.com

Welcome to your new catalogue from EBC Brakes with all of the new brakes and clutches you need for your customers.

With nearly 40 years in the motorcycle aftermarket, we can only thank again our thousands of loyal customers for their support through the years. Carrying EBC as an alternative product line to genuine parts continues to make good commercial sense, increases sales and offers a truly long-term solution to stocking aftermarket parts.

Our range of products for US built motorcycles has been updated and included once again in this catalogue.

2019 saw a change in the way that we produce and distribute our catalogues. This catalogue includes only the NEW products added to our range since the publication of the 2020 edition. This update-only catalogue is designed to supplement the 2020 Issue 202 edition; we will publish a full catalogue in 2022 which will be entitled Issue 203. An up to date full catalogue will always be available on our website on the catalogues page.

Once again **THANK YOU** and have a great 2021 selling season.



CATALOGUE COPYRIGHT

This catalogue forms a copyright under international law.

This includes, but is not limited to, the series of brake pad, brake shoe, clutch and brake disc design numbers with or without the prefixes FA, EPFA, GPFA, GPFAX, MXS, or suffixes R, HH, TT, SV. These design numbers, prefixes and suffixes form the toils of many years of work and set EBC products apart and are easily distinguished from other manufacturers brands or numbers.

Any copying, imitation, in full or in part, by any third party, will result in prosecution to the fullest extent of the law.

Also included within this catalogue are registered or applied for individual trademarks, such as:

- EBC
- Double-H
- Pro-lite
- SD-System
- Dirt Racer
- Street Racer
- DRC
- DRCF
- SRC
- SRK
- SV Series
- VLD Series
- VR Series
- UTVX
- SXR

All of the above are active trademarks and/or brands used by EBC Brakes licencees.

© Copyright 2021 - A C Freeman Investments Ltd (under application)

CONTENTS

BRAKE APPLICATIONS

American Produced Motorcycles.....	2-63	Pads for Aftermarket Calipers.....	183-185
Japanese Built Motorcycles.....	64-181	Non-Japanese Built Motorcycles.....	186-431
Road Racing Motorcycles.....	182		

BRAKE
APPLICATIONS

BRAKE PAD BUYERS GUIDE

Buyers Guide - Brake Pads.....	432-560
--------------------------------	---------

BRAKE PADS
BUYERS GUIDE

SHOE BUYERS GUIDE

Buyers Guide - Brake Shoes.....	561-587
Brake Shoe Illustrations.....	588-594
Diameter Chart - Brake Shoes.....	594

SHOE
BUYERS GUIDE

DISC BUYERS GUIDE

Buyers Guide - Streetbike Discs.....	595-693
Buyers Guide - Off Road Discs.....	694-735

DISC
BUYERS GUIDE

CLUTCH APPLICATIONS

Clutch Introduction Page.....	736
EBC Coil Spring Kits/Spring Tension Measuring Machine/EBC Diaphragm Clutch Springs.....	737
CKF Clutch Kits/DRC-F Clutch Kits/Clutch Removal Tools.....	738
Clutch Applications.....	739-783

CLUTCH
APPLICATIONS

BUYERS GUIDE CLUTCH

Buyers Guide - CK/CKF Clutch Kits.....	784-806
Buyers Guide - DRC/DRCF Kits.....	807-815
Buyers Guide - SRC Kits.....	816-823
Buyers Guide - SRK Kits.....	824-831
Buyers Guide - Clutch Removal Tools.....	832-849

CLUTCH
BUYERS GUIDE

BRAKE LINES

Brake Lines.....	850-864
------------------	---------

BRAKE
LINES

ACCESSORY PAGES

Pilot Jets.....	865-867	Baffle Pac Silencer Wool.....	871
Main Jets.....	868-869	Brake Fluid/Brake Caliper Lube.....	871
S & B Filters.....	869	Galindo & Baja Grips, Ledar Nozzles & Racing Reeds...872	
Hy-Tech Racing Reeds.....	870	Promotional Items.....	873-875

ACCESSORY
PAGES

MOTORCYCLE BRAKE PADS

Aramid Fiber Organic FA Series Pads

“TT” Pads

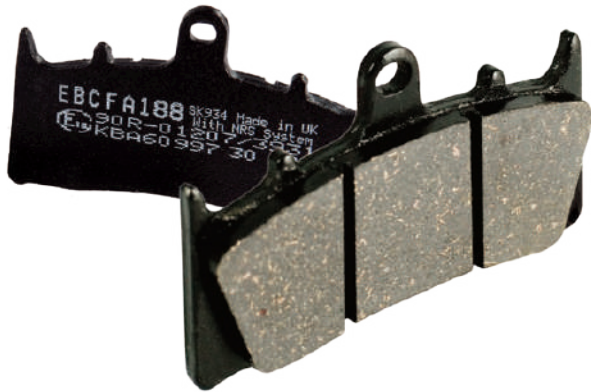

FA series organic brake pads will deliver fingertip stopping power and superb brake feel and control, the preferred choice for many sportbike riders. This compound has low disc attack characteristics and gives medium lifetime.

“TT” series moto-x sport and enduro pads, cool running based pad compound for sport use in moto-x and ATV applications. For mud, sand or wet conditions requiring longer life, use our sintered range below.

Double-H™ Pads

MXS Series Pads

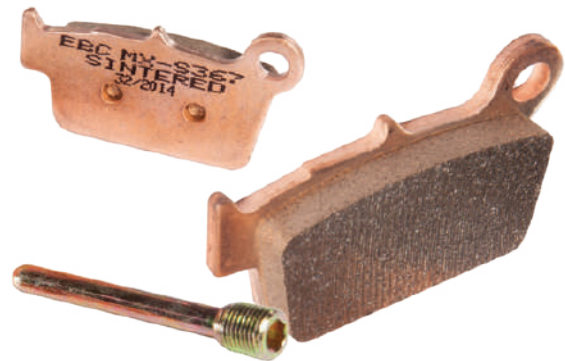
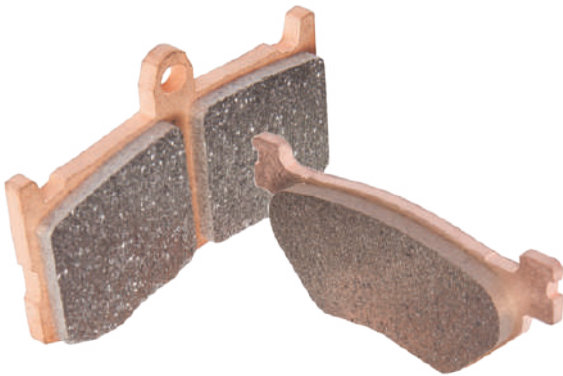

FA series with HH suffix, EBC’s American-made ultra high friction Double-H™ sintered copper alloy brake pads for maximum stopping power and lifetime. With stainless steel radiator plates to reduce heat transfer and double compact for wider pads.

“MXS” moto-x race pads, ultra high friction American-made sintered copper alloy with diamond ground surface finish for fast brake-in. With external hex drive slider pins, these pads are suitable for all fast moto-x riding.

“R” Series Pads

Semi-Sintered V-PAD™



“R” series American-made sintered copper alloy ATV and Moto-X replacement pads for sport and utility off road riding.

This semi-sintered brake pad combines the highest qualities of an organic brake pad with the endurance of a sintered equivalent brake pad. Designed for the heavy cruiser/streetbike market as a replacement brake pad. Can replace both sintered and organic pads.

MOTORCYCLE BRAKE PADS

EPFA Trackday Pads

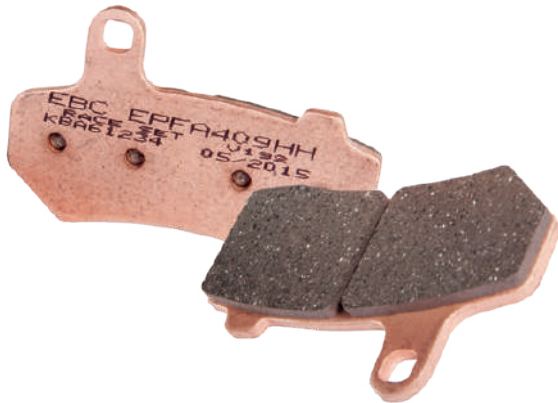

EPFA trackday pads give long life in street use with improved fade resistance and heat cycling plus improved noise characteristics, making this a great pad for heavy streetbikes and cruisers as well as faster superbikes. Great for intermittent track use.

GPFX Race Series Pads

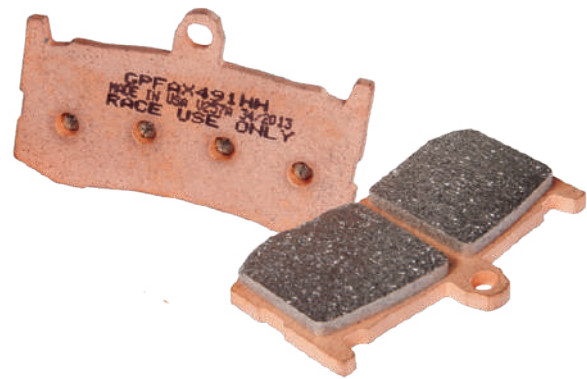

GPFX vacuum sintered ultra-high friction race pads are for sportbike asphalt racing and have been refined over the years to deliver one of the best brake race materials ever made. See page xii for full details.

SFA Organic Scooter Pads



A superb general replacement pad for urban use on scooter mopeds, mofas, mokicks and mopeds. Made using aramid fibres, these pads give above average lifetime, reduced disc wear characteristics and offer great value for money.

SFAC Carbon Scooter Pads



A high durability carbon organic compound giving higher pad performance and longer life for the mid to heavy scooter range. UK-made using 30% copper powder by weight with carbon granules.

SFA-HH Sintered Scooter Pads

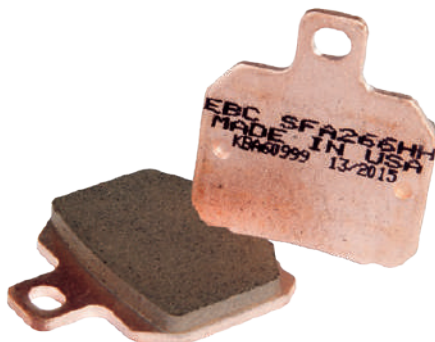

These American-made sintered scooter pads are long lasting with high performance HH rated stopping power for perfect braking – wet or dry. The HH pads target the faster and heavier scooter market and work well with stainless steel brake discs.

SXR Series Pads



SXR pads are sintered in a custom designed furnace to produce a premium blend of off-road race material that delivers high friction and heat stability. Available for all popular SXS models.

MOTORCYCLE BRAKE DISCS

X and XC Series Sportbike Discs

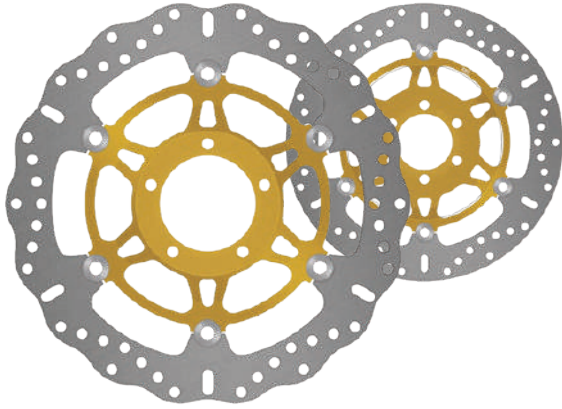

X and XC series discs feature mill hard stainless steel high friction rotor blades for maximum brake effect and are direct size for size replacements for OEM discs. These lightweight discs feature our patented SD system square drive button system.

VMD Classic Style Discs

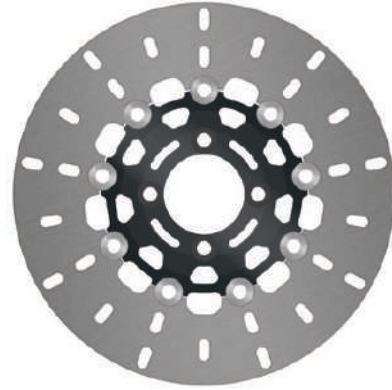

These lightweight, black anodised vintage discs are new to our range. The vintage fitment benefits from billet aluminium construction; lightweight, less unsprung weight enables better handling and stopping power. Perfect for the Café racer scene.

Sportbike VR Series Discs

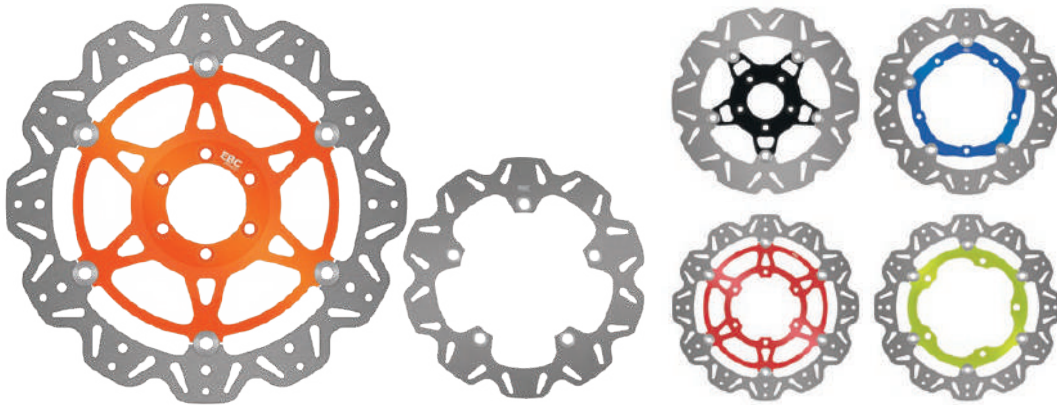

Vee profile lightweight discs with alloy hubs and ground stainless steel rotor blades for fast street bikes. Choose from black or coloured hub options as shown above. To order prefix with VR and suffix with chosen colour BLK, RED, BLU, GRN, GLD. For rear discs just the VR number.

Custom Finish VR Series Discs

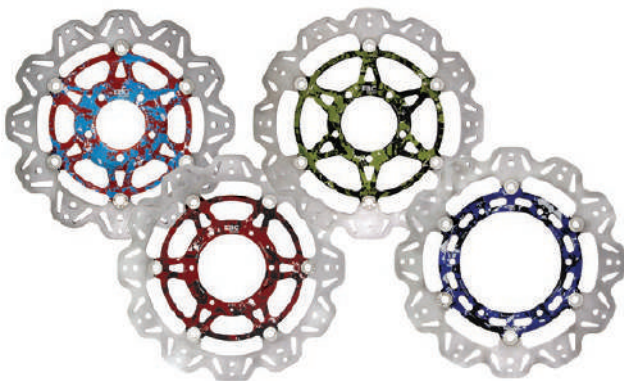

Special edition splatter anodised custom finish is applied to the centre hubs of our VR series discs by hand. The coating has the same resilience as other EBC disc finishes but with a radical and unique aesthetic. Colour options available: Light Blue, Red & White; Red, White & Black; Green, White & Black; Dark Blue, White & Black.

Supermoto Brake Disc

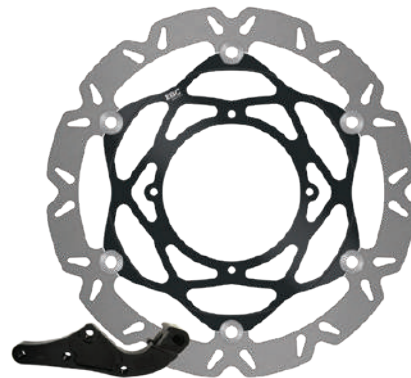

SMX 320mm rotor with vee contour design upgrade kits complete with caliper relocation bracket.

MOTORCYCLE BRAKE DISCS

MD Series Stainless Scooter Discs



Made from mill hard rolled steel, these discs are machined to match the original units, mechanically de-stressed to avoid rotor distortion, surface finished for precise smoothness.

VR Series Stainless Scooter Discs



Made in the UK using German mill rolled heat treated and precision ground stainless steel, the new VR series stainless profiled scooter sport discs are the lightest and best looking on the market and can be used with any type of brake pad.

UTVX Rotors for ATV/Quad/4x4



This new design greatly improves brake performance. Made in our British manufacturing facility using durable, tough German mill rolled stainless steel, heat treated and diamond ground to give great braking for less than OEM prices.

CX Extreme Off Road Discs



CX Extreme self-cleaning lightweight stainless discs are a size-for-size replacement/upgrade for front and rear fitment on all modern motocross machines.

Oversize MX Discs

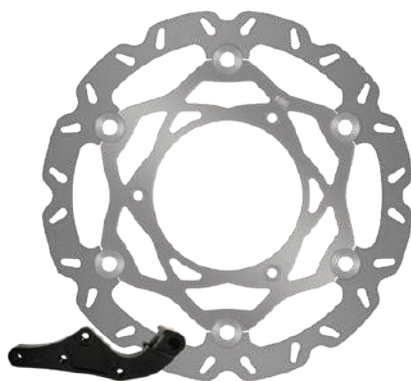

250 or 280mm motocross oversize disc kit complete with billet aluminium relocation brackets for improved brake power and control with vee contour design disc.

Rear Brake Discs

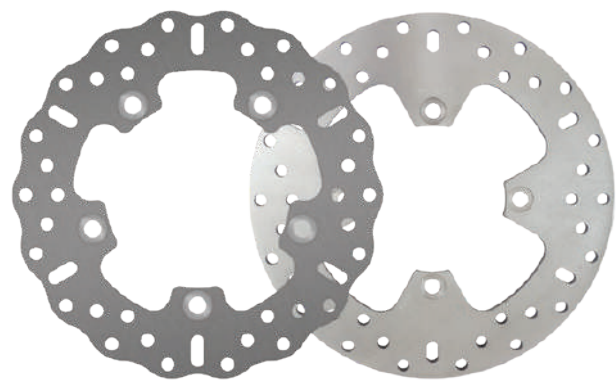

Made from stainless steel and available in full circle or contoured profile, suitable for performance street use or racing with new lightweight hole pattern construction.

MOTORCYCLE CLUTCH OPTIONS

CK/CKF Series Clutch Kits



CK complete engine sets of stack height controlled friction plates feature the EBC Brakes' unique alloy particle impregnated clutch facings that prevent burn up or slippage. CKF carbon fibre impregnated kits for ATV and moto-x use are built to last longer, grip and feel better than cork kits.

DRC/DRCF Series Clutch Kits



DRC is the ultimate clutch rebuild kit for your ATV and Moto-X machine. The DRCF kit swaps the stock type cork friction plates for a set of severe duty carbon fibre lined friction plates for better heat and wear abilities.

SRC/SRK Series Clutch Kits



SRC is an aramid fibre lined plate set with heavy duty clutch springs (diaphragm type springs included where required). Ideal for heavy sport bikes, faster riders and production based race use. SRK series includes a full engine set of aramid lined friction plates with clutch springs and steel separator plates.

CSK Coil & Diaphragm Clutch Kits



CSK sets include either coiled springs or diaphragm springs where appropriate. Coil springs are spiral wound with 4 to 8 pieces per set, made from heat treated high carbon steel delivering the right tension for your bike. Diaphragm springs are dish shaped flat steel pressure rings.

Clutch Removal Tools



**NOW MADE
IN STAINLESS
STEEL**

Made in the UK by EBC Brakes, these laser cut clutch tools make clutch removal, loosening of the drive shaft bolts and re-tightening a breeze, without any fear of damage to your expensive clutch basket. Tools can be extended to create more leverage if required with any simple workshop tool or tube. EBC Brakes produce a clutch tool for almost every clutch plate design known.

SXS Products from EBC BRAKES

The longest lasting, highest performing aftermarket pads and rotors for the SxS industry yet ...

All EBC Brakes pads for SxS fitments, both sintered and carbon X pads, are made with beefed-up pad thickness and DO NOT REQUIRE or accommodate the fitting of noise shims, offering even more available pad life for this tough application.

UTVX DISCS

- Lightweight • Profiled
- UK made • Heat treated stainless steel

NEW SXR PADS

- Vacuum sintered • Maximum grip
- Race performance • Longest wear life

SXR sintered pads are MADE IN THE USA using vacuum furnace sintering to deliver a refined and much longer lasting material blend.

SPORT CARBON TT PADS

also available for fast, dry riding using ENHANCED LIFE MATERIAL and enhanced pad thickness.
All parts are in stock at your favourite EBC Brakes distributor NOW for immediate delivery.

GO FAST STOP FAST

STEP UP FROM STOCK

Choose from our carbon graphite **X pads**, high-friction **SXR Race Pads** or severe duty **SV Series pads**.

Add these to our new stainless-steel **UTVX Rotors** for a great set of brakes to suit all of your riding styles.



Boost brake response even further with EBC Brakes' British-made **Stainless Steel Braided Brake Lines**.























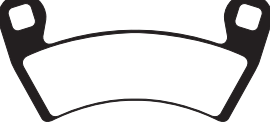



















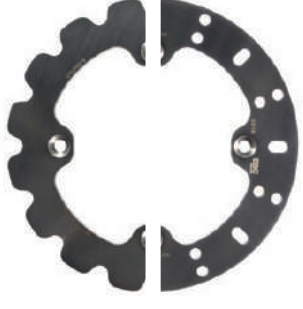

EBC
BRAKES

The World's No. 1 Name in Brakes www.ebcbrakes.com

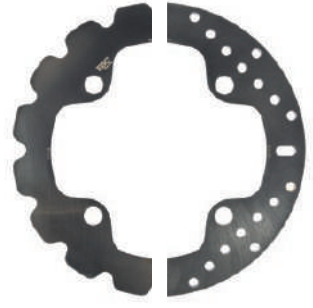
Part #	Make/Model	Year	Pad Position	EAN	Matching UTVX Disc		
					Front	Rear	
SXR135HH	CAN AM			5050953856174			
	Commander 800 R/XT/DPS/1000 STD/DPS/LTD/X/XT/XT-P	11-15	Front Right & Rear		UTVX6366	UTVX6366	
	Maverick 1000 STD/XRS	13	Front Left		UTVX6370	UTVX6370	
SXR159HH	POLARIS			5050953856198			
	570 Sportsman	11-15	Front		UTVX6202	UTVX6275	
	RZR 570	12-13	Rear		UTVX6312	UTVX6275	
	600/700/800 Sportsman 4 x 4	02-13	Front		UTVX6202	MD6201D	
	700/800 Sportsman EFI/X 2	07-14	Front		UTVX6202	UTVX6275	
	Ranger	99	Front		MD6149D	TBA	
	PPS/PTV 4 x 4/Series 10		Front		UTVX6202	MD6200D	
	PPS/PTV 6 x 6/Series 10		Front		MD6149D	MD6200D	
	PPS LUH 6 x 6	02	Front		MD6149D	MD6170D	
	SXR165HH	CAN AM			5050953856235		
Commander 800 R/XT/DPS		11-15	Front Left		UTVX6366	UTVX6366	
Commander 1000 STD/DPS/LTD/X/XT/XT-P		11-15	Front Left		UTVX6366	UTVX6366	
	Maverick 1000 STD/XRS	13	Front Left		UTVX6366	UTVX6370	
SXR307HH	BOMBARDIER			5050953856259			
	Outlander 300 HO/400/400 Max HO	03-06	Front Left		UTVX6222	UTVX6223	
	Outlander 650 HO Efi 4 x 4/HO Efi XT 4 x 4	06	Front Left		UTVX6222	UTVX6223	
	Outlander Max 650 HO Efi 4 x 4 HO Efi XT 4 x 4	06	Front Left		UTVX6222	UTVX6223	
	Outlander 800 (All models)	06	Front Left		UTVX6222	UTVX6223	
	Traxter (4 x 4)/XL (4 x 4)/XT (4 x 4)	01-04	Front Left		MD6229D	MD6230D	
	Traxter Autoshift	01-05	Front Left		MD6225D	MD6224D	
	Traxter Footshift	01	Front Left		MD6229D	MD6230D	
	Quest 500 (4 x 4)	02-04	Front Left		MD6224D	MD6225D	
	Traxter Max	03-05	Front Left		MD6245D	MD6225D	
	Quest 500/650 (2 x 4)/650 (4 x 4)/650 XT (4 x 4)	02-04	Front Left		MD6224D	MD6225D	
	Quest Max 650	03-	Front Left		MD6224D	MD6225D	
	DS 650/650 Baja/X	00-06	Front Left		MD6171D	MD6172D	
	Traxter Max 650/XL/Quest Max/STD/XT	04-05	Front Left		MD6245D	MD6225D	
		CAN AM					
	Maverick 1000 STD/XRS	13	Rear Left & Rear		UTVX6366	UTVX6370	
	Outlander 400/500/650/800/Max 400/500/650/800	07-15	Front Left & Rear		UTVX6222	UTVX6223	
	Renegade 500/800	07-12	Front Left & Rear		UTVX6223	UTVX6223	
	DS 650 X (3B7A/B)	07	Front Left & Rear		MD6171D	MD6172D	
	Renegade 800	08-11	Front Left & Rear		TBA	TBA	
	Buck/Trail Buck 500/650 EX/EXT	04-08	Rear Left		MD6245D	MD6225D	
	Commander 1000 R EFI	18-19	Rear Left		UTVX6411	UTVX6366	
	Commander Max 1000 - DPS/XT/LTD	14-15	Rear Left		TBA	UTVX6370	
	Maverick 1000 - STD/XRS/XRS/XDS - DPS/XMR/XXC	14-15	Rear Left		UTVX6411	UTVX6370	
	Maverick Max 1000 Std/1000 - XRS/XDS - DPS	14-17	Rear Left		UTVX6411	UTVX6370	
SXR317HH	BOMBARDIER			5050953856273			
	Outlander 300 HO/400/400 Max HO	03-06	Front Right		UTVX6222	UTVX6223	
	Outlander 650 HO Efi 4 x 4/HO Efi XT 4 x 4	06	Front Right		UTVX6222	UTVX6223	
	Outlander Max 650 HO Efi 4 x 4 HO Efi XT 4 x 4	06	Front Right		UTVX6222	UTVX6223	
	Outlander 800 (All models)	06	Front Right		UTVX6222	UTVX6223	
	Traxter (4 x 4) /XL (4 x 4)/XT (4 x 4)	01-04	Front Right		MD6229D	MD6230D	
	Traxter Autoshift	01-05	Front Right		MD6225D	MD6224D	
	Traxter Footshift	01	Front Right		MD6229D	MD6230D	
	Quest 500 (4 x 4)	02-04	Front Right		MD6224D	MD6225D	
	Traxter Max	03-05	Front Right		MD6245D	MD6225D	
	Quest 500/650 (2 x 4)/650 (4 x 4)/650 XT (4 x 4)	02-04	Front Right		MD6224D	MD6225D	
	Quest Max 650	03-	Front Right		MD6224D	MD6225D	
	DS 650/650 Baja/X	00-06	Front Right		MD6171D	MD6172D	
	Traxter Max 650/XL/Quest Max/STD/XT	04-05	Front Right		MD6245D	MD6225D	
		CAN AM					
	Maverick 1000 STD/XRS	13	Rear Right		UTVX6366	UTVX6370	
	Outlander 400/500/650/800/Max 400/500/650/800	07-15	Front Right & Rear		UTVX6222	UTVX6223	
	Renegade 500/800	07-12	Front Right & Rear		UTVX6223	UTVX6223	
	DS 650 X (3B7A/B)	07	Front Right & Rear		MD6171D	MD6172D	
	Renegade 800	08-11	Front Right & Rear		TBA	TBA	
	Buck/Trail Buck 500/650 EX/EXT	04-08	Front Right & Rear Right		MD6245D	MD6225D	
	Commander 1000 R EFI	18-19	Rear Right		UTVX6411	UTVX6366	
	Commander Max 1000 - DPS/XT/LTD	14-15	Rear Right		TBA	UTVX6370	
	Maverick 1000 - STD/XRS/XRS/XDS - DPS/XMR/XXC	14-15	Rear Right		UTVX6411	UTVX6370	
	Maverick Max 1000 Std/1000 - XRS/XDS - DPS	14-17	Rear Right		UTVX6411	UTVX6370	
SXR354HH	POLARIS			5050953856297			
	570 Sportsman Ace/Ace Euro	15-20	Rear		UTVX6202	UTVX6275	
	800 Ranger Crew	10-14	Rear		UTVX6338	UTVX6275	
SXR395HH	ARCTIC CAT			5050953856334			
	550 H1 Efi Prowler/650 H1 Prowler/650 Prowler 4 x 4/M4	07-09	Front		UTVX6271	N/A	
	HDX 500 LTD Prowler/Prowler/XT Prowler	14	Front		UTVX6271	N/A	
	XT 550/550 Prowler/650 H1 Prowler	06-14	Front		UTVX6271	N/A	
	HDX 700 Prowler/LTD Prowler/Trail	11-14	Front		UTVX6271	UTVX6173	
	Wildcat Trail 700 XT inc LTD	15-19	Front		UTVX6384	UTVX6384	
	XTX 700 H1 Efi/LE Prowler/700 Prowler	08-14	Front		UTVX6271	N/A	
	1000 H2 Mudpro Efi	10	Front		UTVX6173	UTVX6173	
	1000 Mudpro	10-13	Front		UTVX6271	UTVX6271	
	1000 TRV Cruiser/TRV H2 Efi/H2 Efi Cruiser	09-11	Front		UTVX6173	UTVX6173	
	Thundercat 1000 H2/H2 LE	08-10	Front		UTVX6173	UTVX6173	
	Wildcat 1000 GT	11-12	Front		UTVX6271	UTVX6173	
	Wildcat 1000 GT/LTD/X-LTD/X-LTD-EPS	13-16	Front		TBA	TBA	
	Wildcat X 1000/X-SE-EPS 1000	14-16	Front		TBA	UTVX6383	
	XTZ 1000 Prowler	10-14	Front		UTVX6271	UTVX6173	
	SXR452HH	POLARIS			5050953856358		
		500 Ranger (4 x 4 Efi)/(Carb) 2 x 4/Ranger Crew	08-13	Front		UTVX6202	UTVX6275
500 Ranger (Efi) 4 x 4 H.O.		09-11	Front		UTVX6338	UTVX6275	
RGR 570, Full Size (R06)		16	Front		UTVX6202	UTVX6275	
700 Ranger Crew (Efi) 4 x 4/6 x 4 Efi/XP 4 x 4		08-09	Front		UTVX6202	UTVX6275	
700 Ranger 4 x 4 Efi		09	Front		UTVX6338	UTVX6275	
800 Ranger/Efi/XP/Crew		10-14	Front		UTVX6338	UTVX6275	
800 Ranger 6 x 6		10-17	Front & Rear		UTVX6338	UTVX6275	
RZR-4 800 EPS		12	Front		UTVX6338	UTVX6275	

Part #	Make/Model	Year	Pad Position	EAN	Matching UTVX Disc	
					Front	Rear
	Ranger EV (Electric)	10-15	Front		UTVX6202	UTVX6275
	900 D Crew Ranger Diesel/Crew Ranger Diesel	11-14	Front		UTVX6338	UTVX6275
	900 (Ranger XP 900)	15-19	Front		UTVX6338	UTVX6275
	900 (Ranger XP 900)	13-14	Front		UTVX6338	UTVX6374
	Ranger Crew 900 All Options (R07)	16-19	Front & Rear		UTVX6338	UTVX6275
	1000 General EPS (2 Seat)	16	Front		UTVX6338	UTVX6338
	1000 General EPS PS MD (R09, R13, 2 Seat)	17-20	Front		UTVX6408	UTVX6408
	1000 General 4 EPS PS XP DLX (R01, R14, R18, 4 Seat)	17-20	Front		UTVX6338	UTVX6408
	1000 Ranger Diesel Crew	15	Front		UTVX6338	UTVX6275
	RZR XP 1000 (R11 EU/MD,R12, R14)	16-17	Front		UTVX6380	UTVX6380
	Brutus HD HDPTO (R03)	13-17	Front		UTVX6338	UTVX6275
SXR456HH	POLARIS			5050953856372		
	RZR 570/RZR 800 (Inc EPS Models)	08-14	Front		UTVX6312	UTVX6275
	RZR 570 S/EU/MD (R05)	14-19	Front		UTVX6338	UTVX6275
SXR610HH	ARCTIC CAT			5050953856396		
	Wildcat 4X/4X-LTD/4/4 LTD 1000	13-16	Front		UTVX6384	UTVX6384
SXR642HH	CAN AM			5050953856419		
	Commander 1000 R EFI	18-19	Front Left		UTVX6411	UTVX6366
	Commander Max 1000 - DPS/XT/LTD	14-15	Front Left		TBA	UTVX6370
	Maverick 1000 - STD/XRS/XRS/XDS - DPS/XMR/XXC	14-15	Front Left		UTVX6411	UTVX6370
	Maverick Max 1000 Std/1000 - XRS/XDS - DPS	14-17	Front Left		UTVX6411	UTVX6370
SXR645HH	CAN AM			5050953856433		
	Commander 1000 R EFI	18-19	Front Right		UTVX6411	UTVX6366
	Commander Max 1000 - DPS/XT/LTD	14-15	Front Right		TBA	UTVX6370
	Maverick 1000 - STD/XRS/XRS/XDS - DPS/XMR/XXC	14-15	Front Right		UTVX6411	UTVX6370
	Maverick Max 1000 - Std/1000 - XRS/XDS - DPS	14-17	Front Right		UTVX6411	UTVX6370
SXR651HH	CF MOTO (Side x Side)					
	1000 Z-Force	17-19	Rear		TBA	TBA
SXR656HH	POLARIS			5050953856457		
	570 Sportsman Ace/Ace Euro	15-20	Front		UTVX6202	UTVX6275
	570 Ranger Crew EFI	14-15	Front		UTVX6202	UTVX6275
	RGR 570, Full Size (R12/R06/R03)	17-20	Front		UTVX6202	UTVX6275
	RGR CRW 570 FS (R08/R05/R03)	16-20	Front		UTVX6202	UTVX6275
	RGR 570 EPS CRW MD (R04)/EFI CRW (R10/R03/R02)	17-20	Front		UTVX6202	UTVX6275
	RGR EV MD (R02)/EV LIION (R08/R03)/EV (R12/R03/R02)	16-19	Front		UTVX6202	TBA
	RGR 800 6X6 MD Poland (R02)	17-20	Front		UTVX6202	TBA
	RGR CRW 900 XP 6P SP (R10)/900 EPS (R03)/6P SP (R14)	17-19	Front		UTVX6338	TBA
	Ranger 902D EU Tractor R07	19-20	Front		UTVX6380	UTVX6338
	RZR XP 1000 S4 R02	18-20	Front		UTVX6380	UTVX6338
	900 Ranger Crew	10-15	Front		UTVX6338	UTVX6275
	1000 Ranger Diesel EU (R12)	15-20	Front		UTVX6338	UTVX6275
	RGR CRW 1000 XP PS MD (R08)/PS All Options (R32/R09)	17-18	Front		UTVX6338	UTVX6275
	RGR CRW 1000 XP 6P, PS, NB, MD (R08)/PS (R10)	17-20	Front		UTVX6338	UTVX6275
	RGR 1000 D Poland (R07)/D EU (R14) D Crew (R16)	17-18	Front		UTVX6338	UTVX6275
	Ranger Crew 1000 (R04, R06, R08, R11)	18-20	Front		UTVX6338	UTVX6275
	Ranger 1000 XP PS Crew Inc EU, EPS, HD, MD (R03, R09, R13, R20)	18-20	Front		UTVX6338	UTVX6275
	Ranger 1000 XP PS NSTR, Crew Mud (R15, R17, R18)	18-20	Front		UTVX6338	UTVX6275
	RGR 1000D (R17/R13)	17-18	Front		UTVX6338	UTVX6275
	MIL RZR2 XP MV 1000 TD (R01/R04)/TD NELO (R01)	17-18	Front		TBA	TBA
	RZR XP 900 (Inc EPS Models)/4 XP 900 All Options Inc Military/4 900 (R05)	11-17	Front		UTVX6338	MD6374D
	RZR 4 900 (R05, R12)	16-18	Front		UTVX6338	TBA
	RZR XP 1000 R35	12-19	Front		UTVX6380	UTVX6380
	RZR RS1/XP 4 1000/4 1000 MD	16-20	Front & Rear		UTVX6380	UTVX6380
	RZR XP/XP 4 Turbo/Turbo 4	16-20	Rear		UTVX6397	UTVX6397
	RZR XP Turbo/Latin/MD/S/Tractor/Turbo S/XP4 Turbo/Turbo Inti/Turbo MD	17-20	Rear		UTVX6380	UTVX6397
SXR657HH	POLARIS			5050953856471		
	RZR/RZR-S 900 (50"/60" All Options)	15-20	Front		UTVX6338	UTVX6338
	RZR 1000 60" PS EU/Tractor/Zug (R01, R06, R07, R09)	17-20	Front		UTVX6338	UTVX6338
SXR676HH	YAMAHA			5050953856495		
	YZZ 1000 R All Models	16-17	Front		UTVX6395	UTVX6395
SXR677HH	YAMAHA			5050953856518		
	YZZ 1000 R All Models	16-17	Rear		UTVX6395	UTVX6395
SXR680HH	POLARIS			5050953856532		
	RZR XP/XP 4 Turbo/Turbo 4	16-20	Front		UTVX6397	UTVX6397
	RZR XP/XP4	17-20	Front		UTVX6380	UTVX6397
SXR682HH	CAN AM			5050953856556		
	Defender 500cc/799cc/Max/976cc	16-19	Front Left		UTVX6396	UTVX6396
	Maverick Trail 800cc/1000cc EFI	18	Front Left		UTVX6396	UTVX6412
	Maverick X3/X3 Max	17-18	Front Left		UTVX6411	UTVX6412
SXR683HH	CAN AM			5050953856570		
	Defender 500cc/799cc/Max/976cc	16-19	Front Right		UTVX6396	UTVX6396
	Maverick Trail 800cc/1000cc EFI	18	Front Right		UTVX6396	UTVX6412
	Maverick X3/X3 Max	17-18	Front Right		UTVX6411	UTVX6412
SXR684HH	CAN AM			5050953856594		
	Defender 799cc/976cc	16-19	Rear Left		UTVX6396	UTVX6396
SXR685HH	CAN AM			5050953856617		
	Defender 799cc/976cc	16-19	Rear Right		UTVX6396	UTVX6396
SXR701HH	HONDA			5050953856631		
	Pioneer 1000 SXS (2/4 seat)	16-18	Front Left		UTVX6410	UTVX6410
	SXS Talon 1000 R	19-20	Front Left		UTVX6397	UTVX6425
SXR702HH	HONDA			5050953856655		
	Pioneer 1000 SXS (2/4 seat)	16-18	Front Right		UTVX6410	UTVX6410
	SXS Talon 1000 R	19-20	Front Right		UTVX6397	UTVX6425
SXR703HH	HONDA			5050953856679		
	Pioneer 1000 SXS (2/4 seat)	16-18	Rear Left		UTVX6410	UTVX6410
	SXS Talon 1000 R	19-20	Rear Left		UTVX6397	UTVX6425
SXR704HH	HONDA			5050953856693		
	Pioneer 1000 SXS (2/4 seat)	16-18	Rear Right		UTVX6410	UTVX6410
	SXS Talon 1000 R	19-20	Rear Right		UTVX6397	UTVX6425
SXR726HH	CF MOTO (Side x Side)					
	1000 Z-Force	17-19	Front		TBA	TBA
SXR728HH	POLARIS			5050953868986		
	RZR XP4 Turbo S/XP Turbo S Velocity	19-20	Front		UTVX6380	UTVX6397

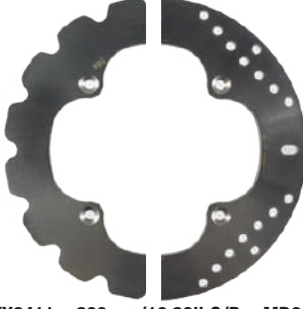
 SXR135HH - 77.3/96.7mm wide	 SXR159HH - 97mm wide	 SXR165HH - 77.3/96.7mm wide	 SXR307HH - 82/62mm wide
 SXR317HH - 82/62mm wide	 SXR354HH - 97mm wide	 SXR395HH - 95mm wide	 SXR452HH - 121mm wide
 SXR456HH - 97.1mm wide	 SXR610HH - 135.6mm wide	 SXR642HH - 104/88mm wide	 SXR645HH - 104/88mm wide
 SXR651HH - 72.73mm wide	Hardened Steel Backplate  SXR656HH - 121mm wide	 SXR657HH - 98mm wide	 SXR676HH - 113.8mm wide
 SXR677HH - 104mm wide	 SXR680HH - 158mm wide	 SXR682HH - 117.35/95.2mm wide	 SXR683HH - 117.35/95.2mm wide
 SXR684HH - 101.5/83.05mm wide	 SXR685HH - 101.5/83.05mm wide	 SXR701HH - 115.1mm wide	 SXR702HH - 115.1mm wide
 SXR703HH - 81.8mm wide	 SXR704HH - 81.8mm wide	 SXR726HH - 101.5mm wide	 SXR728HH - 163.6mm wide

		
UTVX6173 – 202mm/7.95" O/D – MD6173	UTVX6202 – 228mm/8.98" O/D – MD6202	UTVX6271 – 252mm/9.92" O/D – MD6271
		
UTVX6275 – 218mm/8.58" O/D – MD6275	UTVX6312 – 235mm/9.25" O/D – MD6312	UTVX6338 – 220mm/8.93" O/D – MD6338
		
UTVX6366 – 215mm/8.46" O/D – MD6366	UTVX6370 – 215mm/8.46" O/D – MD6370	UTVX6374 – 218mm/8.58" O/D – MD6374
		
UTVX6380 – 245mm/9.64" O/D – MD6380	UTVX6384 – 252mm/9.92" O/D – MD6384	UTVX6395 – 245mm/9.64" O/D – MD6395
		
UTVX6408 – 227mm/8.94" O/D – MD6408	UTVX6410 – 210mm/8.27" O/D – MD6410	UTVX6411 – 260mm/10.23" O/D – MD6411
		
UTVX6412 – 247.5mm/9.74" O/D – MD6412		

GPFX Full Race Pads

PART #	BRIEF FITMENT
GPFX016HH	AP/LOCKHEED CALIPERS / DUCATI 750 Sport / TRIUMPH (MERIDEN MODELS)
GPFX184HH	ISR AFTERMARKET CALIPERS
GPFX197HH	KAWASAKI Ninja 300 & 400
GPFX218HH	BREMBO CALIPERS
GPFX244HH	BREMBO CALIPERS / APRILIA early Dosoduro, RSV & Tuono models / DUCATI 748, 848, 916, 996, 998 models
GPFX263HH	AP LOCKHEED CALIPERS / PFM CALIPERS
GPFX295HH	BREMBO CALIPERS
GPFX296HH	HONDA CBR600 all F & RR3/4 models, CB1000R / KAWASAKI ZX6-R (636cc) Ninja 13-20
GPFX347HH	HONDA RS125 Radial caliper, NSF250R Moto3 / KAWASAKI ZX9-R & Z900 / MORIWAKI MD250H 08-13 / YAMAHA TZ250 Radial Caliper 02-10
GPFX379HH	KAWASAKI ZX10R 08-15, Ninja H2-SX 18-20 / SUZUKI GSXR 600/750 04-10, GSXR 1000 04-11
GPFX380HH	YAMAHA YZ-R6/R1 04-20
GPFX390HH	HONDA CBR 600 RR5 on Radial Caliper 05-16, CBR 1000 RR 05-16, CB 1000 R 09-15
GPFX417/4HH	KAWASAKI ZX6R (600cc) 07-16, ZZR1400 06-20
GPFX435/4HH	AP LOCKHEED CALIPERS / BREMBO RADIAL CALIPERS / PVM REAR CALIPERS
GPFX442/4HH	YAMAHA YZ-R1 Six Piston Radial Caliper 07-14
GPFX447HH	BREMBO CALIPERS / APRILIA RSV410-20, Tuono 17-20 / BENELLI Tornado, Bimota DB8, 9&11 / BMW HP2 Sport, HP4 13-20 / DUCATI Desmodici 2008, 1098, 1198, 1199 & 1299 Panigale / ENERGICA Electric / HONDA CBR1000RR SP 14-20, RC213V-S 15-18 / KAWASAKI H2 Ninja 15-16, ZX-10R 16-20, Ninja H2 17-20, ZX-10RR 17 / KTM RC8 08-15 / MV AUGUSTA 998/1000/1078 F4R/RR / SUZUKI GSXR600/750/1000 11-20 / TRIUMPH 675R
GPFX491HH	TRIUMPH Daytona 675 09-17
GPFX604/4HH	BMW S 1000 RR 10-18 / TRIUMPH Daytona 765 Moto2
GPFX611HH	BREMBO CALIPERS
GPFX630HH	DUCATI 899, V2 955cc, 959 Panigale models / KAWASAKI Z H2 / KTM 890 Duke R / INDIAN FTR1200
GPFX646HH	BREMBO CALIPERS
GPFX662HH	YAMAHA YZ-F R3 Rear 15-20
GPFX663HH	YAMAHA YZ-F R3 Front 15-20
GPFX673HH	BREMBO CALIPERS
GPFX700HH	HONDA CBR600RR 17-20, CBR1000R/RR Tokico Caliper 17-20
GPFX724HH	BMW S1000 R/RR Sport & M Sport 18-20
GPFX730HH	BREMBO CALIPERS

BURNISH & SNUB STOPS

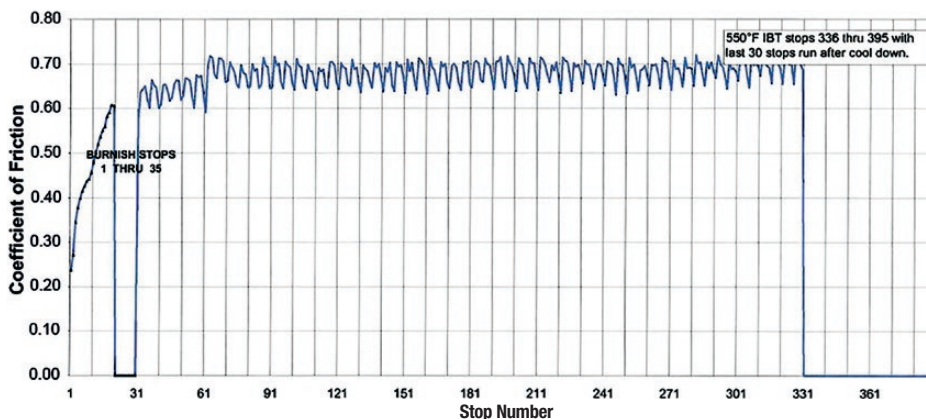

These pads bed in fast and deliver extremely high friction linear performance in track use. GPFX pads are high friction but highly stable in stop. This means pads are powerful and predictable time after time when the brake is applied in race use. The “in-stop” friction fall off is almost zero and can hardly be noticed at the lever meaning the brakes offer superb control. The EBC dyno is set to duplicate race conditions at the Road America race track and represents a true simulation of race brake demand. The number of race teams using GPFX grows annually and for 2021 the exact same formulation developed through 2019 is used again.

EBC pads are developed in our own laboratory and tested using this race track simulator dynamometer to guarantee perfection before being thoroughly field tested on dozens of race teams.



Catalogue - Issue 202a

**AMERICAN, EUROPEAN, ASIAN AND
BRITISH BUILT MACHINES**

FRONT: AMERICAN PRODUCED MOTORCYCLES

This symbol indicates a rotor made of billet steel, and should be only used with EBC FA Kevlar® Organic or Vee pads.

		FRONT					FRONT ROTOR OPTIONS	
		PADS	PADS	PADS	PADS		DESIGN NO.	
SUFFIX OR PREFIX PAD MATERIALS AND DESCRIPTION		FA	V	HH/R	EPFA			
YEAR		Kevlar Organic Pads	Semi-Sintered V-Pads™	Double-H™ USA-Made Sintered Pads	Premium Low Noise Street Sintered Pads			See Buyers Guide for rotor style & finish options. Part nos for ordering & sizing.
HARLEY DAVIDSON® TRUCK								
F-150 Pick Up Truck Special Edition	00-04	DP61259					GD7130	1
HARLEY-DAVIDSON® ELECTRIC								2
LiveWire	18-21			FA630HH*	EPFA630HH*			3
HARLEY-DAVIDSON® SPORTSTER								4
XL, XLH, XLCH, XLS, XLX	54-78							5
XLH, XLCH Rivet Type	73-77	FA026						6
79-81 Twin front caliper	79-81	FA071*	FA071V*					7
82-83 Twin Girling caliper	82-83	FA071*	FA071V*					8
84-Early 87 Girling caliper	84-87	FA094	FA094V	FA094HH			002	9
Late 87-99	87-99	FA094	FA094V	FA094HH			002	10
XL 50 50th Anniversary Sportster <i>Enlarge rotor available – see buyer's guide</i>	07	FA381	FA381V	FA381HH	EPFA381HH		001	11
XLH 883 Sportster <i>Enlarge rotor available – see buyer's guide</i>	00-03	FA400	FA400V	FA400HH	EPFA400HH		001	12
XLH 883 R Sportster Flat Track <i>Enlarge rotor available – see buyer's guide</i>	00-03	FA400	FA400V	FA400HH	EPFA400HH		001	13
XL 883 Sportster Hugger <i>Enlarge rotor available – see buyer's guide</i>	00-03	FA400	FA400V	FA400HH	EPFA400HH		001	14
XL 53c Sportster Custom (883cc) <i>Enlarge rotor available – see buyer's guide</i>	00-03	FA400	FA400V	FA400HH	EPFA400HH		001	15
XL 883 Sportster Standard <i>Enlarge rotor available – see buyer's guide</i>	04-08	FA381	FA381V	FA381HH	EPFA381HH		001	16
XL 883 C Sportster Custom <i>Enlarge rotor available – see buyer's guide</i>	04-10	FA381	FA381V	FA381HH	EPFA381HH		001	17
XL 883 L Low <i>Enlarge rotor available – see buyer's guide</i>	04-10	FA381	FA381V	FA381HH	EPFA381HH		001	18
XL 883 L Superlow <i>Enlarge rotor available – see buyer's guide</i>	11-13	FA381	FA381V	FA381HH	EPFA381HH		001	19
XL 883 L Superlow Cast Wheel	14-20	FA640	FA640V	FA640HH	EPFA640HH		015	20
XL 883 N Iron <i>Enlarge rotor available – see buyer's guide</i>	09-10	FA381	FA381V	FA381HH	EPFA381HH		001	21
XL 883 N Iron Cast Wheel <i>Enlarge rotor available – see buyer's guide</i>	11-13	FA381	FA381V	FA381HH	EPFA381HH		001	22
XL 883 N Iron Cast Wheel	14-18	FA640	FA640V	FA640HH	EPFA640HH		015	23
XL 883 N Iron	16-21	FA640	FA640V	FA640HH	EPFA640HH		MD530	24
XL 883 R 100th Anniversary Edition <i>Enlarge rotor available – see buyer's guide</i>	03	FA400*	FA400V*	FA400HH*	EPFA400HH*		001	25
XL 883 R Sportster R <i>Enlarge rotor available – see buyer's guide</i>	05-13	FA381*	FA381V*	FA381HH*	EPFA381HH*		001	26
XL 883 R Roadster <i>Enlarge rotor available – see buyer's guide</i>	10	FA381*	FA381V*	FA381HH*	EPFA381HH*		001	27
XL 883 R Roadster Cast Wheel <i>Enlarge rotor available – see buyer's guide</i>	11-13	FA381*	FA381V*	FA381HH*	EPFA381HH*		001	28
XL 883 R Roadster Cast Wheel	14-15	FA640	FA640V	FA640HH	EPFA640HH		015	29
XL 1200 C Sportster Custom <i>Enlarge rotor available – see buyer's guide</i>	00-03	FA400	FA400V	FA400HH	EPFA400HH		001	30
XL 1200 S Sportster Sport <i>Enlarge rotor available – see buyer's guide</i>	00-03	FA400*	FA400V*	FA400HH*	EPFA400HH*		001	31
XL 1200 R Sportster Roadster <i>Enlarge rotor available – see buyer's guide</i>	04-08	FA381*	FA381V*	FA381HH*	EPFA381HH*		001	32
XL 1200 C Sportster Custom <i>Enlarge rotor available – see buyer's guide</i>	04-10	FA381	FA381V	FA381HH	EPFA381HH*		001	33
XL 1200 C Sportster Custom Cast & Spoke Wheel <i>Enlarge rotor available – see buyer's guide</i>	11-13	FA381	FA381V	FA381HH	EPFA381HH*		001	34
XL 1200 C Custom Spoke Wheel	14-21	FA640	FA640V	FA640HH	EPFA640HH		015	35
XL 1200 CX Roadster	16-21	FA640*	FA640V*	FA640HH*	EPFA640HH*		015	36
XL 1200 L Sportster Low Spoke Wheel <i>Enlarge rotor available – see buyer's guide</i>	07-11	FA381	FA381V	FA381HH	EPFA381HH		001	37
XL 1200 L Sportster Low Cast Wheel <i>Enlarge rotor available – see buyer's guide</i>	07-11	FA381	FA381V	FA381HH	EPFA381HH		001	38
XL 1200 N Nightster Spoke Wheel <i>Enlarge rotor available – see buyer's guide</i>	08-12	FA381	FA381V	FA381HH	EPFA381HH		001	39
XL 1200 T Superlow	14-21	FA640	FA640V	FA640HH	EPFA640HH		015	40
XL 1200 V Seventy Two <i>Enlarge rotor available – see buyer's guide</i>	12-13	FA381	FA381V	FA381HH	EPFA381HH		001	41
XL 1200 V Seventy Two	14-16	FA640	FA640V	FA640HH	EPFA640HH		015	42
XL 1200 X Forty Eight <i>Enlarge rotor available – see buyer's guide</i>	10-13	FA381	FA381V	FA381HH	EPFA381HH		001	43
XL 1200 X Forty Eight	14-21	FA640	FA640V	FA640HH	EPFA640HH		015	44
XR 1200	08-10			FA296HH*	EPFA296HH*		012	45
XR 1200 X	10-12			FA296HH*	EPFA296HH*		012	46
RH 1250 S Sportster S	21-22		FA630V	FA630HH				47
HARLEY-DAVIDSON® STREET								48
XG 500 Street 494cc	14-15	FA643	FA643V	FA643HH			MD531	49
XG 500 Street 300mm Discs	16-21	FA209/2	FA209/2V	FA209/2HH			022	50
XG 750 Street 749cc	14-15	FA643	FA643V	FA643HH			MD531	51
XG 750 Street 300mm Discs	16-21	FA209/2	FA209/2V	FA209/2HH			022	52
XG 750 Street Rod 300mm Discs	17-21	FA209/2	FA209/2V	FA209/2HH			022	53
								54
								55
								56
								57
								58
								59

*-2 Sets Required. ■ - Also available in MX-S race compound. **SAFETY WARNING:- DO NOT USE HH PADS ON REAR UNLESS ALSO USED ON FRONT TO AVOID BRAKE IMBALANCE**

REAR: AMERICAN PRODUCED MOTORCYCLES

Line #	SUFFIX OR PREFIX PAD MATERIALS AND DESCRIPTION	YEAR	FRONT				FRONT ROTOR OPTIONS
			PADS	PADS	PADS	PADS	
			FA Kevlar Organic Pads	V Semi-Sintered V-Pads™	HH/R Double-H™ USA-Made Sintered Pads	EPFA Premium Low Noise Street Sintered Pads	DESIGN NO. <small>See Buyers Guide for rotor style & finish options. Part nos for ordering & sizing.</small>
HARLEY DAVIDSON® TRUCK							
1	F-150 Pick Up Truck Special Edition	00-04	DP61633				GD7154
HARLEY-DAVIDSON® ELECTRIC							
4	LiveWire	18-21	FA266		FA266HH	EPFA266HH	
HARLEY-DAVIDSON® SPORTSTER							
7	XL, XLH, XLCH, XLS, XLX	54-78					
8	XLH, XLCH Rivet Type	73-77	FA072	FA072V			
9	79-81 Twin front caliper	79-81	FA072	FA072V			
10	82-83 Twin Girling caliper	82-83	FA078	FA078V			
11	84-Early 87 Girling caliper	84-87	FA078	FA078V	FA078HH		
12	Late 87-99	87-99	FA200	FA200V	FA200HH	EPFA200HH	004
13	XL 50 50th Anniversary Sportster	07	FA387	FA387V	FA387HH	EPFA387HH	003
14	XLH 883 Sportster	00-03	FA400	FA400V	FA400HH	EPFA400HH	003
15	XLH 883 R Sportster Flat Track	00-03	FA400	FA400V	FA400HH	EPFA400HH	003
16	XL 883 Sportster Hugger	00-03	FA400	FA400V	FA400HH	EPFA400HH	003
17	XL 53c Sportster Custom (883cc)	00-03	FA400	FA400V	FA400HH	EPFA400HH	003
18	XL 883 Sportster Standard	04-08	FA387	FA387V	FA387HH	EPFA387HH	003
19	XL 883 C Sportster Custom	04-10	FA387	FA387V	FA387HH	EPFA387HH	003
20	XL 883 L Low	04-10	FA387	FA387V	FA387HH	EPFA387HH	003
21	XL 883 L Superlow	11-13	FA387	FA387V	FA387HH	EPFA387HH	013
22	XL 883 L Superlow Cast Wheel	14-20	FA254	FA254V	FA254HH	EPFA254HH	013
23	XL 883 N Iron	09-10	FA387	FA387V	FA387HH	EPFA387HH	003
24	XL 883 N Iron Cast Wheel	11-13	FA387	FA387V	FA387HH	EPFA387HH	013
25	XL 883 N Iron Cast Wheel	14-18	FA254	FA254V	FA254HH	EPFA254HH	013
26	XL 883 N Iron	16-21	FA254	FA254V	FA254HH	EPFA254HH	013
27	XL 883 R 100th Anniversary Edition	03	FA400	FA400V	FA400HH	EPFA400HH	003
28	XL 883 R Sportster R	05-13	FA387	FA387V	FA387HH	EPFA387HH	003
29	XL 883 R Roadster	10	FA387	FA387V	FA387HH	EPFA387HH	003
30	XL 883 R Roadster Cast Wheel	11-13	FA387	FA387V	FA387HH	EPFA387HH	013
31	XL 883 R Roadster Cast Wheel	14-15	FA254	FA254V	FA254HH	EPFA254HH	013
32	XL 1200 C Sportster Custom	00-03	FA400	FA400V	FA400HH	EPFA400HH	003
33	XL 1200 S Sportster Sport	00-03	FA400	FA400V	FA400HH	EPFA400HH	003
34	XL 1200 R Sportster Roadster	04-08	FA387	FA387V	FA387HH	EPFA387HH	003
35	XL 1200 C Sportster Custom	04-10	FA387	FA387V	FA387HH	EPFA387HH	003
36	XL 1200 C Sportster Custom Cast & Spoke Wheel	11-13	FA387	FA387V	FA387HH	EPFA387HH	003
37	XL 1200 C Custom Spoke Wheel	14-21	FA254	FA254V	FA254HH	EPFA254HH	013
38	XL 1200 CX Roadster	16-21	FA254	FA254V	FA254HH	EPFA254HH	013
39	XL 1200 L Sportster Low Spoke Wheel	07-11	FA387	FA387V	FA387HH	EPFA387HH	003
40	XL 1200 L Sportster Low Cast Wheel	07-11	FA387	FA387V	FA387HH	EPFA387HH	013
41	XL 1200 N Nightster Spoke Wheel	08-12	FA387	FA387V	FA387HH	EPFA387HH	003
42	XL 1200 T Superlow	14-21	FA254	FA254V	FA254HH	EPFA254HH	013
43	XL 1200 V Seventy Two	12-13	FA387	FA387V	FA387HH	EPFA387HH	003
44	XL 1200 V Seventy Two	14-16	FA254	FA254V	FA254HH	EPFA254HH	013
45	XL 1200 X Forty Eight	10-13	FA387	FA387V	FA387HH	EPFA387HH	003
46	XL 1200 X Forty Eight	14-21	FA254	FA254V	FA254HH	EPFA254HH	013
47	XR 1200	08-10	FA387	FA387V	FA387HH	EPFA387HH	013
48	XR 1200 X	10-12	FA387	FA387V	FA387HH	EPFA387HH	013
49	RH 1250 S Sportster S	21-22	TBC	TBC	TBC		
HARLEY-DAVIDSON® STREET							
52	XG 500 Street 494cc	14-15		FA643V	FA643HH		MD532
53	XG 500 Street 300mm Discs	16-21		FA181V	FA181HH		023
54	XG 750 Street 749cc	14-15		FA643V	FA643HH		MD532
55	XG 750 Street 300mm Discs	16-21		FA181V	FA181HH		023
56	XG 750 Street Rod 300mm Discs	17-21		FA181V	FA181HH		023

All names & numbers are for reference purposes only. © Registered trademarks of Harley—Davidson® Motor Corp or Buell.

Recommended Fittings: FA400 for use on polished chrome show rotors. FA400HH recommended fitting as replacement for OE.

NOTE: — Some models may have a second rotor fitted as an optional extra. Please double check with your customer exactly which side the front rotor is fitted and if twin rotor or single.

**BRAKE
APPLICATIONS**

*-2 Sets Required. ■ - Also available in MX-S race compound. **SAFETY WARNING:- DO NOT USE HH PADS ON REAR UNLESS ALSO USED ON FRONT TO AVOID BRAKE IMBALANCE**

Part numbers, prefixes, suffixes, photos and illustrations shown in this catalogue are trademarks and/or copyrights of EBC Brakes or the trademark owner A C Freeman Investments Ltd and use without express written permission of the owners is punishable by law.

FRONT: AMERICAN PRODUCED MOTORCYCLES

* This symbol indicates a rotor made of billet steel, and should be only used with EBC FA Kevlar® Organic or Vee pads.

		FRONT					Line #
		PADS	PADS	PADS	PADS	FRONT ROTOR OPTIONS	
		FA	V	HH/R	EPFA	DESIGN NO.	
SUFFIX OR PREFIX PAD MATERIALS AND DESCRIPTION		Kevlar Organic Pads	Semi-Sintered V-Pads™	Double-H™ USA-Made Sintered Pads	Premium Low Noise Street Sintered Pads	See Buyers Guide for rotor style & finish options. Part nos for ordering & sizing.	
HARLEY-DAVIDSON® DYNA							
YEAR							
FX, FXE Rivet type	73-77	FA026					1
FX, FXE, FXS Late 78-83	78-83	FA071	FA071V				2
FX, FXE, FXS	84-86	FA094*	FA094V*	FA094HH*	EPFA094HH*	002	3
FXWG, FXSB	83	FA071	FA071V				4
FL, FLH	49-71						5
FL, FLH	58-62						6
FL, FLH Banana caliper	72-84	FA024/2	FA024/2V				7
FL, FLH Banana caliper	72-80	FA024/2	FA024/2V				8
FL, FLH	81-84	FA024/2	FA024/2V				9
FXD/L/WG, FXR/S/T/D/LR	82-83	FA071	FA071V				10
FXD/L/WG, FXR/S/T/D/R	84-Early 87	FA094*	FA094V*	FA094HH*	EPFA094HH*	002	11
FXD/L/WG, FXR/S/T/D, FXLR <i>Oversize rotor available – see buyer's guide</i>	Late 87-99	FA094*	FA094V*	FA094HH*	EPFA094HH*	002	12
FLD Switchback	12-16		FA457V	FA457HH	EPFA457HH	007	13
FXD Super Glide <i>Oversize rotor available – see buyer's guide</i>	00-03	FA400	FA400V	FA400HH	EPFA400HH	001	14
FXD Super Glide Cast Wheel <i>Oversize rotor available – see buyer's guide</i>	08-10		FA457V	FA457HH	EPFA457HH	007	15
FXDF Fat Bob Cast Wheel <i>Oversize rotor available – see buyer's guide</i>	08-17		FA457V*	FA457HH*	EPFA457HH*	009	16
FXDX Super Glide Sport <i>Oversize rotor available – see buyer's guide</i>	00-03	FA400*	FA400V*	FA400HH*	EPFA400HH*	001	17
FXDL Low Rider <i>Oversize rotor available – see buyer's guide</i>	00-03	FA400*	FA400V*	FA400HH*	EPFA400HH*	001	18
FXDWG Wide Glide <i>Oversize rotor available – see buyer's guide</i>	00-03	FA400*	FA400V*	FA400HH*	EPFA400HH*	001	19
FXDWG Wide Glide Spoke Wheel <i>Oversize rotor available – see buyer's guide</i>	08		FA457V	FA457HH	EPFA457HH	009	20
FXDS-CON Dyna Convertible <i>Oversize rotor available – see buyer's guide</i>	00-02	FA400*	FA400V*	FA400HH*	EPFA400HH*	001	21
FXDXT Superglide T-Sport <i>Oversize rotor available – see buyer's guide</i>	01-03	FA400*	FA400V*	FA400HH*	EPFA400HH*	001	22
FXDi Super Glide 1450 <i>Oversize rotor available – see buyer's guide</i>	04-05	FA400	FA400V	FA400HH	EPFA400HH	001	23
FXDi 35 5th Anniversary Super Glide Spoke Wheel <i>Oversize rotor available – see buyer's guide</i>	06	FA400	FA400V	FA400HH	EPFA400HH	009	24
FXDXi Super Glide Sport <i>Oversize rotor available – see buyer's guide</i>	04-05	FA400*	FA400V*	FA400HH*	EPFA400HH*	001	25
FXDLi Low Rider 1450 <i>Oversize rotor available – see buyer's guide</i>	04-05	FA400	FA400V	FA400HH	EPFA400HH	001	26
FXDLi Dyna Low Rider Spoke Wheel <i>Oversize rotor available – see buyer's guide</i>	06	FA400	FA400V	FA400HH	EPFA400HH	009	27
FXDWGi Wide Glide 1450 <i>Oversize rotor available – see buyer's guide</i>	04-05	FA400	FA400V	FA400HH	EPFA400HH	001	28
FXDWGi Dyna Wide Glide Spoke Wheel <i>Oversize rotor available – see buyer's guide</i>	06-07	FA400	FA400V	FA400HH	EPFA400HH	009	29
FXDWG Dyna Wide Glide Spoke Wheel <i>Oversize rotor available – see buyer's guide</i>	08-20		FA457V	FA457HH	EPFA457HH	009	30
FXDC/FXDCi Super Glide Custom <i>Oversize rotor available – see buyer's guide</i>	05	FA400	FA400V	FA400HH	EPFA400HH	001	31
FXDCi Dyna Superglide Custom Spoke Wheel <i>Oversize rotor available – see buyer's guide</i>	06-07	FA400	FA400V	FA400HH	EPFA400HH	009	32
FXDC Super Glide Custom Spoke Wheel <i>Oversize rotor available – see buyer's guide</i>	08-14		FA457V	FA457HH	EPFA457HH	009	33
FXDBi Street Bob Spoke Wheel <i>Oversize rotor available – see buyer's guide</i>	06-07	FA400	FA400V	FA400HH	EPFA400HH	009	34
FXDB Street Bob Spoke Wheel	08-21		FA457V	FA457HH	EPFA457HH	009	35
FXDBC Street Bob LTD	16		FA457V*	FA457HH*	EPFA457HH*	009	36
FXDi Super Glide Cast Wheel <i>Oversize rotor available – see buyer's guide</i>	06-07	FA400	FA400V	FA400HH	EPFA400HH	007	37
FXDLi Low Rider Cast Wheel	06-07	FA400	FA400V	FA400HH	EPFA400HH	007	38
FXDLi Low Rider Spoke Wheel <i>Oversize rotor available – see buyer's guide</i>	06-07	FA400	FA400V	FA400HH	EPFA400HH	009	39
FXDL Low Rider Cast Wheel	08-13		FA457V	FA457HH	EPFA457HH	007	40
FXDL Low Rider Spoke Wheel <i>Oversize rotor available – see buyer's guide</i>	08-09		FA457V	FA457HH	EPFA457HH	009	41
FXDL Low Rider Cast Wheel <i>Oversize rotor available – see buyer's guide</i>	14-17		FA457V*	FA457HH*	EPFA457HH*	007	42
FXDL Low Rider Spoke Wheel <i>Oversize rotor available – see buyer's guide</i>	14-17		FA457V*	FA457HH*	EPFA457HH*	009	43
FXDCi Superglide Custom Cast Wheel <i>Oversize rotor available – see buyer's guide</i>	06	FA400	FA400V	FA400HH	EPFA400HH	007	44
HARLEY-DAVIDSON® SOFTAIL							
FXSTB/C/S, FLST/G/F/S/N <i>Oversize rotor available – see buyer's guide</i>	84-Early 87	FA094	FA094V	FA094HH	EPFA094HH	002	47
FXSTB/C/S, FLST/G/F/S/N	Late 87-99	FA094	FA094V	FA094HH	EPFA094HH	002	48
FXST/FXSTi Softail Standard	00-05	FA400	FA400V	FA400HH	EPFA400HH	001	49
FXSTB/FXSTBi Night Train <i>Oversize rotor available – see buyer's guide</i>	00-05	FA400	FA400V	FA400HH	EPFA400HH	001	50
FXSTDi/FXSTDi Softail Deuce/i	00-07	FA400	FA400V	FA400HH	EPFA400HH	001	51
FXSTS/FXSTSi Softail Springer	00-05	FA094	FA094V	FA094HH	EPFA094HH	002	52
FLSTF/FLSTFi Fat Boy	00-06	FA400	FA400V	FA400HH	EPFA400HH	001	53
FLSTFi Fat Boy 15th Anniversary Edition <i>Oversize rotor available – see buyer's guide</i>	05	FA400	FA400V	FA400HH	EPFA400HH	001	54
FLSTF/FLSTFi Fat Boy <i>Oversize rotor available – see buyer's guide</i>	07	FA400	FA400V	FA400HH	EPFA400HH	001	55
FLSTF Fat Boy <i>Oversize rotor available – see buyer's guide</i>	08-14		FA457V	FA457HH	EPFA457HH	001	56
FLSTF Fat Boy <i>Oversize rotor available – see buyer's guide</i>	15-17			FA296HH	EPFA296HH	MD530	57
FLFB Fat Boy <i>Oversize rotor available – see buyer's guide</i>	18			FA296HH	EPFA296HH	MD530	58
FLSTFB Fat Boy LO <i>Oversize rotor available – see buyer's guide</i>	10-14		FA457V	FA457HH	EPFA457HH	001	59

*-2 Sets Required. ■ - Also available in MX-S race compound. **SAFETY WARNING:- DO NOT USE HH PADS ON REAR UNLESS ALSO USED ON FRONT TO AVOID BRAKE IMBALANCE**

REAR: AMERICAN PRODUCED MOTORCYCLES

Line #	SUFFIX OR PREFIX PAD MATERIALS AND DESCRIPTION	YEAR	FRONT				
			PADS	PADS	PADS	PADS	FRONT ROTOR OPTIONS
			FA Kevlar Organic Pads	V Semi-Sintered V-Pads™	HH/R Double-H™ USA-Made Sintered Pads	EPFA Premium Low Noise Street Sintered Pads	DESIGN NO. <small>See Buyers Guide for rotor style & finish options. Part nos for ordering & sizing.</small>
HARLEY-DAVIDSON® DYNA							
1	FX, FXE Rivet type	73-77	FA024/2	FA024/2V			
2	FX, FXE, FXS Late 78-83	78-83	FA024/2	FA024/2V			
3	FX, FXE, FXS	84-86	FA078	FA078V	FA078HH		
4	FXWG, FXSB	83	FA078	FA078V	FA078HH		
5	FL, FLH	49-71					
6	FL, FLH	58-62					
7	FL, FLH Banana caliper	72-84	FA024/2	FA024/2V			
8	FL, FLH Banana caliper	72-80	FA024/2	FA024/2V			
9	FL, FLH	81-84	FA079	FA079V			
10	FXD/L/WG, FXR/S/T/D/LR	82-83	FA078	FA078V	FA078HH		
11	FXD/L/WG, FXR/S/T/D/R	84-Early 87	FA078	FA078V	FA078HH		
12	FXD/L/WG, FXR/S/T/D, FXLR	Late 87-99	FA200	FA200V	FA200HH	EPFA200HH	004
13	FLD Switchback	12-16		FA458V	FA458HH	EPFA458HH	003
14	FXD Super Glide	00-03	FA400	FA400V	FA400HH	EPFA400HH	003
15	FXD Super Glide Cast Wheel	08-10		FA458V	FA458HH	EPFA458HH	003
16	FXDF Fat Bob Cast Wheel	08-17		FA458V	FA458HH	EPFA458HH	003
17	FXDX Super Glide Sport	00-03	FA400	FA400V	FA400HH	EPFA400HH	003
18	FXDL Low Rider	00-03	FA400	FA400V	FA400HH	EPFA400HH	003
19	FXDWG Wide Glide	00-03	FA400	FA400V	FA400HH	EPFA400HH	003
20	FXDWG Wide Glide Spoke Wheel	08		FA458V	FA458HH	EPFA458HH	003
21	FXDS-CON Dyna Convertible	00-02	FA400	FA400V	FA400HH	EPFA400HH	003
22	FXDXT Superglide T-Sport	01-03	FA400	FA400V	FA400HH	EPFA400HH	003
23	FXDi Super Glide 1450	04-05	FA400	FA400V	FA400HH	EPFA400HH	003
24	FXDi 35 35th Anniversary Super Glide Spoke Wheel	06	FA400	FA400V	FA400HH	EPFA400HH	003
25	FXDXi Super Glide Sport	04-05	FA400	FA400V	FA400HH	EPFA400HH	003
26	FXDLi Low Rider 1450	04-05	FA400	FA400V	FA400HH	EPFA400HH	003
27	FXDLi Dyna Low Rider Spoke Wheel	06	FA400	FA400V	FA400HH	EPFA400HH	003
28	FXDWGi Wide Glide 1450	04-05	FA400	FA400V	FA400HH	EPFA400HH	003
29	FXDWGi Dyna Wide Glide Spoke Wheel	06-07	FA400	FA400V	FA400HH	EPFA400HH	003
30	FXDWG Dyna Wide Glide Spoke Wheel	08-20		FA458V	FA458HH	EPFA458HH	003
31	FXDC/FXDCi Super Glide Custom	05	FA400	FA400V	FA400HH	EPFA400HH	003
32	FXDCi Dyna Superglide Custom Spoke Wheel	06-07	FA400	FA400V	FA400HH	EPFA400HH	003
33	FXDC Super Glide Custom Spoke Wheel	08-14		FA458V	FA458HH	EPFA458HH	003
34	FXDBi Street Bob Spoke Wheel	06-07	FA400	FA400V	FA400HH	EPFA400HH	003
35	FXDB Street Bob Spoke Wheel	08-21		FA458V	FA458HH	EPFA458HH	003
36	FXDBC Street Bob LTD	16		FA458V	FA458HH	EPFA458HH	003
37	FXDi Super Glide Cast Wheel	06-07	FA400	FA400V	FA400HH	EPFA400HH	003
38	FXDLi Low Rider Cast Wheel	06-07	FA400	FA400V	FA400HH	EPFA400HH	003
39	FXDLi Low Rider Spoke Wheel	06-07	FA400	FA400V	FA400HH	EPFA400HH	003
40	FXDL Low Rider Cast Wheel	08-13		FA458V	FA458HH	EPFA458HH	003
41	FXDL Low Rider Spoke Wheel	08-09		FA458V	FA458HH	EPFA458HH	003
42	FXDL Low Rider Cast Wheel	14-17		FA458V	FA458HH	EPFA458HH	003
43	FXDL Low Rider Spoke Wheel	14-17		FA458V	FA458HH	EPFA458HH	003
44	FXDCi Superglide Custom Cast Wheel	06	FA400	FA400V	FA400HH	EPFA400HH	003
HARLEY-DAVIDSON® SOFTAIL							
47	FXST/B/C/S, FLST/C/F/S/N	84-Early 87	FA078	FA078V	FA078HH		
48	FXST/B/C/S, FLST/C/F/S/N	Late 87-99	FA200	FA200V	FA200HH	EPFA200HH	004
49	FXST/FXSTi Softail Standard	00-05	FA400	FA400V	FA400HH	EPFA400HH	003
50	FXSTB/FXSTBi Night Train	00-05	FA400	FA400V	FA400HH	EPFA400HH	003
51	FXSTDi/FXSTDi Softail Deuce/i	00-07	FA400	FA400V	FA400HH	EPFA400HH	003
52	FXSTS/FXSTSi Softail Springer	00-05	FA400	FA400V	FA400HH	EPFA400HH	003
53	FLSTF/FLSTFi Fat Boy	00-06	FA400	FA400V	FA400HH	EPFA400HH	003
54	FLSTFi Fat Boy 15th Anniversary Edition	05	FA400	FA400V	FA400HH	EPFA400HH	003
55	FLSTF/FLSTFi Fat Boy	07	FA434	FA434V	FA434HH	EPFA434HH	003
56	FLSTF Fat Boy	08-14		FA458V	FA458HH	EPFA458HH	003
57	FLSTF Fat Boy	15-17		FA458V	FA458HH	EPFA458HH	003
58	FLFB Fat Boy	18		FA710V	FA710HH	EPFA710HH	016
59	FLSTFB Fat Boy LO	10-14		FA458V	FA458HH	EPFA458HH	003

All names & numbers are for reference purposes only. © Registered trademarks of Harley—Davidson® Motor Corp or Buell.

Recommended Fittings: FA400 for use on polished chrome show rotors. FA400HH recommended fitting as replacement for OE.

NOTE: — Some models may have a second rotor fitted as an optional extra. Please double check with your customer exactly which side the front rotor is fitted and if twin rotor or single.

**BRAKE
APPLICATIONS**

*-2 Sets Required. ■ - Also available in MX-S race compound. **SAFETY WARNING:- DO NOT USE HH PADS ON REAR UNLESS ALSO USED ON FRONT TO AVOID BRAKE IMBALANCE**

Part numbers, prefixes, suffixes, photos and illustrations shown in this catalogue are trademarks and/or copyrights of EBC Brakes or the trademark owner A C Freeman Investments Ltd and use without express written permission of the owners is punishable by law.

FRONT: AMERICAN PRODUCED MOTORCYCLES

* This symbol indicates a rotor made of billet steel, and should be only used with EBC FA Kevlar® Organic or Vee pads.

		FRONT					Line #
		PADS	PADS	PADS	PADS	FRONT ROTOR OPTIONS	
SUFFIX OR PREFIX PAD MATERIALS AND DESCRIPTION		FA	V	HH/R	EPFA	DESIGN NO.	
YEAR		Kevlar Organic Pads	Semi-Sintered V-Pads™	Double-H™ USA-Made Sintered Pads	Premium Low Noise Street Sintered Pads	See Buyers Guide for rotor style & finish options. Part nos for ordering & sizing.	
HARLEY-DAVIDSON® SOFTAIL							
FLSTFB Fat Boy LO	15-17			FA296HH	EPFA296HH	MD530	1
FLFBS Fat Boy 114	18-22			FA296HH	EPFA296HH	MD530	2
FLFBS Fat Boy 114 Anniversary	18			FA296HH	EPFA296HH	MD530	3
FLSTCI/FLSTC Heritage Classic/i	00-07	FA400	FA400V	FA400HH	EPFA400HH	001	4
FLSTS Heritage Springer	00-03	FA094	FA094V	FA094HH	EPFA094HH	001	5
FLSTN/FLSTNi Softail Deluxe	05-07	FA400	FA400V	FA400HH	EPFA400HH	001	6
FLSTSC/FLSTSCi Springer Classic	05-07	FA094	FA094V	FA094HH	EPFA094HH	001	7
FLST/FLSTI Heritage Softail	06	FA400	FA400V	FA400HH	EPFA400HH	001	8
FLSTSB Softail Cross Bones	08-11	FA094	FA094V	FA094HH	EPFA094HH	001	9
FXST/FXSTI Softail Standard	06-07	FA400	FA400V	FA400HH	EPFA400HH	001	10
FXST Softail Standard	08-14		FA457V	FA457HH	EPFA457HH	001	11
FXST Softail Standard	15			FA296HH	EPFA296HH	015	12
FXST Softail Standard	19-22			FA296HH	EPFA296HH	015	13
FXSTB/FXSTBi Night Train Softail	06-07	FA400	FA400V	FA400HH	EPFA400HH	001	14
FXSTB Night Train Spoke Wheel	08-09		FA457V	FA457HH	EPFA457HH	001	15
FXSTC Softail Custom	07	FA400	FA400V	FA400HH	EPFA400HH	001	16
FXSTC Softail Custom Spoke Wheel	08-10		FA457V	FA457HH	EPFA457HH	001	17
FLSTSC/FLSTSCi Springer Softail Classic	06-07	FA094	FA094V	FA094HH	EPFA094HH	001	18
FLSTC Heritage Softail Classic	07	FA400	FA400V	FA400HH	EPFA400HH	001	19
FLSTC Heritage Softail Classic	08-14		FA457V	FA457HH	EPFA457HH	001	20
FLSTC Heritage Softail Classic	15-17			FA296HH	EPFA296HH	015	21
FLHC Heritage Classic	18-20			FA296HH	EPFA296HH	015	22
FLHCS Heritage Classic 114	18-22			FA296HH	EPFA296HH	015	23
FLHCS Heritage Classic 114 Anniversary	18-20			FA296HH	EPFA296HH	015	24
FLSTN Softail Deluxe Spoke Wheel	08-14		FA457V	FA457HH	EPFA457HH	001	25
FLSTN Softail Deluxe	15-17			FA296HH	EPFA296HH	015	26
FLS Softail Slim	12-14		FA457V	FA457HH	EPFA457HH	001	27
FLS Softail Slim	15-17			FA296HH	EPFA296HH	015	28
FLSL Softail Slim	18-20			FA296HH	EPFA296HH	015	29
FXCW Rocker Cast Wheel	08-09		FA457V	FA457HH	EPFA457HH	001	30
FXCWC Rocker C Cast Wheel	08-11		FA457V	FA457HH	EPFA457HH	001	31
FXS Blackline	11-13		FA457V	FA457HH	EPFA457HH	001	32
FXSB Breakout	13-14		FA457V	FA457HH	EPFA457HH	001	33
FXSB Breakout	15-17			FA296HH	EPFA296HH	MD530	34
FXBR Breakout	18-20			FA296HH	EPFA296HH	MD530	35
FXBRS Breakout 114	18-21			FA296HH	EPFA296HH	MD530	36
FXBRS Breakout 114 Anniversary	18-20			FA296HH	EPFA296HH	MD530	37
FLDE Deluxe	18-20			FA296HH	EPFA296HH	015	38
FXBB Street Bob	18-21			FA296HH	EPFA296HH	015	39
FXFB Fat Bob	18-20			FA296HH	EPFA296HH	MD530	40
FXBS Fat Boy	18-21			FA296HH	EPFA296HH	MD530	41
FXLRS Low Rider S	18-22			FA296HH	EPFA296HH	0155	42
FXDR 114	18-21			FA296HH	EPFA296HH	MD530BLK	43
HARLEY-DAVIDSON® S SERIES							
FLSB Sport Glide 1745	18-22			FA296HH	EPFA296HH	015	46
FLSS Softail Slim S	16-20			FA296HH	EPFA296HH		47
FLSTFBS Fat Boy S	16-18			FA296HH	EPFA296HH		48
FXDLS Dyna Low Rider S	17		FA457V*	FA457HH*	EPFA457HH*	007	49
							50
							51
							52
							53
							54
							55
							56
							57
							58
							59

*-2 Sets Required. ■ - Also available in MX-S race compound. **SAFETY WARNING:- DO NOT USE HH PADS ON REAR UNLESS ALSO USED ON FRONT TO AVOID BRAKE IMBALANCE**

REAR: AMERICAN PRODUCED MOTORCYCLES

Line #	SUFFIX OR PREFIX PAD MATERIALS AND DESCRIPTION	YEAR	FRONT				FRONT ROTOR OPTIONS DESIGN NO. <small>See Buyers Guide for rotor style & finish options. Part nos for ordering & sizing.</small>
			PADS	PADS	PADS	PADS	
			FA Kevlar Organic Pads	V Semi-Sintered V-Pads™	HH/R Double-H™ USA-Made Sintered Pads	EPFA Premium Low Noise Street Sintered Pads	
HARLEY-DAVIDSON® SOFTTAIL							
1	FLSTFB Fat Boy LO	15-17		FA458V	FA458HH	EPFA458HH	003
2	FLFBS Fat Boy 114	18-21		FA710V	FA710HH	EPFA710HH	016
3	FLFBS Fat Boy 114 Anniversary	18		FA710V	FA710HH	EPFA710HH	016
4	FLSTC/FLSTC Heritage Classic/i	00-07	FA400	FA400V	FA400HH	EPFA400HH	003
5	FLSTS Heritage Springer	00-03	FA400	FA400V	FA400HH	EPFA400HH	003
6	FLSTN/FLSTNi Softail Deluxe	05-07	FA400	FA400V	FA400HH	EPFA400HH	003
7	FLSTSC/FLSTSCi Springer Classic	05-07	FA400	FA400V	FA400HH	EPFA400HH	003
8	FLST/FLSTI Heritage Softail	06	FA400	FA400V	FA400HH	EPFA400HH	003
9	FLSTSB Softail Cross Bones	08-11		FA458V	FA458HH	EPFA458HH	003
10	FXST/FXSTI Softail Standard	06-07	FA434	FA434V	FA434HH	EPFA434HH	003
11	FXST Softail Standard	08-14		FA458V	FA458HH	EPFA458HH	003
12	FXST Softail Standard	15		FA458V	FA458HH	EPFA458HH	003
13	FXST Softail Standard	19-22		FA710V	FA710HH	EPFA710HH	003
14	FXSTB/FXSTBi Night Train Softail	06-07	FA434	FA434V	FA434HH	EPFA434HH	003
15	FXSTB Night Train Spoke Wheel	08-09		FA458V	FA458HH	EPFA458HH	003
16	FXSTC Softail Custom	07	FA434	FA434V	FA434HH	EPFA434HH	003
17	FXSTC Softail Custom Spoke Wheel	08-10		FA458V	FA458HH	EPFA458HH	003
18	FLSTSC/FLSTSCi Springer Softail Classic	06-07	FA400	FA400V	FA400HH	EPFA400HH	003
19	FLSTC Heritage Softail Classic	07	FA400	FA400V	FA400HH	EPFA400HH	003
20	FLSTC Heritage Softail Classic	08-14		FA458V	FA458HH	EPFA458HH	003
21	FLSTC Heritage Softail Classic	15-17		FA458V	FA458HH	EPFA458HH	003
22	FLHC Heritage Classic	18-20		FA710V	FA710HH	EPFA710HH	003
23	FLHCS Heritage Classic 114	18-21		FA710V	FA710HH	EPFA710HH	003
24	FLHCS Heritage Classic 114 Anniversary	18-20		FA710V	FA710HH	EPFA710HH	003
25	FLSTN Softail Deluxe Spoke Wheel	08-14		FA458V	FA458HH	EPFA458HH	003
26	FLSTN Softail Deluxe	15-17		FA458V	FA458HH	EPFA458HH	003
27	FLS Softail Slim	12-14		FA458V	FA458HH	EPFA458HH	003
28	FLS Softail Slim	15-17		FA458V	FA458HH	EPFA458HH	003
29	FLSL Softail Slim	18-20		FA710V	FA710HH	EPFA710HH	003
30	FXCW Rocker Cast Wheel	08-09		FA458V	FA458HH	EPFA458HH	003
31	FXCWC Rocker C Cast Wheel	08-11		FA458V	FA458HH	EPFA458HH	003
32	FXS Blackline	11-13		FA458V	FA458HH	EPFA458HH	003
33	FXSB Breakout	13-14		FA458V	FA458HH	EPFA458HH	003
34	FXSB Breakout	15-17		FA458V	FA458HH	EPFA458HH	016
35	FXBR Breakout	18-20		FA710V	FA710HH	EPFA710HH	016
36	FXBRS Breakout 114	18-21		FA710V	FA710HH	EPFA710HH	016
37	FXBRS Breakout 114 Anniversary	18-20		FA710V	FA710HH	EPFA710HH	016
38	FLDE Deluxe	18-20		FA710V	FA710HH	EPFA710HH	016
39	FXBB Street Bob	18-21		FA710V	FA710HH	EPFA710HH	016
40	FXFB Fat Bob	18-20		FA710V	FA710HH	EPFA710HH	016
41	FXBS Fat Boy	18-21		FA710V	FA710HH	EPFA710HH	016
42	FXLRS Low Rider S	18-21		FA710V	FA710HH	EPFA710HH	016
43	FXDR 114	18-21		FA387V	FA387HH	EPFA387HH	
HARLEY-DAVIDSON® S SERIES							
46	FLSB Sport Glide 1745	18-20		FA710V	FA710HH	EPFA710HH	016
47	FLSS Softail Slim S	16-20		FA458V	FA458HH	EPFA458HH	
48	FLSTFBS Fat Boy S	16-18		FA458V	FA458HH	EPFA458HH	
49	FXDLS Dyna Low Rider S	17		FA458V	FA458HH	EPFA458HH	003
50							
51							
52							
53							
54							
55							
56							
57							
58							
59							

All names & numbers are for reference purposes only. © Registered trademarks of Harley—Davidson® Motor Corp or Buell.

Recommended Fittings: FA400 for use on polished chrome show rotors. FA400HH recommended fitting as replacement for OE.

NOTE: — Some models may have a second rotor fitted as an optional extra. Please double check with your customer exactly which side the front rotor is fitted and if twin rotor or single.

BRAKE APPLICATIONS

*-2 Sets Required. ■ - Also available in MX-S race compound. **SAFETY WARNING:- DO NOT USE HH PADS ON REAR UNLESS ALSO USED ON FRONT TO AVOID BRAKE IMBALANCE**

FRONT: AMERICAN PRODUCED MOTORCYCLES

This symbol indicates a rotor made of billet steel, and should be only used with EBC FA Kevlar® Organic or Vee pads.

SUFFIX OR PREFIX PAD MATERIALS AND DESCRIPTION HARLEY-DAVIDSON® TOURING		FRONT				FRONT ROTOR OPTIONS DESIGN NO. <small>See Buyers Guide for rotor style & finish options. Part nos for ordering & sizing.</small>	Line #
		PADS	PADS	PADS	PADS		
		FA	V	HH/R	EPFA		
FLT, FLHT, FLHTCI	UltraGlide®/ElectraGlide®/ElectraGlide Classic®/Ultra Classic®	80-83		FA072V*			1
FLT, FLHT, FLHTCI	UltraGlide®/ElectraGlide®/ElectraGlide Classic®/Ultra Classic®						2
<i>Oversize rotor available – see buyer's guide</i>		84-85	FA094*	FA094V*	FA094HH*	EPFA094HH*	3
FLT, FLHT, FLHTCI	UltraGlide®/ElectraGlide®/ElectraGlide Classic®/Ultra Classic®						4
<i>Oversize rotor available – see buyer's guide</i>		86-99	FA094*	FA094V*	FA094HH*	EPFA094HH*	5
FLHR, FLHRCi Road King®, Road King Classic®	<i>Oversize rotor available – see buyer's guide</i>	94-99	FA094*	FA094V*	FA094HH*	EPFA094HH*	6
FLHRCi Road King	<i>Oversize rotor available – see buyer's guide</i>	00-07	FA400*	FA400V*	FA400HH*	EPFA400HH*	7
FLHRCi Road King Classic		00-07	FA400*	FA400V*	FA400HH*	EPFA400HH*	8
FLHR Road King Spoke Wheel		08-16	FA409*	FA409V*	FA409HH*	EPFA409HH*	9
FLHR Road King Cast Wheel	<i>Oversize rotor available – see buyer's guide</i>	15-21	FA409*	FA409V*	FA409HH*	EPFA409HH*	10
FLHRC Road King Classic	<i>Oversize rotor available – see buyer's guide</i>	08-20	FA409*	FA409V*	FA409HH*	EPFA409HH*	11
FLHT/FLHTi Electra Glide Standard		00-07	FA400*	FA400V*	FA400HH*	EPFA400HH*	12
FLTR/FLTR-i Road Glide		00-07	FA400*	FA400V*	FA400HH*	EPFA400HH*	13
FLTR Road Glide Road Glide	<i>Oversize rotor available – see buyer's guide</i>	08-09	FA409*	FA409V*	FA409HH*	EPFA409HH*	14
FLTRX Road Glide	<i>Oversize rotor available – see buyer's guide</i>	15-20	FA409*	FA409V*	FA409HH*	EPFA409HH*	15
FLTRX Road Glide Limited	<i>Oversize rotor available – see buyer's guide</i>	15-20	FA409*	FA409V*	FA409HH*	EPFA409HH*	16
FLTRX Road Glide Custom		10-12	FA409*	FA409V*	FA409HH*	EPFA409HH*	17
FLTRXS Road Glide Special	<i>Oversize rotor available – see buyer's guide</i>	15-20	FA409*	FA409V*	FA409HH*	EPFA409HH*	18
FLTRXSE CVO Road Glide	<i>Oversize rotor available – see buyer's guide</i>	21	FA409*	FA409V*	FA409HH*	EPFA409HH*	19
FLTRU Road Glide Ultra	<i>Oversize rotor available – see buyer's guide</i>	11-12	FA409*	FA409V*	FA409HH*	EPFA409HH*	20
FLTRU Road Glide Ultra		16-20	FA409*	FA409V*	FA409HH*	EPFA409HH*	21
FLHTCU-i Electra Glide Ultra Classic		00-07	FA400*	FA400V*	FA400HH*	EPFA400HH*	22
FLHRS/FLHRSi Road King Custom	<i>Oversize rotor available – see buyer's guide</i>	04-07	FA400*	FA400V*	FA400HH*	EPFA400HH*	23
FLHTC/FLHTCi Electra Glide Classic	<i>Oversize rotor available – see buyer's guide</i>	04-07	FA400*	FA400V*	FA400HH*	EPFA400HH*	24
FLHTC Electra Glide Classic		08-12	FA409*	FA409V*	FA409HH*	EPFA409HH*	25
FLHTCU Ultra Classic Electra Glide		08-13	FA409*	FA409V*	FA409HH*	EPFA409HH*	26
FLHTCU Ultra Classic Electra Glide	<i>Oversize rotor available – see buyer's guide</i>	14-20	FA409*	FA409V*	FA409HH*	EPFA409HH*	27
FLHTCUL Ultra Classic Electra Glide Low	<i>Oversize rotor available – see buyer's guide</i>	15-16	FA409*	FA409V*	FA409HH*	EPFA409HH*	28
FLHT Electra Glide Standard	<i>Oversize rotor available – see buyer's guide</i>	08-10	FA409*	FA409V*	FA409HH*	EPFA409HH*	29
FLHTK Electra Glide Ultra LTD	<i>Oversize rotor available – see buyer's guide</i>	10-13	FA409*	FA409V*	FA409HH*	EPFA409HH*	30
FLHTK Electra Glide Ultra LTD	<i>Oversize rotor available – see buyer's guide</i>	15-21	FA409*	FA409V*	FA409HH*	EPFA409HH*	31
FLHTKL Electra Glide Ultra LTD Low	<i>Oversize rotor available – see buyer's guide</i>	15-20	FA409*	FA409V*	FA409HH*	EPFA409HH*	32
FLHTKSE CVO Limited	<i>Oversize rotor available – see buyer's guide</i>	21	FA409*	FA409V*	FA409HH*	EPFA409HH*	33
FLHX/FLHXi Street Glide	<i>Oversize rotor available – see buyer's guide</i>	06-07	FA400*	FA400V*	FA400HH*	EPFA400HH*	34
FLHX Street Glide	<i>Oversize rotor available – see buyer's guide</i>	08-13	FA409*	FA409V*	FA409HH*	EPFA409HH*	35
FLHX Street Glide	<i>Oversize rotor available – see buyer's guide</i>	14-21	FA409*	FA409V*	FA409HH*	EPFA409HH*	36
FLHXS Street Glide Special		15-21	FA409*	FA409V*	FA409HH*	EPFA409HH*	37
FLHXSE CVO Street Glide		21	FA409*	FA409V*	FA409HH*	EPFA409HH*	38
Pan American Adventure		20-21			FA630HH*	EPFA630HH*	39
							40
HARLEY-DAVIDSON® TRIKE							41
FLHTCUTG Tri Glide Ultra Classic Trike		09-13		FA409V*	FA409HH*	EPFA409HH*	42
FLHXXX Street Glide Trike		10-11		FA409V*	FA409HH*	EPFA409HH*	43
FLRT Freewheeler Trike		15-21	FA638*	FA638V*	FA638HH*		44
FLHTCUTG Tri Glide Ultra Trike		14-21	FA638*	FA638V*	FA638HH*		45
FLHTCUTGSE CVO Tri Glide		21	FA638*	FA638V*	FA638HH*	EPFA638HH*	46
							47
							48
HARLEY-DAVIDSON® V-ROD							49
V-Rod Hayes Caliper		02-05	FA400*	FA400V*	FA400HH*	EPFA400HH*	50
V-Rod Brembo Caliper		06	FA409*	FA409V*	FA409HH*	EPFA409HH*	51
VRSCAW V-Rod		07	FA409*	FA409V*	FA409HH*	EPFA409HH*	52
VRSCAW V-Rod Spoke Wheel		08-09	FA409*	FA409V*	FA409HH*	EPFA409HH*	53
VRSCR Street Rod		06-07	FA409*	FA409V*	FA409HH*	EPFA409HH*	54
VRSCD Night Rod Cast Wheel		06-08	FA409*	FA409V*	FA409HH*	EPFA409HH*	55
VRSCDX Night Rod Special Cast Wheel		07-17	FA409*	FA409V*	FA409HH*	EPFA409HH*	56
VRSC 10th Anniversary V Rod		12	FA409*	FA409V*	FA409HH*	EPFA409HH*	57
VRSCX V-Rod	<i>Oversize rotor available – see buyer's guide</i>	07	FA409*	FA409V*	FA409HH*	EPFA409HH*	58
VRSCF V-Rod Muscle	<i>Oversize rotor available – see buyer's guide</i>	09-17	FA409*	FA409V*	FA409HH*	EPFA409HH*	59

*-2 Sets Required. ■ - Also available in MX-S race compound. **SAFETY WARNING:- DO NOT USE HH PADS ON REAR UNLESS ALSO USED ON FRONT TO AVOID BRAKE IMBALANCE**

REAR: AMERICAN PRODUCED MOTORCYCLES

Line #	SUFFIX OR PREFIX PAD MATERIALS AND DESCRIPTION HARLEY-DAVIDSON® TOURING	YEAR	FRONT				FRONT ROTOR OPTIONS DESIGN NO. <small>See Buyers Guide for rotor style & finish options. Part nos for ordering & sizing.</small>
			PADS	PADS	PADS	PADS	
			FA Kevlar Organic Pads	V Semi-Sintered V-Pads™	HH/R Double-H™ USA-Made Sintered Pads	EPFA Premium Low Noise Street Sintered Pads	
1	FLT, FLHT, FLHTCi Ultraglide®, Electraglide®, Electraglide Classic®/Ultra Classic®	80-83	FA079	FA079V			
2							
3	FLT, FLHT, FLHTCi Ultraglide®, Electraglide®, Electraglide Classic®/Ultra Classic®	84-1985	FA079	FA079V			
4							
5	FLT, FLHT, FLHTCi Ultraglide®, Electraglide®, Electraglide Classic®/Ultra Classic®	86-99	FA201	FA201V	FA201HH		MD509SR ⚡
6	FLHR, FLHRCi Road King®, Road King Classic®	94-99	FA201	FA201V	FA201HH		MD509SR ⚡
7	FLHRCi Road King	00-07	FA400	FA400V	FA400HH	EPFA400HH	003
8	FLHRCi Road King Classic	00-07	FA400	FA400V	FA400HH	EPFA400HH	003
9	FLHR Road King Spoke Wheel	08-16	FA409	FA409V	FA409HH	EPFA409HH	011 ⚡
10	FLHR Road King Cast Wheel	15-21	FA409	FA409V	FA409HH	EPFA409HH	011 ⚡
11	FLHRC Road King Classic	08-20	FA409	FA409V	FA409HH	EPFA409HH	011 ⚡
12	FLHT/FLHTi Electra Glide Standard	00-07	FA400	FA400V	FA400HH	EPFA400HH	003
13	FLTR/FLTR-i Road Glide	00-07	FA400	FA400V	FA400HH	EPFA400HH	003
14	FLTR Road Glide Road Glide	08-09	FA409	FA409V	FA409HH	EPFA409HH	011 ⚡
15	FLTRX Road Glide	15-20	FA409	FA409V	FA409HH	EPFA409HH	011 ⚡
16	FLTRX Road Glide Limited	15-20	FA409	FA409V	FA409HH	EPFA409HH	011 ⚡
17	FLTRX Road Glide Custom	10-12	FA409	FA409V	FA409HH	EPFA409HH	011 ⚡
18	FLTRXS Road Glide Special	15-20	FA409	FA409V	FA409HH	EPFA409HH	011 ⚡
19	FLTRXSE CVO Road Glide	21	FA409	FA409V	FA409HH	EPFA409HH	011 ⚡
20	FLTRU Road Glide Ultra	11-12	FA409	FA409V	FA409HH	EPFA409HH	011 ⚡
21	FLTRU Road Glide Ultra	16-20	FA409	FA409V	FA409HH	EPFA409HH	011 ⚡
22	FLHTCU-i Electra Glide Ultra Classic	00-07	FA400	FA400V	FA400HH	EPFA400HH	003
23	FLHRS/FLHRSi Road King Custom	04-07	FA400	FA400V	FA400HH	EPFA400HH	003
24	FLHTC/FLHTCi Electra Glide Classic	04-07	FA400	FA400V	FA400HH	EPFA400HH	003
25	FLHTC Electra Glide Classic	08-12	FA409	FA409V	FA409HH	EPFA409HH	011 ⚡
26	FLHTCU Ultra Classic Electra Glide	08-13	FA409	FA409V	FA409HH	EPFA409HH	011 ⚡
27	FLHTCU Ultra Classic Electra Glide	14-20	FA409	FA409V	FA409HH	EPFA409HH	011 ⚡
28	FLHTCUL Ultra Classic Electra Glide Low	15-16	FA409	FA409V	FA409HH	EPFA409HH	011 ⚡
29	FLHT Electra Glide Standard	08-10	FA409	FA409V	FA409HH	EPFA409HH	011 ⚡
30	FLHTK Electra Glide Ultra LTD	10-13	FA409	FA409V	FA409HH	EPFA409HH	011 ⚡
31	FLHTK Electra Glide Ultra LTD	15-21	FA409	FA409V	FA409HH	EPFA409HH	011 ⚡
32	FLHTKL Electra Glide Ultra LTD Low	15-20	FA409	FA409V	FA409HH	EPFA409HH	011 ⚡
33	FLHTKSE CVO Limited	21	FA409	FA409V	FA409HH	EPFA409HH	011 ⚡
34	FLHX/FLHXi Street Glide	06-07	FA400	FA400V	FA400HH	EPFA400HH	003
35	FLHX Street Glide	08-13	FA409	FA409V	FA409HH	EPFA409HH	011 ⚡
36	FLHX Street Glide	14-21	FA409	FA409V	FA409HH	EPFA409HH	011 ⚡
37	FLHXS Street Glide Special	15-21	FA409	FA409V	FA409HH	EPFA409HH	011 ⚡
38	FLHXSE CVO Street Glide	21	FA409	FA409V	FA409HH	EPFA409HH	011 ⚡
39	Pan American Adventure	20-21	FA213	FA213V	FA213HH		
40							
41	HARLEY-DAVIDSON® TRIKE						
42	FLHTCUTG Tri Glide Ultra Classic Trike	09-13		FA605/4V ▲	FA605/4HH ▲		MD540
43	FLHXXX Street Glide Trike	10-11		FA605/4V ▲	FA605/4HH ▲		MD540
44	FLRT Freewheeler Trike	15-21	FA641/4 ▲	FA641/4V ▲	FA641/4HH ▲		MD538
45	FLHTCUTG Tri Glide Ultra Trike	14-21	FA641/4 ▲	FA641/4V ▲	FA641/4HH ▲		MD538
46	FLHTCUTGSE CVO Tri Glide	21	FA631*	FA631V*	FA631HH*		MD538
47	▲ PADS ARE SOLD IN AXLE SETS – 4 PADS PER SET						
48							
49	HARLEY-DAVIDSON® V-ROD						
50	V-Rod Hayes Caliper	02-05	FA400	FA400V	FA400HH	EPFA400HH	MD515
51	V-Rod Brembo Caliper	06	FA409	FA409V	FA409HH	EPFA409HH	008
52	VRSCAW V-Rod	07	FA409	FA409V	FA409HH	EPFA409HH	008
53	VRSCAW V-Rod Spoke Wheel	08-09	FA409	FA409V	FA409HH	EPFA409HH	008
54	VRSCR Street Rod	06-07	FA409	FA409V	FA409HH	EPFA409HH	008
55	VRSCD Night Rod Cast Wheel	06-08	FA409	FA409V	FA409HH	EPFA409HH	008
56	VRSCDX Night Rod Special Cast Wheel	07-17	FA409	FA409V	FA409HH	EPFA409HH	008
57	VRSC 10th Anniversary V Rod	12	FA409	FA409V	FA409HH	EPFA409HH	008
58	VRSCX V-Rod	07	FA409	FA409V	FA409HH	EPFA409HH	008
59	VRSCF V-Rod Muscle	09-17	FA409	FA409V	FA409HH	EPFA409HH	014 ⚡

All names & numbers are for reference purposes only. © Registered trademarks of Harley—Davidson® Motor Corp or Buell.

Recommended Fittings: FA400 for use on polished chrome show rotors. FA400HH recommended fitting as replacement for OE.

NOTE: — Some models may have a second rotor fitted as an optional extra. Please double check with your customer exactly which side the front rotor is fitted and if twin rotor or single.

**BRAKE
APPLICATIONS**

*-2 Sets Required. ■ - Also available in MX-S race compound. **SAFETY WARNING:- DO NOT USE HH PADS ON REAR UNLESS ALSO USED ON FRONT TO AVOID BRAKE IMBALANCE**

FRONT: AMERICAN PRODUCED MOTORCYCLES

* This symbol indicates a rotor made of billet steel, and should be only used with EBC FA Kevlar® Organic or Vee pads.

ATK		SUFFIX OR PREFIX PAD MATERIALS AND DESCRIPTION	YEAR	FRONT					Line #
				PADS	PADS	PADS	PADS	FRONT ROTOR OPTIONS	
				FA	V	HH/R	EPFA	DESIGN NO.	
50 MXLQ	03								1
50 MXN/TN	03								2
50 MXA	03								3
50 MXE/MXLO	03								4
125 (2 Stroke Enduro)	03		FA181X			FA181R		TBA	5
124 (4 Stroke Enduro)	03		TBA						6
250/260 (2 Stroke Enduro)	03		FA181X			FA181R		N/A	7
250 (2T)	04		FA181X			FA181R		MD6032D	8
GT 250 R V-Twin Sport	11		FA086*			FA086HH*		MD690*	9
GV 250 V-Twin Cruiser	11		FA086			FA086HH		N/A	10
370 (2T)	04		FA181X			FA181R		MD6032D	11
450 MX	05		TBA						12
450 MX	07		FA181X			FA181R		N/A	13
450 XC	05		TBA						14
450 XC	07		FA181X			FA181R		N/A	15
450 Enduro	05		TBA						16
450 Enduro	07		FA181X			FA181R		N/A	17
450 Motard	05		TBA						18
450 Motard	07		FA095			FA095HH		N/A	19
500 Enduro	03		FA181X			FA181R		N/A	20
500/600 Super Motard	02-03		FA095			FA095HH		N/A	21
500 (2T)	04		FA181X			FA181R		MD6032D	22
560	84-85		FA47X					N/A	23
560	86		FA47X					N/A	24
560	87-88		FA47X					N/A	25
560 & other models	89-91		FA126X			FA126R		N/A	26
All models	92		FA126X					N/A	27
All models	93-96		FA135X			FA135R		N/A	28
All models	97-99		FA181X			FA181R		N/A	29
600 DTM Dirt Track Motard	03		FA095			FA095HH		N/A	30
605 Enduro	03		FA181X			FA181R		N/A	31
620 Intimidator (2T)	04		FA181X			FA181R		MD6032D	32
650 GT R V-Twin Sport	11		FA086*			FA086HH*		MD690*	33
650 GV V-Twin Cruiser	11		FA086*			FA086HH*		MD691*	34
700 Intimidator (2T)	04		FA181X			FA181R		MD6032D	35
700 Intimidator	05		TBA						36
BOMBARDIER/BRP (SEE CAN-AM FOR 07 MODELS)									37
DS 50 (2 stroke)	02-06		346*			346G*			38
Quest 50	03-04		346*			346G*			39
DS 90 (2 stroke/4 stroke)	02-06		346*			346G*			40
Quest 90 (2 stroke/4 stroke)	03-04		346*			346G*			41
Rally 200 (7550/7551/7552/7553)	03-04		FA083X*			FA083R*		MD6220D*	42
Rally 200	05-07		FA083X*			FA083R*		MD6220D*	43
DS 250	06		FA377X*		FA377V*	FA377R*		MD6283D*	44
Outlander 330 HO	Left 04-05		FA307X			SXR307HH		MD6222D	45
	Right		FA317X			SXR317HH		MD6222	46
Outlander 400 (7535/7716)	Left 03-04		FA307X			SXR307HH		MD6222D	47
	Right		FA317X			SXR317HH		MD6222D	48
Outlander 400 Max HO	Left 03-06		FA307X			SXR307HH		MD6222D	49
	Right		FA317X			SXR317HH		MD6222D	50
Outlander 650 HO Efi 4 x 4/HO Efi XT 4 x 4	Left 06		FA307X			SXR307HH		MD6222D	51
	Right		FA317X			SXR317HH		MD6222D	52
Outlander Max 650 HO Efi 4 x 4 HO Efi XT 4 x 4	Left 06		FA307X			SXR307HH		MD6222D	53
	Right		FA317X			SXR317HH		MD6222D	54
Outlander 800 (All models)	Left 06		FA307X			SXR307HH		MD6222D	55
	Right		FA317X			SXR317HH		MD6222D	56
Traxter (4 x 4)	99-00		FA266*			FA266R*		MD6229D	57
									58
									59

*-2 Sets Required. ■ - Also available in MX-S race compound. **SAFETY WARNING:- DO NOT** USE HH PADS ON REAR UNLESS ALSO USED ON FRONT TO AVOID BRAKE IMBALANCE

REAR: AMERICAN PRODUCED MOTORCYCLES

Line #	ATK	SUFFIX OR PREFIX PAD MATERIALS AND DESCRIPTION	YEAR	FRONT				
				PADS	PADS	PADS	PADS	FRONT ROTOR OPTIONS
				FA Kevlar Organic Pads	V Semi-Sintered V-Pads™	HH/R Double-H™ USA-Made Sintered Pads	EPFA Premium Low Noise Street Sintered Pads	DESIGN NO. <small>See Buyers Guide for rotor style & finish options. Part nos for ordering & sizing.</small>
1	0 MXLQ		03	TBA				
2	50 MXN/TN		03	TBA				
3	50 MXA		03	TBA				
4	50 MXE/MXLO		03	TBA				
5	125 (2 Stroke Enduro)		03	FA208X		FA208R		TBA
6	124 (4 Stroke Enduro)		03	N/A		TBA		N/A
7	250/260 (2 Stroke Enduro)		03	FA208X		FA208R		N/A
8	250 (2T)		04	FA208X		FA208R		MD6035D
9	GT 250 R V-Twin Sport		11	FA086		FA086HH		MD689
10	GV 250 V-Twin Cruiser		11	606		606G		
11	370 (2T)		04	FA208X		FA208R		MD6035D
12	450 MX		05	TBA		TBA		TBA
13	450 MX		07	FA208X		FA208R		N/A
14	450 XC		05	TBA		TBA		TBA
15	450 XC		07	FA208X		FA208R		N/A
16	450 Enduro		05	TBA		TBA		TBA
17	450 Enduro		07	FA208X		FA208R		N/A
18	450 Motard		05	TBA		TBA		TBA
19	450 Motard		07	FA131X		FA131R		N/A
20	500 Enduro		03	FA208X		FA208R		N/A
21	500/600 Super Motard		02-03	FA208X		FA208R		
22	500 (2T)		04	FA208X		FA208R		MD6035D
23	560		84-85			814G		
24	560		86			N/A		
25	560		87-88	FA115X		FA115R		
26	560 & other models		89-91	FA116				
27	All models		92	FA47X		FA47R		
28	All models		93-96	FA135X		FA135R		
29	All models		97-99	FA208X		FA208R		
30	600 DTM Dirt Track Motard		03	FA208X		FA208R		
31	605 Enduro		03	FA208X		FA208R		
32	620 Intimidator (2T)		04	FA208X		FA208R		MD6035D
33	650 GT R V-Twin Sport		11	FA086		FA086HH		MD689
34	650 GV V-Twin Cruiser		11	FA086		FA086HH		
35	700 Intimidator (2T)		04	FA208X		FA208R		MD6035D
36	700 Intimidator		05	TBA		TBA		
37								
38	BOMBARDIER/BRP (SEE CAN-AM FOR 07 MODELS)							
39	DS 50 (2 stroke)		02-06	330		330G		
40	Quest 50		03-04	330		330G		
41	DS 90 (2 stroke/4 stroke)		02-06	330		330G		
42	Quest 90 (2 stroke/4 stroke)		03-04	330		330G		
43	Rally 200 (7550/7551/7552/7553)		03-04	N/A				MD6221D
44	Rally 200		05-07	FA165/2X		FA165/2R		MD6285D
45	DS 250		06	FA377X		FA377R		MD6282D
46	Outlander 330 HO		04-05	FA307X		FA307R		MD6223D
47								
48	Outlander 400 (7535/7716)		03-04	FA307X		FA307R		MD6223D
49								
50	Outlander 400 Max HO		03-06	FA307X		FA307R		MD6223D
51								
52	Outlander 650 HO Efi 4 x 4/HO Efi XT 4 x 4		06	FA307X		FA307R		MD6223D
53								
54	Outlander Max 650 HO Efi 4 x 4 HO Efi XT 4 x 4		06	FA307X		FA307R		MD6223D
55								
56	Outlander 800 (All models)		06	FA307X		FA307R		MD6223D
57								
58	Traxter (4 x 4)		99-00	FA266		FA266R		MD6230D
59								

All names & numbers are for reference purposes only. © Registered trademarks of Harley—Davidson® Motor Corp or Buell.

Recommended Fittings: FA400 for use on polished chrome show rotors. FA400HH recommended fitting as replacement for OE.

NOTE: — Some models may have a second rotor fitted as an optional extra. Please double check with your customer exactly which side the front rotor is fitted and if twin rotor or single.

**BRAKE
APPLICATIONS**

*-2 Sets Required. ■ - Also available in MX-S race compound. **SAFETY WARNING:- DO NOT** USE HH PADS ON REAR UNLESS ALSO USED ON FRONT TO AVOID BRAKE IMBALANCE

Part numbers, prefixes, suffixes, photos and illustrations shown in this catalogue are trademarks and/or copyrights of EBC Brakes or the trademark owner A C Freeman Investments Ltd and use without express written permission of the owners is punishable by law.

FRONT: AMERICAN PRODUCED MOTORCYCLES

This symbol indicates a rotor made of billet steel, and should be only used with EBC FA Kevlar® Organic or Vee pads.

BOMBARDIER/BRP (SEE CAN-AM FOR 07 MODELS)				FRONT					Line #		
				PADS		PADS		PADS		PADS	FRONT ROTOR OPTIONS
				FA	V	HH/R	EPFA	DESIGN NO.			
SUFFIX OR PREFIX PAD MATERIALS AND DESCRIPTION YEAR				Kevlar Organic Pads	Semi-Sintered V-Pads™	Double-H™ USA-Made Sintered Pads	Premium Low Noise Street Sintered Pads	See Buyers Guide for rotor style & finish options. Part nos for ordering & sizing.			
Traxter (4 x 4)	Left	01	FA307X			SXR307HH		MD6229D	1		
	Right		FA317X			SXR317HH		MD6229D	2		
Traxter XL (4 x 4)		01	FA266*			FA266R		MD6229D	3		
Traxter XL (4 x 4)	Left	01-04	FA307X			SXR307HH		MD6229D	4		
	Right		FA317X			SXR317HH		MD6229D	5		
Traxter XT (4 x 4) (Model types 7423/7424)			FA266			FA266R*		MD6229D	6		
Traxter XT (4 x 4) (Model types 7446/7452/7467/7468/7472/7481/7493/7494)	Left	01	FA307X			SXR307HH		MD6229D	7		
	Right		FA317X			SXR317HH		MD6229D	8		
Traxter Autoshift (Model types 7431/7432/7433/7434)		01	FA266*			FA266R*		MD6229D*	9		
Traxter Autoshift (Model types 7453/7454/7461/7462/7469/7470/7471/7475/7480/7495/7496/7497/7560/7561/7562/7563/7564/7566/7567/7568/7569/7570/7595/7596/7597/7598/7599)	Left	01-05	FA307X			SXR307HH		MD6225D	10		
	Right		FA317X			SXR317HH		MD6225D	11		
Traxter Footshift (Model types 7439/7440/7441/7442)		01	FA266*			FA266R		MD6229D*	12		
Traxter Footshift (Model types 7473/7474)	Left	01	FA307X			SXR307HH		MD6229D	13		
	Right		FA317X			SXR317HH		MD6229D	14		
Quest 500 (4 x 4) (Model types 7478/7515/7525/7539/7540/7546/7547/7583/7584/7713/7724/7725/7731)	Left	02-04	FA307X			SXR307HH		MD6224D	15		
	Right		FA317X			SXR317HH		MD6224D	16		
Traxter Max	Left	03-05	FA307X			SXR307HH		MD6245D	17		
	Right		FA317X			SXR317HH		MD6245D	18		
Quest 500 (2 x 4) (Model types 7541/7542/7548/7549/7585/7586/7714/7726)	Left	02	FA307X			SXR307HH		MD6224D	19		
	Right		FA317X			SXR317HH		MD6224D	20		
Quest 650 (2 x 4) (Model type 7582)	Left	02	FA307X			SXR307HH		MD6224D	21		
	Right		FA317X			SXR317HH		MD6224D	22		
Quest 650 (4 x 4) (Model types 7443/7445/7516/7517/7523/7536/7537/7543/7544/7580/7581/7730)	Left	02-04	FA307X			SXR307HH		MD6224D	23		
	Right		FA317X			SXR317HH		MD6224D	24		
Quest 650 XT (4 x 4) (Model types 7522/7523/7534/7545/7715/7727/7728)	Left	02	FA307X			SXR307HH		MD6224D	25		
	Right		FA317X			SXR317HH		MD6224D	26		
Quest Max 650	Left	03-	FA307X			SXR307HH		MD6224D	27		
	Right		FA317X			SXR317HH		MD6224D	28		
DS 650 (Model types 7404/7409/7463/7482/7518/7519/7587/7588 - 7483)	Left	00-05	FA307X			SXR307HH		MD6171D	29		
	Right		FA317X			SXR317HH		MD6171D	30		
DS 650 Baja/X	Left	01-06	FA307X			SXR307HH		MD6171D	31		
	Right		FA317X			SXR317HH		MD6171D	32		
Traxter Max 650	Left	04-05	FA307X			SXR307HH		MD6245D	33		
	Right		FA317X			SXR317HH		MD6245D	34		
Sarasota 1000 Side x Side		05	N/A						35		
Traxter XL (7920/7921)	Left	04	FA307X			SXR307HH		MD6245D	36		
	Right		FA317X			SXR317HH		MD6245D	37		
Quest Max/STD/XT	Left	04-05	FA307X			SXR307HH		MD6245D	38		
	Right		FA317X			SXR317HH		MD6245D	39		
BUELL											
M2 Cyclone (Disc has Countersunk bolt holes)		94-97	FA210		FA210V			MD719RS	42		
S1 Lightning (Disc has Countersunk bolt holes)		94-97	FA210		FA210V			MD719RS	43		
S2 Thunderbolt (Disc has Countersunk bolt holes)		94-97	FA210		FA210V			MD719RS	44		
BS3 Thunderbolt (Disc has Countersunk bolt holes)		94-97	FA210		FA210V			MD719RS	45		
M2 Cyclone (Disc has Countersunk bolt holes)		98-00	FA424			FA424HH		MD719RS	46		
S1 Lightning (Disc has Countersunk bolt holes)		98-00	FA424			FA424HH		MD719RS	47		
S1 White Lightning (Disc has Countersunk bolt holes)		98-00	FA424			FA424HH		MD719RS	48		
S3 Thunderbolt (Disc has Countersunk bolt holes)		98-00	FA424			FA424HH		MD719RS	49		
S3T Thunderbolt (Disc has Countersunk bolt holes)		98-00	FA424			FA424HH		MD719RS	50		
X1 Lightning (Disc has Countersunk bolt holes)		98-00	FA424			FA424HH		MD719RS	51		
M2 Cyclone (Disc has Counterbored bolt holes)		00-05	FA424			FA424HH		MD734RS	52		
X1 Lightning (Disc has Counterbored bolt holes)		00-05	FA424			FA424HH		MD734RS	53		
Blast		00-07	FA196		FA196V	FA196HH		MD737	54		
Firebolt XB9R		02-07				FA345HH		MD735RS	55		
XB9S Lightning		03-04				FA345HH		MD735RS	56		
XB9SX Lightning City X		05-09				FA345HH		MD735RS	57		
XB9SX Lightning		08-10				FA345HH		MD735RS	58		
XB12 S Lightning		04-08				FA345HH		MD735RS	59		

*-2 Sets Required. ■ - Also available in MX-S race compound. **SAFETY WARNING:- DO NOT USE HH PADS ON REAR UNLESS ALSO USED ON FRONT TO AVOID BRAKE IMBALANCE**

REAR: AMERICAN PRODUCED MOTORCYCLES

Line #	BOMBARDIER/BRP (SEE CAN-AM FOR 07 MODELS)	SUFFIX OR PREFIX PAD MATERIALS AND DESCRIPTION YEAR	FRONT				
			PADS	PADS	PADS	PADS	FRONT ROTOR OPTIONS
			FA Kevlar Organic Pads	V Semi-Sintered V-Pads™	HH/R Double-H™ USA-Made Sintered Pads	EPFA Premium Low Noise Street Sintered Pads	DESIGN NO. See Buyers Guide for rotor style & finish options. Part nos for ordering & sizing.
1	Traxter (4 x 4)	01	FA307X		FA307R		MD6230D
2							
3	Traxter XL (4 x 4)	01	FA266		FA266R		MD6230D
4	Traxter XL (4 x 4)	01-04	FA317X		FA317R		MD6230D
5							
6	Traxter XT (4 x 4) (Model types 7423/7424)		FA266		FA266R		MD6230D
7	Traxter XT (4 x 4) (Model types 7446/7452/7467/7468/7472/7481/7493/7494)	01	FA317X		FA317R		MD6230D
8							
9	Traxter Autoshift (Model types 7431/7432/7433/7434)	01	FA266		FA266R		MD6230D
10	Traxter Autoshift (Model types 7453/7454/7461/7462/7469/7470/7471/7475/7480/7495// 7496/7497/7560/7561/7562/7563/7564/7566/7567/7568/7569/7570/7595/7596/7597/7598/7599)	01-05	FA317X		FA317R		MD6224D
11							
12	Traxter Footshift (Model types 7439/7440/7441/7442)	01	FA266		FA266R		MD6230D
13	Traxter Footshift (Model types 7473/7474)	01	FA317X		FA317R		MD6230D
14							
15	Quest 500 (4 x 4) (Model types 7478/7515/7525/7539/7540/7546/7547/7583/7584/7713/7724/7725/7731)	02-04	FA317X		FA317R		MD6225D
16							
17	Traxter Max	03-05	FA317X		FA317R		MD6225D
18							
19	Quest 500 (2 x 4) (Model types 7541/7542/7548/7549/7585/7586/7714/7726)	02	FA317X		FA317R		MD6225D
20							
21	Quest 650 (2 x 4) (Model type 7582)	02	FA317X		FA317R		MD6225D
22							
23	Quest 650 (4 x 4) (Model types 7443/7445/7516/7517/7523/7536/7537/7543/7544/7580/7581/7730)	02-04	FA317X		FA317R		MD6225D
24							
25	Quest 650 XT (4 x 4) (Model types 7522/7523/7534/7545/7715/7727/7728)	02	FA317X		FA317R		MD6225D
26							
27	Quest Max 650	03-	FA317X		FA317R		MD6225D
28							
29	DS 650 (Model types 7404/7409/7463/7482/7518/7519/7587/7588 - 7483)	00-05	FA307X		FA307R		MD6172D
30							
31	DS 650 Baja/X	01-06	FA307X		FA307R		MD6172D
32							
33	Traxter Max 650	04-05	FA317X		FA317R		MD6225D
34							
35	Sarasota 1000 Side x Side	05	N/A				
36	Traxter XL (7920/7921)	04	FA317X		FA317R		MD6225D
37							
38	Quest Max/STD/XT	04-05	FA317X		FA317R		MD6225D
39							
40							
41	BUELL						
42	M2 Cyclone (Disc has Countersunk bolt holes)	94-97	FA251				MD511
43	1 Lightning (Disc has Countersunk bolt holes)	94-97	FA251				MD511
44	S2 Thunderbolt (Disc has Countersunk bolt holes)	94-97	FA251				MD511
45	BS3 Thunderbolt (Disc has Countersunk bolt holes)	94-97	FA251				MD511
46	M2 Cyclone (Disc has Countersunk bolt holes)	98-00	FA140		FA140HH		MD511
47	S1 Lightning (Disc has Countersunk bolt holes)	FA140			FA140HH		MD511
48	S1 White Lightning (Disc has Countersunk bolt holes)	98-00	FA140		FA140HH		MD511
49	S3 Thunderbolt (Disc has Countersunk bolt holes)	98-00	FA140		FA140HH		MD511
50	S3T Thunderbolt (Disc has Countersunk bolt holes)	98-00	FA140		FA140HH		MD511
51	X1 Lightning (Disc has Countersunk bolt holes)	98-00	FA140		FA140HH		MD511
52	M2 Cyclone (Disc has Counterbored bolt holes)	00-05	FA140		FA140HH		MD511
53	X1 Lightning (Disc has Counterbored bolt holes)	00-05	FA140		FA140HH		MD511
54	Blast	00-07	FA140		FA140HH		MD738
55	Firebolt XB9R	02-07	FA140		FA140HH		MD522
56	XB9S Lightning	03-04	FA140		FA140HH		MD522
57	XB9SX Lightning City X	05-09	FA140		FA140HH		MD522
58	XB9SX Lightning	08-10	FA140		FA140HH		MD522
59	XB12 S Lightning	04-08	FA140		FA140HH		MD522

All names & numbers are for reference purposes only. © Registered trademarks of Harley—Davidson® Motor Corp or Buell.

Recommended Fittings: FA400 for use on polished chrome show rotors. FA400HH recommended fitting as replacement for OE.

NOTE: — Some models may have a second rotor fitted as an optional extra. Please double check with your customer exactly which side the front rotor is fitted and if twin rotor or single.

**BRAKE
APPLICATIONS**

*-2 Sets Required. ■ - Also available in MX-S race compound. **SAFETY WARNING:- DO NOT USE HH PADS ON REAR UNLESS ALSO USED ON FRONT TO AVOID BRAKE IMBALANCE**

FRONT: AMERICAN PRODUCED MOTORCYCLES

* This symbol indicates a rotor made of billet steel, and should be only used with EBC FA Kevlar® Organic or Vee pads.

BUCELL		SUFFIX OR PREFIX PAD MATERIALS AND DESCRIPTION	YEAR	FRONT				FRONT ROTOR OPTIONS DESIGN NO. <small>See Buyers Guide for rotor style & finish options. Part nos for ordering & sizing.</small>	Line #
				PADS	PADS	PADS	PADS		
				FA Kevlar Organic Pads	V Semi-Sintered V-Pads™	HH/R Double-H™ USA-Made Sintered Pads	EPFA Premium Low Noise Street Sintered Pads		
XB12 X Ulysses	06-10				FA345HH		MD735RS	1	
XB12 XT Ulysses	08-10				FA345HH		MD735RS	2	
XB12 SCG Lightning	06-08				FA345HH		MD735RS	3	
XB12 Ss Lightning Long	06-08				FA345HH		MD735RS	4	
XB12 Ss Lightning	09-10				FA454/HH		MD735RS	5	
XB12 STT Lightning	08				FA345HH		MD735RS	6	
XB12 SCG Lightning	09-10				FA454/4HH		MD735RS	7	
XB12 R Firebolt	04-08				FA345HH		MD735RS	8	
XB12 R Firebolt	09-10				FA454/4HH		MD735RS	9	
1125 R	08-10				FA454/4HH		MD735RS	10	
1125 CR	09-10				FA454/4HH		MD735RS	11	
CAN AM (ATV)									
DS 70 (2 x 4) Mini 4T	08-15			346*		346G*		13	
DS 90 (2 x 4) 4T	06-15			346*		346G*		14	
DS 90 X (2 x 4) 4T	08-15			FA083X*		FA083R*	MD6335D*	15	
Rally 200 (4A7A/B/C/D/E/F)	05-07			FA083X*		FA083R*	MD6220D*	16	
DS 250 (3J7A/B/C)	06-15			FA377X*	FA377V*	FA377R*	MD6283D*	17	
Outlander 400 (4 x 4 STD) (2D7A/B/C/D/E/F/G/H)	Left	07-14		FA307X		SXR307HH	MD6222D	18	
	Right			FA317X		SXR317HH	MD6222D	19	
Outlander 400 (XT 4 x 4) (2E7A/B/C/D/E/F)	Left	07-14		FA307X		SXR307HH	MD6222D	20	
	Right			FA317X		SXR317HH	MD6222D	21	
Outlander Max 400 (STD 4 x 4) (2F7B/C/D/E/F/G/H/J)	Left	07-14		FA307X		SXR307HH	MD6222D	22	
	Right			FA317X		SXR317HH	MD6222D	23	
Outlander Max 400 (XT 4 x 4) (2G7A/B/C/D/E)	Left	06-13		FA307X		SXR307HH	MD6222D	24	
	Right			FA317X		SXR317HH	MD6222D	25	
Outlander 400 EFI STD international	Left	15		FA307X		SXR307HH	MD6222D	26	
	Right			FA317X		SXR317HH	MD6222D	27	
DS 450 (2 x 4/EFI) road model with Hand brake	08-15					FA468R*		28	
DS 450 X (2 x 4/EFI) road model with Hand brake	08-09					FA468R*		29	
DS 450 Offroad model without hand brake	09-15					FA468R*		30	
Outlander 450 EFI, MAX and T3	Left	18-19		FA618X		FA618R	MD6370D	31	
	Right			FA617X		FA618R		32	
Outlander 6x6 Max and T3	Left	19		FA618X		FA618R	MD6370D	33	
	Right			FA617X				34	
Outlander L 450 EFI	Left	15		FA618X		FA618R	MD6370D	35	
	Right			FA617X				36	
Outlander L 450 Max EFI	Left	15		FA618X		FA618R	MD6370D	37	
	Right			FA617X				38	
Outlander 500 (STD 4 x 4) (2T7A/B/C/D)	Left	07-12		FA307X		SXR307HH	MD6222D	39	
	Right			FA317X		SXR317HH		40	
Outlander 500 (XT 4 x 4) (2U7A/B/C/D)	Left	07-12		FA307X		SXR307HH	MD6222D	41	
	Right			FA317X		SXR317HH		42	
Outlander Max 500 (STD 4 x 4) (2W7A/B/C)	Left	07-12		FA307X		SXR307HH	MD6222D	43	
	Right			FA317X		SXR317HH		44	
Outlander Max 500 (XT 4 x 4) (2X7A/B/C)	Left	07-12		FA307X		SXR307HH	MD6222D	45	
	Right			FA317X		SXR317HH		46	
Outlander 500 4 X 4 (STD/DPS/XT)	Left	13-15		FA618X			MD6370D	47	
	Right			FA617X			MD6370D	48	
Outlander Max 500 4 X 4 (STD/DPS/XT)	Left	13-14		FA618X			MD6370D	49	
	Right			FA617X			MD6370D	50	
Outlander 500 L EFI	Left	15		FA618X			MD6370D	51	
	Right			FA617X			MD6370D	52	
Outlander Max 500 L EFI	Left	15		FA618X			MD6370D	53	
	Right			FA617X			MD6370D	54	
Renegade 500 (4 x 4/EFI)	Left	07-08		FA307X		SXR307HH	MD6223D	55	
	Right			FA317X		SXR317HH		56	
Renegade 500 (4 x 4/EFI)	Left	09-12		FA307X		SXR307HH	MD6223D	57	
	Right			FA317X		SXR317HH		58	

*-2 Sets Required. ■ - Also available in MX-S race compound. **SAFETY WARNING:- DO NOT USE HH PADS ON REAR UNLESS ALSO USED ON FRONT TO AVOID BRAKE IMBALANCE**

REAR: AMERICAN PRODUCED MOTORCYCLES

Line #	SUFFIX OR PREFIX PAD MATERIALS AND DESCRIPTION	YEAR	FRONT				
			PADS	PADS	PADS	PADS	FRONT ROTOR OPTIONS
			FA Kevlar Organic Pads	V Semi-Sintered V-Pads™	HH/R Double-H™ USA-Made Sintered Pads	EPFA Premium Low Noise Street Sintered Pads	DESIGN NO. See Buyers Guide for rotor style & finish options. Part nos for ordering & sizing.
BUELL							
1	XB12 X Ulysses	06-10	FA140		FA140HH		MD522
2	XB12 XT Ulysses	08-10	FA140		FA140HH		MD522
3	XB12 SCG Lightning	06-08	FA140		FA140HH		MD522
4	XB12 Ss Lightning Long	06-08	FA140		FA140HH		MD522
5	XB12 Ss Lightning	09-10	FA140		FA140HH		MD522
6	XB12 STT Lightning	08	FA140		FA140HH		MD522
7	XB12 SCG Lightning	09-10	FA140		FA140HH		MD522
8	XB12 R Firebolt	04-08	FA140		FA140HH		MD522
9	XB12 R Firebolt	09-10	FA140		FA140HH		MD522
10	1125 R	08-10			FA460HH		N/A
11	1125 CR	09-10			FA460HH		N/A
12							
CAN AM (ATV)							
13							
14	DS 70 (2 x 4) Mini 4T	08-15	307		307G		
15	DS 90 (2 x 4) 4T	06-15	307		307G		
16	DS 90 X (2 x 4) 4T	08-15	FA083X		FA083R		MD6334D
17	Rally 200 (4A7A/B/C/D/E/F)	05-07	FA307X		FA307R		MD6285D
18	DS 250 (3J7A/B/C)	06-15	FA377X		FA377R		MD6282D
19	Outlander 400 (4 x 4 STD) (2D7A/B/C/D/E/F/G/H)	07-14	FA307X		FA307R		MD6223D
20							
21	Outlander 400 (XT 4 x 4) (2E7A/B/C/D/E/F)	07-14	FA307X		FA307R		MD6223D
22							
23	Outlander Max 400 (STD 4 x 4) (2F7B/C/D/E/F/G/H/J)	07-14	FA307X		FA307R		MD6223D
24							
25	Outlander Max 400 (XT 4 x 4) (2G7A/B/C/D/E)	06-13	FA307X		FA307R		MD6223D
26							
27	Outlander 400 EFI STD international	15	FA307X		FA307R		MD6223D
28							
29	DS 450 (2 x 4/EFI) road model with Hand brake	08-15			FA398R		
30	DS 450 X (2 x 4/EFI) road model with Hand brake	08-09			FA398R		
31	DS 450 Offroad model without hand brake	09-15			FA398R		MD6021D
32	Outlander 450 EFI, MAX and T3	18-19	FA618X		FA618R		MD6370D
33							
34	Outlander 6x6 Max and T3	19	FA618X		FA618R		MD6370D
35							
36	Outlander L 450 EFI	15					
37							
38	Outlander L 450 Max EFI	15					
39							
40	Outlander 500 (STD 4 x 4) (2T7A/B/C/D)	07-12	FA307X		FA307R		MD6223D
41							
42	Outlander 500 (XT 4 x 4) (2U7A/B/C/D)	07-12	FA307X		FA307R		MD6223D
43							
44	Outlander Max 500 (STD 4 x 4) (2W7A/B/C)	07-12	FA307X		FA307R		MD6223D
45							
46	Outlander Max 500 (XT 4 x 4) (2X7A/B/C)	07-12	FA307X		FA307R		MD6223D
47							
48	Outlander 500 4 X 4 (STD/DPS/XT)	13-15					
49							
50	Outlander Max 500 4 X 4 (STD/DPS/XT)	13-14					
51							
52	Outlander 500 L EFI	15					
53							
54	Outlander Max 500 L Efi	15					
55							
56	Renegade 500 (4 x 4/EFI)	07-08	FA307X		FA307R		MD6223D
57							
58	Renegade 500 (4 x 4/EFI)	09-12	FA307X		FA307R		MD6223D
59							

All names & numbers are for reference purposes only. © Registered trademarks of Harley—Davidson® Motor Corp or Buell.

Recommended Fittings: FA400 for use on polished chrome show rotors. FA400HH recommended fitting as replacement for OE.

NOTE: — Some models may have a second rotor fitted as an optional extra. Please double check with your customer exactly which side the front rotor is fitted and if twin rotor or single.

**BRAKE
APPLICATIONS**

*-2 Sets Required. ■ - Also available in MX-S race compound. **SAFETY WARNING:- DO NOT USE HH PADS ON REAR UNLESS ALSO USED ON FRONT TO AVOID BRAKE IMBALANCE**

FRONT: AMERICAN PRODUCED MOTORCYCLES

* This symbol indicates a rotor made of billet steel, and should be only used with EBC FA Kevlar® Organic or Vee pads.

CAN AM (ATV)	SUFFIX OR PREFIX PAD MATERIALS AND DESCRIPTION	YEAR	FRONT				FRONT ROTOR OPTIONS DESIGN NO. <small>See Buyers Guide for rotor style & finish options. Part nos for ordering & sizing.</small>	Line #
			PADS	PADS	PADS	PADS		
			FA Kevlar Organic Pads	V Semi-Sintered V-Pads™	HH/R Double-H™ USA-Made Sintered Pads	EPFA Premium Low Noise Street Sintered Pads		
Renegade 500 STD/EFI	Left	12-15	FA618X		FA618R		MD6370D	1
	Right		FA617X		FA617R		MD6370D	2
Outlander 570 Max Pro	Left	17	FA618X		FA618R		MD6370D	3
	Right		FA617X		FA617R		MD6370D	4
Outlander 570 T3 EFI inc (3FJD)	Left	18	FA618X		FA618R		MD6370D	5
	Right		FA617X		FA617R		MD6370D	6
Outlander 570 Max EFI T3 Pro inc DPS XT	Left	18-19	FA618X		FA618R		MD6370D	7
	Right		FA617X		FA617R		MD6370D	8
Renegade 570 EFI T3	Left	19	FA618X		FA618R		MD6370D	9
	Right		FA617X		FA617R		MD6370D	10
DS 650 X (3B7A/B)	Left	07	FA307X		SXR307HH		MD6171D	11
	Right		FA317X		SXR317HH		MD6171D	12
(ATV) Outlander 650 (4 x 4 STD) (2N7A/B/C/D/E/F/G/H)	Left	07-12	FA307X		SXR307HH		MD6222D	13
	Right		FA317X		SXR317HH		MD6222D	14
Outlander 650 (XT 4 x 4) (2P7A/B/C/D/E/F)	Left	07-12	FA307X		SXR307HH		MD6222D	15
	Right		FA317X		SXR317HH		MD6222D	16
Outlander Max 650 (STD 4 x 4) (2R7A/B/C/D/E/F/G/H/J/K)	Left	07-12	FA307X		SXR307HH		MD6222D	17
	Right		FA317X		SXR317HH		MD6222D	18
Outlander Max 650 (XT 4 x 4) (2S7A/B/C/D/E/F)	Left	07-12	FA307X		SXR307HH		MD6222D	19
	Right		FA317X		SXR317HH		MD6222D	20
Outlander 650 4x 4	Left	13-15	FA618X		FA618R		MD6370D	21
	Right		FA617X		FA617R		MD6370D	22
Outlander 650 Mmr	Left	15	FA618X		FA618R		MD6370D	23
	Right		FA617X		FA617R		MD6370D	24
Outlander Max 650 X-TP	Left	12	FA307X		SXR307HH		MD6222D	25
	Right		FA317X		SXR317HH		MD6222D	26
Outlander Max 650 4 x 4 (STD/DPS/XT)	Left	13	FA618X		FA618R		MD6370D	27
	Right		FA617X		FA617R		MD6370D	28
Outlander 650 Max Pro	Left	17	FA618X		FA618R		MD6370D	29
	Right		FA617X		FA617R		MD6370D	30
Outlander 650 T3 EFI	Left	18	FA618X		FA618R		MD6370D	31
	Right		FA617X		FA617R		MD6370D	32
Outlander 650 Max EFI T3 Pro inc DPS XT	Left	18-19	FA618X		FA618R		MD6370D	33
	Right		FA617X		FA617R		MD6370D	34
Outlander 650 Max 6x6 EFI T3	Left	19	FA618X		FA618R		MD6370D	35
	Right		FA617X		FA617R		MD6370D	36
Renegade 650 EFI T3	Left	19	FA618X		FA618R		MD6370D	37
	Right		FA617X		FA617R		MD6370D	38
Outlander 800 (STD 4 x 4) (2H7A/B/C/D/E/F/G/H)	Left	07-08	FA307X		SXR307HH		MD6222D	39
	Right		FA317X		SXR317HH		MD6222D	40
Outlander 800 (XT 4 x 4) (2J7A/B/C/D/E/F)	Left	07-08	FA307X		SXR307HH		MD6222D	41
	Right		FA317X		SXR317HH		MD6222D	42
Outlander 800 R EFI	Left	09	FA307X		SXR307HH		MD6222D	43
	Right		FA317X		SXR317HH		MD6222D	44
Outlander 800 R XT	Left	09-10	FA307X		SXR307HH		MD6222D	45
	Right		FA317X		SXR317HH		MD6222D	46
Outlander 800 R STD	Left	12-15	FA618X		FA618R		MD6370D	47
	Right		FA617X		FA617R		MD6370D	48
Outlander 800 R 4 X 4 (STD/DPS/XT/XT-P)	Left	14	FA618X		FA618R		MD6370D	49
	Right		FA617X		FA617R		MD6370D	50
Outlander Max 800 R EFI	Left	09-12	FA307X		SXR307HH		MD6222D	51
	Right		FA317X		SXR317HH		MD6222D	52
Outlander Max 800 R XT		09-12	FA307X		FA307R		MD6222D	53
Outlander Max 800 R 4 X 4 (STD/XT/XT-P)	Left	13	FA618X		FA618R		MD6370D	54
	Right		FA617X		FA617R		MD6370D	55
Outlander 800 R XT	Left	12-13	FA618X		FA618R		MD6370D	56
	Right		FA617X		FA617R		MD6370D	57
Outlander 800 R Mmr	Left	15	FA618X		FA618R		MD6370D	58
	Right		FA617X		FA617R		MD6370D	59

*-2 Sets Required. ■ - Also available in MX-S race compound. **SAFETY WARNING:- DO NOT** USE HH PADS ON REAR UNLESS ALSO USED ON FRONT TO AVOID BRAKE IMBALANCE

REAR: AMERICAN PRODUCED MOTORCYCLES

Line #	CAN AM (ATV)	SUFFIX OR PREFIX PAD MATERIALS AND DESCRIPTION	YEAR	FRONT				
				PADS	PADS	PADS	PADS	FRONT ROTOR OPTIONS
				FA Kevlar Organic Pads	V Semi-Sintered V-Pads™	HH/R Double-H™ USA-Made Sintered Pads	EPFA Premium Low Noise Street Sintered Pads	DESIGN NO. <small>See Buyers Guide for rotor style & finish options. Part nos for ordering & sizing.</small>
1	Renegade 500 STD/EFI		12-15	FA618X		FA618R		MD6370D
2								
3	Outlander 570 Max Pro		17	FA618X		FA618R		MD6370D
4								
5	Outlander 570 T3 EFI inc (3FJD)		18	FA618X		FA618R		MD6370D
6								
7	Outlander 570 Max EFI T3 Pro inc DPS XT		18-19	FA618X		FA618R		MD6370D
8								
9	Renegade 570 EFI T3		19	FA618X		FA618R		MD6370D
10								
11	DS 650 X (3B7A/B)		07	FA307X		FA618R		MD6172D
12								
13	(ATV) Outlander 650 (4 x 4 STD) (2N7A/B/C/D/E/F/G/H)		07-12	FA307X		FA307R		MD6223D
14								
15	Outlander 650 (XT 4 x 4) (2P7A/B/C/D/E/F)		07-12	FA307X		FA307R		MD6223D
16								
17	Outlander Max 650 (STD 4 x 4) (2R7A/B/C/D/E/F/G/H/J/K)		07-12	FA307X		FA307R		MD6223D
18								
19	Outlander Max 650 (XT 4 x 4) (2S7A/B/C/D/E/F)		07-12	FA307X		FA307R		MD6223D
20								
21	Outlander 650 4x 4		13-15					
22								
23	Outlander 650 Mmr		15					
24								
25	Outlander Max 650 X-TP		12	FA307X		FA307R		MD6223D
26								
27	Outlander Max 650 4 x 4 (STD/DPS/XT)		13					
28								
29	Outlander 650 Max Pro		17	FA618X		FA618R		MD6370D
30								
31	Outlander 650 T3 EFI		18	FA618X		FA618R		MD6370D
32								
33	Outlander 650 Max EFI T3 Pro inc DPS XT		18-19	FA618X		FA618R		MD6370D
34								
35	Outlander 650 Max 6x6 EFI T3		19	FA618X		FA618R		MD6370D
36								
37	Renegade 650 EFI T3		19	FA618X		FA618R		MD6370D
38								
39	Outlander 800 (STD 4 x 4) (2H7A/B/C/D/E/F/G/H)		07-08	FA307X		FA307R		MD6223D
40								
41	Outlander 800 (XT 4 x 4) (2J7A/B/C/D/E/F)		07-08	FA307X		FA307R		MD6223D
42								
43	Outlander 800 R EFI		09	FA307X		FA307R		MD6223D
44								
45	Outlander 800 R XT		09-10	FA307X		FA307R		MD6223D
46								
47	Outlander 800 R STD		12-15					
48								
49	Outlander 800 R 4 X 4 (STD/DPS/XT/XT-P)		14					
50								
51	Outlander Max 800 R EFI		09-12	FA307X		FA307R		MD6223D
52								
53	Outlander Max 800 R XT		09-12	FA307X		FA307R		MD6223D
54	Outlander Max 800 R 4 X 4 (STD/XT/XT-P)		13					
55								
56	Outlander 800 R XT		12-13					
57								
58	Outlander 800 R Mmr		15					
59								

All names & numbers are for reference purposes only. © Registered trademarks of Harley—Davidson® Motor Corp or Buell.

Recommended Fittings: FA400 for use on polished chrome show rotors. FA400HH recommended fitting as replacement for OE.

NOTE: — Some models may have a second rotor fitted as an optional extra. Please double check with your customer exactly which side the front rotor is fitted and if twin rotor or single.

**BRAKE
APPLICATIONS**

*-2 Sets Required. ■ - Also available in MX-S race compound. **SAFETY WARNING:- DO NOT USE HH PADS ON REAR UNLESS ALSO USED ON FRONT TO AVOID BRAKE IMBALANCE**

FRONT: AMERICAN PRODUCED MOTORCYCLES

* This symbol indicates a rotor made of billet steel, and should be only used with EBC FA Kevlar® Organic or Vee pads.

CAN AM (ATV)	SUFFIX OR PREFIX PAD MATERIALS AND DESCRIPTION		FRONT					Line #
			PADS	PADS	PADS	PADS	FRONT ROTOR OPTIONS	
			FA Kevlar Organic Pads	V Semi-Sintered V-Pads™	HH/R Double-H™ USA-Made Sintered Pads	EPFA Premium Low Noise Street Sintered Pads	DESIGN NO. <small>See Buyers Guide for rotor style & finish options. Part nos for ordering & sizing.</small>	
Outlander Max 800 (Ltd 4 x 4) (2M7A/B/C)	Left	07-12	FA307X		SXR307HH		MD6222D	1
	Right		FA317X		SXR317HH		MD6222D	2
Outlander Max 800 (STD 4 x 4) (2K7A/B/C/D/E/F/G/H/J)	Left	07-12	FA307X		SXR307HH		MD6222D	3
	Right		FA317X		SXR317HH		MD6222D	4
Outlander Max 800 (XT 4 x 4) (2L7A/B/C/D/E/F)	Left	07-08	FA307X		SXR307HH		MD6222D	5
	Right		FA317X		SXR317HH		MD6222D	6
Outlander 800 R Xmr	Left	11-12	FA307X		SXR307HH		MD6222D	7
	Right		FA317X		SXR317HH		MD6222D	8
Outlander 800 R XXC	Left	11	FA307X		SXR307HH		MD6222D	9
	Right		FA317X		SXR317HH		MD6222D	10
Outlander Max 800 R X-TP	Left	12	FA307X		SXR307HH		MD6222D	11
	Right		FA317X		SXR317HH		MD6222D	12
Renegade 800 X (4 x 4/EFI)	Left	08	FA307X		SXR307HH		TBA	13
	Right		FA317X		SXR317HH		TBA	14
Renegade 800 (4 x 4/EFI)	Left	07-08	FA307X		SXR307HH		TBA	15
	Right		FA317X		SXR317HH		TBA	16
Renegade 800 R EFI	Left	09-11	FA307X		SXR307HH		TBA	17
	Right		FA317X		SXR317HH		TBA	18
Renegade 800 R STD EFI	Left	12-15	FA618X				MD6370D	19
	Right		FA617X				MD6370D	20
Renegade 800 R X	Left	09-10	FA307X		SXR307HH		MD6223D	21
	Right		FA317X		SXR317HH		MD6223D	22
Renegade 800 R XXC	Left	11	FA307X		SXR307HH		MD6223D	23
	Right		FA317X		SXR317HH		MD6223D	24
Renegade 800 R XXC	Left	12-14	FA618X				MD6370D	25
	Right		FA617X				MD6370D	26
Outlander 850 EFI	Left	18	FA618X				MD6370D	27
	Right		FA617X				MD6370D	28
Outlander 850 Max	Left	17	FA618X				MD6370D	29
	Right		FA617X				MD6370D	30
Renegade 850 EFI	Left	19	FA618X				MD6370D	31
	Right		FA617X				MD6370D	32
Outlander 1000 STD	Left	12	FA618X		FA618R		MD6370D	33
	Right		FA617X		FA617R		MD6370D	34
Outlander 1000 XT	Left	12	FA618X		FA618R		MD6370D	35
	Right		FA617X		FA617R		MD6370D	36
Outlander 1000 4 x 4 (DPS/XT/XT-P)	Left	13	FA618X		FA618R		MD6370D	37
	Right		FA617X		FA617R		MD6370D	38
Outlander 1000 4 x 4 (LTD)	Left	13	FA618X		FA618R		MD6370D	39
	Right		FA617X		FA617R		MD6370D	40
Outlander 1000 4 x 4 (Xmr)	Left	13	FA618X		FA618R		MD6370D	41
	Right		FA617X		FA617R		MD6370D	42
Outlander Max 1000 4 x 4 (DPS/XT/XT-P)	Left	13	FA618X		FA618R		MD6370D	43
	Right		FA617X		FA617R		MD6370D	44
Outlander 1000 Max EFI T3 L and R	Left	17-19	FA618X		FA618R		MD6370D	45
	Right		FA617X		FA617R		MD6370D	46
Outlander 1000 EFI T3 and R	Left	17-19	FA618X		FA618R		MD6370D	47
	Right		FA617X		FA617R		MD6370D	48
Outlander 1000 6x6 EFI T3	Left	18-19	FA618X		FA618R		MD6370D	49
	Right		FA617X		FA617R		MD6370D	50
Renegade 1000 EFI T3 and R	Left	19	FA618X		FA618R		MD6370D	51
	Right		FA617X		FA617R		MD6370D	52
Outlander 6 x 6 XT	Left	14-15	FA618X		FA618R		MD6370D	53
	Right		FA617X		FA617R		MD6370D	54
Renegade 1000 STD EFI	Left	12-14	FA618X		FA618R		MD6370D	55
	Right		FA617X		FA617R		MD6370D	56
Renegade 1000 XXC	Left	12-14	FA618X		FA618R		MD6370D	57
	Right		FA617X		FA617R		MD6370D	58
								59

*-2 Sets Required. ■ - Also available in MX-S race compound. **SAFETY WARNING:- DO NOT** USE HH PADS ON REAR UNLESS ALSO USED ON FRONT TO AVOID BRAKE IMBALANCE

REAR: AMERICAN PRODUCED MOTORCYCLES

Line #	CAN AM (ATV)	SUFFIX OR PREFIX PAD MATERIALS AND DESCRIPTION	YEAR	FRONT				
				PADS	PADS	PADS	PADS	FRONT ROTOR OPTIONS
				FA Kevlar Organic Pads	V Semi-Sintered V-Pads™	HH/R Double-H™ USA-Made Sintered Pads	EPFA Premium Low Noise Street Sintered Pads	DESIGN NO. <small>See Buyers Guide for rotor style & finish options. Part nos for ordering & sizing.</small>
1	Outlander Max 800 (Ltd 4 x 4) (2M7A/B/C)		07-12	FA307X		FA307R		MD6223D
2								
3	Outlander Max 800 (STD 4 x 4) (2K7A/B/C/D/E/F/G/H/J)		07-12	FA307X		FA307R		MD6223D
4								
5	Outlander Max 800 (XT 4 x 4) (2L7A/B/C/D/E/F)		07-08	FA307X		FA307R		MD6223D
6								
7	Outlander 800 R Xmr		11-12	FA307X		FA307R		MD6223D
8								
9	Outlander 800 R XXC		11	FA307X		FA307R		MD6223D
10								
11	Outlander Max 800 R X-TP		12	FA307X		FA307R		MD6223D
12								
13	Renegade 800 X (4 x 4/EFI)		08	FA307X		FA307R		TBA
14								
15	Renegade 800 (4 x 4/EFI)		07-08	FA307X		FA307R		TBA
16								
17	Renegade 800 R EFI		09-11	FA307X		FA307R		TBA
18								
19	Renegade 800 R STD EFI		12-15	FA618X		FA618R		MD6370D
20								
21	Renegade 800 R X		09-10	FA307X		FA307R		MD6223D
22								
23	Renegade 800 R XXC		11	FA307X		FA307R		MD6223D
24								
25	Renegade 800 R XXC		12-14	FA618X		FA618R		MD6370D
26								
27	Outlander 850 EFI		18	FA618X		FA618R		MD6370D
28								
29	Outlander 850 Max		17	FA618X		FA618R		MD6370D
30								
31	Renegade 850 EFI		19	FA618X		FA618R		MD6370D
32								
33	Outlander 1000 STD		12					
34								
35	Outlander 1000 XT		12					
36								
37	Outlander 1000 4 x 4 (DPS/XT/XT-P)		13					
38								
39	Outlander 1000 4 x 4 (LTD)		13					
40								
41	Outlander 1000 4 x 4 (Xmr)		13					
42								
43	Outlander Max 1000 4 x 4 (DPS/XT/XT-P)		13					
44								
45	Outlander 1000 Max EFI T3 L and R		17-19	FA618X		FA618R		MD6370D
46								
47	Outlander 1000 EFI T3 and R		17-19	FA618X		FA618R		MD6370D
48								
49	Outlander 1000 6x6 EFI T3		18-19	FA618X		FA618R		MD6370D
50								
51	Renegade 1000 EFI T3 and R		19	FA618X		FA618R		MD6370D
52								
53	Outlander 6 x 6 XT		14-15	FA618X		FA618R		MD6370D
54								
55	Renegade 1000 STD EFI		12-14	FA618X		FA618R		MD6370D
56								
57	Renegade 1000 XXC		12-14	FA618X		FA618R		MD6370D
58								
59								

All names & numbers are for reference purposes only. © Registered trademarks of Harley—Davidson® Motor Corp or Buell.

Recommended Fittings: FA400 for use on polished chrome show rotors. FA400HH recommended fitting as replacement for OE.

NOTE: — Some models may have a second rotor fitted as an optional extra. Please double check with your customer exactly which side the front rotor is fitted and if twin rotor or single.

**BRAKE
APPLICATIONS**

*-2 Sets Required. ■ - Also available in MX-S race compound. **SAFETY WARNING:- DO NOT USE HH PADS ON REAR UNLESS ALSO USED ON FRONT TO AVOID BRAKE IMBALANCE**

Part numbers, prefixes, suffixes, photos and illustrations shown in this catalogue are trademarks and/or copyrights of EBC Brakes or the trademark owner A C Freeman Investments Ltd and use without express written permission of the owners is punishable by law.

FRONT: AMERICAN PRODUCED MOTORCYCLES

* This symbol indicates a rotor made of billet steel, and should be only used with EBC FA Kevlar® Organic or Vee pads.

CAN AM SIDE X SIDE	SUFFIX OR PREFIX PAD MATERIALS AND DESCRIPTION		YEAR		FRONT					Line #
					PADS	PADS	PADS	PADS	FRONT ROTOR OPTIONS	
					FA Kevlar Organic Pads	V Semi-Sintered V-Pads™	HH/R Double-H™ USA-Made Sintered Pads	EPFA Premium Low Noise Street Sintered Pads	DESIGN NO. <small>See Buyers Guide for rotor style & finish options. Part nos for ordering & sizing.</small>	
Commander Electric 9KW			13-15			FA468R*		MD6222D*	1	
Commander 800 (XT/DPS)	Left	11-15	FA165X			SXR165HH		MD6366D	2	
	Right		FA135X			SXR135HH		MD6366D	3	
Commander 800 Single rear right disc brake	Left	11	FA165X			SXR165HH		MD6366D	4	
	Right		FA135X			SXR135HH		MD6366D	5	
Commander 800 Single rear right disc brake	Left	12-15	FA165X			SXR165HH		MD6366D	6	
	Right		FA135X			SXR135HH		MD6366D	7	
Commander 800 Supplement-IS Market /Locking rear Diff			13-14			FA398R*		MD6222D*	8	
Commander 800 R (STD)	Left	11-15	FA165X			SXR165HH		MD6366D	9	
	Right		FA135X			SXR135HH		MD6366D	10	
Commander 800 R XT	Left	11-14	FA165X			SXR165HH		MD6366D	11	
	Right		FA135X			SXR135HH		MD6366D	12	
Commander 1000 EFI	Left	18-19	FA642X			SXR642HH		MD6411D	13	
	Right		FA645X			SXR645HH		MD6411D	14	
Defender 500cc HD5	Left	17-19	FA682X			SXR682HH		MD6396D	15	
	Right		FA683X			SXR683HH		MD6396D	16	
Defender 799cc	Left	16	FA682X			SXR682HH		MD6396D	17	
	Right		FA683X			SXR683HH		MD6396D	18	
Defender 799cc DPS	Left	16	FA682X			SXR682HH		MD6396D	19	
	Right		FA683X			SXR683HH		MD6396D	20	
Defender 799cc XT	Left	16	FA682X			SXR682HH		MD6396D	21	
	Right		FA683X			SXR683HH		MD6396D	22	
Defender 799cc XT Cab	Left	16	FA682X			SXR682HH		MD6396D	23	
	Right		FA683X			SXR683HH		MD6396D	24	
Defender Max	Left	17	FA682X			SXR682HH		MD6396D	25	
	Right		FA683X			SXR683HH		MD6396D	26	
Defender 799cc HD8	Left	17-19	FA682X			SXR682HH		MD6396D	27	
	Right		FA683X			SXR683HH		MD6396D	28	
Defender Max 799cc HD8	Left	18-19	FA682X			SXR682HH		MD6396D	29	
	Right		FA683X			SXR683HH		MD6396D	30	
Defender 976cc HD10	Left	17-19	FA682X			SXR682HH		MD6396D	31	
	Right		FA683X			SXR683HH		MD6396D	32	
Defender Max 976cc Max HD10 inc XMR	Left	18-19	FA682X			SXR682HH		MD6396D	33	
	Right		FA683X			SXR683HH		MD6396D	34	
Defender T	Left	17	FA682X			SXR682HH		MD6396D	35	
	Right		FA683X			SXR683HH		MD6396D	36	
Commander 1000 STD	Left	11-15	FA165X			SXR165HH		MD6366D	37	
	Right		FA135X			SXR135HH		MD6366D	38	
Commander 1000 Single rear right disc brake	Left	11	FA165X			SXR165HH		MD6366D	39	
	Right		FA135X			SXR135HH		MD6366D	40	
Commander 1000 Single rear right disc brake	Left	12-17	FA165X			SXR165HH		MD6366D	41	
	Right		FA135X			SXR135HH		MD6366D	42	
Commander 1000 Supplement-IS Market /Locking rear Diff			13-15			FA398R*		MD6222D*	43	
Commander 1000 (DPS)	Left	13-15	FA165X			SXR165HH		MD6366D	44	
	Right		FA135X			SXR135HH		MD6366D	45	
Commander 1000 LTD Single rear right disc brake	Left	12-14	FA165X			SXR165HH		MD6366D	46	
	Right		FA135X			SXR135HH		MD6366D	47	
Commander 1000 X	Left	11-13	FA165X			SXR165HH		MD6366D	48	
	Right		FA135X			SXR135HH		MD6366D	49	
Commander 1000 XT	Left	11-15	FA165X			SXR165HH		MD6366D	50	
	Right		FA135X			SXR135HH		MD6366D	51	
Commander 1000 XT-P	Left	14-15	FA165X			SXR165HH		MD6366D	52	
	Right		FA135X			SXR135HH		MD6366D	53	
Commander Max 1000 DPS/XT	Left	14	FA165X			SXR165HH		MD6366D	54	
	Right		FA135X			SXR135HH		MD6366D	55	
Commander Max 1000 DPS/XT	Left	15	FA642X			SXR642HH		MD6411D	56	
	Right		FA645X			SXR645HH		MD6411D	57	
Commander Max 1000 LTD	Left	15-17	FA642X			SXR642HH		MD6411D	58	
	Right		FA645X			SXR645HH		MD6411D	59	

*-2 Sets Required. ■ - Also available in MX-S race compound. **SAFETY WARNING:- DO NOT** USE HH PADS ON REAR UNLESS ALSO USED ON FRONT TO AVOID BRAKE IMBALANCE

REAR: AMERICAN PRODUCED MOTORCYCLES

Line #	CAN AM SIDE X SIDE	SUFFIX OR PREFIX PAD MATERIALS AND DESCRIPTION	YEAR	FRONT				
				PADS	PADS	PADS	PADS	FRONT ROTOR OPTIONS
				FA Kevlar Organic Pads	V Semi-Sintered V-Pads™	HH/R Double-H™ USA-Made Sintered Pads	EPFA Premium Low Noise Street Sintered Pads	DESIGN NO. <small>See Buyers Guide for rotor style & finish options. Part nos for ordering & sizing.</small>
1	Commander Electric 9KW		13-15	N/A				
2	Commander 800 (XT/DPS)		11-15	FA135X		FA135R		MD6366D
3								
4	Commander 800 Single rear right disc brake		11					
5								
6	Commander 800 Single rear right disc brake		12-15					
7								
8	Commander 800 Supplement-IS Market /Locking rear Diff		13-14	N/A				
9	Commander 800 R (STD)		11-15	FA135X		FA135R		MD6366D
10								
11	Commander 800 R XT		11-14	FA135X		FA135R		MD6366D
12								
13	Commander 1000 EFI		18-19	FA135X		FA135R		MD6366D
14								
15	Defender 500cc HD5		17-19					
16								
17	Defender 799cc		16	FA684X		FA684R		MD6396D
18								
19	Defender 799cc DPS		16	FA684X		FA684R		MD6396D
20								
21	Defender 799cc XT		16	FA684X		FA684R		MD6396D
22								
23	Defender 799cc XT Cab		16	FA684X		FA684R		MD6396D
24								
25	Defender Max		17	FA682X		FA682R		MD6396D
26								
27	Defender 799cc HD8		17-19	FA684X		FA684R		MD6396D
28								
29	Defender Max 799cc HD8		18-19	FA684X		FA684R		MD6396D
30								
31	Defender 976cc HD10		17-19	FA684X		FA684R		MD6396D
32								
33	Defender Max 976cc Max HD10 inc XMR		18-19	FA684X		FA684R		MD6396D
34								
35	Defender T		17	FA684X		FA684R		MD6396D
36								
37	Commander 1000 STD		11-15	FA135X		FA135R		MD6366D
38								
39	Commander 1000 Single rear right disc brake		11					
40								
41	Commander 1000 Single rear right disc brake		12-17					
42								
43	Commander 1000 Supplement-IS Market /Locking rear Diff		13-15					
44	Commander 1000 (DPS)		13-15	FA135X		FA135R		MD6366D
45								
46	Commander 1000 LTD Single rear right disc brake		12-14					
47								
48	Commander 1000 X		11-13	FA135X		FA135R		MD6366D
49								
50	Commander 1000 XT		11-15	FA135X		FA135R		MD6366D
51								
52	Commander 1000 XT-P		14-15	FA135X		FA135R		MD6366D
53								
54	Commander Max 1000 DPS/XT		14	FA307X		FA307R		MD6370D
55								
56	Commander Max 1000 DPS/XT		15	FA307X		FA307R		MD6370D
57								
58	Commander Max 1000 LTD		15-17	FA307X		FA307R		MD6370D
59								

All names & numbers are for reference purposes only. © Registered trademarks of Harley—Davidson® Motor Corp or Buell.

Recommended Fittings: FA400 for use on polished chrome show rotors. FA400HH recommended fitting as replacement for OE.

NOTE: — Some models may have a second rotor fitted as an optional extra. Please double check with your customer exactly which side the front rotor is fitted and if twin rotor or single.

**BRAKE
APPLICATIONS**

*-2 Sets Required. ■ - Also available in MX-S race compound. **SAFETY WARNING:- DO NOT** USE HH PADS ON REAR UNLESS ALSO USED ON FRONT TO AVOID BRAKE IMBALANCE

FRONT: AMERICAN PRODUCED MOTORCYCLES

* This symbol indicates a rotor made of billet steel, and should be only used with EBC FA Kevlar® Organic or Vee pads.

CAN AM SIDE X SIDE	SUFFIX OR PREFIX PAD MATERIALS AND DESCRIPTION	YEAR	FRONT				FRONT ROTOR OPTIONS	Line #
			PADS	PADS	PADS	PADS	DESIGN NO.	
			FA Kevlar Organic Pads	V Semi-Sintered V-Pads™	HH/R Double-H™ USA-Made Sintered Pads	EPFA Premium Low Noise Street Sintered Pads	See Buyers Guide for rotor style & finish options. Part nos for ordering & sizing.	
Defender 976cc	Left	16	FA682X		SXR682HH		MD6396D	1
	Right		FA683X		SXR683HH		MD6396D	2
Defender 976cc DPS	Left	16	FA682X		SXR682HH		MD6396D	3
	Right		FA683X		SXR683HH		MD6396D	4
Defender 976cc XT	Left	16	FA682X		SXR682HH		MD6396D	5
	Right		FA683X		SXR683HH		MD6396D	6
Defender 976cc XT Cab	Left	16	FA682X		SXR682HH		MD6396D	7
	Right		FA683X		SXR683HH		MD6396D	8
Maverick 1000 Std	Left	13	FA165X		SXR165HH		MD6366D	9
	Right		FA135X		SXR135HH		MD6366D	10
Maverick 1000 XRS	Left	13	FA165X		SXR165HH		MD6366D	11
	Right		FA135X		SXR135HH		MD6366D	12
Maverick 1000 STD/XRS/XRS – DPS	Left	14-16	FA165X		SXR165HH		MD6411D	13
	Right		FA135X		SXR135HH		MD6411D	14
Maverick 1000 STD/XRS/XRS – DPS	Left	15	FA642X		SXR642HH		MD6411D	15
	Right		FA645X		SXR645HH		MD6411D	16
Maverick 1000 XDS – DPS	Left	15	FA642X		SXR642HH		MD6411D	17
	Right		FA645X		SXR645HH		MD6411D	18
Maverick 1000 XMR	Left	14-15	FA642X		SXR642HH		MD6411D	19
	Right		FA645X		SXR645HH		MD6411D	20
Maverick 1000 XXC	Left	14-16	FA165X		SXR165HH		MD6411D	21
	Right		FA135X		SXR135HH		MD6411D	22
Maverick Max 1000 Std, XRS	Left	14-15	FA642X		SXR642HH		MD6411D	23
	Right		FA645X		SXR645HH		MD6411D	24
Maverick Max 1000 XDS – DPS	Left	15-16	FA642X		SXR642HH		MD6411D	25
	Right		FA645X		SXR645HH		MD6411D	26
Maverick Max 1000 XRS – DPS	Left	14-15	FA642X		SXR642HH		MD6411D	27
	Right		FA645X		SXR645HH		MD6411D	28
Maverick Max 1000 Max	Left	16-17	FA642X		SXR642HH		MD6411D	29
	Right		FA645X		SXR645HH		MD6411D	30
Maverick Trail 800cc Trail EFI	Left	18	FA682X		SXR682HH		MD6396D	31
	Right		FA683X		SXR683HH		MD6396D	32
Maverick Trail 1000cc Trail EFI	Left	18	FA682X		SXR682HH		MD6396D	33
	Right		FA683X		SXR683HH		MD6396D	34
Maverick X3	Left	17	FA682X		SXR682HH		MD6411D	35
	Right		FA683X		SXR683HH		MD6411D	36
Maverick X3 Max	Left	17	FA682X		SXR682HH		MD6411D	37
	Right		FA683X		SXR683HH		MD6411D	38
Maverick X3 Turbo	Left	18	FA682X		SXR682HH		MD6411D	39
	Right		FA683X		SXR683HH		MD6411D	40
Maverick X3 Max Turbo	Left	18	FA682X		SXR682HH		MD6411D	41
	Right		FA683X		SXR683HH		MD6411D	42
Maverick X3 Turbo R	Left	18	FA682X		SXR682HH		MD6411D	43
	Right		FA683X		SXR683HH		MD6411D	44
Maverick X3 Max Turbo R	Left	18	FA682X		SXR682HH		MD6411D	45
	Right		FA683X		SXR683HH		MD6411D	46
Traxter T	Left	17	FA682X		FA682R		MD6396D	47
	Right		FA683X		FA683R		MD6396D	48
Traxter HD5 Single rear right disc brake	Left	17-19	FA682X		FA682R		MD6396D	49
	Right		FA683X		FA683R		MD6396D	50
Traxter HD8	Left	17-19	FA682X		FA682R		MD6396D	51
	Right		FA683X		FA683R		MD6396D	52
Traxter HD10	Left	17-19	FA682X		FA682R		MD6396D	53
	Right		FA683X		FA683R		MD6396D	54
Traxter HD10 Max	Left	17-19	FA682X		FA682R		MD6396D	55
	Right		FA683X		FA683R		MD6396D	56
Traxter T HD5	Left	18-19	FA682X		FA682R		MD6396D	57
	Right		FA683X		FA683R		MD6396D	58
								59

*-2 Sets Required. ■ - Also available in MX-S race compound. **SAFETY WARNING:- DO NOT** USE HH PADS ON REAR UNLESS ALSO USED ON FRONT TO AVOID BRAKE IMBALANCE

REAR: AMERICAN PRODUCED MOTORCYCLES

Line #	CAN AM SIDE X SIDE	SUFFIX OR PREFIX PAD MATERIALS AND DESCRIPTION	YEAR	FRONT				
				PADS	PADS	PADS	PADS	FRONT ROTOR OPTIONS
				FA Kevlar Organic Pads	V Semi-Sintered V-Pads™	HH/R Double-H™ USA-Made Sintered Pads	EPFA Premium Low Noise Street Sintered Pads	DESIGN NO. <small>See Buyers Guide for rotor style & finish options. Part nos for ordering & sizing.</small>
1	Defender 976cc		16	FA684X		FA684R		MD6396D
2								
3	Defender 976cc DPS		16	FA684X		FA684R		MD6396D
4								
5	Defender 976cc XT		16	FA684X		FA684R		MD6396D
6								
7	Defender 976cc XT Cab		16	FA684X		FA684R		MD6396D
8								
9	Maverick 1000 Std		13	FA307X		FA307R		MD6370D
10								
11	Maverick 1000 XRS		13	FA307X		FA307R		MD6370D
12								
13	Maverick 1000 STD/XRS/XRS – DPS		14-16	FA307X		FA307R		MD6370D
14								
15	Maverick 1000 STD/XRS/XRS – DPS		15	FA307X		FA307R		MD6370D
16								
17	Maverick 1000 XDS – DPS		15	FA307X		FA307R		MD6370D
18								
19	Maverick 1000 XMR		14-15	FA307X		FA307R		MD6370D
20								
21	Maverick 1000 XXC		14-16	FA307X		FA307R		MD6370D
22								
23	Maverick Max 1000 Std, XRS		14-15	FA307X		FA307R		MD6370D
24								
25	Maverick Max 1000 XDS – DPS		15-16	FA307X		FA307R		MD6370D
26								
27	Maverick Max 1000 XRS – DPS		14-15	FA307X		FA307R		MD6370D
28								
29	Maverick Max 1000 Max		16-17	FA307X		FA307R		MD6370D
30								
31	Maverick Trail 800cc Trail EFI		18	FA682X		FA682R		MD6412D
32								
33	Maverick Trail 1000cc Trail EFI		18	FA682X		FA682R		MD6412D
34								
35	Maverick X3		17	FA682X		FA682R		MD6412D
36								
37	Maverick X3 Max		17	FA682X		FA682R		MD6412D
38								
39	Maverick X3 Turbo		18	FA682X		FA682R		MD6412D
40								
41	Maverick X3 Max Turbo		18	FA682X		FA682R		MD6412D
42								
43	Maverick X3 Turbo R		18	FA682X		FA682R		MD6412D
44								
45	Maverick X3 Max Turbo R		18	FA682X		FA682R		MD6412D
46								
47	Traxter T		17	FA684X		FA684R		MD6396D
48								
49	Traxter HD5 Single rear right disc brake		17-19					
50								
51	Traxter HD8		17-19	FA684X		FA684R		MD6396D
52								
53	Traxter HD10		17-19	FA684X		FA684R		MD6396D
54								
55	Traxter HD10 Max		17-19	FA682X		FA682R		MD6396D
56								
57	Traxter T HD5		18-19	FA682X		FA682R		MD6396D
58								
59								

All names & numbers are for reference purposes only. © Registered trademarks of Harley—Davidson® Motor Corp or Buell.

Recommended Fittings: FA400 for use on polished chrome show rotors. FA400HH recommended fitting as replacement for OE.

NOTE: — Some models may have a second rotor fitted as an optional extra. Please double check with your customer exactly which side the front rotor is fitted and if twin rotor or single.

**BRAKE
APPLICATIONS**

*-2 Sets Required. ■ - Also available in MX-S race compound. **SAFETY WARNING:- DO NOT USE HH PADS ON REAR UNLESS ALSO USED ON FRONT TO AVOID BRAKE IMBALANCE**

Part numbers, prefixes, suffixes, photos and illustrations shown in this catalogue are trademarks and/or copyrights of EBC Brakes or the trademark owner A C Freeman Investments Ltd and use without express written permission of the owners is punishable by law.

FRONT: AMERICAN PRODUCED MOTORCYCLES

* This symbol indicates a rotor made of billet steel, and should be only used with EBC FA Kevlar® Organic or Vee pads.

				FRONT					Line #
				PADS	PADS	PADS	PADS	FRONT ROTOR OPTIONS	
				FA	V	HH/R	EPFA	DESIGN NO.	
SUFFIX OR PREFIX PAD MATERIALS AND DESCRIPTION				Kevlar Organic Pads	Semi-Sintered V-Pads™	Double-H™ USA-Made Sintered Pads	Premium Low Noise Street Sintered Pads	See Buyers Guide for rotor style & finish options. Part nos for ordering & sizing.	
YEAR									
CAN AM SIDE X SIDE									
Traxter T HD8	Left	18-19	FA682X			FA682R		MD6396D	1
	Right		FA683X			FA683R		MD6396D	2
Traxter T HD10	Left	18-19	FA682X			FA682R		MD6396D	3
	Right		FA683X			FA683R		MD6396D	4
CAN AM (RYKER)									
Ryker 600 Ace	Left	18-21	FA165X			SXR165HH			7
	Right		FA135X			SXR135HH			8
Ryker 900 Ace	Left	18-21	FA165X			SXR165HH			9
	Right		FA135X			SXR135HH			10
CAN AM (SPYDER)									
RS SE5	Left	08-09	FA474	FA474V				MD801	12
	Right		FA474	FA474V				MD801	13
RS SM5	Left	08-09	FA474	FA474V				MD801	14
	Right		FA474	FA474V				MD801	15
RS Phantom Black	Left	09	FA474	FA474V				MD801	16
	Right		FA474	FA474V				MD801	17
RT		10-12	FA474*	FA474V*				MD801*	18
RT LTD		10-12	FA474*	FA474V*				MD801*	19
RT-S		10-12	FA474*	FA474V*				MD801*	20
RS		10-12	FA474*	FA474V*				MD801*	21
RS-S		10-12	FA474*	FA474V*				MD801*	22
RS (Brembo Caliper)		13-16		FA630V*	FA630HH*			MD853*	23
RS-S (Brembo Caliper)		13-16		FA630V*	FA630HH*			MD853*	24
RT (3 Cyl Eng/ 6 Speed)		13-21		FA630V*	FA630HH*			MD853*	25
RT LTD (3 Cyl Eng/ 6 Speed)		13-21		FA630V*	FA630HH*			MD853*	26
RT-S (3 Cyl Eng/ 6 Speed)		13-15		FA630V*	FA630HH*			MD853*	27
RT-S (Special Series)		16-17		FA630V*	FA630HH*			MD853*	28
ST (Brembo Calipers)		13-16		FA630V*	FA630HH*			MD853*	29
ST LTD (Brembo Calipers)		13-15		FA630V*	FA630HH*			MD853*	30
ST-S (Brembo Calipers)		13-16		FA630V*	FA630HH*			MD853*	31
F3 (SE6/SM6)		15-21		FA630V*	FA630HH*			MD853*	32
F3 LTD		16-21		FA630V*	FA630HH*			MD853*	33
F3-S (SE6/SM6)		15-21		FA630V*	FA630HH*			MD853*	34
F3-S (Special Series)		16-21		FA630V*	FA630HH*			MD853*	35
F3-S Daytona 500		17		FA630V*	FA630HH*			MD853*	36
F3-T		16-21		FA630V*	FA630HH*			MD853*	37
EBR									
1190 RS (Sport)		14-15				FA454/4HH		MD735RS	40
1190 RX (Sport)		14-15				FA454/4HH		MD735RS	41
1190 SX (Naked)		14-15				FA454/4HH		MD735RS	42
INDIAN									
Chief All models Chief/Deluxe/Springfield/Road Master/Vintage		02-08	FA216/3	FA216/3V	FA216/3HH			N/A	45
Spirit All models Deluxe/Springfield/Roadblaster		02-08	FA216/3	FA216/3V	FA216/3HH			N/A	46
Scout All models Scout/Deluxe/Springfield		02-08	FA216/3	FA216/3V	FA216/3HH			N/A	47
Chief Blackhawk (Brembo calipers)		11	FA095*	FA095V*	FA095HH*			MD535*	48
Chief Blackhawk Dark (Brembo calipers)		11	FA095*	FA095V*	FA095HH*			MD535*	49
Chief		22			FA347HH				50
Chief Dark Horse		22			FA347HH				51
Chief Bobber		22			FA347HH				52
Chief Bobber Dark Horse		22			FA347HH				53
Super Chief		22			FA347HH				54
Super Chief Limited		22			FA347HH				55
Chief Classic (Brembo calipers)		11-13	FA095*	FA095V*	FA095HH*			MD535*	56
Chief Standard (Brembo calipers)		09-11	FA095*	FA095V*	FA095HH*			MD535*	57
Chief Deluxe (Brembo calipers)		09	FA095*	FA095V*	FA095HH*			MD535*	58
Chief Roadmaster (Brembo calipers)		09-11	FA095*	FA095V*	FA095HH*			MD535*	59

*-2 Sets Required. ■ - Also available in MX-S race compound. **SAFETY WARNING:- DO NOT USE HH PADS ON REAR UNLESS ALSO USED ON FRONT TO AVOID BRAKE IMBALANCE**

REAR: AMERICAN PRODUCED MOTORCYCLES

Line #	CAN AM SIDE X SIDE	SUFFIX OR PREFIX PAD MATERIALS AND DESCRIPTION	YEAR	FRONT				
				PADS	PADS	PADS	PADS	FRONT ROTOR OPTIONS
				FA Kevlar Organic Pads	V Semi-Sintered V-Pads™	HH/R Double-H™ USA-Made Sintered Pads	EPFA Premium Low Noise Street Sintered Pads	DESIGN NO. See Buyers Guide for rotor style & finish options. Part nos for ordering & sizing.
1	Traxter T HD8		18-19	FA682X		FA682R		MD6396D
2								
3	Traxter T HD10		18-19	FA682X		A682R		MD6396D
4								
5								
6	CAN AM (RYKER)							
7	Ryker 600 Ace		18-21	FA317X		FA317R		
8								
9	Ryker 900 Ace		18-21	FA317X		FA317R		
10								
11	CAN AM (SPYDER)							
12	RS SE5		08-09	FA473				MD802
13								
14	RS SM5		08-09	FA473				MD802
15								
16	RS Phantom Black		09	FA473				MD802
17								
18	RT		10-12	FA473				MD802
19	RT LTD		10-12	FA473				MD802
20	RT-S		10-12	FA473				MD802
21	RS		10-12	FA473				MD802
22	RS-S		10-12	FA473				MD802
23	RS (Brembo Caliper)		13-16			FA631HH		MD854
24	RS-S (Brembo Caliper)		13-16			FA631HH		MD854
25	RT (3 Cyl Eng/ 6 Speed)		13-21			FA631HH		MD854
26	RT LTD (3 Cyl Eng/ 6 Speed)		13-21			FA631HH		MD854
27	RT-S (3 Cyl Eng/ 6 Speed)		13-15			FA631HH		MD854
28	RT-S (Special Series)		16-17			FA631HH		MD854
29	ST (Brembo Calipers)		13-16			FA631HH		MD854
30	ST LTD (Brembo Calipers)		13-15			FA631HH		MD854
31	ST-S (Brembo Calipers)		13-16			FA631HH		MD854
32	F3 (SE6/SM6)		15-21			FA631HH		MD854
33	F3 LTD		16-21			FA631HH		MD854
34	F3-S (SE6/SM6)		15-21			FA631HH		MD854
35	F3-S (Special Series)		16-21			FA631HH		MD854
36	F3-S Daytona 500		17			FA631HH		MD854
37	F3-T		16-21			FA631HH		MD854
38								
39	EBR							
40	1190 RS (Sport)		14-15			FA460HH		N/A
41	1190 RX (Sport)		14-15			FA460HH		N/A
42	1190 SX (Naked)		14-15			FA460HH		N/A
43								
44	INDIAN							
45	Chief All models Chief/Deluxe/Springfield/Road Master/Vintage		02-08	FA216/3		FA216/3HH		
46	Spirit All models Deluxe/Springfield/Roadblaster		02-08	FA216/3		FA216/3HH		
47	Scout All models Scout/Deluxe/Springfield		02-08	FA216/3		FA216/3HH		
48	Chief Blackhawk (Brembo calipers)		11	N/A		FA696HH		MD535
49	Chief Blackhawk Dark (Brembo calipers)		11	N/A		FA696HH		MD535
50	Chief		22	FA196		FA196HH		
51	Chief Dark Horse		22	FA196		FA196HH		
52	Chief Bobber		22	FA196		FA196HH		
53	Chief Bobber Dark Horse		22	FA196		FA196HH		
54	Super Chief		22	FA196		FA196HH		
55	Super Chief Limited		22	FA196		FA196HH		
56	Chief Classic (Brembo calipers)		11-13	N/A		FA696HH		MD535
57	Chief Standard (Brembo calipers)		09-11	N/A		FA696HH		MD535
58	Chief Deluxe (Brembo calipers)		09	N/A		FA696HH		MD535
59	Chief Roadmaster (Brembo calipers)		09-11	N/A		FA696HH		MD535

All names & numbers are for reference purposes only. © Registered trademarks of Harley—Davidson® Motor Corp or Buell.

Recommended Fittings: FA400 for use on polished chrome show rotors. FA400HH recommended fitting as replacement for OE.

NOTE: — Some models may have a second rotor fitted as an optional extra. Please double check with your customer exactly which side the front rotor is fitted and if twin rotor or single.

**BRAKE
APPLICATIONS**

*-2 Sets Required. ■ - Also available in MX-S race compound. **SAFETY WARNING:- DO NOT USE HH PADS ON REAR UNLESS ALSO USED ON FRONT TO AVOID BRAKE IMBALANCE**

Part numbers, prefixes, suffixes, photos and illustrations shown in this catalogue are trademarks and/or copyrights of EBC Brakes or the trademark owner A C Freeman Investments Ltd and use without express written permission of the owners is punishable by law.

FRONT: AMERICAN PRODUCED MOTORCYCLES

* This symbol indicates a rotor made of billet steel, and should be only used with EBC FA Kevlar® Organic or Vee pads.

		FRONT					Line #
		PADS	PADS	PADS	PADS	FRONT ROTOR OPTIONS	
SUFFIX OR PREFIX PAD MATERIALS AND DESCRIPTION		FA	V	HH/R	EPFA	DESIGN NO.	
INDIAN	YEAR	Kevlar Organic Pads	Semi-Sintered V-Pads™	Double-H™ USA-Made Sintered Pads	Premium Low Noise Street Sintered Pads	See Buyers Guide for rotor style & finish options. Part nos for ordering & sizing.	
Chief Vintage (Brembo calipers)	09-13	FA095*	FA095V*	FA095HH*		MD535*	1
Bomber (Brembo calipers)	10-11	FA095*	FA095V*	FA095HH*		MD535*	2
Dark Horse (Brembo calipers)	10-13	FA095*	FA095V*	FA095HH*		MD535*	3
Chief Classic (Nissin calipers)	14-17			FA347HH*		TBA	4
Chief Dark Horse (Nissin calipers)	16-21			FA347HH*		TBA	5
Chief Vintage (Nissin calipers)	14-21			FA347HH*		TBA	6
Chieftain	14-21			FA347HH*		TBA	7
Chieftain Dark Horse (Nissin Calipers/Cast Wheels)	14-21			FA347HH*		TBA	8
Chieftain Limited (Nissin Calipers/Cast Wheels)	14-21			FA347HH*		TBA	9
Chieftain Elite (Nissin Calipers/Cast Wheels)	14-21			FA347HH*		TBA	10
Challenger 1800	20-21			FA630HH*			11
Challenger 1800 Dark Horse (Brembo calipers/cast wheels)	20-21						12
Challenger 1800 Limited (Brembo calipers/cast wheels)	20-21						13
Roadmaster (Nissin Calipers/Cast Wheels)	15-21			FA347HH*		TBA	14
Roadmaster Dark Horse (Nissin Calipers/Cast Wheels)	15-21			FA347HH*		TBA	15
Roadmaster Limited (Nissin Calipers/Cast Wheels)	15-21			FA347HH*		TBA	16
Roadmaster Dark Horse Jack Daniel's Edition (Nissin Calipers/Cast Wheels)		21			FA347HH*	TBA	17
Roadmaster Elite (Nissin Calipers/Cast Wheels)	15-21			FA347HH*		TBA	18
Scout (Toso Calipers/Cast Wheels)	15-16	FA0672	FA0672V	FA0672HH		MD534	19
Scout	17-21	FA209/2	FA209/2V	FA209/2HH		MD534	20
Scout Sixty	17-21	FA209/2	FA209/2V	FA209/2HH		MD534	21
Scout Sixty (Toso Calipers/Cast Wheels)	16	FA0672	FA0672V	FA0672HH		MD534	22
Scout Bobber Scout Bobber	19-21	FA209/2	FA209/2V	FA209/2HH			23
Scout Bobber Twenty Scout Bobber Twenty	19-21	FA209/2	FA209/2V	FA209/2HH			24
Scout Bobber Sixty Scout Bobber Sixty	21	FA209/2	FA209/2V	FA209/2HH			25
Springfield	16-21			FA347HH*		TBA	26
Springfield Dark Horse	19-21			FA347HH*		TBA	27
FTR 1200	18-21			FA630HH*			28
FTR 1200 S	19-21			FA630HH*			29
FTR 1200 S Race Replica	19-20			FA630HH*			30
FTR 1200 Rally	20-21			FA630HH*			31
							32
							33
MOTUS							
MST-01	12-13			FA322/4HH*		TBA	34
MST	14-17	FA244*		FA244HH*		TBA	35
MSTR-01	12-13			FA322/4HH*		TBA	36
MSTR	14-17			FA447HH*		TBA	37
							38
							39
POLARIS (ATV)							
Outlaw 50	08-18	338*		338G*			40
Predator 50 (2 stroke)	04-07	338*		338G*			41
Scrambler 50 (3 Wheeler)	85-86	503*		503G			42
Scrambler 50	01-03	338*		338G*			43
Outlaw 90	07-16	338*		338G*			44
Predator 90	03-06	338*		338G*			45
Scrambler 90 X	01-03	338*		338G*			46
Sportsman 90	01-16	338*		338G*			47
Outlaw 110	16-18	338*		338G*			48
Phoenix 200 (AA/AB Model/Rear Drum Model)	05	FA159X*		FA159R*		MD6219D*	49
Phoenix 200 (AC/AD Model and Following/Rear Drum Model)	06-09	FA083X*		FA083R*		MD6274D*	50
Phoenix 200 (Rear Drum Model)	10-14			FA490R*		MD6274D*	51
Phoenix 200 Quadricycle Model (EA/EB/Rear disc model)	05	FA159X*		FA159R*		MD6219D*	52
Phoenix 200 Quadricycle Model (EC/ED Models/Rear disc model)	05-09	FA083X*		FA083R*		MD6274D*	53
Phoenix 200 Quadricycle Model (Rear disc model)	10			FA490R*		MD6274D*	54
Sawtooth 200 (Rear Drum Model)	06-07	FA083X*		FA083R*		MD6274D*	55
Sawtooth 200 Quadricycle (Rear Disc Model)	06	FA083X*		FA083R*		MD6274D*	56
Sawtooth 200 Quadricycle (Rear Disc Model)	08	FA083X*		FA083R*		MD6274D*	57
250 2 x 4 / 4 x 4	90	FA159X*		FA159R*		MD6149D*	58
250 2 x 4 / 4 x 4	93	FA159X*		FA159R*		MD6150D*	59

*-2 Sets Required. ■ - Also available in MX-S race compound. **SAFETY WARNING:- DO NOT USE HH PADS ON REAR UNLESS ALSO USED ON FRONT TO AVOID BRAKE IMBALANCE**

REAR: AMERICAN PRODUCED MOTORCYCLES

Line #	INDIAN SUFFIX OR PREFIX PAD MATERIALS AND DESCRIPTION YEAR	FRONT				FRONT ROTOR OPTIONS	
		PADS	PADS	PADS	PADS	DESIGN NO.	
		FA Kevlar Organic Pads	V Semi-Sintered V-Pads™	HH/R Double-H™ USA-Made Sintered Pads	EPFA Premium Low Noise Street Sintered Pads	See Buyers Guide for rotor style & finish options. Part nos for ordering & sizing.	
1	Chief Vintage (Brembo calipers)	09-13	N/A		FA696HH		MD535
2	Bomber (Brembo calipers)	10-11	N/A		FA696HH		MD535
3	Dark Horse (Brembo calipers)	10-13	N/A		FA696HH		MD535
4	Chief Classic (Nissin calipers)	14-17	FA196		FA196HH		
5	Chief Dark Horse (Nissin calipers)	16-21	FA196		FA196HH		MD887BLK
6	Chief Vintage (Nissin calipers)	14-21	FA196		FA196HH		MD887BLK
7	Chieftain 14-21	FA196			FA196HH		MD887BLK
8	Chieftain Dark Horse (Nissin Calipers/Cast Wheels)	14-21	FA196		FA196HH		MD887BLK
9	Chieftain Elite (Nissin Calipers/Cast Wheels)	14-21	FA196		FA196HH		MD887BLK
10	Chieftain Elite (Nissin Calipers/Cast Wheels)	14-21	FA196		FA196HH		MD887BLK
11	Challenger 1800	20-21	FA196		FA196HH		
12	Challenger 1800 Dark Horse (Brembo calipers/cast wheels)	20-21	FA196		FA196HH		
13	Challenger 1800 Limited (Brembo calipers/cast wheels)	20-21	FA196		FA196HH		
14	Roadmaster (Nissin Calipers/Cast Wheels)	15-21	FA196		FA196HH		MD887BLK
15	Roadmaster Dark Horse (Nissin Calipers/Cast Wheels)	15-21	FA196		FA196HH		MD887BLK
16	Roadmaster Limited (Nissin Calipers/Cast Wheels)	15-21	FA196		FA196HH		MD887BLK
17	Roadmaster Dark Horse Jack Daniel's Edition (Nissin Calipers/Cast Wheels)	21	FA196		FA196HH		MD887BLK
18	Roadmaster Elite (Nissin Calipers/Cast Wheels)	15-21	FA196		FA196HH		MD887BLK
19	Scout (Toso Calipers/Cast Wheels)	15-16	FA377X				MD534
20	Scout	17-21	FA213		FA213HH		MD534
21	Scout Sixty	17-21	FA213		FA213HH		MD534
22	Scout Sixty (Toso Calipers/Cast Wheels)	16	FA377X				MD534
23	Scout Bobber Scout Bobber	19-21	FA213		FA213HH		MD534
24	Scout Bobber Twenty Scout Bobber Twenty	19-21	FA213		FA213HH		
25	Scout Bobber Sixty Scout Bobber Sixty	21	FA213		FA213HH		
26	Springfield	16-21	FA196		FA196HH		MD887BLK
27	Springfield Dark Horse	19-21	FA196		FA196HH		MD887BLK
28	FTR 1200	18-21					MD8007
29	FTR 1200 S	19-21					MD8007
30	FTR 1200 S Race Replica	19-20					MD8007
31	FTR 1200 Rally	20-21					MD8007
32							
33	MOTUS						
34	MST-01	12-13	FA266				TBA
35	MST	14-17	FA266				TBA
36	MSTR-01	12-13	FA266				TBA
37	MSTR	14-17	FA266				TBA
38							
39	POLARIS (ATV)						
40	Outlaw 50	08-18	307		307G		
41	Predator 50 (2 stroke)	04-07	307		307G		
42	Scrambler 50 (3 Wheeler)	85-86	FA040				N/A
43	Scrambler 50	01-03	307		307G		
44	Outlaw 90	07-16	307		307G		
45	Predator 90	03-06	307		307G		
46	Scrambler 90 X	01-03	307		307G		
47	Sportsman 90	01-16	307		307G		
48	Outlaw 110	16-18	307		307G		
49	Phoenix 200 (AA/AB Model/Rear Drum Model)	05	306		306G		
50	Phoenix 200 (AC/AD Model and Following/Rear Drum Model)	06-09	306		306G		
51	Phoenix 200 (Rear Drum Model)	10-14	306		306G		
52	Phoenix 200 Quadricycle Model (EA/EB/Rear disc model)	05	FA067X		FA067R		MD6311D
53	Phoenix 200 Quadricycle Model (EC/ED Models/Rear disc model)	05-09	FA067X		FA067R		MD6311D
54	Phoenix 200 Quadricycle Model (Rear disc model)	10	FA067X		FA067R		MD6311D
55	Sawtooth 200 (Rear Drum Model)	06-07	306		306G		
56	Sawtooth 200 Quadricycle (Rear Disc Model)	06	FA067X		FA067R		MD6311D
57	Sawtooth 200 Quadricycle (Rear Disc Model)	08	FA067X		FA067R		MD6311D
58	250 2 x 4 / 4 x 4	90	FA232X		FA232R		N/A
59	250 2 x 4 / 4 x 4	93	FA232X		FA232R		N/A

*-2 Sets Required. ■ - Also available in MX-S race compound. **SAFETY WARNING:- DO NOT USE HH PADS ON REAR UNLESS ALSO USED ON FRONT TO AVOID BRAKE IMBALANCE**

Part numbers, prefixes, suffixes, photos and illustrations shown in this catalogue are trademarks and/or copyrights of EBC Brakes or the trademark owner A C Freeman Investments Ltd and use without express written permission of the owners is punishable by law.

All names & numbers are for reference purposes only. © Registered trademarks of Harley—Davidson® Motor Corp or Buell.

Recommended Fittings: FA400 for use on polished chrome show rotors. FA400HH recommended fitting as replacement for OE.

NOTE: — Some models may have a second rotor fitted as an optional extra. Please double check with your customer exactly which side the front rotor is fitted and if twin rotor or single.

BRAKE
APPLICATIONS

FRONT: AMERICAN PRODUCED MOTORCYCLES

* This symbol indicates a rotor made of billet steel, and should be only used with EBC FA Kevlar® Organic or Vee pads.

POLARIS (ATV)	SUFFIX OR PREFIX PAD MATERIALS AND DESCRIPTION	YEAR	FRONT				FRONT ROTOR OPTIONS	Line #
			PADS	PADS	PADS	PADS	DESIGN NO.	
			FA Kevlar Organic Pads	V Semi-Sintered V-Pads™	HH/R Double-H™ USA-Made Sintered Pads	EPFA Premium Low Noise Street Sintered Pads	See Buyers Guide for rotor style & finish options. Part nos for ordering & sizing.	
250 Cyclone X		87	503*		503G*		1	
Big Boss 250 4 x 6		89-90	FA159X*		FA159R*	MD6147D*	2	
Big Boss 250 4 x 6 Middle Axle Brake		89-90	FA159X		FA159R	MD6149D*	3	
Big Boss 250 4 x 6		91-92	FA159X*		FA159R*	MD6150D*	4	
Big Boss 250 4 x 6 Middle Axle Brake		91-92	FA159X		FA159R	MD6149D*	5	
Big Boss 250 6 x 6		91	FA159X*		FA159R*	MD6149D*	6	
Big Boss 250 6 x 6 Middle Axle Brake		91	FA159X		FA159R	MD6149D*	7	
Big Boss 250 6 x 6		92-93	FA159X*		FA159R*	MD6150D*	8	
Big Boss 250 6 x 6 Middle Axle Brake		92-93	FA159X		FA159R	MD6149D*	9	
Trail Blazer 250		90	FA159X*		FA159R*	MD6147D*	10	
Trail Blazer 250		91-93	FA159X*		FA159R*	MD6150D*	11	
Trail Blazer 250		94-98	FA159X*		FA159R*	MD6150D*	12	
Trail Blazer 250		99-00	FA159X*		FA159R*	MD6155D*	13	
Trail Blazer 250 (Freedom)		01-04	FA159X*		FA159R*	MD6155D*	14	
Trail Blazer 250		05-06	FA159X*		FA159R*	MD6262D*	15	
Trail Boss 250 2 x 4		85-87	503*		503G*		16	
Trail Boss 250		88-90	FA159X*		FA159R*	MD6147D*	17	
Trail Boss 250		91-99	FA159X*		FA159R*	MD6150D*	18	
Trail Boss 250 4 x 4		87	FA54X*		FA54R*	MD6147D*	19	
Trail Boss 250 2 x 4/4 x 4		88-89	FA159X*		FA159R*	MD6147D*	20	
Trail Boss 250 2 x 4/4 x 4		91-92	FA159X*		FA159R*	MD6150D*	21	
Xplorer 250 (4 x 4)			FA159X*		FA159R*	MD6155D*	22	
300 2 x 4 / 4 x 4		94-95	FA159X*		FA159R*	MD6150D*	23	
Big Boss 300 6 x 6		94	FA159X*		FA159R*	MD6150D*	24	
Big Boss 300 6 x 6 Middle Axle Brake		94	FA159X*		FA159R*	MD6149D*	25	
Hawkeye 300 2 x 4		06	FA395X*		FA395R*	MD6272D*	26	
Hawkeye 300 2 x 4		08-09	FA159X*		FA159R*	MD6272D*	27	
Hawkeye 300 4 x 4		06	FA395X*		FA395R*	MD6272D*	28	
Hawkeye 300 2 x 4/4 x 4		07	FA159X*		FA159R*	MD6272D*	29	
Sportsman 300 (4 x 4)		08-10	FA159X*		FA159R*	MD6272D*	30	
Xplorer 300 4 x 4		96-00	FA159X*		FA159R*	MD6150D*	31	
Xpress 300/400 L		96-97	FA159X*		FA159R*	MD6150D*	32	
Xpress 300 2 x 4		98-00	FA159X*		FA159R*	MD6150D*	33	
Hawkeye 325 2 x 4		15	FA159X*		FA159R*	MD6202D*	34	
Magnum 325 (4 x 4) (2 x 4)			FA159X*		FA159R*	MD6155D*	35	
Magnum 325 2 x 4/4 x 4 Moose		01	FA159X*		FA159R*	MD6155D*	36	
Magnum 325 (2 x 4) HDS		02	FA159X*		FA159R*	MD6155D*	37	
Magnum 325 4 x 4 (A02CD32AA/AB/AC)		02	FA159X*		FA159R*	MD6155D*	38	
Magnum 325 4 x 4 HDS (A02CD32FB)		02	FA159X*		FA159R*	MD6202D*	39	
Sportsman 325 Ace		14	FA656X*		FA656R*	MD6202D*	40	
Sportsman 325 Ace EFI		15	FA656X*		FA656R*	MD6202D*	41	
Sportsman 325 Ace Euro		14-15	FA656X*		FA656R*	MD6202D*	42	
Sportsman 325 Ace HD		15	FA656X*		FA656R*	MD6202D*	43	
Trail Boss 325			FA159X*		FA159R*	MD6155D*	44	
Trail Boss 325		01-02	FA159X*		FA159R*	MD6155D*	45	
Xpedition 325			FA159X*		FA159R*	MD6155D*	46	
Xpedition 325		02	FA159X*		FA159R*	MD6155D*	47	
330 ATP (4 x 4)		04-05	FA159X*		FA159R*	MD6202D*	48	
Magnum 330 (2 x 4/HDS)		03-06	FA159X*		FA159R*	MD6149D*	49	
Magnum 330 (4 x 4/HDS)		03-04	FA159X*		FA159R*	MD6202D*	50	
Trail Boss 330		03-04	FA159X*		FA159R*	MD6155D*	51	
Trail Boss 330		05-09	FA159X*		FA159R*	MD6262D*	52	
Trail Boss 330		10-13	FA159X*		FA159R*	MD6202D*	53	
Trail Blazer 330		08-09	FA159X*		FA159R*	MD6262D*	54	
Trail Blazer 330		10-13	FA159X*		FA159R*	MD6202D*	55	
Sportsman 335 4 x 4		99-00	FA159X*		FA159R*	MD6150D*	56	
Sportsman 335 /Worker 4 x 4		99-00	FA159X*		FA159R*	MD6149D*	57	
350 L 2 x 4		90	FA159X*		FA159R*	MD6150D*	58	
350 L 4 x 4		90	FA159X*		FA159R*	MD6149D*	59	

*-2 Sets Required. ■ - Also available in MX-S race compound. **SAFETY WARNING:- DO NOT USE HH PADS ON REAR UNLESS ALSO USED ON FRONT TO AVOID BRAKE IMBALANCE**

REAR: AMERICAN PRODUCED MOTORCYCLES

Line #	POLARIS (ATV)	SUFFIX OR PREFIX PAD MATERIALS AND DESCRIPTION	YEAR	FRONT				
				PADS	PADS	PADS	PADS	FRONT ROTOR OPTIONS
				FA	V	HH/R	EPFA	DESIGN NO.
				Kevlar Organic Pads	Semi-Sintered V-Pads™	Double-H™ USA-Made Sintered Pads	Premium Low Noise Street Sintered Pads	See Buyers Guide for rotor style & finish options. Part nos for ordering & sizing.
1	250 Cyclone X		87	FA040				N/A
2	Big Boss 250 4 x 6		89-90	FA232X		FA232R		N/A
3	Big Boss 250 4 x 6 Middle Axle Brake		89-90					
4	Big Boss 250 4 x 6		91-92	FA232X		FA232R		N/A
5	Big Boss 250 4 x 6 Middle Axle Brake		91-92					
6	Big Boss 250 6 x 6		91	FA232X		FA232R		N/A
7	Big Boss 250 6 x 6 Middle Axle Brake		91					
8	Big Boss 250 6 x 6		92-93	FA232X		FA232R		N/A
9	Big Boss 250 6 x 6 Middle Axle Brake		92-93					
10	Trail Blazer 250		90	FA232X		FA232R		N/A
11	Trail Blazer 250		91-93	FA232X		FA232R		N/A
12	Trail Blazer 250		94-98	FA232X		FA232R		N/A
13	Trail Blazer 250		99-00	FA270X		FA270R		MD6156D
14	Trail Blazer 250 (Freedom)		01-04	FA270X		FA270R		MD6156D
15	Trail Blazer 250		05-06	N/A		FA314R		MD6256D
16	Trail Boss 250 2 x 4		85-87	FA040				N/A
17	Trail Boss 250		88-90	FA232X		FA232R		N/A
18	Trail Boss 250		91-99	FA232X		FA232R		N/A
19	Trail Boss 250 4 x 4		87	FA232X		FA232R		N/A
20	Trail Boss 250 2 x 4/4 x 4		88-89	FA232X		FA232R		N/A
21	Trail Boss 250 2 x 4/4 x 4		91-92	FA232X		FA232R		N/A
22	Xplorer 250 (4 x 4)			FA270X		FA270R		N/A
23	300 2 x 4 / 4 x 4		94-95	FA232X		FA232R		N/A
24	Big Boss 300 6 x 6		94	FA232X		FA232R		N/A
25	Big Boss 300 6 x 6 Middle Axle Brake		94					
26	Hawkeye 300 2 x 4		06	FA395X		FA395R		MD6273D
27	Hawkeye 300 2 x 4		08-09	FA159X		FA159R		MD6273D
28	Hawkeye 300 4 x 4		06	FA395X		FA395R		MD6273D
29	Hawkeye 300 2 x 4/4 x 4		07	FA159X		FA159R		MD6273D
30	Sportsman 300 (4 x 4)		08-10	FA159X		FA159R		MD6273D
31	Xplorer 300 4 x 4		96-00	FA232X		FA232R		N/A
32	Xpress 300/400 L		96-97	FA232X		FA232R		N/A
33	Xpress 300 2 x 4		98-00	FA232X		FA232R		N/A
34	Hawkeye 325 2 x 4		15	FA475X		FA475R		MD6275D
35	Magnum 325 (4 x 4) (2 x 4)			FA270X		FA270R		MD6156D
36	Magnum 325 2 x 4/4 x 4 Moose		01	FA270X		FA270R		MD6156D
37	Magnum 325 (2 x 4) HDS		02	N/A		FA314R		MD6200D
38	Magnum 325 4 x 4 (A02CD32AA/AB/AC)		02	N/A		FA314R		MD6200D
39	Magnum 325 4 x 4 HDS (A02CD32FB)		02	N/A		FA314R		MD6200D
40	Sportsman 325 Ace		14			FA354R		MD6275D
41	Sportsman 325 Ace EFI		15			FA354R		MD6275D
42	Sportsman 325 Ace Euro		14-15			FA354R		MD6275D
43	Sportsman 325 Ace HD		15			FA354R		MD6275D
44	Trail Boss 325			FA270X		FA270R		MD6156D
45	Trail Boss 325		01-02	FA270X		FA270R		MD6156D
46	Xpedition 325			FA270X		FA270R		MD6156D
47	Xpedition 325		02	N/A		FA314R		MD6200D
48	330 ATP (4 x 4)		04-05	FA159X		FA159R		MD6200D
49	Magnum 330 (2 x 4/HDS)		03-06	N/A		FA314R		MD6200D
50	Magnum 330 (4 x 4/HDS)		03-04	N/A		FA314R		MD6200D
51	Trail Boss 330		03-04	FA270X		FA270R		MD6156D
52	Trail Boss 330		05-09	N/A		FA314R		MD6256D
53	Trail Boss 330		10-13	N/A		FA314R		MD6256D
54	Trail Blazer 330		08-09	N/A		FA314R		MD6256D
55	Trail Blazer 330		10-13	N/A		FA314R		MD6256D
56	Sportsman 335 4 x 4		99-00	FA270X		FA270R		N/A
57	Sportsman 335 /Worker 4 x 4		99-00	FA270X		FA270R		N/A
58	350 L 2 x 4		90	FA232X		FA232R		N/A
59	350 L 4 x 4		90	FA232X		FA232R		N/A

All names & numbers are for reference purposes only. © Registered trademarks of Harley—Davidson® Motor Corp or Buell.

Recommended Fittings: FA400 for use on polished chrome show rotors. FA400HH recommended fitting as replacement for OE.

NOTE: — Some models may have a second rotor fitted as an optional extra. Please double check with your customer exactly which side the front rotor is fitted and if twin rotor or single.

**BRAKE
APPLICATIONS**

*-2 Sets Required. ■ - Also available in MX-S race compound. **SAFETY WARNING:- DO NOT USE HH PADS ON REAR UNLESS ALSO USED ON FRONT TO AVOID BRAKE IMBALANCE**

Part numbers, prefixes, suffixes, photos and illustrations shown in this catalogue are trademarks and/or copyrights of EBC Brakes or the trademark owner A C Freeman Investments Ltd and use without express written permission of the owners is punishable by law.

FRONT: AMERICAN PRODUCED MOTORCYCLES

* This symbol indicates a rotor made of billet steel, and should be only used with EBC FA Kevlar® Organic or Vee pads.

POLARIS (ATV)		FRONT					Line #
		PADS				FRONT ROTOR OPTIONS	
		SUFFIX OR PREFIX PAD MATERIALS AND DESCRIPTION	FA	V	HH/R	EPFA	
	YEAR	Kevlar Organic Pads	Semi-Sintered V-Pads™	Double-H™ USA-Made Sintered Pads	Premium Low Noise Street Sintered Pads	See Buyers Guide for rotor style & finish options. Part nos for ordering & sizing.	
350 L 4 x 4	93	FA159X*		FA159R*		MD6150D*	1
Big Boss 350 L	93	FA159X*		FA159R*		MD6149D*	2
Big Boss 350 L Middle Axle Brake	93	FA159X*		FA159R*		MD6149D*	3
Sportsman 350 4 x 4	93	FA159X*		FA159R*		MD6149D*	4
Trail Boss 350 L 2 x 4	91-93	FA159X*		FA159R*		MD6150D*	5
Trail Boss 350 L 4 x 4	91	FA159X*		FA159R*		MD6149D*	6
400 L 2 x 4	94-95	FA159X*		FA159R*		MD6150D*	7
400 L 4 x 4	94	FA159X*		FA159R*		MD6149D*	8
Big Boss 400 L 6 x 6	94-95	FA159X*		FA159R*		MD6149D*	9
Big Boss 400 L 6 x 6 Middle Axle Brake	94-95	FA159X*		FA159R*		MD6149D*	10
Big Boss 400 L 6 x 6	96	FA159X*		FA159R*		MD6149D*	11
Big Boss 400 L 6 x 6 Middle Axle Brake	96			FA273R*		MD6153D	12
Big Boss 400 L 6 x 6	97	FA159X*		FA159R*		MD6149D*	13
Big Boss 400 L 6 x 6 Middle Axle Brake	97	FA159X*		FA159R*		MD6149D*	14
Hawkeye 400 H.O. 2 x 4	13-14	FA159X*		FA159R*		MD6202D*	15
Scrambler 400 L 4 x 4	95-97	FA159X*		FA159R*		MD6150D*	16
Scrambler 400 (2 x 4/4 x 4)		FA159X*		FA159R*		MD6155D*	17
Scrambler 400 4 x 4	98-02	FA159X*		FA159R*		MD6155D*	18
Scrambler 400 2 x 4	02	FA159X*		FA159R*		MD6155D*	19
Sport 400 L	94-98	FA159X*		FA159R*		MD6150D*	20
Sport 400	99-00	FA159X*		FA159R*		MD6150D*	21
Sportsman 400 L 4 x 4	94-97	FA159X*		FA159R*		MD6149D*	22
Sportsman 400	01-02	FA159X*		FA159R*		MD6149D*	23
Sportsman 400	03	FA159X*		FA159R*		MD6149D*	24
Sportsman 400 (Code CH42AA/AE/AG)	04	FA159X*		FA159R*		MD6149D*	25
Sportsman 400 (Code CH42AQ/AR/AS/AT/AV)	04	FA159X*		FA159R*		MD6202D*	26
Sportsman 400 HO 4 x 4	08-10	FA159X*		FA159R*		MD6272D*	27
Sportsman 400 HO 4 x 4	11-14	FA159X*		FA159R*		MD6202D*	28
Trail Blazer 400	03	FA159X*		FA159R*		MD6155D*	29
Xplorer 400 L 4 x 4	95-98	FA159X*		FA159R*		MD6149D*	30
Xplorer 400 L 4 x 4	99-00	FA159X*		FA159R*		MD6149D*	31
Xplorer 400 4 x 4	01-02	FA159X*		FA159R*		MD6155D*	32
Xplorer 400	01-02	FA159X*		FA159R*		MD6149D*	33
Magnum 425 2 x 4	95-98	FA159X*		FA159R*		MD6150D*	34
Magnum 425 4 x 4	95-98	FA159X*		FA159R*		MD6149D*	35
Magnum 425 6 x 6	96	FA159X*		FA159R*		MD6149D*	36
Magnum 425 6 x 6 Middle Axle Brake	96			FA273R*		MD6153D*	37
Magnum 425 6 x 6	97	FA159X*		FA159R*		MD6149D*	38
Magnum 425 6 x 6 Middle Axle Brake	97	FA159X*		FA159R*		MD6149D*	39
Xpedition 425 (4 x 4)		FA159X*		FA159R*		MD6149D*	40
Outlaw 450 S	08	FA456X*		FA456R*		MD6219D*	41
Outlaw 450 MXR	09-10	FA456X*		FA456R*		MD6219D*	42
Sportsman 450	06	FA159X*		FA159R*		MD6202D*	43
Sportsman 450	07	FA159X*		FA159R*		MD6202D*	44
455cc Diesel 4 x 4 EBS	99-00	FA159X*		FA159R*		MD6149D*	45
455cc Diesel	01	FA159X*		FA159R*		MD6149D*	46
500 ATP HO (4 x 4)	04-05	FA159X*		FA159R*		MD6202D*	47
500 ATV Pro 4 x 4 PPS	02	FA159X*		FA159R*		MD6202D*	48
Big Boss 500 6 x 6	98-99	FA159X*		FA159R*		MD6149D*	49
Big Boss 500 6 x 6 Middle Axle Brake	98-99	FA159X*		FA159R*		MD6149D*	50
Magnum 500 (4 x 4)	99-00	FA159X*		FA159R*		MD6149D*	51
Magnum 500	01	FA159X*		FA159R*		MD6149D*	52
Magnum 500 (2 x 39906 x 4 HDS)	02	FA159X*		FA159R*		MD6149D*	53
Magnum 500 4 x 4 HDS	02-03	FA159X*		FA159R*		MD6202D*	54
Outlaw	06-07	FA159X*		FA159R*		MD6219D*	55
Predator 500/TLD	03-07	FA159X*		FA159R*		MD6219D*	56
Scrambler 500 2 x 4	01-02	FA159X*		FA159R*		MD6155D*	57
Scrambler 500 2 x 4	07-08	FA159X*		FA159R*		MD6262D*	58
Scrambler 500 4 x 4	97	FA159X*		FA159R*		MD6150D*	59

*-2 Sets Required. ■ - Also available in MX-S race compound. **SAFETY WARNING:- DO NOT USE HH PADS ON REAR UNLESS ALSO USED ON FRONT TO AVOID BRAKE IMBALANCE**

REAR: AMERICAN PRODUCED MOTORCYCLES

Line #	POLARIS (ATV)	SUFFIX OR PREFIX PAD MATERIALS AND DESCRIPTION	YEAR	FRONT				
				PADS	PADS	PADS	PADS	FRONT ROTOR OPTIONS
				FA Kevlar Organic Pads	V Semi-Sintered V-Pads™	HH/R Double-H™ USA-Made Sintered Pads	EPFA Premium Low Noise Street Sintered Pads	DESIGN NO. <small>See Buyers Guide for rotor style & finish options. Part nos for ordering & sizing.</small>
1	350 L 4 x 4		93	FA232X		FA232R		N/A
2	Big Boss 350 L		93	FA232X		FA232R		N/A
3	Big Boss 350 L Middle Axle Brake		93					
4	Sportsman 350 4 x 4		93	FA232X		FA232R		N/A
5	Trail Boss 350 L 2 x 4		91-93	FA232X		FA232R		N/A
6	Trail Boss 350 L 4 x 4		91	FA232X		FA232R		N/A
7	400 L 2 x 4		94-95	FA232X		FA232R		N/A
8	400 L 4 x 4		94	FA232X		FA232R		N/A
9	Big Boss 400 L 6 x 6		94-95	FA232X		FA232R		N/A
10	Big Boss 400 L 6 x 6 Middle Axle Brake		94-95					
11	Big Boss 400 L 6 x 6		96	FA232X		FA232R		N/A
12	Big Boss 400 L 6 x 6 Middle Axle Brake		96					
13	Big Boss 400 L 6 x 6		97	FA232X		FA232R		N/A
14	Big Boss 400 L 6 x 6 Middle Axle Brake		97					
15	Hawkeye 400 H.O. 2 x 4		13-14	FA475X		FA475R		MD6274D
16	Scrambler 400 L 4 x 4		95-97	FA232X		FA232R		N/A
17	Scrambler 400 (2 x 4/4 x 4)			FA270X		FA270R		MD6156D
18	Scrambler 400 4 x 4		98-02	FA270X		FA270R		MD6156D
19	Scrambler 400 2 x 4		02	FA270X		FA270R		MD6156D
20	Sport 400 L		94-98	FA232X		FA232R		N/A
21	Sport 400		99-00	FA270X		FA270R		MD6156D
22	Sportsman 400 L 4 x 4		94-97	FA232X		FA232R		N/A
23	Sportsman 400		01-02	FA270X		FA270R		N/A
24	Sportsman 400		03	N/A		FA314R		MD6201D
25	Sportsman 400 (Code CH42AA/AE/AG)		04	N/A		FA314R		MD6201D
26	Sportsman 400 (Code CH42AQ/AR/AS/AT/AV)		04	N/A		FA314R		MD6201D
27	Sportsman 400 HO 4 x 4		08-10	FA159X		FA159R		MD6273D
28	Sportsman 400 HO 4 x 4		11-14	FA475X		FA475R		MD6275D
29	Trail Blazer 400		03	FA270X		FA270R		MD6156D
30	Xplorer 400 L 4 x 4		95-98	FA232X		FA232R		N/A
31	Xplorer 400 L 4 x 4		99-00	FA270X		FA270R		MD6169D
32	Xplorer 400 4 x 4		01-02	FA270X		FA270R		MD6156D
33	Xplorer 400		01-02	FA270X		FA270R		MD6169D
34	Magnum 425 2 x 4		95-98	FA232X		FA232R		N/A
35	Magnum 425 4 x 4		95-98	FA232X		FA232R		N/A
36	Magnum 425 6 x 6		96	FA232X		FA232R		N/A
37	Magnum 425 6 x 6 Middle Axle Brake		96					
38	Magnum 425 6 x 6		97	FA232X		FA232R		N/A
39	Magnum 425 6 x 6 Middle Axle Brake		97					
40	Xpedition 425 (4 x 4)			FA270X		FA270R		MD6156D
41	Outlaw 450 S		08	FA159X		FA159R		MD6218D
42	Outlaw 450 MXR		09-10	FA159X		FA159R		MD6290D
43	Sportsman 450		06	N/A		FA314R		MD6201D
44	Sportsman 450		07	N/A		FA314R		MD6275D
45	455cc Diesel 4 x 4 EBS		99-00	FA270X		FA270R		N/A
46	455cc Diesel		01	FA270X		FA270R		N/A
47	500 ATP HO (4 x 4)		04-05	FA159X		FA159R		MD6200D
48	500 ATV Pro 4 x 4 PPS		02	N/A		FA314R		MD6200D
49	Big Boss 500 6 x 6		98-99	FA232X		FA232R		N/A
50	Big Boss 500 6 x 6 Middle Axle Brake		98-99					
51	Magnum 500 (4 x 4)		99-00	FA270X		FA270R		MD6156D
52	Magnum 500		01	FA270X		FA270R		MD6156D
53	Magnum 500 (2 x 39906 x 4 HDS)		02	N/A		FA314R		MD6200D
54	Magnum 500 4 x 4 HDS		02-03	N/A		FA314R		MD6200D
55	Outlaw		06-07	FA159X		FA159R		MD6290D
56	Predator 500/TLD		03-07	FA159X		FA159R		MD6218D
57	Scrambler 500 2 x 4		01-02	FA270X		FA270R		MD6156D
58	Scrambler 500 2 x 4		07-08	N/A		FA314R		MD6256D
59	Scrambler 500 4 x 4		97	FA232X		FA232R		N/A

*-2 Sets Required. ■ - Also available in MX-S race compound. **SAFETY WARNING:- DO NOT** USE HH PADS ON REAR UNLESS ALSO USED ON FRONT TO AVOID BRAKE IMBALANCE

Part numbers, prefixes, suffixes, photos and illustrations shown in this catalogue are trademarks and/or copyrights of EBC Brakes or the trademark owner A C Freeman Investments Ltd and use without express written permission of the owners is punishable by law.

All names & numbers are for reference purposes only. © Registered trademarks of Harley—Davidson® Motor Corp or Buell.

Recommended Fittings: FA400 for use on polished chrome show rotors. FA400HH recommended fitting as replacement for OE.

NOTE: — Some models may have a second rotor fitted as an optional extra. Please double check with your customer exactly which side the front rotor is fitted and if twin rotor or single.

BRAKE
APPLICATIONS

FRONT: AMERICAN PRODUCED MOTORCYCLES

* This symbol indicates a rotor made of billet steel, and should be only used with EBC FA Kevlar® Organic or Vee pads.

POLARIS (ATV)	SUFFIX OR PREFIX PAD MATERIALS AND DESCRIPTION	YEAR	FRONT				FRONT ROTOR OPTIONS DESIGN NO. <small>See Buyers Guide for rotor style & finish options. Part nos for ordering & sizing.</small>	Line #
			PADS	PADS	PADS	PADS		
			FA Kevlar Organic Pads	V Semi-Sintered V-Pads™	HH/R Double-H™ USA-Made Sintered Pads	EPFA Premium Low Noise Street Sintered Pads		
Scrambler 500 4 x 4		98-04	FA159X*		FA159R*		MD6155D*	1
Scrambler 500 4 x 4		05-09	FA159X*		FA159R*		MD6155D*	2
Scrambler 500 4 x 4		10-12	FA159X*		FA159R*		MD6202D*	3
Sportsman 500 4 x 4		96	FA159X*		FA159R*		MD6149D*	4
Sportsman 500 4 x 4		97	FA159X*		FA159R*		MD6149D*	5
Sportsman 500 /Worker 4 x 4 EBS/500 RSE		98-02	FA159X*		FA159R*		MD6149D*	6
Sportsman 500 HO/EFI Demand Drive		03-04	FA159X*		FA159R*		MD6149D*	7
Sportsman 500 EFI/HO		04-06	FA159X*		FA159R*		MD6202D*	8
Sportsman 500 EFI/HO		07-08	FA159X*		FA159R*		MD6202D*	9
Sportsman 500 HO (Built up to 15/12/08)		08	FA159X*		FA159R*		MD6202D*	10
Sportsman 500 HO (Built from 16/12/08)		09-13	FA159X*		FA159R*		MD6202D*	11
Sportsman 500 X2		06-08	FA159X*		FA159R*		MD6202D*	12
Sportsman 500 6 x 6		00-08	FA159X*		FA159R*		MD6149D*	13
Sportsman 500 X 2 EFI		07-09	FA159X*		FA159R*		MD6202D*	14
Sportsman 500 Forest		12	FA159X*		FA159R*		MD6202D*	15
Sportsman 500 Touring H.O.		08-11	FA159X*		FA159R*		MD6202D*	16
Sportsman 500 Touring H.O.		11-13	FA159X*		FA159R*		MD6202D*	17
Sportsman 500 EFI Quad H.O.		08-11	FA159X*		FA159R*		MD6202D*	18
Sportsman 500 XP		09	FA475X*		FA475R*		MD6339D*	19
Xplorer 4 x 4		97	FA159X*		FA159R*		MD6149D*	20
Xplorer S		08-10	FA456X*		FA456R*		MD6219D*	21
Outlaw IRS		08-11	FA456X*		FA456R*		MD6219D*	22
Sportsman 550		11-13	FA475X*		FA475R*		MD6339D*	23
Sportsman 550 EPS		10-14	FA475X*		FA475R*		MD6339D*	24
Sportsman 550 Forest		10-12	FA475X*		FA475R*		MD6339D*	25
Sportsman 550 XP EPS		09-11	FA475X*		FA475R*		MD6339D*	26
Sportsman 550 X2		10-14	FA475X*		FA475R*		MD6339D*	27
Sportsman 550 Touring EPS		10-14	FA475X*		FA475R*		MD6339D*	28
Sportsman 570 Ace		15-18	FA656X*		SXR656HH*		MD6202D*	29
Sportsman 570 Ace Euro		15-18	FA656X*		SXR656HH*		MD6202D*	30
Sportsman 570 Efi (Inc EPS Models)		11-21	FA159X*		SXR159HH*		MD6202D*	31
Sportsman 570 EFI X2		15-21	FA159X*		SXR159HH*		MD6202D*	32
Sportsman 570 Forest Tracker Efi/EPS		15	FA159X*		SXR159HH*		MD6202D*	33
Sportsman 570 Touring EFI		14-21	FA159X*		SXR159HH*		MD6202D*	34
Sportsman 570 Touring Tractor Efi EPS		16-21	FA159X*		SXR159HH*		MD6202D*	35
Sportsman 570 6X6		17-21	FA159X*		SXR159HH*		MD6202D*	36
Sportsman 570 6X6 Tractor		17-21	FA159X*		SXR159HH*		MD6202D*	37
Sportsman 600 4 x 4		03-05	FA159X*		SXR159HH*		MD6202D*	38
Sportsman 700 (4 x 4)/EFI		02-06	FA159X*		SXR159HH*		MD6202D*	39
Sportsman 700 MV		05-06	FA159X*		SXR159HH*		MD6202D*	40
Sportsman 700 EFI		07	FA159X*		SXR159HH*		MD6202D*	41
Sportsman 700 X 2		08	FA159X*		SXR159HH*		MD6202D*	42
Sportsman 800 EFI		05-06	FA159X*		SXR159HH*		MD6202D*	43
Sportsman 800 EFI (Built up to 15/12/08)		08	FA159X*		SXR159HH*		MD6202D*	44
Sportsman 800 EFI (Built up after 16/12/08)		09	FA159X*		SXR159HH*		MD6202D*	45
Sportsman 800 EFI		10-13	FA159X*		SXR159HH*		MD6202D*	46
Sportsman 800 X 2 EFI		07-09	FA159X*		SXR159HH*		MD6202D*	47
Sportsman 800 EFI Intl/HO		07-11	FA159X*		SXR159HH*		MD6202D*	48
Sportsman 800		12-14	FA475X*				MD6339D*	49
Sportsman 800 Forest		12	FA475X*				MD6339D*	50
Sportsman 800 Touring/EFI		08-09	FA159X*		SXR159HH*		MD6202D*	51
Sportsman 800 Big Boss/EFI 6 x 6/EFI		09-14	FA159X*		SXR159HH*		MD6202D*	52
Forest 850		15	FA475X*				MD6339D*	53
Scrambler 850		15	FA475X*				MD6339D*	54
Sportsman 850 Touring EPS		10-13	FA475X*				MD6339D*	55
Sportsman 850 Touring H.O. EPS		13-15	FA475X*				MD6339D*	56
Sportsman 850 Forest		12	FA475X*		FA475R*		MD6339D*	57
Scrambler 850 XP H.O.		13-15	FA475X*		FA475R*		MD6339D*	58
Sportsman 850 XP		09-13	FA475X*		FA475R*		MD6339D*	59

*-2 Sets Required. ■ - Also available in MX-S race compound. **SAFETY WARNING:- DO NOT USE HH PADS ON REAR UNLESS ALSO USED ON FRONT TO AVOID BRAKE IMBALANCE**

REAR: AMERICAN PRODUCED MOTORCYCLES

Line #	POLARIS (ATV)	SUFFIX OR PREFIX PAD MATERIALS AND DESCRIPTION	YEAR	FRONT				
				PADS	PADS	PADS	PADS	FRONT ROTOR OPTIONS
				FA Kevlar Organic Pads	V Semi-Sintered V-Pads™	HH/R Double-H™ USA-Made Sintered Pads	EPFA Premium Low Noise Street Sintered Pads	DESIGN NO. <small>See Buyers Guide for rotor style & finish options. Part nos for ordering & sizing.</small>
1	Scrambler 500 4 x 4	98-04	FA270X		FA270R		MD6156D	
2	Scrambler 500 4 x 4	05-09	N/A		FA314R		MD6256D	
3	Scrambler 500 4 x 4	10-12	N/A		FA314R		MD6256D	
4	Sportsman 500 4 x 4	96	FA232X		FA232R		MD6201D	
5	Sportsman 500 4 x 4	97	FA232X		FA232R		MD6154D	
6	Sportsman 500 /Worker 4 x 4 EBS/500 RSE	98-02	FA270X		FA270R		N/A	
7	Sportsman 500 HO/EFI Demand Drive	03-04	N/A		FA314R		MD6201D	
8	Sportsman 500 EFI/HO	04-06			FA314R		MD6201D	
9	Sportsman 500 EFI/HO	07-08	N/A		FA314R		MD6275D	
10	Sportsman 500 HO (Built up to 15/12/08)	08	N/A		FA314R		MD6275D	
11	Sportsman 500 HO (Built from 16/12/08)	09-13	FA475X		FA475R		MD6275D	
12	Sportsman 500 X2	06-08	N/A		FA314R		MD6275D	
13	Sportsman 500 6 x 6	00-08	N/A		FA313R		MD6170D	
14	Sportsman 500 X 2 EFI	07-09	FA159X		FA159R		MD6275D	
15	Sportsman 500 Forest	12	N/A		FA314R		MD6275D	
16	Sportsman 500 Touring H.O.	08-11	FA159X		FA159R		MD6275D	
17	Sportsman 500 Touring H.O.	11-13			FA354R		MD6275D	
18	Sportsman 500 EFI Quad H.O.	08-1	N/A		FA314R		MD6275D	
19	Sportsman 500 XP	09	FA475X		FA475R		MD6339D	
20	Xplorer 4 x 4	97	FA232X		FA232R		N/A	
21	Xplorer S	08-10	FA159X		FA159R		MD6218D	
22	Outlaw IRS	08-11	FA159X		FA159R		MD6290D	
23	Sportsman 550	11-13	FA475X		FA475R		MD6339D	
24	Sportsman 550 EPS	10-14	FA475X		FA475R		MD6339D	
25	Sportsman 550 Forest	10-12	FA475X		FA475R		MD6339D	
26	Sportsman 550 XP EPS	09-11	FA475X		FA475R		MD6339D	
27	Sportsman 550 X2	10-14	FA475X		FA475R		MD6339D	
28	Sportsman 550 Touring EPS	10-14	FA475X		FA475R		MD6339D	
29	Sportsman 570 Ace	15-18			FA354R		MD6275D	
30	Sportsman 570 Ace Euro	15-18			FA354R		MD6275D	
31	Sportsman 570 Efi (Inc EPS Models)	11-21	FA475X		FA475R		MD6275D	
32	Sportsman 570 EFI X2	15-21	FA475X		FA475R		MD6275D	
33	Sportsman 570 Forest Tracker Efi/EPS	15	FA475X		FA475R		MD6275D	
34	Sportsman 570 Touring EFI	14-21	FA475X		FA475R		MD6275D	
35	Sportsman 570 Touring Tractor Efi EPS	16-21	FA475X		FA475R		MD6275D	
36	Sportsman 570 6X6	17-21	FA475X		FA475R		MD6275D	
37	Sportsman 570 6X6 Tractor	17-21	FA475X		FA475R		MD6275D	
38	Sportsman 600 4 x 4	03-05	N/A		FA314R		MD6201D	
39	Sportsman 700 (4 x 4)/EFI	02-06	N/A		FA314R		MD6201D	
40	Sportsman 700 MV	05-06	N/A		FA314R		MD6201D	
41	Sportsman 700 EFI	07	N/A		FA314R		MD6275D	
42	Sportsman 700 X 2	08	FA159X		FA159R		MD6275D	
43	Sportsman 800 EFI	05-06	N/A		FA314R		MD6201D	
44	Sportsman 800 EFI (Built up to 15/12/08)	N/A			FA314R		MD6275D	
45	Sportsman 800 EFI (Built up after 16/12/08)	N/A			FA314R		MD6275D	
46	Sportsman 800 EFI	N/A			FA475R		MD6275D	
47	Sportsman 800 X 2 EFI		FA159X		FA159R		MD6275D	
48	Sportsman 800 EFI Intl/HO	N/A			FA314R		MD6275D	
49	Sportsman 800	12-14	FA475X		FA475R		MD6339D	
50	Sportsman 800 Forest	12	FA475X		FA475R		MD6339D	
51	Sportsman 800 Touring/EFI	08-09	FA159X		FA159R		MD6275D	
52	Sportsman 800 Big Boss/EFI 6 x 6/EFI	09-14			FA314R		MD6275D	
53	Forest 850	15	FA475X		FA475R		MD6339D	
54	Scrambler 850	15	FA475X		FA475R		MD6339D	
55	Sportsman 850 Touring EPS	10-13	FA475X		FA475R		MD6339D	
56	Sportsman 850 Touring H.O. EPS	13-15	FA475X		FA475R		MD6339D	
57	Sportsman 850 Forest	12	FA475X		FA475R		MD6339D	
58	Scrambler 850 XP H.O.	13-15	FA475X		FA475R		MD6339D	
59	Sportsman 850 XP	09-13	FA475X		FA475R		MD6339D	

*-2 Sets Required. ■ - Also available in MX-S race compound. **SAFETY WARNING:- DO NOT** USE HH PADS ON REAR UNLESS ALSO USED ON FRONT TO AVOID BRAKE IMBALANCE

Part numbers, prefixes, suffixes, photos and illustrations shown in this catalogue are trademarks and/or copyrights of EBC Brakes or the trademark owner A C Freeman Investments Ltd and use without express written permission of the owners is punishable by law.

All names & numbers are for reference purposes only. © Registered trademarks of Harley—Davidson® Motor Corp or Buell.

Recommended Fittings: FA400 for use on polished chrome show rotors. FA400HH recommended fitting as replacement for OE.

NOTE: — Some models may have a second rotor fitted as an optional extra. Please double check with your customer exactly which side the front rotor is fitted and if twin rotor or single.

**BRAKE
APPLICATIONS**

FRONT: AMERICAN PRODUCED MOTORCYCLES

* This symbol indicates a rotor made of billet steel, and should be only used with EBC FA Kevlar® Organic or Vee pads.

POLARIS (ATV)	SUFFIX OR PREFIX PAD MATERIALS AND DESCRIPTION	YEAR	FRONT				FRONT ROTOR OPTIONS DESIGN NO. <small>See Buyers Guide for rotor style & finish options. Part nos for ordering & sizing.</small>	Line #
			PADS	PADS	PADS	PADS		
			FA Kevlar Organic Pads	V Semi-Sintered V-Pads™	HH/R Double-H™ USA-Made Sintered Pads	EPFA Premium Low Noise Street Sintered Pads		
Sportsman 850 XP EPS	09-13	FA475X*		FA475R*		MD6339D*	1	
Sportsman 850 XP H.O. EPS	13-15	FA475X*		FA475R*		MD6339D*	2	
Forest 1000	15	FA475X*		FA475R*		MD6339D*	3	
Scrambler 1000	15	FA475X*		FA475R*		MD6339D*	4	
Scrambler 1000 XP	15	FA475X*		FA475R*		MD6339D*	5	
Scrambler 1000 XP	15-21	FA475X*		FA475R*		MD6339D*	6	
Sportsman 1000 MD/XP	15-19	FA475X*		FA475R*		MD6339D*	7	
Sportsman 1000 XP-S 55"	20-21	FA475X*		FA475R*		MD6338D*	8	
Sportsman 1000 XP Tractor	16-21	FA475X*		FA475R*		MD6338D*	9	
Sportsman 1000 Touring XP	15-20	FA475X*		FA475R*		MD6339D*	10	
Sportsman 1000 MD/XP	16-21	FA475X*		FA475R*		MD6339D*	11	
Sportsman 1000 High Lifter	19	FA475X*		FA475R*		MD6339D*	12	
POLARIS ACE								
570 (R08) All models A17DAA57A5/A7	17-20			FA354R*		MD6202D*	15	
570 EFI EURO (R09) A17DAA57F5	17-20			FA354R*		MD6202D*	16	
POLARIS GENERAL (SIDE X SIDE)								
1000 General EPS (2 Seat)	16-20	FA452X*		SXR452HH*		MD6338D*	19	
1000 General EPS (2 Seat)	17-20	FA452X*		SXR452HH*		MD6408D*	20	
1000 General 4 EPS (4 Seat)	17-20	FA452X*		SXR452HH*		MD6338D*	21	
POLARIS RANGER (COMMERCIAL)								
Brutus HD HDPTO (R03)	13-17	FA452X*		SXR452HH*		MD6338D*	24	
POLARIS RANGER (SIDE X SIDE)								
325 Ranger ETX	15-16			FA354R*		MD6202D*	27	
400 Ranger (All Models)	10-14			FA354R*		MD6202D*	28	
499 Ranger (All Models)	17			FA354R*		MD6202D*	29	
SXS 500 Ranger (2 x 4/4 x 4)	06-07			FA354R*		MD6202D*	30	
SXS 500 Ranger (4 x 4 EFI)	06-07			FA354R*		MD6202D*	31	
SXS 500 Ranger (4 x 4 EFI)	08-10	FA452X*		SXR452HH*		MD6202D*	32	
SXS 500 Ranger (4 x 4 EFI)	11-13			FA354R		MD6202D*	33	
SXS 500 Ranger (Carb) 2 x 4	08-09	FA452X*		SXR452HH*		MD6202D*	34	
SXS 500 Ranger (EFI) 4 x 4 H.O.	09-11	FA452X*		SXR452HH*		MD6338D*	35	
SXS 500 Ranger Crew	11-13	FA452X*		SXR452HH*		MD6202D*	36	
SXS 500 Ranger Series 10 6 x 6						MD6202D*	37	
SXS 500 Ranger 500 2WDHDPE ETX	17-20					MD6202D*	38	
SXS 500 Ranger 500 R21MAA50BJ7	21-22					MD6202D*	39	
Ranger 99 models	99	FA159X*		SXR159HH*		MD6149D*	40	
Ranger Series 10						MD6202D*	41	
Ranger 2 x 4 / 4 x 4	04-05					MD6202D*	42	
Ranger Series 11						MD6202D*	43	
Ranger 6 x 6	04-05					MD6202D*	44	
Ranger TM	04-05					MD6202D*	45	
Ranger TM	06					MD6202D*	46	
Ranger XP	05					MD6202D*	47	
570 Ranger EFI	14-20					MD6202D*	48	
570 Ranger Crew EFI	14-15	FA656X*		SXR656HH*		MD6202D*	49	
SXS Ranger 570 R16MA57A1/4/A9/L1	16					MD6202D*	50	
Ranger 570, (R12)	17-20					MD6202D*	51	
Ranger 570 R18RCA57A1/A4/B4/B1 FULL SIZE (R06)	18-20					MD6202D*	52	
Ranger 570 R19RCA57A1/A4/B1/B4 Full Size (R03)	19-20			FA354R*		MD6202D*	53	
SXS Ranger 570 Full Size R21CCA57A1/A7	21-22	FA656X*		SXR656HH*		MD6202D*	54	
Ranger Crew 570FS R17RDA57A1/B1 (R08)	17-20	FA656X*		SXR656HH*		MD6202D*	55	
Ranger Crew 570 FS R18RDA57A1/B1 (R05)	16-20	FA656X*		SXR656HH*		MD6202D*	56	
Ranger Crew 570 FS R19RDA57A1/B1 (R03)	19-20	FA656X*		SXR656HH*		MD6202D*	57	
RGR 570 EPS Crew MD R18RNE57NV (R04)	18-20	FA656X*		SXR656HH*		MD6202D*	58	
RGR 570 EFI Crew R17RNA57A1/A9/EAM/ENM R10)	17-20	FA656X*		SXR656HH*		MD6202D*	59	

*-2 Sets Required. ■ - Also available in MX-S race compound. **SAFETY WARNING:- DO NOT USE HH PADS ON REAR UNLESS ALSO USED ON FRONT TO AVOID BRAKE IMBALANCE**

REAR: AMERICAN PRODUCED MOTORCYCLES

Line #	POLARIS (ATV)	SUFFIX OR PREFIX PAD MATERIALS AND DESCRIPTION	YEAR	FRONT				
				PADS	PADS	PADS	PADS	FRONT ROTOR OPTIONS
				FA Kevlar Organic Pads	V Semi-Sintered V-Pads™	HH/R Double-H™ USA-Made Sintered Pads	EPFA Premium Low Noise Street Sintered Pads	DESIGN NO. See Buyers Guide for rotor style & finish options. Part nos for ordering & sizing.
1	Sportsman 850 XP EPS	09-13	FA475X		FA475R		MD6339D	
2	Sportsman 850 XP H.O. EPS	13-15	FA475X		FA475R		MD6339D	
3	Forest 1000	15	FA475X		FA475R		MD6339D	
4	Scrambler 1000	15	FA475X		FA475R		MD6339D	
5	Scrambler 1000 XP	15	FA475X		FA475R		MD6339D	
6	Scrambler 1000 XP	15-21	FA456X		FA456R		MD6339D	
7	Sportsman 1000 MD/XP	15-19	FA475X		FA475R		MD6339D	
8	Sportsman 1000 XP-S 55"	20-21	FA456X		FA456R		MD6338D	
9	Sportsman 1000 XP Tractor	16-21	FA475X		FA475R		MD6338D	
10	Sportsman 1000 Touring XP	15-20	FA475X		FA475R		MD6339D	
11	Sportsman 1000 MD/XP	16-21	FA475X		FA475R		MD6339D	
12	Sportsman 1000 High Lifter	19	FA475X		FA475R		MD6339D	
13	POLARIS ACE							
15	570 (R08) All models A17DAA57A5/A7	17-20			FA354R		MD6201D	
16	570 EFI EURO (R09) A17DAA57F5	17-20			FA354R		MD6201D	
17	POLARIS GENERAL (SIDE X SIDE)							
19	1000 General EPS (2 Seat)	16-20	FA456X		FA456R		MD6338D	
20	1000 General EPS (2 Seat)	17-20	FA456X		FA456R		MD6408D	
21	1000 General 4 EPS (4 Seat)	17-20	FA456X		FA456R		MD6408D	
22	POLARIS RANGER (COMMERCIAL)							
24	Brutus HD HDPTO (R03)	13-17	FA354R				MD6275D	
25	POLARIS RANGER (SIDE X SIDE)							
27	325 Ranger ETX	15-16	N/A		FA354R		MD6275D	
28	400 Ranger (All Models)	10-14	N/A		FA354R		MD6275D	
29	499 Ranger (All Models)	17	N/A		FA354R		MD6201D	
30	SXS 500 Ranger (2 x 4/4 x 4)	06-07	N/A		FA354R		MD6275D	
31	SXS 500 Ranger (4 x 4 EFI)	06-07	N/A		FA354R		MD6275D	
32	SXS 500 Ranger (4 x 4 EFI)	08-10	N/A		FA354R		MD6275D	
33	SXS 500 Ranger (4 x 4 EFI)	11-13	N/A		FA354R		MD6275D	
34	SXS 500 Ranger (Carb) 2 x 4	08-09	N/A		FA354R		MD6275D	
35	SXS 500 Ranger (EFI) 4 x 4 H.O.	09-11	N/A		FA354R		MD6275D	
36	SXS 500 Ranger Crew	11-13	N/A		FA354R		MD6275D	
37	SXS 500 Ranger Series 10 6 x 6		N/A		FA354R		MD6201D	
38	SXS 500 Ranger 500 2WDHDPE ETX	17-20	N/A		FA354R		MD6201D	
39	SXS 500 Ranger 500 R21MAA50BJ7	21-22	N/A		FA354R		MD6201D	
40	Ranger 99 models	99	N/A		FA273R		N/A	
41	Ranger Series 10		N/A		FA354R		MD6201D	
42	Ranger 2 x 4 / 4 x 4	04-05	N/A		FA354R		MD6201D	
43	Ranger Series 11		N/A		FA354R		MD6201D	
44	Ranger 6 x 6	04-05	N/A		FA354R		MD6201D	
45	Ranger TM	04-05	N/A		FA354R		MD6201D	
46	Ranger TM	06	N/A		FA354R		MD6275D	
47	Ranger XP	05	N/A		FA354R		MD6201D	
48	570 Ranger EFI	14-20			FA354R		MD6275D	
49	570 Ranger Crew EFI	14-15			FA354R		MD6275D	
50	SXS Ranger 570 R16MA57A1/4/A9/L1	16			FA354R		MD6275D	
51	Ranger 570, (R12)	17-20			FA354R		MD6275D	
52	Ranger 570 R18RCA57A1/A4/B4/B1 FULL SIZE (R06)	18-20			FA354R		MD6275D	
53	Ranger 570 R19RCA57A1/A4/B1/B4 Full Size (R03)	19-20			FA354R		MD6275D	
54	SXS Ranger 570 Full Size R21CCA57A1/A7	21-22	FA656X		FA656R		MD6275D	
55	Ranger Crew 570FS R17RDA57A1/B1 (R08)	17-20	FA656X		FA656R		MD6275D	
56	Ranger Crew 570 FS R18RDA57A1/B1 (R05)	16-20	FA656X		FA656R		MD6275D	
57	Ranger Crew 570 FS R19RDA57A1/B1 (R03)	19-20	FA656X		FA656R		MD6275D	
58	RGR 570 EPS Crew MD R18RNE57NV (R04)	18-20	FA656X		FA656R		MD6275D	
59	RGR 570 EFI Crew R17RNA57A1/A9/EAM/ENM R10)	17-20	FA656X		FA656R		MD6275D	

All names & numbers are for reference purposes only. © Registered trademarks of Harley—Davidson® Motor Corp or Buell.

Recommended Fittings: FA400 for use on polished chrome show rotors. FA400HH recommended fitting as replacement for OE.

NOTE: — Some models may have a second rotor fitted as an optional extra. Please double check with your customer exactly which side the front rotor is fitted and if twin rotor or single.

**BRAKE
APPLICATIONS**

*-2 Sets Required. ■ - Also available in MX-S race compound. **SAFETY WARNING:- DO NOT USE HH PADS ON REAR UNLESS ALSO USED ON FRONT TO AVOID BRAKE IMBALANCE**

FRONT: AMERICAN PRODUCED MOTORCYCLES

APPLICATIONS

BRAKE

⚡ This symbol indicates a rotor made of billet steel, and should be only used with EBC FA Kevlar® Organic or Vee pads.

SUFFIX OR PREFIX PAD MATERIALS AND DESCRIPTION	YEAR	FRONT				FRONT ROTOR OPTIONS	Line #
		PADS	PADS	PADS	PADS	DESIGN NO.	
		FA	V	HH/R	EPFA	See Buyers Guide for rotor style & finish options. Part nos for ordering & sizing.	
POLARIS RANGER (SIDE X SIDE)							
RGR 570 Crew R18RNA57B1/B9/EBV (R03)	18-20	FA656X*		SXR656HH*		MD6202D*	1
RGR 570 Crew R19RNA57B1/B9/EBX (R02)	16-20	FA656X*		SXR656HH*		MD6202D*	2
700 Ranger 6 x 6 EFI	06-09					MD6202D*	3
700 Ranger XP 4 x 4	06					MD6202D*	4
700 Ranger 4 x 4 EFI/LE	07					MD6202D*	5
700 Ranger 4 x 4 EFI	09	FA452X*		SXR452HH*		MD6338D*	6
700 Ranger Crew (EFI) 4 x 4	09	FA452X*		SXR452HH*		MD6202D*	7
700 Ranger 6 x 4 EFI	08	FA452X*		SXR452HH*		MD6202D*	8
700 Ranger XP 4 x 4	08	FA452X*		SXR452HH*		MD6202D*	9
Ranger EV (Electric)	10-15	FA452X*		SXR452HH*		MD6202D*	10
Ranger EV MD R18RMAE4N8 (R02)	18-19	FA656X*		SXR656HH*		MD6202D*	11
Ranger EV LIION R17RMAL4G9 (R08)	16-18	FA656X*		SXR656HH*		MD6202D*	12
Ranger EV LIION R18RMAL4G9 (R03)	16-18	FA656X*		SXR656HH*		MD6202D*	13
Ranger EV R17RMAE4G8/G9/N8/MAE4H8 (R12)	16-17	FA656X*		SXR656HH*		MD6202D*	14
Ranger EV R18RMAE4G8/G9 (R03)	16-18	FA656X*		SXR656HH*		MD6202D*	15
800 Ranger	10-12	FA452X*		SXR452HH*		MD6338D*	16
800 Ranger EFI	13-14	FA452X*		SXR452HH*		MD6338D*	17
800 Ranger Mid Size	13-14					MD6202D*	18
800 Ranger XP	10-12	FA452X*		SXR452HH*		MD6338D*	19
800 Ranger 6 x 6	10-17	FA452X*		SXR452HH*		MD6338D*	20
800 Ranger Crew	10-14	FA452X*		SXR452HH*		MD6338D*	21
RGR 800 6X6 R17RAA76NA MD Poland (R02)	17-20	FA656X*		SXR656HH*		MD6202D*	22
900 Ranger Crew	10-15	FA656X*		SXR656HH*		MD6338D*	23
900 D Crew Ranger Diesel	13-14	FA452X*		SXR452HH*		MD6338D*	24
900 D Ranger Diesel	11-14	FA452X*		SXR452HH*		MD6338D*	25
900 (Ranger XP 900)	13-14	FA452X*		SXR452HH*		MD6338D*	26
900 Ranger XP 900 (R27)	15-19	FA452X*		SXR452HH*		MD6338D*	27
900 R18RVA87A1/B1/E87A9/B9	16-19	FA452X*		SXR452HH*		MD6338D*	28
Ranger Crew 900XP 6P SP R18RVA87A1/B1/E87A9/B9 (R10)	18	FA656X*		SXR656HH*		MD6338D*	29
Ranger Crew 900 EPS R19RVA87A1/B1/EA9/AH/B9/BH (R03)	19	FA656X*		SXR656HH*		MD6338D*	30
Ranger Crew 900 6P SP R17RVA87A1/B1/E87A9/B9 (R14)	17	FA656X*		SXR656HH*		MD6338D*	31
Ranger 902D EU Tractor R07	19-20	FA656X*		SXR656HH*		MD6380D*	32
1000 Ranger Diesel	15-20	FA656X*		SXR656HH*		MD6338D*	33
1000 Ranger Diesel Crew	15	FA452X*		SXR452HH*		MD6338D*	34
Ranger Crew 1000XP PS MD R18RVE99NX (R08)	18	FA656X*		SXR656HH*		MD6338D*	35
Ranger Crew 1000XP PS R17RV_99 ALL OPTIONS (R32)	17	FA656X*		SXR656HH*		MD6338D*	36
Ranger Crew 000XP PS R18RV_99 ALL OPTIONS (R09)	18	FA656X*		SXR656HH*		MD6338D*	37
Ranger Crew 1000XP 6P,PS,NB,MD (R08) R17RVE99NY	17	FA656X*		SXR656HH*		MD6338D*	38
Ranger Crew 1000 PS R18RVU99AS (R10)	18-20	FA656X*		SXR656HH*		MD6338D*	39
Ranger 1000 Diesel Poland R18RTED1F1/SD1C1 (R07)	17-18	FA656X*		SXR656HH*		MD6338D*	40
Ranger 1000 Diesel EU R17RTED1F1/SD1C1 (R14)	17	FA656X*		SXR656HH*		MD6338D*	41
Ranger 1000 Diesel Crew R17RVAD1A1 (R16)	17-18	FA656X*		SXR656HH*		MD6338D*	42
Ranger Crew 1000 49/50S Factory choice (,R04, R06 R08, R11,)	18-20	FA656X*		SXR656HH*		MD6338D*	43
Ranger 1000XP PS Crew Inc EU,EPS, HD,MD (R03, R09,R13, R20)	18-20	FA656X*		SXR656HH*		MD6338D*	44
Ranger 1000XP PS NSTR, Crew Mud (R02,R15,R17,R18)	18-20	FA656X*		SXR656HH*		MD6338D*	45
Ranger 1000 Diesel R17RTAD1A1/ED1N1 (R17)	17	FA656X*		SXR656HH*		MD6338D*	46
Ranger 1000 Diesel R18RTAD1B1/ED1N1 (R13)	18	FA656X*		SXR656HH*		MD6338D*	47
PPS/PTV 4 x 4/ Series 10		FA159X*		SXR159HH*		MD6202D*	48
PPS/PTV 6 x 6/ Series 10		FA159X*		SXR159HH*		MD6149D*	49
PPS/UTV 2 x 4 Series 10				FA354R*		MD6202D*	50
PPS/UTV 4 x 6 Series 10				FA354R*		MD6202D*	51
PPS/UTV 1500 2 x 4 Series 11				FA354R*		MD6202D*	52
PPS LUH 6 x 6	02	FA159X*		SXR159HH*		MD6149D*	53
PPS/ Series 11 2 x 4/4 x 4				FA354R*		MD6202D*	54
PPS/ Series 11 6 x 6				FA354R*		MD6202D*	55
Ranger (Various Models 05-16) Handbrake Pads	05-16						56
							57
							58
							59

*-2 Sets Required. ■ - Also available in MX-S race compound. **SAFETY WARNING:- DO NOT USE HH PADS ON REAR UNLESS ALSO USED ON FRONT TO AVOID BRAKE IMBALANCE**

REAR: AMERICAN PRODUCED MOTORCYCLES

Line #	POLARIS RANGER (SIDE X SIDE)	SUFFIX OR PREFIX PAD MATERIALS AND DESCRIPTION	YEAR	FRONT				
				PADS	PADS	PADS	PADS	FRONT ROTOR OPTIONS
				FA Kevlar Organic Pads	V Semi-Sintered V-Pads™	HH/R Double-H™ USA-Made Sintered Pads	EPFA Premium Low Noise Street Sintered Pads	DESIGN NO. <small>See Buyers Guide for rotor style & finish options. Part nos for ordering & sizing.</small>
1	RGR 570 Crew R18RNA57B1/B9/EBV (R03)	18-20	FA656X		FA656R		MD6275D	
2	RGR 570 Crew R19RNA57B1/B9/EBX (R02)	16-20	FA656X		FA656R		MD6275D	
3	700 Ranger 6 x 6 EFI	06-09	N/A		FA354R		MD6275D	
4	700 Ranger XP 4 x 4	06	N/A		FA354R		MD6275D	
5	700 Ranger 4 x 4 EFI/LE	07	N/A		FA354R		MD6275D	
6	700 Ranger 4 x 4 EFI	09	N/A		FA354R		MD6275D	
7	700 Ranger Crew (EFI) 4 x 4	09	FA452X		FA452R		MD6275D	
8	700 Ranger 6 x 4 EFI	08	N/A		FA354R		MD6275D	
9	700 Ranger XP 4 x 4	08	N/A		FA354R		MD6275D	
10	700 Ranger XP 4 x 4	08	N/A		FA354R		MD6275D	
11	Ranger EV (Electric)	10-15	FA656X		FA656R			
12	Ranger EV MD R18RMAE4N8 (R02)	18-19	FA656X		FA656R			
13	Ranger EV LIION R17RMAL4G9 (R08)	16-18	FA656X		FA656R			
14	Ranger EV R17RMAE4G8/G9/N8/MAE4H8 (R12)	16-17	FA656X		FA656R			
15	Ranger EV R18RMAE4G8/G9 (R03)	16-18	FA656X		FA656R			
16	800 Ranger	10-12	N/A		FA354R		MD6275D	
17	800 Ranger EFI	13-14	N/A		FA354R		MD6275D	
18	800 Ranger Mid Size	13-14	N/A		FA354R		MD6275D	
19	800 Ranger XP	10-12	FA452X		FA452R		MD6275D	
20	800 Ranger 6 x 6	10-17	FA452X		FA452R		MD6275D	
21	800 Ranger Crew	10-14			FA354R		MD6275D	
22	RGR 800 6X6 R17RAA76NA MD Poland (R02)	17-20						
23	900 Ranger Crew	10-15	FA452X		FA452R		MD6275D	
24	900 D Crew Ranger Diesel	13-14	FA452X		FA452R		MD6275D	
25	900 D Ranger Diesel	11-14	N/A		FA354R		MD6275D	
26	900 (Ranger XP 900)	13-14	N/A		FA354R		MD6374D	
27	900 Ranger XP 900 (R27)	15-19			FA354R		MD6275D	
28	900 R18RVA87A1/B1/E87A9/B9	16-19	FA452X		FA452R		MD6275D	
29	Ranger Crew 900XP 6P SP R18RVA87A1/B1/E87A9/B9 (R10)	18						
30	Ranger Crew 900 EPS R19RVA87A1/B1/EA9/AH/B9/BH (R03)	19						
31	Ranger Crew 900 6P SP R17RVA87A1/B1/E87A9/B9 (R14)	17						
32	Ranger 902D EU Tractor R07	19-20	FA456X		FA456R		MD6338D	
33	1000 Ranger Diesel	15-20	N/A		FA354R		MD6275D	
34	1000 Ranger Diesel Crew	15			FA354R		MD6275D	
35	Ranger Crew 1000XP PS MD R18RVE99NX (R08)	18	FA452X		FA452R		MD6275D	
36	Ranger Crew 1000XP PS R17RV_99 ALL OPTIONS (R32)	17	FA452X		FA452R		MD6275D	
37	Ranger Crew 000XP PS R18RV_99 ALL OPTIONS (R09)	18	FA452X		FA452R		MD6275D	
38	Ranger Crew 1000XP 6P,PS,NB,MD (R08) R17RVE99NY	17	FA452X		FA452R		MD6275D	
39	Ranger Crew 1000 PS R18RVU99AS (R10)	18-20	FA452X		FA452R		MD6275D	
40	Ranger 1000 Diesel Poland R18RTED1F1/SD1C1 (R07)	17-18	FA452X		FA452R		MD6275D	
41	Ranger 1000 Diesel EU R17RTED1F1/SD1C1 (R14)	17	FA656X				MD6275D	
42	Ranger 1000 Diesel Crew R17RVAD1A1 (R16)	17-18	FA656X				MD6275D	
43	Ranger Crew 1000 49/50S Factory choice (,R04, R06 R08, R11,)	18-20			FA456R		MD6275D	
44	Ranger 1000XP PS Crew Inc EU,EPS, HD,MD (R03, R09,R13, R20)	18-20	FA456X		FA456R		MD6275D	
45	Ranger 1000XP PS NSTR, Crew Mud (R02,R15,R17,R18)	18-20	FA456X		FA456R		MD6275D	
46	Ranger 1000 Diesel R17RTAD1A1/ED1N1 (R17)	17	FA656X				MD6275D	
47	Ranger 1000 Diesel R18RTAD1B1/ED1N1 (R13)	18	FA656X				MD6275D	
48	PPS/PTV 4 x 4/Series 10		N/A		FA314R		MD6200D	
49	PPS/PTV 6 x 6/Series 10		N/A		FA313R		MD6200D	
50	PPS/UTV 2 x 4 Series 10		N/A		FA354R		MD6201D	
51	PPS/UTV 4 x 6 Series 10		N/A		FA354R		MD6201D	
52	PPS/UTV 1500 2 x 4 Series 11		N/A		FA354R		MD6201D	
53	PPS LUH 6 x 6	02	N/A		FA313R		MD6170D	
54	PPS/Series 11 2 x 4/4 x 4		N/A		FA354R		MD6201D	
55	PPS/Series 11 6 x 6		N/A		FA354R		MD6201D	
56	Ranger (Various Models 05-16) Handbrake Pads	05-16	FA659X		FA659R			
57								
58								
59								

All names & numbers are for reference purposes only. © Registered trademarks of Harley—Davidson® Motor Corp or Buell.

Recommended Fittings: FA400 for use on polished chrome show rotors. FA400HH recommended fitting as replacement for OE.

NOTE: — Some models may have a second rotor fitted as an optional extra. Please double check with your customer exactly which side the front rotor is fitted and if twin rotor or single.

**BRAKE
APPLICATIONS**

*-2 Sets Required. ■ - Also available in MX-S race compound. **SAFETY WARNING:- DO NOT USE HH PADS ON REAR UNLESS ALSO USED ON FRONT TO AVOID BRAKE IMBALANCE**

Part numbers, prefixes, suffixes, photos and illustrations shown in this catalogue are trademarks and/or copyrights of EBC Brakes or the trademark owner A C Freeman Investments Ltd and use without express written permission of the owners is punishable by law.

FRONT: AMERICAN PRODUCED MOTORCYCLES

APPLICATIONS

BRAKE

⊛ This symbol indicates a rotor made of billet steel, and should be only used with EBC FA Kevlar® Organic or Vee pads.

		FRONT					Line #
		PADS	PADS	PADS	PADS	FRONT ROTOR OPTIONS	
		FA	V	HH/R	EPFA	DESIGN NO.	
SUFFIX OR PREFIX PAD MATERIALS AND DESCRIPTION		Kevlar Organic Pads	Semi-Sintered V-Pads™	Double-H™ USA-Made Sintered Pads	Premium Low Noise Street Sintered Pads	See Buyers Guide for rotor style & finish options. Part nos for ordering & sizing.	
POLARIS RZR (SIDE X SIDE)							
YEAR							
Military RZR2 XP MV 1000 Turbo Diesel (R01) M17VDED1MA/EX	17	FA656X*		SXR656HH*			1
Military RZR2 XP MV 1000 Turbo Diesel NELO (R01) M18VDED1MN	18	FA656X*		SXR656HH*			2
Military RZR4 XP MV 1000 Turbo Diesel (R04) M17VFD1MA/EX	17	FA656X*		SXR656HH*			3
RZR 170	09-15			FA490R*		MD6353D*	4
RZR 570	12-13	FA456X*		SXR456HH*		MD6312D*	5
RZR 570	14-19	FA456X*		SXR456HH*		MD6338D*	6
RZR 570	20-21	FA456X*		SXR456HH*		MD6338D*	7
RZR 800 (Inc EPS Models)	08-14	FA456X*		SXR456HH*		MD6312D*	8
RZR-4 800 EPS	12	FA452X*		SXR452HH*		MD6338D*	9
RZR 900 (50" Inch All Options)	15-20	FA657X*		SXR657HH*		MD6338D*	10
RZR-S 900 (60" Inch All Options)	15-20	FA657X*		SXR657HH*		MD6338D*	11
RZR 900 XP (Inc EPS Models)	11-14	FA656X*		SXR656HH*		MD6338D*	12
RZR 900 4 XP All Options Inc Military	12-16	FA656X*		SXR656HH*		MD6338D*	13
RZR 4 900 Z17VCE87AB/AK/AM (R05)	17	FA656X*		SXR656HH*		MD6338D*	14
RZR 4 900 Z18VCE87BK/BU/BR/LU (R05 R12)	16-18	FA656X*		SXR656HH*		MD6338D*	15
RZR 1000 60 Inch PS EU/Tractor/Zug (R01,R06,R07,R09) (60" Inch All Options)	17-20	FA657X*		SXR657HH*		MD6338D*	16
RZR 1000 XP	16-17	FA452X*		SXR452HH*		MD6380D*	17
RZR 1000 XP	12-19	FA656X*		SXR656HH*		MD6380D*	18
RZR 1000 Z19VCE99AM	18-20	FA656X*		SXR656HH*		MD6380D*	19
RZR XP Turbo	16			SXR680HH*		MD6397D*	20
RZR XP 4 Turbo	16			SXR680HH*		MD6397D*	21
RZR RS1 RS1	18-20	FA656X*		SXR656HH*		MD6380D*	22
RZR Turbo 4 Turbo 4	19-20	FA680X*		SXR680HH*		MD6397D*	23
RZR 1000 XP 4	19-20	FA656X*		SXR656HH*		MD6380D*	24
RZR 1000 XP 4	18	FA656X*		SXR656HH*		MD6380D*	25
RZR 1000 XP 4	16-17	FA656X*		SXR656HH*		MD6380D*	26
RZR 1000 XP 4 MD	17	FA656X*		SXR656HH*		MD6380D*	27
RZR 1000 XP 4 MD	18-19	FA656X*		SXR656HH*		MD6380D*	28
RZR Pro XP Turbo (Z20A_92 & Z21RAC)	20-21	FA680X*		SXR680HH*		MD6380D*	29
RZR XP Turbo	17-20	FA680X*		SXR680HH*		MD6380D*	30
RZR XP Turbo Latin	18	FA680X*		SXR680HH*		MD6380D*	31
RZR XP Turbo MD	17-18	FA680X*		SXR680HH*		MD6380D*	32
RZR XP Turbo S	18-20	FA680X*		SXR680HH*		MD6380D*	33
RZR XP Turbo Tractor	17-18	FA680X*		SXR680HH*		MD6380D*	34
RZR XP4 Turbo	17-20	FA680X*		SXR680HH*		MD6380D*	35
RZR XP4 Turbo Intl	17	FA680X*		SXR680HH*		MD6380D*	36
RZR XP4 Turbo MD	18-20	FA680X*		SXR680HH*		MD6380D*	37
RZR XP4 Turbo S	19-20			SXR728HH*		MD6380D*	38
RZR XP Turbo S Velocity	19-20			SXR728HH*		MD6380D*	39
							40
							41
Slingshot Base (Front pads sold as an axle set of 4 pads)	15-17					MD533*	42
Slingshot S (Front pads sold as an axle set of 4 pads)	18					MD533*	43
Slingshot SL (Front pads sold as an axle set of 4 pads)	15-18					MD533*	44
Slingshot SL LE (Front pads sold as an axle set of 4 pads)	15-18					MD533*	45
Slingshot SLR (Front pads sold as an axle set of 4 pads)	17-18						46
							47
							48
							49
							50
							51
							52
							53
							54
							55
							56
							57
							58
							59

*-2 Sets Required. ■ - Also available in MX-S race compound. **SAFETY WARNING:- DO NOT USE HH PADS ON REAR UNLESS ALSO USED ON FRONT TO AVOID BRAKE IMBALANCE**

REAR: AMERICAN PRODUCED MOTORCYCLES

Line #	SUFFIX OR PREFIX PAD MATERIALS AND DESCRIPTION	YEAR	FRONT				
			PADS	PADS	PADS	PADS	FRONT ROTOR OPTIONS
			FA Kevlar Organic Pads	V Semi-Sintered V-Pads™	HH/R Double-H™ USA-Made Sintered Pads	EPFA Premium Low Noise Street Sintered Pads	DESIGN NO. See Buyers Guide for rotor style & finish options. Part nos for ordering & sizing.
POLARIS RZR (SIDE X SIDE)							
1	Military RZR2 XP MV 1000 Turbo Diesel (R01) M17VDED1MA/EX	17	FA656X		FA656R		
2	Military RZR2 XP MV 1000 Turbo Diesel NELO (R01) M18VDED1MN	18	FA656X		FA656R		
3	Military RZR4 XP MV 1000 Turbo Diesel (R04) M17VFED1MA/EX	17	FA656X		FA656R		
4	RZR 170	09-15	N/A		FA489R		MD6344D
5	RZR 570	12-13	FA159X		FA159R		MD6275D
6	RZR 570	14-19	FA456X		FA456R		MD6275D
7	RZR 570	20-21	FA475X		FA475R		MD6275D
8	RZR 800 (Inc EPS Models)	08-14	FA159X		FA159R		MD6275D
9	RZR-4 800 EPS	12	N/A		FA354R		MD6275D
10	RZR 900 (50" Inch All Options)	15-20	FA456X		FA456R		MD6338D
11	RZR-S 900 (60" Inch All Options)	15-20	FA456X		FA456R		MD6338D
12	RZR 900 XP (Inc EPS Models)	11-14			FA354R		MD6374D
13	RZR 900 4 XP All Options Inc Military	12-16	FA656X		FA656R		MD6374D
14	RZR 4 900 Z17VCE87AB/AK/AM (R05)	17	FA656X		FA656R		MD6374D
15	RZR 4 900 Z18VCE87BK/BU/BR/LU (R05 R12)	16-18	FA456X		FA456R		
16	RZR 1000 60 Inch PS EU/Tractor/Zug (R01,R06,R07,R09) (60" Inch All Options)	17-20	FA456X		FA456R		MD6338D
17	RZR 1000 XP	16-17	FA452X		FA452R		MD6380D
18	RZR 1000 XP	12-19	FA656X		FA656R		MD6380D
19	RZR 1000 Z19VCE99AM	18-20	FA456X		FA456R		MD6338D
20	RZR XP Turbo	16	FA656X		FA656R		MD6397D
21	RZR XP 4 Turbo	16	FA656X		FA656R		MD6397D
22	RZR RS1 RS1	18-20	FA656X		FA656R		MD6380D
23	RZR Turbo 4 Turbo 4	19-20	FA656X		FA656R		MD6397D
24	RZR 1000 XP 4	19-20	FA656X		FA656R		MD6380D
25	RZR 1000 XP 4	18	FA656X		FA656R		MD6380D
26	RZR 1000 XP 4	16-17	FA656X		FA656R		MD6380D
27	RZR 1000 XP 4 MD	17	FA656X		FA656R		MD6380D
28	RZR 1000 XP 4 MD	18-19	FA656X		FA656R		MD6380D
29	RZR Pro XP Turbo (Z20A_92 & Z21RAC)	20-21	FA656X		FA656R		MD6397D
30	RZR XP Turbo	17-20	FA656X		FA656R		MD6397D
31	RZR XP Turbo Latin	18	FA656X		FA656R		MD6397D
32	RZR XP Turbo MD	17-18	FA656X		FA656R		MD6397D
33	RZR XP Turbo S	18-20	FA656X		FA656R		MD6397D
34	RZR XP Turbo Tractor	17-18	FA656X		FA656R		MD6397D
35	RZR XP4 Turbo	17-20	FA656X		FA656R		MD6397D
36	RZR XP4 Turbo Intl	17	FA656X		FA656R		MD6397D
37	RZR XP4 Turbo MD	18-20	FA656X		FA656R		MD6397D
38	RZR XP4 Turbo S	19-20	FA656X		FA656R		MD6397D
39	RZR XP Turbo S Velocity	19-20					MD6397D
40	POLARIS (SLINGSHOT)						
41							
42	Slingshot Base (Front pads sold as an axle set of 4 pads)	15-17	FA670				MD533
43	Slingshot S (Front pads sold as an axle set of 4 pads)	18					MD533
44	Slingshot SL (Front pads sold as an axle set of 4 pads)	15-18	FA670				MD533
45	Slingshot SL LE (Front pads sold as an axle set of 4 pads)	15-18					MD533
46	Slingshot SLR (Front pads sold as an axle set of 4 pads)	17-18	TBA				TBA
47							
48							
49							
50							
51							
52							
53							
54							
55							
56							
57							
58							
59							

All names & numbers are for reference purposes only. © Registered trademarks of Harley—Davidson® Motor Corp or Buell.

Recommended Fittings: FA400 for use on polished chrome show rotors. FA400HH recommended fitting as replacement for OE.

NOTE: — Some models may have a second rotor fitted as an optional extra. Please double check with your customer exactly which side the front rotor is fitted and if twin rotor or single.

**BRAKE
APPLICATIONS**

FRONT: AMERICAN PRODUCED MOTORCYCLES

⊛ This symbol indicates a rotor made of billet steel, and should be only used with EBC FA Kevlar® Organic or Vee pads.

VICTORY	SUFFIX OR PREFIX PAD MATERIALS AND DESCRIPTION	YEAR	FRONT				FRONT ROTOR OPTIONS	Line #
			PADS	PADS	PADS	PADS	DESIGN NO.	
			FA Kevlar Organic Pads	V Semi-Sintered V-Pads™	HH/R Double-H™ USA-Made Sintered Pads	EPFA Premium Low Noise Street Sintered Pads	See Buyers Guide for rotor style & finish options. Part nos for ordering & sizing.	
V92C Standard Cruiser	98-00	FA244	FA244V	FA244HH		MD727*	1	
V92C Standard Cruiser	01-02	FA244	FA244V	FA244HH			2	
V92DH Deluxe Cruiser	01-02	FA244	FA244V	FA244HH			3	
V92SC Sport Cruiser	00	FA244*	FA244V*	FA244HH		MD727*	4	
V92SC Sport Cruiser	01	FA244	FA244V	FA244HH			5	
V92SC Special Edition	00	FA244	FA244V	FA244HH			6	
V92TC Touring Cruiser	03-06	FA244*	FA244V*	FA244HH			7	
Broadwalk	13-15			FA347HH			8	
Cross Country	10-17			FA347HH			9	
Cross Country 8 Ball	15-16			FA347HH			10	
Cross Country Touring	13-17			FA347HH			11	
Cross Country Cory Ness Victory	11-12			FA347HH			12	
Cross Roads	10-12			FA347HH			13	
Cross Roads Classic	13-14			FA347HH			14	
Cross Roads 8 Ball	14-15			FA347HH			15	
Empulse TT	16	FA244*	FA244V*	FA244HH			16	
Gunner	15-17			FA347HH			17	
Hammer	05-07	FA244*	FA244V*	FA244HH		MD678*	18	
Hammer	08-11			FA347HH			19	
Hammer 8 Ball	10-15			FA347HH			20	
Hammer 8 Ball	16			FA347HH			21	
Hammer S	07	FA244*	FA244V*	FA244HH		MD678*	22	
Hammer S	08-17			FA347HH			23	
Hard Ball	12-13			FA347HH			24	
High Ball	12-17			FA347HH			25	
Jackpot	07-10			FA347HH		MD678	26	
Jackpot	11-16			FA347HH			27	
Jackpot Cory Ness	08-10			FA347HH			28	
Judge	13-17			FA347HH			29	
King Pin	04-07	FA244	FA244V	FA244HH		MD678	30	
King Pin	08-12			FA347HH			31	
King Pin Tour	04-07	FA244	FA244V	FA244HH		MD678	32	
King Pin Tour	08-09			FA347HH			33	
King Pin 8 Ball	08-11			FA347HH			34	
King Pin Low	09			FA347HH			35	
Magnum	15-17			FA347HH			36	
Magnum X-1	15-17			FA347HH			37	
Ness Signature Series	05-07	FA244	FA244V	FA244HH		MD678	38	
Octane 1200cc	17	FA209/2	FA209/2V	FA209/2HH		MD534	39	
Vegas	03-07	FA244	FA244V	FA244HH		MD678	40	
Vegas	08-12			FA347HH		MD678	41	
Vegas	16-17			FA347HH		MD678	42	
Vegas 8 Ball	05-07	FA244	FA244V	FA244HH		MD678	43	
Vegas 8 Ball	08-10			FA347HH		MD678	44	
Vegas 8 Ball	11-17			FA347HH		MD678	45	
Vegas Jackpot	06-07	FA244	FA244V	FA244HH		MD678	46	
Vegas Jackpot	08-12			FA347HH		MD678	47	
Vegas Jackpot	13-14			FA347HH			48	
Vegas Zach Ness	11			FA347HH		MD678	49	
Vegas Low	08-09			FA347HH		MD678	50	
Vision 8 Ball	10-11			FA0261HH			51	
Vision Street	08-09			FA0261HH			52	
Vision Tour all models	08-15			FA0261HH			53	
Arlen Ness Victory Vision	10-12			FA0261HH			54	
							55	
							56	
							57	
							58	
							59	

*-2 Sets Required. ■ - Also available in MX-S race compound. **SAFETY WARNING:- DO NOT USE HH PADS ON REAR UNLESS ALSO USED ON FRONT TO AVOID BRAKE IMBALANCE**

REAR: AMERICAN PRODUCED MOTORCYCLES

Line #	VICTORY	SUFFIX OR PREFIX PAD MATERIALS AND DESCRIPTION	YEAR	FRONT				
				PADS	PADS	PADS	PADS	FRONT ROTOR OPTIONS
				FA Kevlar Organic Pads	V Semi-Sintered V-Pads™	HH/R Double-H™ USA-Made Sintered Pads	EPFA Premium Low Noise Street Sintered Pads	DESIGN NO. <small>See Buyers Guide for rotor style & finish options. Part nos for ordering & sizing.</small>
1	V92C Standard Cruiser	98-00	FA209/2		FA209/2HH		MD727	
2	V92C Standard Cruiser	01-02	FA209/2		FA209/2HH			
3	V92DH Deluxe Cruiser	01-0	FA209/2		FA209/2HH			
4	V92SC Sport Cruiser	00	FA209/2		FA209/2HH		MD727	
5	V92SC Sport Cruiser	01	FA209/2		FA209/2HH			
6	V92SC Special Edition	00	FA209/2		FA209/2HH		MD727	
7	V92TC Touring Cruiser	03-06	FA209/2		FA209/2HH			
8	Broadwalk	13-15	FA196		FA196HH			
9	Cross Country	10-17	FA196		FA196HH			
10	Cross Country 8 Ball	15-16	FA196		FA196HH			
11	Cross Country Touring	13-17	FA196		FA196HH			
12	Cross Country Cory Ness Victory	11-12	FA196		FA196HH			
13	Cross Roads	10-12	FA196		FA196HH			
14	Cross Roads Classic	13-14	FA196		FA196HH			
15	Cross Roads 8 Ball	14-15	FA196		FA196HH			
16	Empulse TT	16	FA266		FA266HH			
17	Gunner	15-17	FA196		FA196HH			
18	Hammer	05-07	FA209/2		FA209/2HH		MD678	
19	Hammer	08-11	FA196		FA196HH			
20	Hammer 8 Ball	10-15	FA196		FA196HH			
21	Hammer 8 Ball	16	FA196		FA196HH			
22	Hammer S	07	FA209/2		FA209/2HH		MD678	
23	Hammer S	08-17	FA196		FA196HH			
24	Hard Ball	12-13	FA196		FA196HH			
25	High Ball	12-17	FA196		FA196HH			
26	Jackpot	07-10	FA196		FA196HH		MD678	
27	Jackpot	11-16	FA196		FA196HH			
28	Jackpot Cory Ness	08-10	FA196		FA196HH			
29	Judge	13-17	FA196		FA196HH			
30	King Pin	04-07	FA209/2		FA209/2HH		MD678	
31	King Pin	08-12	FA196		FA196HH			
32	King Pin Tour	04-07	FA209/2		FA209/2HH		MD678	
33	King Pin Tour	08-09	FA196		FA196HH			
34	King Pin 8 Ball	08-11	FA196		FA196HH			
35	King Pin Low	09	FA196		FA196HH			
36	Magnum	15-17	FA196		FA196HH			
37	Magnum X-1	15-17	FA196		FA196HH			
38	Ness Signature Series	05-07	FA209/2		FA209/2HH		MD678	
39	Octane 1200cc	17	FA213		FA213HH		MD534	
40	Vegas	03-07	FA209/2		FA209/2HH		MD678	
41	Vegas	08-12	FA196		FA196HH		MD678	
42	Vegas	16-17	FA196		FA196HH		MD678	
43	Vegas 8 Ball	05-07	FA209/2		FA209/2HH		MD678	
44	Vegas 8 Ball	08-10	FA196		FA196HH		MD678	
45	Vegas 8 Ball	11-17	FA196		FA196HH		MD678	
46	Vegas Jackpot	06-07	FA209/2		FA209/2HH		MD678	
47	Vegas Jackpot	13-14	FA196		FA196HH		MD678	
48	Vegas Jackpot	13-14	FA196		FA196HH		MD678	
49	Vegas Zach Ness	11	FA196		FA196HH		MD678	
50	Vegas Low	08-09	FA196		FA196HH		MD678	
51	Vision 8 Ball	10-11	FA196		FA196HH			
52	Vision Street	08-09	FA196		FA196HH			
53	Vision Tour all models	08-15	FA196		FA196HH			
54	Arlen Ness Victory Vision	10-12	FA196		FA196HH			
55								
56								
57								
58								
59								

All names & numbers are for reference purposes only. © Registered trademarks of Harley—Davidson® Motor Corp or Buell.

Recommended Fittings: FA400 for use on polished chrome show rotors. FA400HH recommended fitting as replacement for OE.

NOTE: — Some models may have a second rotor fitted as an optional extra. Please double check with your customer exactly which side the front rotor is fitted and if twin rotor or single.

**BRAKE
APPLICATIONS**

*-2 Sets Required. ■ - Also available in MX-S race compound. **SAFETY WARNING:- DO NOT** USE HH PADS ON REAR UNLESS ALSO USED ON FRONT TO AVOID BRAKE IMBALANCE

FRONT: AMERICAN PRODUCED MOTORCYCLES

* This symbol indicates a rotor made of billet steel, and should be only used with EBC FA Kevlar® Organic or Vee pads.

SUFFIX OR PREFIX PAD MATERIALS AND DESCRIPTION	YEAR	FRONT				FRONT ROTOR OPTIONS	Line #
		PADS	PADS	PADS	PADS	DESIGN NO.	
		FA Kevlar Organic Pads	V Semi-Sintered V-Pads™	HH/R Double-H™ USA-Made Sintered Pads	EPFA Premium Low Noise Street Sintered Pads	See Buyers Guide for rotor style & finish options. Part nos for ordering & sizing.	
ZERO							
DS ZF13.0 J.Juan Front & Rear Calipers	16-19	FA209/2		FA209/2HH			1
Zero DS ZF6.0/ZF9.0 2 Pin Fixing Front Pad	10-12	FA0264		FA0264HH			2
Zero DS ZF8.5/ZF11.4 Nissin Front & Rear Calipers	13	FA185X		FA185R			3
Zero DS ZF8.5/ZF11.4 Nissin Front/J.Juan Rear Calipers	14	FA185X		FA185R			4
Zero DS ZF9.4/ZF12.5 J.Juan Front & Rear Calipers	15	FA209/2		FA209/2HH			5
Zero DS II ZF14.4	19-21	FA209/2		FA209/2HH			6
Zero DS II ZF7.2	19-21	FA209/2		FA209/2HH			7
Zero DSR ZF13.0 J.Juan Front & Rear Calipers	17-19	FA209/2		FA209/2HH			8
Zero DSR ZF14.4.0	19-21	FA209/2		FA209/2HH			9
Zero DSR Black Forest	19-21	FA209/2		FA209/2HH			10
Zero FXZF2.8/ZF5.7 J.Juan Front & Rear Calipers	15	FA181X		FA181R			11
Zero FXZF2.8/ZF5.7 Nissin Front & Rear Calipers	13	FA185X		FA185R			12
Zero FXZF2.8/ZF5.7 Nissin Front/J.Juan Rear Calipers	14	FA185X		FA185R			13
Zero FX ZF3.3/ZF6.5	16-21	FA209/2		FA209/2HH			14
Zero FXS ZF3.3/6ZF5	17-21	FA209/2		FA209/2HH			15
Zero MX 2 Pin Fixing Front Pad	10-12	FA0264		FA0264HH			16
Zero MX ZF2.8/ZF5.7 Nissin Front & Rear Calipers	13	FA185X		FA185R			17
Zero S ZF14.4	19-21	FA209/2		FA209/2HH			18
Zero S ZF6.0 2 Pin Fixing Front Pad	10-12	FA0264		FA0264HH			19
Zero S ZF7.2	19-21	FA209/2		FA209/2HH			20
Zero S ZF8.5/11.4 Nissin Front & Rear Calipers	13	FA185X		FA185R			21
Zero S ZF8.5/11.4 Nissin Front/J.Juan Rear Calipers	14	FA185X		FA185R			22
Zero S ZF9.4/ZF12.5 J.Juan Front & Rear Calipers	15	FA209/2		FA209/2HH			23
Zero S ZF9.8/ZF13.0 J.Juan Front & Rear Calipers	16-19	FA209/2		FA209/2HH			24
Zero SR ZF11.4 Nissin Front/J.Juan Rear Calipers	14	FA185X		FA185R			25
Zero SR ZF12.5 J.Juan Front & Rear Calipers	15	FA209/2		FA209/2HH			26
Zero SR ZF13.0 J.Juan Front & Rear Calipers	16-19	FA209/2		FA209/2HH			27
Zero X 2 Pin Fixing Front Pad	10-12	FA0264		FA0264HH			28
Zero XU 2 Pin Fixing Front Pad	10-12	FA0264		FA0264HH			29
Zero XU ZF2.8/ZF5.7 Nissin Front & Rear Calipers	13	FA185X		FA185R			30
Zero SR/F ZF14.4 kWh Electric	19-21	FA244*	FA244V*	FA244HH*		MD669X*	31
Zero SR/S ZF14.4kWh Electric	19-21	FA244*	FA244V*	FA244HH*		MD669X*	32
							33
							34
							35
							36
							37
							38
							39
							40
							41
							42
							43
							44
							45
							46
							47
							48
							49
							50
							51
							52
							53
							54
							55
							56
							57
							58
							59

*-2 Sets Required. ■ - Also available in MX-S race compound. **SAFETY WARNING:- DO NOT** USE HH PADS ON REAR UNLESS ALSO USED ON FRONT TO AVOID BRAKE IMBALANCE

REAR: AMERICAN PRODUCED MOTORCYCLES

Line #	ZERO	SUFFIX OR PREFIX PAD MATERIALS AND DESCRIPTION	YEAR	FRONT				
				PADS	PADS	PADS	PADS	FRONT ROTOR OPTIONS
				FA Kevlar Organic Pads	V Semi-Sintered V-Pads™	HH/R Double-H™ USA-Made Sintered Pads	EPFA Premium Low Noise Street Sintered Pads	DESIGN NO. <small>See Buyers Guide for rotor style & finish options. Part nos for ordering & sizing.</small>
1	DS ZF13.0 J.Juan Front & Rear Calipers	16-19	FA213		FA213HH			
2	Zero DS ZF6.0/ZF9.0 2 Pin Fixing Front Pad	10-12	FA083X		FA083HH			
3	Zero DS ZF8.5/ZF11.4 Nissin Front & Rear Calipers	13	FA367X		FA367R			
4	Zero DS ZF8.5/ZF11.4 Nissin Front/J.Juan Rear Calipers	14	FA208X		FA208R			
5	Zero DS ZF9.4/ZF12.5 J.Juan Front & Rear Calipers		FA213		FA213HH			
6	Zero DS II ZF14.4	19-21	FA213		FA213HH			
7	Zero DS II ZF7.2	19-21	FA213		FA213HH			
8	Zero DSR ZF13.0 J.Juan Front & Rear Calipers	17-19	FA213		FA213HH			
9	Zero DSR ZF14.4.0	19-21	FA213		FA213HH			
10	Zero DSR Black Forest	19-21	FA213		FA213HH			
11	Zero FXZF2.8/ZF5.7 J.Juan Front & Rear Calipers	15	FA208X		FA208R			
12	Zero FXZF2.8/ZF5.7 Nissin Front & Rear Calipers	13	FA367X		FA367R			
13	Zero FX ZF3.3/ZF6.5	16-21	FA208X		FA208R			
14	Zero FXS ZF3.3/6ZF5	17-21	FA213		FA213HH			
15	Zero FXS ZF3.3/6ZF5	17-21	FA213		FA213HH			
16	Zero MX 2 Pin Fixing Front Pad	10-12	FA083X		FA083HH			
17	Zero MX ZF2.8/ZF5.7 Nissin Front & Rear Calipers	13	FA367X		FA367R			
18	Zero S ZF14.4	19-21	FA213		FA213HH			
19	Zero S ZF6.0 2 Pin Fixing Front Pad	10-12	FA083X		FA083HH			
20	Zero S ZF7.2	19-21	FA213		FA213HH			
21	Zero S ZF8.5/11.4 Nissin Front & Rear Calipers	13	FA367X		FA367R			
22	Zero S ZF8.5/11.4 Nissin Front/J.Juan Rear Calipers	14	FA208X		FA208R			
23	Zero S ZF9.4/ZF12.5 J.Juan Front & Rear Calipers	15	FA213		FA213HH			
24	Zero S ZF9.8/ZF13.0 J.Juan Front & Rear Calipers	16-19	FA213		FA213HH			
25	Zero SR ZF11.4 Nissin Front/J.Juan Rear Calipers	14	FA208X		FA208R			
26	Zero SR ZF12.5 J.Juan Front & Rear Calipers	15	FA213		FA213HH			
27	Zero SR ZF13.0 J.Juan Front & Rear Calipers	16-19	FA213		FA213HH			
28	Zero X 2 Pin Fixing Front Pad	10-12	FA083X		FA083HH			
29	Zero XU 2 Pin Fixing Front Pad	10-12	FA083X		FA083HH			
30	Zero XU ZF2.8/ZF5.7 Nissin Front & Rear Calipers	13	FA367X		FA367R			
31	Zero SR/F ZF14.4 kWh Electric	19-21						
32	Zero SR/S ZF14.4kWh Electric	19-21						
33								
34								
35								
36								
37								
38								
39								
40								
41								
42								
43								
44								
45								
46								
47								
48								
49								
50								
51								
52								
53								
54								
55								
56								
57								
58								
59								

All names & numbers are for reference purposes only. © Registered trademarks of Harley—Davidson® Motor Corp or Buell.

Recommended Fittings: FA400 for use on polished chrome show rotors. FA400HH recommended fitting as replacement for OE.

NOTE: — Some models may have a second rotor fitted as an optional extra. Please double check with your customer exactly which side the front rotor is fitted and if twin rotor or single.

BRAKE
APPLICATIONS

DISC GROUP NO. 001 - FRONT. CHOOSE YOUR PREFERRED STYLE:

BRAKE
APPLICATIONS

Type	Solid	OD	11.5" / 290mm
Color /Finish	Natural	Thickness	0.196" / 5mm
Bobbins	None	Bore	2.22" / 56.4mm

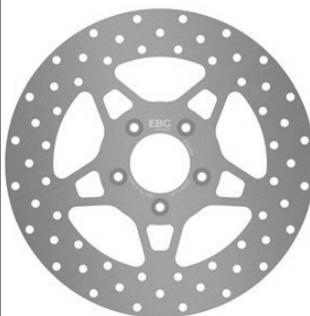

FSD008

Fits EBC Pads: 94, 381, 400, 457

Type	Solid	OD	11.5" / 290mm
Color /Finish	Natural	Thickness	0.196" / 5mm
Bobbins	None	Bore	2.22" / 56.4mm



VR009

Fits EBC Pads: 94, 381, 400, 457

Type	Floating	OD	11.5" / 290mm
Color /Finish	Polished	Thickness	0.196" / 5mm
Bobbins	5	Bore	2.22" / 56.4mm

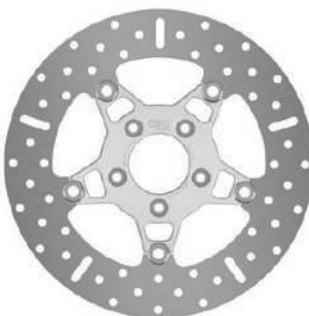

FSD010

Fits EBC Pads: 94, 381, 400, 457

Type	Floating	OD	11.5" / 290mm
Color /Finish	Black	Thickness	0.196" / 5mm
Bobbins	5	Bore	2.22" / 56.4mm



FSD010BLK

Fits EBC Pads: 94, 381, 400, 457

Type	Floating	OD	11.5" / 290mm
Color /Finish	Black	Thickness	0.196" / 5mm
Bobbins	5	Bore	2.22" / 56.4mm



VR010BLK

Fits EBC Pads: 94, 381, 400, 457

Type	Floating	OD	11.5" / 290mm
Color /Finish	Polished	Thickness	0.196" / 5mm
Bobbins	5	Bore	2.22" / 56.4mm

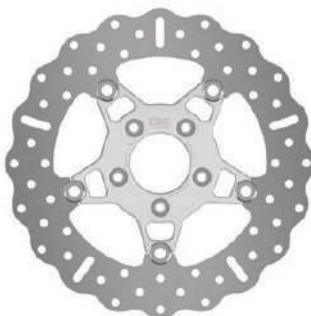

FSD012C

Fits EBC Pads: 94, 381, 400, 457

Type	Floating	OD	11.5" / 290mm
Color /Finish	Black	Thickness	0.196" / 5mm
Bobbins	5	Bore	2.22" / 56.4mm



FSD012CBLK

Fits EBC Pads: 94, 381, 400, 457

Type	Floating	OD	11.5" / 290mm
Color /Finish	Polished	Thickness	0.196" / 5mm
Bobbins	10	Bore	2.22" / 56.4mm

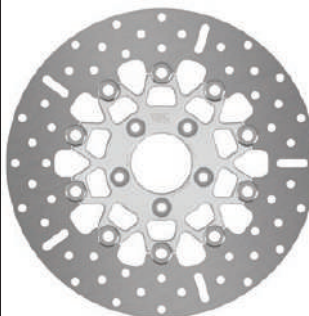

FSD023

Fits EBC Pads: 94, 381, 400, 457

Type	Floating	OD	11.5" / 290mm
Color /Finish	Black	Thickness	0.196" / 5mm
Bobbins	10	Bore	2.22" / 56.4mm

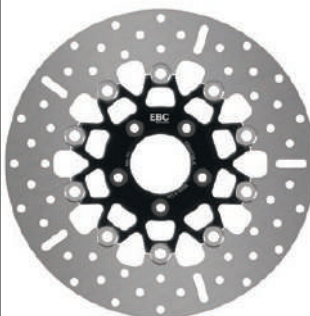

FSD023BLK

Fits EBC Pads: 94, 381, 400, 457

Type	Floating	OD	11.5" / 290mm
Color /Finish	Black	Thickness	0.196" / 5mm
Bobbins	10	Bore	2.22" / 56.4mm



VR023BLK

Fits EBC Pads: 94, 381, 400, 457

Type	Floating	OD	11.5" / 290mm
Color /Finish	Polished	Thickness	0.196" / 5mm
Bobbins	10	Bore	2.22" / 56.4mm

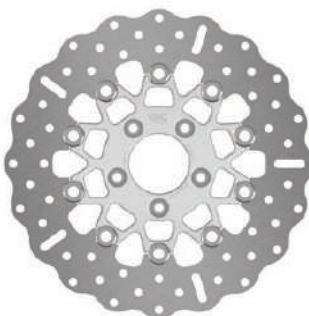

FSD027C

Fits EBC Pads: 94, 381, 400, 457

Type	Floating	OD	11.5" / 290mm
Color /Finish	Black	Thickness	0.196" / 5mm
Bobbins	10	Bore	2.22" / 56.4mm

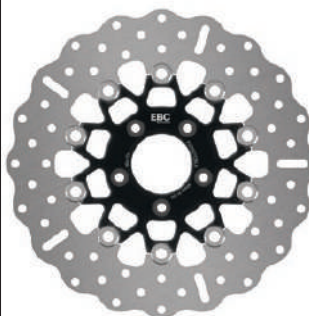

FSD027CBLK

Fits EBC Pads: 94, 381, 400, 457

DISC GROUP NO. 001 - FRONT. CHOOSE YOUR PREFERRED STYLE:

Type	Floating	OD	14" / 355mm
Color /Finish	Black	Thickness	0.196" / 5mm
Bobbins	5	Bore	2.22" / 56.4mm

Type	Floating	OD	15" / 381mm
Color /Finish	Black	Thickness	0.196" / 5mm
Bobbins	5	Bore	2.22" / 56.4mm

Type	Floating	OD	15" / 381mm
Color /Finish	Black	Thickness	0.236" / 6mm
Bobbins	5	Bore	2.22" / 56.4mm

Type	Floating	OD	14" / 355mm
Color /Finish	Black	Thickness	0.196" / 5mm
Bobbins	5	Bore	2.22" / 56.4mm

OVERSIZE ROTOR OPTION

OVERSIZE ROTOR OPTION

OVERSIZE ROTOR OPTION

OVERSIZE ROTOR OPTION

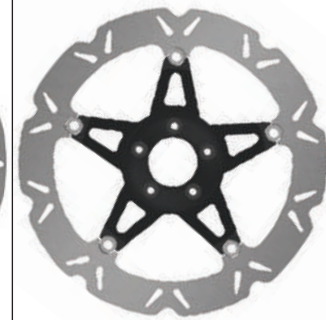
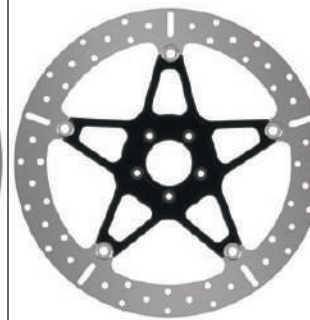
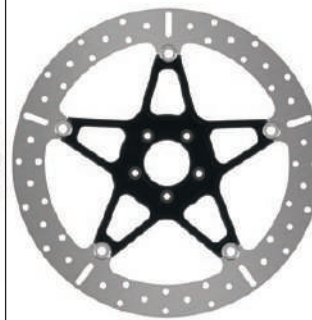
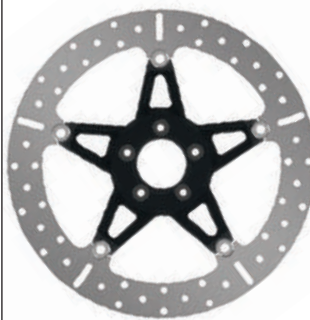

OSMD004-14BLK
Fits EBC Pads: 94, 381, 400, 457

OSMD004-15BLK
Fits EBC Pads: 94, 381, 400, 457

OSMD004-15/6BLK
Fits EBC Pads: 94, 381, 400, 457

OSVR004-14BLK
Fits EBC Pads: 94, 381, 400, 457



BRK701

BRK702

BRK709

BRK710

BRK709

BRK710

BRK701

BRK702

Type	Floating	OD	15" / 381mm
Color /Finish	Black	Thickness	0.196" / 5mm
Bobbins	5	Bore	2.22" / 56.4mm

Type	Floating	OD	15" / 381mm
Color /Finish	Black	Thickness	0.236" / 6mm
Bobbins	5	Bore	2.22" / 56.4mm

OVERSIZE ROTOR OPTION

OVERSIZE ROTOR OPTION

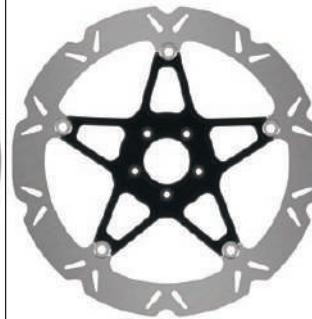
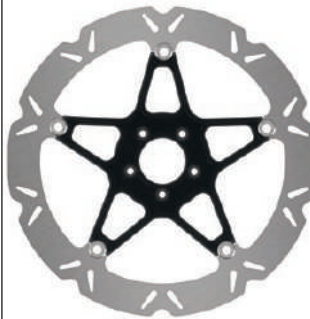

OSVR004-15BLK
Fits EBC Pads: 94, 381, 400, 457

OSVR004-15/6BLK
Fits EBC Pads: 94, 381, 400, 457



BRK709

BRK710

BRK709

BRK710

Increased stopping power, feel and control with the EBC FULLY floating oversize range. These kits bolt directly onto your bike using the stock caliper and also deliver the advantages of a floating rotor over solid designs.

DISC GROUP NO. 002 - FRONT. CHOOSE YOUR PREFERRED STYLE:

APPLICATIONS
BRAKE

Type	Solid	OD	11.5" / 290mm
Color /Finish	Natural	Thickness	0.196" / 5mm
Bobbins	None	Bore	1.99" / 50.6mm

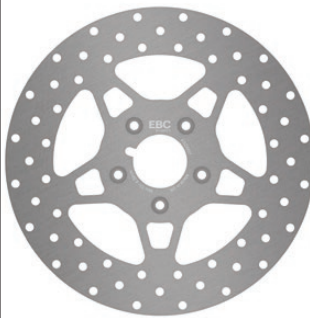

FSD007
Fits EBC Pads: 94, 216/3

Type	Solid	OD	11.5" / 290mm
Color /Finish	Natural	Thickness	0.196" / 5mm
Bobbins	None	Bore	1.99" / 50.6mm



VR007
Fits EBC Pads: 94, 216/3

Type	Floating	OD	11.5" / 290mm
Color /Finish	Polished	Thickness	0.196" / 5mm
Bobbins	5	Bore	1.99" / 50.6mm

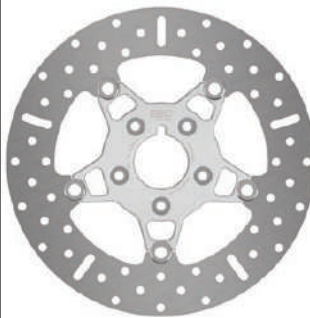

FSD009
Fits EBC Pads: 94, 216/3

Type	Floating	OD	11.5" / 290mm
Color /Finish	Black	Thickness	0.196" / 5mm
Bobbins	5	Bore	1.99" / 50.6mm

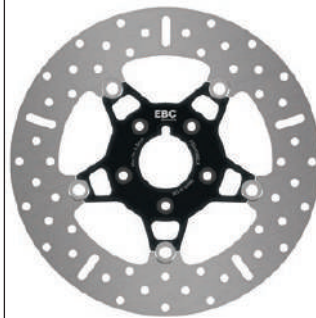

FSD009BLK
Fits EBC Pads: 94, 216/3

Type	Floating	OD	11.5" / 290mm
Color /Finish	Polished	Thickness	0.196" / 5mm
Bobbins	5	Bore	1.99" / 50.6mm

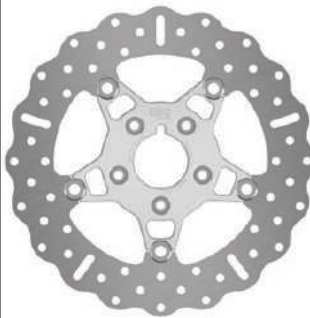

FSD011C
Fits EBC Pads: 94, 216/3

Type	Floating	OD	11.5" / 290mm
Color /Finish	Black	Thickness	0.196" / 5mm
Bobbins	5	Bore	1.99" / 50.6mm



FSD011CBLK
Fits EBC Pads: 94, 216/3

Type	Floating	OD	11.5" / 290mm
Color /Finish	Black	Thickness	0.196" / 5mm
Bobbins	5	Bore	1.99" / 50.6mm



VR011BLK
Fits EBC Pads: 94, 216/3

Type	Floating	OD	11.5" / 290mm
Color /Finish	Polished	Thickness	0.196" / 5mm
Bobbins	10	Bore	1.99" / 50.6mm

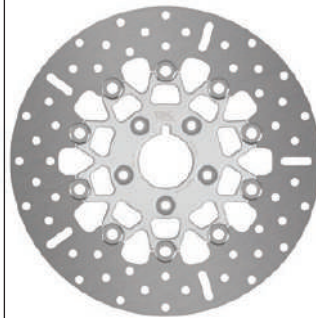

FSD022
Fits EBC Pads: 94, 216/3

Type	Floating	OD	11.5" / 290mm
Color /Finish	Black	Thickness	0.196" / 5mm
Bobbins	10	Bore	1.99" / 50.6mm

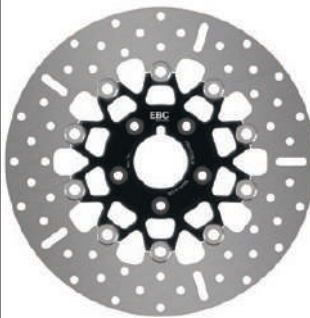

FSD022BLK
Fits EBC Pads: 94, 216/3

Type	Floating	OD	11.5" / 290mm
Color /Finish	Polished	Thickness	0.196" / 5mm
Bobbins	10	Bore	1.99" / 50.6mm

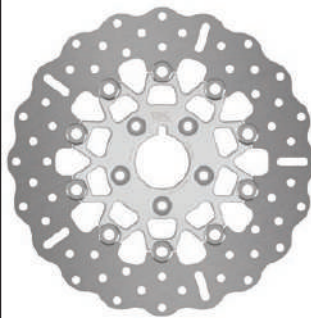



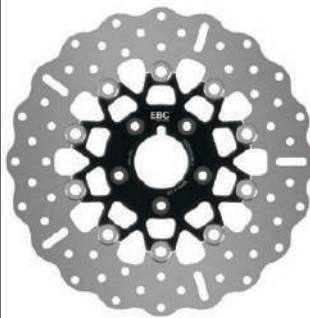

FSD026C
Fits EBC Pads: 94, 216/3

Type	Floating	OD	11.5" / 290mm
Color /Finish	Black	Thickness	0.196" / 5mm
Bobbins	10	Bore	1.99" / 50.6mm

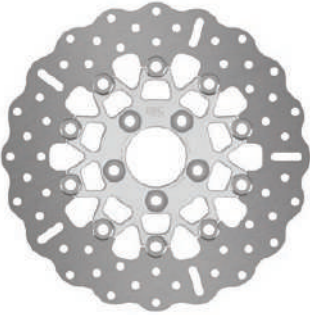
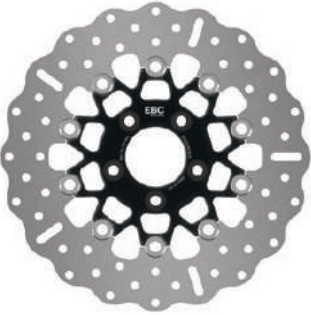
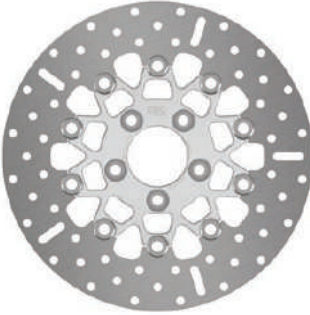

FSD026CBLK
Fits EBC Pads: 94, 216/3

DISC GROUP NO. 003 - REAR. CHOOSE YOUR PREFERRED STYLE:

Type	Solid	OD	11.5" / 290mm	Type	Solid	OD	11.5" / 290mm	Type	Floating	OD	11.5" / 290mm	Type	Floating	OD	11.5" / 290mm
Color /Finish	Natural	Thickness	0.236" / 6mm	Color /Finish	Natural	Thickness	0.236" / 6mm	Color /Finish	Polished	Thickness	0.236" / 6mm	Color /Finish	Black	Thickness	0.236" / 6mm
Bobbins	None	Bore	2.22" / 56.4mm	Bobbins	None	Bore	2.22" / 56.4mm	Bobbins	10	Bore	2.22" / 56.4mm	Bobbins	10	Bore	2.22" / 56.4mm
															
RSD008 Fits EBC Pads: 387, 400, 434, 458, 710				VR008 Fits EBC Pads: 387, 400, 434, 458, 710				RSD018C Fits EBC Pads: 387, 400, 434, 458, 710				RSD018CBLK Fits EBC Pads: 387, 400, 434, 458, 710			
Color /Finish	Polished	Thickness	0.236" / 6mm	Color /Finish	Black	Thickness	0.236" / 6mm	Color /Finish	Black	Thickness	0.236" / 6mm				
Bobbins	10	Bore	2.22" / 56.4mm	Bobbins	10	Bore	2.22" / 56.4mm	Bobbins	10	Bore	2.22" / 56.4mm				
															
RSD020 Fits EBC Pads: 387, 400, 434, 458, 710				RSD020BLK Fits EBC Pads: 387, 400, 434, 458, 710				VR020BLK Fits EBC Pads: 387, 400, 434, 458, 710							

DISC GROUP NO. 004 - REAR. CHOOSE YOUR PREFERRED STYLE:

Type	Solid	OD	11.5" / 290mm
Color /Finish	Natural	Thickness	0.236" / 6mm
Bobbins	None	Bore	1.99" / 50.6mm

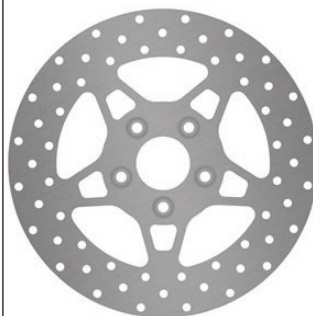

RSD007

Fits EBC Pads: 200, 216/3

Type	Solid	OD	11.5" / 290mm
Color /Finish	Natural	Thickness	0.275" / 7mm
Bobbins	None	Bore	1.99" / 50.6mm

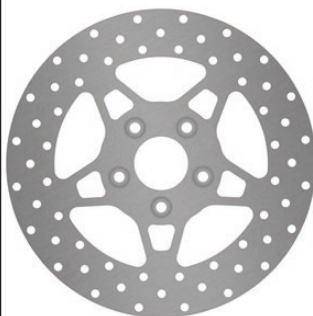

RSD007A

Fits EBC Pads: 200, 216/3

Type	Floating	OD	11.5" / 290mm
Color /Finish	Black	Thickness	0.236" / 6mm
Bobbins	10	Bore	1.99" / 50.6mm

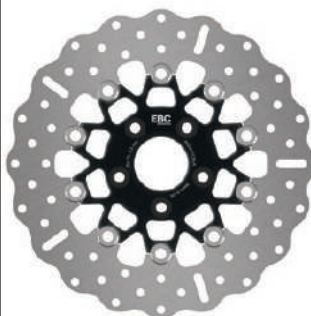

RSD017CBLK

Fits EBC Pads: 200, 216/3

Type	Floating	OD	11.5" / 290mm
Color /Finish	Polished	Thickness	0.236" / 6mm
Bobbins	10	Bore	1.99" / 50.6mm

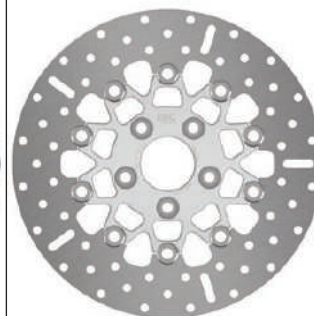

RSD019

Fits EBC Pads: 200, 216/3

Type	Floating	OD	11.5" / 290mm
Color /Finish	Polished	Thickness	0.236" / 6mm
Bobbins	10	Bore	1.99" / 50.6mm

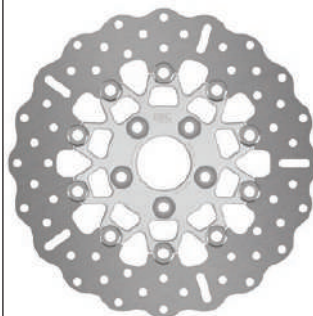

RSD019C

Fits EBC Pads: 200, 216/3

Type	Floating	OD	11.5" / 290mm
Color /Finish	Black	Thickness	0.236" / 6mm
Bobbins	10	Bore	1.99" / 50.6mm

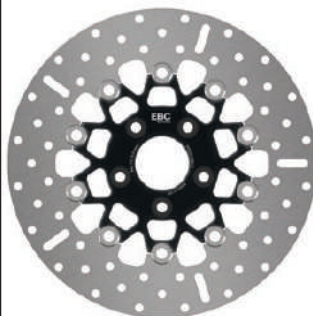

RSD019BLK

Fits EBC Pads: 200, 216/3

Type	Floating	OD	11.5" / 290mm
Color /Finish	Black	Thickness	0.236" / 6mm
Bobbins	10	Bore	1.99" / 50.6mm



VR019BLK

Fits EBC Pads: 200, 216/3

Type	Solid	OD	10.67" / 271mm
Color /Finish	Natural	Thickness	0.3" / 7mm
Bobbins	None	Bore	4" / 101.8mm

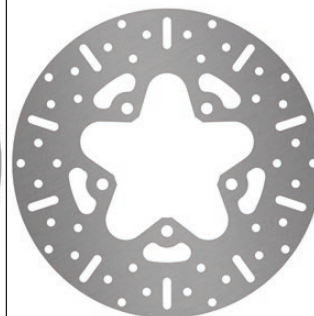

MD509SR

Fits EBC Pads: 201

DISC GROUP NO. 005 - FRONT. CHOOSE YOUR PREFERRED STYLE:

Type	Solid	OD	9.44" / 240mm
Color /Finish	Natural	Thickness	0.196" / 5mm
Bobbins	None	Bore	4.13" / 105mm

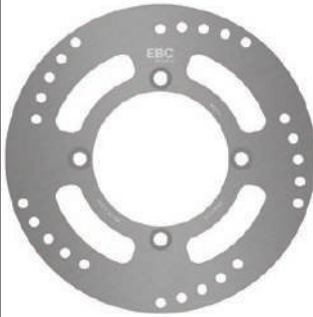

MD511
Fits EBC Pads: 140, 251

BRAKE
APPLICATIONS

DISC GROUP NO. 006 - FRONT/REAR. CHOOSE YOUR PREFERRED STYLE:

Type	Solid	OD	11.5" / 290mm
Color /Finish	Natural	Thickness	0.196" / 5mm
Bobbins	None	Bore	6.77" / 172mm

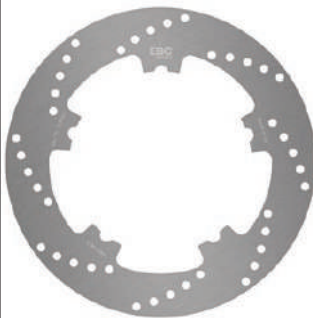

MD514LS
Fits EBC Pads: 400

Type	Solid	OD	11.5" / 290mm
Color /Finish	Natural	Thickness	0.196" / 5mm
Bobbins	None	Bore	6.77" / 172mm

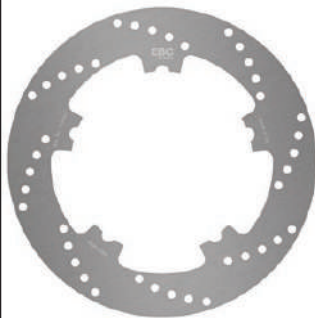

MD514RS
Fits EBC Pads: 400

Type	Solid	OD	11.5" / 290mm
Color /Finish	Natural	Thickness	0.196" / 5mm
Bobbins	None	Bore	6.77" / 172mm



VR514
Fits EBC Pads: 400

Type	Solid	OD	11.5" / 292mm
Color /Finish	Natural	Thickness	0.23" / 5.8mm
Bobbins	None	Bore	4" / 101.4mm

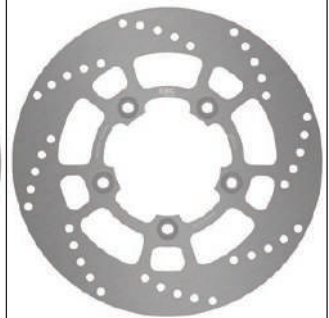

MD515
Fits EBC Pads: 400

DISC GROUP NO. 007 - FRONT. CHOOSE YOUR PREFERRED STYLE:

BRAKE APPLICATIONS

Type	Solid	OD	11.8" / 300mm
Color /Finish	Natural	Thickness	0.196" / 5mm
Bobbins	None	Bore	6.7" / 171mm

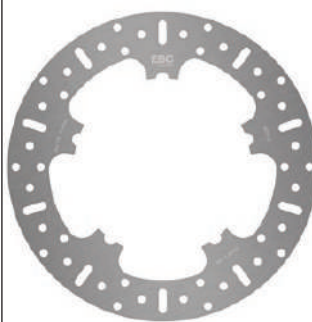

MD516
Fits EBC Pads: 400, 409, 457

Type	Solid	OD	11.8" / 300mm
Color /Finish	Natural	Thickness	0.196" / 5mm
Bobbins	None	Bore	6.7" / 171mm



VR516
Fits EBC Pads: 400, 409, 457

Type	Floating	OD	11.8" / 300mm
Color /Finish	Polished	Thickness	0.196" / 5mm
Bobbins	5	Bore	6.7" / 171mm

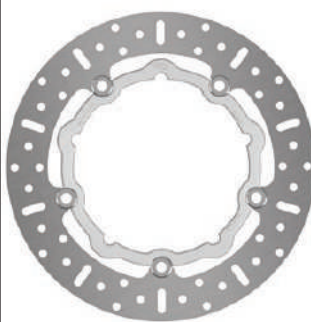

MD516X
Fits EBC Pads: 400, 409, 457

Type	Floating	OD	11.8" / 300mm
Color /Finish	Black	Thickness	0.196" / 5mm
Bobbins	5	Bore	6.7" / 171mm

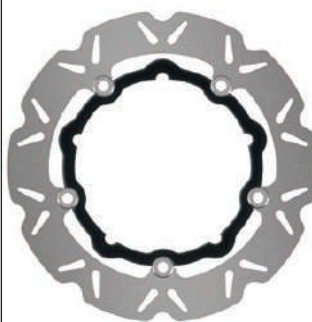

VR516BLK
Fits EBC Pads: 400, 409, 457

Type	Floating	OD	14" / 355mm
Color /Finish	Polished	Thickness	0.196" / 5mm
Bobbins	5	Bore	6.7" / 171mm

OVERSIZE ROTOR OPTION

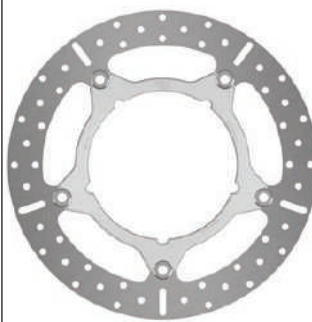

OSMD516-14
Fits EBC Pads: 400, 409, 457

Type	Floating	OD	14" / 355mm
Color /Finish	Black	Thickness	0.196" / 5mm
Bobbins	5	Bore	6.7" / 171mm

OVERSIZE ROTOR OPTION

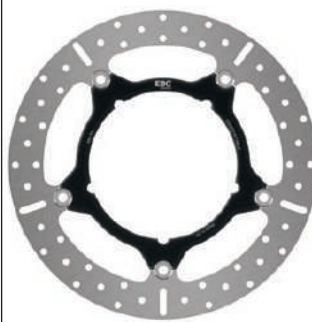

OSMD516-14BLK
Fits EBC Pads: 400, 409, 457

Type	Floating	OD	14" / 355mm
Color /Finish	Black	Thickness	0.196" / 5mm
Bobbins	5	Bore	6.7" / 171mm

OVERSIZE ROTOR OPTION

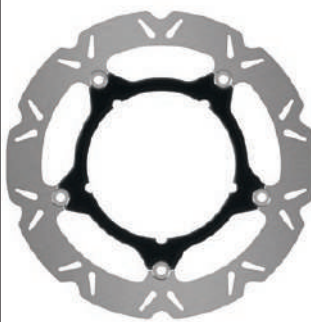

OSVR516-14
Fits EBC Pads: 400, 409, 457

Type	Floating	OD	15" / 381mm
Color /Finish	Polished	Thickness	0.196" / 5mm
Bobbins	5	Bore	6.7" / 171mm

OVERSIZE ROTOR OPTION

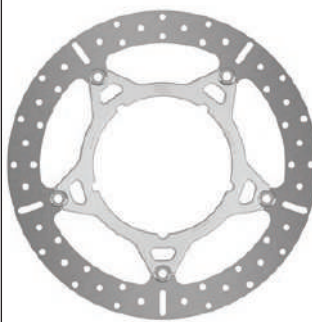

OSMD516-15
Fits EBC Pads: 400, 409, 457



Supplied with relocation bracket & hardware

BRK703 BRK704



Supplied with relocation bracket & hardware

BRK703 BRK704



Supplied with relocation bracket & hardware

BRK703 BRK704



Supplied with relocation bracket & hardware

BRK707 BRK708

Type	Floating	OD	15" / 381mm
Color /Finish	Black	Thickness	0.196" / 5mm
Bobbins	5	Bore	6.7" / 171mm

OVERSIZE ROTOR OPTION

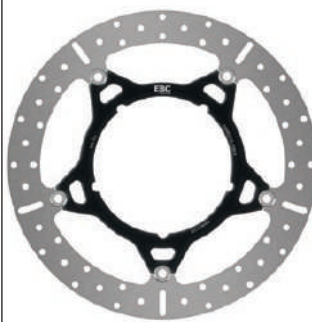

OSMD516-15BLK
Fits EBC Pads: 400, 409, 457

Supplied with relocation bracket & hardware

BRK707 SEE RIGHT BRK708

Type	Floating	OD	15" / 381mm
Color /Finish	Black	Thickness	0.196" / 5mm
Bobbins	5	Bore	6.7" / 171mm

OVERSIZE ROTOR OPTION

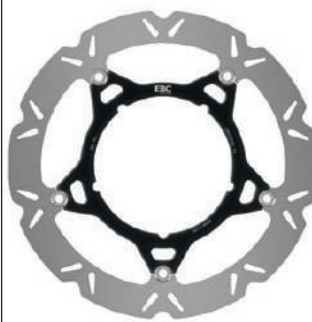

OSVR516-15
Fits EBC Pads: 400, 409, 457

Supplied with relocation bracket & hardware

BRK707 SEE RIGHT BRK708

Increased stopping power, feel and control with the EBC FULLY floating oversize range. These kits bolt directly onto your bike using the stock caliper and also deliver the advantages of a floating rotor over solid designs.



BRK707 BRK708

DISC GROUP NO. 008 - REAR. CHOOSE YOUR PREFERRED STYLE:

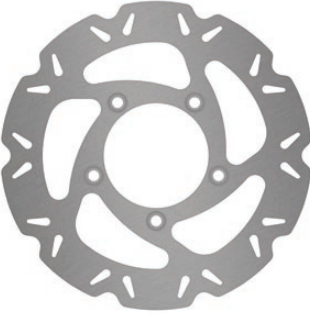
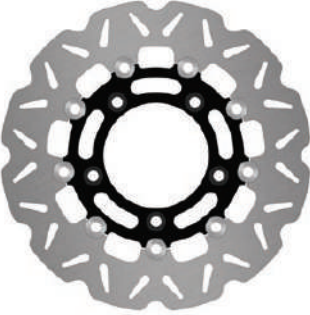
Type	Solid	OD	11.8" / 300mm	Type	Solid	OD	11.8" / 300mm	Type	Floating	OD	11.8" / 300mm
Color /Finish	Natural	Thickness	0.275" / 7mm	Color /Finish	Natural	Thickness	0.196" / 5mm	Color /Finish	Black	Thickness	0.196" / 5mm
Bobbins	None	Bore	4" / 101.6mm	Bobbins	None	Bore	4" / 101.6mm	Bobbins	9	Bore	4" / 101.6mm
											
MD517 Fits EBC Pads: 409				VR517 Fits EBC Pads: 409				VR517BLK Fits EBC Pads: 409			

BRAKE APPLICATIONS

DISC GROUP NO. 009 - FRONT. CHOOSE YOUR PREFERRED STYLE:

Type	Solid	OD	11.8" / 300mm
Color /Finish	Natural	Thickness	0.196" / 5mm
Bobbins	None	Bore	2.22" / 56.4mm



VR518
Fits EBC Pads: 400, 409, 457

Type	Floating	OD	11.8" / 300mm
Color /Finish	Polished	Thickness	0.196" / 5mm
Bobbins	5	Bore	2.22" / 56.4mm

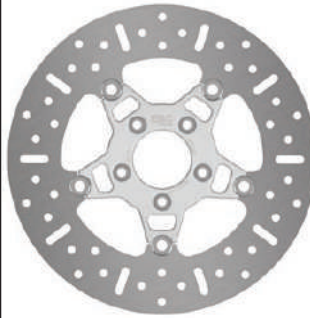

MD518/5
Fits EBC Pads: 400, 409, 457

Type	Floating	OD	11.8" / 300mm
Color /Finish	Black	Thickness	0.196" / 5mm
Bobbins	5	Bore	2.22" / 56.4mm



MD518/5BLK
Fits EBC Pads: 400, 409, 457

Type	Floating	OD	11.8" / 300mm
Color /Finish	Polished	Thickness	0.196" / 5mm
Bobbins	10	Bore	2.22" / 56.4mm

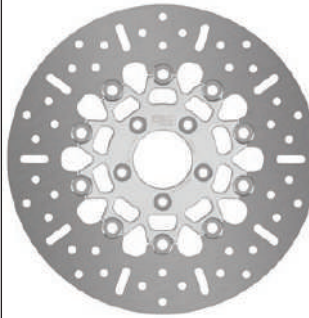

MD518
Fits EBC Pads: 400, 409, 457

Type	Floating	OD	11.8" / 300mm
Color /Finish	Black	Thickness	0.196" / 5mm
Bobbins	10	Bore	2.22" / 56.4mm

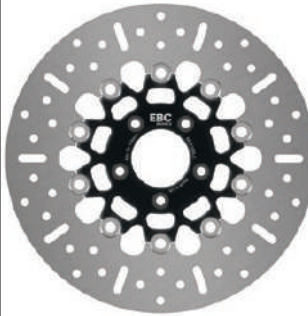

MD518BLK
Fits EBC Pads: 400, 409, 457

Type	Floating	OD	11.8" / 300mm
Color /Finish	Black	Thickness	0.196" / 5mm
Bobbins	10	Bore	2.22" / 56.4mm

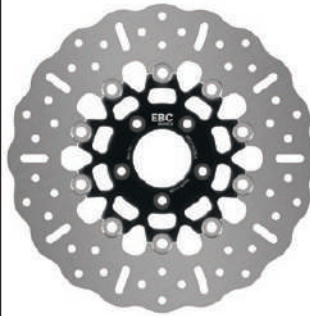

MD518CBLK
Fits EBC Pads: 400, 409, 457

Type	Floating	OD	11.8" / 300mm
Color /Finish	Black	Thickness	0.196" / 5mm
Bobbins	10	Bore	2.22" / 56.4mm



VR518BLK
Fits EBC Pads: 400, 409, 457

Type	Floating	OD	14" / 355mm
Color /Finish	Polished	Thickness	0.196" / 5mm
Bobbins	5	Bore	2.22" / 56.4mm

OVERSIZE ROTOR OPTION

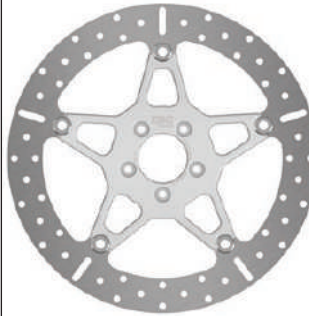

OSMD518-14
Fits EBC Pads: 400, 409, 457
Supplied with relocation bracket & hardware
BRK701



Type	Floating	OD	14" / 355mm
Color /Finish	Black	Thickness	0.196" / 5mm
Bobbins	5	Bore	2.22" / 56.4mm

OVERSIZE ROTOR OPTION

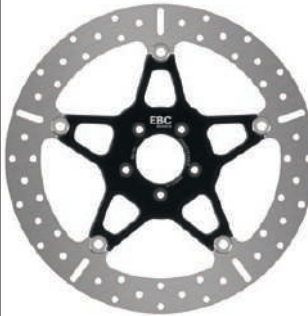

OSMD518-14
Fits EBC Pads: 400, 409, 457

Supplied with relocation bracket & hardware



BRK701

Increased stopping power, feel and control with the EBC FULLY floating oversize range

These kits bolt directly onto your bike using the stock caliper and also deliver the advantages of a floating rotor over solid designs.

DISC GROUP NO. 010 - FRONT. CHOOSE YOUR PREFERRED STYLE:

Type	Solid	OD	11.8" / 300mm
Color /Finish	Natural	Thickness	0.196" / 5mm
Bobbins	None	Bore	2.22" / 56.4mm



VR520
Fits EBC Pads: 409

Type	Floating	OD	11.8" / 300mm
Color /Finish	Polished	Thickness	0.196" / 5mm
Bobbins	5	Bore	2.22" / 56.4mm

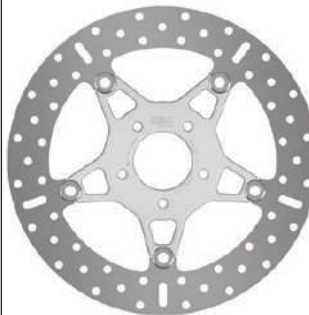

MD520
Fits EBC Pads: 409

DISC GROUP NO. 010 - FRONT (CONTD). CHOOSE YOUR PREFERRED STYLE:

Type	Floating	OD	11.8" / 300mm
Color /Finish	Black	Thickness	0.196" / 5mm
Bobbins	5	Bore	2.22" / 56.4mm



VR520BLK
Fits EBC Pads: 409

Type	Solid	OD	11.81" / 300mm
Color /Finish	Natural	Thickness	0.196" / 5mm
Bobbins	None	Bore	2.22" / 56.4mm



MD541
Fits EBC Pads: 409

Type	Floating	OD	11.8" / 300mm
Color /Finish	Black	Thickness	0.196" / 5mm
Bobbins	10	Bore	2.22" / 56.4mm



MD520/10BLK
Fits EBC Pads: 409

DISC GROUP NO. 011 - REAR. CHOOSE YOUR PREFERRED STYLE:

Type	Solid	OD	11.8" / 300mm
Color /Finish	Natural	Thickness	0.275" / 7mm
Bobbins	None	Bore	2.22" / 56.4mm



VR521
Fits EBC Pads: 409

Type	Floating	OD	11.8" / 300mm
Color /Finish	Polished	Thickness	0.275" / 7mm
Bobbins	10	Bore	2.22" / 56.4mm

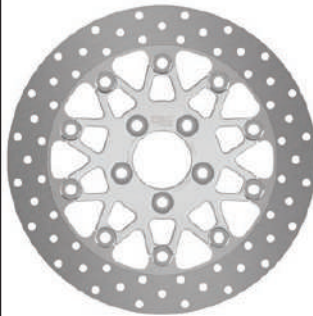

MD521
Fits EBC Pads: 409

Type	Floating	OD	11.8" / 300mm
Color /Finish	Black	Thickness	0.275" / 7mm
Bobbins	10	Bore	2.22" / 56.4mm



MD521BLK
Fits EBC Pads: 409

Type	Floating	OD	11.8" / 300mm
Color /Finish	Polished	Thickness	0.275" / 7mm
Bobbins	10	Bore	2.22" / 56.4mm

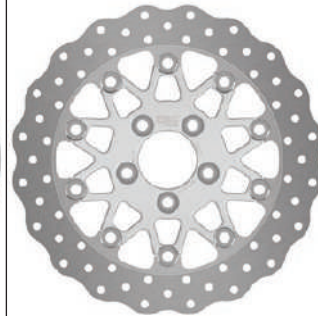

MD521C
Fits EBC Pads: 409

Type	Floating	OD	11.8" / 300mm
Color /Finish	Black	Thickness	0.275" / 7mm
Bobbins	10	Bore	2.22" / 56.4mm



VR521BLK
Fits EBC Pads: 409

DISC GROUP NO. 012 - FRONT. CHOOSE YOUR PREFERRED STYLE:

Type	Solid	OD	11.4" / 290mm
Color /Finish	Natural	Thickness	0.2" / 5.2mm
Bobbins	None	Bore	2.22" / 56.4mm



MD523
Fits EBC Pads: 296

Type	Floating	OD	11.4" / 290mm
Color /Finish	Polished	Thickness	0.2" / 5.2mm
Bobbins	5	Bore	2.22" / 56.4mm

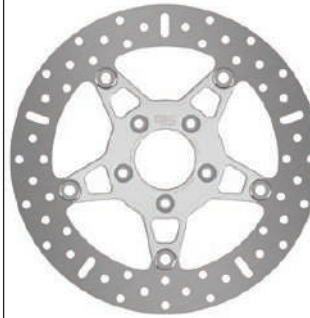

FSD523
Fits EBC Pads: 296

Type	Floating	OD	11.4" / 290mm
Color /Finish	Gold	Thickness	0.2" / 5.2mm
Bobbins	5	Bore	2.22" / 56.4mm

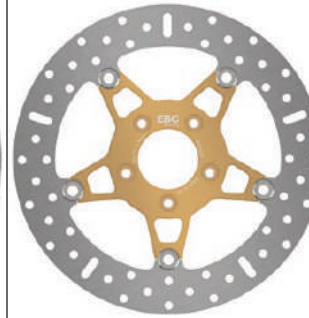

MD523X
Fits EBC Pads: 296

Type	Floating	OD	11.4" / 290mm
Color /Finish	Black	Thickness	0.2" / 5.2mm
Bobbins	5	Bore	2.22" / 56.4mm

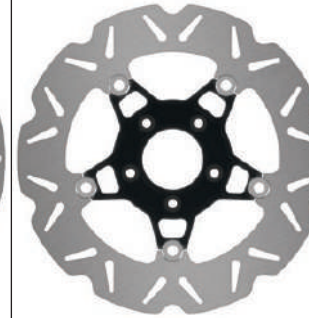

VR523BLK
Fits EBC Pads: 296

DISC GROUP NO. 013 - REAR. CHOOSE YOUR PREFERRED STYLE:

Type	Solid	OD	10.23" / 260mm
Color /Finish	Natural	Thickness	0.275" / 7mm
Bobbins	None	Bore	2.22" / 56.4mm



MD524
Fits EBC Pads: 254, 387

Type	Floating	OD	10.23" / 260mm
Color /Finish	Polished	Thickness	0.275" / 7mm
Bobbins	10	Bore	2.22" / 56.4mm

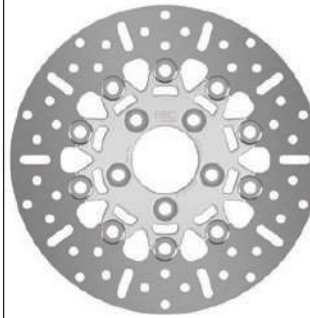

RSD524
Fits EBC Pads: 254, 387

Type	Floating	OD	10.23" / 260mm
Color /Finish	Gold	Thickness	0.275" / 7mm
Bobbins	10	Bore	2.22" / 56.4mm

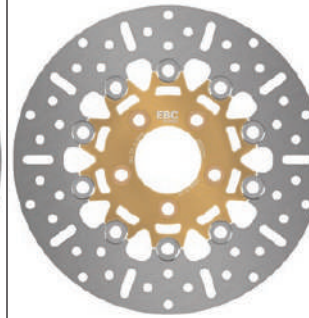

MD524X
Fits EBC Pads: 254, 387

Type	Floating	OD	10.23" / 260mm
Color /Finish	Black	Thickness	0.275" / 7mm
Bobbins	10	Bore	2.22" / 56.4mm

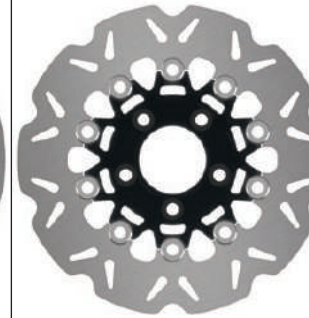

VR524BLK
Fits EBC Pads: 254, 387

Type	Solid	OD	9.44" / 240mm
Color /Finish	Natural	Thickness	0.196" / 5mm
Bobbins	None	Bore	2.77" / 70.6mm

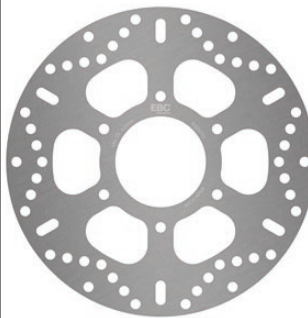



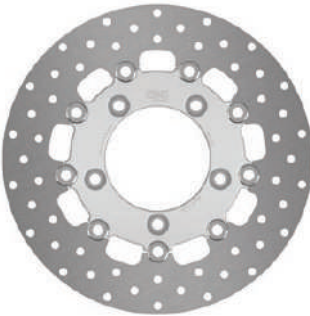
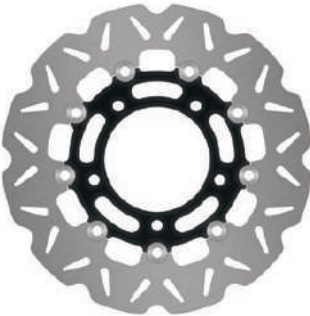

MD522
Fits EBC Pads: 140

DISC GROUP NO. 014 - REAR. CHOOSE YOUR PREFERRED STYLE:

<table border="1" style="width: 100%; border-collapse: collapse;"> <tr><td>Type</td><td>Floating</td><td>OD</td><td>11.8" / 300mm</td></tr> <tr><td>Color /Finish</td><td>Polished</td><td>Thickness</td><td>0.275" / 7mm</td></tr> <tr><td>Bobbins</td><td>9</td><td>Bore</td><td>4" / 101.4mm</td></tr> </table>  <p>MD525 Fits EBC Pads: 409</p>	Type	Floating	OD	11.8" / 300mm	Color /Finish	Polished	Thickness	0.275" / 7mm	Bobbins	9	Bore	4" / 101.4mm	<table border="1" style="width: 100%; border-collapse: collapse;"> <tr><td>Type</td><td>Floating</td><td>OD</td><td>11.8" / 300mm</td></tr> <tr><td>Color /Finish</td><td>Black</td><td>Thickness</td><td>0.275" / 7mm</td></tr> <tr><td>Bobbins</td><td>9</td><td>Bore</td><td>4" / 101.4mm</td></tr> </table>  <p>VR525BLK Fits EBC Pads: 409</p>	Type	Floating	OD	11.8" / 300mm	Color /Finish	Black	Thickness	0.275" / 7mm	Bobbins	9	Bore	4" / 101.4mm		
Type	Floating	OD	11.8" / 300mm																								
Color /Finish	Polished	Thickness	0.275" / 7mm																								
Bobbins	9	Bore	4" / 101.4mm																								
Type	Floating	OD	11.8" / 300mm																								
Color /Finish	Black	Thickness	0.275" / 7mm																								
Bobbins	9	Bore	4" / 101.4mm																								

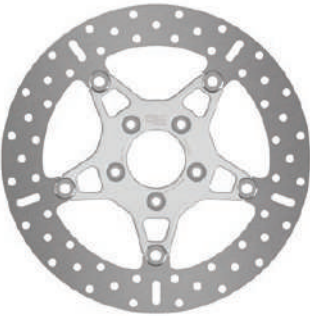
DISC GROUP NO. 015 - FRONT. CHOOSE YOUR PREFERRED STYLE:

<table border="1" style="width: 100%; border-collapse: collapse;"> <tr><td>Type</td><td>Solid</td><td>OD</td><td>11.8" / 300mm</td></tr> <tr><td>Color /Finish</td><td>Natural</td><td>Thickness</td><td>0.196" / 5mm</td></tr> <tr><td>Bobbins</td><td>None</td><td>Bore</td><td>2.22" / 56.4mm</td></tr> </table>  <p>MD526 Fits EBC Pads: 296, 640</p>	Type	Solid	OD	11.8" / 300mm	Color /Finish	Natural	Thickness	0.196" / 5mm	Bobbins	None	Bore	2.22" / 56.4mm	<table border="1" style="width: 100%; border-collapse: collapse;"> <tr><td>Type</td><td>Solid</td><td>OD</td><td>11.8" / 300mm</td></tr> <tr><td>Color /Finish</td><td>Natural</td><td>Thickness</td><td>0.196" / 5mm</td></tr> <tr><td>Bobbins</td><td>None</td><td>Bore</td><td>2.22" / 56.4mm</td></tr> </table>  <p>VR526 Fits EBC Pads: 296, 640</p>	Type	Solid	OD	11.8" / 300mm	Color /Finish	Natural	Thickness	0.196" / 5mm	Bobbins	None	Bore	2.22" / 56.4mm	<table border="1" style="width: 100%; border-collapse: collapse;"> <tr><td>Type</td><td>Floating</td><td>OD</td><td>11.8" / 300mm</td></tr> <tr><td>Color /Finish</td><td>Polished</td><td>Thickness</td><td>0.196" / 5mm</td></tr> <tr><td>Bobbins</td><td>5</td><td>Bore</td><td>2.22" / 56.4mm</td></tr> </table>  <p>MD526X Fits EBC Pads: 296, 640</p>	Type	Floating	OD	11.8" / 300mm	Color /Finish	Polished	Thickness	0.196" / 5mm	Bobbins	5	Bore	2.22" / 56.4mm	<table border="1" style="width: 100%; border-collapse: collapse;"> <tr><td>Type</td><td>Floating</td><td>OD</td><td>11.8" / 300mm</td></tr> <tr><td>Color /Finish</td><td>Black</td><td>Thickness</td><td>0.196" / 5mm</td></tr> <tr><td>Bobbins</td><td>5</td><td>Bore</td><td>2.22" / 56.4mm</td></tr> </table>  <p>MD526XBLK Fits EBC Pads: 296, 640</p>	Type	Floating	OD	11.8" / 300mm	Color /Finish	Black	Thickness	0.196" / 5mm	Bobbins	5	Bore	2.22" / 56.4mm
Type	Solid	OD	11.8" / 300mm																																																
Color /Finish	Natural	Thickness	0.196" / 5mm																																																
Bobbins	None	Bore	2.22" / 56.4mm																																																
Type	Solid	OD	11.8" / 300mm																																																
Color /Finish	Natural	Thickness	0.196" / 5mm																																																
Bobbins	None	Bore	2.22" / 56.4mm																																																
Type	Floating	OD	11.8" / 300mm																																																
Color /Finish	Polished	Thickness	0.196" / 5mm																																																
Bobbins	5	Bore	2.22" / 56.4mm																																																
Type	Floating	OD	11.8" / 300mm																																																
Color /Finish	Black	Thickness	0.196" / 5mm																																																
Bobbins	5	Bore	2.22" / 56.4mm																																																
<table border="1" style="width: 100%; border-collapse: collapse;"> <tr><td>Type</td><td>Floating</td><td>OD</td><td>11.8" / 300mm</td></tr> <tr><td>Color /Finish</td><td>Black</td><td>Thickness</td><td>0.196" / 5mm</td></tr> <tr><td>Bobbins</td><td>5</td><td>Bore</td><td>2.22" / 56.4mm</td></tr> </table>  <p>VR526BLK Fits EBC Pads: 296, 640</p>	Type	Floating	OD	11.8" / 300mm	Color /Finish	Black	Thickness	0.196" / 5mm	Bobbins	5	Bore	2.22" / 56.4mm																																							
Type	Floating	OD	11.8" / 300mm																																																
Color /Finish	Black	Thickness	0.196" / 5mm																																																
Bobbins	5	Bore	2.22" / 56.4mm																																																

DISC GROUP NO. 016 - REAR. CHOOSE YOUR PREFERRED STYLE:

Type	Solid	OD	11.4" / 290mm
Color /Finish	Natural	Thickness	0.236" / 6mm
Bobbins	None	Bore	2.22" / 56.4mm



VR528
Fits EBC Pads: 458, 710

Type	Floating	OD	11.4" / 290mm
Color /Finish	Polished	Thickness	0.236" / 6mm
Bobbins	10	Bore	2.22" / 56.4mm

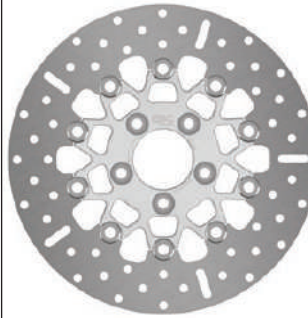

MD528
Fits EBC Pads: 458, 710

Type	Floating	OD	11.4" / 290mm
Color /Finish	Polished	Thickness	0.236" / 6mm
Bobbins	10	Bore	2.22" / 56.4mm

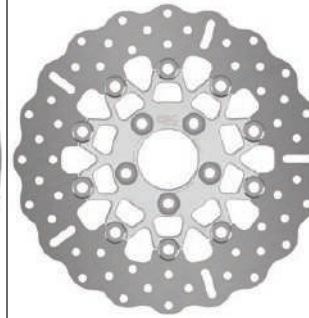

MD528C
Fits EBC Pads: 458, 710

Type	Floating	OD	11.4" / 290mm
Color /Finish	Black	Thickness	0.236" / 6mm
Bobbins	10	Bore	2.22" / 56.4mm

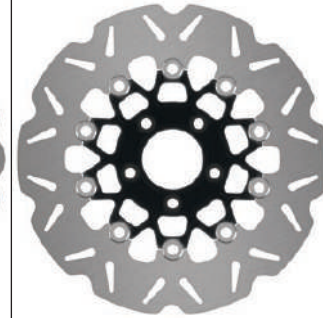

VR528BLK
Fits EBC Pads: 458, 710

DISC GROUP NO. 017 - FRONT. CHOOSE YOUR PREFERRED STYLE:

Type	Solid	OD	11.8" / 300mm
Color /Finish	Natural	Thickness	0.196" / 5mm
Bobbins	None	Bore	5.48" / 139.2mm

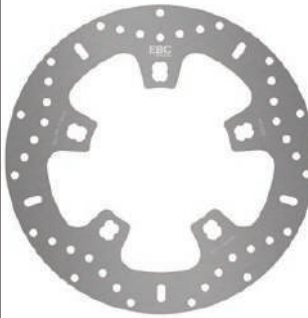

MD529
Fits EBC Pads: 409

Type	Solid	OD	11.8" / 300mm
Color /Finish	Natural	Thickness	0.196" / 5mm
Bobbins	None	Bore	5.48" / 139.2mm

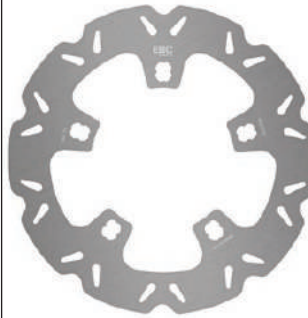

VR529
Fits EBC Pads: 409

Type	Solid	OD	14" / 355mm
Color /Finish	Natural	Thickness	0.196" / 5mm
Bobbins	None	Bore	5.48" / 139.2mm

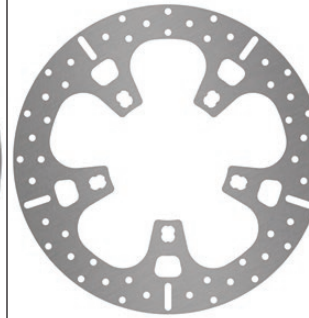

OSMD529-14
Fits EBC Pads: 409
Supplied with relocation bracket & hardware
BRK701

Type	Solid	OD	14" / 355mm
Color /Finish	Natural	Thickness	0.196" / 5mm
Bobbins	None	Bore	5.48" / 139.2mm

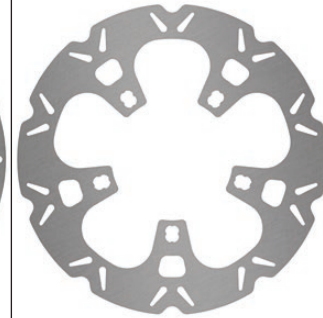

OSVR529-14
Fits EBC Pads: 409
Supplied with relocation bracket & hardware
BRK701

DISC GROUP NO. 018 - FRONT. CHOOSE YOUR PREFERRED STYLE:

Type	Solid	OD	11.8" / 300mm
Color /Finish	Natural	Thickness	0.196" / 5mm
Bobbins	None	Bore	2.22" / 56.4mm



VR530
Fits EBC Pads: 296, 638, 640

Type	Floating	OD	11.8" / 300mm
Color /Finish	Polished	Thickness	0.196" / 5mm
Bobbins	5	Bore	2.22" / 56.4mm

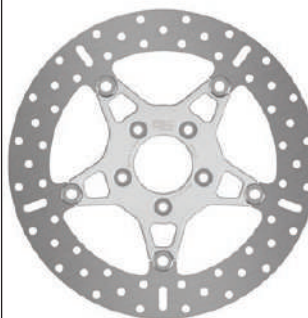

MD530
Fits EBC Pads: 296, 638, 640

Type	Floating	OD	11.8" / 300mm
Color /Finish	Black	Thickness	0.196" / 5mm
Bobbins	5	Bore	2.22" / 56.4mm

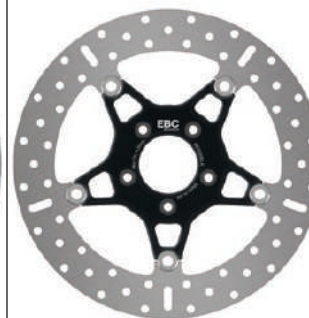

MD530BLK
Fits EBC Pads: 296, 638, 640

Type	Floating	OD	11.8" / 300mm
Color /Finish	Black	Thickness	0.196" / 5mm
Bobbins	5	Bore	2.22" / 56.4mm



VR530BLK
Fits EBC Pads: 296, 638, 640

DISC GROUP NO. 018 - FRONT (CONTD). CHOOSE YOUR PREFERRED STYLE:

Type	Solid	OD	11.41" / 290mm
Color /Finish	Natural	Thickness	0.2" / 5.2mm
Bobbins	None	Bore	2.22" / 56.4mm



MD531
Fits EBC Pads: 643

Type	Solid	OD	10.23" / 260mm
Color /Finish	Natural	Thickness	0.2" / 5.6mm
Bobbins	None	Bore	2.22" / 56.4mm



MD532
Fits EBC Pads: 643

DISC GROUP NO. 019 - FRONT/REAR. CHOOSE YOUR PREFERRED STYLE:

Type	Solid	OD	11.77" / 299mm
Color /Finish	Black	Thickness	0.82" / 21mm
Bobbins	None	Bore	2.67" / 68mm



MD533
Fits EBC Pads: 669/4, 670

Type	Solid	OD	11.77" / 299mm
Color /Finish	Black	Thickness	0.82" / 21mm
Bobbins	None	Bore	2.67" / 68mm



MD533BSDL
Fits EBC Pads: 669/4, 670

Type	Solid	OD	11.77" / 299mm
Color /Finish	Black	Thickness	0.82" / 21mm
Bobbins	None	Bore	2.67" / 68mm



MD533BSDLR
Fits EBC Pads: 669/4, 670

DISC GROUP NO. 020 - FRONT/REAR. CHOOSE YOUR PREFERRED STYLE:

Type	Solid	OD	11.73" / 298mm
Color /Finish	Natural	Thickness	0.196" / 5mm
Bobbins	None	Bore	2.52" / 64.2mm

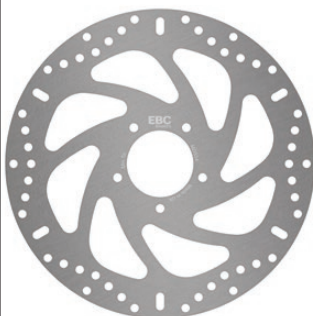

MD534
Fits EBC Pads: 209/2, 213, 377, 672

Type	Floating	OD	11.73" / 298mm
Color /Finish	Gold	Thickness	0.196" / 5mm
Bobbins	10	Bore	2.52" / 64.2mm

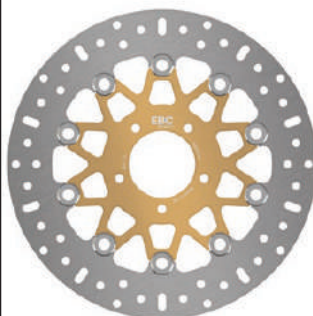

MD534X
Fits EBC Pads: 209/2, 213, 377, 672

Type	Floating	OD	11.73" / 298mm
Color /Finish	Black	Thickness	0.196" / 5mm
Bobbins	10	Bore	2.52" / 64.2mm



VR534BLK
Fits EBC Pads: 209/2, 213, 377, 672

DISC GROUP NO. 021 - FRONT/REAR. CHOOSE YOUR PREFERRED STYLE:

Type	Floating	OD	11.5" / 292mm	Type	Floating	OD	11.5" / 292mm	Type	Floating	OD	11.5" / 292mm
Color /Finish	Polished	Thickness	0.196" / 5mm	Color /Finish	Black	Thickness	0.196" / 5mm	Color /Finish	Black	Thickness	0.196" / 5mm
Bobbins	5	Bore	2.22" / 56.4mm	Bobbins	5	Bore	2.22" / 56.4mm	Bobbins	5	Bore	2.22" / 56.4mm

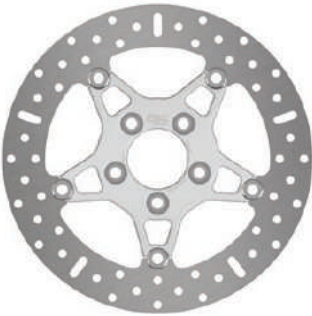

MD535
Fits EBC Pads: 95, 696



MD535BLK
Fits EBC Pads: 95, 696



VR535BLK
Fits EBC Pads: 95, 696

DISC GROUP NO. 022 - FRONT. CHOOSE YOUR PREFERRED STYLE:

Type	Solid	OD	11.8" / 300mm	Type	Solid	OD	11.8" / 300mm	Type	Floating	OD	11.8" / 300mm
Color /Finish	Natural	Thickness	0.236" / 6mm	Color /Finish	Natural	Thickness	0.236" / 6mm	Color /Finish	Polished	Thickness	0.236" / 6mm
Bobbins	None	Bore	2.22" / 56.4mm	Bobbins	None	Bore	2.22" / 56.4mm	Bobbins	5	Bore	2.22" / 56.4mm



MD536
Fits EBC Pads: 209/2



VR536
Fits EBC Pads: 209/2

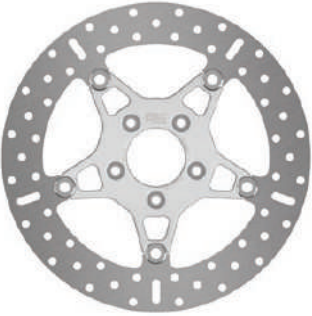

MD536X
Fits EBC Pads: 209/2



MD536XBLK
Fits EBC Pads: 209/2

DISC GROUP NO. 023 - REAR. CHOOSE YOUR PREFERRED STYLE:

Type	Solid	OD	11.8" / 300mm	Type	Solid	OD	11.8" / 300mm	Type	Floating	OD	11.8" / 300mm
Color /Finish	Natural	Thickness	0.236" / 6mm	Color /Finish	Natural	Thickness	0.236" / 6mm	Color /Finish	Polished	Thickness	0.236" / 6mm
Bobbins	None	Bore	2.22" / 56.4mm	Bobbins	None	Bore	2.22" / 56.4mm	Bobbins	5	Bore	2.22" / 56.4mm



MD537
Fits EBC Pads: 181



VR537
Fits EBC Pads: 181

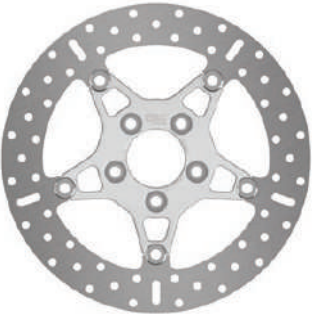

MD537X
Fits EBC Pads: 181



MD537XBLK
Fits EBC Pads: 181

DISC GROUP NO. 024 - FRONT/REAR. CHOOSE YOUR PREFERRED STYLE:

Type	Floating	OD	11.77" / 299mm	Type	Floating	OD	11.77" / 299mm	Type	Floating	OD	11.77" / 299mm
Color /Finish	Natural	Thickness	0.196" / 5mm	Color /Finish	Black	Thickness	0.196" / 5mm	Color /Finish	Black	Thickness	0.196" / 5mm
Bobbins	10	Bore	2.52" / 64.2mm	Bobbins	10	Bore	2.52" / 64.2mm	Bobbins	10	Bore	2.52" / 64.2mm

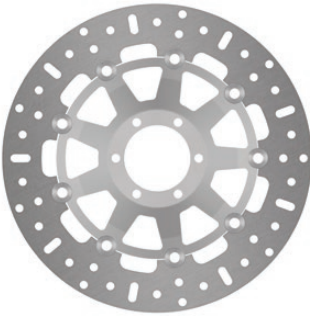

MD678
Fits EBC Pads: 196, 209/2, 244, 347

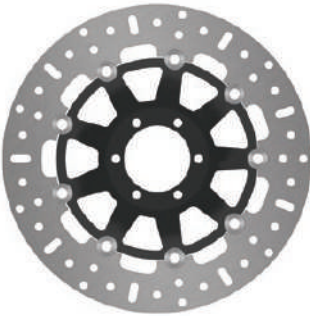

MD678BLK
Fits EBC Pads: 196, 209/2, 244, 347

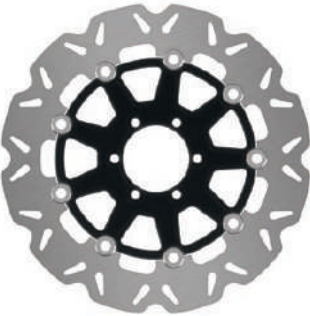

VR678BLK
Fits EBC Pads: 196, 209/2, 244, 347

DISC GROUP NO. 025 - REAR. CHOOSE YOUR PREFERRED STYLE:

Type	Floating	OD	11.77" / 299mm	Type	Floating	OD	11.77" / 299mm
Color /Finish	Black	Thickness	0.275" / 7mm	Color /Finish	Black	Thickness	0.275" / 7mm
Bobbins	9	Bore	2.52" / 64.2mm	Bobbins	9	Bore	2.52" / 64.2mm



MD887BLK
Fits EBC Pads: 196



VR887BLK
Fits EBC Pads: 196

DISC GROUP NO. 026 - FRONT/REAR. CHOOSE YOUR PREFERRED STYLE:

Type	Floating	OD	11.77" / 299mm	Type	Floating	OD	11.77" / 299mm
Color /Finish	Natural	Thickness	0.196" / 5mm	Color /Finish	Black	Thickness	0.196" / 5mm
Bobbins	9	Bore	1.99" / 50.6mm	Bobbins	9	Bore	1.99" / 50.6mm

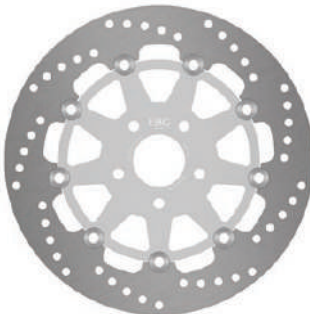

MD727
Fits EBC Pads: 209/2, 244

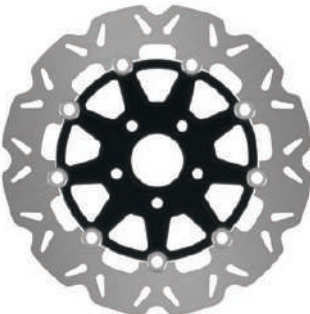

VR727BLK
Fits EBC Pads: 209/2, 244

DISC GROUP NO. 027 - FRONT. CHOOSE YOUR PREFERRED STYLE:

Type	Solid	OD	9.84" / 250mm
Color /Finish	Natural	Thickness	0.236" / 6mm
Bobbins	None	Bore	2.606" / 66.2mm

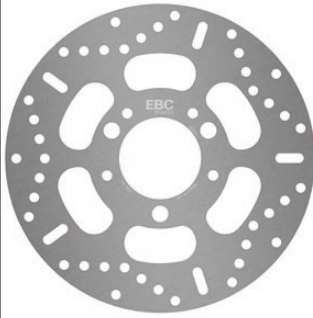

MD801
Fits EBC Pads: 474

Type	Solid	OD	9.84" / 250mm
Color /Finish	Natural	Thickness	0.236" / 6mm
Bobbins	None	Bore	2.606" / 66.2mm



VR801
Fits EBC Pads: 474

DISC GROUP NO. 028 - REAR. CHOOSE YOUR PREFERRED STYLE:

Type	Solid	OD	9.84" / 250mm
Color /Finish	Natural	Thickness	0.236" / 6mm
Bobbins	None	Bore	2.606" / 66.2mm



MD802
Fits EBC Pads: 473

Type	Solid	OD	9.84" / 250mm
Color /Finish	Natural	Thickness	0.236" / 6mm
Bobbins	None	Bore	2.606" / 66.2mm



VR802
Fits EBC Pads: 473

DISC GROUP NO. 029 - FRONT. CHOOSE YOUR PREFERRED STYLE:

Type	Solid	OD	10.6" / 270mm
Color /Finish	Natural	Thickness	0.275" / 7mm
Bobbins	None	Bore	2.46" / 62.6mm

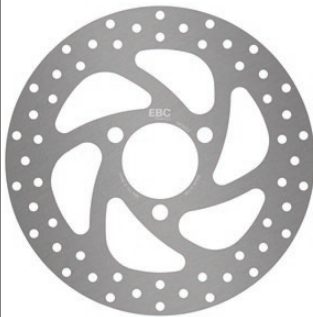

MD853
Fits EBC Pads: 630

Type	Solid	OD	10.6" / 270mm
Color /Finish	Natural	Thickness	0.275" / 7mm
Bobbins	None	Bore	2.46" / 62.6mm



VR853
Fits EBC Pads: 630

DISC GROUP NO. 030 - REAR. CHOOSE YOUR PREFERRED STYLE:

Type	Solid	OD	10.6" / 270mm
Color /Finish	Natural	Thickness	0.275" / 7mm
Bobbins	None	Bore	2.46" / 62.6mm



MD854
Fits EBC Pads: 631

Type	Solid	OD	10.6" / 270mm
Color /Finish	Natural	Thickness	0.275" / 7mm
Bobbins	None	Bore	2.46" / 62.6mm



VR854
Fits EBC Pads: 631

DISC GROUP NO. 031 - FRONT. CHOOSE YOUR PREFERRED STYLE:

Type	Solid	OD	12.59" / 320mm
Color /Finish	Natural	Thickness	0.196" / 5mm
Bobbins	None	Bore	8.86" / 225mm

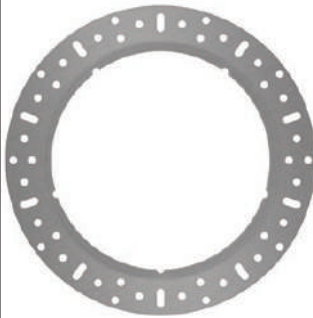

MD737
Fits EBC Pads: 196

Type	Solid	OD	12.59" / 320mm
Color /Finish	Natural	Thickness	0.196" / 5mm
Bobbins	None	Bore	8.86" / 225mm

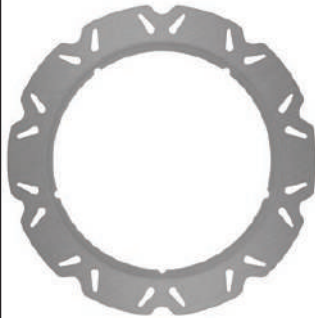

VR737
Fits EBC Pads: 196

DISC GROUP NO. 032 - REAR. CHOOSE YOUR PREFERRED STYLE:

Type	Solid	OD	8.66" / 220mm
Color /Finish	Natural	Thickness	0.196" / 5mm
Bobbins	None	Bore	1.99" / 50.6mm



MD738
Fits EBC Pads: 140

Type	Solid	OD	8.66" / 220mm
Color /Finish	Natural	Thickness	0.196" / 5mm
Bobbins	None	Bore	1.99" / 50.6mm



VR738
Fits EBC Pads: 140

MD509SR

Type	Solid	OD	10.67" / 271mm
Color /Finish	Natural	Thickness	0.3" / 7mm
Bobbins	None	Bore	4" / 101.8mm



MD509SR
Fits EBC Pads: 201

MD515

Type	Solid	OD	11.5" / 292mm
Color /Finish	Natural	Thickness	0.23" / 5.8mm
Bobbins	None	Bore	4" / 101.4mm

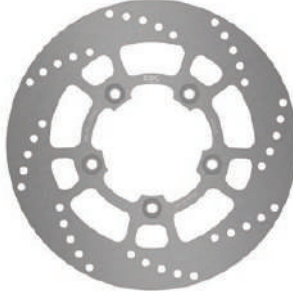

MD515
Fits EBC Pads: 400

MD522

Type	Solid	OD	9.44" / 240mm
Color /Finish	Natural	Thickness	0.196" / 5mm
Bobbins	None	Bore	2.77" / 70.6mm

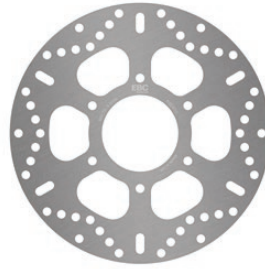

MD522
Fits EBC Pads: 140

MD531

Type	Solid	OD	11.41" / 290mm
Color /Finish	Natural	Thickness	0.2" / 5.2mm
Bobbins	None	Bore	2.22" / 56.4mm



MD531
Fits EBC Pads: 643

MD532

Type	Solid	OD	10.23" / 260mm
Color /Finish	Natural	Thickness	0.2" / 5.6mm
Bobbins	None	Bore	2.22" / 56.4mm



MD532
Fits EBC Pads: 643

MD538

Type	Solid	OD	10.67" / 270.5mm
Color /Finish	Black	Thickness	0.25" / 6.35mm
Bobbins	None	Bore	4.311" / 109.5mm



MD538
Fits EBC Pads: 641/4

MD540

Type	Solid	OD	8.97" / 228mm
Color /Finish	Black	Thickness	0.248" / 6.3mm
Bobbins	None	Bore	6.783" / 172.3mm



MD540
Fits EBC Pads: 605/4

MD689

Type	Solid	OD	9.05" / 230mm
Color /Finish	Natural	Thickness	0.177" / 4.5mm
Bobbins	None	Bore	3.433" / 87.2mm

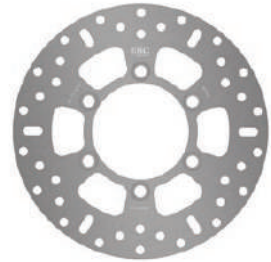

MD689
Fits EBC Pads: 86

MD690

Type	Floating	OD	11.77" / 299mm
Color /Finish	Gold	Thickness	0.157" / 4mm
Bobbins	9	Bore	2.527" / 64.2mm

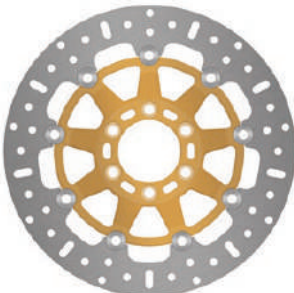

MD690
Fits EBC Pads: 86

MD690C

Type	Floating	OD	11.77" / 299mm
Color /Finish	Gold	Thickness	0.157" / 4mm
Bobbins	9	Bore	2.527" / 64.2mm

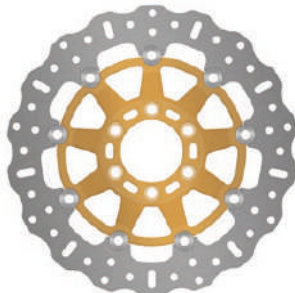

MD690C
Fits EBC Pads: 86

MD691

Type	Floating	OD	11.81" / 300mm
Color /Finish	Gold	Thickness	0.157" / 4mm
Bobbins	6	Bore	5.126" / 130.2mm

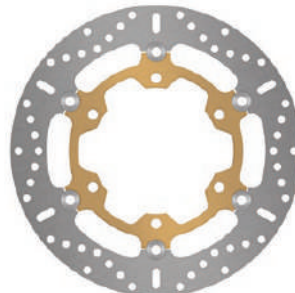

MD691
Fits EBC Pads: 86

MD719RS

Type	Floating	OD	13.38" / 340mm
Color /Finish	Natural	Thickness	0.196" / 5mm
Bobbins	9	Bore	2.385" / 60.6mm

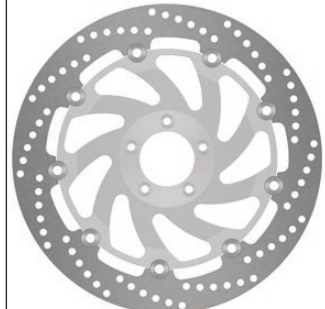

MD719RS
Fits EBC Pads: 210, 424

MD734RS MD735RS MD803

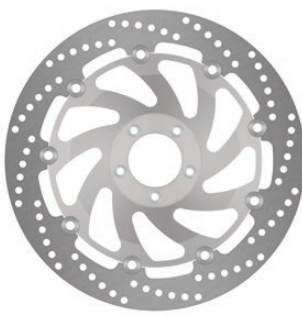
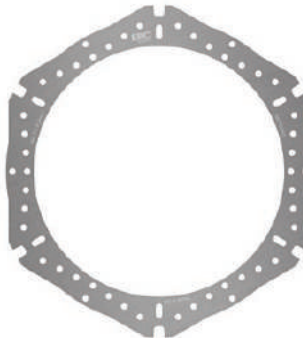
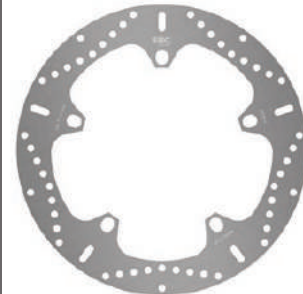
<table border="1" style="width: 100%; border-collapse: collapse;"> <tr><td>Type</td><td>Floating</td><td>OD</td><td>13.38" / 340mm</td></tr> <tr><td>Color /Finish</td><td>Natural</td><td>Thickness</td><td>0.196" / 5mm</td></tr> <tr><td>Bobbins</td><td>9</td><td>Bore</td><td>2.385" / 60.6mm</td></tr> </table>  <p>MD734RS Fits EBC Pads: 424</p>	Type	Floating	OD	13.38" / 340mm	Color /Finish	Natural	Thickness	0.196" / 5mm	Bobbins	9	Bore	2.385" / 60.6mm	<table border="1" style="width: 100%; border-collapse: collapse;"> <tr><td>Type</td><td>Solid</td><td>OD</td><td>14.76" / 375mm</td></tr> <tr><td>Color /Finish</td><td>Natural</td><td>Thickness</td><td>0.196" / 5mm</td></tr> <tr><td>Bobbins</td><td>None</td><td>Bore</td><td>12" / 307mm</td></tr> </table>  <p>MD735RS Fits EBC Pads: 345, 454/4</p>	Type	Solid	OD	14.76" / 375mm	Color /Finish	Natural	Thickness	0.196" / 5mm	Bobbins	None	Bore	12" / 307mm	<table border="1" style="width: 100%; border-collapse: collapse;"> <tr><td>Type</td><td>Solid</td><td>OD</td><td>12.6" / 320mm</td></tr> <tr><td>Color /Finish</td><td>Natural</td><td>Thickness</td><td>0.177" / 4.5mm</td></tr> <tr><td>Bobbins</td><td>None</td><td>Bore</td><td>7.106" / 180.5mm</td></tr> </table>  <p>MD803 Fits EBC Pads: 630</p>	Type	Solid	OD	12.6" / 320mm	Color /Finish	Natural	Thickness	0.177" / 4.5mm	Bobbins	None	Bore	7.106" / 180.5mm	
Type	Floating	OD	13.38" / 340mm																																				
Color /Finish	Natural	Thickness	0.196" / 5mm																																				
Bobbins	9	Bore	2.385" / 60.6mm																																				
Type	Solid	OD	14.76" / 375mm																																				
Color /Finish	Natural	Thickness	0.196" / 5mm																																				
Bobbins	None	Bore	12" / 307mm																																				
Type	Solid	OD	12.6" / 320mm																																				
Color /Finish	Natural	Thickness	0.177" / 4.5mm																																				
Bobbins	None	Bore	7.106" / 180.5mm																																				

MD890BLK VR890BLK MD8007 MD1187C

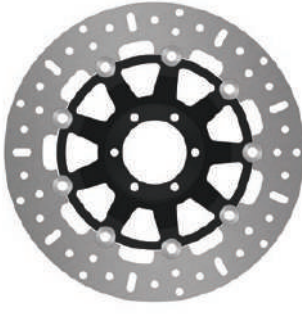
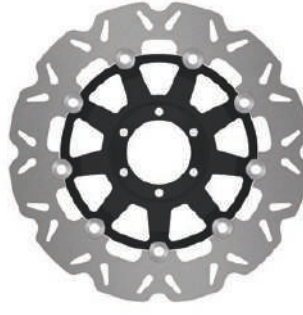
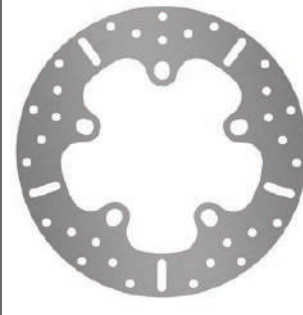
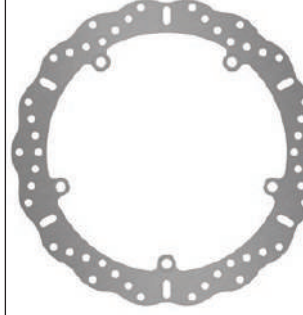
<table border="1" style="width: 100%; border-collapse: collapse;"> <tr><td>Type</td><td>Floating</td><td>OD</td><td>11.77" / 299mm</td></tr> <tr><td>Color /Finish</td><td>Black</td><td>Thickness</td><td>0.196" / 5mm</td></tr> <tr><td>Bobbins</td><td>10</td><td>Bore</td><td>2.527" / 64.2mm</td></tr> </table>  <p>MD890BLK Fits EBC Pads: 196, 261, 347</p>	Type	Floating	OD	11.77" / 299mm	Color /Finish	Black	Thickness	0.196" / 5mm	Bobbins	10	Bore	2.527" / 64.2mm	<table border="1" style="width: 100%; border-collapse: collapse;"> <tr><td>Type</td><td>Floating</td><td>OD</td><td>11.77" / 299mm</td></tr> <tr><td>Color /Finish</td><td>Black</td><td>Thickness</td><td>0.196" / 5mm</td></tr> <tr><td>Bobbins</td><td>10</td><td>Bore</td><td>2.527" / 64.2mm</td></tr> </table>  <p>VR890BLK Fits EBC Pads: 196, 261, 347</p>	Type	Floating	OD	11.77" / 299mm	Color /Finish	Black	Thickness	0.196" / 5mm	Bobbins	10	Bore	2.527" / 64.2mm	<table border="1" style="width: 100%; border-collapse: collapse;"> <tr><td>Type</td><td>Solid</td><td>OD</td><td>10.24" / 260mm</td></tr> <tr><td>Color /Finish</td><td>Natural</td><td>Thickness</td><td>0.196" / 5mm</td></tr> <tr><td>Bobbins</td><td>None</td><td>Bore</td><td>4.63" / 117.6mm</td></tr> </table>  <p>MD8007 Fits EBC Pads: FA266</p>	Type	Solid	OD	10.24" / 260mm	Color /Finish	Natural	Thickness	0.196" / 5mm	Bobbins	None	Bore	4.63" / 117.6mm	<table border="1" style="width: 100%; border-collapse: collapse;"> <tr><td>Type</td><td>Solid</td><td>OD</td><td>12.6" / 320mm</td></tr> <tr><td>Color /Finish</td><td>Natural</td><td>Thickness</td><td>0.196" / 5mm</td></tr> <tr><td>Bobbins</td><td>None</td><td>Bore</td><td>8.35" / 212.2mm</td></tr> </table>  <p>MD1187C Fits EBC Pads: 209/2</p>	Type	Solid	OD	12.6" / 320mm	Color /Finish	Natural	Thickness	0.196" / 5mm	Bobbins	None	Bore	8.35" / 212.2mm
Type	Floating	OD	11.77" / 299mm																																																
Color /Finish	Black	Thickness	0.196" / 5mm																																																
Bobbins	10	Bore	2.527" / 64.2mm																																																
Type	Floating	OD	11.77" / 299mm																																																
Color /Finish	Black	Thickness	0.196" / 5mm																																																
Bobbins	10	Bore	2.527" / 64.2mm																																																
Type	Solid	OD	10.24" / 260mm																																																
Color /Finish	Natural	Thickness	0.196" / 5mm																																																
Bobbins	None	Bore	4.63" / 117.6mm																																																
Type	Solid	OD	12.6" / 320mm																																																
Color /Finish	Natural	Thickness	0.196" / 5mm																																																
Bobbins	None	Bore	8.35" / 212.2mm																																																

MD6435C

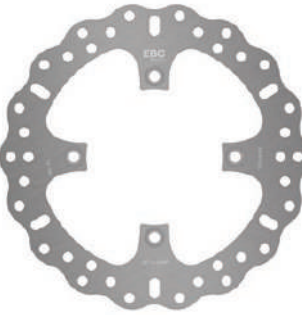
<table border="1" style="width: 100%; border-collapse: collapse;"> <tr><td>Type</td><td>Solid</td><td>OD</td><td>9.44" / 240mm</td></tr> <tr><td>Color /Finish</td><td>Natural</td><td>Thickness</td><td>0.157" / 4mm</td></tr> <tr><td>Bobbins</td><td>None</td><td>Bore</td><td>4.141" / 105.2mm</td></tr> </table>  <p>MD6435C Fits EBC Pads: 83, 181, 185, 208, 209/2, 213, 264, 367</p>	Type	Solid	OD	9.44" / 240mm	Color /Finish	Natural	Thickness	0.157" / 4mm	Bobbins	None	Bore	4.141" / 105.2mm			
Type	Solid	OD	9.44" / 240mm												
Color /Finish	Natural	Thickness	0.157" / 4mm												
Bobbins	None	Bore	4.141" / 105.2mm												

JAPANESE Built Motorcycles



HONDA



DISC PAD CHOICES - FRONT

BRAKE DISC CHOICES - FRONT

R Suffix = High Durability Sintered Pad. **HH** Suffix = High Performance Sintered Pad. **TT** Suffix = Hard Wearing Off Road Pad. **V** Suffix = Semi Sintered Pad. **G** Suffix = Grooved Shoe.

D Suffix = Drilled Disc. **X** Suffix = Universal Left or Right Disc. **XC** Suffix = Contoured Disc. **LS** Suffix = Left/Steel Disc. **RS** = Right/Steel Disc.

FRONT / AVANT / VORN / FRENTE / ANTERIORE

		FA, SFA, TT Pad or Brake Shoe	SFAC Carbon Scooter Pads	Speciality Pads - SXR / Vee / MXS	Sintered/HH Pads/ Grooved Shoes	Left / Gauche / Links Standard Replacement Disc	Right / Droite / Rechts Standard Replacement Disc	Contour Disc Universal left and right fitment	Custom Disc Universal left and right fitment	Vee-Discs Black † See note below	CX Extreme MX Race Disc/ UTVX Disc	Line #
C 50 All Models	75-93	H303										1
C 50 N (Single seat model)	95	H303										2
C 50 P/S/V/X/Y/1/2 (Single seat model)	96-02	H303										3
CB 50 J	81	FA040										4
CB 50 V/W Dream 50	97-98	FA197			FA197HH							5
CD 50 ST/SV/SW/SX Benley 50 S	96-99	H304										6
CF 50 Chaly	79	H303										7
CHF 50-1/Scoopy 50 (Drum brake model)	01-05	H333										8
CL 50 V/X Benley CL50	97-99	H304										9
CR 50 RE/RF	84-85	H333			H333G							10
CRF 50 F	04-21	H301										11
CRM 50 RN/RP/RR/RT	93-96	FA125TT		MXS125	FA125R	MD6001D		MD6001C			MD6001CX	12
MB 5 S	80-82	SFA054	SFAC054		FA054HH							13
MBX 50 SD/SF	83-85	FA086			FA086HH							14
MG 50 S/X/1/3 Magna 50 (AC13-)	95-03	SFA054	SFAC054	MXS054	FA054HH							15
MP 50 3/DX3 (AC17) Solo	03	H304										16
MRX 50	88-	FA054TT										17
MT 50 SA/SE/SG/SJ/SL	80-93	H304			H304G							18
MTX 50 SC	83-84	H304			H304G							19
NB 50 ME Aero	84	H301										20
NB 50 MF/MG/TH Vision	86-88	H301										21
NC 50 K1/Z Express	79-82	H301										22
NC 50 C Express 2	82	H301										23
NC 50 A/B Express 3 Delux	82	H301										24
NCX 50 E/G/J - Dunk 50	14-17	SFA708				MD923D						25
NE 50 MF/MG Vision	86-87	H301										26
NH 50 Lead 50 SS	84	SFA176										27
NH 50 Lead AF01/D716	84-85	SFA176										28
NJ 50 MDY/M2/MD2 (TD01) Gyro-X	00-02	H333										29
NP 50 D Melody Mini	83	H301										30
NPC 50 2/3 (AF59) Bite	02-03	H333										31
NPS 50 1/2/3/5/6/7/8/9 (AF58) Zoomer	01-21	H333										32
NS 50 Melody	82	H301										33
NS 50 MSB Melody Delux	82	H301										34
NSC 50 WHC/T2E/F - Vision 50 14 Inch Wheels	12-16	SFA603	SFAC603		SFA603HH	MD9134D				VR9134		35
NSC 50 MPDC/E/F/G/H/J - Vision 50 16 Inch Wheels	12-18	SFA603	SFAC603		SFA603HH	MD9134D				VR9134		36
NSC 50 R - 14 Inch Wheels	12-16	SFA603	SFAC603		SFA603HH	MD9134D				VR9134		37
NSR 50 FP/FR/FS	93-95	FA086			FA086HH							38
NSR 50 RV/RW/RX/RV	97-00	FA197			FA197HH		MD1142RS					39
NSR 50 SK/SP/SR/SS	89-95	FA086										40
NSR 50 V (AC10-180)	97	FA197			FA197HH			MD1169C				41
NSR 50 V (AC10-180) - Floating disc option	97	FA197			FA197HH			MD1169CF				42
NSR 50 X (AC10-190)	99	FA197			FA197HH			MD1169C				43
NSR 50 X (AC10-190) - Floating disc option	99	FA197			FA197HH			MD1169CF				44
NT 50 F/G/H Melody Mini	85-87	H301										45
NU 50 MC Runaway	82	H333										46
NV 50 MSD Stream	84	H302										47
NVS 50 1SH2/Today 50	01-05	H333										48
NX 50 A/B/MB Caren	80-82	H301										49
PA 50 Camino (Spoke wheels)	79-86	H322										50
PA 50 Camino (Cast wheels)	88-89	H335										51
PC 50 K1	79	H301										52
PF 50 M Novio	75	H322										53
PK 50 Wallaro All models	90-01	H333										54
PX 50	82-83	H322										55
PXR 50	84	H322										56
SA 50 J/MP/R/S Vision Metin	88-95	H333										57
SFX 50 S/T/V/W/X/Y/1	95-04	SFA193	SFAC193		SFA193HH	MD906D				VR906		58
SGX 50 V/W/X/Y/1 Sky/Sky Deluxe	97-03	SFA193	SFAC193		SFA193HH	MD931D				VR931		59
												60

*-2 Sets Required. † For Vee disc colours add RED, BLU, GRN, GLD, ORG suffix to part number. For Custom Finish Options for Vee-Rotors™ including Splatter discs add suffix CHR, CHGR, CHBL, CHBR - available in various colours see page iv. ☼ - Also available as a Vintage Motorcycle Disc.

JAPANESE Built Motorcycles

Line #	BRAKE DISC CHOICES - FRONT						DISC PAD CHOICES - REAR				BRAKE DISC CHOICES - REAR			
	Oversize 250 /280mm Disc Kit	OSX Oversize 250/280mm Disc Kit	Relocating Bracket for 250/ 280mm Disc	Oversize 320mm Disc Kit	SMX Oversize 320mm Disc Kit	Relocating Bracket for 320mm Disc	FA, SFA, TT Pad or Brake Shoe	SFAC Carbon Scooter Pads	Speciality Pads - SXR / Vee / MXS	Sintered/ HH Pads/ Grooved Shoes	Standard Replacement Disc	Contour Disc Rear fitment	Vee Discs CONTOUR	CX Extreme MX Race Disc
1							H303							
2							H304							
3							H304							
4							H304							
5							FA131TT							
6							H304							
7							H303							
8							H333							
9							H304							
10							H333		H333G					
11							H301							
12							H304							
13							H304							
14							H304							
15							H304							
16							H304							
17							H304							
18							H304		H304G					
19							H304		H304G					
20							H302							
21							H302							
22							H301							
23							H302							
24							H302							
25							H353							
26							H302							
27							H302							
28							H302							
29							H333*							
30							H302							
31							H333							
32							H333							
33							H302							
34							H302							
35							H352							
36							H352							
37							H352							
38							H304							
39							SFA131/3		SFA131/3HH	MD1143				
40							H304							
41							SFA131/3		SFA131/3HH		MD1170C			
42							SFA131/3		SFA131/3HH		MD1170C			
43							SFA131/2		SFA131/2HH		MD1170C			
44							SFA131/2		SFA131/2HH		MD1170C			
45							H301							
46							H302							
47							H302							
48														
49							H302							
50							H322							
51							H335							
52							H301							
53							H322							
54							H303							
55							H302							
56							H337							
57							H334							
58							H333							
59							H303							
60							H303							

REAR / ARRIÈRE / HINTEN / POSTERIOR / POSTERIORE

R Suffix = High Durability Sintered Pad. **HH** Suffix = High Performance Sintered Pad. **TT** Suffix = Hard Wearing Off Road Pad. **V** Suffix = Semi Sintered Pad. **G** Suffix = Grooved Shoe.
D Suffix = Drilled Disc. **X** Suffix = Universal Left or Right Disc. **XC** Suffix = Contoured Disc. **LS** Suffix = Left/Steel Disc. **RS** = Right/Steel Disc.

BRAKE APPLICATIONS

*-2 Sets Required. † For Vee disc colours add RED, BLU, GRN, GLD, ORG suffix to part number. For Custom Finish Options for Vee-Rotors™ including Splatter discs add suffix CHR, CHGR, CHBL, CHBR - available in various colours see page iv. Ⓢ - Also available as a Vintage Motorcycle Disc.

JAPANESE Built Motorcycles



HONDA Contd.



DISC PAD CHOICES - FRONT

BRAKE DISC CHOICES - FRONT

R Suffix = High Durability Sintered Pad. **HH** Suffix = High Performance Sintered Pad. **TT** Suffix = Hard Wearing Off Road Pad. **V** Suffix = Semi Sintered Pad. **G** Suffix = Grooved Shoe.

D Suffix = Drilled Disc. **X** Suffix = Universal Left or Right Disc. **XC** Suffix = Contoured Disc. **LS** Suffix = Left/Steel Disc. **RS** = Right/Steel Disc.

FRONT / AVANT / VORN / FRENTE / ANTERIORE

		FA, SFA, TT Pad or Brake Shoe	SFAC Carbon Scooter Pads	Speciality Pads - SXR / Vee / MXS	Sintered/HH Pads/ Grooved Shoes	Left / Gauche / Links Standard Replacement Disc	Right / Droite / Rechts Standard Replacement Disc	Contour Disc Universal left and right fitment	Custom Disc Universal left and right fitment	Vee-Discs Black † See note below	CX Extreme MX Race Disc/ UTVX Disc	Line #
SH 50 E/H/K/M/P/DP City Express	85-96	H303										1
SH 50 T Fifty/Scoopy W/X/Y/1	97-03	SFA193	SFAC193		SFA193HH	MD918D						2
SJ 50 P/R/S/T/W/X Bali	93-99	SFA256	SFAC256		SFA256HH	MD923D				VR923		3
SK 50 MM/MM-YA/MM-YC/MN/MN-YA/MN-YB/MP /MP-YA/MMR/MMT (AF27) DIO Drum Front & Rear		H333										4
SK 50 MM-II/MM-YD/MN-II/MP-II (AF28) DIO SR		SFA257	SFAC257			MD919D						5
SK 50 MNIII/MPIII/MP-IV (AF28) DIO-ZX		SFA257	SFAC257			MD919D						6
SK 50 MR-II/MMT-II DIO XR (AF28)		SFA257	SFAC257			MD919D						7
SN 50 N/R/S Giorno	94	H333										8
SS 50 ZK2	75-77	H303										9
SS 50 ZB2	77-80	FA040										10
SRX 50 T/W/X Joker/Shadow	97-99	SFA131/3			SFA131/3HH	MD931D				VR931		11
ST 50 J/K Dax	78-93	H303										12
SXR 50 W/SW/X/SX	98-99	SFA193	SFAC193		SFA193HH	MD906D				VR906		13
X8R-S Super Sport Scooter (SZX 50 SW/SX/SY/S1)	98-04	SFA193	SFAC193		SFA193HH	MD920D				VR920		14
X8R-X Cross Sport Scooter (SZX 50 XW/XX/XY/X1)	98-04	SFA193	SFAC193		SFA193HH	MD920D				VR920		15
Tact 50		SFA257	SFAC257									16
TC 50 M/P/V Gyro Canopy (TA02)	96-00	H303										17
TC 50 Y/2 (TA02) Gyro Canopy	00-02	H304										18
TLM 50 F	85	H333			H333G							19
QR 50 D/E/F	83-87	H301										20
QR 50 M/R/V/W/Y	93-03	H301										21
XR 50 R1/R2/R3	01-03	H301										22
XR 50 M5 (AD14) Motard	05	FA197			FA197HH							23
XZ 50 1/2 APE-AC16	01-02	H304										24
Z 50 R All Models	79-86	H301										25
CR 60 RF/RG	85-86	H333			H333G							26
ATC 70 All Models	78-85	None										27
C 70 All Models	75-85	H303										28
CF 70 C	77-78	H303										29
CRF 70 F4/F5/F6/F7/F8/F9/FA/FB/FC/FD	04-13	H333			H333G							30
TRX 70 Fourtrax	86-87	H346*			H346G*							31
XR 70 RV/RW/RX/RV/R1/R2/R3	97-03	H333			H333G							32
CRM 75 RK/RL/RM/RP/RR	89-94	FA125TT		MXS125	FA125R	MD6001D		MD6001C			MD6001CX	33
NF 75	79	H303										34
NSR 75 N/P/R/X/Y (NS-1)	92-00	FA197			FA197HH		MD1142RS					35
SA 75 Vision	89-	H303										36
SH 75 Scoopy H/K/M/P/DP/S/DS	87-95	H303										37
XR 75 K4	75-78	H304			H304G							38
XR 75 K5	79	H303			H303G							39
CR 80 RA/RB	80-81	H304			H304G							40
CR 80 RC	82	H304			H304G							41
CR 80 RD/RE	83-84	H333			H333G							42
CR 80 RF	85	H333			H333G							43
CR 80 R2F/R2G	85-86	H304			H304G							44
CR 80 RG/RH/RJ/RK/RL/RM	86-91	FA084TT		MXS084	FA084R	MD6004D						45
CR 80 RV/RP/RR/RS	92-95	FA084TT		MXS084	FA084R	MD6004D						46
CR 80 RT/RBT/RV/RBV/RW/RBW/RX/RBX/RV/RBY /R1/RB1/R2/RB2	96-02	FA084TT		MXS084	FA084R	MD6058D		MD6058C			MD6058CX	47
CRE 80	98-	FA084TT		MXS084	FA084R	MD6058D		MD6058C			MD6058CX	48
CRF 80 F4/F5/F6/F7/F8/F9/FB/FC/FD	04-13	H333			H333G							49
MB 80 (MB8)	80-	FA083/2TT										50
MBX 80 FWDD/FWDF	83-86	SFA054*	SFAC054*		FA054HH*							51
MCX 80	82-	FA083/2TT										52
MTX 80 RFD/RFF	83-84	H304			H304G							53
NH 80 MD-D/MD-G	83-86	H303										54
NH 80 Lead 80	85	SFA176										55
NH 80 Lead 80 SS	85	SFA176										56
NH 80 MDR	94-	H303										57
NSR 80 J-2/K/L/N (HC06)	88-92	FA086			FA086HH			MD1169C				58
												59
												60

*-2 Sets Required. † For Vee disc colours add RED, BLU, GRN, GLD, ORG suffix to part number. For Custom Finish Options for Vee-Rotors™ including Splatter discs add suffix CHR, CHGR, CHBL, CHBR - available in various colours see page iv. ☼ - Also available as a Vintage Motorcycle Disc.

JAPANESE Built Motorcycles

Line #	BRAKE DISC CHOICES - FRONT						DISC PAD CHOICES - REAR				BRAKE DISC CHOICES - REAR			
	Oversize 250 /280mm Disc Kit	OSX Oversize 250/280mm Disc Kit	Relocating Bracket for 250/ 280mm Disc	Oversize 320mm Disc Kit	SMX Oversize 320mm Disc Kit	Relocating Bracket for 320mm Disc	FA, SFA, TT Pad or Brake Shoe	SFAC Carbon Scooter Pads	Speciality Pads - SXR / Vee / MXS	Sintered/ HH Pads/ Grooved Shoes	Standard Replacement Disc	Contour Disc Rear fitment	Vee Discs CONTOUR	CX Extreme MX Race Disc
1							H336							
2							H303							
3							H303							
4														
5							H333							
6							H333							
7							H333							
8							H333							
9							H333							
10							H303							
11							H303							
12							H303							
13							H303							
14							H303							
15							SFA234			MD921D		VR921		
16							SFA234			MD921D		VR921		
17							H333		H333G					
18							H333							
19							H333							
20							H333		H333G					
21							H302							
22							H333							
23							H301							
24							FA131TT							
25							H304							
26							H301							
27							H333		H333G					
28							H310		H310G					
29							H303							
30							H303							
31							H333		H333G					
32							H306		H306G					
33							H333		H333G					
34							H304		H304G					
35							H303							
36							SFA131/2		SFA131/2HH	MD1143				
37							H333							
38							H336							
39							H303		H303G					
40							H303		H303G					
41							H304		H304G					
42							H333		H333G					
43							H333		H333G					
44							H338		H338G					
45							H304		H304G					
46							H338		H338G					
47							FA131TT	MXS131	FA131R	MD6005D	MD6005C			
48														
49	OS6058C	OSX6058	BRK026				FA131TT	MXS131	FA131R	MD6005D	MD6005C		MD6005CX	
50	OS6058C	OSX6058	BRK026				FA131TT	MXS131	FA131R	MD6005D	MD6005C		MD6005CX	
51							H333		H333G					
52							H304							
53							H304							
54							H304							
55							H304		H304G					
56							H302							
57							H302							
58							H333							
59							H333							
60							SFA131/3		SFA131/3HH		MD1170C			

REAR / ARRIÈRE / HINTEN / POSTERIOR / POSTERIORE

R Suffix = High Durability Sintered Pad. **HH** Suffix = High Performance Sintered Pad. **TT** Suffix = Hard Wearing Off Road Pad. **V** Suffix = Semi Sintered Pad. **G** Suffix = Grooved Shoe.
D Suffix = Drilled Disc. **X** Suffix = Universal Left or Right Disc. **XC** Suffix = Contoured Disc. **LS** Suffix = Left/Steel Disc. **RS** = Right/Steel Disc.

*-2 Sets Required. † For Vee disc colours add RED, BLU, GRN, GLD, ORG suffix to part number. For Custom Finish Options for Vee-Rotors™ including Splatter discs add suffix CHR, CHGR, CHBL, CHBR - available in various colours see page iv. ☉ - Also available as a Vintage Motorcycle Disc.

Part numbers, prefixes, suffixes, photos and illustrations shown in this catalogue are trademarks and/or copyrights of EBC Brakes or the trademark owner A C Freeman Investments Ltd and use without express written permission of the owners is punishable by law.

JAPANESE Built Motorcycles



HONDA Contd.



DISC PAD CHOICES - FRONT

BRAKE DISC CHOICES - FRONT

R Suffix = High Durability Sintered Pad. **HH** Suffix = High Performance Sintered Pad. **TT** Suffix = Hard Wearing Off Road Pad. **V** Suffix = Semi Sintered Pad. **G** Suffix = Grooved Shoe.

D Suffix = Drilled Disc. **X** Suffix = Universal Left or Right Disc. **XC** Suffix = Contoured Disc. **LS** Suffix = Left/Steel Disc. **RS** = Right/Steel Disc.

FRONT / AVANT / VORN / FRENTE / ANTERIORE

		FA, SFA, TT Pad or Brake Shoe	SFAC Carbon Scooter Pads	Speciality Pads - SXR / Vee / MXS	Sintered/HH Pads/ Grooved Shoes	Left / Gauche / Links Standard Replacement Disc	Right / Droite / Rechts Standard Replacement Disc	Contour Disc Universal left and right fitment	Custom Disc Universal left and right fitment	Vee-Disks Black † See note below	CX Extreme MX Race Disc/ UTVX Disc	Line #
NSR 80 J-2/K/L/N (HC06) - Floating disc option	88-92	FA086			FA086HH			MD1169CF				1
NSR 80 P/R/S (HC06)	93-95	FA197			FA197HH			MD1169C				2
NSR 80 P/R/S (HC06) - Floating disc option	93-95	FA197			FA197HH			MD1169CF				3
NSR 80 V (HC06-170)	97	FA197			FA197HH			MD1169C				4
NSR 80 V (HC06-170) - Floating disc option	97	FA197			FA197HH			MD1169CF				5
NSR 80 X (HC06-180)	99	FA197			FA197HH			MD1169C				6
NSR 80 X (HC06-180) - Floating disc option	99	FA197			FA197HH			MD1169CF				7
XR 80 Z/AB	80-81	H304			H304G							8
XR 80 R	87-88	H333			H333G							9
CR 85 R3/RB3/R4/RB4/R5/RB5/R6/RB6/R7/RB7	03-07	FA084TT		MXS084	FA084R	MD6058D		MD6058C			MD6058CX	10
C 90 All Models	75-92	H303										11
C 90 All Models	93-03	H304										12
EZ 90 Cub	91-95	H303										13
Lead 90	88-	SFA131/3			SFA131/3HH							14
NH 90 M/P/R Yuppy	91-94	SFA131/3			SFA131/3HH							15
SRX 90 Shadow T/W/X	97-99	SFA131/3			SFA131/3HH	MD931D						16
TRX 90 Fourtrax/Sportrax P/R/S/T/V/W/X/Y/1-6	93-06	H303*			H303G*							17
TRX 90 EX	07-08	H303*			H303G*							18
TRX 90 X9/XB/XC	09-21	H303*			H303G*							19
Astrea Supra NF 100	99	SFA197			FA197HH							20
Astrea Grand/Supra (Drum Model)	97-98	H303										21
CB 100 N	78-80	FA052										22
CRF 100 F4/F5/F6/F7/F8/F9/FA/FB/FC/FD	04-13	H333			H333G							23
H 100 A/SD/SG/SJ	82-92	H303										24
SCV 100-3/F5 Lead	03-08	H352										25
SH 100 T/W/X/Y/1 Scoopy	96-01	SFA193	SFAC193		SFA193HH	MD918D						26
SJ 100 T/W/X Bali Ex	96-99	SFA256	SFAC256		SFA256HH	MD923D				VR923		27
XL 100 All models	78-82	H304			H304G							28
XR 100 RP/RR/RS/RT/RV/RW/RX/R1-R3	93-03	H333			H333G							29
XR 100 M5 (HD13) Motard	05	FA197			FA197HH							30
XZ 100 2 APE-HC07	02	H304										31
ACB 110 CBB/CSB - Vario 110	10	SFA708				MD9134D				VR9134		32
ACD 110 CSB/SCB - Scoopy 110 Fi	11-16	SFA708				MD9134D				VR9134		33
ACC 110 SCB/SCC - ANC 110 Icon	11-12	SFA708				MD9134D				VR9134		34
AFS 110 2SHC/CSFF Wave	12-16	SFA625					MD9134D			VR9134		35
ATC 110 All models	79-84	None										36
CRF 110 F	13-21	H333			H333G							37
CT 110 A/B/C/D/K/M	80-88	H303										38
CT 110 P	89-04	H304										39
CT 110 X	05-09	H304										40
NSC 110 CSD/CSE - Spacy 110	12-14	SFA708				MD9134D				VR9134		41
NSC 110 CBFF/CBFH - Dio 110	15-17	SFA708				MD9134D				VR9134		42
NSC 110 WHB/E - Vision 110 14 Inch Wheels	11-16	SFA603	SFAC603		SFA603HH	MD9134D				VR9134		43
NSC 110 MPDC/E Vision (16 Inch Wheels)	12-14	SFA603	SFAC603		SFA603HH	MD9134D				VR9134		44
NSC 110 MPDH Vision (16 Inch Wheels)	17-18	SFA708				MD9134D				VR9134		45
SCR 110 Spacy	08-14	SFA721	SFAC721									46
SCV 110 Lead (NHX 110-WH8 - 3 Bolt Front Disc Fixing)	08-09	SFA323	SFAC323		SFA323HH	MD923D				VR923		47
SCV 110 Lead (NHX 110-WHA - 4 Bolt Front Disc Fixing)	10-12	SFA603	SFAC603		SFA603HH	MD9140D				VR9140		48
Zoomer 110	19-21	SFA723	SFAC723									49
ACA 125 CBFE - Air Blade 125	14-16	SFA708				MD9134D				VR9134		50
ANF 125 3/5/T5/6/T6/7/A Innova	03-11	SFA375										51
ATC 125 ME/MG	84-85	H303			H303G							52
CA 125 S/T Rebel	95-97	FA228			FA228HH	MD1030						53
CA 125 V/W/X Rebel	98-00	FA256			FA256HH	MD1030						54
CB 125 F (GLR 125 1WHF)	15-16	FA197			FA197HH			MD1030				55
CB 125 F (GLR 125 1WHH)	17-21	FA716						MD1030				56
CB 125 K1-K5	72-76	H308										57
CB 125 K6/S2	76											58
CB 125 S	75-79	H303										59
CB 125 J	79	FA040										60

*-2 Sets Required. † For Vee disc colours add RED, BLU, GRN, GLD, ORG suffix to part number. For Custom Finish Options for Vee-Rotors™ including Splatter discs add suffix CHR, CHGR, CHBL, CHBR - available in various colours see page iv. ☼ - Also available as a Vintage Motorcycle Disc.

JAPANESE Built Motorcycles

Line #	BRAKE DISC CHOICES - FRONT						DISC PAD CHOICES - REAR				BRAKE DISC CHOICES - REAR			
	OverSize 250 /280mm Disc Kit	OSX OverSize 250/280mm Disc Kit	Relocating Bracket for 250/ 280mm Disc	OverSize 320mm Disc Kit	SMX OverSize 320mm Disc Kit	Relocating Bracket for 320mm Disc	FA, SFA, TT Pad or Brake Shoe	SFAC Carbon Scooter Pads	Speciality Pads - SXR / Vee / MXS	Sintered/ HH Pads/ Grooved Shoes	Standard Replacement Disc	Contour Disc Rear fitment	Vee Discs CONTOUR	CX Extreme MX Race Disc
1							SFA131/3			SFA131/3HH		MD1170C		
2							SFA131/3			SFA131/3HH		MD1170C		
3							SFA131/3			SFA131/3HH		MD1170C		
4							SFA131/3			SFA131/3HH		MD1170C		
5							SFA131/3			SFA131/3HH		MD1170C		
6							SFA131/3			SFA131/3HH		MD1170C		
7							SFA131/3			SFA131/3HH		MD1170C		
8							H304			H304G				
9							H333			H333G				
10	OS6058C	OSX6058	BRK026				FA131TT		MXS131	FA131R	MD6005D	MD6005C		MD6005CX
11							H303							
12							H304							
13							H303							
14							H336							
15							H303							
16							H303							
17							H306			H306G				
18							H306			H306G				
19							H306			H306G				
20							H303							
21							H303							
22							H304							
23							H333			H333G				
24							H303							
25							H352							
26							H303							
27							H303							
28							H304			H304G				
29							H333			H333G				
30							FA131TT							
31							H304							
32							H352							
33							H352							
34							H352							
35							H353							
36							H306			H306G				
37							H333			H333G				
38							H304							
39							H304							
40							H352							
41							H352							
42							H352							
43							H352							
44							H352							
45							H352							
46														
47							H352							
48							H352							
49							H352							
50							H352							
51							H353							
52							H306			H306G				
53							H318							
54							H318							
55							H352							
56							H352							
57							H310			H310G				
58							H310			H310G				
59							H303							
60							H304							

REAR / ARRIÈRE / HINTEN / POSTERIOR / POSTERIORE

R Suffix = High Durability Sintered Pad. **HH** Suffix = High Performance Sintered Pad. **TT** Suffix = Hard Wearing Off Road Pad. **V** Suffix = Semi Sintered Pad. **G** Suffix = Grooved Shoe.
D Suffix = Drilled Disc. **X** Suffix = Universal Left or Right Disc. **XC** Suffix = Contoured Disc. **LS** Suffix = Left/Steel Disc. **RS** = Right/Steel Disc.

BRAKE APPLICATIONS

*-2 Sets Required. † For Vee disc colours add RED, BLU, GRN, GLD, ORG suffix to part number. For Custom Finish Options for Vee-Rotors™ including Splatter discs add suffix CHR, CHGR, CHBL, CHBR - available in various colours see page iv. Ⓢ - Also available as a Vintage Motorcycle Disc.

JAPANESE Built Motorcycles



HONDA Contd.



DISC PAD CHOICES - FRONT

BRAKE DISC CHOICES - FRONT

FA, SFA, TT Pad or Brake Shoe	SFAC Carbon Scooter Pads	Speciality Pads - SXR / Vee / MXS	Sintered/HH Pads/ Grooved Shoes	Left / Gauche / Links Standard Replacement Disc	Right / Droite / Rechts Standard Replacement Disc	Contour Disc Universal left and right fitment	Custom Disc Universal left and right fitment	Vee-Discs Black † See note below	CX Extreme MX Race Disc/ UTVX Disc
CB 125 T									
CB 125 T2									
CB 125 TDC/TDE/TDJ			FA069HH						
CB 125 RS	SFA054	SFAC054	FA054HH						
CB 125 R			FA679HH			TBA			
CBF 125 6 Stunner	FA715	FA715V	FA715HH		MD1030				
CBF 125 M7 Stunner	FA715	FA715V	FA715HH		MD1030				
CBF 125 M9/MA/MB/MD/ME	FA375	FA375V	FA375HH		MD1030				
CB 125 F	FA716								
CB 125 R			FA679HH						
CBR 125 R4/R5/RS5/RW5/RS6/RW6 (6 Bolt Front Disc Fixing)	FA375	FA375V	FA375HH		MD644				
CBR 125 RW7/RW8/RW9/RWA (6 Bolt Front Disc Fixing)	FA375	FA375V	FA375HH		MD644				
CBR 125 RWB/RC/RD/RF/RG (5 Bolt Front Disc Fitting)	FA375	FA375V	FA375HH		MD1166RS				
CBX 125 TS Custom	SFA054	SFAC054	FA054HH						
CBX 125 F	FA069		FA069HH						
CBX 125 Custom	FA086		FA086HH						
CD 125 TC	H312								
CG 125 Cargo	H352								
CG 125 K1/B/C/E	H303								
CG 125 BR-K/BR-T/95	H330								
CG 125 T/W/M1/1	H330								
CG 125 ES4-ES8	SFA054	SFAC054	FA054HH						
CG 125 Job	H352								
CH 125 D/E/G Spacy	H303								
CH 125 J/K/L/M/P/R/T Spacy	H303								
CLR 125 W City Fly	FA256		FA256HH	MD1147LS					
CM 125 CC/CF	H312								
CR 125 M2-M4	H304		H304G						
CR 125 RZ/RA/RB	H324		H324G						
CR 125 RC	H319		H319G						
CR 125 RD	H331		H331G						
CR 125 RE/RF	FA092TT		FA092R	MD6087D					
CR 125 RG	FA092TT		FA092R	MD6087D					
CR 125 RH/RJ	FA125TT	MXS125	FA125R	MD6087D					
CR 125 RK	FA125TT	MXS125	FA125R	MD6008D					
CR 125 RL/RM	FA125TT	MXS125	FA125R	MD6003D					
CR 125 RN/PP/RR	FA125TT	MXS125	FA125R	MD6001D		MD6001C		MD6001CX	
CR 125 RS/RT/RV	FA185TT	MXS185	FA185R	MD6037D		MD6037C		MD6037CX	
CR 125 RW/RX/RY/R1	FA185TT	MXS185	FA185R	MD6037D		MD6037C		MD6037CX	
CR 125 R2/R3	FA185TT	MXS185	FA185R	MD6037D		MD6037C		MD6037CX	
♦ Plain undrilled disc for enduro use MD6191CE									
CR 125 R4/R5/R6/R7	FA185TT	MXS185	FA185R	MD6037D		MD6037C		MD6037CX	
♦ Plain undrilled disc for enduro use MD6191CE									
CRF 125 F (Small wheel FR 17 Inch/RR 14 Inch Wheels)	FA185TT	MXS185	FA185R	MD6390D		MD6390C			
CRF 125 FB (Big wheel FR 19 Inch/RR 16 Inch Wheels)	FA185TT	MXS185	FA185R	MD6390D		MD6390C			
CRM 125 RL/RM/RP/RR/RV/RX	FA256TT		FA256HH	MD1147LS					
CT 125 C	H304								
CT 125 (ABS Model)	FA691		FA691HH						
FES 125 W/Y/1/2 Pantheon	SFA281	SFAC281	SFA281HH	MD922D				VR922	
FES 125 3/4/5 Pantheon	SFA281	SFAC281	SFA281HH	MD922D				VR922	
FES 125 7/9/A/B S-Wing (Non ABS Model)	SFA388	SFAC388	SFA388HH	MD922D				VR922	
FES 125 A7/A9/AA/AB S-Wing (ABS Model)	SFA388	SFAC388	SFA388HH	MD922D				VR922	
FS 125 Sonic	SFA086	SFAC086	SFA086HH						
LS 125 RY	FA086		FA086HH						
MBX 125 FE	FA086		FA086HH						
Monkey Z 125 M AC	FA375				MD1191	MD1191C		VR1191	
MSX 125 D/E/F/G/H Grom (Non ABS)	FA375		FA375HH		MD1183			VR1183	
MSX 125 AG/AH GROM (ABS)	FA375		FA375HH		MD1191	MD1191C		VR1191	
MTX 125 RWD	H304								

FRONT / AVANT / VORN / VORN / FREITE / ANTERIORE

Line #
1
2
3
4
5
6
7
8
9
10
11
12
13
14
15
16
17
18
19
20
21
22
23
24
25
26
27
28
29
30
31
32
33
34
35
36
37
38
39
40
41
42
43
44
45
46
47
48
49
50
51
52
53
54
55
56
57
58
59
60

R Suffix = High Durability Sintered Pad. HH Suffix = High Performance Sintered Pad. TT Suffix = Hard Wearing Off Road Pad. V Suffix = Semi Sintered Pad. G Suffix = Grooved Shoe.
D Suffix = Drilled Disc. X Suffix = Universal Left or Right Disc. XC Suffix = Contoured Disc. LS Suffix = Left/Steel Disc. RS = Right/Steel Disc.

*-2 Sets Required. † For Vee disc colours add RED, BLU, GRN, GLD, ORG suffix to part number. For Custom Finish Options for Vee-Rotors™ including Splatter discs add suffix CHR, CHGR, CHBL, CHBR - available in various colours see page iv. ☉ - Also available as a Vintage Motorcycle Disc.

70 Part numbers, prefixes, suffixes, photos and illustrations shown in this catalogue are trademarks and/or copyrights of EBC Brakes or the trademark owner A C Freeman Investments Ltd and use without express written permission of the owners is punishable by law.

JAPANESE Built Motorcycles

Line #	BRAKE DISC CHOICES - FRONT						DISC PAD CHOICES - REAR				BRAKE DISC CHOICES - REAR			
	Oversize 250 /280mm Disc Kit	OSX Oversize 250/280mm Disc Kit	Relocating Bracket for 250/ 280mm Disc	Oversize 320mm Disc Kit	SMX Oversize 320mm Disc Kit	Relocating Bracket for 320mm Disc	FA, SFA, TT Pad or Brake Shoe	SFAC Carbon Scooter Pads	Speciality Pads - SXR / Vee / MXS	Sintered/ HH Pads/ Grooved Shoes	Standard Replacement Disc	Contour Disc Rear fitment	Vee Discs CONTOUR	CX Extreme MX Race Disc
1							H310			H310G				
2							H310			H310G				
3							H310			H310G				
4							H310			H310G				
5							FA629				MD1181			
6							H352							
7							H352							
8							H352							
9							FA629			FA629HH				
10							FA629			FA629HH	MD1181	MD1181C		
11														
12							FA343			FA343HH	MD1151			
13							FA343			FA343HH	MD1151			
14							FA629			FA629HH	MD1151			
15							H310			H310G				
16							H318							
17							H304							
18							H310			H310G				
19							H352							
20							H303							
21							H303							
22							H304							
23							H352							
24							H353							
25							H303							
26							H303							
27							H304							
28							H310			H310G				
29							H304			H304G				
30							H330			H330G				
31							H330			H330G				
32							H331			H331G				
33							H331			H331G				
34							H344			H344G				
35							FA131TT		MXS131	FA131R	MD6009D			
36							FA131TT		MXS131	FA131R	MD6002D			
37							FA131TT		MXS131	FA131R	MD6002D			
38	OS6001EC	OSX6001E	BRK004				FA131TT		MXS131	FA131R	MD6002D			
39	OS6037C	OSX6037	BRK004		SMX6037	BRK009	FA131TT		MXS131	FA131R	MD6002D			
40	OS6037C	OSX6037	BRK004		SMX6037	BRK009	FA131TT		MXS131	FA131R	MD6124D	MD6124C		MD6124CX
41	OS6037C	OSX6037	BRK004		SMX6037	BRK009	FA346TT		MXS346	FA346R	MD6191D	MD6191C		MD6191CX
42														
43	OS6437C	OSX6437	BRK005		SMX6437	BRK006	FA346TT		MXS346	FA346R	MD6191D	MD6191C		MD6191CX
44														
45							H333			H333G				
46							H333			H333G				
47							FA047/3							
48							H304							
49							TBA							
50							H351							
51							SFA140	SFAC140		SFA140HH	MD9135D		VR9135	
52							SFA415	SFAC415		SFA415HH	MD9135D		VR9135	
53							SFA415	SFAC415		SFA415HH	MD9135D		VR9135	
54							SFA375							
55							FA197			FA197HH				
56							H304							
57							FA343			FA343HH	MD1184	MD1184C	VR1184	
58	OSX1183		BRK037				FA629			FA629HH	MD1184	MD1184C	VR1184	
59							FA629			FA629HH	MD1184	MD1184C	VR1184	
60							H304							

REAR / ARRIÈRE / HINTEN / POSTERIOR / POSTERIORE

*-2 Sets Required. † For Vee disc colours add RED, BLU, GRN, GLD, ORG suffix to part number. For Custom Finish Options for Vee-Rotors™ including Splatter discs add suffix CHR, CHGR, CHBL, CHBR - available in various colours see page iv. ☉ - Also available as a Vintage Motorcycle Disc.

Part numbers, prefixes, suffixes, photos and illustrations shown in this catalogue are trademarks and/or copyrights of EBC Brakes or the trademark owner A C Freeman Investments Ltd and use without express written permission of the owners is punishable by law.

R Suffix = High Durability Sintered Pad. **HH** Suffix = High Performance Sintered Pad. **TT** Suffix = Hard Wearing Off Road Pad. **V** Suffix = Semi Sintered Pad. **G** Suffix = Grooved Shoe.
D Suffix = Drilled Disc. **X** Suffix = Universal Left or Right Disc. **XC** Suffix = Contoured Disc. **LS** Suffix = Left/Steel Disc. **RS** = Right/Steel Disc.

BRAKE APPLICATIONS

JAPANESE Built Motorcycles



HONDA Contd.



DISC PAD CHOICES - FRONT

BRAKE DISC CHOICES - FRONT

		FA, SFA, TT Pad or Brake Shoe	SFAC Carbon Scooter Pads	Speciality Pads - SXR / Vee / MXS	Sintered/HH Pads/ Grooved Shoes	Left / Gauche / Links Standard Replacement Disc	Right / Droite / Rechts Standard Replacement Disc	Contour Disc Universal left and right fitment	Custom Disc Universal left and right fitment	Vee-Discs Black † See note below	CX Extreme MX Race Disc/ UTVX Disc	Line #
MTX 125 RWE/RWF/RWH/RWL	85-95	FA092TT			FA092R	MD6087D						1
NES 125 Y1/2/3/4/5/6 (@ 125 Scooter)	00-06	SFA323	SFAC323		SFA323HH	MD970D				VR970		2
NH 125 MD-D Lead	83	H303										3
NH 125 Lead	86-87	SFA176										4
NSC 125 New Elite 125cc	18-20	SFA721										5
NS 125 FG/FH/RH	86-87	FA256			FA256HH	MD1084LS						6
NSR 125 FJ/FK/FL/FM/FN	88-92	FA256			FA256HH	MD1088LS						7
NSR 125 RK/RL/RM/RN	89-92	FA256			FA256HH	MD1088LS						8
NSR 125 RR/RS/RV/RW/RX/R1	93-01	FA256			FA256HH	MD1109LS						9
NSS 125 Forza (2 Piston Caliper)	15-21	SFA196	SFAC196		SFA196HH							10
NX 125 K/S/F Transcity	89-97	FA256TT			FA256HH	MD1147LS						11
NXR 125 Bros ES/KS	05	H352										12
PCX 125 (WW 125 EX2 C/D/F/H/J)	12-18	SFA603	SFAC603		SFA603HH	MD9134D				VR9134		13
PCX 125S (WW 125 AK)	18-21	SFA693	SFAC693		SFA693HH	MD9134D						14
PCX 125	18-21	SFA723										15
PES 125 6/7/8/9/A (PS125)	06-09	SFA323	SFAC323		SFA323HH	MD970D				VR970		16
PES 125 R8/R9/RA (PS125)	08-09	SFA323	SFAC323		SFA323HH	MD970D				VR970		17
SC 125 (Elite)	08-14	SFA721	SFAC721									18
SES 125 2/3/4 Dylan	02-07	SFA323	SFAC323		SFA323HH	MD970D				VR970		19
SH 125 1/3 (Carb/Rear drum model)	01-03	SFA323	SFAC323		SFA323HH	MD970D				VR970		20
SH 125i 4/5/6/7/8 (Fuel Injection/Rear Drum Model)	04-08	SFA323	SFAC323		SFA323HH	MD970D				VR970		21
SH 125i 9/A/B (Fuel Injection/Rear Disc Model)	09-12	SFA388	SFAC388		SFA388HH	MD922D				VR922		22
SH 125i D9 (Fuel Injection/Rear Drum Model)	09	SFA323	SFAC323		SFA323HH	MD922D				VR922		23
SH 125i R8 (Fuel Injection/Rear Drum Model)	08	SFA323	SFAC323		SFA323HH	MD970D				VR970		24
SH 125i RA (Fuel Injection/Rear Disc Model)	10-14	SFA388	SFAC388		SFA388HH	MD922D				VR922		25
SH 125i S7/S8 (Fuel Injection/Rear Drum Model)	07-08	SFA323	SFAC323		SFA323HH	MD970D				VR970		26
SH 125i Mode (ANC 125 E)	14-18	SFA603	SFAC603		SFA603HH	MD9134D						27
SH 125i Mode ADL (2 Piston Caliper)	14-21	SFA196	SFAC196		SFA196HH	MD922D				VR922		28
SH 125i (3 Piston Caliper/ABS)	14-16	SFA388	SFAC388		SFA388HH	MD922D				VR922		29
SL 125 KIA	76	H303										30
SL 125 KID/E/F/G/K2A	76-80	H304										31
Super Cub C 125 (ABS)	18-21	FA691			FA691HH							32
Super Cub C 125 (ABS) 007	18-20	FA691			FA691HH							33
TL 125	76	H304			H304G							34
TRX 125 J	88	H303*			H303G*							35
VT 125 CX-C8 Shadow	99-08	FA197			FA197HH		MD1030					36
XL 125 K2	78	H304			H304G							37
XL 125 K3/K4	79	H303			H303G							38
XL 125 SZ/SA/SB/SC/RC	79-82	H304			H304G							39
XL 125 Paris-Dakar	85	FA256TT			FA256HH							40
XL 125 RF/RH	85-86	FA092TT			FA092R	MD6087D						41
XL 125 V1-VA Varadero	01-16	FA197			FA197HH		MD1150RS					42
XLR 125 RW	98-01	FA185TT		MXS185	FA185R	MD6001D		MD6001C			MD6001CX	43
XR 125 L3/L4/L5/L6/L7/L8	03-08	FA185TT		MXS185	FA185R							44
ADV 150	21	SFA693			SFA693HH							45
CBF 150 5	05	FA715		FA715V	FA715HH		N/A					46
CBF 150 M5 Unicorn	05	FA715		FA715V	FA715HH		N/A					47
CBF 150 6 (Spoke Wheels)	06	FA715		FA715V	FA715HH		MD1030					48
CBF 150 M6/M7 Unicorn (Spoke Wheels)	06-07	FA715		FA715V	FA715HH		MD1030					49
CBF 150 M7/M9/MA Unicorn (Cast Wheels)	07-10	FA715		FA715V	FA715HH		MD1030					50
CBF 150 MB/MC Unicorn (Cast Wheels)	11-12	FA715		FA715V	FA715HH		MD1030					51
CBR 15 SH	07-10	FA744		FA744V			MD1030					52
CBR 150 R	00-03	FA375		FA375V	FA375HH		MD644					53
CG 150 ESD Titan	04-05	FA054TT		MXS054	FA054R							54
CG 150 KS/ES Titan	04-05	FA054TT		MXS054	FA054R							55
CRF 150 F3/F4/F5/F6/F7/F8/F9	03-20	FA185TT		MXS185	FA185R	MD6317D						56
CRF 150 R (Small wheel FR 17 Inch/RR 14 Inch)	03-21	FA084TT		MXS084	FA084R	MD6314D		MD6314C			MD6314CX	57
CRF 150 RB (Big wheel FR 19 Inch/RR 16 Inch)	03-21	FA084TT		MXS084	FA084R	MD6314D		MD6314C			MD6314CX	58
FES 150 W/Y/1/2 Pantheon	98-02	SFA281	SFAC281		SFA281HH	MD922D				VR922		59
FES 150 3/4/5 Pantheon	03-06	SFA281	SFAC281		SFA281HH	MD922D				VR922		60

FRONT / AVANT / VORN / FRENTE / ANTERIORE

R Suffix = High Durability Sintered Pad. HH Suffix = High Performance Sintered Pad. TT Suffix = Hard Wearing Off Road Pad. V Suffix = Semi Sintered Pad. G Suffix = Grooved Shoe.
D Suffix = Drilled Disc. X Suffix = Universal Left or Right Disc. XC Suffix = Contoured Disc. LS Suffix = Left/Steel Disc. RS = Right/Steel Disc.

*-2 Sets Required. † For Vee disc colours add RED, BLU, GRN, GLD, ORG suffix to part number. For Custom Finish Options for Vee-Rotors™ including Splatter discs add suffix CHR, CHGR, CHBL, CHBR - available in various colours see page iv. ☼ - Also available as a Vintage Motorcycle Disc.

JAPANESE Built Motorcycles

Line #	BRAKE DISC CHOICES - FRONT						DISC PAD CHOICES - REAR				BRAKE DISC CHOICES - REAR			
	Oversize 250 /280mm Disc Kit	OSX Oversize 250/280mm Disc Kit	Relocating Bracket for 250/ 280mm Disc	Oversize 320mm Disc Kit	SMX Oversize 320mm Disc Kit	Relocating Bracket for 320mm Disc	FA, SFA, TT Pad or Brake Shoe	SFAC Carbon Scooter Pads	Speciality Pads - SXR / Vee / MXS	Sintered/ HH Pads/ Grooved Shoes	Standard Replacement Disc	Contour Disc Rear fitment	Vee Discs CONTOUR	CX Extreme MX Race Disc
1							H304			H304G				
2							H352							
3							H303							
4							H303							
5							H352							
6							H303							
7							FA047/3							
8							FA047/3							
9							FA047/3							
10							SFA415	SFAC415		SFA415HH				
11							H303							
12							H353							
13							H352							
14							H352							
15							H352							
16							H352							
17							H352							
18							H352							
19							H352							
20							H352							
21							H352							
22							SFA415	SFAC415		SFA415HH	MD9139D		VR9139	
23							H352							
24							H352							
25							SFA415	SFAC415		SFA415HH	MD9139D		VR9139	
26							H352							
27							H352							
28							SFA415	SFAC415		SFA415HH	MD9139D		VR9139	
29							SFA415	SFAC415		SFA415HH	MD9139D		VR9139	
30							H303							
31							H304							
32							H352							
33							H352							
34							H304			H304G				
35							H306			H306G				
36							H318							
37							H304			H304G				
38							H304			H304G				
39							H304			H304G				
40							H303							
41							H304			H304G				
42							FA343			FA343HH	MD1151			
43							H304			H304G				
44							H304			H304G				
45							SFA415	SFAC415		SFA415HH				
46							H352							
47							H352							
48							H352							
49							H352							
50							H352							
51							FA629			FA629HH	MD1151			
52							FA629	FA629HH			MD1151			
53							FA343			FA343HH	MD1151			
54							H352							
55							H352							
56		OSX6317	BRK009				H304			H304G				
57		OSX6314	BRK026				FA346TT	MXS346	FA346R	MD6316D	MD6316C		MD6316CX	
58		OSX6314	BRK026				FA346TT	MXS346	FA346R	MD6316D	MD6316C		MD6316CX	
59							H351							
60							SFA140	SFAC140		SFA140HH	MD9135D		VR9135	

REAR / ARRIÈRE / HINTEN / POSTERIOR / POSTERIORE

R Suffix = High Durability Sintered Pad. **HH** Suffix = High Performance Sintered Pad. **TT** Suffix = Hard Wearing Off Road Pad. **V** Suffix = Semi Sintered Pad. **G** Suffix = Grooved Shoe.
D Suffix = Drilled Disc. **X** Suffix = Universal Left or Right Disc. **XC** Suffix = Contoured Disc. **LS** Suffix = Left/Steel Disc. **RS** = Right/Steel Disc.

*-2 Sets Required. † For Vee disc colours add RED, BLU, GRN, GLD, ORG suffix to part number. For Custom Finish Options for Vee-Rotors™ including Splatter discs add suffix CHR, CHGR, CHBL, CHBR - available in various colours see page iv. ☉ - Also available as a Vintage Motorcycle Disc.

Part numbers, prefixes, suffixes, photos and illustrations shown in this catalogue are trademarks and/or copyrights of EBC Brakes or the trademark owner A C Freeman Investments Ltd and use without express written permission of the owners is punishable by law.

JAPANESE Built Motorcycles



HONDA Contd.



DISC PAD CHOICES - FRONT

BRAKE DISC CHOICES - FRONT

R Suffix = High Durability Sintered Pad. **HH** Suffix = High Performance Sintered Pad. **TT** Suffix = Hard Wearing Off Road Pad. **V** Suffix = Semi Sintered Pad. **G** Suffix = Grooved Shoe.

D Suffix = Drilled Disc. **X** Suffix = Universal Left or Right Disc. **XC** Suffix = Contoured Disc. **LS** Suffix = Left/Steel Disc. **RS** = Right/Steel Disc.

FRONT / AVANT / VORN / FRENTE / ANTERIORE

		FA, SFA, TT Pad or Brake Shoe	SFAC Carbon Scooter Pads	Speciality Pads - SXR / Vee / MXS	Sintered/HH Pads/ Grooved Shoes	Left / Gauche / Links Standard Replacement Disc	Right / Droite / Rechts Standard Replacement Disc	Contour Disc Universal left and right fitment	Custom Disc Universal left and right fitment	Vee-Discs Black † See note below	CX Extreme MX Race Disc/ UTVX Disc	Line #
FES 150 7/9 S-Wing (Non ABS Model)	07-13	SFA388	SFAC388		SFA388HH	MD922D				VR922		1
FES 150 A7/A9 S-Wing (ABS Model)	07-13	SFA388	SFAC388		SFA388HH	MD922D				VR922		2
NES 150 Y1/2/3/4/5/6 @ 150 Scooter	01-06	SFA323	SFAC323		SFA323HH	MD970D				VR970		3
NSR 150 RR (Malaysian Market)		FA197			FA197HH							4
PCX 150 (WW 150 EX2)	12-20	SFA603	SFAC603		SFA603HH	MD9134D				VR9134		5
PCX 150 (ABS)	18-20	SFA693	SFAC603		SFA693HH	MD9134D				VR9134		6
PCX 150	17-21	SFA723	SFAC723			MD9134D						7
PCX 150 Hybrid	19-20	SFA723	SFAC723			MD9134D						8
PES 150 6/7/8/9/A (PS150)	06-10	SFA323	SFAC323		SFA323HH	MD970D				VR970		9
PES 150 R8/R9/RA (PS150)	08-11	SFA323	SFAC323		SFA323HH	MD970D				VR970		10
SES 150 2/3/4 Dylan	02-06	SFA323	SFAC323		SFA323HH	MD970D				VR970		11
SH 150 1/3 (CARB/Rear Drum Model)	01-03	SFA323	SFAC323		SFA323HH	MD970D				VR970		12
SH 150i 4/5/6/7/8 (Fuel Injection/Rear Drum Model)	04-08	SFA323	SFAC323		SFA323HH	MD970D				VR970		13
SH 150i 9/A/B (Fuel Injection/Rear Disc Model)	09-12	SFA388	SFAC388		SFA388HH	MD922D				VR922		14
SH 150 i-D9 (Fuel Injection/Rear Drum Model)	09	SFA323	SFAC323		SFA323HH	MD922D				VR922		15
SH 150i R8 (Fuel Injection/Rear Drum Model)	08	SFA323	SFAC323		SFA323HH	MD970D				VR970		16
SH 150i RA (Fuel Injection/Rear Disc Model)	10-14	SFA388	SFAC388		SFA388HH	MD922D				VR922		17
SH 150i S7/S8 (Fuel Injection/Rear Drum Model)	07-08	SFA323	SFAC323		SFA323HH	MD970D				VR970		18
SH 150i (2 Piston Caliper/ABS)	14-21	SFA196	SFAC196		SFA196HH	MD922D				VR922		19
CB 175 All models	74-76	H308										20
CD 175 All models	67-79	H306										21
ATC 185 A/SB	80-81	H303			H303G							22
CD 185 T	78	H312										23
XL 185 SZ/SA/SB	80-82	H304			H304G							24
CB 190 R (CBF190WH)	16-18	SFA721										25
ATC 200 B/ESE/ESF/SE	81-84	H303			H303G							26
ATC 200 XD	83				FA084/2R	MD6059D						27
TRX 200 L/M/DW/DN	90-93	H345*			H345G*							28
CB 200 B	76-79											29
CBX 200 Strada	97-01	SFA054	SFAC054		SFA054HH							30
CD 200 TA/TB	79-80	H312										31
CM 200 TA/TB	79-80	H312										32
CTX 200/CTX 200 A Bushlander	04-16	FA185TT		MXS185	FA185R	MD6001D		MD6001C			MD6001CX	33
MTX 200 RWD	83-84	H304			H304G							34
MTX 200 RWF	85	FA092TT			FA092R	MD6087D						35
TA 200 (TA Shadow)	02-05	FA197			FA197HH		MD1030					36
TL 200 J/Y Colin Seeley	76-78	H304			H304G							37
TLR 200 D/E	83-85	H333			H333G							38
TLR 200 G/H	86-87	H304			H304G							39
TRX 200 L/M	90-91	H345*			H345G*							40
TRX 200 D	91-97	H345*			H345G*							41
TRX 200 SX	86-87	H345*			H345G*							42
XL 200 L	85	FA256TT			FA256HH							43
XL 200 R	85	FA092TT			FA092R							44
XR 200	80-84	H304			H304G							45
XR 200 R	81-02	H304			H304G							46
TLM 220 R	88-92	FA624TT										47
FTR 223 Y/2/A2 (MC34)	00-02	FA092TT			FA092R							48
CRF 230 F AC	04-20	FA185TT		MXS185	FA185R	MD6001D		MD6001C			MD6001CX	49
CRF 230 L	08-10	FA185TT		MXS185	FA185R	MD6001D		MD6001C			MD6001CX	50
CRF 230 M (Supernova)	09-10	FA185TT		MXS185	FA185R	MD6001D		MD6001C			MD6001CX	51
SL 230 Free Landsports (MD33) VW/X/1	97-01	FA185TT		MXS185	FA185R	MD6001D		MD6001C			MD6001CX	52
XL 230 2 (MC36)	02	H352										53
ATC 250 RB	81	FA054TT		MXS054	FA054R		MD6060D					54
ATC 250 RC	82	FA084TT		MXS084	FA084R		MD6060D					55
ATC 250 RD	83-84	FA084TT		MXS084	FA084R		MD6059D					56
ATC 250 RF/RG	85-86	FA092TT			FA092R	MD6059D						57
ATC 250 ESF/ESG/ESH/ESJ	85-88	H306			H306G							58
AX-1 (NX 250 J/K/R/R3)	89-94	FA125TT		MXS125	FA125R	MD6001D		MD6001C			MD6001CX	59
CB 250 K3-K5	73-75	H314										60

*-2 Sets Required. † For Vee disc colours add RED, BLU, GRN, GLD, ORG suffix to part number. For Custom Finish Options for Vee-Rotors™ including Splatter discs add suffix CHR, CHGR, CHBL, CHBR - available in various colours see page iv. ☼ - Also available as a Vintage Motorcycle Disc.

JAPANESE Built Motorcycles

Line #	BRAKE DISC CHOICES - FRONT						DISC PAD CHOICES - REAR				BRAKE DISC CHOICES - REAR			
	Oversize 250 /280mm Disc Kit	OSX Oversize 250/280mm Disc Kit	Relocating Bracket for 250/ 280mm Disc	Oversize 320mm Disc Kit	SMX Oversize 320mm Disc Kit	Relocating Bracket for 320mm Disc	FA, SFA, TT Pad or Brake Shoe	SFAC Carbon Scooter Pads	Speciality Pads - SXR / Vee / MXS	Sintered/ HH Pads/ Grooved Shoes	Standard Replacement Disc	Contour Disc Rear fitment	Vee Discs CONTOUR	CX Extreme MX Race Disc
1							SFA415	SFAC415		SFA415HH	MD9135D		VR9135	
2							SFA415	SFAC415		SFA415HH	MD9135D		VR9135	
3							H352							
4							FA197			FA197HH				
5							H352							
6							H352							
7							H352							
8							H352							
9							H352							
10							H352							
11							H352							
12							H352							
13							H352							
14							SFA415	SFAC415		SFA415HH	MD9139D		VR9139	
15							H352							
16							H352							
17							SFA415	SFAC415		SFA415HH	MD9139D		VR9139	
18							H352							
19							SFA415	SFAC415		SFA415HH	MD9139D		VR9139	
20							H309							
21							H307							
22							H306			H306G				
23							H310			H310G				
24							H304			H304G				
25							FA629							
26							H306			H306G				
27										FA084/2R	MD6059D			
28							H306			H306G				
29							H309							
30							H352							
31							H310			H310G				
32							H310			H310G				
33							H304			H304G				
34							H304			H304G				
35							H304			H304G				
36							FA197			FA197HH				
37							H304			H304G				
38							H333			H333G				
39							H333			H333G				
40							H306			H306G				
41							H306			H306G				
42							H306			H306G				
43							H303							
44							H303							
45							H304			H304G				
46							H304			H304G				
47							H304			H304G				
48							H352							
49		OSX6001	BRK008		SMX6001	BRK009	H304			H304G				
50		OSX6001	BRK008		SMX6001	BRK009	FA131TT		MXS131	FA131R	MD6013D	MD6013C		MD6013CX
51		OSX6001	BRK008		SMX6001	BRK009	FA131TT		MXS131	FA131R	MD6013D	MD6013C		MD6013CX
52							FA131TT		MXS131	FA131R	MD6013D	MD6013C		MD6013CX
53							H352							
54							H306			H306G				
55							H306			H306G				
56							FA084TT		MXS084	FA084R	MD6059D			
57							FA092TT			FA092R	MD6007D			
58							H315			H315G				
59							FA153				MD6198D			
60							H315							

REAR / ARRIÈRE / HINTEN / POSTERIOR / POSTERIORE

R Suffix = High Durability Sintered Pad. **HH** Suffix = High Performance Sintered Pad. **TT** Suffix = Hard Wearing Off Road Pad. **V** Suffix = Semi Sintered Pad. **G** Suffix = Grooved Shoe.
D Suffix = Drilled Disc. **X** Suffix = Universal Left or Right Disc. **XC** Suffix = Contoured Disc. **LS** Suffix = Left/Steel Disc. **RS** = Right/Steel Disc.

*-2 Sets Required. † For Vee disc colours add RED, BLU, GRN, GLD, ORG suffix to part number. For Custom Finish Options for Vee-Rotors™ including Splatter discs add suffix CHR, CHGR, CHBL, CHBR - available in various colours see page iv. ☉ - Also available as a Vintage Motorcycle Disc.

BRAKE APPLICATIONS

JAPANESE Built Motorcycles



HONDA Contd.



DISC PAD CHOICES - FRONT

BRAKE DISC CHOICES - FRONT

R Suffix = High Durability Sintered Pad. **HH** Suffix = High Performance Sintered Pad. **TT** Suffix = Hard Wearing Off Road Pad. **V** Suffix = Semi Sintered Pad. **G** Suffix = Grooved Shoe.

D Suffix = Drilled Disc. **X** Suffix = Universal Left or Right Disc. **XC** Suffix = Contoured Disc. **LS** Suffix = Left/Steel Disc. **RS** = Right/Steel Disc.

Model	Year	FA, SFA, TT Pad or Brake Shoe	SFAC Carbon Scooter Pads	Speciality Pads - SXR / Vee / MXS	Sintered/HH Pads/ Grooved Shoes
CB 250 G5	75	FA013			
CB 250 T	78	FA045			
CB 250 Twister	16-19	FA388			
CB 250 N/NA/NB/NDB/NDC	78-82	FA045			MD1036LS
CB 250 RSA/RSD	81-84	FA045			
CB 250 FT/FV/FX/FV/F1 Hornet	96-01	FA187			FA187HH MD1144RS
CB 250 N/T/W/X/Y/1/4 Two Fifty	92-05	FA196			FA196HH MD1089LS
CBF 250 4/6	04-06	FA197			FA197HH MD1166RS
CBR 250 FG/FGYA (MC14)	86	FA121*			FA121HH* MD1006 MD1006C*
CBR 250 RH (MC17)	87	FA121*			FA121HH* MD1006 MD1006 MD1006C*
CBR 250 R/J/RK/RK2 (MC19)	88-89	FA142		FA142V	FA142HH MD1140RS
CBR 250 RRL/RRN/RRR (MC22)	90-94	FA142*		FA142V*	FA142HH* MD1145LS MD1145RS
CBR 250 RB/RC (Non ABS Model)	11-13	FA142			FA142HH MD1180X MD1180XC
CBR 250 RAB/RAC (ABS Model)	11-13	FA388			FA388HH MD1180X MD1180XC
CBX 250 RSE	84	FA069			FA069HH MD1090LS
CBX 250 Twister					
CBX 250	84-98	FA086			FA086HH MD1030
CD 250 LJ	88-92	FA124/2			FA124/2HH MD1090LS
CH 250 F/G Spacy	85-86	SFA323/2			SFA323/2HH MD913D
CJ 250 T	77	FA013			
C 250 SC	81	H312			
CM 250 TB	81	FA045			MD1036LS
CMX 250 CT Rebel (Nissin Caliper)	96	FA228			FA228HH MD1030
CMX 250 CV/CW/CX Rebel (Grimeca Caliper)	97-00	FA256			FA256HH MD1030
CN 250 H/J/K/L/M/P/R/S/T/V/X Spazio/Helix	87-98	FA069/2			MD908D VR908
CN 250 3 (MF02) Fusion/Fusion X/Fusion X Special	03	SFA196	SFAC196		SFA196HH MD908D VR908
CR 250 RZ/RA	79-80	H324			H324G
CR 250 RB	81	H327			H327G
CR 250 RC/RD	82-83	H328			H328G
CR 250 RE/RF	84-85	FA092TT			FA092R MD6087D
CR 250 RG	86	FA092TT			FA092R MD6087D
CR 250 RH/RJ	87-88	FA125TT		MXS125	FA125R MD6087D
CR 250 RK	89	FA125TT		MXS125	FA125R MD6008D
CR 250 RL/RM	90-91	FA125TT		MXS125	FA125R MD6003D
CR 250 RN/RP/RR	92-94	FA125TT		MXS125	FA125R MD6001D MD6001C
CR 250 RS/RT	95-96	FA185TT		MXS185	FA185R MD6037D MD6037C MD6001CX
CR 250 RV/RW/RX/RV/R1	97-01	FA185TT		MXS185	FA185R MD6037D MD6037C MD6037CX
CR 250 R2/R3	02-03	FA185TT		MXS185	FA185R MD6037D MD6037C MD6037CX
CR 250 R4/R5/R6/R7	04-07	FA185TT		MXS185	FA185R MD6037D MD6037C MD6037CX
CRF 250 LD/LF	13-20	FA465TT		MXS465	FA465R MD6372C MD6372CX
CRF 250 LH (ABS)	17-21	FA465TT		MXS465	FA465R MD6372C MD6372CX
CRF 250 ME Supermoto	14-16	FA465TT		MXS465	FA465R MD6372C MD6372CX
CRF 250 R4/R5/R6/R7	04-07	FA185TT		MXS185	FA185R MD6037D MD6037C MD6037CX
CRF 250 R8/R9/RA/RB/RC/RD/RE/RF/RG	08-16	FA185TT		MXS185	FA185R MD6037C MD6037CX
CRF 250 RF/RG/RH/RJ (260mm F/Disc)	15-21	FA185TT		MXS185	FA185R MD6389C MD6389CX
CRF 250 Rally (CRF 250 RLA Rally ABS)	17-21	FA465TT		MXS465	FA465R MD6409C MD6409CX
CRF 250 Rally (CRF 250 RL Rally Non ABS)	17-21	FA465TT		MXS465	FA465R MD6409C MD6409CX
CRF 250 X	04-20	FA185TT		MXS185	FA185R MD6037D MD6037C MD6037CX
CRF 250 RX	19-21	FA185TT		MXS185	FA185R MD6037C MD6037CX
CRF 250 XRL (Road Legal)	14-20	FA185TT		MXS185	FA185R MD6037C MD6037CX
CRM 250 R (RK) MK1 MD24 (100001-1008385)	89-90	FA125TT		MXS125	FA125R MD6087D
CRM 250 R (RM) MK2 MD24 (1200001-1211634)	91-92	FA125TT		MXS125	FA125R MD6001D MD6001C MD6001CX
CRM 250 R (RP/RP-II) MK2/2 MD24 (1300001-)	93	FA125TT		MXS125	FA125R MD6001D MD6001C MD6001CX

FRONT / AVANT / VORN / FRENTE / ANTERIORE

Line #

*-2 Sets Required. † For Vee disc colours add RED, BLU, GRN, GLD, ORG suffix to part number. For Custom Finish Options for Vee-Rotors™ including Splatter discs add suffix CHR, CHGR, CHBL, CHBR - available in various colours see page iv. Ⓢ - Also available as a Vintage Motorcycle Disc.

JAPANESE Built Motorcycles

Line #	BRAKE DISC CHOICES - FRONT						DISC PAD CHOICES - REAR				BRAKE DISC CHOICES - REAR			
	Oversize 250 /280mm Disc Kit	OSX Oversize 250/280mm Disc Kit	Relocating Bracket for 250/ 280mm Disc	Oversize 320mm Disc Kit	SMX Oversize 320mm Disc Kit	Relocating Bracket for 320mm Disc	FA, SFA, TT Pad or Brake Shoe	SFAC Carbon Scooter Pads	Speciality Pads - SXR / Vee / MXS	Sintered/ HH Pads/ Grooved Shoes	Standard Replacement Disc	Contour Disc Rear fitment	Vee Discs CONTOUR	CX Extreme MX Race Disc
1							H315							
2							H313							
3							H352							
4							H313							
5							H309							
6							FA140	FA140V	FA140HH	MD1004	MD1004C			
7							H310		H310G					
8							H352							
9							H309							
10							FA140	FA140V	FA140HH	MD1002				
11							FA140	FA140V	FA140HH	MD1002				
12							FA140	FA140V	FA140HH	MD1004	MD1004C			
13							FA496	FA496V	FA496HH	MD1004	MD1004C			
14							FA496	FA496V	FA496HH	MD1181				
15							H318							
16							H352							
17							H304							
18							H310		H310G					
19							H341							
20							H315							
21							H309							
22							H313							
23							H318							
24							H318							
25							H350							
26							H350							
27							H325		H325G					
28							H330		H330G					
29							H331		H331G					
30							H331		H331G					
31							H344		H344G					
32							FA131TT	MXS131	FA131R	MD6009D				
33							FA131TT	MXS131	FA131R	MD6002D				
34							FA131TT	MXS131	FA131R	MD6002D				
35	OS6001EC	OSX6001E	BRK004				FA131TT	MXS131	FA131R	MD6002D				
36	OS6037C	OSX6037	BRK008		SMX6037	BRK009	FA131TT	MXS131	FA131R	MD6002D				
37	OS6037C	OSX6037	BRK008		SMX6037	BRK009	FA131TT	MXS131	FA131R	MD6124D	MD6124C		MD6124CX	
38	OS6037C	OSX6037	BRK008		SMX6037	BRK009	FA346TT	MXS346	FA346R	MD6191D	MD6191C		MD6191CX	
39														
40	OS6437C	OSX6437	BRK005		SMX6437	BRK006	FA346TT	MXS346	FA346R	MD6191D	MD6191C		MD6191CX	
41														
42														
43							FA629TT		FA629R		MD6373C		MD6373CX	
44							FA629TT		FA629R		MD6373C		MD6373CX	
45	OS6437C	OSX6437	BRK005		SMX6437	BRK006	FA346TT	MXS346	FA346R	MD6191D	MD6191C		MD6191CX	
46														
47	OS6437C	OSX6437	BRK005		SMX6437	BRK006	FA346TT	MXS346	FA346R		MD6191C		MD6191CX	
48		OSX6389	BRK042		SMX6389	BRK041	FA346TT	MXS346	FA346R		MD6191C		MD6191CX	
49														
50							FA629TT		FA629R		MD6373C		MD6373CX	
51							FA629TT		FA629R		MD6373C		MD6373CX	
52	OS6437C	OSX6437	BRK005	SM6437C	SMX6437	BRK006	FA346TT	MXS346	FA346R	MD6191D	MD6191C		MD6191CX	
53														
54	OS6437C	OSX6437	BRK005	SM6437C	SMX6437	BRK006	FA346TT	MXS346	FA346R		MD6191C		MD6191CX	
55														
56	OS6437C	OSX6437	BRK005	SM6437C	SMX6437	BRK006	FA346TT	MXS346	FA346R		MD6191C		MD6191CX	
57														
58							FA153			MD6165D				
59	OS6001EC	OSX6001E	BRK004				FA131TT	MXS131	FA131R	MD6013D	MD6013C		MD6013CX	
60	OS6001EC	OSX6001E	BRK004				FA131TT	MXS131	FA131R	MD6013D	MD6013C		MD6013CX	

REAR / ARRIÈRE / HINTEN / POSTERIOR / POSTERIORE

R Suffix = High Durability Sintered Pad. **HH** Suffix = High Performance Sintered Pad. **TT** Suffix = Hard Wearing Off Road Pad. **V** Suffix = Semi Sintered Pad. **G** Suffix = Grooved Shoe.
D Suffix = Drilled Disc. **X** Suffix = Universal Left or Right Disc. **XC** Suffix = Contoured Disc. **LS** Suffix = Left/Steel Disc. **RS** = Right/Steel Disc.

*-2 Sets Required. † For Vee disc colours add RED, BLU, GRN, GLD, ORG suffix to part number. For Custom Finish Options for Vee-Rotors™ including Splatter discs add suffix CHR, CHGR, CHBL, CHBR - available in various colours see page iv. Ⓢ - Also available as a Vintage Motorcycle Disc.

BRAKE APPLICATIONS

JAPANESE Built Motorcycles



HONDA Contd.

DISC PAD CHOICES - FRONT

BRAKE DISC CHOICES - FRONT

R Suffix = High Durability Sintered Pad. **HH** Suffix = High Performance Sintered Pad. **TT** Suffix = Hard Wearing Off Road Pad. **V** Suffix = Semi Sintered Pad. **G** Suffix = Grooved Shoe.
D Suffix = Drilled Disc. **X** Suffix = Universal Left or Right Disc. **XS** Suffix = Contoured Disc. **LS** Suffix = Left/Steel Disc. **RS** = Right/Steel Disc.

CRM 250 (MD24) 140 (MK3) RR-RR-II	94-96
CRM 250 ARV/ARW Active Radical (MD32)	97-98
FES 250 W/X Foresight	98-99
FES 250 Y/1/2/5 Foresight	00-05
FES 250 Y/1/2/5 Foresight - Parking Brake	00-05
FL 250 Odyssey	77-84
GB 250 E/H Clubman (MC10 101-110)	84-87
GB 250 J/L/P/S/V Clubman (MC 10-120-150)	89-97
MXV 250 F (MC92)	83-88
NS 250 FE/RE (MCII-100)	84
NS 250 RG (MCII-102)	86
NSF 250 R (Moto 3)	18-20
NSR 250 RG (MC16-100)	86
NSR 250 R2J (MC18-100) R4J (MC18-100)	88
NSR 250 R5K/R5K-2 (MC18-110)	89
NSR 250 R6K/R6K-2 (MC18-110)	89
NSR 250 R7L/R7N (MC21-106)	90
NSR 250 R8L-3 (MC21-101) R9L (MC21-102) R8N/R8N-3 (MC21-106)	90-92
NSR 250 R9N (MC21-106)	92
NSR 250 RR (MC28-100)	94
NSR 250 R2R/R3R (MC28-110) R2T/R3T (MC28-120)	94
NSS 250 Y/AY/1/A1/A3/3 Forza/Forza-ST/S/T /Jazz/Reflex (MF04/MF06)	00-04
NSS 250 EX5/EX7/EX8 Forza EX (ABS)	05-08
NSS 250 EX5/EX7/EX8 Forza EX (ABS) - Parking Brake	05-08
NSS 250 AX5/AX6 Forza Z (ABS)	05-06
NSS 250 AX5/AX6 Forza Z (ABS) - Parking Brake	05-06
NSS 250 X5/X7/X8 Forza X	05-08
NSS 250 X5/X7/X8 Forza X - Parking Brake	05-08
NX 250 J/K (MD21)	87-90
NX 250 2L/M/P/2P (MD25)	90-93
PS 250 5/6 Big Ruckus	05-06
RTL 250 SG	86
RTL 250 S	88-89
TL 250 K1	79
TLR 250 F	85
TLM 250 RJ	89
TRX 250 F/G/H	85-87
TRX 250 RG/RH	86-87
TRX 250 RJ/RK	88-89
TRX 250 V/W/X/Y/1/TM2 Re Con (Manual Shift)	97-14
TRX 250 TE2 Re Con ES (Electric Shift)	02-14
TRX 250 EX1/2/3/4/5/6/7/8	01-08
TRX 250 X9/XA/XB	09-11
VT 250 FL Spada/Castel	88-90
XL 250 K3/K4	78-79
XL 250 S/SZ/SA	78-81
XL 250 SB	82
XL 250 RE/RF	84-85
XL 250 RC	82
XL 250 RL	90
XL 250 Degree (MD26)	
XR 250 SZ/SA	79-80
XR 250 RB/RC/RD	81-83
XR 250 RE/RF	84-85
XR 250 RG/RH	86-87
XR 250 RJ/RK	88-89
XR 250 RL	90
XR 250 RM/RV/RP/RR/RS	91-95

FRONT / AVANT / VORN / FRENTE / ANTERIORE

FA, SFA, TT Pad or Brake Shoe	SFAC Carbon Scooter Pads	Speciality Pads - SXR / Vee / MXS	Sintered/HH Pads/ Grooved Shoes	Left / Gauche / Links Standard Replacement Disc	Right / Droite / Rechts Standard Replacement Disc	Contour Disc Universal left and right fitment	Custom Disc Universal left and right fitment	Vee-Disks Black † See note below	CX Extreme MX Race Disc/ UTVX Disc
FA185TT		MXS185	FA185R	MD6001D		MD6001C			MD6001CX
FA185TT		MXS185	FA185R	MD6001D		MD6001C			MD6001CX
SFA281	SFAC281		SFA281HH	MD922D				VR922	
SFA281	SFAC281		SFA281HH	MD922D				VR922	
H351									
FA040									
FA069/2									
FA124/2			FA124/2HH						
FA080/2									
FA069/2*				MD1006	MD1006	MD1006C*			
FA069/2*				MD1006	MD1006	MD1006C*			
			FA347HH*						
FA121*			FA121HH*	MD1129LS	MD1129RS				
FA187*			FA187HH*	MD1117LS	MD1117RS				
FA187*			FA187HH*	MD1117LS	MD1117RS				
FA187*			FA187HH*	MD1117LS	MD1117RS				
FA187*			FA187HH*	MD1117LS	MD1117RS				
FA187*			FA187HH*	MD1117LS	MD1117RS				
FA187*			FA187HH*	MD1117LS	MD1117RS				
FA187*			FA187HH*	MD1117LS	MD1117RS				
FA187*			FA187HH*	MD1117LS	MD1117RS				
FA187*			FA187HH*	MD1117LS	MD1117RS				
SFA281	SFAC281		SFA281HH	MD922D				VR922	
SFA388	SFAC388		SFA388HH	MD922D				VR922	
H333									
SFA388	SFAC388		SFA388HH	MD922D				VR922	
H333									
SFA388	SFAC388		SFA388HH	MD922D				VR922	
H333									
FA125TT		MXS125	FA125R	MD6008D					
FA125TT		MXS125	FA125R	MD6001D		MD6001C			MD6001CX
SFA388	SFAC388		SFA388HH	MD922D				VR922	
H304			H304G						
FA624TT									
H304			H304G						
H304			H304G						
H304			H304G						
H339*			H339G*						
FA125TT*		MXS125*	FA125R*	MD6046D	MD6046D				
FA125TT*		MXS125*	FA125R*	MD6006D	MD6006D				
H345*			H345G*						
H345*			H345G*						
H345*			H345G*						
FA084TT*		MXS084*	FA084R*	MD6006D	MD6006D				
FA084TT*		MXS084*	FA084R*	MD6006D	MD6006D				
FA142			FA142HH						
H311			H311G						
H312			H312G						
H312			H312G						
H330			H330G						
H330			H330G						
FA125TT		MXS125	FA125R	MD6001D		MD6001C			MD6001CX
FA185TT		MXS185	FA185R	MD6001D		MD6001C			MD6001CX
H312			H312G						
H327			H327G						
FA092TT			FA092R	MD6001D		MD6001C			MD6001CX
FA092TT			FA092R	MD6087D					
FA125TT		MXS125	FA125R	MD6087D					
FA125TT		MXS125	FA125R	MD6087D					
FA125TT		MXS125	FA125R	MD6001D		MD6001C			MD6001CX

Line #

*-2 Sets Required. † For Vee disc colours add RED, BLU, GRN, GLD, ORG suffix to part number. For Custom Finish Options for Vee-Rotors™ including Splatter discs add suffix CHR, CHGR, CHBL, CHBR - available in various colours see page iv. ☼ - Also available as a Vintage Motorcycle Disc.

JAPANESE Built Motorcycles

Line #	BRAKE DISC CHOICES - FRONT					DISC PAD CHOICES - REAR				BRAKE DISC CHOICES - REAR				
	Oversize 250 /280mm Disc Kit	OSX Oversize 250/280mm Disc Kit	Relocating Bracket for 250/ 280mm Disc	Oversize 320mm Disc Kit	SMX Oversize 320mm Disc Kit	Relocating Bracket for 320mm Disc	FA, SFA, TT Pad or Brake Shoe	SFAC Carbon Scooter Pads	Speciality Pads - SXR / Vee / MXS	Sintered/ HH Pads/ Grooved Shoes	Standard Replacement Disc	Contour Disc Rear fitment	Vee Discs CONTOUR	CX Extreme MX Race Disc
1		OSX6001	BRK008		SMX6001	BRK009	FA131TT		MXS131	FA131R	MD6013D	MD6013C		MD6013CX
2		OSX6001	BRK008		SMX6001	BRK009	FA131TT		MXS131	FA131R	MD6013D	MD6013C		MD6013CX
3							H351							
4							SFA140			SFA140HH	MD1004		VR1004	
5														
6							H306			H306G				
7							H318							
8							H318							
9							H315							
10							FA069/3				MD1002			
11							FA069/3				MD1002			
12														
13							FA069/3			FA069/3HH	MD1002			
14							FA140			FA140HH	MD1002			
15							FA140			FA140HH	MD1002			
16							FA140			FA140HH	MD1002			
17							FA140			FA140HH	MD1002			
18														
19							FA140			FA140HH	MD1002			
20							FA140			FA140HH	MD1002			
21							FA143				MD1111			
22							FA143				MD1111			
23														
24							SFA358			SFA358HH	MD1004		VR1004	
25							SFA415	SFAC415		SFA415HH	MD1020		VR1020	
26														
27							SFA415	SFAC415		SFA415HH	MD1020		VR1020	
28														
29							SFA415	SFAC415		SFA415HH	MD1020		VR1020	
30														
31							H323			H323G				
32							H323			H323G				
33							H351							
34							H304			H304G				
35							FA153							
36							H304			H304G				
37							H304			H304G				
38							H304			H304G				
39							H315			H315G				
40							FA092TT			FA092R	MD6007D			
41							FA092TT			FA092R	MD6007D			
42							H340			H340G				
43							H340			H340G				
44							H340			H340G				
45							H340			H340G				
46							FA140		FA140V	FA140HH	MD1002			
47							H312			H312G				
48							H323			H323G				
49							H318			H318G				
50							H323			H323G				
51							H323			H323G				
52							FA131TT		MXS131	FA131R	MD6013D	MD6013C		MD6013CX
53							H323			H323G				
54							H323			H323G				
55							H323			H323G				
56							H304			H304G				
57							H304			H304G				
58							H304			H304G				
59							FA131TT		MXS131	FA131R	MD6013D	MD6013C		MD6013CX
60	OS6001EC	OSX6001E	BRK004				FA131TT		MXS131	FA131R	MD6013D	MD6013C		MD6013CX

REAR / ARRIÈRE / HINTEN / POSTERIOR / POSTERIORE

R Suffix = High Durability Sintered Pad. **HH** Suffix = High Performance Sintered Pad. **TT** Suffix = Hard Wearing Off Road Pad. **V** Suffix = Semi Sintered Pad. **G** Suffix = Grooved Shoe.
D Suffix = Drilled Disc. **X** Suffix = Universal Left or Right Disc. **XC** Suffix = Contoured Disc. **LS** Suffix = Left/Steel Disc. **RS** = Right/Steel Disc.

*-2 Sets Required. † For Vee disc colours add RED, BLU, GRN, GLD, ORG suffix to part number. For Custom Finish Options for Vee-Rotors™ including Splatter discs add suffix CHR, CHGR, CHBL, CHBR - available in various colours see page iv. ☉ - Also available as a Vintage Motorcycle Disc.

Part numbers, prefixes, suffixes, photos and illustrations shown in this catalogue are trademarks and/or copyrights of EBC Brakes or the trademark owner A C Freeman Investments Ltd and use without express written permission of the owners is punishable by law.

JAPANESE Built Motorcycles



HONDA Contd.



DISC PAD CHOICES - FRONT

BRAKE DISC CHOICES - FRONT

R Suffix = High Durability Sintered Pad. HH Suffix = High Performance Sintered Pad. TT Suffix = Hard Wearing Off Road Pad. V Suffix = Semi Sintered Pad. G Suffix = Grooved Shoe.
 D Suffix = Drilled Disc. X Suffix = Universal Left or Right Disc. XC Suffix = Contoured Disc. LS Suffix = Left/Steel Disc. RS = Right/Steel Disc.

FRONT / AVANT / VORN / FRENTE / ANTERIORE

	FA, SFA, TT Pad or Brake Shoe	SFAC Carbon Scooter Pads	Speciality Pads - SXR / Vee / MXS	Sintered/HH Pads/ Grooved Shoes	Left / Gauche / Links Standard Replacement Disc	Right / Droite / Rechts Standard Replacement Disc	Contour Disc Universal left and right fitment	Custom Disc Universal left and right fitment	Vee-Disks Black † See note below	CX Extreme MX Race Disc/ UTVX Disc	Line #
XR 250 RT/RW/RX/RY/R1/R2/R3/R4	FA185TT		MXS185	FA185R	MD6001D		MD6001C			MD6001CX	1
XR 250 Y/3 (MD30)	FA185TT		MXS185	FA185R	MD6001D		MD6001C			MD6001CX	2
XR 250 3/5 (MD30) Motard	FA185TT		MXS185	FA185R	MD6001D		MD6001C			MD6001CX	3
XR 250 Tornado											4
XR 250 III Y/3 Baja	FA185TT		MXS185	FA185R	MD6001D		MD6001C			MD6001CX	5
XLR 250 Baja MK1 RF/R2F/RH (MD22)	FA092TT			FA092R	MD6001D		MD6001C			MD6001CX	6
XLR 250 Baja MK2 R3 (MD22)	FA185TT		MXS185	FA185R	MD6001D		MD6001C			MD6001CX	7
XLR 250 R/R3/RK/RL/R3L/R3M/RN (MD22)	FA092TT			FA092R	MD6087D						8
XLR 250 RM/R3N/RP/RR/R3R (MD22)	FA185TT		MXS185	FA185R	MD6001D		MD6001C			MD6001CX	9
VT 250 FD	FA080/2										10
VT 250 CR/CT/CV Magna	FA196			FA196HH	MD1021LS						11
VTR 250 W/Y/1-7 (MC33)	FA196			FA196HH		MD1144RS					12
VTR 250 9	FA196			FA196HH							13
VTZ 250 H/J/K	FA124/2			FA124/2HH							14
TLM 260	FA624TT										15
CB 300 R10	FA197			FA197HH		MD1166RS					16
CB 300 F AC (ABS)	FA226			FA226HH		MD1180X	MD1180XC				17
CB 300 FA AC (ABS)	FA226			FA226HH		MD1180X	MD1180XC				18
CB 300 R AC				FA679HH		MD1180X	MD1180XC				19
CBR 300 RAE (ABS Model)	FA142			FA142HH		MD1180X	MD1180XC				20
CBR 300 RA (ABS)	FA196			FA196HH		MD1180X	MD1180XC				21
CBR 300 R (Non ABS Model)	FA196			FA196HH		MD1180X	MD1180XC				22
CMX 300 Rebel (ABS)	FA196			FA196HH		TBA					23
CMX 300 Rebel (ABS incl. SE Models)	FA196			FA196HH		TBA					24
CRF 300 L (ABS)	FA465TT		MXS465	FA465R			MD6372C			MD6372CX	25
CRF 300 Rally (ABS)	FA465TT		MXS465	FA465R			MD6409C				26
NSS 300 AD Forza (ABS)	SFA388	SFAC388		SFA388HH		MD9119D					27
NSS 300 D Forza (Non ABS)	SFA388	SFAC388		SFA388HH		MD9119D					28
NSS 300 D Forza (ABS)	SFA196			SFA196HH		MD9119D					29
SH 300i 7/8/9/A/B (Non ABS Model)	SFA388	SFAC388		SFA388HH	MD9118D				VR9118		30
SH 300i A7/A8/A9/AA/AB/AC (ABS Model)	SFA388	SFAC388		SFA388HH	MD9118D				VR9118		31
SH 300i R8/R9/RA (Non ABS Model)	SFA388	SFAC388		SFA388HH	MD9118D				VR9118		32
SH 300i AR8/AR9/ARA (ABS Model)	SFA388	SFAC388		SFA388HH	MD9118D				VR9118		33
SH 300i (ABS Model)	SFA388	SFAC388		SFA388HH							34
SH 300i (2 Piston Caliper/ABS)	SFA196	SFAC196		SFA196HH	MD9118D						35
TRX 300 J/K/L/T/V/W/X/Y (2WD)	H345*			H345G*							36
TRX 300 F/W/J/K/L/T/V/W/X/Y (4WD)	H347*			H347G*							37
TRX 300 EX P/R/S/T/V/W/X/Y/1-8	FA084TT*		MXS084*	FA084R*	MD6006D	MD6006D					38
TRX 300 X9	FA084TT*		MXS084*	FA084R*	MD6006D	MD6006D					39
XR 300 R10	FA185TT		MXS185	FA185R	MD6010D					MD6010CX	40
CB 350 K4	H314										41
CB 350 SG/SJ	FA121*			FA121HH*	MD1005LS	MD1005RS					42
CBR 300 RAE (ABS Model)	FA142		FA142V	FA142HH		MD1180X					43
FL 350 R Odyssey	H339*			H339G*							44
NSS 350 D Forza ABS	SFA196*			SFA196HH	MD9119D						45
SH 350i (2 Piston Caliper/ABS)	SFA196			SFA196HH	MD9118D						46
SL 350 K0	H314										47
SL 350 K1/K2	H308										48
TRX 350 G/H/J/K/L/M/N	H342*			H342G*							49
TRX 350 Rancher ES 4 x 4/2 x 4 (FMV/1/2/3)											50
/Rancher 4 x 4 & 2 x 4 (FEV/1/2/3)	H347S*			H347SG*							51
XR 350 RD	H331			H331G							52
XR 350 RE	FA092TT			FA092R	MD6087D						53
CB 360 G5	FA013										54
CJ 360 T	FA013										55
CB-1 (CB 400 F)	FA142		FA142V	FA142HH		MD1038RS					56
CB 400 SF (F2N/F2R/F2S/F2T/F3S) Superfour (NC31)	FA142*		FA142V*	FA142HH*	MD1132	MD1132	MD1132C*				57
CB 400 SF (F2V/F3T) Superfour (NC31)	FA187*			FA187HH*	MD1132	MD1132	MD1132C*				58
CB 400 SF (F3V) Superfour (NC31)	FA244*			FA244HH*	MD1132	MD1132	MD1132C*				59
CB 400 F/F1/F2	FA013										60

*-2 Sets Required. † For Vee disc colours add RED, BLU, GRN, GLD, ORG suffix to part number. For Custom Finish Options for Vee-Rotors™ including Splatter discs add suffix CHR, CHGR, CHBL, CHBR - available in various colours see page iv. ☉ - Also available as a Vintage Motorcycle Disc.

JAPANESE Built Motorcycles

Line #	BRAKE DISC CHOICES - FRONT						DISC PAD CHOICES - REAR				BRAKE DISC CHOICES - REAR			
	Over-size 250 /280mm Disc Kit	OSX Over-size 250/280mm Disc Kit	Relocating Bracket for 250/ 280mm Disc	Over-size 320mm Disc Kit	SMX Over-size 320mm Disc Kit	Relocating Bracket for 320mm Disc	FA, SFA, TT Pad or Brake Shoe	SFAC Carbon Scooter Pads	Speciality Pads - SXR / Vee / MXS	Sintered/ HH Pads/ Grooved Shoes	Standard Replacement Disc	Contour Disc Rear fitment	Vee Discs CONTOUR	CX Extreme MX Race Disc
1		OSX6001	BRK008		SMX6001	BRK009	FA131TT		MXS131	FA131R	MD6013D	MD6013C		MD6013CX
2							FA131TT		MXS131	FA131R	MD6013D	MD6013C		MD6013CX
3							FA131TT		MXS131	FA131R	MD6013D	MD6013C		MD6013CX
4							H352							
5							FA131TT		MXS131	FA131R	MD6013D	MD6013C		MD6013CX
6							H323			H323G				
7							FA153				MD6013D	MD6013C		MD6013CX
8							FA153				MD6013D	MD6013C		
9							FA131TT		MXS131	FA131R	MD6013D	MD6013C		MD6013CX
10							H309							
11							H321							
12							FA140		FA140V	FA140HH	MD1004	MD1004C		
13							FA140		FA140V	FA140HH				
14							H309							
15							FA153							
16							H352							
17							FA496		FA496V	FA496HH	MD1181	MD1181C		
18							FA496		FA496V	FA496HH	TBA			
19							FA496		FA496V	FA496HH	TBA			
20														
21							FA496		FA496V	FA496HH				
22							FA496		FA496V	FA496HH	TBA			
23							FA496		FA496V	FA496HH	TBA			
24							FA496		FA496V	FA496HH	TBA			
25							FA629TT			FA629R		MD6373C		MD6373CX
26							FA629TT			FA629R		MD6373C		MD6373CX
27							SFA415	SFAC415		SFA415HH	MD9119D			
28							SFA415	SFAC415		SFA415HH	MD9119D			
29							SFA415	SFAC415		SFA415HH				
30							SFA415	SFAC415		SFA415HH	MD9119D		VR9119	
31							SFA415	SFAC415		SFA415HH	MD9119D		VR9119	
32							SFA415	SFAC415		SFA415HH	MD9119D		VR9119	
33							SFA415	SFAC415		SFA415HH	MD9119D		VR9119	
34							SFA415	SFAC415		SFA415HH				
35							SFA415	SFAC415		SFA415HH	MD9119D			
36							H315			H315G				
37							H315			H315G				
38							FA084TT		MXS084	FA084R	MD6064D			
39							FA084TT		MXS084	FA084R	MD6064D			
40				SM6010C	SMX6010C	BRK009	FA131TT		MXS131	FA131R	MD6013D			MD6013CX
41							H315							
42							H313							
43							FA496		FA496V	FA496HH	MD1181			
44							FA111			FA111R				
45							SFA415	SFAC415		SFA415HH	MD1149			
46							SFA415	SFAC415		SFA415HH	MD9119D			
47							H315							
48							H309							
49							H343			H343G				
50														
51							H351			H351G				
52							H304			H304G				
53							H304			H304G				
54							H315							
55							H315							
56							FA140		FA140V	FA140HH	MD1020			
57							FA140		FA140V	FA140HH	MD1020	MD1020C	VR1020	
58							FA140		FA140V	FA140HH	MD1020	MD1020C	VR1020	
59							FA140		FA140V	FA140HH	MD1020	MD1020C	VR1020	
60							H315							

REAR / ARRIÈRE / HINTEN / POSTERIOR / POSTERIORE

R Suffix = High Durability Sintered Pad. **HH** Suffix = High Performance Sintered Pad. **TT** Suffix = Hard Wearing Off Road Pad. **V** Suffix = Semi Sintered Pad. **G** Suffix = Grooved Shoe.
D Suffix = Drilled Disc. **X** Suffix = Universal Left or Right Disc. **XC** Suffix = Contoured Disc. **LS** Suffix = Left/Steel Disc. **RS** = Right/Steel Disc.

*-2 Sets Required. † For Vee disc colours add RED, BLU, GRN, GLD, ORG suffix to part number. For Custom Finish Options for Vee-Rotors™ including Splatter discs add suffix CHR, CHGR, CHBL, CHBR - available in various colours see page iv. ☉ - Also available as a Vintage Motorcycle Disc.

Part numbers, prefixes, suffixes, photos and illustrations shown in this catalogue are trademarks and/or copyrights of EBC Brakes or the trademark owner A C Freeman Investments Ltd and use without express written permission of the owners is punishable by law.

JAPANESE Built Motorcycles



HONDA Contd.



DISC PAD CHOICES - FRONT

BRAKE DISC CHOICES - FRONT

R Suffix = High Durability Sintered Pad. **HH** Suffix = High Performance Sintered Pad. **TT** Suffix = Hard Wearing Off Road Pad. **V** Suffix = Semi Sintered Pad. **G** Suffix = Grooved Shoe.
D Suffix = Drilled Disc. **X** Suffix = Universal Left or Right Disc. **XS** Suffix = Contoured Disc. **LS** Suffix = Left/Steel Disc. **RS** = Right/Steel Disc.

FA, SFA, TT Pad or Brake Shoe | **SFAC Carbon Scooter Pads** | **Speciality Pads - SXR / Vee / MXS** | **Sintered/HH Pads/ Grooved Shoes** | **Left / Gauche / Links Standard Replacement Disc** | **Right / Droite / Rechts Standard Replacement Disc** | **Contour Disc Universal left and right fitment** | **Custom Disc Universal left and right fitment** | **Vee-Disks Black † See note below** | **CX Extreme MX Race Disc/ UTVX Disc**

Model	FA, SFA, TT Pad or Brake Shoe	SFAC Carbon Scooter Pads	Speciality Pads - SXR / Vee / MXS	Sintered/HH Pads/ Grooved Shoes	Left / Gauche / Links Standard Replacement Disc	Right / Droite / Rechts Standard Replacement Disc	Contour Disc Universal left and right fitment	Custom Disc Universal left and right fitment	Vee-Disks Black † See note below	CX Extreme MX Race Disc/ UTVX Disc	Line #
CB 400 A Honda-Matic	FA045										1
CB 400 T	FA045										2
CB 400 N/NA/NB	FA030*										3
CB 400 NC	FA069/2*										4
CB 400 Four VV-II/W/W-II (NC36)	FA142*		FA142V*	FA142HH*							5
CB 400 SFX/SFY/SF1/SF2/SF3 Superfour (NC39 - Superfour/Superfour Bol D'Or)99-03			FA296HH*								6
CB 400 SS (SS2-NC41)	FA196			FA196HH							7
CB 400 SF4/5/S5 (NC39 - Superfour/Superfour Bol D'Or)				FA296HH*							8
CB 400 SS (SS2-NC41)	FA196			FA196HH							9
CB 400 SF4/5/S5 (NC39 - Superfour/Superfour Bol D'Or)				FA296HH*							10
CB 400 RG (NC23) 100	FA121*			FA121HH*	MD1001	MD1001					11
CB 400 RH-YA (NC23) 101	FA121*			FA121HH*	MD1001	MD1001					12
CB 400 RRJ/RRK (NC23) Tri-Arm (102/109)	FA142*		FA142V*	FA142HH*	MD1003X	MD1003X	MD1003XC*	MD1003CC*	VR1003BLK*†		13
CB 400 RRL/RRN/RRR (NC29) Gull Arm	FA142*		FA142V*	FA142HH*	MD1003X	MD1003X	MD1003XC*	MD1003CC*	VR1003BLK*†		14
CL 400 (NC38)	FA196			FA196HH							15
FJS 400 Silverwing D6/D7/D8											16
Non ABS 256mm front disc	06-08	SFA281	SFAC281	SFA281HH	MD1006		MD1006C				17
FJS 400 Silverwing D6/D7/D8											18
Non ABS 256mm front disc - Parking Brake	06-08	SFA257/2									19
FL 400 R RK/RL Pilot	89-93	H339*		H339G*							20
NS 400 RF/RG	85-87	FA069*		FA069HH*	MD1006	MD1006	MD1006C*				21
NT 400 Bros (NC25)		FA187		FA187HH	MD1124LS						22
NV 400 CJ/CK Steed	92-93	FA124/2		FA124/2HH							23
NV 400 CS/CV Steed	95-97	FA142	FA142V	FA142HH							24
NV 400 DCY/DC1/DC2 (NC40) Shadow Slasher	00-02	FA196		FA196HH	MD1159						25
NX 4 Falcon	02-05	FA185TT	MXS185	FA185R							26
RVF 400 RR/RR-II/RT/RT-II (NC35)	94-96	FA187*		FA187HH*	MD1003X	MD1003X	MD1003XC*	MD1003CC*	VR1003BLK*†		27
SW-T 400 (FJS 400 D9)	09	SFA388	SFAC388	SFA388HH	MD1172LS						28
SW-T 400 (FJS 400 D9) - Parking Brake	09	SFA257/2									29
SW-T 400 (FJS 400 A9/AB)	09-16	SFA388	SFAC388	SFA388HH	MD1172LS						30
SW-T 400 (FJS 400 A9/AB) - Parking Brake	09-16	SFA257/2									31
TRX 400 FWS/T/V/W/X/Y	95-00	H347*		H347G*							32
TRX 400 EXX/EXY/EX1-EX8	99-08	FA084TT*	MXS084*	FA084R*	MD6006D	MD6006D					33
TRX 400 FA4/5/6/7 Fourtrax AT	04-07	H347*		H347G*							34
TRX 400 FGA4/5/6/7 Fourtrax Rancher at Gscape	04-07	H347*		H347G*							35
TRX 400 X9	09	FA084TT*	MXS084*	FA084R*	MD6006D	MD6006D					36
VF 400 FD	83-85	FA080/2									37
VFR 400 ZG/ZH/RG/RG-YA (NC21)	85-87	FA121*		FA121HH*	MD1006	MD1006	MD1006C*				38
VFR 400 RH2/RJ (NC24)	87-88	FA121*		FA121HH*	MD1001	MD1001					39
VFR 400 R3K/R3N (NC30)	89-92	FA187*		FA187HH*	MD1003X	MD1003X	MD1003XC*	MD1003CC*	VR1003BLK*†		40
VFR 400 R3L/R3M (NC30)	90-91	FA187*		FA187HH*	MD1003X	MD1003X	MD1003XC*	MD1003CC*	VR1003BLK*†		41
VRX 400 T (NC33)	96	FA196		FA196HH							42
XL 400 R	82	H332		H332G							43
XR 400 RT/RW/RX/RX/R1/R2/R3/R4	96-04	FA185TT	MXS185	FA185R	MD6001D		MD6001C			MD6001CX	44
XR 400 M Supermotard (ND08/NC38E)	06-08	FA142		FA142HH							45
TRX 420 FE7/FE8/FE9/FEA/FEB 4WD Fourtrax ES	07-11	FA084TT*	MXS084*	FA084R*	MD6302D	MD6302D					46
TRX 420 FM7/FM8/FM9/FMA/FMB 4WD Fourtrax Auto	07-11	FA084TT*	MXS084*	FA084R*	MD6302D	MD6302D					47
TRX 420 FPA9/FPAA/FPAB											48
Fourtrax Auto - Power Steering	09-11	FA084TT*	MXS084*	FA084R*	MD6302D	MD6302D					49
TRX 420 FA9/FAA/FAB Fourtrax Auto 4WD	09-11	FA084TT*	MXS084*	FA084R*	MD6302D	MD6302D					50
TRX 420 FPM9/FPMA/FPMB Fourtrax 4WD - Power Steering	09-11	FA084TT*	MXS084*	FA084R*	MD6302D	MD6302D					51
TRX 420 TE7/TE8/TE9 Fourtrax ES 2WD	07-09	FA084TT*	MXS084*	FA084R*	MD6302D	MD6302D					52
TRX 420 TM7/TM8/TM9/TMA/TMB	07-11	FA084TT*	MXS084*	FA084R*	MD6302D	MD6302D					53
TRX 420 All models	14-21	FA084TT*	MXS084*	FA084R*	MD6302D	MD6302D					54
CB 450 SG/SJ	86-88	FA121*		FA121HH*	MD1005LS	MD1005RS					55
CB 450 DX-K	89-92	FA122*									56
CMX 450 CH/CJ Rebel	87-88	FA069		FA069HH	MD1041LS						57
CR 450 RB	81	H327		H327G							58
CRF 450 L 18" Rear Wheel	18-20	FA185TT	MXS185	FA185R						TBC	59
♦ Plain undrilled disc for enduro use MD6191CE											60

*-2 Sets Required. † For Vee disc colours add RED, BLU, GRN, GLD, ORG suffix to part number. For Custom Finish Options for Vee-Rotors™ including Splatter discs add suffix CHR, CHGR, CHBL, CHBR - available in various colours see page iv. ☉ - Also available as a Vintage Motorcycle Disc.

JAPANESE Built Motorcycles

Line #	BRAKE DISC CHOICES - FRONT						DISC PAD CHOICES - REAR				BRAKE DISC CHOICES - REAR			
	Oversize 250 /280mm Disc Kit	OSX Oversize 250/280mm Disc Kit	Relocating Bracket for 250/ 280mm Disc	Oversize 320mm Disc Kit	SMX Oversize 320mm Disc Kit	Relocating Bracket for 320mm Disc	FA, SFA, TT Pad or Brake Shoe	SFAC Carbon Scooter Pads	Speciality Pads - SXR / Vee / MXS	Sintered/ HH Pads/ Grooved Shoes	Standard Replacement Disc	Contour Disc Rear fitment	Vee Discs CONTOUR	CX Extreme MX Race Disc
1							H313							
2							H313							
3							H313							
4							H313							
5							FA140		FA140V	FA140HH	MD1020			
6														
7						FA254		FA254V	FA254HH					
8							H351							
9							FA174		FA174V	FA174HH				
10							FA069/3		FA069/3V	FA069/3HH	MD1002			
11							FA069/3		FA069/3V	FA069/3HH	MD1002			
12							FA140		FA140V	FA140HH	MD1002			
13							FA140		FA140V	FA140HH	MD1004	MD1004C	VR1004	
14							H351							
15														
16							SFA196			FA196HH	MD1149	MD1149C		
17														
18														
19							FA111			FA111R	MD6144D			
20							FA069		FA069V	FA069HH	MD1002			
21							FA140		FA140V	FA140HH	MD1022			
22							H321							
23							H321							
24							H343							
25							FA131TT		MXS131	FA131R	MD1004			
26							FA143				MD1111			
27							SFA196	SFAC196		SFA196HH	MD1149			
28														
29							SFA196	SFAC196		SFA196HH	MD1149			
30														
31							H351			H351G				
32							FA084TT			FA084R	MD6164D			
33							H351			H351G				
34							H351			H351G				
35							FA084TT			FA084R	MD6164D			
36							FA080/2							
37							FA069/3		FA069/3V	FA069/3HH	MD1002			
38							FA140		FA140V	FA140HH	MD1022			
39							FA143				MD1111			
40							FA143				MD1111			
41							FA174		FA174V	FA174HH				
42							H318			H318G				
43		OSX6001	BRK008		SMX6001	BRK009	FA131TT		MXS131	FA131R	MD6013D	MD6013C		MD6013CX
44							FA131TT		MXS131	FA131R				
45							H351			H351G				
46							H351			H351G				
47														
48							FA373TT			FA373R	MD6217D			
49							FA373TT			FA373R	MD6217D			
50														
51							H351			H351G				
52							H351			H351G				
53							H351			H351G				
54							FA373TT			FA373R	MD1195			
55							H313							
56							FA122							
57							H313							
58							H319			H319G				
59							FA346TT		MXS346	FA346R	MD6191D	MD6191C		MD6191CX
60														

REAR / ARRIÈRE / HINTEN / POSTERIOR / POSTERIORE

R Suffix = High Durability Sintered Pad. **HH** Suffix = High Performance Sintered Pad. **TT** Suffix = Hard Wearing Off Road Pad. **V** Suffix = Semi Sintered Pad. **G** Suffix = Grooved Shoe.
D Suffix = Drilled Disc. **X** Suffix = Universal Left or Right Disc. **XC** Suffix = Contoured Disc. **LS** Suffix = Left/Steel Disc. **RS** = Right/Steel Disc.

*-2 Sets Required. † For Vee disc colours add RED, BLU, GRN, GLD, ORG suffix to part number. For Custom Finish Options for Vee-Rotors™ including Splatter discs add suffix CHR, CHGR, CHBL, CHBR - available in various colours see page iv. Ⓢ - Also available as a Vintage Motorcycle Disc.

Part numbers, prefixes, suffixes, photos and illustrations shown in this catalogue are trademarks and/or copyrights of EBC Brakes or the trademark owner A C Freeman Investments Ltd and use without express written permission of the owners is punishable by law.

JAPANESE Built Motorcycles



HONDA Contd.



DISC PAD CHOICES - FRONT

BRAKE DISC CHOICES - FRONT

R Suffix = High Durability Sintered Pad. **HH** Suffix = High Performance Sintered Pad. **TT** Suffix = Hard Wearing Off Road Pad. **V** Suffix = Semi Sintered Pad. **G** Suffix = Grooved Shoe.

D Suffix = Drilled Disc. **X** Suffix = Universal Left or Right Disc. **XS** Suffix = Contoured Disc. **LS** Suffix = Left/Steel Disc. **RS** = Right/Steel Disc.

FRONT / AVANT / VORN / FRENTE / ANTERIORE

	FA, SFA, TT Pad or Brake Shoe	SFAC Carbon Scooter Pads	Speciality Pads - SXR / Vee / MXS	Sintered/HH Pads/ Grooved Shoes	Left / Gauche / Links Standard Replacement Disc	Right / Droite / Rechts Standard Replacement Disc	Contour Disc Universal left and right fitment	Custom Disc Universal left and right fitment	Vee-Disks Black † See note below	CX Extreme MX Race Disc/ UTVX Disc	Line #
CRF 450 R2/R3	FA185TT		MXS185	FA185R	MD6037D		MD6037C			MD6037CX	1
♦ Plain undrilled disc for enduro use MD6191CE											2
CRF 450 R4/R5/R6/R7	FA185TT		MXS185	FA185R	MD6037D		MD6037C			MD6037CX	3
♦ Plain undrilled disc for enduro use MD6191CE											4
CRF 450 R8/R9/RA/RB/RC/RD/RE	FA185TT		MXS185	FA185R			MD6037C			MD6037CX	5
♦ Plain undrilled disc for enduro use MD6191CE											6
CRF 450 R (260mm F/Disc)	FA185TT		MXS185	FA185R			MD6389C			MD6389CX	7
♦ Plain undrilled disc for enduro use MD6191CE											8
CRF 450 RL 18" Rear Wheel, 260mm F/Disc, 240mm R/Disc	FA185TT		MXS185	FA185R			MD6389C			TBC	9
♦ Plain undrilled disc for enduro use MD6191CE											10
CRF 450 R-S 260mm F/Disc, 240mm R/Disc	FA185TT		MXS185	FA185R			MD6389C			MD6389CX	11
♦ Plain undrilled disc for enduro use MD6191CE											12
CRF 45 RWE 260mm F/Disc, 240mm R/Disc	FA185TT		MXS185	FA185R			MD6389C			MD6389CX	13
♦ Plain undrilled disc for enduro use MD6191CE											14
CRF 450 RX (18 Inch Rear Wheel)	FA185TT		MXS185	FA185R			MD6389C			MD6389CX	15
♦ Plain undrilled disc for enduro use MD6191CE											16
CRF 450 X5/X6/X7	FA185TT		MXS185	FA185R	MD6037D		MD6037C			MD6037CX	17
♦ Plain undrilled disc for enduro use MD6191CE											18
CRF 450 X	FA185TT		MXS185	FA185R			MD6037C			MD6037CX	19
♦ Plain undrilled disc for enduro use MD6191CE											20
CRF 450 XRL (Road Legal)	FA185TT		MXS185	FA185R			MD6037C			MD6037CX	21
♦ Plain undrilled disc for enduro use MD6191CE											22
TRX 450 ESW/ESX/ESY/ES1	H347S*			H347SG*							23
TRX 450 R4/R5/R6/ER6/R7/ER7/R8/ER8/R9/ER9	FA185TT*		MXS185*	FA185R*	MD6006D	MD6006D					24
CR 480 RC	H327			H327G							25
CR 480 RD	H328			H328G							26
CB 500 FD/FE/FF (Non ABS)	FA196		FA196V	FA196HH		MD1200					27
CB 500 T (Twin)	FA013										28
CB 500 K1/K2/F (Four)	FA013							VMD1042			29
CB 500 R/T (Twin)	FA196			FA196HH		MD1008					30
CB 500 V/W/SW/X/SX/Y/SY/2/S2 (Twin)	FA209/2			FA209/2HH		MD1008					31
CB 500 X (Twin/Non ABS)	FA196		FA196V	FA196HH							32
CBF 500 A4/A5/A6/A7 (ABS Model)	FA388			FA388HH		MD1155RS					33
CBF 500 4 (Non ABS Model)	FA196			FA196HH		MD1155RS					34
CBR 500 FH/FJ/FK/FL (Four)	FA121*			FA121HH*	MD1001	MD1001					35
CB 500 F (Non ABS)	FA196			FA196HH			MD1200C				36
CB 500 FA (ABS)	FA196			FA196HH			MD1200C				37
CB 500 X (Non ABS)	FA196			FA196HH			MD1200C				38
CB 500 XA (ABS)	FA196			FA196HH			MD1200C				39
CBR 500 R (Non ABS)	FA196			FA196HH			MD1200C				40
CBR 500 RA (ABS)	FA196			FA196HH			MD1200C				41
CMX 500 Rebel (Non ABS)	FA196			FA196HH							42
CMX 500 Rebel (ABS)	FA196			FA196HH							43
CR 500 RE/RF	FA092TT			FA092R	MD6087D						44
CR 500 RG	FA092TT			FA092R	MD6087D						45
CR 500 RH/RJ	FA125TT		MXS125	FA125R	MD6087D						46
CR 500 RK	FA125TT		MXS125	FA125R	MD6008D						47
CR 500 RL/RM	FA125TT		MXS125	FA125R	MD6003D						48
CR 500 RN/RP/RR	FA125TT		MXS125	FA125R	MD6001D		MD6001C			MD6001CX	49
CR 500 RS/RT/RV/RW/RX/RV/R1	FA185TT		MXS185	FA185R	MD6037D		MD6037C			MD6037CX	50
CX 500 CA/CB/Z/A/B	FA029*										51
CX 500 CC	FA069*			FA069HH*							52
CX 500 EC	FA069*			FA069HH*	MD1036LS	MD1036RS					53
FT 500 C	FA069			FA069HH	MD1131LS						54
GL 500 DC	FA069*			FA069HH*							55
CX 500 TCC Turbo	FA069*			FA069HH*							56
NX 500 J/K/L/M Dominator	FA124/2			FA124/2HH	MD6010D					MD6010CX	57
NX 500 N/P/R/S/T	FA124/2			FA124/2HH	MD6010D					MD6010CX	58
NX 500 V/W/X Dominator	FA209/2			FA209/2HH	MD6010D					MD6010CX	59
SXS 500 M2 Pioneer (2 Seat)	FA712TT*		MXS084*	FA712R*	MD6341D	MD6341D					60

*-2 Sets Required. † For Vee disc colours add RED, BLU, GRN, GLD, ORG suffix to part number. For Custom Finish Options for Vee-Rotors™ including Splatter discs add suffix CHR, CHGR, CHBL, CHBR - available in various colours see page iv. Ⓢ - Also available as a Vintage Motorcycle Disc.

JAPANESE Built Motorcycles

Line #	BRAKE DISC CHOICES - FRONT						DISC PAD CHOICES - REAR				BRAKE DISC CHOICES - REAR			
	Oversize 250 /280mm Disc Kit	OSX Oversize 250/280mm Disc Kit	Relocating Bracket for 250/ 280mm Disc	Oversize 320mm Disc Kit	SMX Oversize 320mm Disc Kit	Relocating Bracket for 320mm Disc	FA, SFA, TT Pad or Brake Shoe	SFAC Carbon Scooter Pads	Speciality Pads - SXR / Vee / MXS	Sintered/ HH Pads/ Grooved Shoes	Standard Replacement Disc	Contour Disc Rear fitment	Vee Discs CONTOUR	CX Extreme MX Race Disc
1	OS6037C	OSX6037	BRK008		SMX6037	BRK009	FA346TT		MXS346	FA346R	MD6191D	MD6191C♦		MD6191CX
2														
3	OS6437C	OSX6437	BRK005		SMX6437	BRK006	FA346TT		MXS346	FA346R	MD6191D	MD6191C♦		MD6191CX
4														
5	OS6437C	OSX6437	BRK005	SM6437C	SMX6437	BRK006	FA346TT		MXS346	FA346R		MD6191C♦		MD6191CX
6														
7		OSX6389	BRK042		SMX6389	BRK041	FA346TT		MXS346	FA346R		MD6191C♦		MD6191CX
8														
9							FA346TT		MXS346	FA346R	MD6191D	MD6191C♦		MD6191CX
10														
11							FA346TT		MXS346	FA346R	MD6191D	MD6191C♦		MD6191CX
12														
13							FA346TT		MXS346	FA346R	MD6191D	MD6191C♦		MD6191CX
14														
15		OSX6389	BRK042		SMX6389	BRK041	FA346TT		MXS346	FA346R		MD6191C♦		MD6191CX
16														
17	OS6437C	OSX6437	BRK005		SMX6437	BRK006	FA346TT		MXS346	FA346R	MD6191D	MD6191C♦		MD6191CX
18														
19	OS6437C	OSX6437	BRK005		SMX6437	BRK006	FA346TT		MXS346	FA346R		MD6191C♦		MD6191CX
20														
21	OS6437C	OSX6437	BRK005		SMX6437	BRK006	FA346TT		MXS346	FA346R		MD6191C♦		MD6191CX
22														
23							H351			H351G				
24							FA373TT			FA373R	MD6233D			
25							H330			H330G				
26							H331			H331G				
27							FA496	FA496V	FA496HH					
28							H316							
29							H316							
30							H321							
31							FA213		FA213HH	MD1020				
32							FA140	FA140V	FA140HH					
33							FA174	FA174V	FA174HH	MD1156				
34							FA174	FA174V	FA174HH	MD1156				
35							FA069/3	FA069/3V	FA069/3HH	MD1002				
36							FA140		FA140HH					
37							FA140		FA140HH					
38							FA140		FA140HH					
39							FA140		FA140HH					
40							FA140		FA140HH					
41							FA140		FA140HH	MD1156				
42							FA140		FA140HH					
43							FA140		FA140HH					
44							H331		H331G					
45							H344		H344G					
46							FA131TT	MXS131	FA131R	MD6009D				
47							FA131TT	MXS131	FA131R	MD6002D				
48							FA131TT	MXS131	FA131R	MD6002D				
49	OS6001EC	OSX6001E	BRK004				FA131TT	MXS131	FA131R	MD6002D				
50	OS6037C	OSX6037	BRK008		SMX6037	BRK009	FA131TT	MXS131	FA131R	MD6002D				
51							H321							
52							H321							
53							FA069	FA069V	FA069HH					
54							FA069	FA069V	FA069HH	MD1048				
55							H321							
56							FA069	FA069V	FA069HH					
57				SM6010C	SMX6010	BRK009	FA140		FA140HH	MD6013D				MD6013CX
58				SM6010C	SMX6010	BRK009	FA140		FA140HH	MD6099D				
59				SM6010C	SMX6010	BRK009	FA213		FA213HH	MD6099D				
60							FA714TT		FA714R	MD6217D				

REAR / ARRIÈRE / HINTEN / POSTERIOR / POSTERIORE

R Suffix = High Durability Sintered Pad. **HH** Suffix = High Performance Sintered Pad. **TT** Suffix = Hard Wearing Off Road Pad. **V** Suffix = Semi Sintered Pad. **G** Suffix = Grooved Shoe.
D Suffix = Drilled Disc. **X** Suffix = Universal Left or Right Disc. **XC** Suffix = Contoured Disc. **LS** Suffix = Left/Steel Disc. **RS** = Right/Steel Disc.

BRAKE APPLICATIONS

*-2 Sets Required. † For Vee disc colours add RED, BLU, GRN, GLD, ORG suffix to part number. For Custom Finish Options for Vee-Rotors™ including Splatter discs add suffix CHR, CHGR, CHBL, CHBR - available in various colours see page iv. Ⓢ - Also available as a Vintage Motorcycle Disc.

JAPANESE Built Motorcycles



HONDA Contd.



DISC PAD CHOICES - FRONT

BRAKE DISC CHOICES - FRONT

		FA, SFA, TT Pad or Brake Shoe	SFAC Carbon Scooter Pads	Speciality Pads - SXR / Vee / MXS	Sintered/HH Pads/ Grooved Shoes	Left / Gauche / Links Standard Replacement Disc	Right / Droite / Rechts Standard Replacement Disc	Contour Disc Universal left and right fitment	Custom Disc Universal left and right fitment	Vee-Disks Black † See note below	CX Extreme MX Race Disc/ UTVX Disc	Line #
TRX 500 FA1/FA2/FA3/FA4/FA5/FA6/FA7/FA8/FA9 /FAA/FAB Fourtrax Foreman - Auto	01-04	H347*			H347G*							1
TRX 500 FA5/FA6/FA7/FA8/FA9/FAA/FAB Fourtrax Foreman - Auto	05-11	FA410TT*			FA410R*	MD6251D	MD6251D					2
TRX 500 FAC Fourtrax Foreman AT 2/4 WD	12	FA084TT*			FA084R*	MD6365D	MD6365D					3
TRX 500 FE5/FE6/FE7/FE8/FE9/FAA/FAB Fourtrax Foreman 4WD/ES	05-11	FA410TT*			FA410R*	MD6251D	MD6251D					4
TRX 500 FEC Fourtrax Foreman ES 2/4 WD	12	FA084TT*			FA084R*	MD6365D	MD6365D					5
TRX 500 FM5/FM6/FM7/FM8/FM9/FMA/FMB Fourtrax Foreman 4 x 4	05-11	FA410TT*			FA410R*	MD6251D	MD6251D					6
TRX 500 FMC Fourtrax Foreman S 2/4 WD	12	FA084TT*			FA084R*	MD6365D	MD6365D					7
TRX 500 FPE8/FPE9/FPEA/FPEB Fourtrax Foreman - Power Steering	05-11	FA410TT*			FA410R*	MD6251D	MD6251D					8
TRX 500 FPAC Fourtrax Foreman 2/4 WD	12	FA084TT*			FA084R*	MD6365D	MD6365D					9
TRX 500 TM5/TM6 Fourtrax Foreman	05-06	FA410TT*			FA410R*	MD6251D	MD6251D					10
TRX 500 All models	14-21	FA084TT*			FA084R*	MD6302D*						11
VF 500 FE/F2E/FF/F2F	84-85	FA069*			FA069HH*	MD1006	MD1006	MD1006C*		VR1006*		12
VT 500 ED/EF	83-85	FA080/2										13
XL 500 SZ	80	H312			H312G							14
XL 500 SB	81	H325			H325G							15
XL 500 RC	82	H332			H332G							16
XR 500 SZ/SA	79-80	H324			H324G							17
XR 500 RB	81	H327			H327G							18
XR 500 RD/RE	84-85	FA092TT			FA092R	MD6001D					MD6001CX	19
XBR 500 F/G/H/SJ	85-89	FA069			FA069HH	MD1001						20
CB 550 F/F1/F2/K3	78-80	FA013							VMD1042			21
CBX 550 FC/F2C/FD/F2D	82-84	FA080*										22
CB 600 FW/FX Hornet (16 Inch wheel)	98-99	FA226*			FA226HH*	MD1132	MD1132	MD1132C*				23
CB 600 FY/F1/F2/F3/F4/F5/F6 Hornet (17 Inch wheel)	00-06	FA226*			FA226HH*	MD1139	MD1139	MD1139C*				24
CB 600 F7/F8/F9/FA/FB/FC Hornet	07-13	FA226*			FA226HH*	MD1168X	MD1168X	MD1168XC*				25
CB 600 FA7/FA7/FA8/FA9/FAA/FAB/FAC Hornet (ABS)	07-13	FA388*			FA388HH*	MD1168X	MD1168X	MD1168XC*				26
CB 600 F2Y/F21/F22 Hornet S (17 Inch wheel)	00-04	FA226*			FA226HH*	MD1139	MD1139	MD1139C*				27
CBF 600 N4/S4/N5/N6	04-06	FA226*			FA226HH*	MD1008	MD1008					28
CBF 600 N8/N9/NA (Non ABS)	08-11	FA226*			FA226HH*	MD1160	MD1160					29
CBF 600 NA4/NA5/NA6 (ABS Model)	04-06	FA226*			FA226HH*	MD1008	MD1008					30
CBF 600 NA8/NA9/NAA (ABS)	08-11	FA388*			FA388HH*	MD1160	MD1160					31
CBF 600 S4/S5 (Non ABS)	04-05	FA226*			FA226HH*	MD1008	MD1008					32
CBF 600 S8/S9 (Non ABS)	08-09	FA226*			FA226HH*	MD1160	MD1160					33
CBF 600 SA4/SA5/SA6/SA7 (ABS Model)	04-08	FA226*			FA226HH*	MD1008	MD1008					34
CBF 600 SA8/SA9/SAA (ABS)	08-12	FA388*			FA388HH*	MD1160	MD1160					35
CBR 600 FH/FJ/FK/FL	87-90	FA121*			FA121HH*	MD1001	MD1001					36
CBR 600 FM/FN/FP/FR	91-94	FA203*			FA203HH*	MD1001	MD1001					37
CBR 600 FM/FN/FP/FR - Floating Disc Conversion Option	91-94	FA203*			FA203HH*	MD601LS	MD601RS					38
CBR 600 FS/FT/FV/FW	95-98	FA226*			FA226HH*	MD1003X	MD1003X	MD1003XC*	MD1003CC*	VR1003BLK*†		39
CBR 600 FX/FY	99-00				FA296HH*	MD1014X	MD1014X	MD1014XC*	MD1014CC*	VR1014BLK*†		40
CBR 600 F1/F2/ CBR 600 FS1/FS2 Sport	01-02				FA296HH*	MD1141X	MD1141X	MD1141XC*	MD1141CC*	VR1141BLK*†		41
CBR 600 F3/F4/F5/F6	03-06				FA296HH*	MD1141X	MD1141X	MD1141XC*	MD1141CC*	VR1141BLK*†		42
CBR 600 FB/FC (Non ABS Model)	11-13	FA226*			FA226HH*	MD1168X	MD1168X	MD1168XC*				43
CBR 600 FAB/FAC (ABS Model)	11-13	FA388*			FA388HH*	MD1168X	MD1168X	MD1168XC*				44
CBR 600 RR3/RR4	03-04				FA296HH*	MD1152X	MD1152X	MD1152XC*	MD1152CC*	VR1152BLK*†		45
CBR 600 RR5/RR6 (Radial Caliper)	05-06				FA390HH*	MD1152X	MD1152X	MD1152XC*	MD1152CC*	VR1152BLK*†		46
CBR 600 RR7/RR8/RR9/RAA/RAB/RAC/RAD/RAG												47
CBR 600 RR/RR6 (Radial Caliper)	07-16				FA390HH*	MD1152X	MD1152X	MD1152XC*	MD1152CC*	VR1152BLK*†		48
CBR 600 RR Hannspree	08				FA390HH*	MD1152X	MD1152X	MD1152XC*	MD1152CC*	VR1152BLK*†		49
CBR 600 RR RA9/RAA/RAB/RAC/RAD/RAG (C-ABS)	09-16				FA390HH*	MD1152X	MD1152X	MD1152XC*	MD1152CC*	VR1152BLK*†		50
CBR 600 RR	17-20				FA700HH*	MD1152X	MD1152X	MD1152XC*	MD1152CC*	VR1152BLK*†		51
CBR 600 RR ABS	17-21				FA700HH*	MD1152X	MD1152X	MD1152XC*	MD1152CC*	VR1152BLK*†		52

FRONT / AVANT / VORN / FRENTE / ANTERIORE

R Suffix = High Durability Sintered Pad. HH Suffix = High Performance Sintered Pad. TT Suffix = Hard Wearing Off Road Pad. V Suffix = Semi Sintered Pad. G Suffix = Grooved Shoe. D Suffix = Drilled Disc. X Suffix = Universal Left or Right Disc. XC Suffix = Contoured Disc. LS Suffix = Left/Steel Disc. RS = Right/Steel Disc.

*-2 Sets Required. † For Vee disc colours add RED, BLU, GRN, GLD, ORG suffix to part number. For Custom Finish Options for Vee-Rotors™ including Splatter discs add suffix CHR, CHGR, CHBL, CHBR - available in various colours see page iv. ☼ - Also available as a Vintage Motorcycle Disc.

JAPANESE Built Motorcycles

Line #	BRAKE DISC CHOICES - FRONT						DISC PAD CHOICES - REAR				BRAKE DISC CHOICES - REAR			
	OverSize 250 /280mm Disc Kit	OSX OverSize 250/280mm Disc Kit	Relocating Bracket for 250/ 280mm Disc	OverSize 320mm Disc Kit	SMX OverSize 320mm Disc Kit	Relocating Bracket for 320mm Disc	FA, SFA, TT Pad or Brake Shoe	SFAC Carbon Scooter Pads	Speciality Pads - SXR / Vee / MXS	Sintered/ HH Pads/ Grooved Shoes	Standard Replacement Disc	Contour Disc Rear fitment	Vee Discs CONTOUR	CX Extreme MX Race Disc
1														
2							H343			H343G				
3														
4							H343			H343G				
5							H343			H343G				
6														
7							H343			H343G				
8							H343			H343G				
9														
10							H343			H343G				
11							H343			H343G				
12														
13							H343			H343G				
14							H343			H343G				
15							H343			H343G				
16							FA373TT			FA373R	MD1195			
17							FA069	FA069V	FA069HH	MD1006	MD1006C	VR1006		
18							H313							
19							H318			H318G				
20							H309							
21							H318			H318G				
22							H318			H318G				
23							H318			H318G				
24							H304			H304G				
25							H340							
26							H316							
27							FA080/2							
28							FA174		FA174HH	MD1004	MD1004C			
29							FA174		FA174HH	MD1004	MD1004C			
30							FA436	FA436V	FA436HH	MD1156				
31							FA174		FA174HH	MD1156				
32							FA174		FA174HH	MD1004	MD1004C			
33							FA174		FA174HH	MD1156				
34							FA174		FA174HH	MD1156				
35							FA174		FA174HH	MD1156				
36							FA174		FA174HH	MD1156				
37							FA174		FA174HH	MD1156				
38							FA174		FA174HH	MD1156				
39							FA174		FA174HH	MD1156				
40							FA174		FA174HH	MD1156				
41							FA069/3		FA069/3HH	MD1002				
42							FA174		FA174HH	MD1004	MD1004C			
43														
44						BRK15S	FA174		FA174HH	MD1004	MD1004C			
45							FA174		FA174HH	MD1004	MD1004C	VR1004		
46							FA174		FA174HH	MD1004	MD1004C	VR1004		
47							FA174		FA174HH	MD1004	MD1004C	VR1004		
48							FA174		FA174HH	MD1004	MD1004C	VR1004		
49							FA436	FA436V	FA436HH	MD1156				
50							FA174		FA174HH	MD1156				
51							FA174		FA174HH	MD1004	MD1004C	VR1004		
52							FA174		FA174HH	MD1004	MD1004C	VR1004		
53														
54							FA436		FA436HH	MD1004	MD1004C	VR1004		
55							FA436		FA436HH	MD1004	MD1004C	VR1004		
56							FA436		FA436HH	MD1173	MD1173C	VR1173		
57							FA436		FA436HH	MD1004	MD1004C	VR1004		
58							FA436		FA436HH	MD1004	MD1004C	VR1004		
59														
60														

REAR / ARRIÈRE / HINTEN / POSTERIOR / POSTERIORE

*-2 Sets Required. † For Vee disc colours add RED, BLU, GRN, GLD, ORG suffix to part number. For Custom Finish Options for Vee-Rotors™ including Splatter discs add suffix CHR, CHGR, CHBL, CHBR - available in various colours see page iv. ☼ - Also available as a Vintage Motorcycle Disc.

Part numbers, prefixes, suffixes, photos and illustrations shown in this catalogue are trademarks and/or copyrights of EBC Brakes or the trademark owner A C Freeman Investments Ltd and use without express written permission of the owners is punishable by law.

R Suffix = High Durability Sintered Pad. **HH** Suffix = High Performance Sintered Pad. **TT** Suffix = Hard Wearing Off Road Pad. **V** Suffix = Semi Sintered Pad. **G** Suffix = Grooved Shoe.
D Suffix = Drilled Disc. **X** Suffix = Universal Left or Right Disc. **XC** Suffix = Contoured Disc. **LS** Suffix = Left/Steel Disc. **RS** = Right/Steel Disc.

BRAKE APPLICATIONS

JAPANESE Built Motorcycles



HONDA Contd.



DISC PAD CHOICES - FRONT

BRAKE DISC CHOICES - FRONT

R Suffix = High Durability Sintered Pad. **HH** Suffix = High Performance Sintered Pad. **TT** Suffix = Hard Wearing Off Road Pad. **V** Suffix = Semi Sintered Pad. **G** Suffix = Grooved Shoe.
D Suffix = Drilled Disc. **X** Suffix = Universal Left or Right Disc. **XC** Suffix = Contoured Disc. **LS** Suffix = Left/Steel Disc. **RS** = Right/Steel Disc.

FRONT / AVANT / VORN / FRENTE / ANTERIORE

	FA, SFA, TT Pad or Brake Shoe	SFAC Carbon Scooter Pads	Speciality Pads - SXR / Vee / MXS	Sintered/HH Pads/ Grooved Shoes	Left / Gauche / Links Standard Replacement Disc	Right / Droite / Rechts Standard Replacement Disc	Contour Disc Universal left and right fitment	Custom Disc Universal left and right fitment	Vee-Disks Black † See note below	CX Extreme MX Race Disc/ UTVX Disc
FJS 600 1/2/D3/D4/D5/D6 Silverwing (Non ABS 256mm front disc)	01-06	SFA281	SFAC281	SFA281HH	MD1006		MD1006C			
FJS 600 1/2/D3/D4/D5/D6 Silverwing (Non ABS 256mm front disc) - Parking Brake	01-06	SFA257/2	SFAC281							
FJS 600 A3-A7/D7 Silverwing (ABS Model 276mm front disc)	03-09	SFA281		SFA281HH	MD1172LS					
FJS 600 A3-A7/D7 Silverwing (ABS Model 276mm front disc) - Parking Brake	03-09	SFA257/2								
NTV 600 J/K/M Revere	88-92	FA142	FA142V	FA142HH	MD1021LS					
SW-T 600 Silverwing (FJS 600 AB)	11-16	SFA388	SFAC388	SFA388HH	MD1172LS					
SW-T 600 Silverwing (FJS 600 AB) - Parking Brake	11-16	SFA257/2								
VT 600 CN Shadow Custom	93	FA124/2	FA124/2V	FA124/2HH	MD1047LS					
VT 600 CR/CS/CT/CV/CW/CX Shadow Custom	94-00	FA142	FA142V	FA142HH	MD1047LS					
XL 600 RD/LD/RE/LE/RF/RG/RH	83-87	FA092TT		FA092R	MD6087D					
XL 600 LMF/RMG/LMH	85-87	FA069		FA069HH	MD6096D					
XL 600 VH/VJ/VK Trans Alp	87-90	FA069		FA069HH	MD6044D					
XL 600 VM/VN/VP Trans Alp	91-93	FA124/2		FA124/2HH	MD6044D					
XL 600 VR/VT Trans Alp	94-96	FA196		FA196HH	MD6044D					
XL 600 VW/VX Trans Alp	97-99	FA185TT*	MXS185*	FA185R*	MD6010D	MD6010D			MD6010CX*	
XR 600 RF/RG/RH	85-87	FA092TT		FA092R	MD6087D					
XR 600 RJ/RK/RL	88-90	FA125TT	MXS125	FA125R	MD6087D					
XR 600 RM/RN	91-92	FA125TT	MXS125	FA125R	MD6001D		MD6001C			MD6001CX
XR 600 RP/RR/RS/RT/RV/RW/RX/RZ	93-00	FA185TT	MXS185	FA185R	MD6001D		MD6001C			MD6001CX
CB 650 F	14-16	FA142*	FA142V*	FA142HH*			MD1200C			
CB 650 FA ABS	14-18	FA142*	FA142V*	FA142HH*			MD1200C			
CB 650 R (Non ABS)	19-20			FA679HH*	MD1194X	MD1194X	MD1194XC*			
CB 650 R AC/ RA AC	19-21			FA679HH*	MD1194X	MD1194X	MD1194XC*			
CB 650 Z/B	79-81	FA045*	FA045V*							
CB 650 SCC Nighthawk	82	FA090*	FA090V*		MD1036LS	MD1036RS				
CBR 650 F (Non ABS)	14-16	FA142*	FA142V*	FA142HH*			MD1201C*			
CBR 650 FA ABS	14-18	FA142*	FA142V*	FA142HH*			MD1201C*			
CBR 650 R (Non ABS)	19-20			FA679HH*	MD1194X	MD1194X	MD1194XC*			
CBR 650 R (ABS)	19-21			FA679HH*	MD1194X	MD1194X	MD1194XC*			
CX 650 ED	83	FA069/2*			MD1036LS	MD1036RS				
CX 650 TD Turbo	83	FA069/2*								
FMX 650 5/6	05-08	FA196		FA196HH	MD6300D					
FX 650 X/Y Vigor	99-03	FA209/2		FA209/2HH	MD6044D					
GL 650 D2-E	84	FA069/2			MD1040LS	MD1040RS				
NT 650 J/K/L (Bros)	88-92	FA187		FA187HH	MD1124LS					
NT 650 VW/VX/VY/V1 Deauville	98-01	FA209/2*		FA209/2HH*	MD1008	MD1008				
NT 650 V2/V3/V4/V5 Deauville (Note - linked brake system. Fit all three sets at pad change)	02-05			FA261HH*	MD1008	MD1008				
NTV 650 J/K/L/M/P/S/T/V	88-97	FA142	FA142V	FA142HH	MD1021LS					
NX 650 J/K/L/LI/II/M Dominator	88-91	FA124/2		FA124/2HH	MD6010D					MD6010CX
NX 650 N/P/R/S/T Dominator	92-96	FA124/2		FA124/2HH	MD6010D					MD6010CX
NX 650 V/W/X Dominator	97-02	FA209/2		FA209/2HH	MD6010D					MD6010CX
SLR 650 V/W	97-98	FA209/2		FA209/2HH	MD6044D					
TRX 650 FA3/FA4/FA5 Rincon	03-05	H347*		H347G*						
XL 650 VY/V1-V7 Transalp	00-07	FA185TT*	MXS185*	FA185R*	MD6346D	MD6346D				
XR 650 L	93-21	FA185TT	MXS185	FA185R	MD6010D					MD6010CX
XR 650 RY/R1-R7	00-07	FA185TT	MXS185	FA185R	MD6001D		MD6001C			MD6001CX
XRV 650 J/K Africa Twin	88-89	FA124/2		FA124/2HH	MD6168D					
DN-01 (680cc) (NSA 700 A8/A9)	08-11	FA388*		FA388HH*		MD1180X				
DN-01 (680cc) (NSA 700 A8/A9) - Parking Brake	08-11	SFA257/2								
TRX 680 FA6/FA7/FA8/FA9/FAA/FAB/FAC Rubicon 4 x 4 Auto	06-21	FA410TT*		FA410R*	MD6251D	MD6251D				
CTX 700 DE-DCT	14-21	FA196	FA196V	FA196HH			MD1187C			
CTX 700 DE-DCT - Parking Brake	14-21	SFA257/2								
CTX 700 N-DCT	14-21	FA196	FA196V	FA196HH			MD1186C			
CTX 700 N-DCT - Parking Brake	14-21	SFA257/2								

Line #
1
2
3
4
5
6
7
8
9
10
11
12
13
14
15
16
17
18
19
20
21
22
23
24
25
26
27
28
29
30
31
32
33
34
35
36
37
38
39
40
41
42
43
44
45
46
47
48
49
50
51
52
53
54
55
56
57
58
59
60

*-2 Sets Required. † For Vee disc colours add RED, BLU, GRN, GLD, ORG suffix to part number. For Custom Finish Options for Vee-Rotors™ including Splatter discs add suffix CHR, CHGR, CHBL, CHBR - available in various colours see page iv. ☉ - Also available as a Vintage Motorcycle Disc.

JAPANESE Built Motorcycles

Line #	BRAKE DISC CHOICES - FRONT						DISC PAD CHOICES - REAR				BRAKE DISC CHOICES - REAR			
	Oversize 250 /280mm Disc Kit	OSX Oversize 250/280mm Disc Kit	Relocating Bracket for 250/ 280mm Disc	Oversize 320mm Disc Kit	SMX Oversize 320mm Disc Kit	Relocating Bracket for 320mm Disc	FA, SFA, TT Pad or Brake Shoe	SFAC Carbon Scooter Pads	Speciality Pads - SXR / Vee / MXS	Sintered/ HH Pads/ Grooved Shoes	Standard Replacement Disc	Contour Disc Rear fitment	Vee Discs CONTOUR	CX Extreme MX Race Disc
1														
2							SFA196			FA196HH	MD1149	MD1149C		
3														
4														
5														
6							SFA196			FA196HH	MD1149			
7														
8														
9							FA140		FA140V	FA140HH	MD1025			
10							SFA196	SFAC196		SFA196HH	MD1149			
11														
12							H321							
13							H321							
14							H318			H318G				
15							H318			H318G				
16							H318			H318G				
17							FA140			FA140HH	MD6097D			
18							FA140			FA140HH	MD6097D			
19				SM6010C*	SMX6010*	BRK009*	FA140			FA140HH	MD6097D			
20							H304			H304G				
21							H304			H304G				
22	OSX6001	BRK004		SMX6001	BRK009		FA131TT	MXS131	FA131R	MD6013D	MD6013C		MD6013CX	
23	OSX6001	BRK008		SMX6001	BRK009		FA131TT	MXS131	FA131R	MD6013D	MD6013C		MD6013CX	
24							FA496	FA496V	FA496HH	TBA				
25							FA496	FA496V	FA496HH					
26							FA496	FA496V	FA496HH	MD1156				
27							FA496	FA496V	FA496HH	MD1156				
28							H320							
29							H320							
30							FA496	FA496V	FA496HH	MD1156				
31							FA496	FA496V	FA496HH					
32							FA496	FA496V	FA496HH	MD1156				
33							FA496	FA496V	FA496HH	MD1156				
34							FA069	FA069V						
35							FA069	FA069V						
36							FA140		FA140HH	MD6099D				
37							FA213		FA213HH	MD6099D				
38							H321							
39							FA140	FA140V	FA140HH	MD1022				
40							FA140		FA140HH	MD1016				
41														
42									FA261HH	MD1016				
43							FA140		FA140HH	MD1025				
44				SM6010C	SMX6010	BRK009	FA140		FA140HH	MD6013D	MD6013C		MD6013CX	
45				SM6010C	SMX6010	BRK009	FA140		FA140HH	MD6099D				
46				SM6010C	SMX6010	BRK009	FA213		FA213HH	MD6099D				
47							FA213		FA213HH	MD6099D				
48							FA373TT		FA373R	MD6217D				
49							FA140		FA140HH	MD6097D				
50				SM6010C	SMX6010	BRK009	FA131TT	MXS131	FA131R	MD6045D			MD6045CX	
51	OS6001C	OSX6001	BRK008		SMX6001	BRK009	FA131TT	MXS131	FA131R	MD6181D	MD6181C		MD6181CX	
52							FA140		FA140HH	MD6097D				
53							FA196	FA196V	FA196HH					
54														
55														
56							FA373TT		FA373R	MD6217D				
57							FA140	FA140V	FA140HH		MD1185C			
58														
59							FA140	FA140V	FA140HH		MD1185C			
60														

REAR / ARRIÈRE / HINTEN / POSTERIORE

*-2 Sets Required. † For Vee disc colours add RED, BLU, GRN, GLD, ORG suffix to part number. For Custom Finish Options for Vee-Rotors™ including Splatter discs add suffix CHR, CHGR, CHBL, CHBR - available in various colours see page iv. ☉ - Also available as a Vintage Motorcycle Disc.

Part numbers, prefixes, suffixes, photos and illustrations shown in this catalogue are trademarks and/or copyrights of EBC Brakes or the trademark owner A C Freeman Investments Ltd and use without express written permission of the owners is punishable by law.

R Suffix = High Durability Sintered Pad. **HH** Suffix = High Performance Sintered Pad. **TT** Suffix = Hard Wearing Off Road Pad. **V** Suffix = Semi Sintered Pad. **G** Suffix = Grooved Shoe.
D Suffix = Drilled Disc. **X** Suffix = Universal Left or Right Disc. **XC** Suffix = Contoured Disc. **LS** Suffix = Left/Steel Disc. **RS** = Right/Steel Disc.

BRAKE APPLICATIONS

JAPANESE Built Motorcycles



HONDA Contd.



DISC PAD CHOICES - FRONT

BRAKE DISC CHOICES - FRONT

FA, SFA, TT Pad or Brake Shoe	SFAC Carbon Scooter Pads	Speciality Pads - SXR / Vee / MXS	Sintered/HH Pads/ Grooved Shoes	Left / Gauche / Links Standard Replacement Disc	Right / Droite / Rechts Standard Replacement Disc	Contour Disc Universal left and right fitment	Custom Disc Universal left and right fitment	Vee-Disks Black † See note below	CX Extreme MX Race Disc/ UTVX Disc
NC 700 DC-700 Integra Scooter	12-14	SFA388	SFAC388		SFA388HH		MD1187C		
NC 700 DC-700 Integra Scooter - Parking Brake	12-14	SFA257/2							
NC 700 SA (ABS)	12-13	FA388			FA388HH		MD1187C		
NC 700 SD (ABS/DCT)	12-14	FA388			FA388HH		MD1187C		
NC 700 SD (ABS/DCT) - Parking Brake	12-14	SFA257/2							
NC 700 S (Non ABS)	12-13	FA196	FA196V	FA196HH			MD1186C		
NC 700 XA (ABS)	12-13	FA388			FA388HH		MD1187C		
NC 700 XA (ABS) - Parking Brake	12-13	SFA257/2							
NC 700 XD (ABS/DCT)	12-14	FA388			FA388HH		MD1187C		
NC 700 XD (ABS/DCT) - Parking Brake	12-14	SFA257/2							
NC 700 X (Non ABS)	12-13	FA196	FA196V	FA196HH			MD1186C		
NT 700 V6/V7/V8/VAA Deauville	06-13			FA388HH*		MD1008	MD1008		
NT 700 VA6/VA7/VA8/VAA Deauville	07-13			FA388HH*		MD1008	MD1008		
MUV 700-9 Big Red Side x Side	Left 09	FA476TT				MDG6341D			
	Right	FA477TT					MDG6341D		
SXS 700 M2 Pioneer (2 Seat)	16-18	FA712TT*	MXS712*	FA712R*		MDG6341D	MDG6341D		
SXS 700 M4 Pioneer (4 Seat)	16-18	FA712TT*	MXS712*	FA712R*		MDG6341D	MDG6341D		
TRX 700 XX8/XX9/XXB	08-12	FA185TT*		FA185R*		MDG6006D	MDG6006D		
XL 700 V8/V9/VA (Transalp/2 Piston Front Caliper /ABS on Rear Disc)	08-11	FA185TT*	MXS185	FA185R*		MDG6346D	MDG6346D		
XL 700 VA8/VA9/VAA (Transalp/3 Piston Front Caliper /ABS Front & Rear wheels)	08-11	FA388*		FA388HH*		MDG6346D	MDG6346D		
ADV 750 H (X-ADV DCT)	17-21			FA679HH*					
ADV 750 H (X-ADV DCT) - Parking Brake	17-21	SFA257/2							
CB 750 F/F1	76-77	FA013	FA013V						
CB 750 F2	78	FA031*	FA031V*						
CB 750 FZ/FA/FB	78-82	FA031*	FA031V*			MD1036LS	MD1036RS	VMD1036	
CB 750 FC/F2C/FD/F2D	83-84	FA069/2*	FA069/2V*			MD1036LS	MD1036RS		
CB 750 F2N/F2R/F2S/F2T/F2V/F2W/F2X/F2Y/F21									
CB Seven Fifty	92-02	FA142*	FA142V*	FA142HH*		MD1008	MD1008		
CB 750 K0-K5	69-75	FA012	FA012V						
CB 750 K6	76	FA012	FA012V			MD1062LS			
CB 750 K7	78	FA013	FA013V			MD1062LS			
CB 750 KZ	80	FA045*	FA045V*			MD1036LS	MD1036RS		
CBR 750 FH Superaero (RC27)	87	FA124*		FA124HH*		MD1001	MD1001		
CBR 750 FJ Superaero (RC27)	88	FA142*	FA142V*	FA142HH*		MD1162LS	MD1162RS		
CBX 750 FE	84	FA069*		FA069HH*		MD1001	MD1001		
NM 4 Vultus (NC750J)	15-19	FA196	FA196V	FA196HH					
NM 4 Vultus (NC750J) - Parking Brake	15-19	FA196							
NC 750 S	14-15	FA196	FA196V	FA196HH			MD1186C		
NC 750 S - Parking brake	14-15	SFA257/2							
NC 750 S ABS	14-18	FA196	FA196V	FA196HH			MD1187C		
NC 750 S ABS DCT	14-18	FA196	FA196V	FA196HH			MD1187C		
NC 750 S ABS DCT - Parking Brake	14-18	SFA257/2							
NC 750 X	14-21	FA196	FA196V	FA196HH			MD1186C		
NC 750 X ABS	14-21	FA196	FA196V	FA196HH			MD1187C		
NC 750 X ABS DCT	14-21	FA196	FA196V	FA196HH			MD1187C		
NC 750 X ABS DCT - Parking Brake	14-21	SFA257/2							
NC 750 D Integra Scooter DCT	13-20	SFA196	SFAC196	SFA196HH			MD1187C		
NC 750 D Integra Scooter DCT - Parking Brake	13-21	SFA257/2							
NR 750 N	92	FA187*		FA187HH*					
RVF 750 RR/RS RC45	94-98	FA187*		FA187HH*		MD1012LS	MD1012RS		
VF 750 C Shadow	83	FA069	FA069V	FA069HH		MD1047LS			
VF 750 CH	87	FA069/3	FA069/3V	FA069/3HH		MD1059LS			
VF 750 CP/CR/CS/CT/CV/CW/CX	93-99	FA196	FA196V	FA196HH		MD1021LS			
VF 750 FD/FE	83-84	FA069*		FA069HH*		MD1083LS	MD1083RS		
VF 750 SC (V45 Sabre)	82	FA069*	FA069V*	FA069HH*		MD1001	MD1001		
VFR 750 FG/FH	86-87	FA124*		FA124HH*		MD1001	MD1001		
VFR 750 FJ/FK	88-89	FA142*	FA142V*	FA142HH*		MD1008	MD1008		
VFR 750 FL/FM/FN/FP	90-93	FA142*	FA142V*	FA142HH*		MD1008	MD1008		

FRONT / AVANT / VORN / FRENTE / ANTERIORE

Line #

R Suffix = High Durability Sintered Pad. HH Suffix = High Performance Sintered Pad. TT Suffix = Hard Wearing Off Road Pad. V Suffix = Semi Sintered Pad. G Suffix = Grooved Shoe. D Suffix = Drilled Disc. X Suffix = Universal Left or Right Disc. XC Suffix = Contoured Disc. LS Suffix = Left/Steel Disc. RS = Right/Steel Disc.

*-2 Sets Required. † For Vee disc colours add RED, BLU, GRN, GLD, ORG suffix to part number. For Custom Finish Options for Vee-Rotors™ including Splatter discs add suffix CHR, CHGR, CHBL, CHBR - available in various colours see page iv. ☉ - Also available as a Vintage Motorcycle Disc.

90 Part numbers, prefixes, suffixes, photos and illustrations shown in this catalogue are trademarks and/or copyrights of EBC Brakes or the trademark owner A C Freeman Investments Ltd and use without express written permission of the owners is punishable by law.

JAPANESE Built Motorcycles

Line #	BRAKE DISC CHOICES - FRONT						DISC PAD CHOICES - REAR				BRAKE DISC CHOICES - REAR			
	OverSize 250 /280mm Disc Kit	OSX OverSize 250/280mm Disc Kit	Relocating Bracket for 250/ 280mm Disc	OverSize 320mm Disc Kit	SMX OverSize 320mm Disc Kit	Relocating Bracket for 320mm Disc	FA, SFA, TT Pad or Brake Shoe	SFAC Carbon Scooter Pads	Speciality Pads - SXR / Vee / MXS	Sintered/ HH Pads/ Grooved Shoes	Standard Replacement Disc	Contour Disc Rear fitment	Vee Discs CONTOUR	CX Extreme MX Race Disc
1							FA174		FA174V	FA174HH		MD1185C		
2														
3							FA174		FA174V	FA174HH		MD1185C		
4							FA174		FA174V	FA174HH		MD1185C		
5														
6							FA140		FA140V	FA140HH		MD1185C		
7							FA174		FA174V	FA174HH		MD1185C		
8														
9							FA174		FA174V	FA174HH		MD1185C		
10														
11							FA140		FA140V	FA140HH		MD1185C		
12									FA261HH		MD1016			
13									FA261HH		MD1016			
14							FA478TT					MD6341D		
15							FA479TT					MD6341D		
16							FA714TT			FA714R		MD6217D		
17							FA714TT			FA714R		MD6217D		
18							FA410TT			FA410R		MD6331D		
19														
20							FA140			FA140HH		MD6345D		
21														
22							FA174			FA174HH		MD6345D		
23							FA496			FA496HH		MD1156		
24														
25							FA032		FA032V			MD1064		
26							FA030		FA030V			MD1064		
27							FA031		FA031V			MD1071		
28							FA069		FA069V			MD1082		
29														
30							FA174		FA174V	FA174HH		MD1020		
31							H320							
32							H320							
33							H320							
34							H320							
35							FA069/3		FA069/3V	FA069/3HH		MD1006		
36							FA196		FA196V	FA196HH		MD1006		
37							FA069/3		FA069/3V	FA069/3HH		MD1079		
38							FA140		FA140V	FA140HH				
39							FA496		FA496V	FA496HH				
40							FA496		FA496V	FA496HH		MD1185C		
41														
42							FA496		FA496V	FA496HH		MD1185C		
43							FA496		FA496V	FA496HH		MD1185C		
44														
45							FA496		FA496V	FA496HH		MD1185C		
46							FA496		FA496V	FA496HH		MD1185C		
47							FA496		FA496V	FA496HH		MD1185C		
48														
49							FA496		FA496V	FA496HH		MD1185C		
50														
51							FA143							
52							FA143					MD1013		
53							H343							
54							H343							
55							H343							
56							FA069/3		FA069/3V	FA069/3HH		MD1068		
57							H321							
58							FA069/3		FA069/3V	FA069/3HH		MD1006		
59							FA196		FA196V	FA196HH		MD1006		
60							FA196		FA196V	FA196HH		MD1007		

REAR / ARRIÈRE / HINTEN / POSTERIORE

R Suffix = High Durability Sintered Pad. **HH** Suffix = High Performance Sintered Pad. **TT** Suffix = Hard Wearing Off Road Pad. **V** Suffix = Semi Sintered Pad. **G** Suffix = Grooved Shoe.
D Suffix = Drilled Disc. **X** Suffix = Universal Left or Right Disc. **XC** Suffix = Contoured Disc. **LS** Suffix = Left/Steel Disc. **RS** = Right/Steel Disc.

*-2 Sets Required. † For Vee disc colours add RED, BLU, GRN, GLD, ORG suffix to part number. For Custom Finish Options for Vee-Rotors™ including Splatter discs add suffix CHR, CHGR, CHBL, CHBR - available in various colours see page iv. ☉ - Also available as a Vintage Motorcycle Disc.

Part numbers, prefixes, suffixes, photos and illustrations shown in this catalogue are trademarks and/or copyrights of EBC Brakes or the trademark owner A C Freeman Investments Ltd and use without express written permission of the owners is punishable by law.

JAPANESE Built Motorcycles



HONDA Contd.



DISC PAD CHOICES - FRONT

BRAKE DISC CHOICES - FRONT

FA, SFA, TT Pad or Brake Shoe	SFAC Carbon Scooter Pads	Speciality Pads - SXR / Vee / MXS	Sintered/HH Pads/ Grooved Shoes	Left / Gauche / Links Standard Replacement Disc	Right / Droite / Rechts Standard Replacement Disc	Contour Disc Universal left and right fitment	Custom Disc Universal left and right fitment	Vee-Disks Black † See note below	CX Extreme MX Race Disc/ UTVX Disc
VFR 750 FR/FS/FT/FV		FA142V*	FA142HH*	MD1003X	MD1003X	MD1003XC*	MD1003CC*	VR1003BLK*†	
VFR 750 RJ/RK/RL RC30		FA187*	FA187HH*	MD1010LS	MD1010RS				
VT 750 CV/C2V/CW/C2W/CX/C2X/CY/C2Y/C21/C1 /C31/C4/C5/C6/C7/C8 Shadow		FA196	FA196V	FA196HH	MD1159				
VT 750 C2BA/C2BB/C2BC/C2BE Shadow Black Spirit		FA196	FA196V	FA196HH		MD1159			
VT 750 C2SA/C2SB Shadow (3 Piston Caliper /17 Inch Front Wheel/ABS/Rear Disc)		FA388		FA388HH					
VT 750 DC1/DC2 Black Widow		FA196	FA196V	FA196HH	MD1159				
VT 750 DC7/DC8 Shadow Spirit		FA196	FA196V	FA196HH	MD1159				
VT 750 S (VT 750 SA/SB)		FA196	FA196V	FA196HH	MD1159				
VT 750 C Shadow Aero		FA388	FA388V	FA388HH					
VT 750 C Shadow Aero ABS		FA388	FA388V	FA388HH					
XLV 750 R (RD/RF)		FA069		FA069HH	MD6044D				
XRV 750 L/M/N Africa Twin		FA121*	FA121HH*	MD6102	MD6102				
XRV 750 P/R/S/T/N/W/X/Y Africa Twin		FA185TT*	MXS185*	FA185R*	MD6102	MD6102			
PC 800 Pacific Coast		FA142*	FA142V*	FA142HH*	MD1001	MD1001			
VFR 800 FIW/FIX				FA261HH*	MD1014X	MD1014X	MD1014XC*	MD1014CC*	VR1014BLK*†
VFR 800 FIY/F11/2/3/4/5				FA261HH*	MD1014X	MD1014X	MD1014XC*	MD1014CC*	VR1014BLK*†
VFR 800 6/8/9				FA388HH*	MD1157X	MD1157X	MD1157XC*		
VFR 800 A2/A3/A4/A5 (ABS Model)				FA261HH*	MD1157X	MD1157X	MD1157XC*		
VFR 800 A6/A8/A9 (ABS Model)				FA388HH*	MD1157X	MD1157X	MD1157XC*		
VFR 800 F (ABS Model)				FA390HH*	MD1188X	MD1188X			
VFR 800 XB/XC/XD (Crossrunner/ABS)				FA388HH*	MD1157X	MD1157X			
VFR 800 XF/XG (Crossrunner/ABS)				FA390HH*	MD1188X	MD1188X			
VFR 800 XH/XJ (Crossrunner/ABS)				FA700HH*	MD1188X	MD1188X			
CB 900 FZ/FA		FA031*		MD1036LS	MD1036RS	VMD1036			
CB 900 FB/F2B		FA069/2*		MD1036LS	MD1036RS				
CB 900 FC/F2C/FD/F2D		FA069*		FA069HH*	MD1036LS	MD1036RS			
CB 900 F2/F3/F4/F5/F6/F7 Hornet		FA187*		FA187HH*	MD1141X	MD1141X	MD1141XC*	MD1141CC*	VR1141BLK*†
CBR 900 RRN/RRP Fireblade (893cc)		FA187*		FA187HH*	MD1014X	MD1014X	MD1014XC*	MD1014CC*	VR1014BLK*†
CBR 900 RRR/RRS Fireblade (893cc)		FA187*		FA187HH*	MD1003X	MD1003X	MD1003XC*	MD1003CC*	VR1003BLK*†
CBR 900 RRT/RRV Fireblade (918cc)		FA187*		FA187HH*	MD1003X	MD1003X	MD1003XC*	MD1003CC*	VR1003BLK*†
CBR 900 RRW/RRX Fireblade (918cc)				FA265HH*	MD1134X	MD1134X	MD1134XC*	MD1134CC*	VR1134BLK*†
CBR 900 Evolution Blade		FA095*		FA095HH*					
CBR 900 RRY/RR1 (929cc) Fireblade				FA265HH*	MD1137X	MD1137X	MD1137XC*	MD1137CC*	VR1137BLK*†
CBR 900 RR2/RR3 (954cc) Fireblade				FA265HH*	MD1137X	MD1137X	MD1137XC*	MD1137CC*	VR1137BLK*†
CB 1000 FP/FR/FS/FT/FV		FA187*		FA187HH*	MD1056	MD1056			
CB 1000 R (Non ABS Model)				FA390HH*	MD1152X	MD1152X	MD1152XC*	MD1152CC*	VR1152BLK*†
CB 1000 R (ABS Model)				FA388HH*	MD1152X	MD1152X	MD1152XC*	MD1152CC*	VR1152BLK*†
CB 1000 R (ABS Model)				FA296HH*	MD1193X	MD1193X			
CBF 1000 6/7/8/9/A (2 Piston Front Calipers /Non ABS Model)		FA226*		FA226HH*	MD1160	MD1160			
CBF 1000 A A6/A7/A8/A9/AA (3 Piston Front Caliper /ABS Model)				FA388HH*	MD1160	MD1160			
CBF 1000 S S7/S8/S9/SA (3 Piston Front Caliper /ABS Model)				FA388HH*	MD1160	MD1160			
CBF 1000 T T7/T8/T9/TA - GT (3 Piston Front Caliper /ABS Model)				FA388HH*	MD1160	MD1160			
CBF 1000 F FA (2 Piston Front Caliper/Non ABS)		FA226*		FA226HH*	MD1160	MD1160			
CBF 1000 FA FAA (3 Piston Front Caliper/ABS Model)				FA388HH*	MD1160	MD1160			
CBF 1000 FS FSA (3 Piston Front Caliper/ABS Model)				FA388HH*	MD1160	MD1160			
CBF 1000 FT FTA (3 Piston Front Caliper/ABS Model)				FA388HH*	MD1160	MD1160			
CBR 1000 FH/FJ		FA124*		FA124HH*	MD1008	MD1008			
CBR 1000 FK/FL/FM/FN		FA142*	FA142V*	FA142HH*	MD1008	MD1008			
CBR 1000 FP/FR/FS/FT/FV/FW/FX (Note - linked brake system. Fit all three sets at pad change)		FA189*		FA189HH*	MD1008	MD1008			
CBR 1000 RR4/RR5 Fireblade				FA390HH*	MD1153X	MD1153X	MD1153XC*	MD1153CC*	VR1153BLK*†
CBR 1000 RR6/RR7				FA390HH*	MD1161X	MD1161X	MD1161XC*	MD1161CC*	VR1161BLK*†
CBR 1000 RR8/RR9/RRR/RRB/RRC/RRD/RRE/RRF /RRG Fireblade Non ABS				FA390HH*	MD1171X	MD1171X	MD1171XC*		VR1171BLK*†

FRONT / AVANT / VORN / FRENTE / ANTERIORE

Line #

R Suffix = High Durability Sintered Pad. HH Suffix = High Performance Sintered Pad. TT Suffix = Hard Wearing Off Road Pad. V Suffix = Semi Sintered Pad. G Suffix = Grooved Shoe. D Suffix = Drilled Disc. X Suffix = Universal Left or Right Disc. XC Suffix = Contoured Disc. LS Suffix = Left/Steel Disc. RS = Right/Steel Disc.

*-2 Sets Required. † For Vee disc colours add RED, BLU, GRN, GLD, ORG suffix to part number. For Custom Finish Options for Vee-Rotors™ including Splatter discs add suffix CHR, CHGR, CHBL, CHBR - available in various colours see page iv. ☉ - Also available as a Vintage Motorcycle Disc.

92 Part numbers, prefixes, suffixes, photos and illustrations shown in this catalogue are trademarks and/or copyrights of EBC Brakes or the trademark owner A C Freeman Investments Ltd and use without express written permission of the owners is punishable by law.

JAPANESE Built Motorcycles

Line #	BRAKE DISC CHOICES - FRONT						DISC PAD CHOICES - REAR				BRAKE DISC CHOICES - REAR			
	Oversize 250 /280mm Disc Kit	OSX Oversize 250/280mm Disc Kit	Relocating Bracket for 250/ 280mm Disc	Oversize 320mm Disc Kit	SMX Oversize 320mm Disc Kit	Relocating Bracket for 320mm Disc	FA, SFA, TT Pad or Brake Shoe	SFAC Carbon Scooter Pads	Speciality Pads - SXR / Vee / MXS	Sintered/ HH Pads/ Grooved Shoes	Standard Replacement Disc	Contour Disc Rear fitment	Vee Discs CONTOUR	CX Extreme MX Race Disc
1							FA196		FA196V	FA196HH	MD1007	MD1007C		
2							FA143				MD1011			
3														
4							H343							
5							H343							
6														
7							FA254		FA254V	FA254HH				
8							H343							
9							H343							
10							H343							
11							TBA							
12							FA254		FA254V	FA254HH				
13							H340			H340G				
14							FA140			FA140HH	MD6103D			
15							FA140				MD6103D			
16							H343							
17										FA261HH	MD1165	MD1165C		
18										FA261HH	MD1165	MD1165C		
19										FA261HH	MD1165	MD1165C		
20										FA261HH	MD1164	MD1164C		
21										FA261HH	MD1164	MD1164C		
22										FA488HH	MD1190			
23										FA488HH	MD1189			
24										FA488HH	MD1190			
25										FA488HH	MD1190			
26							FA031		FA031V		MD1071			
27							FA069		FA069V		MD1082			
28							FA069		FA069V	FA069HH	MD1082			
29							FA174		FA174V	FA174HH	MD1020	MD1020C	VR1020	
30							FA174		FA174V	FA174HH	MD1004	MD1004C	VR1004	
31							FA174		FA174V	FA174HH	MD1004	MD1004C	VR1004	
32							FA174		FA174V	FA174HH	MD1004	MD1004C	VR1004	
33							FA174		FA174V	FA174HH	MD1004	MD1004C	VR1004	
34							FA047			FA047HH				
35							FA174		FA174V	FA174HH	MD1004	MD1004C	VR1004	
36							FA174		FA174V	FA174HH	MD1004	MD1004C	VR1004	
37							FA174		FA174V	FA174HH	MD1016			
38										FA488HH	MD1177	MD1177C		
39										FA488HH	MD1177	MD1177C		
40							FA196		FA196V	FA488HH				
41														
42							FA174		FA174V	FA174HH	MD1156			
43														
44										FA388HH	MD1178			
45														
46										FA388HH	MD1178			
47														
48										FA388HH	MD1178			
49							FA174		FA174V	FA174HH	MD1156			
50							FA174		FA174V	FA174HH	MD1178			
51							FA174		FA174V	FA174HH	MD1178			
52							FA174		FA174V	FA174HH	MD1178			
53							FA069/3		FA069/3V	FA069/3HH	MD1001			
54							FA196		FA196V	FA196HH	MD1016			
55														
56							FA189			FA189HH	MD1006			
57							FA174		FA174V	FA174HH	MD1004	MD1004C	VR1004	
58							FA436		FA436V	FA436HH	MD1004	MD1004C	VR1004	
59														
60							FA436		FA436V	FA436HH	MD1173	MD1173C	VR1173	

REAR / ARRIÈRE / HINTEN / POSTERIOR / POSTERIORE

R Suffix = High Durability Sintered Pad. **HH** Suffix = High Performance Sintered Pad. **TT** Suffix = Hard Wearing Off Road Pad. **V** Suffix = Semi Sintered Pad. **G** Suffix = Grooved Shoe.
D Suffix = Drilled Disc. **X** Suffix = Universal Left or Right Disc. **XC** Suffix = Contoured Disc. **LS** Suffix = Left/Steel Disc. **RS** = Right/Steel Disc.

*-2 Sets Required. † For Vee disc colours add RED, BLU, GRN, GLD, ORG suffix to part number. For Custom Finish Options for Vee-Rotors™ including Splatter discs add suffix CHR, CHGR, CHBL, CHBR - available in various colours see page iv. ⚙ - Also available as a Vintage Motorcycle Disc.

Part numbers, prefixes, suffixes, photos and illustrations shown in this catalogue are trademarks and/or copyrights of EBC Brakes or the trademark owner A C Freeman Investments Ltd and use without express written permission of the owners is punishable by law.

JAPANESE Built Motorcycles



HONDA Contd.



DISC PAD CHOICES - FRONT

BRAKE DISC CHOICES - FRONT

R Suffix = High Durability Sintered Pad. **HH** Suffix = High Performance Sintered Pad. **TT** Suffix = Hard Wearing Off Road Pad. **V** Suffix = Semi Sintered Pad. **G** Suffix = Grooved Shoe. **D** Suffix = Drilled Disc. **X** Suffix = Universal Left or Right Disc. **XS** Suffix = Contoured Disc. **LS** Suffix = Left/Steel Disc. **RS** = Right/Steel Disc.

FA, SFA, TT Pad or Brake Shoe

Model	Year
CBR 1000 RA9/RAA/RAB/RAC/RAD/RAE/RAF/RAG	
Fireblade (C-ABS)	09-16
CBR 1000 RAH/RAJ Fireblade	
(C-ABS/Nissin F/Caliper 5 bolt hole mounting)	17-20
CBR 1000 RR Fireblade (RA-AC/2AC, RR-AC/2AC models	
C-ABS/TOKIKO Front Caliper)	17-20
RR-SP1 (S1 S2) RR-SP1 models ABS -	
Brembo F/Caliper	17-20
RR-SP-AC/2AC models ABS - Brembo F/Caliper	20-21
RR-R SP models ABS - Nissin F/Caliper	20-21
CBR 1000 RR-SP Non ABS Fireblade	
(CBR 1000 SE/SF/SG)	14-16
CBR 1000 Fireblade 8 Ball ABS	20
CBR 1000 RR-SP ABS-TT Edition	16
CBX 1000 Z	79-80
CBX 1000 B/C	81-82
CRF 1000 Africa Twin ABS	16-17
CRF 1000 Africa Twin ABS DCT	16-17
CRF 1000 Africa Twin ABS DCT	18-20
CRF 1000 Africa Twin ABS DCT Parking Brake	16-20
GL 1000 K/K1/K2 Goldwing (6 Bolt disc fixing)	75-77
GL 1000 K3 Goldwing	78
GL 1000 Z Goldwing (5 Bolt disc fixing)	79
RC 213 V-S	15-17
PVT 1000 RS Pursuer	17-18
SXS 1000 M3 Pioneer (3 Seater)	Left 16-20
	Right
SXS 1000 M3P Pioneer (3 Seater)	Left 16-20
	Right
SXS 1000 M5D Pioneer (5 Seater)	Left 16-20
	Right
SXS 1000 M5L Pioneer (5 Seater)	Left 17-20
	Right
SXS 1000 M5P Pioneer (5 Seater)	Left 16-20
	Right
SXS 1000 S2R Talon (2 Seater)	Left 19-21
	Right
VF 1000 FE/FF/FG/F2F/F2G	84-86
VF 1000 RE/RF/RG	84-86
VTR 1000 FV/FW/FX/FY/F1-F6 Firestorm	97-06
VTR 1000 SP-Y/SP-1 (SC45) (SP1)	00-01
VTR 1000 SP-2/SP-3/SP-4/SP-5/SP-6 (SP2)	02-07
XL 1000 VX/XY/V1/V2 Varadero - Non ABS Model	
(Note - linked brake system.	
Fit all three sets at pad change)	99-02
XL 1000 V3/V4/V5/V6 Varadero - Non ABS Model	
(Note - linked brake system.	
Fit all three sets at pad change)	03-06
XL 1000 V7/V8/V9/VA/VB Varadero - Non ABS Model	
(Note - linked brake system.	
Fit all three sets at pad change)	07-11
XL 1000 VA4/VA5/VA6/VA7/VA8/VA9/VA/VA/VB Varadero -	
ABS Model (Note - linked brake system.	
Fit all three sets at pad change)	04-11
CB 1100 RB2/RC2/RD2	80-83
CB 1100 SFY/SF1 X11	00-03
CB 1100 AD (Cast Wheels/3 Piston Caliper)	13
CB 1100 AE (Cast Wheels/4 Piston Calipers)	14
CB 1100 EX (SAE)	14-21
CB 1100 RS	17

FRONT / AVANT / VORN / FRENTE / ANTERIORE

FA, SFA, TT Pad or Brake Shoe	SFAC Carbon Scooter Pads	Speciality Pads - SXR / Vee / MXS	Sintered/HH Pads/ Grooved Shoes	Left / Gauche / Links Standard Replacement Disc	Right / Droite / Rechts Standard Replacement Disc	Contour Disc Universal left and right fitment	Custom Disc Universal left and right fitment	Vee-Disks Black † See note below	CX Extreme MX Race Disc/ UTVX Disc
			FA390HH*	MD1171X	MD1171X	MD1171XC*		VR1171BLK*†	
			FA700HH*	MD1199X	MD1199X				
			FA700HH*	MD1176X	MD1176X	MD1171XC*		VR1171BLK*†	
			FA447HH*	MD1202X	MD1202X				
			FA447HH*	MD1202X	MD1202X				
			FA757HH*	TBC	TBC				
			FA447HH*	MD1171X	MD1171X	MD1171XC*		VR1171BLK*†	
			FA447HH*	MD1202X	MD1202X				
			FA447HH*						
FA031*				MD1036LS	MD1036RS	VMD1036			
FA069/2*									
			FA679HH*	MD1198X	MD1198X				
			FA679HH*	MD1198X	MD1198X				
			FA679HH*	MD1198X	MD1198X				
SFA257/2									
FA030*		FA030V*		MD1074LS	MD1074RS				
FA029*		FA029V*							
FA029*		FA029V*		MD1036LS	MD1036RS				
			FA447HH*						
FA700*			FA700HH*	MD1186X	MD1186X	MD1186XC*			
FA701TT		SXR701HH	FA701R	MD6410D					UTVX6410
FA702TT		SXR702HH	FA702R		MD6410D				UTVX6410
FA701TT		SXR701HH	FA701R	MD6410D					UTVX6410
FA702TT		SXR702HH	FA702R		MD6410D				UTVX6410
FA701TT		SXR701HH	FA701R	MD6410D					UTVX6410
FA702TT		SXR702HH	FA702R		MD6410D				UTVX6410
FA701TT		SXR701HH	FA701R	MD6410D					UTVX6410
FA702TT		SXR702HH	FA702R		MD6410D				UTVX6410
FA701TT		SXR701HH	FA701R	MD6410D					UTVX6410
FA702TT		SXR702HH	FA702R		MD6410D				UTVX6410
FA701TT		SXR701HH	FA701R	MD6425					TBA
FA701TT		SXR702HH	FA702R		MD6425				TBA
FA069*			FA069HH*	MD1001	MD1001				
FA069*			FA069HH*	MD1146	MD1146				
FA187*			FA187HH*	MD1003X	MD1003X	MD1003XC*	MD1003CC*	VR1003BLK*†	
			FA265HH*	MD1161X	MD1161X	MD1161XC*	MD1161CC*	VR1161BLK*†	
			FA265HH*	MD1161X	MD1161X	MD1161XC*	MD1161CC*	VR1161BLK*†	
			FA261HH*	MD1014X	MD1014X	MD1014XC*	MD1014CC*	VR1014BLK*†	
			FA261HH*	MD1014X	MD1014X	MD1014XC*	MD1014CC*	VR1014BLK*†	
			FA388HH*	MD1014X	MD1014X	MD1014XC*	MD1014CC*	VR1014BLK*†	
			FA388HH*	MD1157X	MD1157X	MD1157XC*			
FA069*			FA069HH*						
			FA261HH*	MD1136X	MD1136X	MD1136XC*		VR1136BLK*†	
			FA388HH*						
			FA296HH*						
			FA296HH*						
			FA390HH*						

Line #

*-2 Sets Required. † For Vee disc colours add RED, BLU, GRN, GLD, ORG suffix to part number. For Custom Finish Options for Vee-Rotors™ including Splatter discs add suffix CHR, CHGR, CHBL, CHBR - available in various colours see page iv. Ⓢ - Also available as a Vintage Motorcycle Disc.

JAPANESE Built Motorcycles

Line #	BRAKE DISC CHOICES - FRONT						DISC PAD CHOICES - REAR				BRAKE DISC CHOICES - REAR			
	Oversize 250 /280mm Disc Kit	OSX Oversize 250/280mm Disc Kit	Relocating Bracket for 250/ 280mm Disc	Oversize 320mm Disc Kit	SMX Oversize 320mm Disc Kit	Relocating Bracket for 320mm Disc	FA, SFA, TT Pad or Brake Shoe	SFAC Carbon Scooter Pads	Speciality Pads - SXR / Vee / MXS	Sintered/ HH Pads/ Grooved Shoes	Standard Replacement Disc	Contour Disc Rear fitment	Vee Discs CONTOUR	CX Extreme MX Race Disc
1														
2							FA436		FA436V	FA436HH	MD1173	MD1173C	VR1173	
3														
4							FA436			FA436HH	MD1173	MD1173C	VR1173	
5														
6							FA436		FA436V	FA436HH	MD1173	MD1173C	VR1173	
7														
8									FA266HH	MD1173	MD1173C	VR1173		
9									FA266HH	MD1173	MD1173C			
10									FA266HH	MD1173	MD1173C			
11														
12							FA436		FA436V	FA436HH	MD1173	MD1173C		
13							FA436		FA436V	FA436HH		MD1173C		
14							FA436		FA436V	FA436HH		MD1173C		
15							FA031		FA031V		MD1071			
16							FA069		FA069V		MD1071			
17							FA174		FA174V	FA174HH	MD1196			
18							FA174		FA174V	FA174HH	MD1196			
19							FA174		FA174V	FA174HH	MD1196			
20														
21							FA032		FA032V		MD1064			
22							FA032		FA032V		MD1064			
23							FA032		FA032V		MD1064			
24							FA266		FA266V	FA266HH				
25							FA109				MD1079			
26							FA703TT			FA703R	MD6410D		UTVX6410	
27							FA704TT			FA704R	MD6410D		UTVX6410	
28							FA703TT			FA703R	MD6410D		UTVX6410	
29							FA704TT			FA704R	MD6410D		UTVX6410	
30							FA703TT			FA703R	MD6410D		UTVX6410	
31							FA704TT			FA704R	MD6410D		UTVX6410	
32							FA703TT			FA703R	MD6410D		UTVX6410	
33							FA704TT			FA704R	MD6410D		UTVX6410	
34							FA703TT			FA703R	MD6410D		UTVX6410	
35							FA704TT			FA704R	MD6410D		UTVX6410	
36							FA703TT			FA703R	MD6425			
37							FA704TT			FA704R	MD6425			
38							FA069/3		FA069/3V	FA069/3HH	MD1079			
39							FA109							
40							FA174		FA174V	FA174HH	MD1004	MD1004C	VR1004	
41							FA174		FA174V	FA174HH	MD1004	MD1004C	VR1004	
42							FA174		FA174V	FA174HH	MD1004	MD1004C	VR1004	
43														
44														
45									FA261HH	MD6103D				
46														
47														
48									FA261HH	MD1006	MD1006C	VR1006		
49														
50														
51									FA261HH	MD1006	MD1006C	VR1006		
52														
53														
54									FA261HH	MD1006	MD1006C			
55							FA069/3		FA069/3V	FA069/3HH	MD1116			
56									FA261HH	MD1006	MD1006C	VR1006		
57							FA174		FA174V	FA174HH	MD1203			
58							FA174		FA174V	FA174HH	MD1203			
59							FA174		FA174V	FA174HH	MD1203			
60							FA174		FA174V	FA174HH	MD1174			

REAR / ARRIÈRE / HINTEN / POSTERIOR / POSTERIORE

R Suffix = High Durability Sintered Pad. **HH** Suffix = High Performance Sintered Pad. **TT** Suffix = Hard Wearing Off Road Pad. **V** Suffix = Semi Sintered Pad. **G** Suffix = Grooved Shoe.
D Suffix = Drilled Disc. **X** Suffix = Universal Left or Right Disc. **XC** Suffix = Contoured Disc. **LS** Suffix = Left/Steel Disc. **RS** = Right/Steel Disc.

*-2 Sets Required. † For Vee disc colours add RED, BLU, GRN, GLD, ORG suffix to part number. For Custom Finish Options for Vee-Rotors™ including Splatter discs add suffix CHR, CHGR, CHBL, CHBR - available in various colours see page iv. Ⓢ - Also available as a Vintage Motorcycle Disc.

Part numbers, prefixes, suffixes, photos and illustrations shown in this catalogue are trademarks and/or copyrights of EBC Brakes or the trademark owner A C Freeman Investments Ltd and use without express written permission of the owners is punishable by law.

JAPANESE Built Motorcycles



HONDA Contd.



DISC PAD CHOICES - FRONT

BRAKE DISC CHOICES - FRONT

FA, SFA, TT Pad or Brake Shoe	SFAC Carbon Scooter Pads	Speciality Pads - SXR / Vee / MXS	Sintered/HH Pads/ Grooved Shoes	Left / Gauche / Links Standard Replacement Disc	Right / Droite / Rechts Standard Replacement Disc	Contour Disc Universal left and right fitment	Custom Disc Universal left and right fitment	Vee-Disks Black † See note below	CX Extreme MX Race Disc/ UTVX Disc
CB 1100 RS			FA700HH*						
CBR 1100 XXV/XXW Blackbird (Note - linked brake system.)									
Fit all three sets at pad change)			FA261HH*	MD1120X	MD1120X	MD1120XC*		VR1120BLK*†	
CBR 1100 XXX/XXY/XX1-XX6 Blackbird									
(Note - linked brake system.)									
Fit all three sets at pad change)			FA261HH*	MD1136X	MD1136X	MD1136XC*		VR1136BLK*†	
CRF 1100 Africa Twin Adventure Sport ES ABS (Manual)			FA679HH*	MD1198X	MD1198X				
CRF 1100 Africa Twin Adventure Sport ES ABS (DCT)			FA679HH*	MD1198X	MD1198X				
CMX 1100 Rebel (ABS)			FA700HH						
GL 1100 AD Goldwing Aspencade	FA069/2*	FA069/2V*		MD1133	MD1133				
GL 1100 A/DA/B/DB (SC02)	FA030*	FA030V*		MD1036LS*	MD1036RS*				
GL 1100 C/DC Goldwing	FA069/2*	FA069/2V*		MD1036LS*	MD1036RS*				
ST 1100 L/M/N/P/R/S/T/V/W/X/Y/1/2 Pan European									
- Non ABS Model	FA142*	FA142V*	FA142HH*	MD1101	MD1101				
ST 1100 AN/AP/AR/AS (Pan European - ABS Model)									
(Note - linked brake system.)									
Fit all three sets at pad change)	FA142*	FA142V*	FA142HH*	MD1101	MD1101				
ST 1100 AT/AV/AW/AX/AY/A1/A2 (Pan European									
- ABS Model) (Note - linked brake system.)									
Fit all three sets at pad change)			FA261HH*	MD1008	MD1008				
VT 1100 CH/CJ/CN/CP Shadow	FA069/3	FA069/3V	FA069/3HH		MD1080RS				
VT 1100 CR/CS/CT/CV/CW Shadow	FA196	FA196V	FA196HH		MD1167RS				
VT 1100 C2 (S/T/M)	FA196	FA196V	FA196HH	MD1021RS					
VT 1100 C2 (W/X/Y/1/2/3/4/5)	FA196	FA196V	FA196HH	MD1179					
VT 1100 C3 (W/X/Y)	FA196	FA196V	FA196HH	MD1179					
GL 1200 DE/DF/DG Goldwing (4.7mm front disc)	FA069/3*	FA069/3V*	FA069/3HH*	MD1083LS	MD1083RS				
GL 1200 AE/AF/AG Goldwing (10mm vented front disc)	FA069/3*	FA069/3V*	FA069/3HH*	MD1125	MD1125				
VFR 1200 FA			FA499/4HH*	MD1176X	MD1176X				
VFR 1200 FAD DCT			FA499/4HH*	MD1176X	MD1176X				
VFR 1200 FAD DCT - Parking Brake	SFA257/2								
VFR 1200 FA GT			FA499/4HH*	MD1176X	MD1176X				
VFR 1200 FAD GT/DCT			FA499/4HH*	MD1176X	MD1176X				
VFR 1200 FAD GT/DCT - Parking Brake	SFA257/2								
VFR 1200 XAC/XAD/XAE/XAF/XAH/XAJ Crosstourer									
(Manual G/Box)			FA388HH*	MD1197	MD1197				
VFR 1200 XDC/XDCD/XDE/XDF/XDG/XDH/XDJ			FA388HH*	MD1197	MD1197				
DCT Crosstourer			FA388HH*	MD1197	MD1197				
VFR 1200 XDC/XDCD/XDE/XDF/XDG/XDH/XDJ									
DCT Crosstourer - Parking Brake	SFA257/2								
VFR 1200 Crosstourer Highlander T/DCT			FA388HH*	MD1197	MD1197				
X4 CB 1300 DCV/DCW/DCX/DCY (SC38)	FA187*		FA187HH*						
CB 1300 FW/FX/FY (SC40)	FA424*		FA424HH*	MD1136X	MD1136X	MD1136XC*		VR1136BLK*†	
CB 1300 F1 (SC40)			FA265HH*						
CB 1300 F3/F13 Superfour			FA296HH*						
CB 1300 5/6/7/8/9 (Superfour)			FA296HH*	MD1152X	MD1152X	MD1152XC*	MD1152CC*	VR1152BLK*†	
CB 1300 A5/A6/A7/A8/A9 (Superfour ABS)			FA296HH*	MD1152X	MD1152X	MD1152XC*	MD1152CC*	VR1152BLK*†	
CB 1300 S5/S6/S7/S8/S9			FA296HH*	MD1152X	MD1152X	MD1152XC*	MD1152CC*	VR1152BLK*†	
CB 1300 SA5-SAA			FA388HH*	MD1152X	MD1152X	MD1152XC*	MD1152CC*	VR1152BLK*†	
CTX 1300 AE			FA388HH*	MD1188X	MD1188X				
ST 1300 2/3/4/6 Pan European - Non ABS Model									
(Note - linked brake system.)									
Fit all three sets at pad change)			FA261HH*	MD1154X	MD1154X	MD1154XC*			
ST 1300 8/9 Pan European - Non ABS Model									
(Note - linked brake system.)									
Fit all three sets at pad change)			FA388HH*	MD1154X	MD1154X	MD1154XC*			
ST 1300 A2/A3/A4/A6 Pan European - ABS Model									
(Note - linked brake system.)									
Fit all three sets at pad change)			FA261HH*	MD1154X	MD1154X	MD1154XC*			
ST 1300 A8/A9/AA-AE Pan European - ABS Model									
(Note - linked brake system.)									

FRONT / AVANT / VORN / FRENTE / ANTERIORE

Line #

R Suffix = High Durability Sintered Pad. HH Suffix = High Performance Sintered Pad. TT Suffix = Hard Wearing Off Road Pad. V Suffix = Semi Sintered Pad. G Suffix = Grooved Shoe.
D Suffix = Drilled Disc. X Suffix = Universal Left or Right Disc. XC Suffix = Contoured Disc. LS Suffix = Left/Steel Disc. RS = Right/Steel Disc.

*-2 Sets Required. † For Vee disc colours add RED, BLU, GRN, GLD, ORG suffix to part number. For Custom Finish Options for Vee-Rotors™ including Splatter discs add suffix CHR, CHGR, CHBL, CHBR - available in various colours see page iv. * - Also available as a Vintage Motorcycle Disc.

JAPANESE Built Motorcycles

Line #	BRAKE DISC CHOICES - FRONT						DISC PAD CHOICES - REAR				BRAKE DISC CHOICES - REAR			
	OverSize 250 /280mm Disc Kit	OSX OverSize 250/280mm Disc Kit	Relocating Bracket for 250/ 280mm Disc	OverSize 320mm Disc Kit	SMX OverSize 320mm Disc Kit	Relocating Bracket for 320mm Disc	FA, SFA, TT Pad or Brake Shoe	SFAC Carbon Scooter Pads	Speciality Pads - SXR / Vee / MXS	Sintered/ HH Pads/ Grooved Shoes	Standard Replacement Disc	Contour Disc Rear fitment	Vee Discs CONTOUR	CX Extreme MX Race Disc
1							FA174		FA174V	FA174HH	MD1174			
2														
3									FA261HH		MD1006	MD1006C	VR1006	
4														
5														
6									FA261HH		MD1006	MD1006C	VR1006	
7							FA174		FA174V	FA174HH	MD1196			
8							FA174		FA174V	FA174HH	MD1196			
9							FA496		FA496V	FA496HH				
10							FA069		FA069V		MD1082			
11							FA030		FA030V		MD1071			
12							FA069		FA069V		MD1071			
13														
14							FA196		FA196V	FA196HH	MD1077			
15														
16														
17							FA196		FA196V	FA196HH	MD1077			
18														
19														
20														
21									FA261HH		MD1135			
22							H343							
23							H343							
24							FA174		FA174V	FA174HH	MD1016			
25							FA174		FA174V	FA174HH	MD1016			
26							FA069/3		FA069/3V	FA069/3HH	MD1082			
27							FA069/3		FA069/3V	FA069/3HH	MD1082			
28									FA488HH		MD1175			
29								FA636V	FA636HH		MD1175			
30														
31									FA488HH		MD1175			
32								FA636V	FA636HH		MD1175			
33														
34														
35									FA636HH		MD1175			
36														
37									FA636HH		MD1175			
38														
39														
40									FA636HH					
41							FA254		FA254V	FA254HH	MD1001			
42							FA254		FA254V	FA254HH	MD1016			
43							FA254		FA254V	FA254HH	MD1016			
44							FA174		FA174V	FA174HH	MD1006			
45							FA174		FA174V	FA174HH	MD1174	MD1174C		
46							FA174		FA174V	FA174HH	MD1174	MD1174C		
47							FA174		FA174V	FA174HH	MD1174	MD1174C		
48							FA174		FA174V	FA174HH	MD1174	MD1174C		
49									FA261V	FA261HH	MD1163			
50														
51														
52									FA261V		MD1163			
53														
54														
55									FA261V		MD1163			
56														
57														
58									FA261V		MD1163			
59														
60														

REAR / ARRIÈRE / HINTEN / POSTERIOR / POSTERIORE

R Suffix = High Durability Sintered Pad. **HH** Suffix = High Performance Sintered Pad. **TT** Suffix = Hard Wearing Off Road Pad. **V** Suffix = Semi Sintered Pad. **G** Suffix = Grooved Shoe.
D Suffix = Drilled Disc. **X** Suffix = Universal Left or Right Disc. **XC** Suffix = Contoured Disc. **LS** Suffix = Left/Steel Disc. **RS** = Right/Steel Disc.

*-2 Sets Required. † For Vee disc colours add RED, BLU, GRN, GLD, ORG suffix to part number. For Custom Finish Options for Vee-Rotors™ including Splatter discs add suffix CHR, CHGR, CHBL, CHBR - available in various colours see page iv. ☉ - Also available as a Vintage Motorcycle Disc.

Part numbers, prefixes, suffixes, photos and illustrations shown in this catalogue are trademarks and/or copyrights of EBC Brakes or the trademark owner A C Freeman Investments Ltd and use without express written permission of the owners is punishable by law.

JAPANESE Built Motorcycles



HONDA Contd.



DISC PAD CHOICES - FRONT

BRAKE DISC CHOICES - FRONT

R Suffix = High Durability Sintered Pad. **HH** Suffix = High Performance Sintered Pad. **TT** Suffix = Hard Wearing Off Road Pad. **V** Suffix = Semi Sintered Pad. **G** Suffix = Grooved Shoe.

D Suffix = Drilled Disc. **X** Suffix = Universal Left or Right Disc. **XC** Suffix = Contoured Disc. **LS** Suffix = Left/Steel Disc. **RS** = Right/Steel Disc.

Fit all three sets at pad change)	08-17
VT 1300 CTA Interstate	11-13
VT 1300 CXA (Fury/Chopper/Non ABS /9 Spoke Cast Wheel)	10-20
VT 1300 CXAA (Fury/Chopper/ABS /9 Spoke Cast Wheel)	10-20
VTX 1300 S (Spoke Wheel Models Only)	03-08
VTX 1300 C/T (Cast Wheel Models Only)	03-08
GL 1500 J/K Goldwing	88-89
GL 1500 L/SEM/SEN/SEP/SER/SES/SEV/SEW /SEX/SEY Goldwing	90-00
GL 1500 CV/CW/CX (F6C)	97-99
GL 1500 CY/C1/C2 (F6C)	00-03
F6B Goldwing (GLF6BA)	13-17
F6C Goldwing (GLF6CA)	14-17
GL 1800 A1/A2/A3/A4/A5 Goldwing	01-05
GL 1800 6/7/8/9/A/C/D/E/F/G/H Goldwing	06-17
GL 1800 B Goldwing J (Manual)	18-21
GL 1800 Goldwing Tour J (Manual)	18-21
GL 1800 BD Goldwing J (DCT)	18-21
GL 1800 J Goldwing DCT - Parking Brake	18-21
GL 1800 D Goldwing Tour J (DCT)	18-20
GL 1800 D Goldwing Tour J (DCT) - Parking Brake	18-20
GL 1800 DA Goldwing Tour Airbag J (DCT)	18-20
GL 1800 DA Goldwing Tour Airbag J (DCT) - Parking Brake	18-20
VTX 1800 C2/C3/C4/C15/CA6/CA7 (Note - linked brake system. Fit all three sets at pad change)	02-08

FRONT / AVANT / VORN / FRENTE / ANTERIORE

FA, SFA, TT Pad or Brake Shoe	SFAC Carbon Scooter Pads	Speciality Pads - SXR / Vee / MXS	Sintered/HH Pads/ Grooved Shoes	Left / Gauche / Links Standard Replacement Disc	Right / Droite / Rechts Standard Replacement Disc	Contour Disc Universal left and right fitment	Custom Disc Universal left and right fitment	Vee-Disks Black † See note below	CX Extreme MX Race Disc/ UTVX Disc
			FA388HH*	MD1154X	MD1154X	MD1154XC*			
			FA388HH						
FA196		FA196V	FA196HH						
FA388			FA388HH						
FA196		FA196V	FA196HH		MD1158RS				
FA196		FA196V	FA196HH		MD1182RS				
FA124/2*		FA124/2V*	FA124/2HH*	MD1126	MD1126				
FA124/2*		FA124/2V*	FA124/2HH*	MD1126	MD1126				
FA142*		FA142V*	FA142HH*	MD1014X	MD1014X	MD1014XC*	MD1014CC*	VR1014BLK*†	
FA142*		FA142V*	FA142HH*	MD1014X	MD1014X	MD1014XC*	MD1014CC*	VR1014BLK*†	
			FA261HH*						
			FA296HH*						
			FA261HH*	MD1014X	MD1014X	MD1014XC*	MD1014CC*	VR1014BLK*†	
			FA261HH*	MD1014X	MD1014X	MD1014XC*	MD1014CC*	VR1014BLK*†	
			FA717HH*						
			FA717HH*						
			FA717HH*						
FA257/2			FA717HH*						
FA257/2			FA717HH*						
FA257/2			FA717HH*						
			FA261HH*	MD1141X	MD1141X	MD1141XC*	MD1141CC*	VR1141BLK*†	
			S603						
FA083TT			FA083HH	MD4040LS					
S613			S613G						
S614*			S614G*						
H338*			H338G*						
H338*			H338G*						
FA083/2TT									
K715			K715G						
FA302TT			FA302R	MD6166D					MD6166CX
S603			S603G						
FA083TT			FA083HH	MD4040LS					
S614*			S614G*						
K701			K701G						
K714			K714G						
FA083TT			FA083R	MD6027D					
FA083TT			FA083R	MD6027D					
FA083TT			FA083R	MD6026D					
FA258TT			FA258R	MD6026D					
FA258TT			FA258R	MD6186D		MD6186C			MD6186CX
FA258TT			FA258R	MD6186D		MD6186C			MD6186CX
H338*			H338G*						
FA083/2TT									
S603			S603G						
S602									
FA048				MD4116LS					
FA067			FA067HH	MD4116LS					
FA067			FA067HH	MD4105LS					
S603			S603G						
FA083TT			FA083R	MD6027D					

Line #

*-2 Sets Required. † For Vee disc colours add RED, BLU, GRN, GLD, ORG suffix to part number. For Custom Finish Options for Vee-Rotors™ including Splatter discs add suffix CHR, CHGR, CHBL, CHBR - available in various colours see page iv. ☼ - Also available as a Vintage Motorcycle Disc.

JAPANESE Built Motorcycles

Line #	BRAKE DISC CHOICES - FRONT						DISC PAD CHOICES - REAR				BRAKE DISC CHOICES - REAR			
	OverSize 250 /280mm Disc Kit	OSX OverSize 250/280mm Disc Kit	Relocating Bracket for 250/ 280mm Disc	OverSize 320mm Disc Kit	SMX OverSize 320mm Disc Kit	Relocating Bracket for 320mm Disc	FA, SFA, TT Pad or Brake Shoe	SFAC Carbon Scooter Pads	Speciality Pads - SXR / Vee / MXS	Sintered/ HH Pads/ Grooved Shoes	Standard Replacement Disc	Contour Disc Rear fitment	Vee Discs CONTOUR	CX Extreme MX Race Disc
1								FA261V		MD1163				
2								FA216/2V	FA261/2HH					
3														
4							FA174	FA174V	FA174HH					
5														
6							FA174	FA174V	FA174HH					
7							FA174	FA174V	FA174HH	MD1159				
8							FA174	FA174V	FA174HH	MD1159				
9							FA069/3	FA069/3V	FA069/3HH	MD1127				
10														
11							FA069/3	FA069/3V	FA069/3HH	MD1077				
12							FA196	FA196V	FA196HH	MD1077				
13							FA196	FA196V	FA196HH	MD1148				
14								FA261/2V	FA261/2HH					
15								FA261/2V	FA261/2HH					
16								FA261/2V	FA261/2HH					
17								FA261/2V	FA261/2HH					
18									FA388/2HH					
19									FA388/2HH					
20									FA388/2HH					
21									FA388/2HH					
22									FA388/2HH					
23														
24									FA388/2HH					
25														
26														
27									FA261HH	MD1148				
28														
29														
30							S603		S603G					
31							S603							
32							S613		S613G					
33							S604		S604G					
34							FA305TT		FA305R	MD6267D				
35							FA305TT		FA305R	MD6267D				
36							FA067TT							
37							K715		K715G					
38							FA054TT	MXS054	FA054R	MD6166D			MD6166CX	
39							S603		S603G					
40							S603							
41							S618		S618G					
42							K701		K701G					
43							K715		K715G					
44							K715		K715G					
45							FA084TT		FA084R	MD6025D				
46							FA084TT		FA084R	MD6025D				
47							FA084TT		FA084R	MD6025D				
48	OS6186C		BRK025				FA084TT		FA084R	MD6187D	MD6187C		MD6187CX	
49	OS6186C		BRK025				FA084TT		FA084R	MD6187D	MD6187C		MD6187CX	
50														
51							FA305TT		FA305R	MD6267D				
52							FA067TT							
53							S603							
54							S603		S603G					
55							S603							
56							S603							
57							S603							
58							S602							
59							S603		S603G					
60							FA084TT		FA084R	MD6025D				

REAR / ARRIÈRE / HINTEN / POSTERIOR / POSTERIORE

R Suffix = High Durability Sintered Pad. **HH** Suffix = High Performance Sintered Pad. **TT** Suffix = Hard Wearing Off Road Pad. **V** Suffix = Semi Sintered Pad. **G** Suffix = Grooved Shoe.
D Suffix = Drilled Disc. **X** Suffix = Universal Left or Right Disc. **XC** Suffix = Contoured Disc. **LS** Suffix = Left/Steel Disc. **RS** = Right/Steel Disc.

*-2 Sets Required. † For Vee disc colours add RED, BLU, GRN, GLD, ORG suffix to part number. For Custom Finish Options for Vee-Rotors™ including Splatter discs add suffix CHR, CHGR, CHBL, CHBR - available in various colours see page iv. ☉ - Also available as a Vintage Motorcycle Disc.

Part numbers, prefixes, suffixes, photos and illustrations shown in this catalogue are trademarks and/or copyrights of EBC Brakes or the trademark owner A C Freeman Investments Ltd and use without express written permission of the owners is punishable by law.

JAPANESE Built Motorcycles



KAWASAKI Contd.



DISC PAD CHOICES - FRONT

BRAKE DISC CHOICES - FRONT

R Suffix = High Durability Sintered Pad. **HH** Suffix = High Performance Sintered Pad. **TT** Suffix = Hard Wearing Off Road Pad. **V** Suffix = Semi Sintered Pad. **G** Suffix = Grooved Shoe.

D Suffix = Drilled Disc. **X** Suffix = Universal Left or Right Disc. **XC** Suffix = Contoured Disc. **LS** Suffix = Left/Steel Disc. **RS** = Right/Steel Disc.

FRONT / AVANT / VORN / FRENTE / ANTERIORE

		DISC PAD CHOICES - FRONT				BRAKE DISC CHOICES - FRONT					Line #	
		FA, SFA, TT Pad or Brake Shoe	SFAC Carbon Scooter Pads	Speciality Pads - SXR / Vee / MXS	Sintered/HH Pads/ Grooved Shoes	Left / Gauche / Links Standard Replacement Disc	Right / Droite / Rechts Standard Replacement Disc	Contour Disc Universal left and right fitment	Custom Disc Universal left and right fitment	Vee-Discs Black † See note below		CX Extreme MX Race Disc/ UTVX Disc
KX 100 B2-B6	92-96	FA083TT			FA083R	MD6026D						1
KX 100 B7/C1/C2/C3	97-00	FA258TT			FA258R	MD6026D						2
Max 100		S603										3
KLF 110 B1-B2 Mojave	87-88	S603			S603G							4
KLX 110 R	02-21	K715			K715G							5
KLX 110 L	10-21	K715			K715G							6
Kaze-r 112cc	04	FA197			FA197HH							7
AR 125 A1-A7/B1-B8	82-94	FA067			FA067HH	MD4099						8
BN 125 A1/A2 Eliminator	98-99	FA054TT			FA054HH		MD4137RS					9
BN 125 A3/A4/A5/A6/A6F/A7F Eliminator	00-07	FA197			FA197HH		MD4137RS					10
J 125 ABS (SC125 AGF/BGF/CGF/CHF/CJF)	16-18	SFA142	SFAC142		SFA142HH							11
J 125 SE/ABS (SC125 AGFA/BGFA/CGFA/CHFA/CJFA)	16-21	SFA142	SFAC142		SFA142HH				VR9128			12
KDX 125 A1/A2/B1/B2	90-94	FA083TT			FA083R	MD6083D					MD6083CX	13
KE 125 A4-A12	76-85	K704			K704G							14
KH 125 A1-A4	77-81	FA039										15
KH 125 K1	83	FA054TT			FA054HH							16
KH 125 K2-K10	82-98	FA067			FA067HH							17
KH 125 L1 (EX)	84	FA067			FA067HH	MD4105LS						18
KLX 125 A1/A2/A3/A6F	03-06	S604			S604G							19
KLX 125 L (B1/B2/B3/B6F)	03-06	FA230TT			FA230R	MD6212D						20
KLX 125 CAF/CBF/CCF/CCS/CDF/CDS/CEF/CFF/CGF	10-16	FA135TT		MXS135	FA135R			MD6363C				21
KLX 125 DAF/DBF/DCF/DDF/DEF (D-Tracker)	10-14	FA135TT		MXS135	FA135R			MD6363C				22
KMX 125 A1-A5/B1-B9	86-98	FA083TT			FA083R	MD6106D						23
KMX 125 B2-B12 (From E/No MX AE 013437)	87-03	FA230TT			FA230R	MD6106D						24
KX 125 A3-A7	74-80	K704			K704G							25
KX 125 B1	82	FA083TT			FA083R							26
KX 125 B2/C1	83-84	FA067TT			FA067R							27
KX 125 D1	85	FA067TT			FA067R	MD6036D						28
KX 125 E1	86	FA067TT			FA067R	MD6036D						29
KX 125 E2/F1	87-88	FA130TT			FA130R	MD6036D						30
KX 125 G1/H1/H2/J1/J2	89-93	FA135TT		MXS135	FA135R	MD6015D		MD6015C			MD6015CX	31
KX 125 K1	94	FA185TT		MXS185	FA185R	MD6015D		MD6015C			MD6015CX	32
KX 125 K2/K3/K4/K5/L1/L2/L3/L4	95-02	FA185TT		MXS185	FA185R	MD6015D		MD6015C			MD6015CX	33
KX 125 M1/M2/M3	03-05	FA185TT		MXS185	FA185R	MD6213D		MD6213C			MD6213CX	34
♦ Plain undrilled disc for enduro use MD6208CE												35
KX 125 M6F/M7F/M8F	06-08	FA185TT		MXS185	FA185R	MD6264D		MD6264C			MD6264CX	36
♦ Plain undrilled disc for enduro use MD6208CE												37
Ninja 125 ABS	19-21	FA197			FA197HH			MD4166C				38
♦ Plain undrilled disc for enduro use MD4172CE												39
Z 125 Performance	16-21	FA197			FA197HH			MD4166C				40
♦ Plain undrilled disc for enduro use MD4172CE												41
Z 125 PRO (BR 125 HGF/JHF Manual G/Box)	16-20	FA691			FA691HH			MD4171C				42
Z 125 Pro SE (BR 125 JJFS Manual G/Box)	18-20	FA691			FA691HH			MD4171C				43
ZX 130 R	08-10	SFA197	SFAC197		SFA197HH							44
KLX 140 (17" front/14" rear)	08-20	FA135TT		MXS135	FA135R	MD6328C						45
KLX 140 L (19" front/16" rear)	08-20	FA135TT		MXS135	FA135R	MD6328C						46
KLX 140 G (21" front/18" rear)	17-20	FA135TT		MXS135	FA135R	MD6328C						47
KLX 150 L (KLX 150 EFF)	14-15	FA135TT		MXS135	FA135R							48
KLX 150 D-Tracker (KLX 150 HGF)	16	FA135TT		MXS135	FA135R							49
SC 150 A1 (Epsilon 150)	02	SFA396			SFA396HH	MD934D						50
BN 175 Boss 175	02											51
KDX 175 A1-A3	80-82	K704			K704G							52
KE 175 B1-B3	76-78	K704			K704G							53
KE 175 D2-D5	79-83	K704			K704G							54
KLF 185 A1	87	None										55
KDX 200 A1-A3	83-85	K703			K703G							56
KDX 200 C1/C2/C3	86-88	FA067TT			FA067R	MD6036D						57
KDX 200 E1/E2/E3/E4	89-92	FA067TT			FA067R	MD6036D						58
KDX 200 E5/E6	93-94	FA135TT		MXS135	FA135R	MD6015D		MD6015C			MD6015CX	59
KDX 200 H1/H2/H3/H4/H5	95-99	FA185TT		MXS185	FA185R	MD6083D					MD6083CX	60

*-2 Sets Required. † For Vee disc colours add RED, BLU, GRN, GLD, ORG suffix to part number. For Custom Finish Options for Vee-Rotors™ including Splatter discs add suffix CHR, CHGR, CHBL, CHBR - available in various colours see page iv. ☼ - Also available as a Vintage Motorcycle Disc.

100 Part numbers, prefixes, suffixes, photos and illustrations shown in this catalogue are trademarks and/or copyrights of EBC Brakes or the trademark owner A C Freeman Investments Ltd and use without express written permission of the owners is punishable by law.

JAPANESE Built Motorcycles

Line #	BRAKE DISC CHOICES - FRONT						DISC PAD CHOICES - REAR				BRAKE DISC CHOICES - REAR			
	OverSize 250 /280mm Disc Kit	OSX OverSize 250/280mm Disc Kit	Relocating Bracket for 250/ 280mm Disc	OverSize 320mm Disc Kit	SMX OverSize 320mm Disc Kit	Relocating Bracket for 320mm Disc	FA, SFA, TT Pad or Brake Shoe	SFAC Carbon Scooter Pads	Speciality Pads - SXR / Vee / MXS	Sintered/ HH Pads/ Grooved Shoes	Standard Replacement Disc	Contour Disc Rear fitment	Vee Discs CONTOUR	CX Extreme MX Race Disc
1							FA084TT			FA084R	MD6025D			
2							FA084TT			FA084R	MD6025D			
3							S603							
4							S602			S602G				
5							S603			S603G				
6							S603			S603G				
7							S603							
8							S602							
9							S602							
10							S602							
11							SFA498	SFAC498		SFA498HH	MD9129D		VR9129	
12							SFA498	SFAC498		SFA498HH	MD9129D		VR9129	
13							FA152TT		MXS152	FA152R	MD6105D			MD6105CX
14							S602			S602G				
15							K702							
16							S602							
17							S602							
18							S602							
19							S604			S604G				
20							S604			S604G				
21							FA054TT		MXS054	FA054R		MD6362C		
22							FA054TT		MXS054	FA054R		MD6362C		
23							FA067			FA067R	MD6107D			
24							FA067			FA067R	MD6107D			
25							S602			S602G				
26							S602			S602G				
27							K702			K702G				
28							K702			K702G				
29							FA067TT			FA067R	MD6161D			
30							FA067TT			FA067R	MD6161D			
31							FA152TT		MXS152	FA152R	MD6024D	MD6024C		MD6024CX
32	OS6015C	OSX6015	BRK023		SMX6015	BRK024	FA152TT		MXS152	FA152R	MD6024D	MD6024C		MD6024CX
33	OS6015C	OSX6015	BRK023		SMX6015	BRK024	FA131TT		MXS131	FA131R	MD6024D	MD6024C		MD6024CX
34	OS6213C	OSX6015	BRK023	SM6213C	SMX6015	BRK024	FA131TT		MXS131	FA131R	MD6208D	MD6208C		MD6208CX
35														
36	OS6264C	OSX6015	BRK023		SMX6015	BRK024	FA131TT		MXS131	FA131R	MD6208D	MD6208C		MD6208CX
37														
38	OS4171		BRK040				FA054TT			FA054HH		MD4172		
39														
40							FA054TT			FA054HH		MD4172		
41														
42							FA054TT			FA054HH		MD4172C		
43							FA054TT			FA054HH		MD4172C		
44							S603							
45							FA054TT		MXS054	FA054R				
46							FA054TT		MXS054	FA054R				
47							FA054TT		MXS054	FA054R				
48							FA054TT		MXS054	FA054R				
49							FA054TT		MXS054	FA054R				
50							S635							
51														
52							S602			S602G				
53							S602			S602G				
54							K703			K703G				
55							K706			K706G				
56							K702			K702G				
57							K702			K702G				
58							FA152TT		MXS152	FA152R	MD6024D			
59							FA152TT		MXS152	FA152R	MD6024D	MD6024C		MD6024CX
60							FA152TT		MXS152	FA152R	MD6105D			MD6015CX

REAR / ARRIÈRE / HINTEN / POSTERIOR / POSTERIORE

*-2 Sets Required. † For Vee disc colours add RED, BLU, GRN, GLD, ORG suffix to part number. For Custom Finish Options for Vee-Rotors™ including Splatter discs add suffix CHR, CHGR, CHBL, CHBR - available in various colours see page iv. ☉ - Also available as a Vintage Motorcycle Disc.

Part numbers, prefixes, suffixes, photos and illustrations shown in this catalogue are trademarks and/or copyrights of EBC Brakes or the trademark owner A C Freeman Investments Ltd and use without express written permission of the owners is punishable by law.

R Suffix = High Durability Sintered Pad. HH Suffix = High Performance Sintered Pad. TT Suffix = Hard Wearing Off Road Pad. V Suffix = Semi Sintered Pad. G Suffix = Grooved Shoe.
D Suffix = Drilled Disc. X Suffix = Universal Left or Right Disc. XC Suffix = Contoured Disc. LS Suffix = Left/Steel Disc. RS = Right/Steel Disc.

JAPANESE Built Motorcycles



KAWASAKI Contd.



DISC PAD CHOICES - FRONT

BRAKE DISC CHOICES - FRONT

R Suffix = High Durability Sintered Pad. **HH** Suffix = High Performance Sintered Pad. **TT** Suffix = Hard Wearing Off Road Pad. **V** Suffix = Semi Sintered Pad. **G** Suffix = Grooved Shoe.

D Suffix = Drilled Disc. **X** Suffix = Universal Left or Right Disc. **XS** Suffix = Contoured Disc. **LS** Suffix = Left/Steel Disc. **RS** = Right/Steel Disc.

FRONT / AVANT / VORN / FRENTE / ANTERIORE

		DISC PAD CHOICES - FRONT			BRAKE DISC CHOICES - FRONT						Line #	
		FA, SFA, TT Pad or Brake Shoe	SFAC Carbon Scooter Pads	Speciality Pads - SXR / Vee / MXS	Sintered/HH Pads/ Grooved Shoes	Left / Gauche / Links Standard Replacement Disc	Right / Droite / Rechts Standard Replacement Disc	Contour Disc Universal left and right fitment	Custom Disc Universal left and right fitment	Vee-Disks Black † See note below		CX Extreme MX Race Disc/ UTVX Disc
KDX 200 SR (DX 200 G)		FA135TT		MXS135	FA135R	MD6036D						1
KLT 200 A1/A4A/C1/C2	81-84	S603			S603G							2
KMX 200 A2/A3	88-92	FA083TT			FA083R	MD6057D						3
Z 200 A1-A5	77-82	FA039										4
Z 200 A6	83	FA067			FA067HH							5
KLF 220 A1-A15	88-02	K705*			K705G*							6
KDX 220 R A4-A12/A6F	97-06	FA185TT		MXS185	FA185R	MD6083D					MD6083CX	7
KDX 220 SR (DX 220 B)		FA185TT		MXS185	FA185R	MD6083D					MD6083CX	8
KLX 230	19-20	FA135X		MXS135	FA135R							9
KLX 230 R	19-20	FA135X		MXS135	FA135R							10
250 SIB	75	K711										11
ER 250 B1/B2/B3 (Z 250 T Scorpion)	83-88	FA085			FA085HH	MD4099						12
EL 250 D1-D5	90-94	FA085			FA085HH	MD4002LS						13
EL 252 (EL 250 F2/F3/F5/F6)	96-03	FA085			FA085HH		MD4002RS					14
EL 250 Eliminator	87-89	FA085			FA085HH		MD4002RS					15
BJ 250 B1-B7A Estrella	92-99	FA067			FA067HH							16
BJ 250 C1-C7 Estrella RS	99-02	FA067			FA067HH							17
BJ 250 D1-D7 Estrella Custom	96-02	S612										18
BJ 250 E1-E4A Estrella RS Custom	96-99	S612										19
BJ 250 F1/F2 (250 TR)	02-03	FA231			FA231HH							20
EX 250 K8F/K9F/KAF/KBF/KBFA/KCF Ninja 250R	08-12	FA197			FA197HH			MD4162C				21
EX 250 K8F/K9F/KAF/KBF/KBFA/KCF Ninja 250R - Floating disc option	08-12	FA197			FA197HH			MD4162XC				22
GPX 250 R (ZX 250 F2-F9)	88-95	FA129			FA129HH		MD4041RS					23
GPX 250 R (EX 250 E)	86	FA085			FA085HH	MD4002LS						24
GPX 250 R (EX 250 F)	87	FA129			FA129HH		MD4041RS					25
GPX 250 RII (EX 250 G)	88	FA141*										26
KDX 250 B1	79	K705			K705G							27
KDX 250 B2/B3	80-84	K705			K705G							28
KDX 250 D1	91-93	FA135TT		MXS135	FA135R	MD6083D					MD6083CX	29
KH 250 B1-B5	77-82	FA033										30
KDX 250 SR (KDX 250 F1)	91	FA135TT		MXS135	FA135R	MD6083D					MD6083CX	31
KL 250 A1/A2	78-79	K705			K705G							32
KL 250 A3/A4/C1/C2	80-84	K704			K704G							33
KL 250 J1/J3 Stockman		FA258TT			FA258R	MD6239D						34
KL 250 G1/G1A Super Sherpa	97-00	FA258TT			FA258R	MD6239D						35
KLE 250 A2 Anhelo	95	FA129			FA129R							36
KLE 250 A3	97	FA129			FA129R							37
KLE 250 A5/A6	00-01	FA129			FA129R							38
KLX 250 H1 Super Sherpa	98	FA258TT			FA258R	MD6239D						39
KLF 250 A1/A2/A3/A6F-A9F/AAF/ABF (Bayou 250)	03-11	K705*			K705G*							40
KLR 250 D2-D22	84-05	FA067			FA067R	MD6057D						41
KLT 250 C1-C3 Prairie	83-85	S603			S603G							42
KLX 250 R D1/D2	93-94	FA185TT		MXS185	FA185R	MD6015D		MD6015C			MD6015CX	43
KLX 250 F1-F4 (KLX 250 ES)	94-97	FA185TT		MXS185	FA185R	MD6091D						44
KLX 250 G1	94	FA185TT		MXS185	FA185R	MD6091D						45
KLX 250 J1-J6 D-Tracker	98-03	FA185TT		MXS185	FA185R	MD6240D		MD6240C				46
KLX 250 S H6F/H7F (If installing oversize disc kit, longer brake hose is required - Goodridge ref 62024)	06-07	FA185TT		MXS185	FA185R	MD6330D		MD6330C			MD6330CX	47
KLX 250 SF	09-20	FA135TT		MXS135	FA135R			MD6351C				48
KLX 250 SF	09-20	FA135TT		MXS135	FA135R			MD6351C				49
KR-1 (KR 250 B2)	89	FA141*				MD4095X	MD4095X					50
KR-1S (KR 250 C2/C3)	90-92	FA158*			FA158HH*	MD4008X	MD4008X	MD4008XC*	MD4008CC*	VR4008BLK*†		51
KR 250 A1/A2	84-86	FA067*			FA067HH*							52
KSF 250 A1-A18 (KFX 250 Mojave)	87-04	FA128TT*			FA128R*	MD6133D	MD6133D					53
KT 250 All models	75-80	K704			K704G							54
KX 250	74	S602			S602G							55
KX 250 A/A3/A4/A5	75-79	K705			K705G							56
KX 250 A6/A7	80-81	K705			K705G							57
KX 250 B1	82	FA083TT			FA083R							58

*-2 Sets Required. † For Vee disc colours add RED, BLU, GRN, GLD, ORG suffix to part number. For Custom Finish Options for Vee-Rotors™ including Splatter discs add suffix CHR, CHGR, CHBL, CHBR - available in various colours see page iv. ☼ - Also available as a Vintage Motorcycle Disc.

JAPANESE Built Motorcycles

Line #	BRAKE DISC CHOICES - FRONT						DISC PAD CHOICES - REAR				BRAKE DISC CHOICES - REAR			
	Oversize 250 /280mm Disc Kit	OSX Oversize 250/280mm Disc Kit	Relocating Bracket for 250/ 280mm Disc	Oversize 320mm Disc Kit	SMX Oversize 320mm Disc Kit	Relocating Bracket for 320mm Disc	FA, SFA, TT Pad or Brake Shoe	SFAC Carbon Scooter Pads	Speciality Pads - SXR / Vee / MXS	Sintered/ HH Pads/ Grooved Shoes	Standard Replacement Disc	Contour Disc Rear fitment	Vee Discs CONTOUR	CX Extreme MX Race Disc
1							FA152TT		MXS152	FA152R	MD6105D			
2							K705			K705G				
3							FA067TT			FA067R	MD6108D			
4							S602							
5							S602							
6							K706			K706G				
7							FA152TT		MXS152	FA152R	MD6105D			MD6105CX
8							FA152TT		MXS152	FA152R	MD6105D			MD6105CX
9							FA54X		MXS54	FA54R				
10							FA54X		MXS54	FA54R				
11							K708							
12							K706							
13							K706							
14							K706							
15							K706							
16							FA067			FA067HH				
17							FA067			FA067HH				
18							K706							
19							K706							
20							K706							
21							FA197			FA197HH		MD4163C		
22														
23							FA197			FA197HH		MD4163C		
24							FA141				MD4042			
25							FA085		FA085V	FA085HH	MD4032			
26							FA141				MD4042			
27							FA141				MD4042			
28							S605			S605G				
29							S602			S602G				
30							FA152TT		MXS152	FA152R	MD6105D			MD6105CX
31							K708							
32							FA152TT		MXS152	FA152R	MD6105D			MD6105CX
33							S605			S605G				
34							K703			K703G				
35							FA067TT			FA067R	MD6107D			
36							FA067TT			FA067R	MD6107D			
37							FA067/3							
38							FA067/3							
39							FA067/3							
40							FA067TT			FA067R	MD6107D			
41							K706			K706G				
42							K703			K703G				
43							K705			K705G				
44							FA152TT		MXS152	FA152R	MD6085D			
45							FA152TT		MXS152	FA152R	MD6085D			
46							FA152TT		MXS152	FA152R	MD6085D			
47	OS6240C	OSX6240	BRK023		SMX6240	BRK024	FA131TT		MXS131	FA131R	MD6105D			
48														
49		OSX6330	BRK021	SM6330C	SMX6330	BRK022	FA131TT		MXS131	FA131R	MD6105D			MD6105CX
50		OSX6330	BRK021		SMX6330	BRK022	FA131TT		MXS131	FA131R		MD6352C		
51		OSX6330	BRK021		SMX6330	BRK022	FA131TT		MXS131	FA131R		MD6326C		
52							FA141				MD4096			
53							FA141				MD4096			
54							FA085		FA085V	FA085HH				
55							FA084TT			FA084R	MD6132D			
56							S602			S602G				
57							S605			S605G				
58							S605			S605G				
59							S605			S605G				
60							S602			S602G				

REAR / ARRIÈRE / HINTEN / POSTERIOR / POSTERIORE

R Suffix = High Durability Sintered Pad. **HH** Suffix = High Performance Sintered Pad. **TT** Suffix = Hard Wearing Off Road Pad. **V** Suffix = Semi Sintered Pad. **G** Suffix = Grooved Shoe.
D Suffix = Drilled Disc. **X** Suffix = Universal Left or Right Disc. **XC** Suffix = Contoured Disc. **LS** Suffix = Left/Steel Disc. **RS** = Right/Steel Disc.

BRAKE APPLICATIONS

*-2 Sets Required. † For Vee disc colours add RED, BLU, GRN, GLD, ORG suffix to part number. For Custom Finish Options for Vee-Rotors™ including Splatter discs add suffix CHR, CHGR, CHBL, CHBR - available in various colours see page iv. ☉ - Also available as a Vintage Motorcycle Disc.

JAPANESE Built Motorcycles



KAWASAKI Contd.



DISC PAD CHOICES - FRONT

BRAKE DISC CHOICES - FRONT

R Suffix = High Durability Sintered Pad. **HH** Suffix = High Performance Sintered Pad. **TT** Suffix = Hard Wearing Off Road Pad. **V** Suffix = Semi Sintered Pad. **G** Suffix = Grooved Shoe.

D Suffix = Drilled Disc. **X** Suffix = Universal Left or Right Disc. **XC** Suffix = Contoured Disc. **LS** Suffix = Left/Steel Disc. **RS** = Right/Steel Disc.

FRONT / AVANT / VORN / FRENTE / ANTERIORE

		FA, SFA, TT Pad or Brake Shoe	SFAC Carbon Scooter Pads	Speciality Pads - SXR / Vee / MXS	Sintered/HH Pads/ Grooved Shoes	Left / Gauche / Links Standard Replacement Disc	Right / Droite / Rechts Standard Replacement Disc	Contour Disc Universal left and right fitment	Custom Disc Universal left and right fitment	Vee-Disks Black † See note below	CX Extreme MX Race Disc/ UTVX Disc	Line #
KX 250 C1/C2	83-84	FA067TT			FA067R							1
KX 250 D1	85	FA067TT			FA067R	MD6036D						2
KX 250 D2	86	FA067TT			FA067R	MD6036D						3
KX 250 E1/F1	87-88	FA130TT			FA130R	MD6036D						4
KX 250 G1/H1/H2/J1/J2	89-93	FA135TT		MXS135	FA135R	MD6015D		MD6015C			MD6015CX	5
KX 250 K1	94	FA185TT		MXS185	FA185R	MD6015D		MD6015C			MD6015CX	6
KX 250 K2/K3/K4/K5/L1/L2/L3/L4	95-02	FA185TT		MXS185	FA185R	MD6015D		MD6015C			MD6015CX	7
KX 250 M1/M2/R1 (2T)	03-05	FA185TT		MXS185	FA185R	MD6213D		MD6213C			MD6213CX	8
♦ Plain undrilled disc for enduro use MD6208CE												9
KX 250 R6F/R7F/R8F (2T)	06-08	FA185TT		MXS185	FA185R	MD6264D		MD6264C			MD6264CX	10
♦ Plain undrilled disc for enduro use MD6208CE												11
KXF 250 (KX 250 N1/N2) (4T)	04-05	FA185TT		MXS185	FA185R	MD6213D		MD6213C			MD6213CX	12
♦ Plain undrilled disc for enduro use MD6208CE												13
KXF 250 (T6F/T7F/T8F) (4T)	06-08	FA185TT		MXS185	FA185R	MD6264D		MD6264C			MD6264CX	14
♦ Plain undrilled disc for enduro use MD6208CE												15
KXF 250 (KX 250 W9F/XAFB/YBF/YCF/ZDF/ZE) (4T)	09-14	FA185TT		MXS185	FA185R			MD6264C			MD6264CX	16
♦ Plain undrilled disc for enduro use MD6208CE												17
KXF 250 270mm Front, 240mm Rear Rotor	15-22	FA185TT		MXS185	FA185R			MD6388C			MD6388CX	18
♦ Plain undrilled disc for enduro use MD6208CE												19
KXF 250 X Enduro 270mm F/disc & 240mm R/Disc, 18" R/wheel	21-22	FA185TT		MXS185	FA185R			MD6388C			MD6388CX	20
♦ Plain undrilled disc for enduro use MD6208CE												21
KXF 250 A1/A2 Tecate 4	87-88	FA128TT*			FA128R*	MD6133D	MD6133D					22
KXT 250 A1 Tecate - 3 Wheel Model	84	K705			K705G							23
KXT 250 A2 Tecate - 3 Wheel Model	85	FA067TT			FA067R							24
KXT 250 B1 Tecate - 3 Wheel Model	86	FA067TT			FA067R	MD6138D						25
KXT 250 B2 Tecate - 3 Wheel Model	87	FA067TT			FA067R	MD6138D						26
SC 250 A1 (Epsilon 250)	02	SFA283/4	SFAC283/4		SFA283/4HH	MD929D				VR929		27
S1-A/B/C (250cc)	73-75	K711										28
Z 250 A1/A2	78-80	FA073										29
Z 250 A3	81	FA068			FA068HH	MD4010LS						30
Z 250 B1/B2	80-83	K711										31
Z 250 C1/C2/G1/G2	81-83	K711										32
Z 250 SL (Naked Non ABS) (BR 250 EFF/EGF/FHF)	15-17	FA197			FA197HH			MD4166C			MD4166CX	33
Z 250 SL (Naked ABS) (BR 250 FFF/FGF)	15-16	FA197			FA197HH			MD4166C			MD4166CX	34
Ninja 250 SL (BX 250 AFF/AFS/AFSA)												35
KRT Edition Non ABS)	15	FA197			FA197HH			MD4166C			MD4166CX	36
Ninja 250 SL (BX 250 BFF/BFS/BGF/BGFS ABS)	15-16	FA197			FA197HH			MD4166C			MD4166CX	37
Ninja 250 SL (BX 250 BFSA/BGSA KRT/ABS Edition)	15-16	FA197			FA197HH			MD4166C			MD4166CX	38
ZR 250 A1-A5 Balius	91-95	FA129			FA129HH		MD4008X	MD4008XC	MD4008CC	VR4008BLK†		39
ZR 250 B6 Balius-II	02	FA231			FA231HH		MD4008X	MD4008XC	MD4008CC	VR4008BLK†		40
ZZR 250 (EX 250 H1-H13)	90-01	FA129			FA129HH		MD4008X	MD4008XC	MD4008CC	VR4008BLK†		41
ZXR 250 (ZX 250 A1/A2)	89-90	FA141*				MD4008X	MD4008X	MD4008XC*	MD4008CC*	VR4008BLK*†		42
ZXR 250 R (ZX 250 B1/B2)	89-90	FA141*				MD4008X	MD4008X	MD4008XC*	MD4008CC*	VR4008BLK*†		43
ZXR 250 C1-C3 (ZX 250 C1-C3)	91-95	FA141*				MD4149LS	MD4149RS					44
ZXR 250 R (ZX 250 D1)	91	FA141*				MD4149LS	MD4149RS					45
ZX-25 Ninja	20-21	FA379			FA379HH							46
EX 300 ADF/AEF/AFF Ninja 300 (Non ABS)	13-15	FA197			FA197HH			MD4166C		VR4166BLK†		47
EX 300 ADF/AEF/AFF Ninja 300 (Non ABS)												48
- Floating disc option	13-15	FA197			FA197HH			MD4166XC		VR4166BLK†		49
EX 300 AEFA/AFFA/AGFA Ninja 300 (Non ABS)	14-16	FA197			FA197HH			MD4166C		VR4166BLK†		50
EX 300 AEFA/AFFA/AGFA Ninja 300 (Non ABS)												51
- Floating disc option	14-16	FA197			FA197HH			MD4166XC		VR4166BLK†		52
EX 300 BDF/BEF/BFF/BGF Ninja 300 (ABS)	13-16	FA197			FA197HH			MD4166C		VR4166BLK†		53
EX 300 BDF/BEF/BFF/BGF Ninja 300 (ABS)												54
- Floating disc option	13-16	FA197			FA197HH			MD4166XC		VR4166BLK†		55
EX 300 BEFA/BFFA/BGFA Ninja 300 (ABS)	14-16	FA197			FA197HH			MD4166C		VR4166BLK†		56
- Floating disc option	14-16	FA197			FA197HH			MD4166XC		VR4166BLK†		57
J300 AEF/AFF/AGF (Non ABS)	14-16	SFA142	SFAC142		SFA142HH					VR9128		58
J300 AEFA/AFFA/AGFA Special Edition (Non ABS)	14-16	SFA142	SFAC142		SFA142HH					VR9128		59
J300 (ABS)	14-20	SFA142	SFAC142		SFA142HH							60

*-2 Sets Required. † For Vee disc colours add RED, BLU, GRN, GLD, ORG suffix to part number. For Custom Finish Options for Vee-Rotors™ including Splatter discs add suffix CHR, CHGR, CHBL, CHBR - available in various colours see page iv. ☉ - Also available as a Vintage Motorcycle Disc.

JAPANESE Built Motorcycles

Line #	BRAKE DISC CHOICES - FRONT						DISC PAD CHOICES - REAR				BRAKE DISC CHOICES - REAR			
	Oversize 250 /280mm Disc Kit	OSX Oversize 250/280mm Disc Kit	Relocating Bracket for 250/ 280mm Disc	Oversize 320mm Disc Kit	SMX Oversize 320mm Disc Kit	Relocating Bracket for 320mm Disc	FA, SFA, TT Pad or Brake Shoe	SFAC Carbon Scooter Pads	Speciality Pads - SXR / Vee / MXS	Sintered/ HH Pads/ Grooved Shoes	Standard Replacement Disc	Contour Disc Rear fitment	Vee Discs CONTOUR	CX Extreme MX Race Disc
1							S602			S602G				
2							S602			S602G				
3							FA067TT			FA067R	MD6161D			
4							FA067TT			FA067R	MD6161D			
5							FA152TT		MXS152	FA152R	MD6024D	MD6024C		MD6024CX
6	OS6015C	OSX6015	BRK023		SMX6015	BRK024	FA152TT		MXS152	FA152R	MD6024D	MD6024C		MD6024CX
7	OS6015C	OSX6015	BRK023		SMX6015	BRK024	FA131TT		MXS131	FA131R	MD6024D	MD6024C		MD6024CX
8	OS6213C	OSX6213	BRK023	SM6213C	SMX6213	BRK024	FA131TT		MXS131	FA131R	MD6208D	MD6208C		MD6208CX
9														
10	OS6264C	OSX6264	BRK023		SMX6264	BRK024	FA131TT		MXS131	FA131R	MD6208D	MD6208C		MD6208CX
11														
12	OS6213C	OSX6213	BRK023	SM6213C	SMX6213	BRK024	FA367TT		MXS367	FA367R	MD6208D	MD6208C		MD6208CX
13														
14	OS6264C	OSX6264	BRK023		SMX6264	BRK024	FA367TT		MXS367	FA367R	MD6208D	MD6208C		MD6208CX
15														
16	OS6264C	OSX6264	BRK023		SMX6264	BRK024	FA367TT		MXS367	FA367R		MD6208C		MD6208CX
17														
18		OSX6264	BRK023		SMX6264	BRK024	FA367TT		MXS367	FA367R		MD6208C		MD6208CX
19														
20					SMX6264	BRK024	FA367TT		MXS367	FA367R		MD6208C		MD6208CX
21														
22							FA083TT			FA083R	MD6136D			
23							FA083TT			FA083R				
24							FA067TT			FA067R				
25							FA067TT			FA067R	MD6138D			
26							FA084TT			FA084R	MD6134D			
27							SFA323/3			SFA323/3HH	MD930D	MD930C	VR930	
28							K708							
29							FA161							
30							FA161			FA161HH				
31							K706							
32							S602							
33							FA197			FA197HH		MD4163C		
34							FA197			FA197HH		MD4163C		
35														
36							FA197			FA197HH		MD4163C		
37							FA197			FA197HH		MD4179AC		
38							FA197			FA197HH		MD4179AC		
39							FA067/3				MD4051	MD4051C		
40							FA067			FA067HH	MD4051	MD4051C		
41							FA067/3				MD4117			
42							FA141				MD4051	MD4051C		
43							FA141				MD4051	MD4051C		
44							FA067/3				MD4051	MD4051C		
45							FA067/3				MD4051	MD4051C		
46							FA174			FA174HH				
47							FA197			FA197HH		MD4163C	VR4163	
48														
49							FA197			FA197HH		MD4163C	VR4163	
50							FA197			FA197HH		MD4163C	VR4163	
51														
52							FA197			FA197HH		MD4163C	VR4163	
53							FA197			FA197HH		MD4179AC		
54														
55							FA197			FA197HH		MD4179AC		
56							FA197			FA197HH		MD4179AC		
57							FA197			FA197HH		MD4179AC		
58							SFA498	SFAC498		SFA498HH		MD9129D	VR9129	
59							SFA498	SFAC498		SFA498HH		MD9129D	VR9129	
60							SFA498	SFAC498		SFA498HH		MD9129D	VR9129	

REAR / ARRIÈRE / HINTEN / POSTERIOR / POSTERIORE

R Suffix = High Durability Sintered Pad. **HH** Suffix = High Performance Sintered Pad. **TT** Suffix = Hard Wearing Off Road Pad. **V** Suffix = Semi Sintered Pad. **G** Suffix = Grooved Shoe.
D Suffix = Drilled Disc. **X** Suffix = Universal Left or Right Disc. **XC** Suffix = Contoured Disc. **LS** Suffix = Left/Steel Disc. **RS** = Right/Steel Disc.

*-2 Sets Required. † For Vee disc colours add RED, BLU, GRN, GLD, ORG suffix to part number. For Custom Finish Options for Vee-Rotors™ including Splatter discs add suffix CHR, CHGR, CHBL, CHBR - available in various colours see page iv. ☉ - Also available as a Vintage Motorcycle Disc.

BRAKE APPLICATIONS

JAPANESE Built Motorcycles



KAWASAKI Contd.



DISC PAD CHOICES - FRONT

BRAKE DISC CHOICES - FRONT

		FA, SFA, TT Pad or Brake Shoe	SFAC Carbon Scooter Pads	Speciality Pads - SXR / Vee / MXS	Sintered/HH Pads/ Grooved Shoes	Left / Gauche / Links Standard Replacement Disc	Right / Droite / Rechts Standard Replacement Disc	Contour Disc Universal left and right fitment	Custom Disc Universal left and right fitment	Vee-Disks Black † See note below	CX Extreme MX Race Disc/ UTVX Disc	Line #
J300 Special Edition (ABS)	14-20	SFA142	SFAC142		SFA142HH					VR9128		1
KAF 300 A1/B1/B2 (Mule 500)		S628*			S628G*							2
KAF 300 C1/C2/C3/C4/C6/C7/D1 (Mule 550)		S628*			S628G*							3
KEF 300 B1/B2/B3 Lakota Sport	01-03	FA128TT*			FA128R*	MD6133D	MD6133D					4
KLE 300 CHF/CJF Versys-X 300 ABS	17-20	FA142			FA142HH			MD4166XC		VR4166BLK†		5
KLE 300 BHF/Versys-X 300 Non ABS	17-20	FA142			FA142HH			MD4166XC		VR4166BLK†		6
KLF 300 A1/A2 Bayou	86-87	K717*			K717G*							7
KLF 300 B1-B17 Bayou	88-04	FA067*			FA067R*	MD6133D	MD6133D					8
KLF 300 C1-C17 Bayou	Left 89-05	FA165TT		MXS165	FA165R	MD6131D						9
	Right	FA135TT		MXS135	FA135R		MD6131D					10
KLX 300 A2-A10/A6F/A7F	97-07	FA185TT		MXS185	FA185R	MD6015D					MD6015CX	11
KLX 300 R	19-20	FA135TT		MXS135	FA135R							12
KVF 300 A1/A2/A3/A4 (Prairie 4 x 4)	99-02	FA054TT*		MXS054*	FA054R*	MD6131D	MD6131D					13
KVF 300 B1/B2/B3/B4 (Prairie 2 x 4)	99-02	FA054TT*		MXS054*	FA054R*	MD6131D	MD6131D					14
KVF 300 CCF/CDF/CEF/CFF/CGF/CHF Brute Force	12-17	FA377TT*			FA377R*	MD6267D	MD6267D					15
Z 300 Non ABS (ER 300 AFF/AGF)	15-16	FA197			FA197HH			MD4166C		VR4166BLK†		16
Z 300 ABS (ER 300 BFF/BGF/BGFA) Ninja 300 (ABS)	15-16	FA197			FA197HH			MD4166C		VR4166BLK†		17
Z 300 ABS (ER 300 BFF/BGF/BGFA) Ninja 300 (ABS)												18
- Floating Disc Conversion	15-16	FA197			FA197HH			MD4166XC		VR4166BLK†		19
GPZ 305 A1/B1-B10	83-96	FA067*			FA067HH*	MD4105LS	MD4105RS					20
S2 (350cc)	72-73	K711										21
S2-A (350cc)	72-73	FA033										22
KVF 360 A1-A3/A6F/A7F/A8F/A9F/AAF/ABF/ACF/ADF	03-13	FA054TT*		MXS054*	FA054R*	MD6188D	MD6188D					23
KVF 360 B1-B3/B6F/B7F/B8F/B9F	03-09	FA054TT*		MXS054*	FA054R*	MD6188D	MD6188D					24
KVF 360 C1-C3/C6F/C7F/C8F Prairie All models	03-08	FA054TT*		MXS054*	FA054R*	MD6188D	MD6188D					25
KAF 400 A6F/A7F/A8F/A9F/AAF (Mule 610 4 x 4)	06-10	K718*										26
KAF 400 ABF/ACF/ADF/AEF (Mule 610 4 x 4)	11-14	K718*										27
KAF 400 B6F/B7F/B8F/B9F/BAF/BBF/BCF/BDF/BEF (Mule 600)	06-14	K718*										28
		K718*										29
KAF 400 JHF (Mule SX)	17	K718*										30
KAF 400 HHF (Mule SX 4 x 4)	17	K718*										31
KAF 400 NHF (Mule SX 4 x 4 SE)	17	K718*										32
KAF 400 KHf (Mule SX 4 x 4 XC)	17	K718*										33
KAF 400 LHF (Mule SX 4 x 4 XC Camo)	17	K718*										34
KAF 400 MHF (Mule SX 4 x 4 XC SE)	17	K718*										35
KH 400 A3/A4/A5	76-78	FA033				VMD4123						36
KLF 400 B1-B7 Bayou	Left 93-99	FA165TT		MXS165	FA165R	MD6131D						37
	Right	FA135TT		MXS135	FA135R		MD6131D					38
KSF 400 A1/A2/A3/A6F (KFX 400)	03-06	FA084TT*		MXS084*	FA084R*	MD6210D	MD6210D					39
KVF 400 A1/A2/B1 Prairie	97-98	FA054TT*		MXS054*	FA054R*	MD6131D	MD6131D					40
KVF 400 C1/C2/C3/C4 (Prairie 4 x 4)	99-02	FA054TT*		MXS054*	FA054R*	MD6131D	MD6131D					41
KVF 400 D1/D2/D3 (Prairie 2 x 4)	99-01	FA054TT*		MXS054*	FA054R*	MD6131D	MD6131D					42
S3/S3-A (400cc)	74-75	FA033										43
Z 400 B1/B2	78-80	FA048										44
Z 400 G1	79	FA033										45
Z 400 J1	80	FA073*				MD4047LS	MD4047RS					46
Z 400 J2/J3	81-83	FA068*			FA068HH*	MD4010LS	MD4010RS					47
ZR 400 A1/B1 (Z 400 F)	83-84	FA067*			FA067HH*	MD4108LS	MD4108RS					48
Z 400 C2/C3 (Z 400 F2)	85-87	FA067*			FA067HH*	MD4028	MD4028					49
ZL 400 A Eliminator	86-87	FA085			FA085HH	MD4016						50
ZL 400 B Eliminator 400 SE	88	FA067*			FA067HH*	MD4135LS	MD4135RS					51
ZL 400 D1/D2	94-95	FA129			FA129HH	MD4008X	MD4008XC	MD4008CC		VR4008BLK†		52
FX 400 R (ZX 400 E1-E3)	86-88	FA067*			FA067HH*	MD4135LS	MD4135RS					53
GPZ 400 R (ZX 400 D/D3/D3A)	85-87	FA067*			FA067HH*	MD4135LS	MD4135RS					54
GPZ 400 R D4	88	FA141*				MD4143LS	MD4143RS					55
GPX 400 R (ZX 400 F1)	87	FA141*				MD4140LS	MD4140RS					56
KLX 400 R (KLX 400 B1/B2)	03-04	FA185TT		MXS185	FA185R	MD6017D		MD6017C			MD6017CX	57
Ninja 400 (EX 400 GJF/GJFA- ABS)	17-21	FA197			FA197HH		MD4174X	MD4174XC		VR4174BLK†		58
Ninja 400 (EX 400 GJF/GJFA- ABS KRT)	18-21	FA197			FA197HH		MD4174X	MD4174XC		VR4174BLK†		59
Z 400 ABS	18-21	FA197			FA197HH		MD4174X	MD4174XC		VR4174BLK†		60

FRONT / AVANT / VORN / FRENTE / ANTERIORE

R Suffix = High Durability Sintered Pad. HH Suffix = High Performance Sintered Pad. TT Suffix = Hard Wearing Off Road Pad. V Suffix = Semi Sintered Pad. G Suffix = Grooved Shoe. D Suffix = Drilled Disc. X Suffix = Universal Left or Right Disc. XC Suffix = Contoured Disc. LS Suffix = Left/Steel Disc. RS = Right/Steel Disc.

*-2 Sets Required. † For Vee disc colours add RED, BLU, GRN, GLD, ORG suffix to part number. For Custom Finish Options for Vee-Rotors™ including Splatter discs add suffix CHR, CHGR, CHBL, CHBR - available in various colours see page iv. ☼ - Also available as a Vintage Motorcycle Disc.

JAPANESE Built Motorcycles

Line #	BRAKE DISC CHOICES - FRONT						DISC PAD CHOICES - REAR				BRAKE DISC CHOICES - REAR			
	OverSize 250 /280mm Disc Kit	OSX OverSize 250/280mm Disc Kit	Relocating Bracket for 250/ 280mm Disc	OverSize 320mm Disc Kit	SMX OverSize 320mm Disc Kit	Relocating Bracket for 320mm Disc	FA, SFA, TT Pad or Brake Shoe	SFAC Carbon Scooter Pads	Speciality Pads - SXR / Vee / MXS	Sintered/ HH Pads/ Grooved Shoes	Standard Replacement Disc	Contour Disc Rear fitment	Vee Discs CONTOUR	CX Extreme MX Race Disc
1							SFA498	SFAC498		SFA498HH		MD9129D	VR9129	
2							K718*							
3							K718*							
4							FA084TT			FA084R	MD6132D			
5							FA197			FA197HH				
6							FA197			FA197HH				
7							K706			K706G				
8							K706			K706G				
9							K710			K710G				
10														
11							FA131TT		MXS131	FA131R	MD6105D			MD6105CX
12							FA131TT		MXS131	FA131R				
13							K710			K710G				
14							K710			K710G				
15							FA377TT			FA377R	MD6267D			
16							FA197			FA197HH		MD4163C		
17							FA197			FA197HH		MD4179AC		
18														
19							FA197			FA197HH		MD4179AC		
20							K706							
21							K708							
22							K708							
23														
24														
25														
26							K718*							
27							K719*							
28														
29							K718*							
30							K718*							
31							K718*							
32							K718*							
33							K718*							
34							K718*							
35							K718*							
36							K708							
37							K710			K710G				
38														
39							FA137TT			FA137R	MD6211D			
40							K710			K710G				
41							K710			K710G				
42							K710			K710G				
43							K708							
44							K706							
45							K706							
46							K709							
47							K709							
48							K706							
49							FA085		FA085V	FA085HH	MD4001			
50							K709							
51							K709							
52							K709							
53							FA085		FA085V	FA085HH	MD4015			
54							FA085		FA085V	FA085HH	MD4015			
55							FA129							
56							FA129				MD4027			
57	OS6017C	OSX6017	BRK023	SM6017C	SMX6017	BRK024	FA131TT		MXS131	FA131R	MD6014D	MD6014C		MD6014CX
58							FA197			FA197HH		MD4179AC		
59							FA197			FA197HH		MD4179AC		
60							FA197			FA197HH		MD4179AC		

REAR / ARRIÈRE / HINTEN / POSTERIOR / POSTERIORE

*-2 Sets Required. † For Vee disc colours add RED, BLU, GRN, GLD, ORG suffix to part number. For Custom Finish Options for Vee-Rotors™ including Splatter discs add suffix CHR, CHGR, CHBL, CHBR - available in various colours see page iv. Ⓢ - Also available as a Vintage Motorcycle Disc.

Part numbers, prefixes, suffixes, photos and illustrations shown in this catalogue are trademarks and/or copyrights of EBC Brakes or the trademark owner A C Freeman Investments Ltd and use without express written permission of the owners is punishable by law. 107

R Suffix = High Durability Sintered Pad. **HH** Suffix = High Performance Sintered Pad. **TT** Suffix = Hard Wearing Off Road Pad. **V** Suffix = Semi Sintered Pad. **G** Suffix = Grooved Shoe.
D Suffix = Drilled Disc. **X** Suffix = Universal Left or Right Disc. **XC** Suffix = Contoured Disc. **LS** Suffix = Left/Steel Disc. **RS** = Right/Steel Disc.

BRAKE APPLICATIONS

JAPANESE Built Motorcycles



KAWASAKI Contd.



DISC PAD CHOICES - FRONT

BRAKE DISC CHOICES - FRONT

R Suffix = High Durability Sintered Pad. **HH** Suffix = High Performance Sintered Pad. **TT** Suffix = Hard Wearing Off Road Pad. **V** Suffix = Semi Sintered Pad. **G** Suffix = Grooved Shoe.

D Suffix = Drilled Disc. **X** Suffix = Universal Left or Right Disc. **XC** Suffix = Contoured Disc. **LS** Suffix = Left/Steel Disc. **RS** = Right/Steel Disc.

FRONT / AVANT / VORN / FRENTE / ANTERIORE

		FA, SFA, TT Pad or Brake Shoe	SFAC Carbon Scooter Pads	Speciality Pads - SXR / Vee / MXS	Sintered/HH Pads/ Grooved Shoes	Left / Gauche / Links Standard Replacement Disc	Right / Droite / Rechts Standard Replacement Disc	Contour Disc Universal left and right fitment	Custom Disc Universal left and right fitment	Vee-Disks Black † See note below	CX Extreme MX Race Disc/ UTVX Disc	Line #
ZR 400 D1/D3/D4 Xanthus	92-95	FA141*										1
ZR 400 Zephyr (G2/G3/G3A/G4/G5)	97-01	FA158*			FA158HH*							2
ZRX 400 (ZR 400 E1/E2)	94-95	FA129*			FA129HH*	MD4008X	MD4008X	MD4008XC*	MD4008CC*	VR4008BLK*†		3
ZRX 400 E3 (ZR 400 E3)	Left 96	FA229			FA229HH	MD4008X		MD4008XC	MD4008CC	VR4008BLK*†		4
	Right	FA231			FA231HH		MD4008X	MD4008XC	MD4008CC	VR4008BLK*†		5
ZRX 400 (ZX 400 E4/5/6/7)	98-01				FA294HH*	MD4008X	MD4008X	MD4008XC*	MD4008CC*	VR4008BLK*†		6
ZX-4 (ZX 400 G1/G1A/G1B)	88	FA141*				MD4134	MD4134					7
ZXR 400 H1/H2	89-90	FA158*			FA158HH*	MD4008X	MD4008X	MD4008XC*	MD4008CC*	VR4008BLK*†		8
ZXR 400 R (ZXR 400 J1)	89	FA158*			FA158HH*	MD4008X	MD4008X	MD4008XC*	MD4008CC*	VR4008BLK*†		9
ZXR 400 R (ZX 400 J2)	90	FA158*			FA158HH*	MD4008X	MD4008X	MD4008XC*	MD4008CC*	VR4008BLK*†		10
ZXR 400 R (ZX 400 M1-M4)	91-94	FA158*			FA158HH*	MD4005	MD4005					11
ZXR 400 L1-L9	91-03	FA180*			FA180HH*	MD4005	MD4005					12
ZZ-R 400 (ZX 400 K1/K2/K3)	90-92	FA158*			FA158HH*	MD4008X	MD4008X	MD4008XC*	MD4008CC*	VR4008BLK*†		13
ZZ-R 400 (ZX 400 N1-N7)	93-99	FA158*			FA158HH*	MD4008X	MD4008X	MD4008XC*	MD4008CC*	VR4008BLK*†		14
KX 420 A1/A2	80-81	K705			K705G							15
Z 440 A2 LTD	79	FA073				MD4047LS						16
Z 440 C1	80	FA073										17
Z 440 C2	81	FA068			FA068HH	MD4010LS						18
Z 440 D4 LTD	82	FA073				MD4047LS						19
Z 440 D5/D6 LTD	83-84	FA068			FA068HH	MD4010LS						20
Z 440 H1/H2	82-83	FA068			FA068HH	MD4010LS						21
LTD 454 (EN 450 A1-A5)	86-89	FA085			FA085HH	MD4006LS						22
KAF 450 B1 (Mule 1000)		K719*										23
KFX 450 R Quad (KSF 450 B8F/B9F/BAF/BBF /BCS/BFD/BEF)	08-14				FA342R	MD6137D						24
KFX 450 R Quad (KSF 450 B8F/B9F/BAF/BBF /BCS/BFD/BEF) - Plain undrilled disc for enduro use	08-14				FA349R	MD6137D						25
KLX 450 R (A8F/A9F/AAF/ABF/ACF/ADF/AEF/AFF/AGF/AHF/AJF)	08-18	FA185TT		MXS185	FA185R	MD6264D		MD6264C			MD6264CX	26
♦ Plain undrilled disc for enduro use MD6208CE												27
KX 450 F (D6F/D7F/D8F/E9F/EAF/EBF/FCF/FDF/FEF)	06-14	FA185TT		MXS185	FA185R	MD6264D		MD6264C			MD6264CX	28
♦ Plain undrilled disc for enduro use MD6208CE												29
KX 450 F (FFF/HGF/HHF/HJF)	15-18	FA185TT		MXS185	FA185R			MD6388C			MD6388CX	30
♦ Plain undrilled disc for enduro use MD6208CE												31
KX-F 450 (4T) 270mm Front 250mm Rear Rotor	19-22	FA185TT		MXS185	FA185R			MD6388C			MD6388CX	32
KX 450 F Tomac (JKF) (4T) 270mm Front 250mm Rear Rotor	19	FA185TT		MXS185	FA185R			MD6388C			MD6388CX	33
KX-F 450 X Enduro 270mm F/disc & 240mm R/Disc, 18" R/wheel	21-22	FA185TT		MXS185	FA185R			MD6388C			MD6388CX	34
EN 500 A1-A3	90-93	FA085			FA085HH	MD4006LS						35
EN 500 B1-B2/C1-C9	94-04	FA085			FA085HH	MD4124LS						36
ER-5 (ER 500 A1/A2/A3/A4)	97-00	FA129			FA129HH	MD4016						37
ER-5 (ER 500 C1/C3/C4/C5P)	01-07	FA229			FA229HH	MD4016						38
GPZ 500 S (EX 500 A1-A6)	87-93	FA129			FA129HH	MD714X					MD714CX	39
GPZ 500 S (EX 500 B1-B5)	88-93	FA067*			FA067HH*	MD4144	MD4144					40
GPZ 500 S (EX 500 D1-D7)	94-01	FA129			FA129HH	MD714X	MD4016				MD714CX	41
GPZ 500 S (EX 500 E1-E10)	94-04	FA141*				MD4144	MD4144					42
H1 500 Mach III	69-70	FA033										43
H1-A 500 S Mach III	71	FA033										44
H1-B/C 500 Mach III	72	FA033										45
H1-D/E/F 500	73-75	FA055				MD4069LS						46
KH 500 A8	76	FA033				MD4052LS						47
KLE 500 A1-A12	91-04	FA129			FA129R	MD6093D						48
KLE 500 B1P/B6F/B7F	05-07	FA129			FA129HH	MD6093D						49
KX 500 A1/A2	83-84	FA067TT			FA067R							50
KX 500 B1	85	FA067TT			FA067R	MD6036D						51
KX 500 B2	86	FA067TT			FA067R	MD6036D						52
KX 500 C1/D1	87-88	FA130TT			FA130R	MD6036D						53
KX 500 E1-E5	89-93	FA135TT		MXS135	FA135R	MD6015D		MD6015C			MD6015CX	54
KX 500 E6/E7	94-95	FA185TT		MXS185	FA185R	MD6015D		MD6015C			MD6015CX	55
KX 500 E8-E16	96-04	FA185TT		MXS185	FA185R	MD6015D		MD6015C			MD6015CX	56
Z 500 B1-B2	79-80	FA073*				MD4047LS	MD4047RS					57
KAF 540 C1 (Mule 2010)		K719*										58
												59
												60

*-2 Sets Required. † For Vee disc colours add RED, BLU, GRN, GLD, ORG suffix to part number. For Custom Finish Options for Vee-Rotors™ including Splatter discs add suffix CHR, CHGR, CHBL, CHBR - available in various colours see page iv. ☉ - Also available as a Vintage Motorcycle Disc.

JAPANESE Built Motorcycles

Line #	BRAKE DISC CHOICES - FRONT						DISC PAD CHOICES - REAR				BRAKE DISC CHOICES - REAR			
	Oversize 250 /280mm Disc Kit	OSX Oversize 250/280mm Disc Kit	Relocating Bracket for 250/ 280mm Disc	Oversize 320mm Disc Kit	SMX Oversize 320mm Disc Kit	Relocating Bracket for 320mm Disc	FA, SFA, TT Pad or Brake Shoe	SFAC Carbon Scooter Pads	Speciality Pads - SXR / Vee / MXS	Sintered/ HH Pads/ Grooved Shoes	Standard Replacement Disc	Contour Disc Rear fitment	Vee Discs CONTOUR	CX Extreme MX Race Disc
1							FA067/3							
2							FA192		FA192V	FA192HH	MD4009			
3							FA192		FA192V	FA192HH				
4							FA192		FA192V	FA192HH				
5														
6							FA192		FA192V	FA192HH				
7							FA141				MD4009			
8							FA161		FA161V	FA161HH	MD4009	MD4009C	VR4009	
9							FA161		FA161V	FA161HH	MD4009	MD4009C	VR4009	
10							FA161		FA161V	FA161HH	MD4009	MD4009C	VR4009	
11							FA161		FA161V	FA161HH	MD4009			
12							FA161		FA161V	FA161HH	MD4009			
13							FA129		FA129V	FA129HH	MD4007		VR4007	
14							FA192		FA192V	FA192HH	MD4009	MD4009C	VR4009	
15							S605			S605G				
16							K706							
17							K706							
18							K706							
19							K706							
20							K706							
21							K706							
22							K709							
23							K720*							
24														
25											MD6304C			
26														
27							FA084TT			FA084R				
28	OS6264C	OSX6264	BRK023		SMX6264	BRK024	FA367TT		MXS367	FA367R	MD6208D	MD6208C♦		MD6208CX
29														
30	OS6264C	OSX6264	BRK023		SMX6264	BRK024	FA367TT		MXS367	FA367R	MD6208D	MD6208C♦		MD6208CX
31														
32					SMX6264	BRK024	FA367TT		MXS367	FA367R		MD6208C♦		MD6208CX
33														
34		OSX6264	BRK023		SMX6264	BRK024	FA367TT		MXS367	FA367R	MD6421D	MD6421C	TBA	MD6421CX
35							FA367TT		MXS367	FA367R	TBA	MD6024C	TBA	
36					SMX6264	BRK024	FA367TT		MXS367	FA367R		MD6024C		MD6208CX
37							K709							
38							K709							
39							K706							
40							K706							
41							K706							
42							K706							
43							FA067/3				MD4051	MD4051C		
44							FA067				MD4051	MD4051C		
45							K710							
46							K710							
47							K710							
48							K710							
49							K710							
50							FA067/3				MD6082D			
51							FA067/3				MD6082D			
52							S602		S602G					
53							S602		S602G					
54							FA067TT			FA067R	MD6161D			
55							FA067			FA067R	MD6161D			
56							FA152TT		MXS152	FA152R	MD6024D	MD6024C		MD6024CX
57	OS6015C	OSX6015	BRK023		SMX6015	BRK024	FA152TT		MXS152	FA152R	MD6024D	MD6024C		MD6024CX
58	OS6015C	OSX6015	BRK023		SMX6015	BRK024	FA131TT		MXS131	FA131R	MD6024D	MD6024C		MD6024CX
59							FA036							
60							K720*							

REAR / ARRIÈRE / HINTEN / POSTERIOR / POSTERIORE

*-2 Sets Required. † For Vee disc colours add RED, BLU, GRN, GLD, ORG suffix to part number. For Custom Finish Options for Vee-Rotors™ including Splatter discs add suffix CHR, CHGR, CHBL, CHBR - available in various colours see page iv. Ⓢ - Also available as a Vintage Motorcycle Disc.

R Suffix = High Durability Sintered Pad. **HH** Suffix = High Performance Sintered Pad. **TT** Suffix = Hard Wearing Off Road Pad. **V** Suffix = Semi Sintered Pad. **G** Suffix = Grooved Shoe.
D Suffix = Drilled Disc. **X** Suffix = Universal Left or Right Disc. **XC** Suffix = Contoured Disc. **LS** Suffix = Left/Steel Disc. **RS** = Right/Steel Disc.

BRAKE APPLICATIONS

JAPANESE Built Motorcycles



KAWASAKI Contd.



DISC PAD CHOICES - FRONT

BRAKE DISC CHOICES - FRONT

R Suffix = High Durability Sintered Pad. **HH** Suffix = High Performance Sintered Pad. **TT** Suffix = Hard Wearing Off Road Pad. **V** Suffix = Semi Sintered Pad. **G** Suffix = Grooved Shoe.

D Suffix = Drilled Disc. **X** Suffix = Universal Left or Right Disc. **XC** Suffix = Contoured Disc. **LS** Suffix = Left/Steel Disc. **RS** = Right/Steel Disc.

FRONT / AVANT / VORN / FRENTE / ANTERIORE

Model	Year	DISC PAD CHOICES - FRONT			BRAKE DISC CHOICES - FRONT						Line #
		FA, SFA, TT Pad or Brake Shoe	SFAC Carbon Scooter Pads	Speciality Pads - SXR / Vee / MXS	Sintered/HH Pads/ Grooved Shoes	Left / Gauche / Links Standard Replacement Disc	Right / Droite / Rechts Standard Replacement Disc	Contour Disc Universal left and right fitment	Custom Disc Universal left and right fitment	Vee-Disks Black † See note below	
KAF 540 D1 (Mule 2020)		K719*									1
KAF 540 E1 (Mule 2030)		K719*									2
GPZ 550 D1	82	FA068*			FA068HH*	MD4010LS	MD4010RS				3
GPZ 550 H1/H2	82-83	FA068*			FA068HH*	MD4099	MD4099				4
GPZ 550 A1-A4 (ZX 550 A1-A4)	84-87	FA085*			FA085HH*	MD4002LS	MD4002RS				5
GT 550 G1-G9	83-01	FA067*			FA067HH*	MD4006LS	MD4006RS				6
Z 550 A1	80	FA073*				MD4047LS	MD4047RS				7
Z 550 A2/A3	81-82	FA068*			FA068HH*	MD4010LS	MD4010RS				8
Z 550 C1/C2 LTD	82-84	FA068*			FA068HH*	MD4010LS	MD4010RS				9
ZR 550 A1/A2 (Z 550 F)	83-84	FA067*			FA067HH*	MD4108LS	MD4108RS				10
ZR 550 B2/B3 Zephyr	91-93	FA129*			FA129HH*	MD4008X	MD4008X	MD4008XC*	MD4008CC*	VR4008BLK*†	11
ZR 550 B4-B6 Zephyr	94-99	FA129*			FA129HH*	MD4008X	MD4008X	MD4008XC*	MD4008CC*	VR4008BLK*†	12
GPX 600 R (ZX 600 C1-C7)	88-96	FA129*			FA129HH*	MD4026LS	MD4026RS				13
GPZ 600 R A1-A5A	85-89	FA085*			FA085HH*	MD4028	MD4028				14
KLR 600 A1/B2/B1-B4/B6-B9	84-94	FA067			FA067R	MD6080D					15
ZL 600 B1 Eliminator	95-97	FA129	FA129V	FA129V	FA129HH*		MD4008X	MD4008XC	MD4008CC	VR4008BLK*†	16
ZZR 600 (ZX 600 D1-D3)	90-93	FA158*			FA158HH*	MD4141X	MD4141X	MD4141XC*	MD4141CC*		17
ZZR 600 (ZX 600 E1-E13)	93-05	FA158*			FA158HH*	MD4153X	MD4153X	MD4153XC*	MD4153CC*	VR4153BLK*†	18
ZZR 600 (ZX 600 E6F)	06-07	FA158*			FA158HH*	MD4153X	MD4153X	MD4153XC*	MD4153CC*	VR4153BLK*†	19
ZX-6R (ZX 600 F1-F3)	95-97	FA158*			FA158HH*	MD4008X	MD4008X	MD4008XC*	MD4008CC*	VR4008BLK*†	20
ZX-6R (ZX 600 G1/G2/J1/J2)	98-01	FA188*			FA188HH*	MD4136X	MD4136X	MD4136XC*	MD4136CC*	VR4136BLK*†	21
ZX-6R (ZX 600 P7F/P8F)	07-08				FA417/4HH*			MD4152XC*	MD4152CC*	VR4152BLK*†	22
ZX-6R (ZX 600 R9F/RAF/RBF/RBF/RDF/REF/RF/ /RGF 599cc)	09-16				FA417/4HH*			MD4152XC*	MD4152CC*	VR4152BLK*†	24
ZX-6R (ZX 636 A1P 636cc)	02	FA188*			FA188HH*	MD4136X	MD4136X	MD4136XC*	MD4136CC*	VR4136BLK*†	25
ZX-6R (ZX 636 B1/B2)	03-04				FA369/4HH*	MD4151X	MD4151X	MD4151XC*			26
ZX-6R (ZX 636 C1/C6F)	05-06				FA369/4HH*			MD4152XC*	MD4152CC*	VR4152BLK*†	27
Ninja ZX-6R (Non ABS - 636cc)	13-20				FA296HH*			MD4155XC*		VR4155BLK*†	28
Ninja ZX-6R KRT (Non ABS- 636cc)	16-20				FA296HH*			MD4155XC*		VR4155BLK*†	29
ZX-6R 30th Anniversary Edition											30
(ZX 636 E6FA - Non ABS - 636cc)	15				FA296HH*			MD4155XC*		VR4155BLK*†	31
Ninja ZX-6R ABS (636cc)	13-20				FA296HH*			MD4155XC*		VR4155BLK*†	32
Ninja ZX-6R KRT ABS (636cc)	16-20				FA296HH*			MD4155XC*		VR4155BLK*†	33
ZX-6R 30 th Anniversary Edition											34
(ZX 636 F6FA - ABS - 636cc)	15				FA296HH*			MD4155XC*		VR4155BLK*†	35
ZX-6RR (ZX 600 K1/M1)	03-04				FA369/4HH*	MD4151X	MD4151X	MD4151XC*			36
ZX-6RR (ZX 600 N1/N6F)	05-06				FA369/4HH*			MD4152XC*	MD4152CC*	VR4155BLK*†	37
KAF 620 A1/A2/A3/A6 (Mule 2510)		K719*									38
KAF 620 B1/B2/B6 (Mule 2520)		K719*									39
KAF 620 C1/C2/C3/C6 (Mule 2500)		K719*									40
KAF 620 E1/E2/E3/E4/E5 Mule 3010		K719*									41
KAF 620 F1/F2 Mule 3020		K719*									42
KAF 620 G1/G2/G3/G4/G5 Mule 3000		K719*									43
KAF 620 H1/H2/H3 (Mule 3010 4 x 4)		K719*									44
KAF 620 J1/K1/K6F/K7F (Mule 3010 Trans 4 x 4)	05-07	K719*									45
KAF 620 M9F/MAF/MBF/MCF/MDF/MEF/MFF/MGF/MHF (Mule 4010 4 x 4)	09-17	K719*									46
KAF 620 N9F (Mule 4010 4 x 4 Hardwoods Green)	09	K719*									47
KAF 620 P9F/PAF/PBF/PCF/PDF/PEF/PFF/PGF/PHF (Mule 4000)	09-17	K719*									48
KAF 620 R9F/RAF/RBF/RCF/RDF/REF/RFF/RFFA/RGF/RHF (Mule 4010 Trans 4 x 4)	09-17	K719*									49
KAF 620 S9F/SAF/SBF/SCF/SDF/SEF/SFF/SGF/SHF (Mule 4010 Trans 4 x 4 Hardwoods Green HD)	09-17	K719*									50
KAF 620 TGF/TGF (Mule 4010 4 x 4 SE)	16-17	K719*									51
KAF 620 VGF/VHF (Mule 4010 Trans 4 x 4 SE)	16-17	K719*									52
EN 650 Vulcan S	15-20				FA281HH						53
EN 650 Vulcan S ABS	15-21				FA281HH						54
EN 650 Vulcan S Café ABS	18-20				FA281HH						55
EN 650 Vulcan SE ABS	18-20				FA281HH						56

*-2 Sets Required. † For Vee disc colours add RED, BLU, GRN, GLD, ORG suffix to part number. For Custom Finish Options for Vee-Rotors™ including Splatter discs add suffix CHR, CHGR, CHBL, CHBR - available in various colours see page iv. ☼ - Also available as a Vintage Motorcycle Disc.

JAPANESE Built Motorcycles

Line #	BRAKE DISC CHOICES - FRONT						DISC PAD CHOICES - REAR				BRAKE DISC CHOICES - REAR			
	OverSize 250 /280mm Disc Kit	OSX OverSize 250/280mm Disc Kit	Relocating Bracket for 250/ 280mm Disc	OverSize 320mm Disc Kit	SMX OverSize 320mm Disc Kit	Relocating Bracket for 320mm Disc	FA, SFA, TT Pad or Brake Shoe	SFAC Carbon Scooter Pads	Speciality Pads - SXR / Vee / MXS	Sintered/ HH Pads/ Grooved Shoes	Standard Replacement Disc	Contour Disc Rear fitment	Vee Discs CONTOUR	CX Extreme MX Race Disc
1							K720*							
2							K720*							
3							FA068		FA068V	FA068HH	MD4169			
4							FA068		FA068V	FA068HH	MD4024			
5							FA085		FA085V	FA085HH	MD4001			
6							K709							
7							K709							
8							K709							
9							K709							
10							K706							
11							FA141				MD4009	MD4009C	VR4009	
12							FA192		FA192V	FA192HH	MD4009	MD4009C	VR4009	
13							FA129		FA129V	FA129HH	MD4027			
14							FA085		FA085V	FA085HH	MD4015			
15							S602			S602G				
16							K709							
17							FA129		FA129V	FA129HH	MD4007	MD4007C		
18							FA192		FA192V	FA192HH	MD4009	MD4009C	VR4009	
19							FA192		FA192V	FA192HH	MD4009	MD4009C	VR4009	
20							FA192		FA192V	FA192HH	MD4023	MD4023C	VR4023	
21							FA192		FA192V	FA192HH	MD4138	MD4138C	VR4138	
22							FA192		FA192V	FA192HH		MD4138C	VR4138	
23														
24							FA192		FA192V	FA192HH		MD4138C	VR4138	
25							FA192		FA192V	FA192HH	MD4138	MD4138C	VR4138	
26							FA192		FA192V	FA192HH	MD4138	MD4138C		
27							FA192		FA192V	FA192HH	MD4138	MD4138C	VR4138	
28							FA436			FA436HH		MD4165C	VR4165	
29							FA436			FA436HH		MD4165C	VR4165	
30														
31							FA436			FA436HH		MD4165C	VR4165	
32							FA436			FA436HH		MD4165C	VR4165	
33							FA436			FA436HH		MD4165C	VR4165	
34														
35							FA436			FA436HH		MD4165C	VR4165	
36							FA192		FA192V	FA192HH	MD4138	MD4138C		
37							FA192		FA192V	FA192HH		MD4138C	VR4138	
38							K720*							
39							K720*							
40							K720*							
41							K720*							
42							K720*							
43							K720*							
44							K720*							
45							K720*							
46														
47							K720*							
48							K720*							
49														
50							K720*							
51														
52							K720*							
53														
54							K720*							
55							K720*							
56							K720*							
57							FA174			FA174HH	MD4165	MD4165C		
58							FA174			FA174HH	MD4165	MD4165C		
59							FA174			FA174HH	MD4165	MD4165C		
60							FA174			FA174HH	MD4165	MD4165C		

REAR / ARRIÈRE / HINTEN / POSTERIOR / POSTERIORE

R Suffix = High Durability Sintered Pad. **HH** Suffix = High Performance Sintered Pad. **TT** Suffix = Hard Wearing Off Road Pad. **V** Suffix = Semi Sintered Pad. **G** Suffix = Grooved Shoe.
D Suffix = Drilled Disc. **X** Suffix = Universal Left or Right Disc. **XC** Suffix = Contoured Disc. **LS** Suffix = Left/Steel Disc. **RS** = Right/Steel Disc.

*-2 Sets Required. † For Vee disc colours add RED, BLU, GRN, GLD, ORG suffix to part number. For Custom Finish Options for Vee-Rotors™ including Splatter discs add suffix CHR, CHGR, CHBL, CHBR - available in various colours see page iv. Ⓢ - Also available as a Vintage Motorcycle Disc.

Part numbers, prefixes, suffixes, photos and illustrations shown in this catalogue are trademarks and/or copyrights of EBC Brakes or the trademark owner A C Freeman Investments Ltd and use without express written permission of the owners is punishable by law. 111

BRAKE APPLICATIONS

JAPANESE Built Motorcycles



KAWASAKI Contd.



DISC PAD CHOICES - FRONT

BRAKE DISC CHOICES - FRONT

Line #

Model	Side	Year	FA, SFA, TT Pad or Brake Shoe	SFAC Carbon Scooter Pads	Speciality Pads - SXR / Vee / MXS	Sintered/HH Pads/ Grooved Shoes	Left / Gauche / Links Standard Replacement Disc	Right / Droite / Rechts Standard Replacement Disc	Contour Disc Universal left and right fitment	Custom Disc Universal left and right fitment	Vee-Discs Black † See note below	CX Extreme MX Race Disc/ UTVX Disc
ER-6f Non ABS Model	Left	06-11	FA229			FA229HH			MD4159XC		VR4159BLK†	
(EX 650 A6F/A7F/A8F/C9F/CAF/CBF)	Right		FA231			FA231HH			MD4159XC		VR4159BLK†	
ER-6f (ABS Model)	Left	06-11	FA229			FA229HH			MD4156AXC			
(EX 650 B6F/B7F/B8F/D9F/DAF/DBF)	Right		FA231			FA231HH			MD4156XC			
ER-6f ECF/EDS/EEF/FFF/EGF	Left	12-16	FA229			FA229HH			MD4159XC		VR4159BLK†	
(Non ABS Model)	Right		FA231			FA231HH			MD4159XC		VR4159BLK†	
ER-6f FCF/FDS/FEF/FFF/FGF	Left	12-16	FA229			FA229HH			MD4156AXC			
(ABS Model)	Right		FA231			FA231HH			MD4156XC			
ER-6n (Non ABS Model)	Left	06-11	FA229			FA229HH			MD4159XC		VR4159BLK†	
/ER 650 A6F/A7F/A8F/C9F/CAF/CBF)	Right		FA231			FA231HH			MD4159XC		VR4159BLK†	
ER-6n (ABS Model)	Left	06-11	FA229			FA229HH			MD4156AXC			
(ER 650 B6F/B7F/B8F/D9F/DAF/DBF)	Right		FA231			FA231HH			MD4159XC			
ER-6n ECF/EDS/EEF/FFF/EGF	Left	12-16	FA229			FA229HH			MD4159XC		VR4159BLK†	
(Non ABS Model)	Right		FA231			FA231HH			MD4159XC		VR4159BLK†	
ER-6n FCF/FDS/FEF/FFF/FGF	Left	12-16	FA229			FA229HH			MD4156AXC			
(ABS Model)	Right		FA231			FA231HH			MD4156XC			
KLR 650 A1-A3		87-89	FA130TT		FA130V	FA130R	MD6042D					MD6042CX
KL 650 B1-B3 Tengai		89-92	FA129			FA129R	MD6081D					
KLE 650 A7F/A8F/A9F/CAF Versys	Left	07-10	FA229			FA229HH			MD4159XC		VR4159BLK†	
	Right		FA231			FA231HH			MD4159XC		VR4159BLK†	
KLE 650 B7F/B8F/B9F/DAF	Left	07-10	FA229			FA229HH			MD4156AXC			
Versys ABS	Right		FA231			FA231HH			MD4156XC			
KLE 650 CBF/CCF/CDF/CEF	Left	11-14	FA229			FA229HH			MD4159XC		VR4159BLK†	
Versys/Non ABS	Right		FA231			FA231HH			MD4159XC		VR4159BLK†	
KLE 650 Versys (KLE 650 EFF/Non ABS)		15	FA142			FA142HH*			MD4156XC*			
KLE 650 DBF/DCF/DDF/DEF	Left	11-14	FA229			FA229HH			MD4156AXC			
Versys/ABS	Right		FA231			FA231HH			MD4156XC			
KLE 650 Versys (KLE 650 FFF/ABS)	Left	15	FA142			FA142HH			MD4156AXC			
	Right		FA142			FA142HH			MD4156XC			
KLE 650 Versys (Non ABS) KLE 650 EGF		16	FA142*			FA142HH*						
KLE 650 Versys (ABS)	Left	16-21	FA142			FA142HH			MD4156AXC			
	Right		FA142			FA142HH			MD4156XC			
KLR 650 C1-C10		95-04	FA229			FA229HH	MD6081D					
KLR 650 (KL 650 E8F/E9F)		08-09	FA228			FA228HH			MD6309C			
KLR 650 300mm O/D F/Disc, 240mm O/D R/Disc		21	FA228			FA228HH						
KLX 650 C1/C2/C3		93-97	FA185TT		MXS185	FA185R	MD6086D					
KVF 650 A1/A2 Prairie	Left	02-03				FA342R	MD6188D					
	Right					FA349R		MD6188D				
KVF 650 D1/D6F/D7F/D8F/D9F	Left	05-11				FA342R	MD6188D					
/DAF/DBF Brute Force 4 x 4	Right					FA349R		MD6188D				
KVF 650 E1/E6F/E7F/E8F/E9F Brute	Left	05-09				FA342R	MD6188D					
Force 4 x 4 Hardwoods Green HD	Right					FA349R		MD6188D				
KVF 650 E8FA Brute Force	Left	08	FA165TT		MXS165	FA165R	MD6188D					
4 x 4 Hardwoods Green HD	Right		FA135TT		MXS135	FA135R		MD6188D				
KVF 650 F7F/F8F Brute Force	Left	07-08	FA165TT		MXS165	FA165R	MD6188D					
4 x 4i Hardwoods Green	Right		FA135TT		MXS135	FA135R		MD6188D				
KVF 650 H7F/H8F Brute Force	Left	07-08	FA165TT		MXS165	FA165R	MD6188D					
4 x 4i Hardwoods Green	Right		FA135TT		MXS135	FA135R		MD6188D				
KVF 650 FCF/FCS/FDF/FEF	Left	12-14	FA165TT		MXS165	FA165R	MD6188D					
	Right		FA135TT		MXS135	FA135R		MD6188D				
KVF 650 G7F/G8F Brute Force	Left	07-08	FA165TT		MXS165	FA165R	MD6188D					
4 x 4i Hardwoods Green	Right		FA135TT		MXS135	FA135R		MD6188D				
KVF 650 G7F/G8F Brute Force	Left	12-13	FA165TT		MXS165	FA165R	MD6188D					
4 x 4i Hardwoods Green	Right		FA135TT		MXS135	FA135R		MD6188D				
Ninja 650 K (EX 650)		17-20	FA226*			FA226HH*			MD4156XC*			
Ninja 650 J ABS (EX 650)	Left	17-21	FA226			FA226HH			MD4156AXC			
	Right	17-20	FA226			FA226HH			MD4156XC			
Ninja 650 KRT (EX 650 KRT)	Left	18-20	FA226			FA226HH			MD4156AXC			
	Right	18-20	FA226			FA226HH			MD4156XC			
W 650 (EJ 650 A1/C3/C4/C5/C6/C7)		99-05	FA231			FA231HH		MD4008X	MD4008XC	MD4008CC	VR4008BLK†	

FRONT / AVANT / VORN / FRENTE / ANTERIORE

R Suffix = High Durability Sintered Pad. HH Suffix = High Performance Sintered Pad. TT Suffix = Hard Wearing Off Road Pad. V Suffix = Semi Sintered Pad. G Suffix = Grooved Shoe. D Suffix = Drilled Disc. X Suffix = Universal Left or Right Disc. XC Suffix = Contoured Disc. LS Suffix = Left/Steel Disc. RS = Right/Steel Disc.

*-2 Sets Required. † For Vee disc colours add RED, BLU, GRN, GLD, ORG suffix to part number. For Custom Finish Options for Vee-Rotors™ including Splatter discs add suffix CHR, CHGR, CHBL, CHBR - available in various colours see page iv. ☼ - Also available as a Vintage Motorcycle Disc.

JAPANESE Built Motorcycles

Line #	BRAKE DISC CHOICES - FRONT						DISC PAD CHOICES - REAR				BRAKE DISC CHOICES - REAR			
	Oversize 250 /280mm Disc Kit	OSX Oversize 250/280mm Disc Kit	Relocating Bracket for 250/ 280mm Disc	Oversize 320mm Disc Kit	SMX Oversize 320mm Disc Kit	Relocating Bracket for 320mm Disc	FA, SFA, TT Pad or Brake Shoe	SFAC Carbon Scooter Pads	Speciality Pads - SXR / Vee / MXS	Sintered/ HH Pads/ Grooved Shoes	Standard Replacement Disc	Contour Disc Rear fitment	Vee Discs CONTOUR	CX Extreme MX Race Disc
1							FA192		FA192V	FA192HH		MD4138C	VR4138	
2														
3							FA192		FA192V	FA192HH		MD4164AC		
4														
5												MD4138C	VR4138	
6							FA192			FA192HH				
7												MD4164AC		
8							FA192			FA192HH				
9							FA192		FA192V	FA192HH		MD4138C	VR4138	
10														
11							FA192		FA192V	FA192HH		MD4164AC		
12														
13												MD4138C	VR4138	
14							FA192			FA192HH				
15												MD4164AC		
16							FA192			FA192HH				
17							FA067/3				MD6082D			MD6082CX
18							FA067			FA067R	MD6082D			
19							FA192			FA192HH		MD4138C	VR4138	
20														
21							FA192			FA192HH		MD4164AC		
22														
23							FA192			FA192HH		MD4138C	VR4138	
24														
25							FA140			FA140HH				
26							FA192			FA192HH		MD4164AC		
27														
28														
29							FA140			FA140HH				
30							FA174			FA174HH				
31							FA174			FA174HH		MD4178AC		
32														
33							FA067			FA067R	MD6082D			
34						SM6309C	FA197			FA197HH		MD6310C		
35							FA197			FA197HH				
36							FA152TT		MXS152	FA152R	MD6085D			
37														
38														
39														
40														
41														
42														
43														
44														
45														
46														
47														
48														
49														
50														
51														
52														
53														
54														
55							FA174		FA174V	FA174HH	MD4138C			
56							FA174			FA174HH	MD4164AC			
57							FA174			FA174HH	MD4164AC			
58							FA174		FA174V	FA174HH	MD4164AC			
59							FA174		FA174V	FA174HH	MD4164AC			
60							K706							

REAR / ARRIÈRE / HINTEN / POSTERIOR / POSTERIORE

R Suffix = High Durability Sintered Pad. **HH** Suffix = High Performance Sintered Pad. **TT** Suffix = Hard Wearing Off Road Pad. **V** Suffix = Semi Sintered Pad. **G** Suffix = Grooved Shoe.
D Suffix = Drilled Disc. **X** Suffix = Universal Left or Right Disc. **XC** Suffix = Contoured Disc. **LS** Suffix = Left/Steel Disc. **RS** = Right/Steel Disc.

*-2 Sets Required. † For Vee disc colours add RED, BLU, GRN, GLD, ORG suffix to part number. For Custom Finish Options for Vee-Rotors™ including Splatter discs add suffix CHR, CHGR, CHBL, CHBR - available in various colours see page iv. ☉ - Also available as a Vintage Motorcycle Disc.

BRAKE APPLICATIONS

JAPANESE Built Motorcycles



KAWASAKI Contd.



DISC PAD CHOICES - FRONT

BRAKE DISC CHOICES - FRONT

FA, SFA, TT Pad or Brake Shoe	SFAC Carbon Scooter Pads	Speciality Pads - SXR / Vee / MXS	Sintered/HH Pads/ Grooved Shoes	Left / Gauche / Links Standard Replacement Disc	Right / Droite / Rechts Standard Replacement Disc	Contour Disc Universal left and right fitment	Custom Disc Universal left and right fitment	Vee-Discs Black † See note below	CX Extreme MX Race Disc/ UTVX Disc
Z 650 B1/B2/B3				MD4052LS					
Z 650 C1/C2				MD4059LS	MD4059RS				
Z 650 C3				MD4059LS	MD4059RS				
Z 650 D2/D3 (SR)				MD4059LS	MD4059RS		VMD4059		
Z 650 F1				MD4052LS	MD4052RS				
Z 650 F2/F3/F4				MD4010LS	MD4010RS				
Z 650 (ER 650)						MD4156XC*			
Z 650 (ER 650 ABS)						MD4156XC*			
KSV 700 A1/A2/A6F/A7F/A8F	Left		FA342R	MD6137D					
/A9F/ABF (KFX 700) V-Force	Right		FA349R		MD6137D				
KVF 700 B1/B6F/A7F/A8F 4 x 4	Left		FA342R	MD6188D					
(Prairie) (KVF 700 A1/A2/A6F/B2)	Right		FA349R		MD6188D				
KVF 700 D1 Team Green	Left		FA342R	MD6188D					
	Right		FA349R		MD6188D				
ST 700 Stallion			FA380HH*	MD4155X	MD4155X	MD4155XC*			
Z 700 A1 LTD		FA068*	FA068HH*	MD4010LS	MD4010RS				
VN 700 A1 Vulcan		FA085*	FA085HH*	MD4010LS	MD4010RS				
ZN 700 A1/A2 LTD		FA085*	FA085HH*	MD4067LS	MD4067RS				
GPX 750 R (ZX 750 F1-F3)		FA129*	FA129HH*	MD4071LS	MD4071RS				
GT 750 P1-P9		FA068*	FA068HH*	MD4010LS	MD4010RS				
GPZ 750 R1		FA068*	FA068HH*	MD4010LS	MD4010RS				
GPZ 750 A1-A5		FA085*	FA085HH*	MD4028	MD4028				
GPZ 750 E1/E2 Turbo		FA085*	FA085HH*	MD4016	MD4016				
GPZ 750 R G2/G3		FA085*	FA085HH*	MD4016	MD4016				
H2/H2-A (750cc) Mach IV		FA055		MD4069LS					
H2-B/H2-C (750cc) Mach IV		FA055		MD4069LS					
KRF 750 A8F/B8F	Left	FA165TT	MXS165	FA165R	MD6325D				
Teryx 750 4 x 4 (RUV)	Right	FA135TT	MXS135	FA135R	MD6325D				
KRF 750 C8F/D8F	Left	FA165TT	MXS165	FA165R	MD6325D				
Teryx 750 4 x 4 LE (RUV)	Right	FA135TT	MXS135	FA135R	MD6325D				
KRF 750 F8F Teryx 750	Left	FA165TT	MXS165	FA165R	MD6325D				
4 x 4 NRA Outdoors (RUV)	Right	FA135TT	MXS135	FA135R	MD6325D				
KRF 750 G9F/NAF/NBF/NCS/NDF	Left	FA165TT	MXS165	FA165R	MD6325D				
Teryx 750 Fi 4 x 4	Right	FA135TT	MXS135	FA135R	MD6325D				
KRF 750 J9FA/K9F/PAF/RAF/PBF/RBF	Left	FA165TT	MXS165	FA165R	MD6325D				
/RCS/PDF/RDF Teryx 750 Fi 4 x 4 LE	Right	FA135TT	MXS135	FA135R	MD6325D				
KRF 750 L9F Teryx 750 Fi	Left	FA165TT	MXS165	FA165R	MD6325D				
4 x 4 LE Sport	Right	FA135TT	MXS135	FA135R	MD6325D				
KRF 750 M9F Teryx 750 Fi	Left	FA165TT	MXS165	FA165R	MD6325D				
4 x 4 NRA Outdoors	Right	FA135TT	MXS135	FA135R	MD6325D				
KRF 750 SAF/SAFA/SBF/SBFASCS/SCSA	Left	FA165TT	MXS165	FA165R	MD6325D				
/SDF Teryx 750 Fi 4 x 4 Sport LE	Right	FA135TT	MXS135	FA135R	MD6325D				
KRF 750 TAF/VBF	Left	FA165TT	MXS165	FA165R	MD6325D				
Teryx 750 Fi 4 x 4 SGE	Right	FA135TT	MXS135	FA135R	MD6325D				
KRT 750 ACF/ADF (Teryx 4 750 4 x 4)	Left	FA165TT		FA165R	MD6399D				UTVX6399
	Right	FA135TT		FA135R	MD6399D				UTVX6399
KRT 750 ACFA/ADFA	Left	FA165TT		FA165R	MD6399D				UTVX6399
(Teryx 4 750 4 x 4 EPS)	Right	FA135TT		FA135R	MD6399D				UTVX6399
KRT 750 CCF/CDF	Left	FA165TT		FA165R	MD6399D				UTVX6399
(Teryx 4 750 4 x 4 EPS LE)	Right	FA135TT		FA135R	MD6399D				UTVX6399
KVF 750 D8F/D9F/DBF	Left	FA165TT	MXS165	FA165R	MD6188D				
	Right	FA135TT	MXS135	FA135R	MD6188D				
KVF 750 GCF/GDF/GEF/GFF/GGF/GHF	Left	FA165TT	MXS165	FA165R	MD6188D				
Brute Force 4 x 4i EPS	Right	FA135TT	MXS135	FA135R	MD6188D				
KVF 750 HCF/HDF/HEF/HFF/HGF/HHF	Left	FA165TT	MXS165	FA165R	MD6188D				
Brute Force 4 x 4i EPS/Cam0	Right	FA135TT	MXS135	FA135R	MD6188D				
KVF 750 JCF/JDF/JEF/JFF/JGF	Left	FA165TT	MXS165	FA165R	MD6188D				
/JHF Brute Force 4 x 4i EPS	Right	FA135TT	MXS135	FA135R	MD6188D				
KVF 750 LCF/LDF/LEF/LFF/LGF/LHF	Left	FA165TT	MXS165	FA165R	MD6188D				
Brute Force 4 x 4i	Right	FA135TT	MXS135	FA135R	MD6188D				

FRONT / AVANT / VORN / FRENTE / ANTERIORE

Line #

R Suffix = High Durability Sintered Pad. HH Suffix = High Performance Sintered Pad. TT Suffix = Hard Wearing Off Road Pad. V Suffix = Semi Sintered Pad. G Suffix = Grooved Shoe. D Suffix = Drilled Disc. X Suffix = Universal Left or Right Disc. XC Suffix = Contoured Disc. LS Suffix = Left/Steel Disc. RS = Right/Steel Disc.

*-2 Sets Required. † For Vee disc colours add RED, BLU, GRN, GLD, ORG suffix to part number. For Custom Finish Options for Vee-Rotors™ including Splatter discs add suffix CHR, CHGR, CHBL, CHBR - available in various colours see page iv. Ⓢ - Also available as a Vintage Motorcycle Disc.

JAPANESE Built Motorcycles

Line #	BRAKE DISC CHOICES - FRONT						DISC PAD CHOICES - REAR				BRAKE DISC CHOICES - REAR			
	OverSize 250 /280mm Disc Kit	OSX OverSize 250/280mm Disc Kit	Relocating Bracket for 250/ 280mm Disc	OverSize 320mm Disc Kit	SMX OverSize 320mm Disc Kit	Relocating Bracket for 320mm Disc	FA, SFA, TT Pad or Brake Shoe	SFAC Carbon Scooter Pads	Speciality Pads - SXR / Vee / MXS	Sintered/ HH Pads/ Grooved Shoes	Standard Replacement Disc	Contour Disc Rear fitment	Vee Discs CONTOUR	CX Extreme MX Race Disc
1							K709							
2							FA037				MD4062			
3							FA036		FA036V					
4							FA036		FA036V		MD4063 ⚙			
5							K709							
6							K709							
7							FA174		FA174V	FA174HH	MD4138C			
8							FA174		FA174V	FA174HH	MD4164AC			
9														
10														
11														
12														
13														
14														
15							FA196		FA196V	FA196HH	MD4169			
16							FA068		FA068V	FA068HH	MD4169			
17							K709							
18							FA085		FA085V	FA085HH	MD4068			
19							FA129		FA129V	FA129HH	MD4007			
20							FA068		FA068V	FA068HH	MD4169			
21							FA068		FA068V	FA068HH	MD4169			
22							FA085		FA085V	FA085HH	MD4019			
23							FA085		FA085V	FA085HH	MD4017			
24							FA085		FA085V	FA085HH	MD4017			
25							K713							
26							K713							
27														
28														
29														
30														
31														
32														
33														
34														
35														
36														
37														
38														
39														
40														
41														
42														
43														
44														
45														
46														
47														
48														
49														
50														
51														
52														
53														
54														
55														
56														
57														
58														
59														
60														

REAR / ARRIÈRE / HINTEN / POSTERIOR / POSTERIORE

*-2 Sets Required. † For Vee disc colours add RED, BLU, GRN, GLD, ORG suffix to part number. For Custom Finish Options for Vee-Rotors™ including Splatter discs add suffix CHR, CHGR, CHBL, CHBR - available in various colours see page iv. ⚙ - Also available as a Vintage Motorcycle Disc.

Part numbers, prefixes, suffixes, photos and illustrations shown in this catalogue are trademarks and/or copyrights of EBC Brakes or the trademark owner A C Freeman Investments Ltd and use without express written permission of the owners is punishable by law.

R Suffix = High Durability Sintered Pad. **HH** Suffix = High Performance Sintered Pad. **TT** Suffix = Hard Wearing Off Road Pad. **V** Suffix = Semi Sintered Pad. **G** Suffix = Grooved Shoe.
D Suffix = Drilled Disc. **X** Suffix = Universal Left or Right Disc. **XC** Suffix = Contoured Disc. **LS** Suffix = Left/Steel Disc. **RS** = Right/Steel Disc.

JAPANESE Built Motorcycles



KAWASAKI Contd.



DISC PAD CHOICES - FRONT

BRAKE DISC CHOICES - FRONT

FA, SFA, TT Pad or Brake Shoe	SFAC Carbon Scooter Pads	Speciality Pads - SXR / Vee / MXS	Sintered/HH Pads/ Grooved Shoes	Left / Gauche / Links Standard Replacement Disc	Right / Droite / Rechts Standard Replacement Disc	Contour Disc Universal left and right fitment	Custom Disc Universal left and right fitment	Vee-Discs Black † See note below	CX Extreme MX Race Disc/ UTVX Disc
VN 750 A2-A5/A10	86-94	FA085*	FA085V*	FA085HH*	MD4010LS	MD4010RS			
Z 750 E1	80	FA068*	FA068V*	FA068HH*	MD4010LS	MD4010RS			
Z 750 H1/H2 LTD	80-81	FA068*	FA068V*	FA068HH*	MD4010LS	MD4010RS			
Z 750 L1-L4	81-84	FA068*	FA068V*	FA068HH*	MD4010LS	MD4010RS			
Z 750 Y1 LTD	82	FA068*	FA068V*	FA068HH*	MD4043LS	MD4043RS			
Z 750 B1/B2	77-78	FA033							
Z 750 D1	76	FA033							
Z 750 N1/N2 Spectre	82-83	FA068*	FA068V*	FA068HH*	MD4010LS	MD4010RS			
Z 750 S (ZR 750 K1/K6F)	Left 05-07	FA229	FA229V	FA229HH	MD4141X		MD4141XC	MD4141CC	
	Right	FA231	FA231V	FA231HH		MD4141X	MD4141XC	MD4141CC	
Z 750 (ZR 750 J1/J2/J6F)	Left 04-06	FA229	FA229V	FA229HH	MD4141X		MD4141XC	MD4141CC	
	Right	FA231	FA231V	FA231HH		MD4141X	MD4141XC	MD4141CC	
Z 750 (ZR 750 L7F/L8F/L9F/LAF)	07-11	FA142*	FA142V*	FA142HH*			MD4159XC*		VR4159BLK*†
Z 750 ABS (ZR 750 M7F/M8F/M9F/MAF/MBF)	07-11	FA142*	FA142V*	FA142HH*			MD4156XC*		
Z 750 R Non ABS (ZR 750 NBF/NCF)	11-12			FA417/4HH*			MD4152XC*	MD4152CC*	VR4152BLK*†
Z 750 R Black Edition (ZR 750 NBFA)	12			FA417/4HH*			MD4152XC*	MD4152CC*	VR4152BLK*†
Z 750 R ABS (ZR 750 PBF/PCF)	11-12			FA417/4HH*			MD4152XC*	MD4152CC*	VR4152BLK*†
ZR 750 C1-C5 Zephyr	91-95	FA129*	FA129V*	FA129HH*	MD4008X	MD4008X	MD4008XC*	MD4008CC*	VR4008BLK*†
ZR 750 D1 Zephyr	96-98	FA229	FA229V	FA229HH	MD4008X		MD4008XC	MD4008CC	VR4008BLK†
	Left	FA231	FA231V	FA231HH		MD4008X	MD4008XC	MD4008CC	VR4008BLK†
	Right	FA231	FA231V	FA231HH	MD4141X		MD4141XC	MD4141CC	
ZR-7 (ZR 750 F1/F3/F5)	99-04	FA229	FA229V	FA229HH	MD4141X		MD4141XC	MD4141CC	
	Left	FA231	FA231V	FA231HH		MD4141X	MD4141XC	MD4141CC	
	Right	FA231	FA231V	FA231HH	MD4141X		MD4141XC	MD4141CC	
ZR-7S (ZR 750 H1/H3)	01-04	FA229	FA229V	FA229HH	MD4141X		MD4141XC	MD4141CC	
	Left	FA231	FA231V	FA231HH		MD4141X	MD4141XC	MD4141CC	
	Right	FA231	FA231V	FA231HH	MD4012X	MD4012X	MD4012XC*	MD4012CC*	VR4012BLK*†
ZXR 750 H1/H2	89-90	FA158*		FA158HH*	MD4022X	MD4022X	MD4022XC*	MD4022CC*	VR4022BLK*†
ZXR 750 K1/K2/J1/J2	91-92	FA158*		FA158HH*	MD4022X	MD4022X	MD4022XC*	MD4022CC*	VR4022BLK*†
ZXR 750 M1/M2/L1-L3	93-95	FA158*		FA158HH*	MD4022X	MD4022X	MD4022XC*	MD4022CC*	VR4022BLK*†
ZX7-R (ZX 750 P1/P2/P3/P4/P5/P6/P7)	96-03	FA188*		FA188HH*	MD4022X	MD4022X	MD4022XC*	MD4022CC*	VR4022BLK*†
ZX7-RR (ZX 750 N1/N2)	96-99	FA424*		FA424HH*	MD4022X	MD4022X	MD4022XC*	MD4022CC*	VR4022BLK*†
KRF 800 BEF/BFF/FGF/FHF/FJF (Teryx) Left	14-18	FA165TT		FA165R	MD6399D				UTVX6399
	Right	FA135TT		FA135R		MD6399D			UTVX6399
KRF 800 CEF/CFF/GGF/GHF/GJF (Teryx LE) Left	14-18	FA165TT		FA165R	MD6399D				UTVX6399
	Right	FA135TT		FA135R		MD6399D			UTVX6399
KRF 800 DEF/DFE/HGF/HHF/HJF (Teryx Camo) Left	14-18	FA165TT		FA165R	MD6399D				UTVX6399
	Right	FA135TT		FA135R		MD6399D			UTVX6399
KRT 800 BEF/BFF/FGF/FHF/FJF (Teryx 4) Left	14-18	FA165TT		FA165R	MD6399D				UTVX6399
	Right	FA135TT		FA135R		MD6399D			UTVX6399
KRT 800 CEF/CFF/GGF/GHF/GJF (Teryx 4 LE) Left	14-18	FA165TT		FA165R	MD6399D				UTVX6399
	Right	FA135TT		FA135R		MD6399D			UTVX6399
KRT 800 DEF/DFE/HGF/HHF/HJF (Teryx 4 Camo) Left	14-18	FA165TT		FA165R	MD6399D				UTVX6399
	Right	FA135TT		FA135R		MD6399D			UTVX6399
VN 800 A1/A2/A3	95-99	FA085	FA085V	FA085HH	MD4124LS				
VN 800 B1-B10/B6F Classic	96-06	FA229	FA229V	FA229HH	MD4125LS				
VN 800 C1/C2/E1/E2/E3 Drifter	99-04	FA229	FA229V	FA229HH	MD4125LS				
W 800 (Solid Front Disc)	11-12	FA231	FA231V	FA231HH		MD4158			
W 800 Café (Cockpit Fairing)	11-16	FA231	FA231V	FA231HH		MD4008X	MD4008XC	MD4008CC	VR4008BLK†
W 800 Special (Black Exhaust)	12	FA231	FA231V	FA231HH		MD4008X	MD4008XC	MD4008CC	VR4008BLK†
W 800 ABS	13-19	FA231	FA231V	FA231HH		MD4008X	MD4008XC	MD4008CC	VR4008BLK†
W 800 Special	13-16	FA231	FA231V	FA231HH		MD4008X	MD4008XC	MD4008CC	VR4008BLK†
W 800 ABS Disc brake on rear	16-21	FA231	FA231V	FA231HH		MD4008X	MD4008XC	MD4008CC	VR4008BLK†
Z 800 ADS/AEF/AF/AGF (Non ABS)	13-16			FA347HH*			MD4155XC*	MD4155CC*	VR4155BLK*†
Z 800 BDS/BEF/BFF/BGF (ABS Model)	13-16			FA347HH*			MD4155XC*	MD4155CC*	VR4155BLK*†
Z 800 E CDS/CEF/CFF/CGF (Non ABS)	13-16	FA142*	FA142V*	FA142HH*			MD4155XC*	MD4155CC*	VR4155BLK*†
Z 800 E DDS/DEF/DFE/DGF (ABS Model)	13-16			FA347HH*			MD4155XC*	MD4155CC*	VR4155BLK*†
KAF 820 AFF/AGF/AHF/AJF Mule Pro FXT Left	15-18	FA165TT		FA165R	MD6398D				UTVX6398
	Right	FA135TT		FA135R		MD6398D			UTVX6398
KAF 820 BFF/BGF/BHF/BJF Mule Pro FXT/EPG Left	15-18	FA165TT		FA165R	MD6398D				UTVX6398
	Right	FA135TT		FA135R		MD6398D			UTVX6398
KAF 820 CFF/CGF/CHF/CJF Mule Pro FXT/EPG LE Left	15-18	FA165TT		FA165R	MD6398D				UTVX6398
	Right	FA135TT		FA135R		MD6398D			UTVX6398

FRONT / AVANT / VORN / FRENTE / ANTERIORE

Line #

R Suffix = High Durability Sintered Pad. HH Suffix = High Performance Sintered Pad. TT Suffix = Hard Wearing Off Road Pad. V Suffix = Semi Sintered Pad. G Suffix = Grooved Shoe. D Suffix = Drilled Disc. X Suffix = Universal Left or Right Disc. LS Suffix = Left/Steel Disc. RS = Right/Steel Disc.

*-2 Sets Required. † For Vee disc colours add RED, BLU, GRN, GLD, ORG suffix to part number. For Custom Finish Options for Vee-Rotors™ including Splatter discs add suffix CHR, CHGR, CHBL, CHBR - available in various colours see page iv. ☼ - Also available as a Vintage Motorcycle Disc.

JAPANESE Built Motorcycles

Line #	BRAKE DISC CHOICES - FRONT						DISC PAD CHOICES - REAR				BRAKE DISC CHOICES - REAR			
	Oversize 250 /280mm Disc Kit	OSX Oversize 250/280mm Disc Kit	Relocating Bracket for 250/ 280mm Disc	Oversize 320mm Disc Kit	SMX Oversize 320mm Disc Kit	Relocating Bracket for 320mm Disc	FA, SFA, TT Pad or Brake Shoe	SFAC Carbon Scooter Pads	Speciality Pads - SXR / Vee / MXS	Sintered/ HH Pads/ Grooved Shoes	Standard Replacement Disc	Contour Disc Rear fitment	Vee Discs CONTOUR	CX Extreme MX Race Disc
1							K709							
2							FA068		FA068V	FA068HH	MD4169			
3							FA068		FA068V	FA068HH	MD4169			
4							FA068		FA068V	FA068HH	MD4169			
5							K709							
6							FA037							
7							FA037							
8							FA068		FA068V	FA068HH	MD4169			
9														
10							FA192		FA192V	FA192HH	MD4138	MD4138C		
11														
12							FA192		FA192V	FA192HH	MD4138	MD4138C		
13							FA174		FA174V	FA174HH		MD4157C	VR4157	
14							FA174		FA174V	FA174HH		MD4157C		
15							FA140		FA140V	FA140HH		MD4157C	VR4157	
16							FA140		FA140V	FA140HH		MD4157C	VR4157	
17							FA140		FA140V	FA140HH		MD4157C	VR4157	
18							FA129		FA129V	FA129HH	MD4007	MD4007C	VR4007	
19							FA129		FA129V	FA129HH	MD4007	MD4007C	VR4007	
20														
21							FA231			FA231HH	MD4142	MD4142C		
22														
23							FA231			FA231HH	MD4142	MD4142C		
24														
25							FA161		FA161V	FA161HH	MD4013	MD4013C	VR4013	
26							FA161		FA161V	FA161HH	MD4013	MD4013C	VR4013	
27							FA161		FA161V	FA161HH	MD4013	MD4013C	VR4013	
28							FA161		FA161V	FA161HH	MD4013	MD4013C	VR4013	
29							FA254		FA254V	FA254HH	MD4013	MD4013C	VR4013	
30														
31														
32														
33														
34														
35														
36														
37														
38														
39														
40														
41														
42							K709							
43							K709							
44							FA231		FA231V	FA231HH	MD4148			
45							K706							
46							K706							
47							K706							
48							K706							
49							K706							
50							FA197		FA197HH					
51							FA140		FA140V	FA140HH		MD4157C	VR4157	
52							FA140		FA140V	FA140HH		MD4157C	VR4157	
53							FA140		FA140V	FA140HH		MD4157C	VR4157	
54							FA140		FA140V	FA140HH		MD4157C	VR4157	
55							FA686TT		FA686R		MD6398D		UTVX6398	
56							FA686TT		FA686R		MD6398D		UTVX6398	
57							FA686TT		FA686R		MD6398D		UTVX6398	
58							FA686TT		FA686R		MD6398D		UTVX6398	
59							FA686TT		FA686R		MD6398D		UTVX6398	
60							FA686TT		FA686R		MD6398D		UTVX6398	

REAR / ARRIÈRE / HINTEN / POSTERIOR / POSTERIORE

*-2 Sets Required. † For Vee disc colours add RED, BLU, GRN, GLD, ORG suffix to part number. For Custom Finish Options for Vee-Rotors™ including Splatter discs add suffix CHR, CHGR, CHBL, CHBR - available in various colours see page iv. Ⓢ - Also available as a Vintage Motorcycle Disc.

Part numbers, prefixes, suffixes, photos and illustrations shown in this catalogue are trademarks and/or copyrights of EBC Brakes or the trademark owner A C Freeman Investments Ltd and use without express written permission of the owners is punishable by law.

R Suffix = High Durability Sintered Pad. **HH** Suffix = High Performance Sintered Pad. **TT** Suffix = Hard Wearing Off Road Pad. **V** Suffix = Semi Sintered Pad. **G** Suffix = Grooved Shoe.
D Suffix = Drilled Disc. **X** Suffix = Universal Left or Right Disc. **XC** Suffix = Contoured Disc. **LS** Suffix = Left/Steel Disc. **RS** = Right/Steel Disc.

BRAKE APPLICATIONS

JAPANESE Built Motorcycles



KAWASAKI Contd.



DISC PAD CHOICES - FRONT

BRAKE DISC CHOICES - FRONT

R Suffix = High Durability Sintered Pad. **HH** Suffix = High Performance Sintered Pad. **TT** Suffix = Hard Wearing Off Road Pad. **V** Suffix = Semi Sintered Pad. **G** Suffix = Grooved Shoe.
D Suffix = Drilled Disc. **X** Suffix = Universal Left or Right Disc. **XC** Suffix = Contoured Disc. **LS** Suffix = Left/Steel Disc. **RS** = Right/Steel Disc.

Model	Side	Year
KAF 820 DFF/DGF/DHF/DJF	Left	15-18
Mule Pro FXT/EPS Camo	Right	
KAF 820 EGF/EHF/EJF Mule Pro FX	Left	16-18
	Right	
KAF 820 FGF/FHF/FJF	Left	16-18
Mule Pro FX/EPS	Right	
KAF 820 GGF/GHF/GJF	Left	16-18
Mule Pro FX/EPS LE	Right	
KAF 820 HGF/HHF	Left	16-17
Mule Pro FX/EPS Camo	Right	
KAF 820 JGF/JHF	Left	16-17
Mule Pro FXT Ranch Edition	Right	
ZL 900 A1/A2 Eliminator		85-86
GPZ 900 R A1-A6		84-89
GPZ 900 R A7/A8		90-96
GPZ 900 R (ZX 900 A11)		98
GPZ 900 R (ZX 900 A12-A15)		99-02
VN 900 A6F Classic		06
Vulcan Classic LT (Spoke wheels & Screen)		07-20
Vulcan Classic (Spoke Wheels)		11-21
Vulcan Custom (Cast Wheels)		07-21
Z 900 ZIA/ZIB		74-76
Z 900 A4		77
Z 900		17-18
Z 900 Performance (ZR 900 ABS)		17-21
Z 900 RS		18-20
Z 900 RS Performance ABS		18-21
Z 900 RS Café		18-20
ZX 9 R (ZX 900 B1/B2)		94-95
ZX 9 R (ZX 900 B3/B4)		96-97
ZX 9 R (ZX 900 C1/C2)		98-99
ZX 9 R (ZX 900 E1/E2)		00-01
ZX 9 R (ZX 900 F1/F2)		02-04
KAF 950 A1/A2/A3 (Mule 2510 Diesel)		
KAF 950 B1/B2/B3 (Mule 3010 Diesel)		
KAF 950 D8F Mule 3010 Diesel 4 x 4		08
KAF 950 E8F Mule 3010 Trans Diesel 4 x 4		08
KAF 950 F9F/FAF/FBF/FCF/DFD (Mule 4010 Diesel 4 x 4)		09-13
KAF 950 G9F/GAF/GBF/GCF/GDF (Mule 4010 Trans 4 x 4 Diesel)		09-13
GPZ 1000 RX (A1-A3)		86-88
H2 Ninja (ZX 1000 NFF/NGF)		15-16
H2 R Ninja (ZX 1000 PFF/PGF)		15-16
KAF 1000 AGF/AHF/AJF	Left	16-18
Mule Pro DXT/Diesel	Right	
KAF 1000 BGF/BHF/BJF	Left	16-18
Mule Pro DXT/Diesel EPS	Right	
KAF 1000 CGF/CHF	Left	16-17
Mule Pro DXT EPS LE/Diesel	Right	
KAF 1000 DGF/DHF	Left	16-17
Mule Pro DX/Diesel	Right	
KAF 1000 EGF/EHFE/JF	Left	16-18
Mule Pro DX EPS/Diesel	Right	
KAF 1000 FGF/FHF	Left	16-17
Mule Pro DX EPS LE/Diesel	Right	
KLX 1000 (LV 1000 A1H/A2H)	Left	04-05
	Right	
KLZ 1000 ACF/ADF/AEF Versys		12-14
KLZ 1000 BFF/BGF/BHF/BJF/BJFA Versys		15-18
KLX 1000 Versys LT ABS		18-20

FRONT / AVANT / VORN / FRENTE / ANTERIORE

FA, SFA, TT Pad or Brake Shoe	SFAC Carbon Scooter Pads	Speciality Pads - SXR / Vee / MXS	Sintered/HH Pads/ Grooved Shoes	Left / Gauche / Links Standard Replacement Disc	Right / Droite / Rechts Standard Replacement Disc	Contour Disc Universal left and right fitment	Custom Disc Universal left and right fitment	Vee-Disks Black † See note below	CX Extreme MX Race Disc/ UTVX Disc
FA165TT			FA165R	MD6398D					UTVX6398
FA135TT			FA135R		MD6398D				UTVX6398
FA165TT			FA165R	MD6398D					UTVX6398
FA135TT			FA135R		MD6398D				UTVX6398
FA165TT			FA165R	MD6398D					UTVX6398
FA135TT			FA135R		MD6398D				UTVX6398
FA165TT			FA165R	MD6398D					UTVX6398
FA135TT			FA135R		MD6398D				UTVX6398
FA165TT			FA165R	MD6398D					UTVX6398
FA135TT			FA135R		MD6398D				UTVX6398
FA165TT			FA165R	MD6398D					UTVX6398
FA135TT			FA135R		MD6398D				UTVX6398
FA165TT			FA165R	MD6398D					UTVX6398
FA135TT			FA135R		MD6398D				UTVX6398
FA085*		FA085V*	FA085HH*	MD4016	MD4016				
FA085*			FA085HH*	MD4016	MD4016				
FA158*			FA158HH*	MD4008X	MD4008X	MD4008XC*	MD4008CC*	VR4008BLK*†	
FA158*			FA158HH*	MD4008X	MD4008X	MD4008XC*	MD4008CC*	VR4008BLK*†	
FA188*			FA188HH*						
FA229	FA229V		FA229HH	MD4158					
FA229	FA229V		FA229HH	MD4158					
FA229	FA229V	FA229V	FA229HH	MD4158					
FA229	FA229V	FA229V	FA229HH	MD4158					
FA055*				MD4069LS*	MD4069RS*				
FA033*				MD4052LS*	MD4052RS*				
			FA347HH*						
			FA347HH*			MD4177XC*			
			FA379HH*						
			FA379HH*						
			FA379HH*						
FA158*			FA158HH*	MD4022X	MD4022X	MD4022XC*	MD4022CC*	VR4022BLK†	
FA188*			FA188HH*	MD4022X	MD4022X	MD4022XC*	MD4022CC*	VR4022BLK†	
FA188*			FA188HH*	MD4167X	MD4167X	MD4167XC*			
FA188*			FA188HH*	MD4012X	MD4012X	MD4012XC*	MD4012CC*	VR4012BLK*†	
			FA347HH*	MD4022X	MD4022X	MD4022XC*	MD4022CC*	VR4022BLK*†	
K719*									
K719*									
K719*									
K719*									
K719*									
FA085*			FA085HH*	MD4016	MD4016				
			FA447HH*						
			FA447HH*						
FA165TT			FA165R	MD6398D					UTVX6398
FA135TT			FA135R		MD6398D				UTVX6398
FA165TT			FA165R	MD6398D					UTVX6398
FA135TT			FA135R		MD6398D				UTVX6398
FA165TT			FA165R	MD6398D					UTVX6398
FA135TT			FA135R		MD6398D				UTVX6398
FA165TT			FA165R	MD6398D					UTVX6398
FA135TT			FA135R		MD6398D				UTVX6398
FA165TT			FA165R	MD6398D					UTVX6398
FA135TT			FA135R		MD6398D				UTVX6398
FA229	FA229V	FA229V	FA229HH	MD3088X	MD3088X	MD3088XC	MD3088CC	VR3088BLK†	
FA231	FA231V	FA231V	FA231HH			MD3088XC	MD3088CC	VR3088BLK†	
FA158*			FA158HH*			MD4156XC*			
FA158*			FA158HH*						
			FA158HH*	MD4155X	MD4155X				

Line #
1
2
3
4
5
6
7
8
9
10
11
12
13
14
15
16
17
18
19
20
21
22
23
24
25
26
27
28
29
30
31
32
33
34
35
36
37
38
39
40
41
42
43
44
45
46
47
48
49
50
51
52
53
54
55
56
57
58
59
60

*-2 Sets Required. † For Vee disc colours add RED, BLU, GRN, GLD, ORG suffix to part number. For Custom Finish Options for Vee-Rotors™ including Splatter discs add suffix CHR, CHGR, CHBL, CHBR - available in various colours see page iv. * - Also available as a Vintage Motorcycle Disc.

JAPANESE Built Motorcycles

Line #	BRAKE DISC CHOICES - FRONT						DISC PAD CHOICES - REAR				BRAKE DISC CHOICES - REAR			
	OverSize 250 /280mm Disc Kit	OSX OverSize 250/280mm Disc Kit	Relocating Bracket for 250/ 280mm Disc	OverSize 320mm Disc Kit	SMX OverSize 320mm Disc Kit	Relocating Bracket for 320mm Disc	FA, SFA, TT Pad or Brake Shoe	SFAC Carbon Scooter Pads	Speciality Pads - SXR / Vee / MXS	Sintered/ HH Pads/ Grooved Shoes	Standard Replacement Disc	Contour Disc Rear fitment	Vee Discs CONTOUR	CX Extreme MX Race Disc
1							FA686TT			FA686R	MD6398D			UTVX6398
2							FA686TT			FA686R	MD6398D			UTVX6398
3							FA686TT			FA686R	MD6398D			UTVX6398
4							FA686TT			FA686R	MD6398D			UTVX6398
5							FA686TT			FA686R	MD6398D			UTVX6398
6							FA686TT			FA686R	MD6398D			UTVX6398
7							FA686TT			FA686R	MD6398D			UTVX6398
8							FA686TT			FA686R	MD6398D			UTVX6398
9							FA686TT			FA686R	MD6398D			UTVX6398
10							FA686TT			FA686R	MD6398D			UTVX6398
11							FA686TT			FA686R	MD6398D			UTVX6398
12							FA686TT			FA686R	MD6398D			UTVX6398
13							FA085		FA085V	FA085HH	MD4017			
14							FA085		FA085V	FA085HH	MD4017			
15							FA129		FA129V	FA129HH	MD4015	MD4015C	VR4015	
16							FA129		FA129V	FA129HH	MD4015	MD4015C	VR4015	
17							FA129		FA129V	FA129HH	MD4015	MD4015C	VR4015	
18							FA231		FA231/2V	FA231HH	MD4085			
19							FA231		FA231/2V	FA231HH	MD4085			
20							FA231		FA231/2V	FA231HH	MD4085			
21							FA231		FA231/2V	FA231HH	MD4085			
22							K713							
23							K713							
24							FA140		FA140V	FA140HH				
25							FA140		FA140V	FA140HH				
26							FA140		FA140V	FA140HH				
27							FA140		FA140V	FA140HH				
28							FA140		FA140V	FA140HH				
29							FA192		FA192V	FA192HH	MD4013	MD4013C	VR4013	
30							FA192		FA192V	FA192HH	MD4013	MD4013C	VR4013	
31							FA192		FA192V	FA192HH	MD4138	MD4138C		
32							FA192		FA192V	FA192HH	MD4138	MD4138C	VR4138	
33							FA192		FA192V	FA192HH	MD4138	MD4138C	VR4138	
34							K720*							
35							K720*							
36							K720*							
37							K720*							
38							K720*							
39														
40							K720*							
41							FA085		FA085V	FA085HH	MD4019			
42							FA266		FA266V	FA266HH				
43							FA266		FA266V	FA266HH				
44							FA686TT			FA686R	MD6398D			UTVX6398
45							FA686TT			FA686R	MD6398D			UTVX6398
46							FA686TT			FA686R	MD6398D			UTVX6398
47							FA686TT			FA686R	MD6398D			UTVX6398
48							FA686TT			FA686R	MD6398D			UTVX6398
49							FA686TT			FA686R	MD6398D			UTVX6398
50							FA686TT			FA686R	MD6398D			UTVX6398
51							FA686TT			FA686R	MD6398D			UTVX6398
52							FA686TT			FA686R	MD6398D			UTVX6398
53							FA686TT			FA686R	MD6398D			UTVX6398
54							FA686TT			FA686R	MD6398D			UTVX6398
55							FA686TT			FA686R	MD6398D			UTVX6398
56														
57							FA174		FA174V	FA174HH	MD6232D			MD6232CX
58							FA174		FA174V	FA174HH		MD4157C		
59							FA174		FA174V	FA174HH				
60							FA174		FA174V	FA174HH				

REAR / ARRIÈRE / HINTEN / POSTERIOR / POSTERIORE

R Suffix = High Durability Sintered Pad. **HH** Suffix = High Performance Sintered Pad. **TT** Suffix = Hard Wearing Off Road Pad. **V** Suffix = Semi Sintered Pad. **G** Suffix = Grooved Shoe.
D Suffix = Drilled Disc. **X** Suffix = Universal Left or Right Disc. **XC** Suffix = Contoured Disc. **LS** Suffix = Left/Steel Disc. **RS** = Right/Steel Disc.

*-2 Sets Required. † For Vee disc colours add RED, BLU, GRN, GLD, ORG suffix to part number. For Custom Finish Options for Vee-Rotors™ including Splatter discs add suffix CHR, CHGR, CHBL, CHBR - available in various colours see page iv. ☉ - Also available as a Vintage Motorcycle Disc.

BRAKE APPLICATIONS

JAPANESE Built Motorcycles



KAWASAKI Contd.



DISC PAD CHOICES - FRONT

BRAKE DISC CHOICES - FRONT

Model	Year	FA, SFA, TT Pad or Brake Shoe	SFAC Carbon Scooter Pads	Speciality Pads - SXR / Vee / MXS	Sintered/HH Pads/ Grooved Shoes	Left / Gauche / Links Standard Replacement Disc	Right / Droite / Rechts Standard Replacement Disc	Contour Disc Universal left and right fitment	Custom Disc Universal left and right fitment	Vee-Disks Black † See note below	CX Extreme MX Race Disc/ UTVX Disc	Line #
KLX 1000 Versys SE LT ABS	18-20				FA379HH*	MD4155X	MD4155X					1
KLX 1000 Versys SE LT+ ABS	18-20				FA379HH*	MD4155X	MD4155X					2
KRX 1000 Teryx	20-21				FA738R*	MD6434D	MD6434D					3
KLZ 1000 Versys S Tourer and Grand Tourer ABS	20-21				FA379HH*	MD4155X	MD4155X	MD4155X*				4
Z 1000 A1/A2	77-78	FA033*				MD4064LS	MD4064RS					5
Z 1000 A3/A4	79-80	FA073*				MD4064LS	MD4064RS					6
Z 1000 D1 (ZIR)	78-	FA033*				MD4076LS	MD4076RS					7
Z 1000 D3 (ZIR)	79	FA073*				MD4076LS	MD4076RS					8
Z 1000 ST (E1-E2 Shaft)	79-82	FA062*				MD4078LS	MD4078RS					9
Z 1000 H1	80	FA033*				MD4064LS	MD4064RS					10
Z 1000 J1/J2	81-82	FA068*			FA068HH*	MD4006LS	MD4006RS					11
Z 1000 J3	83	FA068*			FA068HH*	MD4038	MD4038					12
Z 1000 JHF/JJF ABS - 310mm Plain Discs	17-21				FA379HH*	MD4155X	MD4155X			VR4155BLK†		13
Z 1000 K1/K2 LTD	81-83	FA068*		FA068V*	FA068HH*	MD4006LS	MD4006RS					14
Z 1000 R2	83	FA068*			FA068HH*	MD4038	MD4038					15
Z 1000 (ZR 1000 A1/A2/A3/A6F)	03-06				FA347HH*	MD4154X	MD4154X	MD4154XC*	MD4154CC*	VR4154BLK†		16
Z 1000 (ZR 1000 B7F/B8F/B9F)	07-09				FA417/4HH*			MD4152XC*	MD4152CC*	VR4152BLK†		17
Z 1000 ABS (ZR 1000 C7F/C8F/C9F)	07-09				FA417/4HH*			MD4152XC*	MD4152CC*	VR4152BLK†		18
Z 1000 (ZR 1000 DAF/DBF/DCF/DDF/FEF/FFF)	10-15				FA379HH*			MD4152XC*	MD4152CC*	VR4152BLK†		19
Z 1000 (ZR 1000 DCFA/DDFA/FEFA)	12-14				FA379HH*			MD4152XC*	MD4152CC*	VR4152BLK†		20
Z 1000 DAF/DAS/DBF/DCF/DCFA/DDF/DDFA (Non ABS/300mm Disc)	10-13							MD4152XC*	MD4152CC*	VR4152BLK†		22
Z 1000 EAF/EBF/ECF/ECFA/EDF/EDFA (ABS/300mm Discs)	10-13				FA379HH*			MD4152XC*	MD4152CC*	VR4152BLK†		24
Z 1000 FEF/FEFA/FFF/FGF (Non ABS/310mm Discs)	14-16				FA379HH*			MD4155XC*		VR4155BLK†		25
Z 1000 HLF (ABS/310mm Contour Discs)	14-20				FA379HH*			MD4155XC*				26
Z 1000 R (ABS/310mm Round Discs)	17-20				FA447HH*							27
Z 1000 Special Edition (ZR 1000 GEFA)	14				FA379HH*			MD4152XC*	MD4152CC*	VR4152BLK†		28
Z 1000 SX (ZX 1000 HBF/HCF/HDF) ABS Model	11-13				FA379HH*			MD4152XC*	MD4152CC*	VR4152BLK†		29
Z 1000 SX (ZX 1000 GBF/GCF/GDF) Non ABS Model	11-13				FA379HH*			MD4152XC*	MD4152CC*	VR4152BLK†		30
Z 1000 SX Non ABS (ZX 1000 LEF/LFF/LGF)	14-16				FA379HH*			MD4152XC*	MD4152CC*	VR4152BLK†		31
Z 1000 SX ABS	14-20				FA379HH*			MD4152XC*	MD4152CC*	VR4152BLK†		32
Z 1000 SX Tourer	14				FA379HH*			MD4152XC*	MD4152CC*	VR4152BLK†		33
Z H2	20				FA630HH*	TBA	TBA					34
Z H2 Performance	21				FA630HH*	TBA	TBA					35
Z H2 SE Performance	21				FA630HH*	TBA	TBA					36
ZL 1000 A1	87	FA085*		FA085V*	FA085HH*	MD4016	MD4016					37
ZX 1000 B1-B3 (ZX-10)	88-90	FA129*			FA129HH*	MD4021	MD4021					38
ZG 1000 A1-A7 (1000 GTR)	86-93	FA085*		FA085V*	FA085HH*	MD4028	MD4028					39
ZG 1000 A9-A18 (1000 GTR)	94-03	FA129*		FA129V*	FA129HH*	MD4008X	MD4008X	MD4008XC*	MD4008CC*	VR4008BLK†		40
ZX10 R Ninja (ZX 1000 C1/C2/D6F/D7F)	04-07				FA369/4HH*			MD4152XC*	MD4152CC*	VR4152BLK†		41
ZX10 R Ninja (ZX 1000 E8F/E9F/FAF)	08-10				FA379HH*			MD4161XC*		VR4161BLK†		42
ZX10 R Ninja (ZX 1000 GBF/GCF/GDF)	11-13				FA379HH*			TBA*		VR4161BLK†		43
ZX10 R Ninja (ZX 1000 JBF/JCF/JDF/JEF/JFF)	11-15				FA379HH*			MD4161XC*		VR4161BLK†		44
ZX10 R Ninja ABS (ZX 1000 KBF/KCF/KDF/KEF/KFF)	11-15				FA379HH*			MD4161XC*				45
ZX10 R Ninja ABS (ZX 1000 HCF/HDF)	12-13				FA379HH*			MD4170X*		VR4161BLK†		46
ZX10 R Ninja ABS (ZX 1000 MEF/MFF)	14-19				FA379HH*			MD4170X*		VR4161BLK†		47
ZX10 R Ninja 30th Anniversary Edition (ZX 1000 JFFA)	15				FA379HH*			MD4161XC*				48
ZX10 R Ninja 30th Anniversary Edition ABS (ZX 1000 KFFA)	15				FA379HH*			MD4161XC*				49
ZX 10 R Winter Test Edition (ZX 1000 SGFB)	16				FA447HH*	MD4170X	MD4170X			VR4170CHGR†		51
ZX10 R Ninja ABS												52
(ZX 1000 RGF/SGF/RHF/SHF/RJF/SJF)	16-18				FA447HH*	MD4170X	MD4170X					53
ZX10 R Ninja ABS KRT Edition												54
(ZX 1000 RGFA/SGFA/RHFA/SHFA/RJFA/SJFA)	16-18				FA447HH*	MD4170X	MD4170X					55
ZX10 R Ninja ABS (ZX 1002 EKf/FKf)	19-21				FA447HH*	MD4170X	MD4170X					56
ZX10 R Ninja SE ABS (ZX 1002 EKf/FKf)		19-20				FA447HH*	MD4170X	MD4170X				57
ZX10 R Ninja ABS KRT Edition												58
(ZX 1002 EKFA/FKFA)	19-20				FA447HH*	MD4170X	MD4170X					59
ZX10 RR Ninja (ZX 1000 ZHF/ZJF)	17-18				FA447HH*	MD4175X	MD4175X					60

FRONT / AVANT / VORN / FRENTE / ANTERIORE

R Suffix = High Durability Sintered Pad. HH Suffix = High Performance Sintered Pad. TT Suffix = Hard Wearing Off Road Pad. V Suffix = Semi Sintered Pad. G Suffix = Grooved Shoe.
D Suffix = Drilled Disc. X Suffix = Universal Left or Right Disc. XC Suffix = Contoured Disc. LS Suffix = Left/Steel Disc. RS Suffix = Right/Steel Disc.

*-2 Sets Required. † For Vee disc colours add RED, BLU, GRN, GLD, ORG suffix to part number. For Custom Finish Options for Vee-Rotors™ including Splatter discs add suffix CHRd, CHGR, CHBL, CHBR - available in various colours see page iv. Ⓢ - Also available as a Vintage Motorcycle Disc.

JAPANESE Built Motorcycles

Line #	BRAKE DISC CHOICES - FRONT						DISC PAD CHOICES - REAR				BRAKE DISC CHOICES - REAR			
	Oversize 250 /280mm Disc Kit	OSX Oversize 250/280mm Disc Kit	Relocating Bracket for 250/ 280mm Disc	Oversize 320mm Disc Kit	SMX Oversize 320mm Disc Kit	Relocating Bracket for 320mm Disc	FA, SFA, TT Pad or Brake Shoe	SFAC Carbon Scooter Pads	Speciality Pads - SXR / Vee / MXS	Sintered/ HH Pads/ Grooved Shoes	Standard Replacement Disc	Contour Disc Rear fitment	Vee Discs CONTOUR	CX Extreme MX Race Disc
1							FA174			FA174HH				
2							FA174			FA174HH				
3									FA739R*	MD6434D				
4							FA174		FA174HH		MD4157C			
5							FA036	FA036V		MD4077 ⚙				
6							FA036	FA036V		MD4077 ⚙				
7							FA036	FA036V		MD4077 ⚙				
8							FA036	FA036V		MD4077 ⚙				
9							FA036	FA036V		MD4090				
10							FA036	FA036V		MD4077 ⚙				
11							FA068	FA068V	FA068HH	MD4054				
12							FA068	FA068V	FA068HH	MD4054				
13							FA192	FA192V	FA192HH		MD4157C	VR4157		
14							FA068	FA068V	FA068HH	MD4054				
15							FA068	FA068V	FA068HH	MD4054				
16							FA192	FA192V	FA192HH	MD4138	MD4138C	VR4138		
17							FA174	FA174V	FA174HH		MD4157C	VR4157		
18							FA174	FA174V	FA174HH		MD4157C	VR4157		
19							FA192	FA192V	FA192HH		MD4157C	VR4157		
20							FA192	FA192V	FA192HH		MD4157C	VR4157		
21														
22							FA192	FA192V	FA192HH		MD4157C	VR4157		
23														
24							FA192	FA192V	FA192HH		MD4157C	VR4157		
25							FA192	FA192V	FA192HH		MD4157C	VR4157		
26							FA192	FA192V	FA192HH		MD4157C	VR4157		
27							FA192	FA192V	FA192HH					
28							FA192	FA192V	FA192HH		MD4157C	VR4157		
29							FA192	FA192V	FA192HH		MD4157C	VR4157		
30							FA192	FA192V	FA192HH		MD4157C	VR4157		
31							FA192	FA192V	FA192HH		MD4157C	VR4157		
32							FA192	FA192V	FA192HH		MD4157C	VR4157		
33							FA192	FA192V	FA192HH		MD4157C	VR4157		
34														
35							FA266		FA266HH					
36							FA266		FA266HH					
37							FA085	FA085V	FA085HH	MD4017				
38							FA129	FA129V	FA129HH	MD4015				
39							FA085	FA085V	FA085HH	MD4082				
40							FA085	FA085V	FA085HH	MD4082				
41							FA192		FA192HH		MD4138C	VR4138		
42							FA192		FA192HH		MD4138C	VR4138		
43							FA192		FA192HH		MD4157C			
44							FA436		FA436HH		MD4165C	VR4165		
45							FA436		FA436HH		MD4165C	VR4165		
46							FA192		FA192HH		MD4157C			
47							FA192		FA192HH		MD4157C			
48							FA436		FA436HH		MD4165C	VR4165		
49											MD4165C	VR4165		
50							FA436		FA436HH					
51							FA436		FA436HH	MD4165				
52														
53							FA436		FA436HH	MD4165				
54														
55							FA436		FA436HH	MD4165				
56							FA436		FA436HH	MD4165				
57								FA436		FA436HH	MD4166			
58														
59							FA436		FA436HH	MD4166				
60							FA436		FA436HH	MD4165				

REAR / ARRIÈRE / HINTEN / POSTERIOR / POSTERIORE

*-2 Sets Required. † For Vee disc colours add RED, BLU, GRN, GLD, ORG suffix to part number. For Custom Finish Options for Vee-Rotors™ including Splatter discs add suffix CHR, CHGR, CHBL, CHBR - available in various colours see page iv. ⚙ - Also available as a Vintage Motorcycle Disc.

R Suffix = High Durability Sintered Pad. **HH** Suffix = High Performance Sintered Pad. **TT** Suffix = Hard Wearing Off Road Pad. **V** Suffix = Semi Sintered Pad. **G** Suffix = Grooved Shoe.
D Suffix = Drilled Disc. **X** Suffix = Universal Left or Right Disc. **XC** Suffix = Contoured Disc. **LS** Suffix = Left/Steel Disc. **RS** = Right/Steel Disc.

BRAKE APPLICATIONS

JAPANESE Built Motorcycles



KAWASAKI Contd.



DISC PAD CHOICES - FRONT

BRAKE DISC CHOICES - FRONT

R Suffix = High Durability Sintered Pad. **HH** Suffix = High Performance Sintered Pad. **TT** Suffix = Hard Wearing Off Road Pad. **V** Suffix = Semi Sintered Pad. **G** Suffix = Grooved Shoe.

D Suffix = Drilled Disc. **X** Suffix = Universal Left or Right Disc. **XC** Suffix = Contoured Disc. **LS** Suffix = Left/Steel Disc. **RS** = Right/Steel Disc.

FRONT / AVANT / VORN / FRENTE / ANTERIORE

		FA, SFA, TT Pad or Brake Shoe	SFAC Carbon Scooter Pads	Speciality Pads - SXR / Vee / MXS	Sintered/HH Pads/ Grooved Shoes	Left / Gauche / Links Standard Replacement Disc	Right / Droite / Rechts Standard Replacement Disc	Contour Disc Universal left and right fitment	Custom Disc Universal left and right fitment	Vee-Disks Black † See note below	CX Extreme MX Race Disc/ UTVX Disc	Line #
ZX 1000 Front disc 5.5mm thickness					FA447HH*	MD4173X	MD4173X					1
ZX10 RR Ninja (ZX 1002 GKF)					FA447HH*	MD4175X	MD4175X					2
Ninja H2/Carbon (ZX 1000 NFF/NGF/XHF/XHFA)					FA447HH*	TBA	TBA					3
Ninja H2/Carbon (ZX 1002 JFK/JKFA)					FA447HH*	TBA	TBA					4
Ninja H2R (ZX 1000 P)					FA447HH*	TBA	TBA					5
Ninja H2R (ZX 1000 P)					FA447HH*	TBA	TBA					6
Ninja H2 SX (ZX 1002 AJF)					FA379HH*	TBA	TBA					7
Ninja H2 SX SE (ZX 1002 BJF)					FA379HH*	TBA	TBA					8
Ninja H2 SX SE+ (ZX 1002 DKF)					FA447HH*							9
Ninja 1000 SX Performance Tourer					FA379HH							10
GPZ 1100 B1		FA068*			FA068HH*	MD4006LS	MD4006RS					11
GPZ 1100 B2		FA068*			FA068HH*	MD4038	MD4038					12
Z 1100 D1/D2 Spectre		FA068*		FA068V*	FA068HH*	MD4006LS	MD4006RS					13
GPZ 1100 A1-A3		FA085*			FA085HH*	MD4016	MD4016					14
Z 1100 A1-A3		FA068*		FA068V*	FA068HH*	MD4006LS	MD4006RS					15
Z 1100 R1 Lawson Replica		FA085*			FA085HH*	MD4038	MD4038					16
ZR 1100 A1-A4 Zephyr		FA158*			FA158HH*	MD4012X	MD4012X	MD4012XC*	MD4012CC*	VR4012BLK*†		17
ZR 1100 B1 Zephyr	Left	FA229			FA229HH	MD4012X		MD4012XC	MD4012CC	VR4012BLK*†		18
	Right	FA231			FA231HH		MD4012X	MD4012XC	MD4012CC	VR4012BLK*†		19
ZR 1100 B5 (Zephyr 1100 RS)	Left	FA229			FA229HH	MD4012X		MD4012XC	MD4012CC	VR4012BLK*†		20
	Right	FA231			FA231HH		MD4012X	MD4012XC	MD4012CC	VR4012BLK*†		21
ZRX 1100 (ZR 1100 C1/C2/C3/C4)		FA188*			FA188HH*	MD4012X	MD4012X	MD4012XC*	MD4012CC*	VR4012BLK*†		22
ZZR 1100 (ZX 1100 C1-C3)		FA158*			FA158HH*	MD4012X	MD4012X	MD4012XC*	MD4012CC*	VR4012BLK*†		23
ZZR 1100 (ZX 1100 D1-D9)		FA158*			FA158HH*	MD4022X	MD4022X	MD4022XC*	MD4022CC*	VR4022BLK*†		24
GPZ 1100 E1/E2	Left	FA229			FA229HH	MD4008X		MD4008XC	MD4008CC	VR4008BLK*†		25
	Right	FA231			FA231HH		MD4008X	MD4008XC	MD4008CC	VR4008BLK*†		26
GPZ 1100 F1 (ABS Model)	Left	FA229			FA229HH	MD4008X		MD4008XC		VR4008BLK*†		27
	Right	FA231			FA231HH		MD4132X	MD4132XC		VR4008BLK*†		28
ZX 12 R (ZX 1200 A1/A2/B1/B2)		FA188*			FA188HH*	MD4022X	MD4022X	MD4022XC*	MD4022CC*	VR4022BLK*†		29
ZX 12 R (ZX 1200 B3/B4/B6F)					FA369/4HH*	MD4154X	MD4154X	MD4154XC*	MD4154CC*	VR4154BLK*†		30
ZRX 1200 R (ZR 1200 A1/A2/A3/A4/A5/A6F)		FA188*			FA188HH*	MD4012X	MD4012X	MD4012XC*	MD4012CC*	VR4012BLK*†		31
ZRX 1200 S (ZR 1200 B1/B2/B3)		FA188*			FA188HH*	MD4012X	MD4012X	MD4012XC*	MD4012CC*	VR4012BLK*†		32
ZZR 1200 C1H/C2H		FA158*			FA158HH*	MD4022X	MD4022X	MD4022XC*	MD4022CC*	VR4022BLK*†		33
Z 1300 A1-A5		FA062*				MD4089LS⊗	MD4089RS⊗					34
ZG 1300 A1-A3		FA062*				MD4089LS⊗	MD4089RS⊗					35
GTR 1400 (ZG 1400 A8F/A9F/CAF/CBF) ABS					FA417/4HH*			MD4155XC*	MD4155CC*	VR4155BLK*†		36
GTR 1400 ABS (ZG 1400 CCF/CDF/CEF/EEF /EGF/EHF/EJF/EKF)					FA417/4HH*			MD4155XC*	MD4155CC*	VR4155BLK*†		37
ZZR 1400 (ZX 1400 A6F/A7F)					FA417/4HH*			MD4155XC*	MD4155CC*			38
ZZR 1400 ABS (ZX 1400 B6F/B7F)					FA417/4HH*			MD4155XC*	MD4155CC*			39
ZZR 1400 ABS					FA417/4HH*			MD4155XC*	MD4155CC*			40
ZZR 1400 ABS					FA417/4HH*			MD4155XC*	MD4155CC*			41
ZZR 1400 ABS					FA417/4HH*			MD4155XC*	MD4155CC*			42
ZZR 1400 ABS Performance					FA447HH							43
ZZR 1400 ABS Performance Sport					FA447HH							44
VN 1500 B2-B6 (VN 15 SE)		FA085		FA085V	FA085HH	MD4094LS						45
VN 1500 A6 (VN15)		FA085		FA085V	FA085HH	MD4124LS						46
VN 1500 C1/C2 (VN15)		FA085		FA085V	FA085HH	MD4124LS						47
VN 1500 D1/D2/E1/E2 Classic		FA229		FA229V	FA229HH	MD4131LS						48
VN 1500 G1/G2 Classic Tourer	Left	FA229		FA229V	FA229HH	MD4150						49
	Right	FA231		FA231V	FA231HH		MD4150					50
VN 1500 J1/J2/R1/R2/R3 Drifter		FA229		FA229V	FA229HH	MD4125LS						51
VN 1500 N1/N2/N3 Classic Fi		FA229		FA229V	FA229HH	MD4125LS						52
VN 1500 L1/L2/L3/L4 Classic Tourer Fi	Left	FA229		FA229V	FA229HH	MD4150						53
	Right	FA231		FA231V	FA231HH		MD4150					54
VN 1500 P1/P2 Mean Streak		FA188*			FA188HH*	MD4022X	MD4022X	MD4022XC*	MD4022CC*	VR4022BLK*†		55
VN 1600 A1/A2/A3/A6F Classic	Left	FA229		FA229V	FA229HH	MD4158						56
	Right	FA231		FA231V	FA231HH		MD4158					57
VN 1600 B1 Mean Streak		FA188*			FA188HH*	MD4022X	MD4022X	MD4022XC*	MD4022CC*	VR4022BLK*†		58
VN 1600 B2H/B6F/B7F Mean Streak					FA369/4HH*	MD4022X	MD4022X	MD4022XC*	MD4022CC*	VR4022BLK*†		59
												60

*-2 Sets Required. † For Vee disc colours add RED, BLU, GRN, GLD, ORG suffix to part number. For Custom Finish Options for Vee-Rotors™ including Splatter discs add suffix CHR, CHGR, CHBL, CHBR - available in various colours see page iv. ⊗ - Also available as a Vintage Motorcycle Disc.

JAPANESE Built Motorcycles

Line #	BRAKE DISC CHOICES - FRONT						DISC PAD CHOICES - REAR				BRAKE DISC CHOICES - REAR			
	Oversize 250 /280mm Disc Kit	OSX Oversize 250/280mm Disc Kit	Relocating Bracket for 250/ 280mm Disc	Oversize 320mm Disc Kit	SMX Oversize 320mm Disc Kit	Relocating Bracket for 320mm Disc	FA, SFA, TT Pad or Brake Shoe	SFAC Carbon Scooter Pads	Speciality Pads - SXR / Vee / MXS	Sintered/ HH Pads/ Grooved Shoes	Standard Replacement Disc	Contour Disc Rear fitment	Vee Discs CONTOUR	CX Extreme MX Race Disc
1							FA436		FA436HH	MD4165				
2							FA436		FA346HH	MD4165				
3							FA266		FA266HH					
4														
5							FA266		FA266HH					
6							FA266		FA266HH					
7							FA228		FA228HH					
8							FA228		FA228HH					
9							FA228		FA228HH					
10									FA228HH					
11							FA068	FA068V	FA068HH	MD4054				
12							FA068	FA068V	FA068HH	MD4054				
13							FA068	FA068V	FA068HH	MD4054				
14							FA085	FA085V	FA085HH	MD4017				
15							FA068	FA068V	FA068HH	MD4054				
16							FA068	FA068V	FA068HH	MD4054				
17							FA129	FA129V	FA129HH	MD4027	MD4027C	VR4027		
18							FA129	FA129V	FA129HH	MD4027	MD4027C	VR4027		
19														
20							FA129	FA129V	FA129HH	MD4027	MD4027C	VR4027		
21														
22							FA161	FA161V	FA161HH	MD4133	MD4133C	VR4133		
23							FA129	FA129V	FA129HH	MD4015	MD4015C	VR4015		
24							FA161	FA161V	FA161HH	MD4014	MD4014C	VR4014		
25							FA192	FA192V	FA192HH	MD4130	MD4130C	VR4130		
26														
27							FA192	FA192V	FA192HH	MD4130	MD4130C	VR4130		
28														
29							FA161		FA161HH	MD4023	MD4023C	VR4023		
30							FA161		FA161HH	MD4023	MD4023C	VR4023		
31							FA161	FA161V	FA161HH	MD4133	MD4133C	VR4133		
32							FA161	FA161V	FA161HH	MD4133	MD4133C	VR4133		
33							FA161		FA161HH	MD4133	MD4133C	VR4133		
34							FA036	FA036V		MD4090				
35							FA036	FA036V		MD4090				
36							FA254				MD4160C	VR4160		
37														
38							FA254		FA254HH		MD4160C	VR4160		
39							FA254		FA254HH	MD4157	MD4157C	VR4157		
40							FA254		FA254HH	MD4157	MD4157C	VR4157		
41							FA254		FA254HH	MD4157	MD4157C	VR4157		
42							FA254		FA254HH	MD4157	MD4157C	VR4157		
43							FA254		FA254HH	MD4157	MD4157C	VR4157		
44							FA254		FA254HH	MD4157	MD4157C	VR4157		
45							FA085	FA085V	FA085HH	MD4054				
46							FA085	FA085V	FA085HH	MD4054				
47							FA085	FA085V	FA085HH	MD4128				
48							FA085	FA085V	FA085HH	MD4128				
49							FA085	FA085V	FA085HH	MD4147				
50														
51							FA231	FA231V	FA231HH	MD4148				
52							FA231	FA231V	FA231HH	MD4148				
53							FA231	FA231/3V	FA231HH	MD4147				
54														
55							FA231	FA231/3V	FA231HH	MD4146				
56							FA231	FA231/3V	FA231HH	MD4146				
57														
58							FA231	FA231/3V	FA231HH	MD4146				
59							FA231	FA231/2V	FA231HH	MD4146				
60														

REAR / ARRIÈRE / HINTEN / POSTERIOR / POSTERIORE

R Suffix = High Durability Sintered Pad. **HH** Suffix = High Performance Sintered Pad. **TT** Suffix = Hard Wearing Off Road Pad. **V** Suffix = Semi Sintered Pad. **G** Suffix = Grooved Shoe.
D Suffix = Drilled Disc. **X** Suffix = Universal Left or Right Disc. **XC** Suffix = Contoured Disc. **LS** Suffix = Left/Steel Disc. **RS** = Right/Steel Disc.

BRAKE APPLICATIONS

*-2 Sets Required. † For Vee disc colours add RED, BLU, GRN, GLD, ORG suffix to part number. For Custom Finish Options for Vee-Rotors™ including Splatter discs add suffix CHR, CHGR, CHBL, CHBR - available in various colours see page iv. Ⓢ - Also available as a Vintage Motorcycle Disc.

JAPANESE Built Motorcycles



KAWASAKI Contd.



VN 1600 D1H/D6F Classic Tourer	Left	05-08
	Right	
VN 1700 Voyager ABS		09-20
VN 1700 C9F Classic Tourer	Left	09
	Right	
VN 1700 DAF/DBF/DCF/DDF/DEF Classic Tourer ABS		10-14
VN 1700 DFF/DGF Vulcan 1700 Nomad		15-16
VN 1700 E9F Classic	Left	09
	Right	
VN 1700 FAF/FBF/FCF/FDF/FEF Classic ABS		10-14
VN 1700 KBF/KCF/KDF/KEF Voyager Custom		11-14
VN 2000 A1/A2/A6F		04-07
VN 2000 H8F/H9F Classic		08-09

SUZUKI

A 50		71-76
AD 50 T/Tune/V-Tune		88
AE 50 R		
AE 50 L/NT Style		90-96
AH 50 N Address (CA1GA)		92-95
AH 50 N Address (CA1GA) Italian Market		92-95
AJ 50 ZZ/RS Sepia		92-
AP 50		75-78
AP 50 R/S/T/V/W		96-02
AY 50 V/W/W/W/WRW/K1-K4 Katana		97-04
AY 50 WRX/WX/WRY/WY/WRK1/WRK2/WRK3/WRK4 Katana (Grimeca caliper)		99-04
AY 50 WRK1/WRK2/WRK3/WRK4/AK5 (AJP Caliper)		01-05
AZ 50 XLX/UX/Y/LY/UY/K2/UK2 (LETS II)		
AZ 50 RY/RK2 (ZZ Inch Up Sport)		00-02
AZ 50 7/8 Let 4/G (CA45A)		07-08
CL 50 D Suzi/Love		83
CP 50 CHF (CA14C)		85
CP 50 C		
CR 50 DC		
CS 50 Z/D Roadie		83-84
CX 50 DF (CA15A)		85
DR-Z 50		18-21
F 50		71-73
FR 50		74-81
FS 50 T/X Snip		81-82
FZ 50 N/X/Z/G/K/L/P Suzy		80-96
GS 50 K5 (NA41A)		05
GT 50 KB/KEN		77-80
JR 50 (All models)		78-07
LT 50 G/H/J/K/L/X/Y/K1		86-02
LT-A 50 K2/K3/K4/K5 Quadmaster		02-05
LT-Z 50 K6/K7/K8/K9/L0/L4/L5/L6/L7/L8 Quadspout		06-18
OR 50 ET		80
RB 50 H GSXR 50		87
RG 50 EW		
RM 50 C/N/T		78-80
RM 50 X/Z		81-82
RMX 50		
TR 50 SW/SX Street Magic		98-00
TS 50 W		
TS 50 KN		79
TS 50 ERK/X/Z/D		80-83
TS 50 XKE/XKG/XKH/XKJ/XKM/XKR		84-02
UF 50 Y Estilete		00-02

FRONT / AVANT / VORN / FRENTE / ANTERIORE

DISC PAD CHOICES - FRONT				BRAKE DISC CHOICES - FRONT						Line #
FA, SFA, TT Pad or Brake Shoe	SFAC Carbon Scooter Pads	Speciality Pads - SXR / Vee / MXS	Sintered/HH Pads/ Grooved Shoes	Left / Gauche / Links Standard Replacement Disc	Right / Droite / Rechts Standard Replacement Disc	Contour Disc Universal left and right fitment	Custom Disc Universal left and right fitment	Vee-Disks Black † See note below	CX Extreme MX Race Disc/ UTVX Disc	Line #
FA229		FA229V	FA229HH	MD4158						1
FA231		FA231V	FA231HH		MD4158					2
FA158*			FA158HH*	MD4158	MD4158					3
FA229		FA229V	FA229HH	MD4158						4
FA231		FA231V	FA231HH		MD4158					5
FA158*			FA158HH*	MD4158						6
FA158*			FA158HH*		MD4158					7
FA229		FA229V	FA229HH	MD4158						8
FA231		FA231V	FA231HH		MD4158					9
FA158*			FA158HH*	MD4158	MD4158					10
FA158*			FA158HH*	MD4158	MD4158					11
FA158*			FA158HH*	MD4158	MD4158					12
FA158*			FA158HH*	MD4158	MD4158					13
										14
S603										15
SFA083	SFAC083		SFA083HH							16
SFA083	SFAC083		SFA083HH							17
S632										18
S624										19
SFA083	SFAC083		SFA083HH							20
SFA083	SFAC083		SFA083HH							21
S603										22
SFA193	SFAC193		SFA193HH	MD937D						23
SFA193	SFAC193		SFA193HH	MD938D				VR938		24
SFA193	SFAC193		SFA193HH	MD938D				VR938		25
SFA115	SFAC115		SFA115HH	MD938D				VR938		26
S632										27
SFA396			SFA396HH							28
S632										29
S614										30
S624										31
SFA083	SFAC083		SFA083HH							32
SFA083	SFAC083		SFA083HH							33
S613										34
S614										35
H301			H301G							36
S603										37
S603										38
S614										39
S601										40
S604										41
FA039										42
S613			S613G							43
None										44
S614*			S614G*							45
S614*			S614G*							46
FA067										47
FA067				MD3010LS						48
FA067										49
S603			S603G							50
S604			S604G							51
FA115			FA115R							52
SFA396			SFA396HH	MD911D				VR911		53
S617										54
S603			S603G							55
S603			S603G							56
S617			S617G							57
SFA115			SFA115HH	MD938D				VR938		58

*-2 Sets Required. † For Vee disc colours add RED, BLU, GRN, GLD, ORG suffix to part number. For Custom Finish Options for Vee-Rotors™ including Splatter discs add suffix CHR, CHGR, CHBL, CHBR - available in various colours see page iv. Ⓢ - Also available as a Vintage Motorcycle Disc.

JAPANESE Built Motorcycles

Line #	BRAKE DISC CHOICES - FRONT						DISC PAD CHOICES - REAR				BRAKE DISC CHOICES - REAR			
	OverSize 250 /280mm Disc Kit	OSX OverSize 250/280mm Disc Kit	Relocating Bracket for 250/ 280mm Disc	OverSize 320mm Disc Kit	SMX OverSize 320mm Disc Kit	Relocating Bracket for 320mm Disc	FA, SFA, TT Pad or Brake Shoe	SFAC Carbon Scooter Pads	Speciality Pads - SXR / Vee / MXS	Sintered/ HH Pads/ Grooved Shoes	Standard Replacement Disc	Contour Disc Rear fitment	Vee Discs CONTOUR	CX Extreme MX Race Disc
1							FA231		FA231/2V	FA231HH	MD4146			
2														
3							FA231		FA231/2V	FA231HH				
4							FA231		FA231/2V	FA231HH				
5														
6							FA231		FA231/2V	FA231HH				
7														
8							FA231		FA231/2V	FA231HH				
9														
10							FA231		FA231/2V	FA231HH				
11							FA231		FA231/2V	FA231HH				
12							FA231		FA231/2V	FA231HH				
13							FA231		FA231/2V	FA231HH				
14														
15														
16							S603							
17							S632							
18							S632							
19							S632							
20							S624							
21							S624							
22							S624							
23							S603							
24							S624							
25							S624							
26														
27							SFA115	SFAC115		SFA115HH	MD940D		VR940	
28							SFA115	SFAC115		SFA115HH	MD940D		VR940	
29							S624							
30														
31							S624							
32							S613							
33							S624							
34							S631							
35							S632							
36							S613							
37							S614							
38							H301							
39							S603							
40							S603							
41							S614							
42							S601							
43							S604							
44							S603							
45							S613		S613G					
46							S613		S613G					
47							S604		S604G					
48							S604		S604G					
49							S604							
50							S604							
51							S601							
52							S603		S603G					
53							S604		S604G					
54							FA115		FA115R					
55							897							
56							S601							
57							S603		S603G					
58							S604		S604G					
59							S601							
60							S624							

REAR / ARRIÈRE / HINTEN / POSTERIOR / POSTERIORE

R Suffix = High Durability Sintered Pad. **HH** Suffix = High Performance Sintered Pad. **TT** Suffix = Hard Wearing Off Road Pad. **V** Suffix = Semi Sintered Pad. **G** Suffix = Grooved Shoe.
D Suffix = Drilled Disc. **X** Suffix = Universal Left or Right Disc. **XC** Suffix = Contoured Disc. **LS** Suffix = Left/Steel Disc. **RS** = Right/Steel Disc.

*-2 Sets Required. † For Vee disc colours add RED, BLU, GRN, GLD, ORG suffix to part number. For Custom Finish Options for Vee-Rotors™ including Splatter discs add suffix CHR, CHGR, CHBL, CHBR - available in various colours see page iv. ☉ - Also available as a Vintage Motorcycle Disc.

BRAKE APPLICATIONS

JAPANESE Built Motorcycles



SUZUKI Contd.



DISC PAD CHOICES - FRONT

BRAKE DISC CHOICES - FRONT

FA, SFA, TT Pad or Brake Shoe	SFAC Carbon Scooter Pads	Speciality Pads - SXR / Vee / MXS	Sintered/HH Pads/ Grooved Shoes	Left / Gauche / Links Standard Replacement Disc	Right / Droite / Rechts Standard Replacement Disc	Contour Disc Universal left and right fitment	Custom Disc Universal left and right fitment	Vee-Disks Black † See note below	CX Extreme MX Race Disc/ UTVX Disc
UR 50 W/Y/K1/K2/K3 (CA1MA/B) Verde			S632						
UX 50 WX/WY Zillion			SFA193		SFA193HH	MD938D		VR938	
X5K3/BK3/DK3/DBK3 (CZ41A) Choinori			S632						
ZR 50 KEN/KEK X1			FA039						
ZR 50 SLKX			FA067		FA067HH				
ZR 50 SKX/SKE/SKH			FA067		FA067HH				
RM 60 K3			K715		K715G				
RM 65 K3/K4/K5			FA302TT		FA302R	MD6166D			MD6166CX
DR-Z 70 K8/K9/L0/L2/L4/L5/L6/L7			H301						
FR 70			S603						
AH 80 Address			SFA083	SFAC083	SFA083HH	MD939D			
CP 80 CHF			S624						
CS 80 CD			S601						
DS 80 T/X/Z/D/F/G/H/J/K/L/MN/P/R/S/T/V/W/X/Y			S604		S604G				
FR 80 M/B/N/X/Z/D			S603						
JR 80 K1/K2/K3/K4/K5/K6/K7			S604		S604G				
LT 80 L/M/N/P/R/S/T/V/W/X/Y/K1-K6			S614*		S614G*				
RM 80 B/C/N			S603		S603G				
RM 80 XT/XX			S604		S604G				
RM 80 XZ/XD/XE/XF			S615						
RM 80 HD/HF			S602		S602G				
RM 80 XG/XH/XJ/XK (RC12A)			FA083TT		FA083R	MD6018D	MD6018C		
RM 80 XL/XM/XN/XP/XR/XS (RC12A)			FA083TT		FA083R	MD6018D	MD6018C		
RM 80 T/V/W/X/Y/K1			FA230TT		FA230R	MD6018D	MD6018C		
RM 85 K2/LK2/K3/LK3/K4/LK4			FA230TT		FA230R	MD6018D	MD6018C		
RM 85 (Small Wheel F 17 Inch/R 14 Inch)			FA258TT		FA258R	MD6030D	MD6030C		MD6030CX
RM 85 (Big Wheel F 19 Inch/R 16 Inch)			FA258TT		FA258R	MD6030D	MD6030C		MD6030CX
FB 90 K1 (BD42A)			S602						
LT-Z 90 K7/K8/K9/L0/L4/L5/L6/L7 QuadSport			S604*		S604G*				
TS 90 R/J			S603		S603G				
ASS 100			S602						
ACC 100			S602						
A 100 All Models			S603						
AH 100 Address			SFA083	SFAC083	SFA083HH	MD939D			
AH 100 P Address (CE12A)			SFA083	SFAC083	SFA083HH	MD912D			
GP 100 C/N/X/DED			FA046						
GP 100 UN/UX/UD/UL			S602						
RM 100 A/B/C			S603		S603G				
RM 100 N/T/X			S603		S603G				
RM 100 K3			FA258TT		FA258R	MD6186D	MD6186C		MD6186CX
TS 100 K/L/M			S603		S603G				
TS 100 A/B/C/ERN/ERT/ERX			S602		S602G				
TS 100 ERZ/ERH			S602		S602G				
DR-Z 110 K3/K4/K5			K715		K715G				
110cc Smash			S603						
FX 110 Shogun			S603						
UG 110 W/SW/Y/SY/SK1 Hokuto/Address			SFA652			MD911D		VR911	
UK 110 L5/L6/L7/L8 Address			SFA396		SFA396HH				
UK 110 L5/L6/L7/L8 Address			SFA652						
Shogun-R FD-112			FA197		FA197HH				
B 120			S602						
AN 125 S/T/V/W/X			SFA396		SFA396HH	MD911D		VR911	
AN 125 HKK5			SFA083/2		SFA083/2HH	MD911D		VR911	
CS 125 D			S603						
DF 125			FA054TT	MXS054	FA054R	MD6073D			
DR 125 SZ/SD/SE			S602		S602G				
DR 125 SF/SH/SJ			FA054TT	MXS054	FA054R	MD6073D			
DR 125 SEX/SEY			FA054TT	MXS054	FA054R	MD6073D			
DR 125 SMK8/SMK9/SMLO			FA185TT	MXS185	FA185R	MD6017D	MD6017C		MD6017CX
DR-Z 125 K3/K4/K5/K6/K7/K8/K9/L0-L5			S604						

FRONT / AVANT / VORN / FRENTE / ANTERIORE

Line #

R Suffix = High Durability Sintered Pad. HH Suffix = High Performance Sintered Pad. TT Suffix = Hard Wearing Off Road Pad. V Suffix = Semi Sintered Pad. G Suffix = Grooved Shoe.

D Suffix = Drilled Disc. X Suffix = Universal Left or Right Disc. XG Suffix = Contoured Disc. LS Suffix = Left/Steel Disc. RS = Right/Steel Disc.

*-2 Sets Required. † For Vee disc colours add RED, BLU, GRN, GLD, ORG suffix to part number. For Custom Finish Options for Vee-Rotors™ including Splatter discs add suffix CHR, CHGR, CHBL, CHBR - available in various colours see page iv. ☼ - Also available as a Vintage Motorcycle Disc.

JAPANESE Built Motorcycles

Line #	BRAKE DISC CHOICES - FRONT						DISC PAD CHOICES - REAR				BRAKE DISC CHOICES - REAR			
	OverSize 250 /280mm Disc Kit	OSX OverSize 250/280mm Disc Kit	Relocating Bracket for 250/ 280mm Disc	OverSize 320mm Disc Kit	SMX OverSize 320mm Disc Kit	Relocating Bracket for 320mm Disc	FA, SFA, TT Pad or Brake Shoe	SFAC Carbon Scooter Pads	Speciality Pads - SXR / Vee / MXS	Sintered/ HH Pads/ Grooved Shoes	Standard Replacement Disc	Contour Disc Rear fitment	Vee Discs CONTOUR	CX Extreme MX Race Disc
1							S624							
2							S624							
3							S632							
4							S603							
5							S604							
6							S604							
7							K715		K715G					
8							FA054TT		FA054R	MD6166D			MD6166CX	
9							H301							
10							S603							
11							S624							
12							S624							
13							S601							
14							S604		S604G					
15							S603							
16							S604		S604G					
17							S618		S618G					
18							S603		S603G					
19							S604		S604G					
20							Y502		Y502G					
21							S604		S604G					
22							Y502		Y502G					
23							FA083TT		FA083R	MD6025D	MD6025C			
24	OS6018C	OSX6018	BRK001				FA083TT		FA083R	MD6025D	MD6025C			
25	OS6018C	OSX6018	BRK001				FA083TT		FA083R	MD6025D	MD6025C			
26	OSS6030C	OSXS6030	BRK029				FA401TT		FA401R	MD6246D	MD6246C		MD6246CX	
27	OSS6030C	OSXS6030	BRK029				FA401TT		FA401R	MD6246D	MD6246C		MD6246CX	
28							S602							
29							S618		S618G					
30							S602		S602G					
31							S603							
32							S602							
33							S603							
34							S624							
35							S624							
36							S603							
37							S603							
38							S602		S602G					
39							S617		S617G					
40	OS6186C	OSX6186	BRK025				FA084TT		FA084R	MD6187D	MD6187C		MD6187CX	
41							S602		S602G					
42							S602		S602G					
43							S604		S604G					
44							S603		S603G					
45							S603							
46							S603							
47							897							
48							S624							
49							S624							
50							S603							
51							S602							
52							S624							
53							S624							
54							S603							
55							S602							
56							S602		S602G					
57							S602		S602G					
58							S602		S602G					
59							FA131TT	MXS131	FA131R	MD6014D	MD6014C		MD6014CX	
60							S604							

REAR / ARRIÈRE / HINTEN / POSTERIOR / POSTERIORE

R Suffix = High Durability Sintered Pad. **HH** Suffix = High Performance Sintered Pad. **TT** Suffix = Hard Wearing Off Road Pad. **V** Suffix = Semi Sintered Pad. **G** Suffix = Grooved Shoe.
D Suffix = Drilled Disc. **X** Suffix = Universal Left or Right Disc. **XC** Suffix = Contoured Disc. **LS** Suffix = Left/Steel Disc. **RS** = Right/Steel Disc.

*-2 Sets Required. † For Vee disc colours add RED, BLU, GRN, GLD, ORG suffix to part number. For Custom Finish Options for Vee-Rotors™ including Splatter discs add suffix CHR, CHGR, CHBL, CHBR - available in various colours see page iv. ☉ - Also available as a Vintage Motorcycle Disc.

BRAKE APPLICATIONS

JAPANESE Built Motorcycles



SUZUKI Contd.



DISC PAD CHOICES - FRONT

BRAKE DISC CHOICES - FRONT

FA, SFA, TT Pad or Brake Shoe	SFAC Carbon Scooter Pads	Speciality Pads - SXR / Vee / MXS	Sintered/HH Pads/ Grooved Shoes	Left / Gauche / Links Standard Replacement Disc	Right / Droite / Rechts Standard Replacement Disc	Contour Disc Universal left and right fitment	Custom Disc Universal left and right fitment	Vee-Discs Black † See note below	CX Extreme MX Race Disc/ UTVX Disc
DR-Z 125 L			FA230R	MD6212D					
EN 125-2			FA135TT						
EN 125-2A			FA135TT						
FL 125 SDWK7/SDWK8 Address/Underbone			SFA197	SFA197HH	MD9120D				
FX 125			FA197	FA197HH					
GN 125 R/V/W/X/Y/K1 (NF41A)			FA067	FA067HH					
GN 125 ER/EV/EW/EX/EY/EK1 (NF41A)			FA067	FA067HH					
GN 125 Z/D/K (NF41A/Cast wheel/Aisin Caliper)			FA093						
GN 125 HS (LC6PCJB1/Chinese production)			FA067	FA067HH					
GP 125 C/N/X/D			FA056						
GS 125 Z/D			S602						
GS 125 ESZ			FA067	FA067HH					
GS 125 ESD/ESF/ESK/ESM			FA093						
GS 125 ESR/ESX			FA067	FA067HH					
G SX-R 125		FA715V	FA715HH		MD3110	MD3110C			
G SX-S 125		FA715V	FA715HH		MD3110	MD3110C			
GT 125 L/M/A/B			FA055						
GT 125 C/EC/EN		FA038V							
GX 125 (SJ 125)			FA093						
GZ 125 W/X/Y/K1-K9 Marauder		FA106V							
LT 125 D		None							
LT 125 E		None							
LT 125 F/G/H		None							
RG 125 CG/CH/J (NF12A)									
(Gamma/Rear Drum Brake Model)				MD3048LS					
RG 125 UCG/UCH/UCJ/J/BUJ (NF12B)									
(Gamma/Rear Drum Model)				MD3048LS					
RG 125 FN/FP/FR Gamma (NF13A/Rear Disc Model)			FA158	FA158HH	MD3045				
RG 125 FUV/FUP/FUR Gamma (NF13B/Rear Disc Model)			FA158	FA158HH	MD3045				
RG 125 UN Wolf (NF13E/Naked)			FA129	FA129HH	MD3045				
RM 125 M/A/B/C			S602	S602G					
RM 125 N/T			S602	S602G					
RM 125 X/Z/D			S602	S602G					
RM 125 E			S622	S622G					
RM 125 F/G			FA106TT	FA106R	MD6163D				
RM 125 H			FA135TT	FA135R	MD6163D				
RM 125 J			FA135TT	MXS135	FA135R	MD6163D			
RM 125 K/L/M		MXS135	FA135TT	MXS135	FA135R	MD6017D	MD6017C		MD6017CX
RM 125 N/P/R/S (RF14A)		MXS135	FA135TT	MXS135	FA135R	MD6017D	MD6017C		MD6017CX
RM 125 T/V/W		MXS185	FA185TT	MXS185	FA185R	MD6017D	MD6017C		MD6017CX
RM 125 X/Y/K1/K2/K3/K4/K5		MXS185	FA185TT	MXS185	FA185R	MD6017D	MD6017C		MD6017CX
RM 125 K6/K7/K8/K9		MXS185	FA185TT	MXS185	FA185R	MD6017D	MD6017C		MD6017CX
RM 125 XCK8		MXS185	FA185TT	MXS185	FA185R	MD6017D	MD6017C		MD6017CX
RV 125 K			S603	S603G					
RV 125 L/M/A			S602	S602G					
RV 125 K2-K9/L0/L3/L4/L5/L6/L7/L8 Van-Van			FA231	FA231HH	MD6281D				
T 125/125 II/125 R Stinger			S602						
TF 125 Farm Bike (All models)			S602	S602G					
TS 125 K			S603	S603G					
TS 125 L/M/A/B/C/CZ/ERN/ERT/ERX			S602	S602G					
TS 125 ERZ			S602	S602G					
TS 125 N			S602	S602G					
TS 125 XE			S602	S602G					
TS 125 XUF/XUG/XUH/XUJ		MXS054	FA054TT	FA054R	MD6073D				
TS 125 RK/RL/RM/RN/RR (SF15A)		MXS135	FA135TT	FA135R	MD6109D				
TU 125 XXTUX/XTX			FA067	FA067HH					
UC 125 XY Epicuro			SFA396	SFA396HH	MD934D				
UE 125 CTK1		SFAC083	SFA083	SFA083HH	MD911D			VR911	
UH 125 K2/K3/K4/K5/K6 Burgman		SFAC181	SFA181	SFA181HH	MD976D			VR976	
UH 125 K2/K3/K4/K5/K6 Burgman - Parking Brake			S602						

FRONT / AVANT / VORN / FRENTE / ANTERIORE

Line #

R Suffix = High Durability Sintered Pad. HH Suffix = High Performance Sintered Pad. TT Suffix = Hard Wearing Off Road Pad. V Suffix = Semi Sintered Pad. G Suffix = Grooved Shoe.

D Suffix = Drilled Disc. X Suffix = Universal Left or Right Disc. XC Suffix = Contoured Disc. LS Suffix = Left/Steel Disc. RS = Right/Steel Disc.

*-2 Sets Required. † For Vee disc colours add RED, BLU, GRN, GLD, ORG suffix to part number. For Custom Finish Options for Vee-Rotors™ including Splatter discs add suffix CHR, CHGR, CHBL, CHBR - available in various colours see page iv. ☼ - Also available as a Vintage Motorcycle Disc.

JAPANESE Built Motorcycles

Line #	BRAKE DISC CHOICES - FRONT						DISC PAD CHOICES - REAR				BRAKE DISC CHOICES - REAR			
	Oversize 250 /280mm Disc Kit	OSX Oversize 250/280mm Disc Kit	Relocating Bracket for 250/ 280mm Disc	Oversize 320mm Disc Kit	SMX Oversize 320mm Disc Kit	Relocating Bracket for 320mm Disc	FA, SFA, TT Pad or Brake Shoe	SFAC Carbon Scooter Pads	Speciality Pads - SXR / Vee / MXS	Sintered/ HH Pads/ Grooved Shoes	Standard Replacement Disc	Contour Disc Rear fitment	Vee Discs CONTOUR	CX Extreme MX Race Disc
1							S604							
2							S602							
3							S602							
4							H353							
5							S603							
6							S602							
7							S602							
8							S602							
9							S602							
10							S602							
11							S602							
12							S602							
13							S602							
14							S602							
15							FA629		FA629HH	MD3111	MD3111C			
16							FA629		FA629HH	MD3111	MD3111C			
17							S602							
18							S602							
19							S602							
20							S602							
21							S621		S621G					
22							S605		S605G					
23							S621		S621G					
24														
25							S602							
26														
27							S602							
28							FA157			MD3059				
29							FA157			MD3059				
30							FA157			MD3059				
31							S602		S602G					
32							S617		S617G					
33							S616		S616G					
34							S616		S616G					
35							S616		S616G					
36							S616		S616G					
37								MXS084/3	FA084/3R	MD6014D	MD6014C			
38	OS6017EC	OSX6017E	BRK031				FA152TT	MXS152	FA152R	MD6014D	MD6014C		MD6014CX	
39	OS6017EC	OSX6017E	BRK031				FA152/2TT	MXS152	FA152/2R	MD6014D	MD6014C		MD6014CX	
40		OSX6017	BRK023		SMX6017	BRK024	FA131TT	MXS131	FA131R	MD6014D	MD6014C		MD6014CX	
41		OSX6017	BRK023		SMX6017	BRK024	FA131TT	MXS131	FA131R	MD6157D	MD6157C		MD6157CX	
42		OSX6017	BRK023		SMX6017	BRK024	FA131TT	MXS131	FA131R	MD6305D	MD6305C		MD6305CX	
43		OSX6017	BRK023		SMX6017	BRK024	FA131TT	MXS131	FA131R	MD6305D	MD6305C		MD6305CX	
44							S602		S602G					
45							S602		S602G					
46							S603							
47							S602							
48							S602		S602G					
49							S602		S602G					
50							S602		S602G					
51							S604		S604G					
52							S602		S602G					
53							S627							
54							S627							
55							FA152TT	MXS152	FA152R	MD6038D				
56							S602							
57							S635							
58							S624							
59							SFA266	SFAC266	SFA266HH	MD975D		VR975		
60														

REAR / ARRIÈRE / HINTEN / POSTERIOR / POSTERIORE

R Suffix = High Durability Sintered Pad. HH Suffix = High Performance Sintered Pad. TT Suffix = Hard Wearing Off Road Pad. V Suffix = Semi Sintered Pad. G Suffix = Grooved Shoe.
D Suffix = Drilled Disc. X Suffix = Universal Left or Right Disc. XC Suffix = Contoured Disc. LS Suffix = Left/Steel Disc. RS = Right/Steel Disc.

*-2 Sets Required. † For Vee disc colours add RED, BLU, GRN, GLD, ORG suffix to part number. For Custom Finish Options for Vee-Rotors™ including Splatter discs add suffix CHR, CHGR, CHBL, CHBR - available in various colours see page iv. ☉ - Also available as a Vintage Motorcycle Disc.

BRAKE APPLICATIONS

JAPANESE Built Motorcycles



SUZUKI Contd.



DISC PAD CHOICES - FRONT

BRAKE DISC CHOICES - FRONT

R Suffix = High Durability Sintered Pad. **HH** Suffix = High Performance Sintered Pad. **TT** Suffix = Hard Wearing Off Road Pad. **V** Suffix = Semi Sintered Pad. **G** Suffix = Grooved Shoe. **D** Suffix = Drilled Disc. **X** Suffix = Universal Left or Right Disc. **XC** Suffix = Contoured Disc. **LS** Suffix = Left/Steel Disc. **RS** = Right/Steel Disc.

UE 150 CTKI 01 SFA083 SFAC083 SFA083HH MD9117D VR9117

		DISC PAD CHOICES - FRONT				BRAKE DISC CHOICES - FRONT						Line #
		FA, SFA, TT Pad or Brake Shoe	SFAC Carbon Scooter Pads	Speciality Pads - SXR / Vee / MXS	Sintered/HH Pads/ Grooved Shoes	Left / Gauche / Links Standard Replacement Disc	Right / Droite / Rechts Standard Replacement Disc	Contour Disc Universal left and right fitment	Custom Disc Universal left and right fitment	Vee-Disks Black † See note below	CX Extreme MX Race Disc/ UTVX Disc	
UH 125 K7/K8/K9/L0/L1/L3 Burgman	07-13	SFA388	SFAC388		SFA388HH		MD9117D			VR9117		1
UH 125 L4/L5/L6 Burgman (Non ABS)	14-16	SFA197	SFAC197		SFA197HH							2
UH 125 AL4/AL5/AL6/AL7/AL8 Burgman (ABS)	14-21	SFA197	SFAC197		SFA197HH	MD9176D						3
UX 125 K8/K9/L0/L1 SIXteen	08-14	SFA388	SFAC388		SFA388HH		MD9142D					4
UZ 125 K5/GK5 (CF46A) (V 125 G)	05	SFA396			SFA396HH							5
VL 125 Y/K1-K7 Intruder	00-08	FA106TT										6
X4 125		FA067			FA067HH							7
GSX 150 L6 (Gixxer)	16-18	FA715		FA715V	FA715HH		TBA					8
GSX 150 (Gixxer)	16-18	FA715		FA715V	FA715HH		TBA					9
GSX-R 150	16-17	FA715		FA715V	FA715HH		TBA					10
GSX-S 150	16-17	FA715		FA715V	FA715HH			MD3110C				11
GSX-R 150	18-20	FA715		FA715V	FA715HH			MD3110C				12
GSX-S 150	18-20	FA715		FA715V	FA715HH			MD3110C				13
UE 150 CTKI	01	SFA083	SFAC083		SFA083HH		MD9117D			VR9117		14
UX 150 K8/K9/L0/L1 SIXteen	08-14	SFA388	SFAC388		SFA388HH		MD9142D					15
LT 160 EK/EL/EM/EN	89-92	S624			S624G							16
LT-F 160 L/M/N/P/R/S/T/V/W/X/Y/K1-K3	90-03	S624			S624G							17
LT 160 K3/K4 Quadsport	03-04	S624			S624G							18
PE 175 C/N	78-79	S602			S602G							19
PE 175 TX	80-81	S602			S602G							20
PE 175 Z	82	S618			S618G							21
GT 185 K	73											22
GT 185 L/M/A/B/C/EC	74-79	FA055										23
LT 185 E/F	84-85	None										24
TS 185 K	73	S603			S603G							25
TS 185 L/M/B/C/ERN/ERT/ERX	74-81	S602			S602G							26
DF 200 EV/EW/EY (SH42A)	98-00	FA054TT		MXS054	FA054R	MD6073D						27
DR 200 G/H/J	86-89	FA054TT		MXS054	FA054R	MD6073D						28
DR 200 SEP/SER/SES/SEV/SEW/SEX/SEY (SH42A) Djebel	93-00	FA054TT		MXS054	FA054R	MD6073D						29
DR 200 SEK1-SEK9	01-09	FA054TT		MXS054	FA054R	MD6073D						30
DR 200 SE Trojan	96-13	FA054TT		MXS054	FA054R	MD6073D						31
GT 200 EV/EX X5	79-82	FA038										32
RV 200 K2/K3	02-03	FA231			FA231HH		MD6281D					33
RV 200 L6/L7/L8/L9 Van-Van	16-19	FA231			FA231HH		MD6281D					34
SB 200 N/X	79-81	S605										35
SX 200 R/R-2/RJ/RM (SH41A)	90-91	FA054TT		MXS054	FA054R	MD6073D						36
TS 200 RK/RL/RM/RN/RP/RR	89-94	FA135TT		MXS135	FA135R	MD6109D						37
UH 200 K7/K8/K9/L0/L1/L3 Burgman	07-13	SFA388	SFAC388		SFA388HH		MD9117D			VR9117		38
UH 200 L4/L5/L6 Burgman (Non ABS)	14-16	SFA197	SFAC197		SFA197HH							39
UH 200 Burgman ABS	14-21	SFA197	SFAC197		SFA197HH	MD9176D						40
LT 230 GEF/GEG	85-86	S625*			S625G*							41
LT-F 230 G/H	86-87	S625*			S625G*							42
LT-F4WDX H/J/K/L/M/N/P/R/S/T/V/W	87-98	S633*			S633G*							43
250 SBK 2 (LX 250 L)	02	FA185TT		MXS185	FA185R	MD6240D		MD6240C				44
AN 250 W/X/Y Burgman/Skywave	98-02	SFA283/4	SFAC283/4		SFA283/4HH	MD929D				VR929		45
AN 250 K1/K2 Burgman/Skywave	01-02	SFA283/4	SFAC283/4		SFA283/4HH	MD929D				VR929		46
AN 250 K3-K6 Burgman (CJ43A)	03-06	SFA283/4	SFAC283/4		SFA283/4HH	MD994D				VR994		47
AN 250 Skywave Type M (BA-CJ45A)	Left	SFA228	SFAC228		SFA228HH	MD994D				VR994		48
	Right	SFA197	SFAC197		SFA197HH		MD994D			VR994		49
AN 250 Skywave Type S (BA-CJ44A)	Left	SFA228	SFAC228		SFA228HH	MD994D				VR994		50
	Right	SFA197	SFAC197		SFA197HH		MD994D			VR994		51
AN 250 8 Skywave SS	Left	SFA228	SFAC228		SFA228HH	MD994D				VR994		52
	Right	SFA197	SFAC197		SFA197HH		MD994D			VR994		53
DL 250 V-Strom ABS	18-21	FA226			FA226HH			MD3112C				54
DR 250 SL/SM/SN/SEP/SER/SES (SJ 44A)	90-95	FA135TT		MXS135	FA135R	MD6040D					MD6040CX	55
DR 250 RS/RLS/RT/RV/RLV/RLW/RW/RY (SJ45A/DOHC) 95-00	95-00	FA185TT		MXS185	FA185R	MD6017D		MD6017C			MD6017CX	56
DR 250 RXT/RXL/RXV/RXLV/RXW/RXLW/RXGW/RXGLW												57
/RXV/RXGY (Djebel 250 XC/GPS (SJ45A))	96-98	FA185TT		MXS185	FA185R	MD6017D		MD6017C			MD6017CX	58
DR-Z 250 K1-K7 (SJ 44 A)	01-07	FA185TT		MXS185	FA185R	MD6017D		MD6017C			MD6017CX	59
GN 250 F/J/M/R/T (NJ41A)	85-97	FA051				MD3014LS						60

*-2 Sets Required. † For Vee disc colours add RED, BLU, GRN, GLD, ORG suffix to part number. For Custom Finish Options for Vee-Rotors™ including Splatter discs add suffix CHR, CHGR, CHBL, CHBR - available in various colours see page iv. ☼ - Also available as a Vintage Motorcycle Disc.

JAPANESE Built Motorcycles

Line #	BRAKE DISC CHOICES - FRONT						DISC PAD CHOICES - REAR				BRAKE DISC CHOICES - REAR			
	Oversize 250 /280mm Disc Kit	OSX Oversize 250/280mm Disc Kit	Relocating Bracket for 250/ 280mm Disc	Oversize 320mm Disc Kit	SMX Oversize 320mm Disc Kit	Relocating Bracket for 320mm Disc	FA, SFA, TT Pad or Brake Shoe	SFAC Carbon Scooter Pads	Speciality Pads - SXR / Vee / MXS	Sintered/ HH Pads/ Grooved Shoes	Standard Replacement Disc	Contour Disc Rear fitment	Vee Discs CONTOUR	CX Extreme MX Race Disc
1							SFA413	SFAC413		SFA413HH	MD9117D		VR9117	
2							SFA413	SFAC413		SFA413HH				
3							SFA413	SFAC413		SFA413HH	MD9176D			
4							SFA307			SFA307HH	MD9142D			
5														
6							S602							
7							S602							
8							TBA							
9							TBA							
10							FA629			FA629HH	MD3111			
11							FA629			FA629HH	MD3111	MD3111C		
12							FA629			FA629HH	MD3111	MD3111C		
13							FA629			FA629HH	MD3111	MD3111C		
14							S624							
15							SFA307			SFA307HH	MD9142D			
16							S605			S605G				
17							S605			S605G				
18							S605			S605G				
19							S602			S602G				
20							S619			S619G				
21							S619			S619G				
22							S602							
23							S602							
24							S605			S605G				
25							S602			S602G				
26							S602			S602G				
27							S602			S602G				
28							S602			S602G				
29							S602			S602G				
30							S602			S602G				
31							S602			S602G				
32							S602							
33							S603							
34							S603							
35							S602							
36							S605			S605G				
37							FA152TT		MXS152	FA152R	MD6038D			
38							SFA413	SFAC413		SFA413HH	MD9117D		VR9117	
39							SFA413	SFAC413		SFA413HH				
40							SFA413	SFAC413		SFA413HH	MD9176D			
41							S605			S605G				
42							S605			S605G				
43							S634			S634G				
44		OSX6240	BRK023		SMX6240	BRK024	FA131TT		MXS131	FA131R	MD6105D			
45							SFA323/3			SFA323/3HH	MD930D	MD930C	VR930	
46							SFA411	SFAC411		SFA411HH	MD930D	MD930C	VR930	
47							SFA411	SFAC411		SFA411HH				
48							SFA412	SFAC412		SFA412HH	MD9109D		VR9109	
49														
50							SFA412	SFAC412		SFA412HH	MD9109D		VR9109	
51														
52							SFA412	SFAC412		SFA412HH	MD9109D		VR9109	
53														
54							FA496		FA496V	FA496HH		MD3113C		
55	OS6040C	OSX6040	BRK031				FA152TT		MXS152	FA152R	MD6038D			
56	OS6017C	OSX6017	BRK023		SMX6017	BRK024	FA152/2TT		MXS152	FA152/2R	MD6110D			
57														
58	OS6017C	OSX6017	BRK023		SMX6017	BRK024	FA152TT		MXS152	FA152R	MD6110D			
59	OS6017C	OSX6017	BRK023		SMX6017	BRK024	FA152/2TT		MXS152	FA152/2R	MD6110D			
60							S602							

REAR / ARRIÈRE / HINTEN / POSTERIOR / POSTERIORE

R Suffix = High Durability Sintered Pad. **HH** Suffix = High Performance Sintered Pad. **TT** Suffix = Hard Wearing Off Road Pad. **V** Suffix = Semi Sintered Pad. **G** Suffix = Grooved Shoe.
D Suffix = Drilled Disc. **X** Suffix = Universal Left or Right Disc. **XC** Suffix = Contoured Disc. **LS** Suffix = Left/Steel Disc. **RS** = Right/Steel Disc.

BRAKE APPLICATIONS

*-2 Sets Required. † For Vee disc colours add RED, BLU, GRN, GLD, ORG suffix to part number. For Custom Finish Options for Vee-Rotors™ including Splatter discs add suffix CHR, CHGR, CHBL, CHBR - available in various colours see page iv. Ⓢ - Also available as a Vintage Motorcycle Disc.

JAPANESE Built Motorcycles



SUZUKI Contd.



DISC PAD CHOICES - FRONT

BRAKE DISC CHOICES - FRONT

R Suffix = High Durability Sintered Pad. **HH** Suffix = High Performance Sintered Pad. **TT** Suffix = Hard Wearing Off Road Pad. **V** Suffix = Semi Sintered Pad. **G** Suffix = Grooved Shoe.

D Suffix = Drilled Disc. **X** Suffix = Universal Left or Right Disc. **XC** Suffix = Contoured Disc. **LS** Suffix = Left/Steel Disc. **RS** = Right/Steel Disc.

FRONT / AVANT / VORN / FRENTE / ANTERIORE

	FA, SFA, TT Pad or Brake Shoe	SFAC Carbon Scooter Pads	Speciality Pads - SXR / Vee / MXS	Sintered/HH Pads/ Grooved Shoes	Left / Gauche / Links Standard Replacement Disc	Right / Droite / Rechts Standard Replacement Disc	Contour Disc Universal left and right fitment	Custom Disc Universal left and right fitment	Vee-Disks Black † See note below	CX Extreme MX Race Disc/ UTVX Disc	Line #
GT 250 K/L/M/N/A/B/C	73-78	FA055									1
GT 250 EN/ET/EX X7	78-81	FA038	FA038V								2
GS 250 TT/TX	80-81	FA051			MD3014LS						3
GSF 250 N/ZM/P/NP/ZP/R/NR Bandit (GJ74A)	92-96	FA129		FA129HH	MD3006X		MD3006XC	MD3006CC	VR3006BLK†		4
GSF 250 VS/NT/VV/NZ/VV/VX/VY Bandit (GJ77A)	95-00	FA229		FA229HH	MD3006X		MD3006XC	MD3006CC	VR3006BLK†		5
GSX 250 ET/EX/EZ	80-82	FA051			MD3014LS						6
GSX 250 FL/FM/FN/FP/FR/FS/FT/FV/FW Across	90-98	FA129		FA129HH	MD3006X		MD3006XC	MD3006CC	VR3006BLK†		7
GSX 250 RCH/H (GJ72A)	87	FA103*		FA103HH*	MD3074	MD3074					8
GSX 250 SSM Katana (GJ76A)	91	FA129		FA129HH	MD3006X		MD3006XC	MD3006CC	VR3006BLK†		9
GSX 250 FXK2/K3/K4/K5 (ZR 250 C)	02-05	FA231		FA231HH		MD4008X	MD4008XC	MD4008CC	VR3006BLK†		10
GSX 250 RL7/RL8	17-18	FA226		FA226HH			MD3112C				11
GSXR 250 CJ (GJ72A)	88	FA103*		FA103HH*	MD3074	MD3074					12
GSXR 250 CK (GJ72A)	17-21	FA103*		FA103HH*	MD3074	MD3074					13
GSXR 250 RK (GJ73A)	89	FA158*		FA158HH*	MD3003X	MD3003X	MD3003XC*	MD3003CC*	VR3006BLK†		14
GW 250 L3/ZL5 Inazuma	13-15	FA142	FA142V	FA142HH	MD3105LS						15
GW 250 FL5 Inazuma	15	FA142	FA142V	FA142HH	MD3105LS						16
GZ 250 X/Y/K1	99-01	FA106TT	FA106V								17
GZ 250 K2-K8 Marauder	02-08	FA106TT	FA106V								18
LT 250 EFF/EFG	85-86	S625*		S625G*							19
LT 250 RH/RJ/RK/RL	87-90	FA128TT*		FA128R*	MD6020D	MD6020D					20
LT-F 250 J/K/L/M/N/P/R/S/T/V/W/X/Y/K1	88-01	S628*		S628G*							21
LT-F 250 FX/FY/FK1/FK2	99-02	S628*		S628G*							22
LT-F 250 K2/K3/K4/K5/K6/K7/K8/K9/L2/L3/L4 Ozark	02-14	FA054TT*		FA054R*	MD6207D	MD6207D					23
LT-Z 250 K4/K5/K6/K7/K8/K9/L0 Quadport	04-12	FA084TT*	MXS084*	FA084R*	MD6210D	MD6210D					24
LT-F4WD H/J/K/L/M/N/P/S/T/V/W	87-98	S628*		S628G*							25
PE 250 B/C/N	77-79	S605		S605G							26
PE 250 T/X/Z	80-82	S605		S605G							27
RL 250 L/M	74-75	S603		S603G							28
RL 250 Beamish Model Reed Valve Engine	78-82	S603		S603G							29
RM 250 A/B/C	76-78	S602		S602G							30
RM 250 N	79	S605		S605G							31
RM 250 T	80	S618		S618G							32
RM 250 X/Z	81-82	S621		S621G							33
RM 250 D	83	S622		S622G							34
RM 250 E	84	S622		S622G							35
RM 250 F/G	85-86	FA106TT		FA106R	MD6163D						36
RM 250 H/J	87-88	FA135TT	MXS135	FA135R	MD6163D						37
RM 250 K/L/M	89-91	FA135TT	MXS135	FA135R	MD6017D		MD6017C			MD6017CX	38
RM 250 N/P/R/S (RJ16A)	92-95	FA135TT	MXS135	FA135R	MD6017D		MD6017C			MD6017CX	39
RM 250 T/V/W	96-98	FA185TT	MXS185	FA185R	MD6017D		MD6017C			MD6017CX	40
RM 250 X/Y/K1/K2/K3/K4/K5/K6/K7	99-05	FA185TT	MXS185	FA185R	MD6017D		MD6017C			MD6017CX	41
RM 250 K6/K7/K8/K9	06-12	FA185TT	MXS185	FA185R	MD6017D		MD6017C			MD6017CX	42
RM 250 XCK8	09	FA185TT	MXS185	FA185R	MD6017D		MD6017C			MD6017CX	43
RMX 250 K/M/N/P	89-93	FA135TT	MXS135	FA135R	MD6017D		MD6017C			MD6017CX	44
RMX 250 R/S	94-95	FA135TT	MXS135	FA135R	MD6017D		MD6017C			MD6017CX	45
RMX 250 T/V/W	96-98	FA185TT	MXS185	FA185R	MD6017D		MD6017C			MD6017CX	46
RMX 250 ST/SV/SW/SX (SJ14A)	96-99	FA185TT	MXS185	FA185R	MD6017D		MD6017C			MD6017CX	47
RMX 250 SN/SR/SS (SJ13A)	95-97	FA135TT	MXS135	FA135R	MD6017D		MD6017C			MD6017CX	48
RMZ 250 K4/K5/K6	04-06	FA185TT	MXS185	FA185R	MD6213D		MD6213C			MD6213CX	49
♦ Plain undrilled disc for enduro use MD6208CE											50
RMZ 250 K7	07	FA185TT	MXS185	FA185R	MD6254D		MD6254C			MD6254CX	51
♦ Plain undrilled disc for enduro use MD6255CE											52
RM-Z 250	08-18	FA185TT	MXS185	FA185R			MD6254C			MD6254CX	53
♦ Plain undrilled disc for enduro use MD6255CE											54
RM-Z 250 270mm F/Disc, 240mm R/Disc	19-21	FA185TT	MXS185	FA185R						MD6422CX	55
♦ Plain undrilled disc for enduro use MD6255CE											56
RG 250 WD Gamma	83	FA063		FA063HH	MD3014LS						57
RG 250 WE	84	FA102			MD3014LS						58
RG 250 FG/CH/FCH/FH Gamma (GJ21B)	85-88	FA102*									59
RGV 250 J	88	FA158*		FA158HH*	MD3003X	MD3003X	MD3003XC*	MD3003CC*	VR3003BLK†		60

*-2 Sets Required. † For Vee disc colours add RED, BLU, GRN, GLD, ORG suffix to part number. For Custom Finish Options for Vee-Rotors™ including Splatter discs add suffix CHR, CHGR, CHBL, CHBR - available in various colours see page iv. ☉ - Also available as a Vintage Motorcycle Disc.

JAPANESE Built Motorcycles

Line #	BRAKE DISC CHOICES - FRONT						DISC PAD CHOICES - REAR				BRAKE DISC CHOICES - REAR			
	OverSize 250 /280mm Disc Kit	OSX OverSize 250/280mm Disc Kit	Relocating Bracket for 250/ 280mm Disc	OverSize 320mm Disc Kit	SMX OverSize 320mm Disc Kit	Relocating Bracket for 320mm Disc	FA, SFA, TT Pad or Brake Shoe	SFAC Carbon Scooter Pads	Speciality Pads - SXR / Vee / MXS	Sintered/ HH Pads/ Grooved Shoes	Standard Replacement Disc	Contour Disc Rear fitment	Vee Discs CONTOUR	CX Extreme MX Race Disc
1							S609							
2							S606							
3							S606							
4							FA063		FA063V	FA063HH	MD3002	MD3002C	VR3002	
5							FA063		FA063V	FA063HH	MD3084			
6							S606							
7							FA063		FA063V	FA063HH	MD3002	MD3002C	VR3002	
8							FA063		FA063V	FA063HH	MD3064			
9							FA063		FA063V	FA063HH	MD3002	MD3002C	VR3002	
10							FA067			FA067HH	MD4051	MD4051C	VR4015	
11							FA496		FA496V	FA496HH		MD3113C		
12							FA063		FA063V	FA063HH	MD3081			
13							FA063			FA063HH	MD3081			
14							FA063		FA063V	FA063HH				
15							FA496		FA496V	FA496HH	MD3093			
16							FA496		FA496V	FA496HH	MD3093			
17							S602							
18							S602							
19							S634			S634G				
20							FA137TT			FA137R	MD6021D			
21							S629			S629G				
22							S629			S629G				
23							S636			S636G				
24							S636			S636G				
25							S629			S629G				
26							S605			S605G				
27							S605			S605G				
28							S602			S602G				
29							S602			S602G				
30							S605			S605G				
31							S620			S620G				
32							S620			S620G				
33							S616			S616G				
34							S616			S616G				
35							S602			S602G				
36							S602			S602G				
37														
38	OS6017C	OSX6017E	BRK031				FA152TT		MXS084/3	FA084/3R	MD6014D			
39	OS6017C	OSX6017E	BRK031				FA152/2TT		MXS152	FA152R	MD6014D	MD6014C		MD6014CX
40	OS6017C	OSX6017	BRK023				FA131TT		MXS131	FA131R	MD6014D	MD6014C		MD6014CX
41	OS6017C	OSX6017	BRK023				FA131TT		MXS131	FA131R	MD6157D	MD6157C		MD6157CX
42	OS6017C	OSX6017	BRK023				FA131TT		MXS131	FA131R	MD6305D	MD6305C		MD6305CX
43	OS6017C	OSX6017	BRK023				FA131TT		MXS131	FA131R	MD6305D	MD6305C		MD6305CX
44	OS6017C	OSX6017	BRK023				FA131TT		MXS131	FA131R	MD6305D	MD6305C		MD6305CX
45	OS6017C	OSX6017	BRK023				FA152TT		MXS152	FA152R	MD6014D	MD6014C		MD6014CX
46	OS6017C	OSX6017	BRK023				FA152/2TT		MXS152	FA152/2R	MD6014D	MD6014C		MD6014CX
47	OS6017C	OSX6017	BRK023				FA152TT		MXS152	FA152R	MD6014D	MD6014C		MD6014CX
48	OS6017C	OSX6017	BRK023				FA131TT		MXS131	FA131R	MD6014D	MD6014C		MD6014CX
49	OS6017C	OSX6017	BRK031				FA152/2TT		MXS152	FA152/2R	MD6014D	MD6014C		MD6014CX
50	OS6213C	OSX6213	BRK023	SM6213C	SMX6213	BRK024	FA367TT		MXS367	FA367R	MD6208D	MD6208C		MD6208CX
51		OSX6254	BRK023		SMX6254	BRK024	FA367TT		MXS367	FA367R	MD6255D	MD6255C		MD6255CX
52		OSX6254	BRK023		SMX6254	BRK024	FA367TT		MXS367	FA367R		MD6255C		MD6255CX
53		OSX6254	BRK023		SMX6254	BRK024	FA367TT		MXS367	FA367R		MD6255C		MD6255CX
54		OSX6254	BRK023		SMX6254	BRK024	FA367TT		MXS367	FA367R		MD6255C		MD6255CX
55		OSX6254	BRK023		SMX6254	BRK024	FA367TT		MXS367	FA367R		MD6255C		MD6255CX
56														
57							FA063		FA063V	FA063HH	MD3064			
58							FA063		FA063V		MD3064			
59							FA063		FA063V		MD3064			
60							FA063		FA063V	FA063HH	MD3081			

REAR / ARRIÈRE / HINTEN / POSTERIOR / POSTERIORE

*-2 Sets Required. † For Vee disc colours add RED, BLU, GRN, GLD, ORG suffix to part number. For Custom Finish Options for Vee-Rotors™ including Splatter discs add suffix CHR, CHGR, CHBL, CHBR - available in various colours see page iv. ⚙ - Also available as a Vintage Motorcycle Disc.

Part numbers, prefixes, suffixes, photos and illustrations shown in this catalogue are trademarks and/or copyrights of EBC Brakes or the trademark owner A C Freeman Investments Ltd and use without express written permission of the owners is punishable by law.

R Suffix = High Durability Sintered Pad. **HH** Suffix = High Performance Sintered Pad. **TT** Suffix = Hard Wearing Off Road Pad. **V** Suffix = Semi Sintered Pad. **G** Suffix = Grooved Shoe.
D Suffix = Drilled Disc. **X** Suffix = Universal Left or Right Disc. **XC** Suffix = Contoured Disc. **LS** Suffix = Left/Steel Disc. **RS** = Right/Steel Disc.

JAPANESE Built Motorcycles



SUZUKI Contd.



DISC PAD CHOICES - FRONT

BRAKE DISC CHOICES - FRONT

FA, SFA, TT Pad or Brake Shoe	SFAC Carbon Scooter Pads	Speciality Pads - SXR / Vee / MXS	Sintered/HH Pads/ Grooved Shoes	Left / Gauche / Links Standard Replacement Disc	Right / Droite / Rechts Standard Replacement Disc	Contour Disc Universal left and right fitment	Custom Disc Universal left and right fitment	Vee-Disks Black † See note below	CX Extreme MX Race Disc/ UTVX Disc
RGV 250 K/L (VJ21A)			FA158H*	MD3003X	MD3003X	MD3003XC*	MD3003CC*	VR3003BLK*†	
RGV 250 M/N/P/R/S (VJ22A)			FA158*	MD3045	MD3045				
RGV 250 T (RGVR 250 SP VJ23A)			FA180*	MD3082LS	MD3082RS				
SW-1 (NJ45A)			FA129						
T 20 Super Six			S608						
T 250 I/R/J			S608						
TS 250 L/M/A/B/C/ERN/ERT/ERX			S605						
TS 250 XE/XG/XH/XJ/XK			FA054TT						
TU 250 S/T/XS/XT/X-ST/XSV/XT-W Volty (NJ47A 100001-115972)		MXS054	FA054R	MD6075D					
TU 250 XV/XW			FA106V						
TU 250 XTX/XXTY (NJ47A-115-) Volty			FA229						
TU 250 GY/GBK1 Grass Tracker Big Boy (NJ47A-117/123)			FA229						
TV 250 J/K/AK/L (VJ21A) Wolf			FA158			MD3007X	MD3007XC	VR3007BLK†	
VL 250 Y/K1/K5/K6/K7 Intruder			FA106TT						
VL 250 Y/K1/K5/K6/K7 Intruder			FA106V						
LT-F 300 J/K			S625*						
LT-F 300 FX/FY/FK1			S633*						
LT-F 300 FK2	Left		FA165TT						
	Right		FA135TT						
LT-F 4WD XH/J/K/L/M/N/P/R/S/T/V/W		MXS165	FA165R	MD6206D					
RL 325			S633*						
DR 350 SL/SM/SN/SP (4 Bolt Front Disc/Kick Start)			S603						
DR 350 SER/SES (Electric Start/4 Bolt Front Disc)			S603G						
DR 350 SET/SEV/SEW/SEX (Electric Start /4 Bolt Front Disc/UK/Europe)			FA135TT						
DR 350 SEW/SEX (Electric Start/6 Bolt Front Disc /USA Only)		MXS135	FA135R	MD6040D					MD6040CX
RL 350 Beamish Model Reed Valve Engine			FA135TT						MD6040CX
SG 350 N Goose			FA135TT						
T 350 1/2/R/J			FA135TT						
SP 370 C/N			S605						
GT 380 J			S608						
GT 380 K/L/M/A/B			FA055						
AN 400 XY Burgman			SFA283/4						
AN 400 K1/K2			SFA283/4						
AN 400 K3-K6			SFA283/4						
AN 400 K7/ZK7/K8/ZK8/K9/L0/L1/L2/L3/L4 Burgman /Skywave (Non ABS)	Left		SFA228						
	Right		SFA197						
AN 400 Burgman/Skywave (ABS)	Left		SFA228						
	Right		SFA197						
DR 400 ST/SX			S605						
DR-Z 400 SY/EY/Y/SEK1/EK1/K1/SK2/EK2/K2/K3/SK3/EK3 /K4/SK4/EK4/SK5/EK5/K5/EK5/EK6/SK6/K6/SK7 /EK7/K7/SK8			FA185TT						
DR-Z 400 SMK5/SMK6/SMK7/SMK8/SMK9			FA185TT						
GN 400 TT			FA051						
GS 400 B/C			FA035						
GS 400 LX			FA051						
GS 400 TX			FA051						
GSF 400 K/NK/Z/MM/VZM/P/NP/NP/VZP/VR Bandit (GK75A)			FA158*						
GSF 400 M/N/P Bandit			FA129						
GSF 400 S/V/S-V/VZ-V Bandit (GK7AA)			FA158*						
GSR 400 K6			FA158*						
G SX 400 ET/EX/EZ			FA051						
G SX 400 FW/FWS/FWS-2			FA063*						
G SX 400 R2 (GK 71B)			FA102*						
G SX 400 R3 (GK 71F)			FA103*						

FRONT / AVANT / VORN / FRENTE / ANTERIORE

Line #

R Suffix = High Durability Sintered Pad. HH Suffix = High Performance Sintered Pad. TT Suffix = Hard Wearing Off Road Pad. V Suffix = Semi Sintered Pad. G Suffix = Grooved Shoe. D Suffix = Drilled Disc. X Suffix = Universal Left or Right Disc. XC Suffix = Contoured Disc. LS Suffix = Left/Steel Disc. RS Suffix = Right/Steel Disc.

*-2 Sets Required. † For Vee disc colours add RED, BLU, GRN, GLD, ORG suffix to part number. For Custom Finish Options for Vee-Rotors™ including Splatter discs add suffix CHR, CHGR, CHBL, CHBR - available in various colours see page iv. ☉ - Also available as a Vintage Motorcycle Disc.

JAPANESE Built Motorcycles

Line #	BRAKE DISC CHOICES - FRONT						DISC PAD CHOICES - REAR				BRAKE DISC CHOICES - REAR			
	Oversize 250 /280mm Disc Kit	OSX Oversize 250/280mm Disc Kit	Relocating Bracket for 250/ 280mm Disc	Oversize 320mm Disc Kit	SMX Oversize 320mm Disc Kit	Relocating Bracket for 320mm Disc	FA, SFA, TT Pad or Brake Shoe	SFAC Carbon Scooter Pads	Speciality Pads - SXR / Vee / MXS	Sintered/ HH Pads/ Grooved Shoes	Standard Replacement Disc	Contour Disc Rear fitment	Vee Discs CONTOUR	CX Extreme MX Race Disc
1							FA063		FA063V	FA063HH	MD3081			
2							FA141				MD3059			
3							FA141				MD3059			
4							S606							
5							S609							
6							S609							
7							S605			S605G				
8							S627							
9														
10							S602							
11							S602							
12							S602							
13							S602							
14							FA063		FA063V	FA063HH	MD3081			
15							S602							
16							S602							
17							S634			S634G				
18							S634			S634G				
19							S634			S634G				
20														
21							S634			S634G				
22							S602			S602G				
23	OS6040C	OSX6040	BRK031				FA152TT		MXS152	FA152R	MD6038D			MD6038CX
24	OS6040C	OSX6040	BRK031				FA152TT		MXS152	FA152R	MD6038D			MD6038CX
25														
26	OS6040C	OSX6040	BRK031				FA152TT		MXS152	FA152R	MD6110D			MD6110CX
27														
28	OS6017C	OSX6017	BRK023		SMX6017	BRK024	FA152TT		MXS152	FA152R	MD6110D			MD6110CX
29														
30							FA063		FA063V	FA063HH	MD3081			
31							S609							
32							S605			S605G				
33							S609							
34							S609							
35							SFA323/3			SFA323/3HH	MD930D	MD930C	VR930	
36							SFA411	SFAC411		SFA411HH	MD930D	MD930C	VR930	
37							SFA411	SFAC411		SFA411HH				
38														
39														
40							SFA412	SFAC412		SFA412HH	MD9109D		VR9109	
41														
42							SFA412	SFAC412		SFA412HH	MD9109D		VR9109	
43							S605			S605G				
44														
45														
46	OS6017C	OSX6017	BRK023		SMX6017/1	BRK038	FA131TT		MXS131	FA131R	MD6014D	MD6014C		MD6014CX
47							FA131TT		MXS131	FA131R	MD6157D	MD6157C		
48							S606							
49							S609							
50							S606							
51							S609							
52														
53							FA063		FA063V	FA063HH	MD3002	MD3002C	VR3002	
54							FA063		FA063V	FA063HH	MD3002	MD3002C	VR3002	
55							FA063		FA063V	FA063HH	MD3084			
56							FA419		FA419V	FA419HH	MD3093	MD3093C	VR3093	
57							S606							
58							FA063		FA063V	FA063HH	MD3025			
59							FA063		FA063V		MD3064			
60							FA063		FA063V	FA063HH	MD3064			

REAR / ARRIÈRE / HINTEN / POSTERIOR / POSTERIORE

R Suffix = High Durability Sintered Pad. **HH** Suffix = High Performance Sintered Pad. **TT** Suffix = Hard Wearing Off Road Pad. **V** Suffix = Semi Sintered Pad. **G** Suffix = Grooved Shoe.
D Suffix = Drilled Disc. **X** Suffix = Universal Left or Right Disc. **XC** Suffix = Contoured Disc. **LS** Suffix = Left/Steel Disc. **RS** = Right/Steel Disc.

*-2 Sets Required. † For Vee disc colours add RED, BLU, GRN, GLD, ORG suffix to part number. For Custom Finish Options for Vee-Rotors™ including Splatter discs add suffix CHR, CHGR, CHBL, CHBR - available in various colours see page iv. Ⓢ - Also available as a Vintage Motorcycle Disc.

BRAKE APPLICATIONS

JAPANESE Built Motorcycles



SUZUKI Contd.



DISC PAD CHOICES - FRONT

BRAKE DISC CHOICES - FRONT

			FA, SFA, TT Pad or Brake Shoe	SFAC Carbon Scooter Pads	Speciality Pads - SXR / Vee / MXS	Sintered/HH Pads/ Grooved Shoes	Left / Gauche / Links Standard Replacement Disc	Right / Droite / Rechts Standard Replacement Disc	Contour Disc Universal left and right fitment	Custom Disc Universal left and right fitment	Vee-Discs Black † See note below	CX Extreme MX Race Disc/ UTVX Disc	Line #
GSX 400 FX/FZ/FD		81-83	FA067*			FA067HH*	MD3066LS	MD3066RS					1
GSX 400 FJ/FK/FAK/FL (GK74A)		88-90	FA146*			FA146HH*	MD3003X	MD3003X	MD3003XC*	MD3003CC*	VR3003BLK*†		2
GSX 400 X/XA/XS Impulse			FA103*			FA103HH*	MD3001	MD3001					3
GSX 400 SSN (GK77A) Katana		92	FA158*			FA158HH*	MD3003X	MD3003X	MD3003XC*	MD3003CC*	VR3003BLK*†		4
GSX 400 R/S/T/ZR/ZS/ZT (GK79A) Impulse Type S		94-96	FA142*		FA142V*	FA142HH*	MD3003X	MD3003X	MD3003XC*	MD3003CC*	VR3003BLK*†		5
GSX 400 X (GK79A) Impulse		99	FA244*			FA244HH*	MD3003X	MD3003X	MD3003XC*	MD3003CC*	VR3003BLK*†		6
GSX 400 FSV/FSK1 (GK7B) Inazuma		00	FA244*			FA244HH*	MD3003X	MD3003X	MD3003XC*	MD3003CC*	VR3003BLK*†		7
GSXR 400 H		87	FA103*			FA103HH*	MD3001	MD3001					8
GSXR 400 J/RR/RAK (GK73A)		88-90	FA158*			FA158HH*	MD3003X	MD3003X	MD3003XC*	MD3003CC*	VR3003BLK*†		9
GSXR 400 RL/RM/RN/RP/RS (GK76A)		90-95	FA145*			FA145HH*	MD3045	MD3045					10
LT-A 400 FK2-FK7 Eiger 4WD		02-07	FA054TT*		MXS054*	FA054R*	MD6195D	MD6195D					11
LT-A 400 K2/K3/K4 Eiger		02-04	FA054TT*		MXS054*	FA054R*	MD6195D	MD6195D					12
LT-A 400 FK8/FK9/FL0/FL1	Left	08-18	FA413TT			FA413R	MD6195D						13
King Quad Auto 4WD	Right		FA414TT			FA414R		MD6195D					14
LT-F 400 FK8/FK9/FL0/FL1	Left	08-18	FA413TT			FA413R	MD6195D						15
King Quad 4WD	Right		FA414TT			FA414R		MD6195D					16
LT-F 400 FK2/FK3/FK4/FK5/FK6/FK7 (Eiger 4WD)		02-07	FA054TT*		MXS054*	FA054R*	MD6195D	MD6195D					17
LT-F 400 K2-K7 Eiger		02-07	FA054TT*		MXS054*	FA054R*	MD6195D	MD6195D					18
LT-Z 400 K3/K4/K5/K6/K7/K8/K9/L0/L1/L2/L3		03-15	FA084TT*		MXS084*	FA084R*	MD6210D	MD6210D					19
PE 400 TX		79-81	S605			S605G							20
RF 400 RP/RR/VR/RT/RV/V (GK78A)		93-97	FA142*		FA142V*	FA142HH*	MD3003X	MD3003X	MD3003XC*	MD3003CC*	VR3003BLK*†		21
RG 400 EWF/EW-2G/EWH Walter Wolf (Type 1 & 2)		85-87	FA103*			FA103HH*	MD3070LS	MD3070RS					22
RM 400 C		78	S602			S602G							23
RM 400 N		79	S605			S605G							24
RM 400 T		80	S618			S618G							25
SP 400 T		80	S605			S605G							26
ST 400 V/W/X/Y/K1/K2/K3 Tempter		97-03											27
SV 400 N (VK53A)		98	FA231			FA231HH		MD3006X	MD3006XC		VR3006BLK†		28
SV 400 X/Y/K1/K2	Left	99-02	FA229		FA229V	FA229HH	MD3003X		MD3003XC	MD3003CC	VR3003BLK†		29
	Right		FA231		FA231V	FA231HH		MD3003X	MD3003XC	MD3003CC	VR3003BLK†		30
SV 400 K3/K4/K5	Left	03-05	FA229		FA229V	FA229HH	MD3090X		MD3090XC	MD3090CC	VR3090BLK†		31
	Right		FA231		FA231V	FA231HH		MD3090X	MD3090XC	MD3090CC	VR3090BLK†		32
SV 400 SN (VK53A)		98						MD3006X	MD3006XC	MD3006CC	VR3006BLK†		33
SV 400 SX/SY/SK1/SK2	Left	99-02	FA229		FA229V	FA229HH	MD3003X		MD3003XC	MD3003CC	VR3003BLK†		34
	Right		FA231		FA231V	FA231HH		MD3003X	MD3003XC	MD3003CC	VR3003BLK†		35
SV 400 SK3/SK4/SK5	Left	03-05	FA229		FA229V	FA229HH	MD3090X		MD3090XC	MD3090CC	VR3090BLK†		36
	Right		FA231		FA231V	FA231HH		MD3090X	MD3090XC	MD3090CC	VR3090BLK†		37
VS 400 VR/FR/VTR/FTR/V-T/F-T Intruder		94-	FA103			FA103HH		MD3032RS					38
GS 425 EN		79	FA035				MD3014LS						39
RM-X 450 ZL0/ZL2		10-15	FA185TT		MXS185	FA185R			MD6254C			MD6254CX	40
♦ Plain undrilled disc for enduro use MD6255CE													41
RM-Z 450 K5/K6/K7		05-07	FA185TT		MXS185	FA185R	MD6254D		MD6254C			MD6254CX	42
♦ Plain undrilled disc for enduro use MD6255CE													43
RM-Z 450		08-17	FA185TT		MXS185	FA185R	MD6254D		MD6254C			MD6254CX	44
♦ Plain undrilled disc for enduro use MD6255CE													45
RM-Z 450 260mm O/D F/Disc, 220mm O/D R/Disc		18-21	FA185TT		MXS185	FA185R	TBA		MD6422C			MD6422CX	46
GS 450 ET/EG/EJ		80-88	FA051				MD3014LS						47
LT-A 450 XK7/XK8/XK9	Left	07-10	FA413TT			FA413R	MD6261D						48
	Right		FA414TT			FA414R		MD6261D					49
LT-R 450 K6/K7/K8/K9/L0/L1	Left	06-12	FA165TT		MXS165	FA165R	MD6277D						50
	Right		FA135TT		MXS135	FA135R		MD6277D					51
RM 465 X/Z		81-82	S621			S621G							52
DR 500 X/Z/D		81-83	S602			S602G							53
DR 500 S/SA		84-88	S605			S605G							54
GS 500 EK/EL/EM/EN/EP/ER/ES (GM51A)		89-95	FA129			FA129HH		MD3006X	MD3006XC	MD3006CC	VR3006BLK†		55
GS 500 ET/EV/EW/EX/EY/K1/K2/K3		96-03	FA231			FA231HH		MD3006X	MD3006XC	MD3006CC	VR3006BLK†		56
GS 500 FK4/K4/FK5/K5/FK6/K6/FK7/K7/K8/FK8		04-08	FA231			FA231HH		MD3006X	MD3006XC	MD3006CC	VR3006BLK†		57
T 500 1/2/3/R/J/K/L/M		68-75	S612										58
GT 500 A/B		76-77	FA055					MD3019RS					59
RE 5 M/A		75-77	FA055*				MD3019LS	MD3019RS					60

FRONT / AVANT / VORN / FRENTE / ANTERIORE

R Suffix = High Durability Sintered Pad. HH Suffix = High Performance Sintered Pad. TT Suffix = Hard Wearing Off Road Pad. V Suffix = Semi Sintered Pad. G Suffix = Grooved Shoe.

D Suffix = Drilled Disc. X Suffix = Universal Left or Right Disc. XC Suffix = Contoured Disc. LS Suffix = Left/Steel Disc. RS = Right/Steel Disc.

*-2 Sets Required. † For Vee disc colours add RED, BLU, GRN, GLD, ORG suffix to part number. For Custom Finish Options for Vee-Rotors™ including Splatter discs add suffix CHR, CHGR, CHBL, CHBR - available in various colours see page iv. Ⓢ - Also available as a Vintage Motorcycle Disc.

JAPANESE Built Motorcycles

Line #	BRAKE DISC CHOICES - FRONT						DISC PAD CHOICES - REAR				BRAKE DISC CHOICES - REAR			
	OverSize 250 /280mm Disc Kit	OSX OverSize 250/280mm Disc Kit	Relocating Bracket for 250/ 280mm Disc	OverSize 320mm Disc Kit	SMX OverSize 320mm Disc Kit	Relocating Bracket for 320mm Disc	FA, SFA, TT Pad or Brake Shoe	SFAC Carbon Scooter Pads	Speciality Pads - SXR / Vee / MXS	Sintered/ HH Pads/ Grooved Shoes	Standard Replacement Disc	Contour Disc Rear fitment	Vee Discs CONTOUR	CX Extreme MX Race Disc
1							FA036		FA036V		MD3025			
2							FA063		FA063V	FA063HH	MD3002	MD3002C	VR3002	
3							FA063		FA063V	FA063HH	MD3064			
4							FA063		FA063V	FA063HH	MD3002	MD3002C	VR3002	
5							FA063		FA063V	FA063HH	MD3002	MD3002C	VR3002	
6							FA063		FA063V	FA063HH	MD3002	MD3002C	VR3002	
7							FA063		FA063V	FA063HH	MD3008	MD3008C	VR3008	
8							FA063		FA063V	FA063HH	MD3064			
9							FA063		FA063V	FA063HH	MD3081			
10							FA063		FA063V	FA063HH	MD3081			
11							S606			S606G				
12							S606			S606G				
13							S626			S626G				
14														
15							S626			S626G				
16														
17							S606			S606G				
18							S606			S606G				
19							FA137TT			FA137R	MD6211D			
20							S605			S605G				
21							FA063	FA063V	FA063HH	MD3008	MD3008C	VR3008		
22							FA063	FA063V	FA063HH	MD3064				
23							S605			S605G				
24							S620			S620G				
25							S620			S620G				
26							S605			S605G				
27							S606							
28							FA063	FA063V	FA063HH	MD3008	MD3008C	VR3008		
29							FA063	FA063V	FA063HH	MD3008	MD3008C	VR3008		
30														
31							FA174	FA174V	FA174HH	MD3060	MD3060C	VR3060		
32														
33							FA063	FA063V	FA063HH	MD3008	MD3008C	VR3008		
34							FA063	FA063V	FA063HH	MD3008	MD3008C	VR3008		
35														
36							FA174	FA174V	FA174HH	MD3060	MD3060C	VR3060		
37														
38							S626							
39							S606							
40	OS6254C	OSX6254	BRK023		SMX6254	BRK024	FA367TT		MXS367	FA367R		MD6255C♦		MD6255CX
41														
42	OS6254C	OSX6254	BRK023		SMX6254	BRK024	FA367TT		MXS367	FA367R	MD6255D	MD6255C♦		MD6255CX
43														
44	OS6254C	OSX6254	BRK023		SMX6254	BRK024	FA367TT		MXS367	FA367R	MD6255D	MD6255C♦		MD6255CX
45														
46							FA367TT		MXS367	FA367R	MD6423D			
47							S606							
48														
49														
50							FA137TT			FA137R	MD6278D			
51														
52							S602			S602G				
53							S605			S605G				
54							S605			S605G				
55							FA063	FA063V	FA063HH	MD3002	MD3002C	VR3002		
56							FA063	FA063V	FA063HH	MD3002	MD3002C	VR3002		
57							FA063	FA063V	FA063HH	MD3002	MD3002C	VR3002		
58							S609							
59							S609							
60							S634							

REAR / ARRIÈRE / HINTEN / POSTERIOR / POSTERIORE

*-2 Sets Required. † For Vee disc colours add RED, BLU, GRN, GLD, ORG suffix to part number. For Custom Finish Options for Vee-Rotors™ including Splatter discs add suffix CHR, CHGR, CHBL, CHBR - available in various colours see page iv. Ⓢ - Also available as a Vintage Motorcycle Disc.

R Suffix = High Durability Sintered Pad. **HH** Suffix = High Performance Sintered Pad. **TT** Suffix = Hard Wearing Off Road Pad. **V** Suffix = Semi Sintered Pad. **G** Suffix = Grooved Shoe.
D Suffix = Drilled Disc. **X** Suffix = Universal Left or Right Disc. **XC** Suffix = Contoured Disc. **LS** Suffix = Left/Steel Disc. **RS** = Right/Steel Disc.

BRAKE APPLICATIONS

JAPANESE Built Motorcycles



SUZUKI Contd.



DISC PAD CHOICES - FRONT

BRAKE DISC CHOICES - FRONT

Model	Side	Year	DISC PAD CHOICES - FRONT				BRAKE DISC CHOICES - FRONT						Line #
			FA, SFA, TT Pad or Brake Shoe	SFAC Carbon Scooter Pads	Speciality Pads - SXR / Vee / MXS	Sintered/HH Pads/ Grooved Shoes	Left / Gauche / Links Standard Replacement Disc	Right / Droite / Rechts Standard Replacement Disc	Contour Disc Universal left and right fitment	Custom Disc Universal left and right fitment	Vee-Disks Black † See note below	CX Extreme MX Race Disc/ UTVX Disc	
RG 500 G/CH		85-87	FA103*			FA103HH*	MD3070LS	MD3070RS					1
RM 500 D/E		83-84	S622			S622G							2
LT 500 RL		90	FA128TT*			FA128R*	MD6022D	MD6022D					3
LT-A 500 FY/FK1	Left	00-01	FA165TT		MXS165	FA165R	MD6145D						4
	Right		FA135TT		MXS135	FA135R		MD6145D					5
LT-A 500 FK2 Vision 4WD		02	FA054TT*		MXS054*	FA054R*	MD6195D	MD6195D					6
LT-A 500 FK3/FK4/FK5/FK6/FK7 Vinson 4WD Auto		03-07	FA054TT*		MXS054*	FA054R*	MD6195D	MD6195D					7
LT-A 500 XPK9/XPZK9/XPLO	Left	09-15	FA413TT			FA413R	MD6355D						8
/XPL1-XPL5 (Power Steering)	Right		FA414TT			FA414R		MD6355D					9
LT-F 500 FW/FX/FY/FK1/FK2	Left	98-02	FA165TT		MXS165	FA165R	MD6145D						10
	Right		FA135TT		MXS135	FA135R		MD6145D					11
LT-F 500 FK3-FK7 Vinson Quadrunner		03-07	FA054TT*		MXS054*	FA054R*	MD6195D	MD6195D					12
GT 550 J (4 Shoe type front brake)		72											13
GT 550 K/L/M		73-75	FA055					MD3019RS					14
GT 550 A/B		76-77	FA055					MD3019RS					15
GS 550 DB/DC		77-78	FA038*		FA038V*		MD3014LS	MD3014RS					16
GS 550 EC/EN		78-79	FA038*		FA038V*		MD3014LS	MD3014RS					17
GS 550 ET/EX/EZ/LT/LX/MX/MZ		80-84	FA065*				MD3014LS	MD3014RS					18
GSF 550 ESD/ESE/EFE/EF/ESH/EF/EG (GN71D)		84-87	FA063*			FA063HH*	MD3024LS	MD3024RS					19
DR 600 RG/RH/RJ (SN41A) (Rear drum model)		86-88	FA106/2TT			FA106/2R	MD6075D						20
DR 600 RK (SN41A) (Rear disc model)		89	FA106/2TT			FA106/2R	MD6075D						21
DR 600 SF/SG/SH/SJ/SK (SN41A)		85-89	FA106/2TT			FA106/2R	MD6075D						22
GSF 600 S/T/W/X (Naked Bandit)		95-99	FA142*		FA142V*	FA142HH*	MD3003X	MD3003X	MD3003XC*	MD3003CC*	VR3003BLK*†		23
GSF 600 ST/SV/SW/SX (Faired Bandit)		96-99	FA142*		FA142V*	FA142HH*	MD3003X	MD3003X	MD3003XC*	MD3003CC*	VR3003BLK*†		24
GSF 600 Y/K1/K2/K3/K4	Left	00-04	FA229			FA229HH	MD3003X		MD3003XC	MD3003CC	VR3003BLK*†		25
(Naked Bandit)	Right		FA231			FA231HH		MD3003X	MD3003XC	MD3003CC	VR3003BLK*†		26
GSF 600 SY/K1/K2/K3/K4	Left	00-04	FA229			FA229HH	MD3003X		MD3003XC	MD3003CC	VR3003BLK*†		27
(Faired Bandit)	Right		FA231			FA231HH		MD3003X	MD3003XC	MD3003CC	VR3003BLK*†		28
GSR 600 K6/K7/K8		06-08	FA158*			FA158HH*	MD3092X	MD3092X	MD3092XC*	MD3092CC	VR3003BLK*†		29
GSX 600 FJ (GN72A)		88	FA146*			FA146HH*	MD3001	MD3001					30
GSX 600 FK/FL/FM/FN/FP/FR/FS/FT/FV (GN72A)		89-97	FA146*			FA146HH*	MD3003X	MD3003X	MD3003XC*	MD3003CC*	VR3003BLK*†		31
GSX 600 FW/FX/FY/FK1/FK2	Left	98-02	FA229			FA229HH	MD3003X		MD3003XC	MD3003CC	VR3003BLK*†		32
	Right		FA231			FA231HH		MD3003X	MD3003XC	MD3003CC	VR3003BLK*†		33
GSX 600 FK3/FK4/FK5/FK6	Left	03-04	FA229			FA229HH	MD3090X		MD3090XC	MD3090CC	VR3090BLK*†		34
	Right		FA231			FA231HH		MD3090X	MD3090XC	MD3090CC	VR3090BLK*†		35
GSRX 600 V/W/X/Y (SRAD)		97-00	FA158*			FA158HH*	MD3058X	MD3058X	MD3058XC*	MD3058CC*	VR3058BLK*†		36
GSRX 600 K1/K2/K3/ZK3		01-03	FA158*			FA158HH*	MD3058X	MD3058X	MD3058XC*	MD3058CC*	VR3058BLK*†		37
GSRX 600 K4/K5		04-05				FA379HH*	MD3104X	MD3104X	MD3104XC*		VR3104BLK*†		38
GSRX 600 K6/K7		06-07				FA379HH*	MD3091X	MD3091X	MD3091XC*	MD3091CC*	VR3091BLK*†		39
GSRX 600 K8/K9/L0		08-10				FA379HH*	MD3100X	MD3100X	MD3100XC*		VR3100BLK*†		40
GSRX 600 L1/L2/L3/L4/L5/L6/L7/L8 (Brembo Calipers)		11-21				FA447HH*	MD3100X	MD3100X	MD3100XC*		VR3100BLK*†		41
RF 600 RP/RR/RS/RT/RV (GN76A)		93-97	FA142*		FA142V*	FA142HH*	MD3003X	MD3003X	MD3003XC*	MD3003CC*	VR3003BLK*†		42
VS 600 GLS/GLT/GLV		95-97	FA103		FA103V	FA103HH		MD3032RS					43
UV 620 FK5 Side x Side		05	K719*										44
AN 650 K3 Burgman (4 Bolt Fixing Front/Rear Discs)		03	SFA142*	SFAC142*		SFA142HH*	MD987D	MD987D			VR987*		45
AN 650 K4/K5/K6/K7/K8/K9/L0/L1/L2 Burgman/Skywave (Non ABS) (5 Bolt Fixing Front/Rear Discs)		04-11	SFA142*	SFAC142*		SFA142HH*	MD994D	MD994D			VR994*		46
AN 650 AK4/AK5/AK6/AK7/AK8/AK9/AL0/AL1/AL2 Burgman/Skywave (ABS) (5 Bolt F/R Discs)		04-12	SFA142*	SFAC142*		SFA142HH*	MD994D	MD994D			VR994*		47
AN 650 L3/L4/L5/L6 Burgman Non ABS		13-16	SFA142*	SFAC142*		SFA142HH*	MD9144D	MD9144D			VR9144BLK*		48
AN 650 ZL3/ZL4/ZL5/ZL6/ZL7/ZL8 Burgman ABS Executive		13-18	SFA142*	SFAC142*		SFA142HH*	MD9144D	MD9144D			VR9144BLK*		49
DL 650 K4/K5/K6 V-Strom	Left	04-06	FA229			FA229HH	MD3088X		MD3088XC	MD3088CC	VR3088BLK*†		50
	Right		FA231			FA231HH		MD3088X	MD3088XC	MD3088CC	VR3088BLK*†		51
DL 650 XK7/XK8/XK9/XA0 V-Strom X	Left	07-11	FA229			FA229HH	MD3092X		MD3092XC	MD3092CC	VR3092BLK*†		52
	Right		FA231			FA231HH		MD3092X	MD3092XC	MD3092CC	VR3092BLK*†		53
DL 650 AK7/AK8/AK9/AL0 V-Strom ABS	Left	07-11	FA229			FA229HH	MD3092X		MD3092XC	MD3092CC	VR3092BLK*†		54
	Right		FA231			FA231HH		MD3092X	MD3092XC	MD3092CC	VR3092BLK*†		55
DL 650 AL1XP V-Strom Xpedition	Left	11	FA229			FA229HH	MD3092X		MD3092XC	MD3092CC	VR3092BLK*†		56
	Right		FA231			FA231HH		MD3092X	MD3092XC	MD3092CC	VR3092BLK*†		57

FRONT / AVANT / VORN / FRENTE / ANTERIORE

R Suffix = High Durability Sintered Pad. HH Suffix = High Performance Sintered Pad. TT Suffix = Hard Wearing Off Road Pad. V Suffix = Semi Sintered Pad. G Suffix = Grooved Shoe. D Suffix = Drilled Disc. X Suffix = Universal Left or Right Disc. XC Suffix = Contoured Disc. LS Suffix = Left/Steel Disc. RS = Right/Steel Disc.

*-2 Sets Required. † For Vee disc colours add RED, BLU, GRN, GLD, ORG suffix to part number. For Custom Finish Options for Vee-Rotors™ including Splatter discs add suffix CHR, CHGR, CHBL, CHBR - available in various colours see page iv. ☉ - Also available as a Vintage Motorcycle Disc.

JAPANESE Built Motorcycles

Line #	BRAKE DISC CHOICES - FRONT						DISC PAD CHOICES - REAR				BRAKE DISC CHOICES - REAR			
	Over-size 250 /280mm Disc Kit	OSX Over-size 250/280mm Disc Kit	Relocating Bracket for 250/ 280mm Disc	Over-size 320mm Disc Kit	SMX Over-size 320mm Disc Kit	Relocating Bracket for 320mm Disc	FA, SFA, TT Pad or Brake Shoe	SFAC Carbon Scooter Pads	Speciality Pads - SXR / Vee / MXS	Sintered/ HH Pads/ Grooved Shoes	Standard Replacement Disc	Contour Disc Rear fitment	Vee Discs CONTOUR	CX Extreme MX Race Disc
1							FA063		FA063V	FA063HH	MD3064			
2							S602			S602G				
3							FA137TT			FA137R	MD6023D			
4							S634			S634G				
5														
6							FA317TT			FA317R	MD6196D			
7							FA372TT			FA372R	MD6196D			
8														
9														
10							S634			S634G				
11														
12							FA372TT			FA372R	MD6196D			
13							S609							
14							S609							
15							S611							
16							S611							
17							FA036		FA036V		MD3014RS			
18							FA036		FA036V		MD3014RS			
19							FA063		FA063V	FA063HH	MD3025			
20							S602			S602G				
21							FA157			FA157R	MD6077D			
22							S602			S602G				
23							FA063		FA063V	FA063HH	MD3008	MD3008C	VR3008	
24							FA063		FA063V	FA063HH	MD3008	MD3008C	VR3008	
25							FA063		FA063V	FA063HH	MD3008	MD3008C	VR3008	
26														
27							FA063		FA063V	FA063HH	MD3008	MD3008C	VR3008	
28														
29							FA419		FA419V	FA419HH	MD3093	MD3093C	VR3093	
30							FA063		FA063V	FA063HH	MD3002	MD3002C	VR3002	
31							FA063		FA063V	FA063HH	MD3002	MD3002C	VR3002	
32							FA063		FA063V	FA063HH	MD3008	MD3008C	VR3008	
33														
34							FA063		FA063V	FA063HH	MD3008	MD3008C	VR3008	
35														
36							FA063		FA063V	FA063HH	MD3060	MD3060C	VR3060	
37							FA063		FA063V	FA063HH	MD3060	MD3060C	VR3060	
38							FA254		FA254V	FA254HH	MD3060	MD3060C	VR3060	
39							FA419		FA419V	FA419HH	MD3060	MD3060C	VR3060	
40							FA419		FA419V	FA419HH	MD3060	MD3060C	VR3060	
41							FA436		FA436V	FA436HH	MD3060	MD3060C	VR3060	
42							FA063		FA063V	FA063HH	MD3008	MD3008C	VR3008	
43							S626							
44							K720*							
45							SFA412	SFAC412		SFA412HH	MD998D		VR998	
46														
47							SFA412	SFAC412		SFA412HH	MD998D		VR998	
48														
49							SFA412	SFAC412		SFA412HH	MD998D		VR998	
50							SFA412	SFAC412		SFA412HH	MD998D		VR998	
51														
52							SFA412	SFAC412		SFA412HH	MD998D		VR998	
53														
54							FA174			FA174HH	MD6232D		MD6232CX	
55														
56							FA174			FA174HH	MD6232D		MD6232CX	
57														
58							FA174			FA174HH	MD6232D		MD6232CX	
59														
60							FA174			FA174HH	MD6232D		MD6232CX	

REAR / ARRIÈRE / HINTEN / POSTERIOR / POSTERIORE

R Suffix = High Durability Sintered Pad. **HH** Suffix = High Performance Sintered Pad. **TT** Suffix = Hard Wearing Off Road Pad. **V** Suffix = Semi Sintered Pad. **G** Suffix = Grooved Shoe. **D** Suffix = Drilled Disc. **X** Suffix = Universal Left or Right Disc. **XC** Suffix = Contoured Disc. **LS** Suffix = Left/Steel Disc. **RS** = Right/Steel Disc.

*-2 Sets Required. † For Vee disc colours add RED, BLU, GRN, GLD, ORG suffix to part number. For Custom Finish Options for Vee-Rotors™ including Splatter discs add suffix CHR, CHGR, CHBL, CHBR - available in various colours see page iv. ☉ - Also available as a Vintage Motorcycle Disc.

BRAKE APPLICATIONS

JAPANESE Built Motorcycles



SUZUKI Contd.



DISC PAD CHOICES - FRONT

BRAKE DISC CHOICES - FRONT

Model	Left	Right	FA, SFA, TT Pad or Brake Shoe	SFAC Carbon Scooter Pads	Speciality Pads - SXR / Vee / MXS	Sintered/HH Pads/ Grooved Shoes	Left / Gauche / Links Standard Replacement Disc	Right / Droite / Rechts Standard Replacement Disc	Contour Disc Universal left and right fitment	Custom Disc Universal left and right fitment	Vee-Discs Black † See note below	CX Extreme MX Race Disc/ UTVX Disc	Line #
DL 650 AK9GT V-Strom Traveller/ABS	Left	07-11	FA229			FA229HH	MD3092X		MD3092XC	MD3092CC	VR3092BLK*†		1
	Right		FA231			FA231HH		MD3092X	MD3092XC	MD3092CC	VR3092BLK*†		2
DL 650 V-Strom ABS	Left	12-21	FA229			FA229HH	MD3092X		MD3092XC	MD3092CC	VR3092BLK*†		3
	Right		FA231			FA231HH		MD3092X	MD3092XC	MD3092CC	VR3092BLK*†		4
DL 650 XT V-Strom ABS	Left	15-20	FA229			FA229HH	MD3092X		MD3092XC	MD3092CC	VR3092BLK*†		5
	Right		FA231			FA231HH		MD3092X	MD3092XC	MD3092CC	VR3092BLK*†		6
DL 650 XT V-Strom Touring ABS	Left	18-21	FA229			FA229HH	MD3092X		MD3092XC	MD3092CC	VR3092BLK*†		7
	Right		FA231			FA231HH		MD3092X	MD3092XC	MD3092CC	VR3092BLK*†		8
DR 650 RL/RM (SP41A)		90-91	FA147			FA147R	MD6076D						9
DR 650 RSL/RSM (SP42A)		90-91	FA147			FA147R	MD6076D						10
DR 650 RSEM/RSEW/RSEP (SP43A/B)		91-93	FA147			FA147R	MD6078D						11
DR 650 RER/RES (SP45A/B)		94-95	FA147			FA147R	MD6078D						12
DR 650 RUN/RN/RUP/RP (SP44A/B)		92-93	FA147			FA147R	MD6078D						13
DR 650 SET/SEV (SP46A/B)		96-21	FA185TT		MXS185	FA185R	MD6094D					MD6094CX	14
GR 650 D/XD Tempter		83	FA065		FA065V		MD3014LS						15
GS 650 GTX/GTZ/GTD/GX/GZ		81-83	FA065*		FA065V*		MD3014LS	MD3014RS					16
GSF 650 K5/K6	Left	05-06	FA229		FA229V	FA229HH	MD3090X		MD3090XC	MD3090CC	VR3090BLK†		17
(Naked Bandit - Non ABS)	Right		FA231		FA231V	FA231HH		MD3090X	MD3090XC	MD3090CC	VR3090BLK†		18
GSF 650 SK5/SK6	Left	05-06	FA229		FA229V	FA229HH	MD3090X		MD3090XC	MD3090CC	VR3090BLK†		19
(Faired Bandit - Non ABS)	Right		FA231		FA231V	FA231HH		MD3090X	MD3090XC	MD3090CC	VR3090BLK†		20
GSF 650 AK5/AK6	Left	05-06	FA229		FA229V	FA229HH	MD3101X		MD3101XC				21
(Naked Bandit - ABS)	Right		FA231		FA231V	FA231HH		MD3101X	MD3101XC				22
GSF 650 SAK5/SAK6	Left	05-06	FA229		FA229V	FA229HH	MD3101X		MD3101XC				23
(Faired Bandit - ABS)	Right		FA231		FA231V	FA231HH		MD3101X	MD3101XC				24
GSF 650 K7/K8/K9/L0/L1/L2 (Naked Bandit - Non ABS)		07-11	FA158*			FA158HH*	MD3092X	MD3092X	MD3092XC*	MD3092CC*	VR3092BLK*†		25
GSF 650 AK7/AK8/AK9/AL0/AL1/AL2 (Naked Bandit - ABS)		07-11	FA158*			FA158HH*	MD3092X	MD3092X	MD3092XC*	MD3092CC*	VR3092BLK*†		26
GSF 650 SK7/SK8/SK9/SLO/SL1/SL2													27
(Faired Bandit - Non ABS)		07-11	FA158*			FA158HH*	MD3092X	MD3092X	MD3092XC*	MD3092CC*	VR3092BLK*†		28
GSF 650 SAK7/SAK8/SAK9/SALO/SAL1/SAL2													29
(Faired Bandit - ABS)		07-15	FA158*			FA158HH*	MD3092X	MD3092X	MD3092XC*	MD3092CC*	VR3092BLK*†		30
GSX 650 FK8/FK9/FL0/FL1/FL2 (Non ABS)		08-11	FA158*			FA158HH*	MD3092X	MD3092X	MD3092XC*	MD3092CC*	VR3092BLK*†		31
GSX 650 FAK8/FAK9/FAL0/FAL1/FAL2 (ABS)		08-15	FA158*			FA158HH*	MD3092X	MD3092X	MD3092XC*	MD3092CC*	VR3092BLK*†		32
XN 85 Turbo		83	FA065*		FA065V*		MD3028LS	MD3028RS					33
LS 650 FG/PK/PM/PR/PG/PT/PV/PW/PX Savage NP41A		87-99	FA106TT		FA106V		MD3017LS						34
SFV 650 K9/L0/L1/L2/L3/L4/L5	Left	09-15	FA229		FA229V	FA229HH	MD3103X		MD3103XC				35
Gladius (Non ABS)	Right		FA231		FA231V	FA231HH		MD3103X	MD3103XC				36
SFV 650 AK9/AL0/AL1/AL2/AL3/AL4	Left	09-15	FA229		FA229V	FA229HH	MD3103X		MD3103XC				37
/AL5 Gladius (ABS)	Right		FA231		FA231V	FA231HH		MD3103X	MD3103XC				38
SV 650 XY/K1/K2 (Naked - Non ABS)	Left	99-02	FA229		FA229V	FA229HH	MD3003X		MD3003XC	MD3003CC	VR3003BLK†		39
	Right		FA231		FA231V	FA231HH		MD3003X	MD3003XC	MD3003CC	VR3003BLK†		40
SV 650 SX/SY/SK1/SK2	Left	99-02	FA229		FA229V	FA229HH	MD3003X		MD3003XC	MD3003CC	VR3003BLK†		41
(Top Fairing - Non ABS)	Right		FA231		FA231V	FA231HH		MD3003X	MD3003XC	MD3003CC	VR3003BLK†		42
SV 650 K3/K4/K5/K6/K7/K8/K9/L0	Left	03-10	FA229		FA229V	FA229HH	MD3090X		MD3090XC	MD3090CC	VR3090BLK†		43
(Naked - Non ABS)	Right		FA231		FA231V	FA231HH		MD3090X	MD3090XC	MD3090CC	VR3090BLK†		44
SV 650 SK3/SK4/SK5/SK6/SK7/SK8	Left	03-15	FA229		FA229V	FA229HH	MD3090X		MD3090XC	MD3090CC	VR3090BLK†		45
/SK9/SLO (Top Fairing - Non ABS)	Right		FA231		FA231V	FA231HH		MD3090X	MD3090XC	MD3090CC	VR3090BLK†		46
SV 650 AK7/AK8/AK9/AL0	Left	07-10	FA229		FA229V	FA229HH	MD3103X		MD3103XC				47
(Naked - ABS)	Right		FA231		FA231V	FA231HH		MD3103X	MD3103XC				48
SV 650 SAK7/SAK8/SAK9/SAL0	Left	07-15	FA229		FA229V	FA229HH	MD3103X		MD3103XC				49
(Top Fairing - ABS)	Right		FA231		FA231V	FA231HH		MD3103X	MD3103XC				50
SV 650 ABS	Left	16-18	FA229		FA229V	FA229HH	MD3103X		MD3103XC				51
	Right		FA231		FA231V	FA231HH		MD3103X	MD3103XC				52
SV 650 ABS		19-21	FA158*			FA158HH*	MD3103X	MD3103X	MD3103XC*				53
SV 650 X ABS	Left	18-21	FA229		FA229V	FA229HH	MD3103X		MD3103XC*				54
	Right		FA231		FA231V	FA231HH		MD3103X	MD3103XC*				55
XF 650 VW/X/Y Freewind		97-02	FA231		FA231V	FA231HH		MD6113D					56
GS 700 EF/ESF		85	FA051*		FA051V*		MD3028LS	MD3028RS					57
LT-A 700 XK5/XCK6/XK6/XK7	Left	05-07	FA413TT			FA413R	MD6261D						58
King Quad	Right		FA414TT			FA414R		MD6261D					59
													60

FRONT / AVANT / VORN / FRENTE / ANTERIORE

R Suffix = High Durability Sintered Pad. HH Suffix = High Performance Sintered Pad. TT Suffix = Hard Wearing Off Road Pad. V Suffix = Semi Sintered Pad. G Suffix = Grooved Shoe.
D Suffix = Drilled Disc. X Suffix = Universal Left or Right Disc. XC Suffix = Contoured Disc. LS Suffix = Left/Steel Disc. RS = Right/Steel Disc.

*-2 Sets Required. † For Vee disc colours add RED, BLU, GRN, GLD, ORG suffix to part number. For Custom Finish Options for Vee-Rotors™ including Splatter discs add suffix CHR, CHGR, CHBL, CHBR - available in various colours see page iv. ☉ - Also available as a Vintage Motorcycle Disc.

JAPANESE Built Motorcycles

Line #	BRAKE DISC CHOICES - FRONT						DISC PAD CHOICES - REAR				BRAKE DISC CHOICES - REAR			
	Oversize 250 /280mm Disc Kit	OSX Oversize 250/280mm Disc Kit	Relocating Bracket for 250/ 280mm Disc	Oversize 320mm Disc Kit	SMX Oversize 320mm Disc Kit	Relocating Bracket for 320mm Disc	FA, SFA, TT Pad or Brake Shoe	SFAC Carbon Scooter Pads	Speciality Pads - SXR / Vee / MXS	Sintered/ HH Pads/ Grooved Shoes	Standard Replacement Disc	Contour Disc Rear fitment	Vee Discs CONTOUR	CX Extreme MX Race Disc
1														
2							FA174		FA174HH	MD6232D			MD6232CX	
3														
4							FA174		FA174HH	MD6232D			MD6232CX	
5														
6							FA174		FA174HH	MD6232D			MD6232CX	
7							FA174		FA174HH	MD6232D			MD6232CX	
8														
9							FA157		FA157R	MD6077D				
10							FA157		FA157R	MD6077D				
11							FA157		FA157R	MD6077D				
12							FA157		FA157R	MD6077D				
13							FA157		FA157R	MD6077D				
14					SMX6094	BRK003	FA152TT	MXS152	FA152R	MD6095D			MD6059CX	
15							S606							
16							FA036	FA036V		MD3027				
17														
18							FA254	FA254V	FA254HH	MD3008	MD3008C	VR3008		
19														
20							FA254	FA254V	FA254HH	MD3008	MD3008C	VR3008		
21														
22							FA174	FA174V	FA174HH	MD3093	MD3093C	VR3093		
23														
24							FA174	FA174V	FA174HH	MD3093	MD3093C	VR3093		
25							FA174	FA174V	FA174HH	MD3093	MD3093C	VR3093		
26							FA174	FA174V	FA174HH	MD3093	MD3093C	VR3093		
27														
28							FA174	FA174V	FA174HH	MD3093	MD3093C	VR3093		
29														
30							FA174	FA174V	FA174HH	MD3093	MD3093C	VR3093		
31							FA174	FA174V	FA174HH	MD3093	MD3093C	VR3093		
32							FA174	FA174V	FA174HH	MD3093	MD3093C	VR3093		
33							FA036	FA036V		MD3014RS				
34							S606							
35														
36							FA496	FA496V	FA496HH	MD3093	MD3093C			
37														
38							FA496	FA496V	FA496HH	MD3093	MD3093C			
39														
40							FA063	FA063V	FA063HH	MD3008	MD3008C	VR3008		
41														
42							FA063	FA063V	FA063HH	MD3008	MD3008C	VR3008		
43														
44							FA174	FA174V	FA174HH	MD3060	MD3060C	VR3060		
45														
46							FA174	FA174V	FA174HH	MD3060	MD3060C	VR3060		
47														
48							FA174	FA174V	FA174HH	MD3093	MD3093C			
49														
50							FA174	FA174V	FA174HH	MD3093	MD3093C			
51														
52							FA496	FA496V	FA496HH	MD3093	MD3093C			
53							FA496	FA496V	FA496HH	MD3093	MD3093C			
54														
55							FA496		FA496HH	MD3093	MD3093C			
56							FA140	FA140V	FA140HH	MD6095D				
57							FA036	FA036V		MD3029				
58														
59														
60														

REAR / ARRIÈRE / HINTEN / POSTERIOR / POSTERIORE

R Suffix = High Durability Sintered Pad. **HH** Suffix = High Performance Sintered Pad. **TT** Suffix = Hard Wearing Off Road Pad. **V** Suffix = Semi Sintered Pad. **G** Suffix = Grooved Shoe.
D Suffix = Drilled Disc. **X** Suffix = Universal Left or Right Disc. **XC** Suffix = Contoured Disc. **LS** Suffix = Left/Steel Disc. **RS** = Right/Steel Disc.

*-2 Sets Required. † For Vee disc colours add RED, BLU, GRN, GLD, ORG suffix to part number. For Custom Finish Options for Vee-Rotors™ including Splatter discs add suffix CHR, CHGR, CHBL, CHBR - available in various colours see page iv. ☉ - Also available as a Vintage Motorcycle Disc.

JAPANESE Built Motorcycles



SUZUKI Contd.



DISC PAD CHOICES - FRONT

BRAKE DISC CHOICES - FRONT

		FA, SFA, TT Pad or Brake Shoe	SFAC Carbon Scooter Pads	Speciality Pads - SXR / Vee / MXS	Sintered/HH Pads/ Grooved Shoes	Left / Gauche / Links Standard Replacement Disc	Right / Droite / Rechts Standard Replacement Disc	Contour Disc Universal left and right fitment	Custom Disc Universal left and right fitment	Vee-Disks Black † See note below	CX Extreme MX Race Disc/ UTVX Disc	Line #
LT-V 700 FK4/FK5 Twin Peaks	Left				FA342R	MD6188D						1
	Right				FA349R		MD6188D					2
VS 700 GLEFG/GLEPG/GLEFH/GLEPH (Cast wheel 5 bolt)		FA103		FA103V	FA103HH	MD3073LS						3
VS 700 GLFG/GLPG (Spoke wheel 5 bolt)		FA103		FA103V	FA103HH	MD3031LS						4
VS 700 GLFH/GLPH (Spoke wheel 6 bolt)		FA103		FA103V	FA103HH	MD3032LS						5
DR 750 SJ (SR41A)		FA147			FA147R	MD6076D						6
DR 750 SK (SR41A)		FA147			FA147R	MD6076D						7
GT 750 J (4 Shoe type front brake)												8
GT 750 K/L/M/A/B		FA055*				MD3019LS	MD3019RS					9
GS 750 B		FA035				MD3019LS						10
GS 750 DB/DC/EC/EN		FA035*				MD3014LS	MD3014RS					11
GSR 750 L1/L2/L3/L4/L5/L6 (Non ABS)	Left	FA229			FA229HH	MD3092X		MD3092XC	MD3092CC	VR3092BLK†		12
	Right	FA231			FA231HH		MD3092X	MD3092XC	MD3092CC	VR3092BLK†		13
GSR 750 AL2/AL4/AL5/AL6 (ABS)	Left	FA229			FA229HH	MD3092X		MD3092XC	MD3092CC	VR3092BLK†		14
	Right	FA231			FA231HH		MD3092X	MD3092XC	MD3092CC	VR3092BLK†		15
GSX 750 ET/EX		FA051*		FA051V*		MD3014LS	MD3014RS					16
GSX 750 ESD/EF/ESG/ESE/ESH/EFF		FA051*		FA051V*		MD3028LS	MD3028RS					17
GSX 750 S/SS (GS75X-106815-)		FA065*		FA065V*		MD3028LS	MD3028RS					18
GSX 750 S-2/S-2C Katana (FS75X-114747-)		FA065*		FA065V*		MD3028LS	MD3028RS					19
GSX 750 SE Katana (GR72A)		FA063*		FA063V*	FA063HH*	MD3014LS	MD3014RS					20
GSXR 750 F/G/H (GR75A)		FA103*			FA103HH*	MD3005	MD3005					21
GSXR 750 RG		FA145*			FA145HH*	MD3005	MD3005					22
GSXR 750 J/K/L/M/NN/WP		FA145*			FA145HH*	MD3007X	MD3007X	MD3007XC*		VR3007BLK*†		23
GSXR 750 WR/WS		FA188*			FA188HH*	MD3007X	MD3007X	MD3007XC*		VR3007BLK*†		24
GSXR 750 T/V/W/X (SRAD)		FA188*			FA188HH*	MD3058X	MD3058X	MD3058XC*	MD3058CC*	VR3058BLK*†		25
GSXR 750 Y/K1/K2/K3		FA158*			FA158HH*	MD3058X	MD3058X	MD3058XC*	MD3058CC*	VR3058BLK*†		26
GSXR 750 K4/K5					FA379HH*	MD3104X	MD3104X	MD3104XC*		VR3104BLK*†		27
GSXR 750 K6/K7					FA379HH*	MD3091X	MD3091X	MD3091XC*	MD3091CC*	VR3091BLK*†		28
GSXR 750 K8/K9/L0					FA379HH*	MD3100X	MD3100X	MD3100XC*		VR3100BLK*†		29
GSXR 750 ABS (Brembo Caliper)					FA447HH*	MD3100X	MD3100X	MD3100XC*		VR3100BLK*†		30
GSX-S 750 ABS					FA347HH*	MD3100X	MD3100X	MD3100XC*		VR3100BLK*†		31
GSX-S 750 Y					FA347HH*	MD3092X	MD3092X	MD3092XC*				32
GSX-S 750 Z					FA347HH*	MD3092X	MD3092X	MD3092XC*				33
GSX-S 750 ZL					FA347HH*	MD3092X	MD3092X	MD3092XC*				34
GSX 750 W/X/Y/K1	Left	FA229			FA229HH	MD3045						35
	Right	FA231			FA231HH		MD3045					36
GSX 750 FK/FL/FM/FV/FP/FR/FS/FT/FV (GR78A)		FA146*		FA146V*	FA146HH*	MD3003X	MD3003X	MD3003XC*	MD3003CC*	VR3003BLK*†		37
GSX 750 FW/FX/FY/FK1/FK2	Left	FA229			FA229HH	MD3003X		MD3003XC	MD3003CC	VR3003BLK*†		38
	Right	FA231			FA231HH		MD3003X	MD3003XC	MD3003CC	VR3003BLK*†		39
GSX 750 FK3/FK4/FK5/FK6	Left	FA229			FA229HH	MD3090X		MD3090XC	MD3090CC	VR3090BLK†		40
	Right	FA231			FA231HH		MD3090X	MD3090XC	MD3090CC	VR3090BLK†		41
LT-A 750 XK8/XZK8/XK9/XZK9/XLO	Left	FA413TT			FA413R	MD6261D						42
King Quad	Right	FA414TT			FA414R		MD6261D					43
LT-A 750 XPK9/XPK9/XPLO	Left	FA413TT			FA413R	MD6355D						44
/XPL1-XPL5 (Power Steering)	Right	FA414TT			FA414R		MD6355D					45
VS 750 GLF/GLFG/GLPG Intruder (Spoke Wheel 5 bolt) (VR51A)		FA103		FA103V	FA103HH	MD3031LS						46
VS 750 GLFH/GLPH Intruder (Spoke Wheel 6 bolt) (VR51A)		FA103		FA103V	FA103HH	MD3032LS						47
VS 750 GLEFH/GLEPH Intruder (Cast Wheel 5 bolt) (VR51A)		FA103		FA103V	FA103HH	MD3073LS						48
VS 750 GLPK/GLPL/GLPM Intruder (Spoke Wheel 6 bolt) (VR51A)		FA103		FA103V	FA103HH		MD3032RS					49
DR 800 SL (SR43A)		FA147			FA147R	MD6076D						50
DR 800 SM/SN/SP/SR/SS (SR43B)		FA129			FA129R	MD6113D						51
DR 800 ST/SV (SR43B)		FA229		FA229V	FA229HH	MD6113D						52
VL 800 K1/K2/K3/K4/K5 Intruder Volusia		FA231		FA231V	FA231HH		MD3095RS					53
VL 800 C 50 Boulevard Incl. Tourer		FA231		FA231V	FA231HH		MD3095RS					54
C 800 Intruder - Spoke Wheels (VL 800 K6/K7/K8/K9/L0/L1/L2/L3/L5)		FA231		FA231V	FA231HH		MD3095RS					55
C 800 C Intruder - Cast Wheels (VL 800 CK7/CK8/CK9/CL0/CL1/CL2/CL3)		FA231		FA231V	FA231HH		MD3095RS					56

FRONT / AVANT / VORN / FRENTE / ANTERIORE

R Suffix = High Durability Sintered Pad. HH Suffix = High Performance Sintered Pad. TT Suffix = Hard Wearing Off Road Pad. V Suffix = Semi Sintered Pad. G Suffix = Grooved Shoe. D Suffix = Drilled Disc. X Suffix = Universal Left or Right Disc. LS Suffix = Left/Steel Disc. RS = Right/Steel Disc.

*-2 Sets Required. † For Vee disc colours add RED, BLU, GRN, GLD, ORG suffix to part number. For Custom Finish Options for Vee-Rotors™ including Splatter discs add suffix CHR, CHGR, CHBL, CHBR - available in various colours see page iv. Ⓢ - Also available as a Vintage Motorcycle Disc.

JAPANESE Built Motorcycles

Line #	BRAKE DISC CHOICES - FRONT						DISC PAD CHOICES - REAR				BRAKE DISC CHOICES - REAR			
	OverSize 250 /280mm Disc Kit	OSX OverSize 250/280mm Disc Kit	Relocating Bracket for 250/ 280mm Disc	OverSize 320mm Disc Kit	SMX OverSize 320mm Disc Kit	Relocating Bracket for 320mm Disc	FA, SFA, TT Pad or Brake Shoe	SFAC Carbon Scooter Pads	Speciality Pads - SXR / Vee / MXS	Sintered/ HH Pads/ Grooved Shoes	Standard Replacement Disc	Contour Disc Rear fitment	Vee Discs CONTOUR	CX Extreme MX Race Disc
1														
2														
3							S626							
4							S626							
5							S626							
6							S606							
7							FA157		FA157R	MD6077D				
8							S634							
9							S634							
10							FA036	FA036V		MD3014RS				
11							FA036	FA036V		MD3014RS				
12														
13							FA174	FA174V	FA174HH	MD3093	MD3093C	VR3093		
14														
15							FA174	FA174V	FA174HH	MD3093	MD3093C	VR3093		
16							FA036	FA036V		MD3014RS				
17							FA036	FA036V		MD3029				
18							FA036	FA036V		MD3014RS				
19							FA036	FA036V		MD3014RS				
20							FA036	FA036V		MD3029				
21							FA063	FA063V	FA063HH	MD3009				
22							FA063	FA063V	FA063HH	MD3009				
23							FA063	FA063V	FA063HH	MD3008	MD3008C	VR3008		
24							FA063	FA063V	FA063HH	MD3008	MD3008C	VR3008		
25							FA063	FA063V	FA063HH	MD3060	MD3060C	VR3060		
26							FA063	FA063V	FA063HH	MD3060	MD3060C	VR3060		
27							FA254	FA254V	FA254HH	MD3060	MD3060C	VR3060		
28							FA419	FA419V	FA419HH	MD3060	MD3060C	VR3060		
29							FA419	FA419V	FA419HH	MD3060	MD3060C	VR3060		
30							FA436	FA436V	FA436HH	MD3060	MD3060C	VR3060		
31							FA174	FA174V	FA174HH	MD3060	MD3060C	VR3060		
32							FA174	FA174V	FA174HH	MD3093	MD3060C			
33							FA174	FA174V	FA174HH	MD3093	MD3060C			
34							FA174	FA174V	FA174HH	MD3093	MD3060C			
35							FA063	FA063V	FA063HH	MD3008	MD3008C			
36														
37							FA063	FA063V	FA063HH	MD3002	MD3002C	VR3002		
38							FA063	FA063V	FA063HH	MD3008	MD3008C	VR3008		
39														
40							FA063	FA063V	FA063HH	MD3008	MD3008C	VR3008		
41														
42														
43														
44														
45														
46														
47							S626							
48							S626							
49							S626							
50														
51							S626							
52							FA157		FA157R	MD6077D				
53							FA165/2TT		FA165/2R	MD6077D				
54							FA165/2TT		FA165/2R	MD6077D				
55							S626							
56							S626							
57														
58							S626							
59														
60							S626							

REAR / ARRIÈRE / HINTEN / POSTERIOR / POSTERIORE

R Suffix = High Durability Sintered Pad. **HH** Suffix = High Performance Sintered Pad. **TT** Suffix = Hard Wearing Off Road Pad. **V** Suffix = Semi Sintered Pad. **G** Suffix = Grooved Shoe.
D Suffix = Drilled Disc. **X** Suffix = Universal Left or Right Disc. **XC** Suffix = Contoured Disc. **LS** Suffix = Left/Steel Disc. **RS** = Right/Steel Disc.

*-2 Sets Required. † For Vee disc colours add RED, BLU, GRN, GLD, ORG suffix to part number. For Custom Finish Options for Vee-Rotors™ including Splatter discs add suffix CHR, CHGR, CHBL, CHBR - available in various colours see page iv. Ⓢ - Also available as a Vintage Motorcycle Disc.

JAPANESE Built Motorcycles



SUZUKI Contd.



DISC PAD CHOICES - FRONT

BRAKE DISC CHOICES - FRONT

		FA, SFA, TT Pad or Brake Shoe	SFAC Carbon Scooter Pads	Speciality Pads - SXR / Vee / MXS	Sintered/HH Pads/ Grooved Shoes	Left / Gauche / Links Standard Replacement Disc	Right / Droite / Rechts Standard Replacement Disc	Contour Disc Universal left and right fitment	Custom Disc Universal left and right fitment	Vee-Discs Black † See note below	CX Extreme MX Race Disc/ UTVX Disc	Line #
VS 800 GLN/GLP/GLR/GLS/GLT/GLV/GLW/GLX Intruder (VS52A)	92-99	FA103		FA103V	FA103HH							1
VX 800 L/M/N/P/R	90-95	FA129		FA129V	FA129HH	MD3033LS						2
VX 800 T	96	FA229		FA229V	FA229HH	MD3033LS						3
VZ 800 V/W/X/Y/K1/K2 Marauder	97-03	FA231		FA231V	FA231HH		MD3045					4
M 800 (VZ 800 K5-K9/L0/L1/L3 Intruder M800)	05-13	FA231		FA231V	FA231HH		MD3096RS					5
M 800 Z (VZ 800 K9Z M800 Intruder)	09-10	FA231		FA231V	FA231HH		MD3096RS					6
M 800/T (VZ 800 L4/L5 M800/T Intruder)	14-15	FA231		FA231V	FA231HH		MD3096RS					7
GS 850 GN/GT/GX	79-81	FA038*		FA038V*		MD3014LS	MD3014RS					8
GS 850 GZ/GE/GG	82-85	FA051*		FA051V*		MD3014LS	MD3014RS					9
DL 900 Migrator	14-17	FA229			FA229HH	MD3014LS		MD3014C				10
RF 900 RR/RS/RS2	94-95	FA145*			FA145HH*	MD3006X	MD3006X	MD3006XC*	MD3006CC*	VR3006BLK*†		11
RF 900 RT/RV/RW	96-99	FA145*			FA145HH*	MD3006X	MD3006X	MD3006XC*	MD3006CC*	VR3006BLK*†		12
GSX-S 950 999cc New 35KW/70KW	21				FA379HH*	TBC	TBC					13
DL 1000 K2-K9/L0 V-Strom	02-10	FA229		FA229V	FA229HH	MD3088X		MD3088XC	MD3088CC	VR3088BLK†		14
		FA231		FA231V	FA231HH		MD3088X	MD3088XC	MD3088CC	VR3088BLK†		15
DL 1000 V-Strom (ABS)	14-20				FA379HH*							16
DL 1000XT V-Strom (ABS)	18-20				FA379HH*							17
GS 1000 HC/EC/EN/SN	78-80	FA038*		FA038V*		MD3014LS	MD3014RS					18
GS 1000 ET	81	FA065*				MD3014LS	MD3014RS					19
GS 1000 GT/GX	81-82	FA051*				MD3014LS	MD3014RS					20
GSX 1000 SZ Katana	82	FA065*				MD3014LS	MD3014RS					21
GSX 1000 Katana	19-21				FA447HH*	MD3109X	MD3109X	MD3109XC*		VR3109BLK*†		22
GSXR 1000 K1/K2	01-02	FA188*			FA188HH*	MD3058X	MD3058X	MD3058XC*	MD3058CC*	VR3058BLK*†		23
GSXR 1000 K3	03				FA369/4HH*	MD3089X	MD3089X	MD3089XC*	MD3089CC*	VR3089BLK*†		24
GSXR 1000 K4	04				FA379HH*	MD3104X	MD3104X	MD3104XC*		VR3104BLK*†		25
GSXR 1000 K5/K6	05-06				FA379HH*	MD3091X	MD3091X	MD3091XC*	MD3091CC*	VR3091BLK*†		26
GSXR 1000 K7/K8	07-08				FA379HH*	MD3091X	MD3091X	MD3091XC*	MD3091CC*	VR3091BLK*†		27
GSXR 1000 K9/L0/L1	09-11				FA379HH*	MD3102X	MD3102X	MD3102XC*		VR3102BLK*†		28
GSXR 1000 L2/L3/ZL3/L4/ZL4/L5/L6/L7 (Brembo Caliper)	12-17				FA447HH*	MD3102X	MD3102X	MD3102XC*		VR3102BLK*†		29
GSXR 1000 AL5/AL6 (Brembo Caliper/310mm Disc ABS)	15-16				FA447HH*	MD3102X	MD3102X	MD3102XC*		VR3102BLK*†		30
GSXR 1000 A (Brembo Caliper/320mm Disc ABS)	17-21				FA447HH*	MD3107X	MD3107X	MD3107XC*		VR3107BLK*†		31
GSXR 1000 R (Brembo Caliper/320mm Disc ABS)	17-21				FA447HH*	MD3107X	MD3107X	MD3107XC*		VR3107BLK*†		32
GSX-S 1000 L	16-21				FA447HH*	MD3109X	MD3109X	MD3109XC*		VR3109BLK*†		33
GSX-S 1000 A ABS	16-20				FA447HH*	MD3109X	MD3109X	MD3109XC*		VR3109BLK*†		34
GSX-S 1000 F	16-21				FA447HH*	MD3109X	MD3109X	MD3109XC*		VR3109BLK*†		35
GSX-S 1000 F ABS	16-21				FA447HH*	MD3109X	MD3109X	MD3109XC*		VR3109BLK*†		36
SV 1000 K3/K4/K5/K6/K7 (Naked)	03-07	FA158*			FA158HH*	MD3088X	MD3088X	MD3088XC*	MD3088CC*	VR3088BLK*†		37
SV 1000 SK3/SK4/SK5/SK6/SK7 (Faired)	03-07	FA158*			FA158HH*	MD3088X	MD3088X	MD3088XC*	MD3088CC*	VR3088BLK*†		38
TL 1000 SV/SW/SX/SY/SK1	97-01	FA158*			FA158HH*	MD3058X	MD3058X	MD3058XC*	MD3058CC*	VR3058BLK*†		39
TL 1000 RW/RX/RV/RK1	98-02	FA188*			FA188HH*	MD3058X	MD3058X	MD3058XC*	MD3058CC*	VR3058BLK*†		40
DL 1050 V-Strom (ABS)	18-21				FA379HH*	MD3092X	MD3092X	MD3092XC*	MD3092CC*			41
DL 1050 V-Strom XT (ABS)	18-21				FA379HH*	MD3092X	MD3092X	MD3092XC*	MD3092CC*			42
DL 1050 V-Strom XT Tour (ABS)	18-21				FA379HH*	MD3092X	MD3092X	MD3092XC*	MD3092CC*			43
GSX 1100 ET/EX/EZ	80-82	FA065*				MD3014LS	MD3014RS					44
GSX 1100 ESD	83	FA065*				MD3014LS	MD3014RS					45
GSX 1100 SZ/SD Katana	82-83	FA065*				MD3014LS	MD3014RS					46
GS 1100 GZ	82	FA051*				MD3014LS	MD3014RS					47
GSX 1100 EFE/EFF/ESE	84-86	FA103*			FA103HH*	MD3039LS	MD3039RS					48
GSX 1100 FJ/FK/FL/FM/FN/FP/FR (GV72A)	88-94	FA146*			FA146HH*	MD3039LS	MD3039RS					49
GSXR 1100 G/H/J (GV74B)	86-88	FA103*			FA103HH*	MD3004	MD3004					50
GSXR 1100 K/L/M/N (GV73B)	89-92	FA145*			FA145HH*	MD3007X	MD3007X	MD3007XC*		VR3007BLK*†		51
GSXR 1100 WP/WR/WS/WT (GU75A)	93-96	FA188*			FA188HH*	MD3007X	MD3007X	MD3007XC*		VR3007BLK*†		52
GSX 1100 GM/GN/GR	91-96	FA129*			FA129HH*	MD3037LS	MD3037RS					53
GS 1200 SSK1/ZK1 (GV78A)	01	FA188*			FA188HH*	MD3006X	MD3006X	MD3006XC*	MD3006CC*	VR3006BLK*†		54
GSF 1200 T/V/W/X/Y (Naked Bandit - 4 Piston Caliper)	96-00	FA145*			FA145HH*	MD3006X	MD3006X	MD3006XC*	MD3006CC*	VR3006BLK*†		55
GSF 1200 ST/SV/SW/SX/SY (Faired Bandit - 4 Piston Caliper)	96-00	FA145*			FA145HH*	MD3006X	MD3006X	MD3006XC*	MD3006CC*	VR3006BLK*†		56

FRONT / AVANT / VORN / FRENTE / ANTERIORE

R Suffix = High Durability Sintered Pad. HH Suffix = High Performance Sintered Pad. TT Suffix = Hard Wearing Off Road Pad. V Suffix = Semi Sintered Pad. G Suffix = Grooved Shoe. D Suffix = Drilled Disc. X Suffix = Universal Left or Right Disc. XC Suffix = Contoured Disc. LS Suffix = Left/Steel Disc. RS = Right/Steel Disc.

*-2 Sets Required. † For Vee disc colours add RED, BLU, GRN, GLD, ORG suffix to part number. For Custom Finish Options for Vee-Rotors™ including Splatter discs add suffix CHR, CHGR, CHBL, CHBR - available in various colours see page iv. ⊗ - Also available as a Vintage Motorcycle Disc.

JAPANESE Built Motorcycles

Line #	BRAKE DISC CHOICES - FRONT						DISC PAD CHOICES - REAR				BRAKE DISC CHOICES - REAR			
	Oversize 250 /280mm Disc Kit	OSX Oversize 250/280mm Disc Kit	Relocating Bracket for 250/ 280mm Disc	Oversize 320mm Disc Kit	SMX Oversize 320mm Disc Kit	Relocating Bracket for 320mm Disc	FA, SFA, TT Pad or Brake Shoe	SFAC Carbon Scooter Pads	Speciality Pads - SXR / Vee / MXS	Sintered/ HH Pads/ Grooved Shoes	Standard Replacement Disc	Contour Disc Rear fitment	Vee Discs CONTOUR	CX Extreme MX Race Disc
1														
2							S626							
3							FA146	FA146V	FA146HH	MD3061				
4							FA146	FA146V	FA146HH	MD3061				
5							S626							
6							S626							
7							S626							
8							S626							
9							FA036	FA036V		MD3014RS Ⓞ				
10							FA036	FA036V		MD3027				
11							FA174		FA174HH	MD6232D				
12							FA222			MD3008	MD3008C	VR3008		
13							FA063	FA063V	FA063HH	MD3008	MD3008C	VR3008		
14							FA174		FA174HH		MD3108C	VR3108		
15										MD6232D			MD6232CX	
16							FA174	FA174V	FA174HH					
17							FA419	FA419V	FA419HH	MD6232D			MD6232CX	
18							FA419	FA419V	FA419HH	MD6232D			MD6232CX	
19							FA036	FA036V		MD3014RS Ⓞ				
20							FA036	FA036V		MD3014RS Ⓞ				
21							FA036	FA036V		MD3014RS Ⓞ				
22							FA036	FA036V		MD3014RS Ⓞ				
23							FA174		FA174HH	MD3108	MD3108C	VR3108		
24							FA254		FA254HH	MD3060	MD3060C	VR3060		
25							FA254		FA254HH	MD3060	MD3060C	VR3060		
26							FA254		FA254HH	MD3060	MD3060C	VR3060		
27							FA254		FA254HH	MD3060	MD3060C	VR3060		
28							FA419		FA419HH	MD3060	MD3060C	VR3060		
29							FA436		FA436HH	MD3060	MD3060C	VR3060		
30							FA436		FA436HH	MD3060	MD3060C	VR3060		
31														
32							FA436		FA436HH	MD3106	MD3106C	VR3106		
33							FA436		FA436HH	MD3106	MD3106C	VR3106		
34							FA436		FA436HH	MD3106	MD3106C	VR3106		
35							FA174		FA174HH	MD3108	MD3108C	VR3108		
36							FA174		FA174HH	MD3108	MD3108C	VR3108		
37							FA174		FA174HH	MD3108	MD3108C	VR3108		
38							FA174		FA174HH	MD3108	MD3108C	VR3108		
39							FA174		FA174HH	MD3060	MD3060C	VR3060		
40							FA174		FA174HH	MD3060	MD3060C	VR3060		
41							FA063		FA063HH	MD3060	MD3060C	VR3060		
42							FA063		FA063HH	MD3060	MD3060C	VR3060		
43							FA419	FA419V	FA419HH	MD6232D			MD6232CX	
44							FA419	FA419V	FA419HH	MD6232D			MD6232CX	
45							FA419	FA419V	FA419HH	MD6232D			MD6232CX	
46							FA036	FA036V		MD3014RS Ⓞ				
47							FA036	FA036V		MD3014RS Ⓞ				
48							FA036	FA036V		MD3014RS Ⓞ				
49							FA036	FA036V		MD3027				
50							FA103	FA103V	FA103HH	MD3039				
51							FA103	FA103V	FA103HH	MD3036				
52							FA063	FA063V	FA063HH	MD3009				
53							FA063	FA063V	FA063HH	MD3008	MD3008C	VR3008		
54							FA063	FA063V	FA063HH	MD3008	MD3008C	VR3008		
55							FA146	FA146V	FA146HH	MD3038				
56							FA254	FA254V	FA254HH	MD3008	MD3008C	VR3008		
57							FA063	FA063V	FA063HH	MD3008	MD3008C	VR3008		
58														
59							FA063	FA063V	FA063HH	MD3008	MD3008C			
60														

REAR / ARRIÈRE / HINTEN / POSTERIOR / POSTERIORE

R Suffix = High Durability Sintered Pad. **HH** Suffix = High Performance Sintered Pad. **TT** Suffix = Hard Wearing Off Road Pad. **V** Suffix = Semi Sintered Pad. **G** Suffix = Grooved Shoe.
D Suffix = Drilled Disc. **X** Suffix = Universal Left or Right Disc. **XC** Suffix = Contoured Disc. **LS** Suffix = Left/Steel Disc. **RS** = Right/Steel Disc.

BRAKE APPLICATIONS

*-2 Sets Required. † For Vee disc colours add RED, BLU, GRN, GLD, ORG suffix to part number. For Custom Finish Options for Vee-Rotors™ including Splatter discs add suffix CHR, CHGR, CHBL, CHBR - available in various colours see page iv. Ⓞ - Also available as a Vintage Motorcycle Disc.

JAPANESE Built Motorcycles



SUZUKI Contd.



DISC PAD CHOICES - FRONT

BRAKE DISC CHOICES - FRONT

Model	Year	FA, SFA, TT Pad or Brake Shoe	SFAC Carbon Scooter Pads	Speciality Pads - SXR / Vee / MXS	Sintered/HH Pads/ Grooved Shoes	Left / Gauche / Links Standard Replacement Disc		Right / Droite / Rechts Standard Replacement Disc		Contour Disc Universal left and right fitment	Custom Disc Universal left and right fitment	Vee-Disks Black † See note below	CX Extreme MX Race Disc/ UTVX Disc	Line #
GSF 1200 SAV (Faired Bandit - ABS Model- 4 Piston Caliper)	97	FA145*			FA145HH*	MD3075LS	MD3075RS							1
GSF 1200 K1/K2/K3/K4/K5 (Naked Bandit - 6 Piston Caliper)	01-05	FA188*			FA188HH*	MD3006X	MD3006X	MD3006XC*	MD3006CC*	VR3006BLK*†				2
GSF 1200 S SK1/SK2/SK3/SK4/SK5 (Faired Bandit - 6 Piston Caliper)	01-05	FA188*			FA188HH*	MD3006X	MD3006X	MD3006XC*	MD3006CC*	VR3006BLK*†				3
GSF 1200 K6/AK6 (Naked Bandit /Non & ABS Models/4 Piston Caliper)	06	FA158*			FA158HH*	MD3092X	MD3092X	MD3092XC*	MD3092CC*	VR3092BLK*†				4
GSF 1200 SK6/SAK6 (Faired Bandit /Non & ABS Models/4 Piston Caliper)	06	FA158*			FA158HH*	MD3092X	MD3092X	MD3092XC*	MD3092CC*	VR3092BLK*†				5
GSX 1200 FSW/FSX Inazuma	98-99	FA244*			FA244HH*	MD3006X	MD3006X	MD3006XC*	MD3006CC*	VR3006BLK*†				6
GV 1200 GLF/GLF2/GLG Madura	85-86	FA051*		FA051V*		MD3030LS	MD3030RS							7
GSF 1250 K7/K8/K9/OLO (Naked Bandit - Non ABS - 4 Piston Caliper)	07-11	FA158*			FA158HH*	MD3092X	MD3092X	MD3092XC*	MD3092CC*	VR3092BLK*†				8
GSF 1250 AK7/AK8 (Naked Bandit - ABS Model - 4 Piston Caliper)	07-10	FA158*			FA158HH*	MD3092X	MD3092X	MD3092XC*	MD3092CC*	VR3092BLK*†				9
GSF 1250 SK7/SK8/SK9/SLO (Faired Bandit - ABS Model - 4 Piston Caliper)	07-10	FA158*			FA158HH*	MD3092X	MD3092X	MD3092XC*	MD3092CC*	VR3092BLK*†				10
GSF 1250 SAK7/SAK8/SAK9/SAZK9/SALO/SAL1 /SAL2/SAL4/SAL5/SAL6 (Faired Bandit - ABS Model - 4 Piston Caliper)	07-16	FA158*			FA158HH*	MD3092X	MD3092X	MD3092XC*	MD3092CC*	VR3092BLK*†				11
GSX 1250 FALO/FAL1/FAL2/FAL4/FAL5/FAL6	10-16	FA158*			FA158HH*	MD3092X	MD3092X	MD3092XC*	MD3092CC*	VR3092BLK*†				12
GSX 1250 FAL0ST/FAL1ST Sports Touring	10-14	FA158*			FA158HH*	MD3092X	MD3092X	MD3092XC*	MD3092CC*	VR3092BLK*†				13
GSX 1300 RX/RV/RK1/RK2/RK3/RZK3/RK4 /RK5/K6/K7 Hayabusa	99-07	FA188*			FA188HH*	MD3058X	MD3058X	MD3058XC*	MD3058CC*	VR3058BLK*†				14
GSX 1300 RK8/RK9/RL0/RL1/RL2 Hayabusa	08-12				FA379HH*	MD3098X	MD3098X	MD3098XC*	MD3098CC*	VR3098BLK*†				15
GSX 1300 Hayabusa (Brembo Calipers)	13-20				FA447HH*	MD3098X	MD3098X	MD3098XC*	MD3098CC*	VR3098BLK*†				16
GSX 1300 New R Hayabusa Brembo Style Calipers, 320mm O/D discs	2021				FA447HH*	TBC	TBC							17
GSX 1300 BKK8/BKK9/BKLO/BKL1 B-King	08-12				FA347HH*	MD3098X	MD3098X	MD3098XC*	MD3098CC*	VR3098BLK*†				18
GSX 1400 K1/K2/K3/K4/K5/K6/K7/FE	01-07	FA188*			FA188HH*	MD3058X	MD3058X	MD3058XC*	MD3058CC*	VR3058BLK*†				19
GV 1400 GDG/GTG Cavalcade (Up to F/No 103764)	86	FA103*		FA103V*	FA103HH*	MD3042	MD3042							20
GV 1400 GDG/GCG/GDH/GDJ/GCH Cavalcade (From f/No 103765)	86-88	FA146*		FA146V*	FA146HH*	MD3042	MD3042							21
VS 1400 GLPH/GLFH/GLPJ/GLFJ/GLPP/GLPT/GLPV/GLPW /GLPX/GLPY/GLPK1/GLPK2 Intruder (VX51L)	87-03	FA103		FA103V	FA103HH			MD3032RS						22
VL 1500 W/X Intruder Legendary Classic	98-99	FA103		FA103V	FA103HH			MD3078RS						23
VL 1500 Y/K1 Intruder Legendary Classic	00-01	FA103		FA103V	FA103HH			MD3078RS						24
VL 1500 K2/K3 Intruder	02-03	FA229		FA229V	FA229HH	MD3087LS								25
VL 1500 K5/K6/K7/K8/K9 (C 1500 Intruder)	05-09	FA231		FA231V	FA231HH			MD3087RS						26
VL 1500 BTL3/BTL4/BLT5 (CT 1500 BT Intruder)	13-15	FA196		FA196V	FA196HH									27
M 1500 VZ 1500 K9/L0	09-13	FA229		FA229V	FA229HH	MD3090X			MD3090CC					28
M 1600 (VZ 1600 K4 M1600 Marauder)	04	FA188*		FA231V	FA231HH		MD3090X		MD3090CC					29
M 1600 (VZ 1600 K5 M1600 Intruder)	05				FA188HH*	MD4022X	MD4022X	MD4022XC*	MD4022CC*	VR4022BLK*†				30
C 1800 R (VLR 1800 K8/K9/L0/L1) (C 1800 R Intruder)	08-13	FA388*			FA388HH*	MD3090X	MD3090X	MD3090XC*	MD3090CC*	VR3090BLK*†				31
C 1800 RT (VLR 1800 8RT/K9RT) (C 1800 RT Intruder)	08-09	FA388*			FA388HH*	MD3090X	MD3090X	MD3090XC*	MD3090CC*	VR3090BLK*†				32
M 1800 R (VZR 1800 K6/K7/K8/K9) (M 1800 R Intruder - With handlebar cowling)	06-09				FA379HH*	MD3091X	MD3091X	MD3091XC*	MD3091CC*	VR3091BLK*†				33
M 1800 R2 (VZR 1800 NK8/NK9 Intruder - M 1800 RZ - No handlebar cowling)	08-09				FA379HH*	MD3091X	MD3091X	MD3091XC*	MD3091CC*	VR3091BLK*†				34
M 1800 RZ (VZR 1800 ZK7/ZK8/ZL1/ZL2/ZL3 - M 1800 RZ - With handlebar cowling)	07-13				FA379HH*	MD3091X	MD3091X	MD3091XC*	MD3091CC*	VR3091BLK*†				35
M 1800 RB (VZR 1800 BZL4/BZL5/BZL6/BZL7/BZL8 - M 1800 RB)	14-18				FA379HH*	MD3091X	MD3091X	MD3091XC*	MD3091CC*	VR3091BLK*†				36

FRONT / AVANT / VORN / FRENTE / ANTERIORE

R Suffix = High Durability Sintered Pad. HH Suffix = High Performance Sintered Pad. TT Suffix = Hard Wearing Off Road Pad. V Suffix = Semi Sintered Pad. G Suffix = Grooved Shoe. D Suffix = Drilled Disc. X Suffix = Universal Left or Right Disc. XC Suffix = Contoured Disc. LS Suffix = Left/Steel Disc. RS = Right/Steel Disc.

*-2 Sets Required. † For Vee disc colours add RED, BLU, GRN, GLD, ORG suffix to part number. For Custom Finish Options for Vee-Rotors™ including Splatter discs add suffix CHR, CHGR, CHBL, CHBR - available in various colours see page iv. ☉ - Also available as a Vintage Motorcycle Disc.

JAPANESE Built Motorcycles

Line #	BRAKE DISC CHOICES - FRONT						DISC PAD CHOICES - REAR				BRAKE DISC CHOICES - REAR			
	Oversize 250 /280mm Disc Kit	OSX Oversize 250/280mm Disc Kit	Relocating Bracket for 250/ 280mm Disc	Oversize 320mm Disc Kit	SMX Oversize 320mm Disc Kit	Relocating Bracket for 320mm Disc	FA, SFA, TT Pad or Brake Shoe	SFAC Carbon Scooter Pads	Speciality Pads - SXR / Vee / MXS	Sintered/ HH Pads/ Grooved Shoes	Standard Replacement Disc	Contour Disc Rear fitment	Vee Discs CONTOUR	CX Extreme MX Race Disc
1														
2							FA063		FA063V	FA063HH	MD3076			
3														
4							FA063		FA063V	FA063HH	MD3008	MD3008C	VR3008	
5														
6							FA063		FA063V	FA063HH	MD3008	MD3008C	VR3008	
7														
8							FA174		FA174V	FA174HH	MD3093	MD3093C	VR3093	
9														
10							FA174		FA174V	FA174HH	MD3093	MD3093C	VR3093	
11							FA063		FA063V	FA063HH	MD3008	MD3008C	VR3008	
12							FA036		FA036V		MD3041			
13														
14							FA174		FA174V	FA174HH	MD3093	MD3093C	VR3093	
15														
16							FA174		FA174V	FA174HH	MD3093	MD3093C	VR3093	
17														
18							FA174		FA174V	FA174HH	MD3093	MD3093C	VR3093	
19														
20														
21							FA174		FA174V	FA174HH	MD3093	MD3093C	VR3093	
22							FA174		FA174V	FA174HH	MD3093	MD3093C	VR3093	
23							FA174		FA174V	FA174HH	MD3093	MD3093C	VR3093	
24														
25							FA063		FA063V	FA063HH	MD3008	MD3008C	VR3008	
26							FA419		FA419V	FA419HH	MD3099	MD3099C	VR3099	
27							FA419		FA419V	FA419HH	MD3099	MD3099C	VR3099	
28														
29							FA419		FA419V	FA419HH	MD3099	MD3099C	VR3099	
30							FA419		FA419V	FA419HH	MD3099	MD3099C	VR3099	
31							FA254		FA254V	FA254HH	MD3083	MD3083C		
32							FA103		FA103V	FA103HH	MD3043			
33														
34							FA150		FA150V	FA150HH	MD3043			
35														
36							FA103		FA103V	FA103HH	MD3044			
37							FA103		FA103V	FA103HH	MD3079			
38							FA103		FA103V	FA103HH	MD3086			
39							FA366TT		FA366V	FA366HH	MD3086			
40														
41							FA366TT		FA366V	FA366HH	MD3086			
42														
43														
44									FA231/2V	FA231HH				
45									FA231/2V	FA231HH	MD3097			
46									FA231/3V	FA231HH	MD4146			
47									FA231/3V	FA231HH	MD4146			
48									FA231/2V	FA231HH	MD3097			
49									FA231/2V	FA231HH	MD3097			
50														
51									FA231/3V	FA231HH	MD3097			
52														
53									FA231/3V	FA231HH	MD3097			
54														
55									FA231/3V	FA231HH	MD3097			
56														
57									FA231/3V	FA231HH	MD3097			
58														
59														
60														

REAR / ARRIÈRE / HINTEN / POSTERIOR / POSTERIORE

R Suffix = High Durability Sintered Pad. **HH** Suffix = High Performance Sintered Pad. **TT** Suffix = Hard Wearing Off Road Pad. **V** Suffix = Semi Sintered Pad. **G** Suffix = Grooved Shoe.
D Suffix = Drilled Disc. **X** Suffix = Universal Left or Right Disc. **XC** Suffix = Contoured Disc. **LS** Suffix = Left/Steel Disc. **RS** = Right/Steel Disc.

*-2 Sets Required. † For Vee disc colours add RED, BLU, GRN, GLD, ORG suffix to part number. For Custom Finish Options for Vee-Rotors™ including Splatter discs add suffix CHR, CHGR, CHBL, CHBR - available in various colours see page iv. ☉ - Also available as a Vintage Motorcycle Disc.

BRAKE APPLICATIONS

JAPANESE Built Motorcycles



YAMAHA



DISC PAD CHOICES - FRONT

BRAKE DISC CHOICES - FRONT

R Suffix = High Durability Sintered Pad. **HH** Suffix = High Performance Sintered Pad. **TT** Suffix = Hard Wearing Off Road Pad. **V** Suffix = Semi Sintered Pad. **G** Suffix = Grooved Shoe.

D Suffix = Drilled Disc. **X** Suffix = Universal Left or Right Disc. **XC** Suffix = Contoured Disc. **LS** Suffix = Left/Steel Disc. **RS** = Right/Steel Disc.

FRONT / AVANT / VORN / FRENTE / ANTERIORE

		FA, SFA, TT Pad or Brake Shoe	SFAC Carbon Scooter Pads	Speciality Pads - SXR / Vee / MXS	Sintered/HH Pads/ Grooved Shoes	Left / Gauche / Links Standard Replacement Disc	Right / Droite / Rechts Standard Replacement Disc	Contour Disc Universal left and right fitment	Custom Disc Universal left and right fitment	Vee-Discs Black † See note below	CX Extreme MX Race Disc/ UTVX Disc	Line #
Aerox 50 2T All Models (See lines for NS 50/YQ 50)	97-16	SFA193	SFAC193		SFA193HH	MD923D				VR923		1
Aerox 4 50	14-20	SFA193	SFAC193		SFA193HH	MD923D				VR923		2
BA 50 C (4KNH) Gear-C (UA03J)	04-08	Y531										3
BA 50 S/V (UA03J)	08	Y531										4
BWs (3TX/4CA) CW 50 T Bi-Wizz	90-94	Y518										5
BWs 50 Next Generation (Twin headlight model)												6
(190mm disc)	99-07	SFA193	SFAC193		SFA193HH	MD923D				VR923		7
BWs 50 Original (180mm disc)	99-02	SFA193	SFAC193		SFA193HH	MD916D						8
BWs 50 (5WW1)	04	SFA193	SFAC193		SFA193HH	MD916D						9
BWs 50 (5WW4/6/8/9/B/D/F/H/K/M/P)	05-15	SFA193	SFAC193		SFA193HH	MD916D						10
BWs Easy (2DW)	13-15	Y530										11
BWs 50 Naked (1D11/2B71)	03-04	SFA193	SFAC193		SFA193HH	MD916D						12
BWs 50 Naked (2B7B/D/F/H)	09-15	SFA193	SFAC193		SFA193HH	MD916D						13
BWs 50 R (5SX1)	01	SFA193	SFAC193		SFA193HH	MD916D						14
CA 50 Salient	83-85	Y501										15
CG 50 Jog	88-92	Y501										16
CR-Z 50 (3WN)	91-95	SFA169	SFAC169		SFA169HH	MD904D				VR904		17
CS 50 Jog R	02-05	SFA193	SFAC193		SFA193HH	MD943D		MD943C		VR943		18
CS 50 Jog R	06-15	SFA193	SFAC193		SFA193HH	MD943D		MD943C		VR943		19
CS 50 Z (Jog RR)	03-05	SFA193	SFAC193		SFA193HH	MD943D		MD943C		VR943		20
CS 50 Z (Jog RR)	06-12	SFA193	SFAC193		SFA193HH	MD943D		MD943C		VR943		21
CT 50 S (3NT6)	90-95	Y503										22
CT 50 SS (3NTC)	92-95	Y503										23
CV 50 Jog (5KN1/2) (Coolstyle)	00-02	SFA336				MD965D						24
CV 50 ZR Evolution (5PT1)	01-02	SFA336				MD965D						25
CV 50 A/R Jog (5SU2/1)/SA/EJ	03-08	SFA384				MD965D						26
CW 50 RS (4YA1/2/BWs) (180mm front disc)	96-97	SFA193	SFAC193		SFA193HH	MD916D						27
CW 50 RSP (5CC1/3/4YA BWs Spy) (180mm front disc)	97-98	SFA193	SFAC193		SFA193HH	MD916D						28
CW 50 RS (4YA4/BWs NG) (180mm front disc)	98	SFA193	SFAC193		SFA193HH	MD916D						29
CW 50 RS (5FXA/VG5SA BWs) (190mm front disc)	99	SFA193	SFAC193		SFA193HH	MD923D				VR923		30
CW 50 RS (5FXJ/VG5SA BWs) (190mm front disc)	00	SFA193	SFAC193		SFA193HH	MD923D				VR923		31
CW 50 RS (5FXM/VG5SA BWs) (190mm front disc)	01-05	SFA193	SFAC193		SFA193HH	MD923D				VR923		32
CW 50 (5MS2/4G54R)	02	SFA193	SFAC193		SFA193HH	MD923D				VR923		33
CW 50 (5WW4/BWs)	04-07	SFA193	SFAC193		SFA193HH	MD916D						34
CY 50 Jog-in	91-95	Y519										35
DT 50 LC	98-	FA119TT			FA119R	MD6158D		MD6158C				36
DT 50 M/MX	78-86	Y504			Y504G							37
DT 50 MX	87-91	Y518			Y518G							38
DT 50 MX	92-95	Y503			Y503G							39
DT 50 R	97-01	FA116				MD6214D						40
DT 50 R	02-08	FA350			FA350HH	MD6297D						41
DT 50 X (Supermotard)	04-08	FA194			FA194HH	MD6279D						42
DT 50 R-L (SM-5VB1/VG55BK)	02-03	FA116				MD6214D						43
EC-03 (Electric Bike)	11-15	Y519										44
EW 50 Slider	00-05	SFA268	SFAC268		SFA268HH	MD923D				VR923		45
FS1E	74-76	Y504										46
FS1E DX	77-79	FA028										47
FS1 DX	79-80	FA042										48
FS1 SE	81-82	Y504										49
FS1	87-90	Y518										50
CY 50 RS Jog R	96-	SFA169	SFAC169		SFA169HH	MD904D				VR904		51
LC 50 M Bop	80	Y519										52
MA 50 M QT 50	80-86	Y501										53
MJ 50 M Towny	82	Y501										54
MS 50	85-86	Y501										55
NS 50 Aerox (2T)	13-16	SFA193	SFAC193		SFA193HH	MD923D				VR923		56
NS 50 N Aerox Naked (2T)	13-16	SFA193	SFAC193		SFA193HH	MD923D				VR923		57
PW 50	80-21	Y501										58
RD 50 M	78	FA028										59
RD 50 M	79-80	FA042										60

*-2 Sets Required. † For Vee disc colours add RED, BLU, GRN, GLD, ORG suffix to part number. For Custom Finish Options for Vee-Rotors™ including Splatter discs add suffix CHR, CHGR, CHBL, CHBR - available in various colours see page iv. ☼ - Also available as a Vintage Motorcycle Disc.

148 Part numbers, prefixes, suffixes, photos and illustrations shown in this catalogue are trademarks and/or copyrights of EBC Brakes or the trademark owner A C Freeman Investments Ltd and use without express written permission of the owners is punishable by law.

JAPANESE Built Motorcycles

Line #	BRAKE DISC CHOICES - FRONT						DISC PAD CHOICES - REAR				BRAKE DISC CHOICES - REAR			
	Oversize 250 /280mm Disc Kit	OSX Oversize 250/280mm Disc Kit	Relocating Bracket for 250/ 280mm Disc	Oversize 320mm Disc Kit	SMX Oversize 320mm Disc Kit	Relocating Bracket for 320mm Disc	FA, SFA, TT Pad or Brake Shoe	SFAC Carbon Scooter Pads	Speciality Pads - SXR / Vee / MXS	Sintered/ HH Pads/ Grooved Shoes	Standard Replacement Disc	Contour Disc Rear fitment	Vee Discs CONTOUR	CX Extreme MX Race Disc
1							SFA268	SFAC268		SFA268HH	MD923D		VR923	
2							SFA268	SFAC268		SFA268HH	MD923D		VR923	
3							Y530							
4							Y530							
5							Y518							
6														
7							Y503							
8							Y503							
9							Y503							
10							Y530							
11							Y530							
12							Y503							
13							Y530							
14							Y503							
15							Y519							
16							Y519							
17							Y503							
18							Y503							
19							Y530							
20							Y503							
21							Y530							
22							Y503							
23							Y503							
24							Y530							
25							Y530							
26							Y530							
27							Y503							
28							Y503							
29							Y503							
30							Y503							
31							Y503							
32							Y503							
33							Y503							
34							Y530							
35							Y518							
36							Y503							
37							Y504		Y504G					
38							Y518		Y518G					
39							Y503		Y503G					
40							Y503							
41							FA350		FA350HH	MD6280D				
42							FA350		FA350HH	MD6280D				
43							FA382			MD6286D				
44														
45							Y503							
46							Y504							
47							Y504							
48							Y504							
49							Y504							
50							Y518							
51							Y503							
52							Y519							
53							Y501							
54							Y501							
55							Y519							
56							SFA268	SFAC268		SFA268HH	MD923D		VR923	
57							SFA268	SFAC268		SFA268HH	MD923D		VR923	
58							Y501							
59							Y504							
60							Y504							

REAR / ARRIÈRE / HINTEN / POSTERIOR / POSTERIORE

*-2 Sets Required. † For Vee disc colours add RED, BLU, GRN, GLD, ORG suffix to part number. For Custom Finish Options for Vee-Rotors™ including Splatter discs add suffix CHR, CHGR, CHBL, CHBR - available in various colours see page iv. ☉ - Also available as a Vintage Motorcycle Disc.

R Suffix = High Durability Sintered Pad. **HH** Suffix = High Performance Sintered Pad. **TT** Suffix = Hard Wearing Off Road Pad. **V** Suffix = Semi Sintered Pad. **G** Suffix = Grooved Shoe.
D Suffix = Drilled Disc. **X** Suffix = Universal Left or Right Disc. **XC** Suffix = Contoured Disc. **LS** Suffix = Left/Steel Disc. **RS** = Right/Steel Disc.

BRAKE APPLICATIONS

JAPANESE Built Motorcycles



YAMAHA Contd.



DISC PAD CHOICES - FRONT

BRAKE DISC CHOICES - FRONT

R Suffix = High Durability Sintered Pad. **HH** Suffix = High Performance Sintered Pad. **TT** Suffix = Hard Wearing Off Road Pad. **V** Suffix = Semi Sintered Pad. **G** Suffix = Grooved Shoe.

D Suffix = Drilled Disc. **X** Suffix = Universal Left or Right Disc. **XC** Suffix = Contoured Disc. **LS** Suffix = Left/Steel Disc. **RS** = Right/Steel Disc.

FRONT / AVANT / VORN / FRENTE / ANTERIORE

		FA, SFA, TT Pad or Brake Shoe	SFAC Carbon Scooter Pads	Speciality Pads - SXR / Vee / MXS	Sintered/HH Pads/ Grooved Shoes	Left / Gauche / Links Standard Replacement Disc	Right / Droite / Rechts Standard Replacement Disc	Contour Disc Universal left and right fitment	Custom Disc Universal left and right fitment	Vee-Disks Black † See note below	CX Extreme MX Race Disc/ UTVX Disc	Line #
RD 50/RD 50 MX	81-87	FA070										1
RZ 50 (5FC1/2)	02	FA275			FA275HH							2
SA 50 M/ME Passola	80-84	Y501										3
T 50 Townmate	86	Y518										4
TT-R 50 E	06-21	H301										5
TY 50/50 M	77-80	Y504			Y504G							6
TZR 50 Thunderkid (41V21) (5DU1/3)	97-00	FA197			FA197HH		MD2067					7
TZR 50	03-16	FA194			FA194HH	MD672LS						8
V 50 M/P	74-82	Y504										9
V 50 M	83	Y518										10
XC 50 X Vino Classic (SA26J)	08	Y530										11
XF 50 Giggle/Vox	07-12	Y530										12
YA 50 R Axis (4PC)	95-96	SFA193	SFAC193		SFA193HH	MD904D		MD904C		VR904		13
YA 50 ZA Jog Z (4SC1)	95	SFA169	SFAC169		SFA169HH							14
Yamy 50 (2T)	86-	Y525										15
YB-1 (50cc) (5JE1/3)	01-02	Y531										16
YFM 50 S/T/RV/RW/RX Raptor	04-09	Y503*			Y503G*							17
YSR 50 T	87	FA101										18
YJ 50 R (5AU1-3) Vino	98-	Y519			Y519G							19
YZ 50 G/H/J/K	80-83	Y502			Y502G							20
YE 50 Zest	93-95	SFA193	SFAC193		SFA193HH	MD904D		MD904C		VR904		21
YFZ 50 Quad	17-20	H346	H346									22
YH 50 Why	99-09	SFA193	SFAC193		SFA193HH	MD928D						23
YM 50 Breeze (4KH)	94-95	SFA193	SFAC193		SFA193HH	MD904D		MD904C		VR904		24
YN 50 R Neos (5AD/5MR/5RN3)	97-02	SFA193	SFAC193		SFA193HH	MD943D		MD943C		VR943		25
YN 50 Neos (5RN/1P9)	02-06	SFA193	SFAC193		SFA193HH	MD943D		MD943C		VR943		26
YN 50 Neos (2T) (1F5C2/1H5C2)	07-16	SFA193	SFAC193		SFA193HH	MD943D		MD943C		VR943		27
YN 50 Neos F (4T)	09-20	SFA193	SFAC193		SFA193HH	MD943D		MD943C		VR943		28
YN 50 Neos Easy (2T)	14-15	Y530										29
YV 50 (5BM2) Jog Space Innovation	97-	Y519			Y519G							30
YQ 50 Aerox/Aerox-R	97-12	SFA193	SFAC193		SFA193HH	MD923D		MD923C		VR923		31
YT 60 Tri Zinger	83	None										32
YF 60 S	88	None										33
YZ 65 J	18-21	FA119TT			FA119R			MD6418C			MD6418CX	34
V 70 A	76	Y504										35
V 75 A	77	Y504										36
CV 80 Beluga	81-83	Y503										37
DT 80 LC (37A)	81-84	FA081			FA081R							38
DT 80 LC-2 (53V)	85-92	FA101TT			FA101R							39
DT 80 MX	81-83	Y504			Y504G							40
DT 80 MX 36N Type/MXS	83-85	Y518			Y518G							41
LB2/80 Bop 2	80	Y504										42
PW 80 K/S/91	83-91	Y502			Y502G							43
PW 80	93-13	Y502			Y502G							44
RD 80 (Air cooled)	82	FA070										45
RD 80 LC	82	FA081			FA081R							46
T 80 Townmate	83-97	Y518										47
TY 80	77	Y502			Y502							48
TY 80	83-	Y502			Y502							49
V 80	79-82	Y504										50
V 80 DL	83	Y518										51
YFM 80 S	87	None										52
YFM 80 D/E/F/G/H/J/K/L/M/N Badger	92-01	Y503*			Y503G*							53
YFM 80 WP/WR/WS/RT/RV/RW/RX Raptor	02-08	Y503*			Y503G*							54
YFM 80 GT/GV/GW/GX Grizzly	05-08	Y503*			Y503G*							55
YZ 80 D/E/F	77-79	Y502			Y502G							56
YZ 80 G/H/J/K/L/N	80-85	Y502			Y502G							57
YZ 80 S/T/U/W	86-89	FA119TT			FA119R	MD6029D						58
YZ 80 E/F/L/WF/LWG/G/LWH/H/LWJ/J/LWK/K/L/LWL/M												59
/LWN/LWN	93-01	FA119TT			FA119R	MD6030D		MD6030C			MD6030CX	60

*-2 Sets Required. † For Vee disc colours add RED, BLU, GRN, GLD, ORG suffix to part number. For Custom Finish Options for Vee-Rotors™ including Splatter discs add suffix CHR, CHGR, CHBL, CHBR - available in various colours see page iv. ☼ - Also available as a Vintage Motorcycle Disc.

JAPANESE Built Motorcycles

Line #	BRAKE DISC CHOICES - FRONT						DISC PAD CHOICES - REAR				BRAKE DISC CHOICES - REAR			
	OverSize 250 /280mm Disc Kit	OSX OverSize 250/280mm Disc Kit	Relocating Bracket for 250/ 280mm Disc	OverSize 320mm Disc Kit	SMX OverSize 320mm Disc Kit	Relocating Bracket for 320mm Disc	FA, SFA, TT Pad or Brake Shoe	SFAC Carbon Scooter Pads	Speciality Pads - SXR / Vee / MXS	Sintered/ HH Pads/ Grooved Shoes	Standard Replacement Disc	Contour Disc Rear fitment	Vee Discs CONTOUR	CX Extreme MX Race Disc
1							Y504							
2							Y503							
3							Y519			Y519G				
4							Y518							
5							H301							
6							Y504			Y504G				
7							FA101				MD2077			
8							FA115			FA115HH	MD2113			
9							Y504							
10							Y518							
11							Y530							
12							Y530							
13							Y503							
14							Y503							
15							Y525							
16							Y531							
17							Y527			Y527G				
18							Y503							
19							Y503							
20							Y502			Y502G				
21							Y518							
22							H307							
23							Y503							
24							Y503							
25							Y503							
26							Y503							
27							Y530							
28							Y530							
29							Y530							
30							Y503							
31							SFA268	SFAC268		SFA268HH	MD923D	MD923C	VR923	
32							Y518			Y518G				
33							Y518			Y518G				
34							FA084/3TT		MXS084/3	FA084/3R	MD6419D	MD6419C	MD6419CX	
35							Y504							
36							Y504							
37							Y503							
38							Y506							
39							Y506							
40							Y504			Y504G				
41							Y518			Y518G				
42							Y504							
43							Y518			Y518G				
44							Y503			Y503G				
45							Y504							
46							Y504							
47							Y518							
48							Y504			Y504G				
49							Y503			Y503G				
50							Y504							
51							Y518							
52							Y506			Y506G				
53							Y527			Y527G				
54							Y527			Y527G				
55							Y527			Y527G				
56							Y504			Y504G				
57							Y502			Y502G				
58							Y502			Y502G				
59														
60		OSXY6030	BRK036				FA084/3TT		MXS084/3	FA084/3R	MD6031D	MD6031C	MD6031CX	

REAR / ARRIÈRE / HINTEN / POSTERIOR / POSTERIORE

R Suffix = High Durability Sintered Pad. HH Suffix = High Performance Sintered Pad. TT Suffix = Hard Wearing Off Road Pad. V Suffix = Semi Sintered Pad. G Suffix = Grooved Shoe.
D Suffix = Drilled Disc. X Suffix = Universal Left or Right Disc. XC Suffix = Contoured Disc. LS Suffix = Left/Steel Disc. RS = Right/Steel Disc.

BRAKE APPLICATIONS

*-2 Sets Required. † For Vee disc colours add RED, BLU, GRN, GLD, ORG suffix to part number. For Custom Finish Options for Vee-Rotors™ including Splatter discs add suffix CHR, CHGR, CHBL, CHBR - available in various colours see page iv. ☉ - Also available as a Vintage Motorcycle Disc.

JAPANESE Built Motorcycles



YAMAHA Contd.



DISC PAD CHOICES - FRONT

BRAKE DISC CHOICES - FRONT

R Suffix = High Durability Sintered Pad. HH Suffix = High Performance Sintered Pad. TT Suffix = Hard Wearing Off Road Pad. V Suffix = Semi Sintered Pad. G Suffix = Grooved Shoe.
D Suffix = Drilled Disc. X Suffix = Universal Left or Right Disc. XC Suffix = Contoured Disc. LS Suffix = Left/Steel Disc. RS = Right/Steel Disc.

Y Z 85 (Small wheel model Front 17 Inch /Rear 14 Inch) 02-22 FA119TT
Y Z 85 (Big Wheel - 19" Front/16" Rear) 02-22 FA119TT

Model	Year	FA, SFA, TT Pad or Brake Shoe	SFAC Carbon Scooter Pads	Speciality Pads - SXR / Vee / MXS	Sintered/HH Pads/ Grooved Shoes	Left / Gauche / Links Standard Replacement Disc	Right / Droite / Rechts Standard Replacement Disc	Contour Disc Universal left and right fitment	Custom Disc Universal left and right fitment	Vee-Disks Black † See note below	CX Extreme MX Race Disc/ UTVX Disc
YZ 85 (Small wheel model Front 17 Inch /Rear 14 Inch)	02-22	FA119TT			FA119R	MD6030D		MD6030C			MD6030CX
YZ 85 (Big Wheel - 19" Front/16" Rear)	02-22	FA119TT			FA119R	MD6030D		MD6030C			MD6030CX
T 90 N (4NM1/2/3/6)	94-99	Y530									
T 90 D (4NM4/5/7)	97-99	Y530									
T 90 D (4NM8/UB02J)	00-08	Y530									
T 90 N (4NM9/UB02J)	00-08	Y530									
TT-R 90 M/N/P/R/ES/S/T/ET/EV/EW	00-07	Y502			Y502G						
V 90	78	Y504									
YFM 90 RY Raptor (No Rear Parking Brake)	09	Y536*			Y536G*						
YFM 90 RZ/RA/RB/RD Raptor (With Rear Parking Brake)	10-13	Y536*			Y536G*						
YFM 90 (Raptor 90)	16-20	H346*			H346G*						
AG 100 J (3HAA)	82	Y503			Y503G						
AG 100 E Farm Bike	93	Y503			Y503G						
DT 100	76-80	Y504			Y504G						
FIZ	97-	SFA275	SFAC275		SFA275HH						
RT 100 E/F/K	93-03	Y503			Y503G						
RS 100 (478)	75-76	Y504									
RS 100 (1Y8/Europe) (Front Disc Model/Round Type Pad)	77-78	FA028									
RS 100 (1Y8/UK)	77-78	Y504									
RS 100 (1Y9/UK)	79-81	Y504									
RS 100 DX (1Y8 Europe) (Front Disc Model/Round Type Pad)	79	FA028									
RS 100 (1Y8/Europe) (Front Disc Model/Square Type Pad)	80-82	FA028									
RXS 100	83-97	Y518									
YB 100	78-81	Y504									
YB 100	82-86	Y504									
YB 100	87-92	Y503									
YN 100 Neos 100	99-03	SFA193	SFAC193		SFA193HH	MD943D		MD943C		VR943	
YQ 100 Aerox 100	00-04	SFA193	SFAC193		SFA193HH	MD923D		MD923C		VR923	
YW 100 T Booster BWs	96	SFA169			SFA169HH						
YZ 100 E/F/G/H	78-81	Y504			Y504G						
YZ 100 J/K	82-83	Y503			Y503G						
T 105/105 E Crypton	96	Y518									
T 105 E (5ER1/2) Crypton-R	99	SFA275	SFAC275		SFA275HH	MD963D					
T 105 SE Crypton (SER3)	02	SFA275	SFAC275		SFA275HH	MD963D					
Alba (106cc 4T) (Cast wheel)	08										
G5 Libero (106cc 4T) (Cast wheel)	08										
Crux (106cc 4T) (Spoke wheel)	08										
Crypton 110cc	04	SFA197	SFAC197		SFA197HH						
TT-R 110 E	08-21	Y502			Y502G						
V 110 ZE/ZK/ZHE/ZHK FIZR/FIZR Sporty	96	SFA275	SFAC275		SFA275HH	MD963D					
MIO (113cc)	05-07	SFA336									
MIO Sporty (113cc)	05-07	SFA336									
Nouvo-Z (113cc)	06-07	SFA336									
AT 115 (2B81/2/3) Neo (Brasil)	05-07	SFA275	SFAC275		SFA275HH		MD963D				
AT 115 (15S1) (Neo CVT/Brasil)	08	SFA275	SFAC275		SFA275HH		MD963D				
Crypton S 115	18-19										
RX 115 (5FS3)	99	FA081			FA081R						
XC 115 S D'elight	14-16	SFA464	SFAC464								
AS3 125	71-72	Y522									
BL 125 Beluga	85	Y521									
BWs 125 - See YW 125	10-13										
Cygnus X (5ML) 220mm O/D Disc - See NXC 125	04-06										
Cygnus X (4P9) 240mm O/D Disc - See NXC 125	07-13										
D'elight 125	17-20	SFA694	SFAC694								
DT 125 E/MX/LC	74-85	Y506			Y506						
DT 125 LC	86-87	FA101TT		MXS101	FA101R	MD6067D					
DT 125 R	88-03	FA101TT		MXS101	FA101R	MD6039D					
DT 125 RE	04	FA101TT		MXS101	FA101R	MD6039D					

FRONT / AVANT / VORN / FRENTE / ANTERIORE

Line #
1
2
3
4
5
6
7
8
9
10
11
12
13
14
15
16
17
18
19
20
21
22
23
24
25
26
27
28
29
30
31
32
33
34
35
36
37
38
39
40
41
42
43
44
45
46
47
48
49
50
51
52
53
54
55
56
57
58
59
60

*-2 Sets Required. † For Vee disc colours add RED, BLU, GRN, GLD, ORG suffix to part number. For Custom Finish Options for Vee-Rotors™ including Splatter discs add suffix CHR, CHGR, CHBL, CHBR - available in various colours see page iv. ☼ - Also available as a Vintage Motorcycle Disc.

JAPANESE Built Motorcycles

Line #	BRAKE DISC CHOICES - FRONT						DISC PAD CHOICES - REAR				BRAKE DISC CHOICES - REAR			
	Oversize 250 /280mm Disc Kit	OSX Oversize 250/280mm Disc Kit	Relocating Bracket for 250/ 280mm Disc	Oversize 320mm Disc Kit	SMX Oversize 320mm Disc Kit	Relocating Bracket for 320mm Disc	FA, SFA, TT Pad or Brake Shoe	SFAC Carbon Scooter Pads	Speciality Pads - SXR / Vee / MXS	Sintered/ HH Pads/ Grooved Shoes	Standard Replacement Disc	Contour Disc Rear fitment	Vee Discs CONTOUR	CX Extreme MX Race Disc
1														
2		OSXY6030	BRK036				FA084/3TT	MXS084/3	FA084/3R	MD6031D	MD6031C		MD6031CX	
3		OSXY6030	BRK036				FA084/3TT	MXS084/3	FA084/3R	MD6031D	MD6031C		MD6031CX	
4							Y530							
5							Y530							
6							Y530							
7							Y530							
8							Y503		Y503G					
9							Y504							
10							FA083TT		FA083R	MD6282D				
11							FA067TT		FA067R	MD6282D				
12							H307*		H307C*					
13							Y527		Y527G					
14							Y527		Y527G					
15							Y506		Y506G					
16							Y503							
17							Y503		Y503G					
18							Y504							
19							Y504							
20							Y504							
21							Y504							
22														
23							Y504							
24							Y504							
25							Y518							
26							Y504							
27							Y503							
28							Y503							
29							Y527							
30							Y527							
31							Y527							
32							Y506		Y506G					
33							Y506		Y506G					
34							Y518							
35							Y518							
36							Y518							
37														
38														
39														
40							Y518							
41							Y503		Y503G					
42							Y518							
43														
44														
45														
46							Y531							
47							Y531							
48														
49							Y518							
50							Y531							
51							Y506							
52							Y506							
53														
54														
55														
56							Y531							
57							Y506		Y506G					
58							Y506		Y506G					
59							FA101TT	MXS101	FA101R	MD6115D				
60							FA101TT	MXS101	FA101R	MD6115D				

REAR / ARRIÈRE / HINTEN / POSTERIOR / POSTERIORE

R Suffix = High Durability Sintered Pad. **HH** Suffix = High Performance Sintered Pad. **TT** Suffix = Hard Wearing Off Road Pad. **V** Suffix = Semi Sintered Pad. **G** Suffix = Grooved Shoe.
D Suffix = Drilled Disc. **X** Suffix = Universal Left or Right Disc. **XC** Suffix = Contoured Disc. **LS** Suffix = Left/Steel Disc. **RS** = Right/Steel Disc.

BRAKE APPLICATIONS

*-2 Sets Required. † For Vee disc colours add RED, BLU, GRN, GLD, ORG suffix to part number. For Custom Finish Options for Vee-Rotors™ including Splatter discs add suffix CHR, CHGR, CHBL, CHBR - available in various colours see page iv. ☉ - Also available as a Vintage Motorcycle Disc.

JAPANESE Built Motorcycles



YAMAHA Contd.



DISC PAD CHOICES - FRONT

BRAKE DISC CHOICES - FRONT

R Suffix = High Durability Sintered Pad. **HH** Suffix = High Performance Sintered Pad. **TT** Suffix = Hard Wearing Off Road Pad. **V** Suffix = Semi Sintered Pad. **G** Suffix = Grooved Shoe.

D Suffix = Drilled Disc. **X** Suffix = Universal Left or Right Disc. **XC** Suffix = Contoured Disc. **LS** Suffix = Left/Steel Disc. **RS** = Right/Steel Disc.

FRONT / AVANT / VORN / FRENTE / ANTERIORE

		FA, SFA, TT Pad or Brake Shoe	SFAC Carbon Scooter Pads	Speciality Pads - SXR / Vee / MXS	Sintered/HH Pads/ Grooved Shoes	Left / Gauche / Links Standard Replacement Disc	Right / Droite / Rechts Standard Replacement Disc	Contour Disc Universal left and right fitment	Custom Disc Universal left and right fitment	Vee-Disks Black † See note below	CX Extreme MX Race Disc/ UTVX Disc	Line #
DT 125 RE	05-07	FA101TT		MXS101	FA101R	MD6039D						1
DT-Z 125 Tenere/Tenere Scout	89-90	FA166										2
DT 125 Chesterfield Scout	89-90	FA166										3
DT 125 (3TT4)	96	Y527			Y527G							4
DT 125 X	05-06	FA209/2			FA209/2HH	MD6235D						5
FZS 25	19-20	FA464										6
GT 125 Hammerhead	12-18	FA181TT				MD6158D		MD6158C				7
IT 125 G/H/J	80-82	Y504			Y504G							8
XQ 125/150 N Maxster - See XQ 125/150 N	01-03											9
Majesty 125 - See YP 125	98-00											10
Majesty 125 - See YP 125	01-06											11
Majesty 125 FA (SCA9) (Taiwan Production) - See YP125	02											12
Majesty 125 - See YP125	04-09											13
Majesty S 125 - See XC 125 R	15	SFA142	SFAC142		SFA142HH					VR9145		14
MT 125 (Non ABS)	14-19	FA432			FA432HH	MD2121X						15
MT 125 A (ABS)	19-21	FA432			FA432HH	MD2121X						16
N-Max 125	15-21	SFA694	SFAC694					MD9156D				17
NCX 125 K Cygnus X Cab (4C6-1)	07-10	SFA632						MD9133D		VR9133		18
NCX 125 L Cygnus X Injection (4C6-2)	07-10	SFA632						MD9133D		VR9133		19
NXC 125 Cygnus X (5ML) 220mm O/D Disc	04-06	SFA393	SFAC393					MD986D		VR986		20
NXC 125 Cygnus X (4P9) 240mm O/D Disc	07-13	SFA393	SFAC393					MD9133D		VR9133		21
RD 125 DX	75-77	FA028										22
RD 125 DX	78-81	FA042										23
RD 125 LC	82-84	FA081			FA081R							24
RD 125 LC (MK2/3)	85-87	FA104			FA104HH			MD2053RS				25
RD 125	73-74	Y522										26
RS 125	75	Y510										27
RS 125 DX	76-80	FA028										28
RS 125 DX	81	FA042										29
RZ 125 (1GV 030101-)	85	FA104			FA104HH			MD2053RS				30
SR 125 SE	82	Y506										31
SR 125 (3MW2 Type)	89-91	Y506/Y527										32
SR 125 SE	92-96	FA081			FA081R							33
SR 125	97-03	FA199			FA199HH	MD2085LS						34
TDR 125 (4GW/GX1/2/3/4)	93-03	FA199			FA199HH	MD6116D						35
TDR 125 (3HS1/3XD0/3SH3/3XD1)	89-93	FA134				MD2003X		MD2003XC	MD2003CC	VR2003BLK†		36
TDR 125 R (3SH2/3XE2) Lightburner	93-94	FA134				MD2003X		MD2003XC	MD2003CC	VR2003BLK†		37
Tricity 125	Left 14-16	SFA652				MD9146D						38
	Right	SFA655					MD9146D					39
Tricity 125 ABS	Left 17-20	SFA652				MD9146D						40
	Right	SFA655					MD9146D					41
TT-R 125 M/N/P/R/S/ES/T/ET/EV/EW/EX/EY	00-09	Y503			Y503G							42
TT-R 125 LW	00-21	FA119TT			FA119R	MD6158D		MD6158C				43
TW 125 (5EK)	99-02	FA275TT			FA275HH	MD6067D						44
TW 125 (5RS)	03-04	FA275TT			FA275HH	MD6067D						45
TY 125	82	Y504			Y504G							46
TZR 125 (2RK/3PC1)	87-89	FA104			FA104HH			MD2053RS				47
TZR 125 (3PC2/3PC3)	90-92	FA088			FA088HH			MD2056RS				48
TZR 125 (3JB/4JB/4HW/4HX)	93-95	FA252			FA252HH			MD2022RS				49
TZR 125 R (4DL1/4DL2) Brembo caliper	91-93	FA095			FA095HH			MD2003X	MD2003XC	MD2003CC	VR2003BLK†	50
TZR 125 RR (4DL3) Brembo caliper	94-95	FA095			FA095HH			MD2003X	MD2003XC	MD2003CC	VR2003BLK†	51
Vity 125 - See XC 125E	08-13											52
VP 125 X-City (16P)	08-15	SFA196	SFAC196		SFA196HH	MD9130D						53
WR 125 X (Supermoto)	09-18	FA142			FA142HH	MD6235D						54
WR 125 R	09-15	FA142			FA142HH							55
X-City - See VP 125 X-City	08-15											56
XC 125 Beluga	92	Y521										57
XC 125 Beluga	93-95	Y521										58
XC 125 T Cygnus	95-98	Y527										59
XC 125 TR Cygnus	96-03	SFA101	SFAC101		SFA101HH							60

*-2 Sets Required. † For Vee disc colours add RED, BLU, GRN, GLD, ORG suffix to part number. For Custom Finish Options for Vee-Rotors™ including Splatter discs add suffix CHR, CHGR, CHBL, CHBR - available in various colours see page iv. ☼ - Also available as a Vintage Motorcycle Disc.

JAPANESE Built Motorcycles

Line #	BRAKE DISC CHOICES - FRONT						DISC PAD CHOICES - REAR				BRAKE DISC CHOICES - REAR			
	Oversize 250 /280mm Disc Kit	OSX Oversize 250/280mm Disc Kit	Relocating Bracket for 250/ 280mm Disc	Oversize 320mm Disc Kit	SMX Oversize 320mm Disc Kit	Relocating Bracket for 320mm Disc	FA, SFA, TT Pad or Brake Shoe	SFAC Carbon Scooter Pads	Speciality Pads - SXR / Vee / MXS	Sintered/ HH Pads/ Grooved Shoes	Standard Replacement Disc	Contour Disc Rear fitment	Vee Discs CONTOUR	CX Extreme MX Race Disc
1							FA152TT		MXS152	FA152R	MD6121D			
2							FA157							
3							FA157							
4							Y527			Y527G				
5							FA152TT		MXS152	FA152R	MD6121D			
6							SFA181	SFAC181						
7							FA152TT		MXS152	FA152R	MD6011D			
8							Y506			Y506G				
9														
10														
11														
12														
13														
14							SFA213			SFA213HH			VR9133	
15							FA377			FA377HH	MD2122			
16							FATT152			FA152R	MD2122			
17							SFA464	SFAC464			MD9157D			
18							Y533							
19							Y533							
20							Y533							
21							Y533							
22							Y506							
23							Y510							
24									Y506					
25							Y506							
26							Y506							
27							Y506							
28							Y506							
29							Y506							
30							Y506							
31							Y503							
32							Y503/Y518							
33							Y518							
34							Y503							
35							FA101TT				MD6115D			
36							FA173							
37							FA047				MD2021	MD2021C	VR2021	
38							SFA343				MD9147D			
39														
40							SFA464				MD9157D			
41														
42							Y503			Y503G				
43							Y503			Y503G				
44							Y503			Y503G				
45							Y531							
46							Y506			Y506G				
47							Y506							
48							FA104			FA104HH	MD2021			
49							FA104			FA104HH	MD2021			
50							FA047			FA047HH	MD2021	MD2021C	VR2021	
51							FA047			FA047HH	MD2021	MD2021C	VR2021	
52														
53							SFA266	SFAC266		SFA266HH	MD9104D			
54							FA213			FA213HH	MD6121D			
55							FA213			FA213HH		MD6121C		
56														
57							Y506							
58							Y527							
59							Y503							
60							Y503							

REAR / ARRIÈRE / HINTEN / POSTERIOR / POSTERIORE

R Suffix = High Durability Sintered Pad. **HH** Suffix = High Performance Sintered Pad. **TT** Suffix = Hard Wearing Off Road Pad. **V** Suffix = Semi Sintered Pad. **G** Suffix = Grooved Shoe.
D Suffix = Drilled Disc. **X** Suffix = Universal Left or Right Disc. **XC** Suffix = Contoured Disc. **LS** Suffix = Left/Steel Disc. **RS** = Right/Steel Disc.

*-2 Sets Required. † For Vee disc colours add RED, BLU, GRN, GLD, ORG suffix to part number. For Custom Finish Options for Vee-Rotors™ including Splatter discs add suffix CHR, CHGR, CHBL, CHBR - available in various colours see page iv. ☉ - Also available as a Vintage Motorcycle Disc.

BRAKE APPLICATIONS

JAPANESE Built Motorcycles



YAMAHA Contd.



DISC PAD CHOICES - FRONT

BRAKE DISC CHOICES - FRONT

FA, SFA, TT Pad or Brake Shoe	SFAC Carbon Scooter Pads	Speciality Pads - SXR / Vee / MXS	Sintered/HH Pads/ Grooved Shoes	Left / Gauche / Links Standard Replacement Disc	Right / Droite / Rechts Standard Replacement Disc	Contour Disc Universal left and right fitment	Custom Disc Universal left and right fitment	Vee-Disks Black † See note below	CX Extreme MX Race Disc/ UTVX Disc
XC 125 E Vity (4P7)	SFA464	SFAC464			MD9127D			VR9127	
XC 125 R Majesty S 125	SFA142	SFAC142	SFA142HH	MD9145D				VR9145BLK	
Xenter 125	SFA492	SFAC492		MD9154D					
X-Max 125 (2DM/Brembo R/Caliper)									
- See YP 125 R X-Max	SFA196	SFAC196	SFA196HH	MD9102D					
X-Max 125 (2DM/Heng Tong R/Caliper)									
- See YP 125 R X-Max	SFA196	SFAC196	SFA196HH	MD9102D					
X-Max 125 R (1B9/Brembo F/Caliper) - See YP 125 R	SFA430	SFAC430	SFA430HH		MD9102D			VR9102	
X-Max 125 Non ABS (39D1/5/Nissin F/Caliper)									
- See YP 125 R	SFA196	SFAC196	SFA196HH		MD9102D			VR9102	
X-Max 125 R Sport Non ABS (Nissin F/Caliper)									
- See YP 125 R Sport	SFA196	SFAC196	SFA196HH		MD9102D			VR9102	
X-Max 125 ABS (39D2/Nissin F/Caliper) - See YP 125 RA	SFA196	SFAC196	SFA196HH		MD9102D			VR9102	
X-Max 125 ABS	SFA705	SFAC705	SFA705HH		MD9169D				
X-Max 125 ABS Tech Max	SFA705	SFAC705	SFA705HH		MD9169D				
X-Max 125 R Business ABS - See YP 125 R	SFA196	SFAC196	SFA196HH		MD9102D			VR9102	
X-Max 125 Momo Design inc ABS	SFA196	SFAC196	SFA196HH		MD9102D				
XN 125 N Teos	SFA193	SFAC193	SFA193HH	MD907D				VR907	
XP 125 RA X-Max - Iron-Max (ABS)	SFA196	SFAC196	SFA196HH	MD9102D					
XT 125	Y506		Y506G						
XT 125 R (3D61/3D63) 21 Inch/18 Inch Wheels	FA350		FA350HH	MD6297D					
XT 125 R (13D1) 21 Inch/18 Inch Wheels	FA350		FA350HH	MD6297D					
XT 125 R (13D3/13D5) 21 Inch/18 Inch Wheels	FA350		FA350HH	MD6297D					
XT 125 X (3D62/3D64) 17 Inch Wheels	FA194		FA194HH	MD6279D					
XT 125 X (13D2) 17 Inch Wheels	FA194		FA194HH	MD6279D					
XT 125 X (13D4/13D6) 17 Inch Wheels	FA194		FA194HH	MD6279D					
XTZ 125 (5RM)	FA135TT		FA135R	MD6067D					
XV 125 Virago	FA199		FA199HH	MD2067					
XVS 125 Dragstar	FA199		FA199HH		MD2067				
XQ 125/150 N Maxster	SFA181	SFAC181	SFA181HH	MD957D				VR957	
YFA1W/A/B Breeze	Y503*		Y503G*						
YFA1D/F/G/H/J/K/L/M/N/P/R Breeze	Y503*		Y503G*						
YBA 125 Enticer (3P01/3P41)	SFA181	SFAC181	SFA181HH						
YBR 125 E/K (5HH1/2/C/G/J/SLX/SLX9)									
(Drum front/Brasil)	Y527								
YBR 125 ED (5HHB/F/H) (Disc front/Brasil)	FA228		FA228HH						
YBR 125 Custom	FA464				MD2104RS				
YBR 125 ED (3D91)	FA101				MD2097RS				
YBR 125 (3D92/9)	FA464				MD2104RS				
YBR 125 (51D1/2)	FA464				MD2104RS				
YFM 125 S/GT/GV/GW/GX/GY/GZ/GA/GB/GD Grizzly	Y503*		Y503G*						
YP 125 Majesty	SFA181	SFAC181	SFA181HH	MD907D				VR907	
YP 125 Majesty	SFA181	SFAC181	SFA181HH	MD907D				VR907	
YP 125 Majesty FA (SCA9) (Taiwan Production)	SFA196	SFAC196	SFA196HH		MD979D				
YP 125 Majesty	SFA181	SFAC181	SFA181HH	MD907D				VR907	
YS 125	FA464				MD2104RS				
YW 125 (BWs 125/1CE1)	SFA492	SFAC492		MD986D				VR986	
YW 125 X (1DN1/2)	SFA632							VR9133	
YW 125 G Zuma (Rear disc model)	SFA196	SFAC196		MD986D					
YZ 125 C/D/E/F/G/H/J (2T)	Y507		Y507G						
YZ 125 K (2T)	Y507		Y507G						
YZ 125 L (2T)	Y508		Y508G						
YZ 125 N (2T)	FA105TT		FA105R	MD6324D					
YZ 125 S (2T)	FA105TT		FA105R	MD6067D					
YZ 125 T (2T)	FA105TT		FA105R	MD6067D					
YZ 125 U (2T)	FA105TT		FA105R	MD6039D					
YZ 125 W (2T)	FA135TT		FA135R	MD6016D					
YZ 125 D/E/F/G/H/J (2T)	FA135TT	MXS135	FA135R	MD6028D		MD6028C		MD6028CX	
YZ 125 K/L/M (2T)	FA185TT	MXS185	FA185R	MD6028D		MD6028C		MD6028CX	
YZ 125 N (2T)	FA185TT	MXS185	FA185R	MD6356D		MD6356C		MD6356CX	

FRONT / AVANT / VORN / FRENTE / ANTERIORE

Line #

R Suffix = High Durability Sintered Pad. HH Suffix = High Performance Sintered Pad. TT Suffix = Hard Wearing Off Road Pad. V Suffix = Semi Sintered Pad. G Suffix = Grooved Shoe. D Suffix = Drilled Disc. X Suffix = Universal Left or Right Disc. XC Suffix = Contoured Disc. LS Suffix = Left/Steel Disc. RS = Right/Steel Disc.

*-2 Sets Required. † For Vee disc colours add RED, BLU, GRN, GLD, ORG suffix to part number. For Custom Finish Options for Vee-Rotors™ including Splatter discs add suffix CHR, CHGR, CHBL, CHBR - available in various colours see page iv. ☼ - Also available as a Vintage Motorcycle Disc.

JAPANESE Built Motorcycles

Line #	BRAKE DISC CHOICES - FRONT						DISC PAD CHOICES - REAR				BRAKE DISC CHOICES - REAR			
	Oversize 250 /280mm Disc Kit	OSX Oversize 250/280mm Disc Kit	Relocating Bracket for 250/ 280mm Disc	Oversize 320mm Disc Kit	SMX Oversize 320mm Disc Kit	Relocating Bracket for 320mm Disc	FA, SFA, TT Pad or Brake Shoe	SFAC Carbon Scooter Pads	Speciality Pads - SXR / Vee / MXS	Sintered/ HH Pads/ Grooved Shoes	Standard Replacement Disc	Contour Disc Rear fitment	Vee Discs CONTOUR	CX Extreme MX Race Disc
1							Y530							
2							SFA213			SFA213HH			VR9133	
3							Y533							
4														
5							SFA266	SFAC266		SFA266HH	MD9153D			
6														
7							SFA678	SFAC678		SFA678HH	MD9153D			
8							SFA266	SFAC266		SFA266HH	MD9104D		VR9104	
9														
10							SFA266	SFAC266		SFA266HH	MD9104D		VR9104	
11														
12							SFA266	SFAC266		SFA266HH	MD9104D		VR9104	
13							SFA275	SFAC275		SFA275HH	MD9108D			
14							SFA706	SFAC706		SFA706HH	MD9168D			
15							SFA706	SFAC706		SFA706HH	MD9168D			
16							SFA275	SFAC275		SFA275HH	MD9108D			
17							SFA275	SFAC275		SFA275HH	MD9108D			
18							Y527							
19							SFA275	SFAC275		SFA275HH	MD9108D			
20							Y503			Y503G				
21							FA350			FA350HH	MD6280D			
22							FA350			FA350HH	MD6280D			
23							FA350			FA350HH	MD6280D			
24							FA350			FA350HH	MD6280D			
25							FA350			FA350HH	MD6280D			
26							FA350			FA350HH	MD6280D			
27							Y527			Y527G				
28							Y527							
29							Y527							
30							SFA266	SFAC266		SFA266HH	MD958D		VR958	
31							Y506			Y506G				
32							Y527			Y527G				
33							Y506							
34														
35							Y527							
36							Y527							
37							Y535							
38							Y527							
39							Y535							
40							Y535							
41							Y527			Y527G				
42							Y527							
43							SFA266	SFAC266		SFA266HH	MD962D		VR962	
44							Y527							
45							SFA266	SFAC266		SFA266HH	MD962D		VR962	
46							Y535							
47							Y533							
48							Y533							
49							SFA123	SFAC213			MD9150D			
50							Y506			Y506G				
51							Y517			Y517G				
52							Y517			Y517G				
53							Y517			Y517G				
54							Y517			Y517G				
55							Y506			Y506G				
56							FA101TT		MXS101	FA101R	MD6011D			
57									MXS084/3	FA084/3R	MD6011D			
58	OS6028EC	OSX6028E	BRK035				FA152/2TT		MXS152	FA152/2R	MD6011D			
59	OS6028C	OSX6028	BRK008		SMX6028	BRK009	FA131TT		MXS131	FA131R	MD6135D	MD6135C		MD6135CX
60	OS6028C	OSX6028	BRK008		SMX6028	BRK009	FA131TT		MXS131	FA131R	MD6135D	MD6135C		MD6135CX

REAR / ARRIÈRE / HINTEN / POSTERIOR / POSTERIORE

R Suffix = High Durability Sintered Pad. HH Suffix = High Performance Sintered Pad. TT Suffix = Hard Wearing Off Road Pad. V Suffix = Semi Sintered Pad. G Suffix = Grooved Shoe.
D Suffix = Drilled Disc. X Suffix = Universal Left or Right Disc. XC Suffix = Contoured Disc. LS Suffix = Left/Steel Disc. RS = Right/Steel Disc.

BRAKE APPLICATIONS

*-2 Sets Required. † For Vee disc colours add RED, BLU, GRN, GLD, ORG suffix to part number. For Custom Finish Options for Vee-Rotors™ including Splatter discs add suffix CHR, CHGR, CHBL, CHBR - available in various colours see page iv. Ⓢ - Also available as a Vintage Motorcycle Disc.

JAPANESE Built Motorcycles



YAMAHA Contd.



DISC PAD CHOICES - FRONT

BRAKE DISC CHOICES - FRONT

FA, SFA, TT Pad or Brake Shoe	SFAC Carbon Scooter Pads	Speciality Pads - SXR / Vee / MXS	Sintered/HH Pads/ Grooved Shoes	Left / Gauche / Links Standard Replacement Disc	Right / Droite / Rechts Standard Replacement Disc	Contour Disc Universal left and right fitment	Custom Disc Universal left and right fitment	Vee-Disks Black † See note below	CX Extreme MX Race Disc/ UTVX Disc
YZ 125 P (2T)		MXS185	FA185R	MD6356D		MD6356C			MD6356CX
◆ Plain undrilled disc for enduro use MD6190CE									
YZ 125 R/S/T/V/W (2T)		MXS185	FA185R	MD6356D		MD6356C			MD6356CX
◆ Plain undrilled disc for enduro use MD6190CE									
YZ 125 X/Y/Z/A/B/D/E/F/G (2T)		MXS450	FA450R			MD6356C			MD6356CX
◆ Plain undrilled disc for enduro use MD6190CE									
YZ 125 (2T) 270 F/Disc, 245 R/Disc		MXS450	FA450R			MD6392C			MD6392CX
◆ Plain undrilled disc for enduro use MD6190CE									
YZ 125 (2T) 270 F/Disc, 240 R/Disc		MXS450	FA450R			MD6392C			MD6392CX
YZ 125 Monster Energy (2T) 270 F/Disc, 240 R/Disc		MXS450	FA450R			MD6392C			MD6392CX
YZ 125 X (2T) 270 F/Disc, 245 R/Disc		MXS450	FA450R			MD6392C			MD6392CX
Plain undrilled disc for enduro use MD6190CE									
YZF-R 125 (Standard Mount Front Caliper)			FA181HH	MD2110LS					
YZF-R 125 (Radial Mount Front Caliper/Non ABS)			FA432HH	MD2121X					
YZF-R 125 A (Radial Mount Front Caliper/ABS)			FA432HH	MD2121X					
YZF-R 125 (ABS)			FA432HH	MD2121X					
YZF-R 125 Monster Energy MotoGP Edition			FA432HH	MD2121X					
RX 135 (13X)			FA081R						
T135 HC/S (2S61) Crypton X/Jupiter MX/Spark 135 /Exciter/135LC Sniper				MD963D					
T135 SE (1S71) Crypton X/Jupiter MX/Spark 135 /Exciter/135LC Sniper (Automatic clutch)				MD963D					
GPD 150 A - N-Max/2DP4					MD9156D				
HW 150 - Xenter 150				MD9154D					
N-Max 150 - See GPD150 A					MD9156D				
TZR 150 R (4AP2)			FA199HH						
Xenter 150 - See HW 150				MD9154D					
N-Max 155					MD9156D				
YZF-R 15 (155cc)									
Tricity 155 ABS									
XC 155 F/G SMAX		SFA196	SFA196HH	MD9145D				VR9145BLK	
DT 175 All models		Y506	Y506G						
DT 175 (3TS4)		Y527	Y527G						
IT 175 G/H/J		Y507	Y507G						
TY 175		Y504	Y504G						
XC 180 Riva Scooter		Y521							
AG 200 E (3GX6)		Y503	Y503G						
DT 200 (2LR)		FA101TT	FA101R	MD6067D					
DT 200 R		FA101TT	FA101R	MD6039D					
DT 200 WR (3XP)		FA135TT	FA135R	MD6066D					
IT 200 L		Y517	Y517G						
RD 200 DX		FA028							
RD 200 DX		FA042							
RS 200		Y510							
SDR 200 (2TV)		FA104	FA104HH		MD2056RS				
TW 200 (2JL/4CS1/2/3/5)		FA275TT	FA275HH	MD6067D					
TW 200 (4CS4/6/5LB1/2)		FA275TT	FA275HH	MD6067D					
XC 200 Riva Scooter		Y521							
YFM 200 N		Y503*	Y503G*						
YFM 200 DXW/DX/DXA		Y503*	Y503G*						
YFS 200 B/F/G/H/J/K/L/M/N/P Blaster		Y503*	Y503G*						
YFS 200 R/S/T/V Blaster		FA054TT*	FA054R*	MD6054D	MD6054D				
YTM 200 EL/DX		Y503	Y503G						
WR 200 D/E/F		FA135TT	FA135R		MD6066D				
ST 225 (5BT) Bronco		FA275TT	FA275HH	MD6067D					
TDM 225									
TW 225 E (5VC1/2)		FA275TT	FA275HH	MD6067D					
YFM 225 S/T/U		Y503*	Y503G*						
YTM 225 DRN		Y503	Y503G						
XT 225 (2LN) (1KH 020101- Serrow)		FA101TT	FA101R	MD6067D					

FRONT / AVANT / VORN / FRENTE / ANTERIORE

Line #

R Suffix = High Durability Sintered Pad. HH Suffix = High Performance Sintered Pad. TT Suffix = Hard Wearing Off Road Pad. V Suffix = Semi Sintered Pad. G Suffix = Grooved Shoe.

D Suffix = Drilled Disc. X Suffix = Universal Left or Right Disc. XC Suffix = Contoured Disc. LS Suffix = Left/Steel Disc. RS = Right/Steel Disc.

*-2 Sets Required. † For Vee disc colours add RED, BLU, GRN, GLD, ORG suffix to part number. For Custom Finish Options for Vee-Rotors™ including Splatter discs add suffix CHR, CHGR, CHBL, CHBR - available in various colours see page iv. ☼ - Also available as a Vintage Motorcycle Disc.

JAPANESE Built Motorcycles

Line #	BRAKE DISC CHOICES - FRONT					DISC PAD CHOICES - REAR				BRAKE DISC CHOICES - REAR				
	Oversize 250 /280mm Disc Kit	OSX Oversize 250/280mm Disc Kit	Relocating Bracket for 250/ 280mm Disc	Oversize 320mm Disc Kit	SMX Oversize 320mm Disc Kit	Relocating Bracket for 320mm Disc	FA, SFA, TT Pad or Brake Shoe	SFAC Carbon Scooter Pads	Speciality Pads - SXR / Vee / MXS	Sintered/ HH Pads/ Grooved Shoes	Standard Replacement Disc	Contour Disc Rear fitment	Vee Discs CONTOUR	CX Extreme MX Race Disc
1	OS6028C	OSX6028	BRK008		SMX6028	BRK009	FA131TT		MXS131	FA131R	MD6190D	MD6190C♦		MD6190CX
2														
3	OS6028C	OSX6028	BRK008		SMX6028	BRK009	FA367TT		MXS367	FA367R	MD6190D	MD6190C♦		MD6190CX
4														
5	OS6728C	OSX6728	BRK002		SMX6728	BRK034	FA367TT		MXS367	FA367R		MD6190C♦		MD6190CX
6														
7	OSX6392C		BRK046				FA367TT		MXS367	FA367R		MD6190C♦		MD6190CX
8														
9	OSX6392C		BRK046				FA367TT		MXS367	FA367R		MD6135C		MD6135CX
10	OSX6392C		BRK046				FA367TT		MXS367	FA367R		MD6135C		MD6135CX
11	OSX6392C		BRK046				FA367TT		MXS367	FA367R		MD6190C♦		MD6190CX ♦
12														
13							FA377		FA377V	FA377HH	MD2111			
14							FA377		FA377V	FA377HH	MD2122			
15							FA377		FA377V	FA377HH	MD2122			
16							FA152			FA152R	MD2122			
17							FA152			FA152R	MD2122			
18							Y506							
19														
20							Y531							
21														
22							Y531							
23							SFA464	SFAC464			MD9157D			
24							Y533							
25							SFA464	SFAC464			MD9157D			
26							FA104			FA104HH	MD2021			
27							Y533							
28							SFA464	SFAC464			MD9157D			
29							FA152TT			FA152R				
30														
31							SFA213			SFA213HH		VR9133		
32							Y506			Y506G				
33							Y527			Y527G				
34							Y506			Y506G				
35							Y506			Y506G				
36							Y537							
37							Y527			Y527G				
38							Y506			Y506G				
39							FA101TT	MXS101		FA101R	MD6115D			
40							FA152/2TT	MXS152		FA152/2R	MD6121D			
41							Y517			Y517G				
42							Y510							
43							Y510							
44							Y510							
45							FA104			FA104HH	MD2021			
46							Y503			Y503G				
47							Y503			Y503G				
48							Y537							
49							FA021			FA021R				
50							FA021			FA021R				
51							FA155			FA155R	MD6050D			
52							FA084TT			FA084R	MD6237D			
53							FA021			FA021R				
54							FA152TT	MXS152		FA152R	MD6121D			
55							Y503			Y503G				
56														
57							Y531							
58							FA021			FA021R				
59							FA021			FA021R				
60							Y503			Y503G				

REAR / ARRIÈRE / HINTEN / POSTERIOR / POSTERIORE

R Suffix = High Durability Sintered Pad. **HH** Suffix = High Performance Sintered Pad. **TT** Suffix = Hard Wearing Off Road Pad. **V** Suffix = Semi Sintered Pad. **G** Suffix = Grooved Shoe.
D Suffix = Drilled Disc. **X** Suffix = Universal Left or Right Disc. **XC** Suffix = Contoured Disc. **LS** Suffix = Left/Steel Disc. **RS** = Right/Steel Disc.

*-2 Sets Required. † For Vee disc colours add RED, BLU, GRN, GLD, ORG suffix to part number. For Custom Finish Options for Vee-Rotors™ including Splatter discs add suffix CHR, CHGR, CHBL, CHBR - available in various colours see page iv. ⚙ - Also available as a Vintage Motorcycle Disc.

BRAKE APPLICATIONS

JAPANESE Built Motorcycles



YAMAHA Contd.



DISC PAD CHOICES - FRONT

BRAKE DISC CHOICES - FRONT

	FA, SFA, TT Pad or Brake Shoe	SFAC Carbon Scooter Pads	Speciality Pads - SXR / Vee / MXS	Sintered/HH Pads/ Grooved Shoes	Left / Gauche / Links Standard Replacement Disc	Right / Droite / Rechts Standard Replacement Disc	Contour Disc Universal left and right fitment	Custom Disc Universal left and right fitment	Vee-Disks Black † See note below	CX Extreme MX Race Disc/ UTVX Disc	Line #
XT 225 (3RW1-5 Serrow) (1KH 034101 - 132000)	FA101TT		MXS101	FA101R	MD6067D						1
XT 225 S (3RW3) (1KH 102101 - 109000 Serrow)	FA101TT		MXS101	FA101R	MD6067D						2
XT 225 (3RW4) (1KH 080101 - Serrow)	FA101TT		MXS101	FA101R	MD6067D						3
XT 225 W (4JG1/2/3/4 Serrow)	FA101TT		MXS101	FA101R	MD6067D						4
XT 225 WE (4JG5/6 Serrow)	FA275TT		MXS275	FA275HH	MD6067D						5
XT 225 (4VW1/3/5/7/9) (4VWA/B/D/G/J/L) (Brasil)	FA101TT		MXS101	FA101R	MD6067D						6
DT 230 (4TP1/2) Lanza	FA135TT		MXS135	FA135R	MD6066D						7
YFU1W/YFU1TW Pro Hauler Pro 4 (230cc)	Y528*			Y528G*							8
CP 250 (1B71) Maxam/Morphus	SFA199	SFAC199		SFA199HH		MD9107D					9
♦ Plain undrilled disc for enduro use MD6190CE											10
DT 250 All models	Y528			Y528G							11
FZR 250	FA123			FA123HH		MD2003X	MD2003XC	MD2003CC	VR2003BLK†		12
FZR 250 R (3LN)	FA220*				MD2022LS	MD2022RS					13
FZ 250 (3YX1/2/4) Zeal	FA179			FA179HH							14
IT 250 G	Y507			Y507G							15
IT 250 H/J	Y507			Y507G							16
IT 250 L	Y508			Y508G							17
Majesty - See YP 250 Majesty											18
Majesty - See YP 250 DX/A Majesty											19
Majesty - See YP 250 Majesty											20
RD 250 A				Y513							21
RD 250 B/C	FA011										22
RD 250 D	FA011										23
RD 250 E/F	FA041					MD2025RS					24
RD 250 LC	FA064					MD2019RS					25
RD 250 LC	FA070					MD2019RS					26
RZ 250 R (1AR/1XG)	FA104*			FA104HH*	MD2011	MD2011	MD2011C*		VR2011*		27
RZ 250 R (29L)	FA081*			FA081R	MD2011	MD2011	MD2011C*		VR2011*		28
RZ 250 RR (5IL)	FA104*			FA104HH*	MD2011	MD2011	MD2011C*		VR2011*		29
RZ 250 (4L3)	FA070					MD2019RS					30
RI-Z (250cc/3XC)	FA220*				MD2022LS	MD2022RS					31
Serrow 250 (3C51/52)	FA275TT			FA275HH	MD6067D						32
SR 250 SE (3Y8)	Y522										33
SR 250 (4GR1/2/3/4)	Y522										34
SR 250 (Classic/21L)	FA081			FA081R		MD2019RS					35
SRV 250 Soulfultwin/Renaissa (4DN1-6)	FA179			FA179HH	MD2067						36
SRX 250 (51Y/52E/1JA)	FA104			FA104HH		MD2056RS					37
TDR 250 (3CK1/3CK2 Europe - Eng/Frame 3CK-)	FA123			FA123HH		MD2003X	MD2003XC	MD2003CC	VR2003BLK†		38
TT 250	FA105TT			FA105R	MD6039D						39
TT 250 R (4GY Japan)	FA135TT		MXS135	FA135R	MD6066D						40
TT 250 R (4RR1/2 Japan)	FA135TT		MXS135	FA135R	MD6066D						41
TT 250 R (4GY3/4GY5/4WA1 - Japan - Raid)	FA135TT		MXS135	FA135R	MD6066D						42
TT 250 R (4MR2 UK)	FA135TT		MXS135	FA135R	MD6066D						43
TT 250 RL (4PX5)	FA135TT		MXS135	FA135R	MD6066D						44
TT 250 RM (4PX6)	FA135TT		MXS135	FA135R	MD6066D						45
TY 250 D/E	Y504			Y504G							46
TY 250 H	Y507			Y507G							47
TY 250 S/R	Y517			Y517G							48
TY 250 R	FA115TT		MXS115	FA115R							49
TY 250 R	FA115TT		MXS115	FA115R							50
TY 250 Z	FA115TT		MXS115	FA115R							51
TZR 250 (1KT/2AW Japan - Eng/Frame # 1KT)	FA123			FA123HH		MD2003X	MD2003XC	MD2003CC	VR2003BLK†		52
TZR 250 (2MA/2XW1/2XW2 Europe - Eng/Frame # 2MA-)	FA123			FA123HH		MD2003X	MD2003XC	MD2003CC	VR2003BLK†		53
TZR 250 (3MA1 Reverse Cylinder - Eng/Frame # 3MA-)	FA252*			FA252HH*	MD2001X	MD2001X	MD2001XC*	MD2001CC*	VR2001BLK*†		54
TZR 250 (3MA3/3MA5 Reverse Cylinder - Eng/Frame # 3MA -046/058-)	FA252*			FA252HH*							55
TZR 250 SP (3MA4 - Eng/Frame # 3MA 055)	FA252*			FA252HH*							56
TZR 250 R (3XV1/3XV4/3XV6 V-Twin - Eng/Frame # 3XV 000101-08600)	FA252*			FA252HH*							57
											58
											59
											60

FRONT / AVANT / VORN / FRENTE / ANTERIORE

R Suffix = High Durability Sintered Pad. HH Suffix = High Performance Sintered Pad. TT Suffix = Hard Wearing Off Road Pad. V Suffix = Semi Sintered Pad. G Suffix = Grooved Shoe. D Suffix = Drilled Disc. X Suffix = Universal Left or Right Disc. XG Suffix = Contoured Disc. LS Suffix = Left/Steel Disc. RS = Right/Steel Disc.

*-2 Sets Required. † For Vee disc colours add RED, BLU, GRN, GLD, ORG suffix to part number. For Custom Finish Options for Vee-Rotors™ including Splatter discs add suffix CHR, CHGR, CHBL, CHBR - available in various colours see page iv. Ⓢ - Also available as a Vintage Motorcycle Disc.

JAPANESE Built Motorcycles

Line #	BRAKE DISC CHOICES - FRONT						DISC PAD CHOICES - REAR				BRAKE DISC CHOICES - REAR			
	Oversize 250 /280mm Disc Kit	OSX Oversize 250/280mm Disc Kit	Relocating Bracket for 250/ 280mm Disc	Oversize 320mm Disc Kit	SMX Oversize 320mm Disc Kit	Relocating Bracket for 320mm Disc	FA, SFA, TT Pad or Brake Shoe	SFAC Carbon Scooter Pads	Speciality Pads - SXR / Vee / MXS	Sintered/ HH Pads/ Grooved Shoes	Standard Replacement Disc	Contour Disc Rear fitment	Vee Discs CONTOUR	CX Extreme MX Race Disc
1							Y503			Y503G				
2							Y503			Y503G				
3							Y503			Y503G				
4							FA152/2TT		MXS152	FA152/2R	MD6244D			
5							FA152/2TT		MXS152	FA152/2R	MD6244D			
6							Y527							
7							FA152/2TT		MXS152	FA152/2R	MD6121D			
8							Y523*			Y523G*				
9							SFA408	SFAC408		SFA408HH	MD9108D			
10														
11							Y510			Y510G				
12							FA104		FA104V	FA104HH	MD2021	MD2021C	VR2021	
13							FA104				MD2021			
14							FA104		FA104V	FA104HH	MD2021			
15							Y528			Y528G				
16							Y510			Y510G				
17							Y510			Y510G				
18														
19														
20														
21							Y514							
22							Y514							
23							FA011							
24							FA041				MD2025RS			
25							Y514							
26							Y514							
27							FA104		FA104V	FA104HH	MD2011	MD2011C	VR2011	
28							FA104		FA104V	FA104HH	MD2011	MD2011C	VR2011	
29							FA104		FA104V	FA104HH	MD2011	MD2011C	VR2011	
30							Y514							
31							FA104		FA104V		MD2021			
32							FA152TT			FA152R	MD6244D			
33							Y506							
34							Y527							
35							Y527							
36							Y527							
37							Y510							
38							FA104		FA104V	FA104HH	MD2021	MD2021C	VR2021	
39							Y506			Y506G				
40							FA152/2TT		MXS152	FA152/2R	MD6121D			
41							FA152/2TT		MXS152	FA152/2R	MD6121D			
42							FA152/2TT		MXS152	FA152/2R	MD6121D			
43							FA152/2TT		MXS152	FA152/2R	MD6121D			
44							FA152/2TT		MXS152	FA152/2R	MD6121D			
45							FA152/2TT		MXS152	FA152/2R	MD6121D			
46							Y506			Y506G				
47							Y510			Y510G				
48							Y504			Y504G				
49							Y504			Y504G				
50							FA115TT		MXS115	FA115R				
51							FA115TT		MXS115	FA115R				
52							FA104		FA104V	FA104HH	MD2021	MD2021C	VR2021	
53							FA104		FA104V	FA104HH	MD2021	MD2021C	VR2021	
54							FA104		FA104V	FA104HH	MD2021	MD2021C	VR2021	
55														
56							FA104		FA104V	FA104HH	MD2021	MD2021C		
57							FA104		FA104V	FA104HH	MD2021	MD2021C		
58														
59							FA104		FA104V	FA104HH	MD2021	MD2021C		
60														

REAR / ARRIÈRE / HINTEN / POSTERIOR / POSTERIORE

R Suffix = High Durability Sintered Pad. **HH** Suffix = High Performance Sintered Pad. **TT** Suffix = Hard Wearing Off Road Pad. **V** Suffix = Semi Sintered Pad. **G** Suffix = Grooved Shoe.
D Suffix = Drilled Disc. **X** Suffix = Universal Left or Right Disc. **XC** Suffix = Contoured Disc. **LS** Suffix = Left/Steel Disc. **RS** = Right/Steel Disc.

BRAKE APPLICATIONS

*-2 Sets Required. † For Vee disc colours add RED, BLU, GRN, GLD, ORG suffix to part number. For Custom Finish Options for Vee-Rotors™ including Splatter discs add suffix CHR, CHGR, CHBL, CHBR - available in various colours see page iv. ⚙ - Also available as a Vintage Motorcycle Disc.

JAPANESE Built Motorcycles



YAMAHA Contd.



DISC PAD CHOICES - FRONT

BRAKE DISC CHOICES - FRONT

Line #

		FA, SFA, TT Pad or Brake Shoe	SFAC Carbon Scooter Pads	Speciality Pads - SXR / Vee / MXS	Sintered/HH Pads/ Grooved Shoes	Left / Gauche / Links Standard Replacement Disc	Right / Droite / Rechts Standard Replacement Disc	Contour Disc Universal left and right fitment	Custom Disc Universal left and right fitment	Vee-Disks Black † See note below	CX Extreme MX Race Disc/ UTVX Disc
TZR 250 RS (3XV8/3XV9/3XVA - V-Twin - Eng/Frame # 3XV 08080101-08200/088-)	92-94	FA252*			FA252HH*						
TZR 250 SPR (3XVC V-Twin 3XV 107101-)	95	FA252*			FA252HH*						
VP 250 X-City (5B2)	07-16	SFA196	SFAC196		SFA196HH	MD9130D					
WR 250 ZB	91	FA135TT		MXS135	FA135R	MD6012D					
WR 250 ZD/ZE/ZF/ZG/ZH/ZJ (2T)	92-97	FA135TT		MXS135	FA135R	MD6028D		MD6028C			MD6028CX
WR 250 ZK (5EN1) (2T)	98	FA185TT		MXS185	FA185R	MD6028D		MD6028C			MD6028CX
WR 250 FN (4T)	01	FA185TT		MXS185	FA185R	MD6356D		MD6356C			MD6356CX
WR 250 FP (4T)	02	FA185TT		MXS185	FA185R	MD6356D		MD6356C			MD6356CX
♦ Plain undrilled disc for enduro use MD6190CE											
WR 250 FR/FS/FT/FV (4T)	03-06	FA185TT		MXS185	FA185R	MD6356D		MD6356C			MD6356CX
♦ Plain undrilled disc for enduro use MD6190CE											
WR 250 FW/FX/FY/FZ/FA/FB/FD (4T)	07-13	FA185TT		MXS185	FA185R			MD6356C			MD6356CX
♦ Plain undrilled disc for enduro use MD6190CE											
WR 250 FF/FG (4T/Reverse Cylinder)	15-16	FA185TT		MXS185	FA185R			MD6356C			MD6356CX
♦ Plain undrilled disc for enduro use MD6190CE											
WR 250 F (4T/Reverse Cylinder)	17-21	FA450TT		MXS450	FA450R			MD6392C			MD6392CX
♦ Plain undrilled disc for enduro use MD6190CE											
WR 250 RX/RX (32D-)	08-18	FA185TT		MXS185	FA185R			MD6320C			
WR 250 RX/RX (32D-) For upgrade disc from 250mm to 280mm when using WR 250 X wheel and caliper bracket. Disc only supplied by EBC.	08-15							MD6320CSPEC			
WR 250 XX/XY (Supermoto) (32D-)	08-15	FA142		FA142V	FA142HH			MD6323C			
X-City - See VP 250 X-City (5B2)	07-16										
XG 250 Tricker (5XT1)	04-06	FA275TT			FA275HH	MD6067D					
X-Max (Brembo F/Caliper/Non ABS/1C0)											
See YP 250 R X-Max (Brembo F/Caliper/Non ABS/1C0)	05-09										
X-Max (37P1/Nissin F/Caliper/Non ABS)											
See YP 250 R X-Max (37P1/Nissin F/Caliper/Non ABS)	10-13										
X-Max (ABS) See YP 250 R X-Max (ABS) 11-16											
X-Max Sport - See YP 250 X-Max Sport 11-12											
X-Max 250 Momo Design	15	SFA196	SFAC196		SFA196HH	MD9102D					
X-Max 250 (Non ABS/Heng Tong R/Caliper/2DL)											
See YP250 R X-Max	14-16	SFA196	SFAC196		SFA196HH	MD9102D					
X-Max 250 ABS	18-19	SFA705	SFAC705		SFA705HH	MD9169D					
XP 250 RA X-Max - Iron-Max (ABS)	16	SFA196	SFAC196		SFA196HH	MD9102D					
XS 250 C	78	FA034		FA034V				MD2019RS			
XS 250 D/E	79-81	FA034						MD2019RS			
XS 250 SE/SF	79-81	FA041						MD2019RS			
XS 250 C	81	Y513									
XT 250	80	Y506			Y506G						
XT 250 Serow (3C51/2)	05-08	FA275TT			FA275HH	MD6068D					
XTZ 250 (4B41/2/3) Lander (Brasil)	07-09	FA135TT			FA135R						
XV 250 Virago	89-94	FA081			FA081R			MD2019RS			
XV 250 S Virago	95-00	FA199			FA199HH	MD2067					
XVS 250 Dragstar	01-04	FA199			FA199HH			MD2067			
YBR 250 (5D11/3/4)	07-11	FA197			FA197HH			MD2106RS			
YDS7 250cc	72	Y513									
YFB 250 D/E/F Timberwolf	92-94	Y503*			Y503G*						
YFB 250 G/H/UH/J/UJ/UK/K Timberwolf	95-98	Y528*			Y528G*						
YFB 250 FWF/FWG/FWH/FWJ/FWK/FWL/FWK Timberwolf	94-00	Y528*			Y528G*						
YFM 250 W/A/B	90-92	Y528*			Y528G*						
YFM 250 XLC/XL/X Bear Tracker	99-00	Y528*			Y528G*						
YFM 250 XN/XP/XR/XS Bear Tracker	01-04	FA054TT*			FA054R*	MD6054D	MD6054D				
YFM 250 BT/BV Bruin	05-06	FA054TT*			FA054R*	MD6054D	MD6054D				
YFM 250 BW/BX/BY Big Bear	07-10	FA054TT*		MXS054*	FA054R*	MD6054D	MD6054D				
YFM 250 RX/RX Raptor	Left 08-09	FA443TT			FA443R	MD6054D					
	Right	FA444TT			FA444R			MD6054D			
YFM 250 R (33B)	Left 09-11	FA443TT			FA443R	MD6054D					
	Right	FA444TT			FA444R			MD6054D			

FRONT / AVANT / VORN / FRENTE / ANTERIORE

R Suffix = High Durability Sintered Pad. HH Suffix = High Performance Sintered Pad. TT Suffix = Hard Wearing Off Road Pad. V Suffix = Semi Sintered Pad. G Suffix = Grooved Shoe. D Suffix = Drilled Disc. X Suffix = Universal Left or Right Disc. XG Suffix = Contoured Disc. LS Suffix = Left/Steel Disc. RS = Right/Steel Disc.

*-2 Sets Required. † For Vee disc colours add RED, BLU, GRN, GLD, ORG suffix to part number. For Custom Finish Options for Vee-Rotors™ including Splatter discs add suffix CHR, CHGR, CHBL, CHBR - available in various colours see page iv. ☉ - Also available as a Vintage Motorcycle Disc.

JAPANESE Built Motorcycles

Line #	BRAKE DISC CHOICES - FRONT						DISC PAD CHOICES - REAR				BRAKE DISC CHOICES - REAR			
	Oversize 250 /280mm Disc Kit	OSX Oversize 250/280mm Disc Kit	Relocating Bracket for 250/ 280mm Disc	Oversize 320mm Disc Kit	SMX Oversize 320mm Disc Kit	Relocating Bracket for 320mm Disc	FA, SFA, TT Pad or Brake Shoe	SFAC Carbon Scooter Pads	Speciality Pads - SXR / Vee / MXS	Sintered/ HH Pads/ Grooved Shoes	Standard Replacement Disc	Contour Disc Rear fitment	Vee Discs CONTOUR	CX Extreme MX Race Disc
1														
2							FA104		FA104V	FA104HH	MD2021	MD2021C		
3							FA104		FA104V	FA104HH	MD2021	MD2021C		
4							SFA275	SFAC275		SFA275HH	MD9104D			
5							FA152TT		MXS152	FA152R	MD6011D			
6	OS6028EC	OSX6028E	BRK035				FA152TT		MXS152	FA152R	MD6011D			
7	OS6028C	OSX6028	BRK008		SMX6028	BRK009	FA131TT		MXS131	FA131R	MD6135D	MD6135C	MD6135CX	
8	OS6028C	OSX6028	BRK008		SMX6028	BRK009	FA131TT		MXS131	FA131R	MD6135D	MD6135C	MD6135CX	
9	OS6028C	OSX6028	BRK008		SMX6028	BRK009	FA131TT		MXS131	FA131R	MD6190D	MD6190C♦	MD6190CX	
10														
11	OS6028C	OSX6028	BRK008		SMX6028	BRK009	FA367TT		MXS367	FA367R	MD6190D	MD6190C♦	MD6190CX	
12														
13	OS6028C	OSX6028	BRK008		SMX6028	BRK009	FA367TT		MXS367	FA367R		MD6190C♦	MD6190CX	
14														
15		OSX6028	BRK008		SMX6028	BRK009	FA367TT		MXS367	FA367R		MD6190C♦	MD6190CX	
16														
17		OSX6392C	BRK046				FA367TT		MXS367	FA367R		MD6190C♦	MD6190CX	
18														
19							FA367TT		MXS367	FA367R		MD6319C		
20														
21														
22														
23							FA367TT		MXS367	FA367R		MD6319C		
24														
25							FA152TT		MXS152	FA152R	MD6244D			
26														
27														
28														
29														
30														
31														
32							SFA213			SFA213HH				
33														
34							SFA678	SFAC678		SFA678HH	MD9153D			
35							SFA706	SFAC706		SFA706HH	MD9168D			
36							SFA275	SFAC275		SFA275HH	MD9108D			
37							FA034		FA034V		MD2019RS			
38							Y516							
39							Y516							
40							Y516							
41							Y506		Y506G					
42							FA152TT		FA152R	MD6244D				
43							FA152TT		FA152R	MD6244D				
44							Y527							
45							Y527							
46							Y527							
47							Y535							
48							Y514							
49							Y528		Y528G					
50							Y528		Y528G					
51							Y528		Y528G					
52							FA021		FA021R					
53							Y528		Y528G					
54							Y528		Y528G					
55							Y532		Y532G					
56							Y532		Y532G					
57							FA084TT		FA084R	MD6236D				
58														
59							FA084TT		FA084R	MD6236D				
60														

REAR / ARRIÈRE / HINTEN / POSTERIOR / POSTERIORE

R Suffix = High Durability Sintered Pad. HH Suffix = High Performance Sintered Pad. TT Suffix = Hard Wearing Off Road Pad. V Suffix = Semi Sintered Pad. G Suffix = Grooved Shoe.
D Suffix = Drilled Disc. X Suffix = Universal Left or Right Disc. XC Suffix = Contoured Disc. LS Suffix = Left/Steel Disc. RS = Right/Steel Disc.

*-2 Sets Required. † For Vee disc colours add RED, BLU, GRN, GLD, ORG suffix to part number. For Custom Finish Options for Vee-Rotors™ including Splatter discs add suffix CHR, CHGR, CHBL, CHBR - available in various colours see page iv. Ⓢ - Also available as a Vintage Motorcycle Disc.

BRAKE APPLICATIONS

JAPANESE Built Motorcycles



YAMAHA Contd.



DISC PAD CHOICES - FRONT

BRAKE DISC CHOICES - FRONT

R Suffix = High Durability Sintered Pad. HH Suffix = High Performance Sintered Pad. TT Suffix = Hard Wearing Off Road Pad. V Suffix = Semi Sintered Pad. G Suffix = Grooved Shoe.

D Suffix = Drilled Disc. X Suffix = Universal Left or Right Disc. XC Suffix = Contoured Disc. LS Suffix = Left/Steel Disc. RS Suffix = Right/Steel Disc.

FRONT / AVANT / VORN / FRENTE / ANTERIORE

Model	Left	Right	FA, SFA, TT Pad or Brake Shoe	SFAC Carbon Scooter Pads	Speciality Pads - SXR / Vee / MXS	Sintered/HH Pads/ Grooved Shoes	Left / Gauche / Links Standard Replacement Disc	Right / Droite / Rechts Standard Replacement Disc	Contour Disc Universal left and right fitment	Custom Disc Universal left and right fitment	Vee-Disks Black † See note below	CX Extreme MX Race Disc/ UTVX Disc	Line #
YFM 250 R (1BT)	Left	12-13	FA443TT			FA443R	MD6054D						1
	Right		FA444TT			FA444R		MD6054D					2
YFU1W/YFU1-T (230cc)		89-90	Y528*			Y528G*							3
YP 250 Majesty		96-98	SFA199	SFAC199		SFA199HH		MD903D			VR903		4
YP 250 DX/A Majesty		98-99	SFA199	SFAC199		SFA199HH		MD903D			VR903		5
YP 250 Majesty		00-03	SFA199	SFAC199		SFA199HH		MD903D			VR903		6
YP 250 R X-Max (1C0) Non ABS (Brembo F/Caliper)		05-09	SFA430	SFAC430		SFA430HH		MD9102D			VR9102		7
YP 250 R X-Max (37P1) Non ABS (Nissin Front Caliper)		10-13	SFA196	SFAC196		SFA196HH		MD9102D			VR9102		8
YP 250 R X-Max (ABS)		11-16	SFA196	SFAC196		SFA196HH		MD9102D			VR9102		9
YP 250 R X-Max Sport		11-12	SFA196	SFAC196		SFA196HH		MD9102D			VR9102		10
YP 250 R X-Max ABS (Nissin Front /Brembo Rear Calipers)		14-15	SFA196	SFAC196		SFA196HH		MD9102D			VR9102		11
YP 250 R X-Max (2PL1) Non ABS (Nissin Front /Brembo Rear Calipers)		14-15	SFA196	SFAC196		SFA196HH		MD9102D			VR9102		12
YP 250 R X-Max (2DL) Non ABS (Heng Tong Rear Calipers)		14-16	SFA196	SFAC196		SFA196HH	MD9102D						13
YS 250 (1S41/2/3) Fazer (Brasil)		06-08	FA197			FA197HH							14
YZ 250 N/S TR1-Z		85-86	FA101TT		MXS101	FA101R	MD6047D						15
YZ 250 D/E/F (2T)		77-79	Y507										16
YZ 250 G (2T)		80	Y507			Y507G							17
YZ 250 J/K/L (2T)		81-84	Y508			Y508G							18
YZ 250 N (2T)		85	FA105TT			FA105R	MD6324D						19
YZ 250 S/T (2T)		86-87	FA105TT			FA105R	MD6067D						20
YZ 250 U (2T)		88	FA105TT			FA105R	MD6039D						21
YZ 250 W/WRW (2T)		89	FA135TT		MXS135	FA135R	MD6016D						22
YZ 250 A/WRA/B (2T)		90-91	FA135TT		MXS135	FA135R	MD6012D						23
YZ 250 D/E/F/G/H/J (2T)		92-97	FA135TT		MXS135	FA135R	MD6028D		MD6028C			MD6028CX	24
YZ 250 K/L/M (2T)		98-00	FA185TT		MXS185	FA185R	MD6028D		MD6028C			MD6028CX	25
YZ 250 N (2T)		01	FA185TT		MXS185	FA185R	MD6356D		MD6356C			MD6356CX	26
YZ 250 P (2T)		02	FA185TT		MXS185	FA185R	MD6356D		MD6356C			MD6356CX	27
♦ Plain undrilled disc for enduro use MD6190CE													28
YZ 250 R/S/T/V/W (2T)		03-07	FA185TT		MXS185	FA185R	MD6356D		MD6356C			MD6356CX	29
♦ Plain undrilled disc for enduro use MD6190CE													30
YZ 250 X/Y/Z/A/B/D/E/F/G (2T)		08-16	FA450TT		MXS450	FA450R			MD6356C			MD6356CX	31
♦ Plain undrilled disc for enduro use MD6190CE													32
YZ 250 (2T) 270 F/Disc, 240 R/Disc		21-22	FA450TT		MXS450	FA450R			MD6392C			MD6392CX	33
♦ Plain undrilled disc for enduro use MD6190CE													34
YZ 250 Monster Energy 2T 270 F/Disc, 240 R/Disc		22	FA450TT		MXS450	FA450R			MD6392C			MD6392CX	35
♦ Plain undrilled disc for enduro use MD6190CE													36
YZ 250 X 2T 270 F/Disc, 245 R/Disc		17-22	FA450TT		MXS450	FA450R			MD6392C			MD6392CX	37
♦ Plain undrilled disc for enduro use MD6190CE													38
YZ 250 FN (4T)		01	FA185TT		MXS185	FA185R	MD6356D		MD6356C			MD6356CX	39
YZ 250 FP (4T)		02	FA185TT		MXS185	FA185R	MD6356D		MD6356C			MD6356CX	40
♦ Plain undrilled disc for enduro use MD6190CE													41
YZ 250 FR/FS/FT/FV (4T)		03-06	FA185TT		MXS185	FA185R	MD6356D		MD6356C			MD6356CX	42
♦ Plain undrilled disc for enduro use MD6190CE													43
YZ 250 FW/FX/FY/FZ/FA/FB/FD/FE/FF (4T)		07-15	FA450TT		MXS450	FA450R			MD6356C			MD6356CX	44
♦ Plain undrilled disc for enduro use MD6190CE													45
YZ 250 F		16-19	FA450TT		MXS450	FA450R			MD6392C			MD6392CX	46
♦ Plain undrilled disc for enduro use MD6190CE													47
YZ 250 F		20-22	FA755TT		MXS755	FA755R			MD6392C			MD6392CX	48
♦ Plain undrilled disc for enduro use MD6190CE													49
YZ 250 FGY (60th Anniversary Edition/270mm Disc)		16	FA450TT		MXS450	FA450R			MD6392C			MD6392CX	50
♦ Plain undrilled disc for enduro use MD6190CE													51
Tricity 300 ABS		19-21	SFA694	SFAC694									52
VP 300 Versity		03-05	SFA181	SFAC181		SFA181HH		MD995D			VR995		53
XC 300 Versity		06	SFA196	SFAC196		SFA196HH		MD995D			VR995		54
X-Max 300 (CZD300A) ABS		17-21	SFA705	SFAC705		SFA705HH			MD9169D				55
X-Max 300 ABS Tech Max		19-20	SFA705	SFAC705		SFA705HH			MD9169D				56
YFM 300 B/D Grizzly		12-13	FA083TT*			FA083R*	MD6283D	MD6283D					57

*-2 Sets Required. † For Vee disc colours add RED, BLU, GRN, GLD, ORG suffix to part number. For Custom Finish Options for Vee-Rotors™ including Splatter discs add suffix CHR, CHGR, CHBL, CHBR - available in various colours see page iv. ☼ - Also available as a Vintage Motorcycle Disc.

JAPANESE Built Motorcycles

Line #	BRAKE DISC CHOICES - FRONT						DISC PAD CHOICES - REAR				BRAKE DISC CHOICES - REAR			
	Oversize 250 /280mm Disc Kit	OSX Oversize 250/280mm Disc Kit	Relocating Bracket for 250/ 280mm Disc	Oversize 320mm Disc Kit	SMX Oversize 320mm Disc Kit	Relocating Bracket for 320mm Disc	FA, SFA, TT Pad or Brake Shoe	SFAC Carbon Scooter Pads	Speciality Pads - SXR / Vee / MXS	Sintered/ HH Pads/ Grooved Shoes	Standard Replacement Disc	Contour Disc Rear fitment	Vee Discs CONTOUR	CX Extreme MX Race Disc
1							FA084TT			FA084R	MD6236D			
2														
3							Y523*			Y523G*				
4							Y516							
5							SFA275	SFAC275		SFA275HH	MD927D		VR927	
6							SFA275	SFAC275		SFA275HH	MD953D	MD953C	VR953	
7							SFA275	SFAC275		SFA275HH	MD9104D		VR9104	
8							SFA275	SFAC275		SFA275HH	MD9104D		VR9104	
9							SFA275	SFAC275		SFA275HH	MD9108D			
10							SFA275	SFAC275		SFA275HH	MD9104D		VR9104	
11														
12							SFA213			SFA213HH				
13														
14							SFA213			SFA213HH				
15														
16							SFA678	SFAC678		SFA678HH	MD9153D			
17							Y531							
18							FA101TT		MXS101	FA101R				
19							Y528			Y528G				
20							Y506			Y506G				
21							Y506			Y506G				
22							Y506			Y506G				
23							Y506			Y506G				
24							FA101TT		MXS101	FA101R	MD6011D			
25							FA084/3TT		MXS084/3	FA084/3R	MD6011D			
26							FA152TT		MXS152	FA152R	MD6011D			
27	OS6028EC	OSX6028E	BRK035				FA152/2TT		MXS152	FA152/2R	MD6011D			
28	OS6028C	OSX6028	BRK008		SMX6028	BRK009	FA131TT		MXS131	FA131R	MD6135D	MD6135C		MD6135CX
29	OS6028C	OSX6028	BRK008		SMX6028	BRK009	FA131TT		MXS131	FA131R	MD6135D	MD6135C		MD6135CX
30	OS6028C	OSX6028	BRK008		SMX6028	BRK009	FA131TT		MXS131	FA131R	MD6190D	MD6190C		MD6190CX
31														
32	OS6028C	OSX6028	BRK008		SMX6028	BRK009	FA367TT		MXS367	FA367R	MD6190D	MD6190C		MD6190CX
33														
34	OS6728C	OSX6728	BRK002		SMX6728	BRK034	FA367TT		MXS367	FA367R		MD6190C		MD6190CX
35														
36	OSX6392C	BRK046					FA367TT		MXS367	FA367R		MD6190C		MD6190CX
37														
38	OSX6392C	BRK046					FA367TT		MXS367	FA367R		MD6190C		MD6190CX
39														
40	OSX6392C	BRK046					FA367TT		MXS367	FA367R		MD6190C		MD6190CX
41														
42	OS6028C	OSX6028	BRK008		SMX6028	BRK009	FA131TT		MXS131	FA131R	MD6135D	MD6135C		MD6135CX
43	OS6028C	OSX6028	BRK008		SMX6028	BRK009	FA131TT		MXS131	FA131R	MD6190D	MD6190C		MD6190CX
44														
45	OS6028C	OSX6028	BRK008		SMX6028	BRK009	FA367TT		MXS367	FA367R	MD6190D	MD6190C		MD6190CX
46														
47	OS6728C	OSX6728	BRK002		SMX6728	BRK034	FA367TT		MXS367	FA367R		MD6190C		MD6190CX
48														
49	OSX6392C		BRK046				FA367TT		MXS367	FA367R		MD6190C		MD6190CX
50														
51	OSX6392C		BRK046				FA367TT		MXS367	FA367R		MD6190C		MD6190CX
52														
53	OSX6392C		BRK046				FA367TT		MXS367	FA367R		MD6190C		MD6190CX
54														
55														
56							SFA181	SFAC181		SFA181HH	MD9104D		VR9104	
57							SFA181	SFAC181		SFA181HH	MD9104D		VR9104	
58							SFA706	SFAC706		SFA706HH	MD9168D			
59							SFA706	SFAC706		SFA706HH	MD9168D			
60							FA067TT			FA067R	MD6369D			

REAR / ARRIERE / HINTEN / POSTERIOR / POSTERIORE

*-2 Sets Required. † For Vee disc colours add RED, BLU, GRN, GLD, ORG suffix to part number. For Custom Finish Options for Vee-Rotors™ including Splatter discs add suffix CHR, CHGR, CHBL, CHBR - available in various colours see page iv. Ⓢ - Also available as a Vintage Motorcycle Disc.

R Suffix = High Durability Sintered Pad. **HH** Suffix = High Performance Sintered Pad. **TT** Suffix = Hard Wearing Off Road Pad. **V** Suffix = Semi Sintered Pad. **G** Suffix = Grooved Shoe.
D Suffix = Drilled Disc. **X** Suffix = Universal Left or Right Disc. **XC** Suffix = Contoured Disc. **LS** Suffix = Left/Steel Disc. **RS** = Right/Steel Disc.

JAPANESE Built Motorcycles



YAMAHA Contd.



DISC PAD CHOICES - FRONT

BRAKE DISC CHOICES - FRONT

	FA, SFA, TT Pad or Brake Shoe	SFAC Carbon Scooter Pads	Speciality Pads - SXR / Vee / MXS	Sintered/HH Pads/ Grooved Shoes	Left / Gauche / Links Standard Replacement Disc	Right / Droite / Rechts Standard Replacement Disc	Contour Disc Universal left and right fitment	Custom Disc Universal left and right fitment	Vee-Disks Black † See note below	CX Extreme MX Race Disc/ UTVX Disc
MT-03 ABS	FA663			FA663HH		MD2119X	MD2119XC		VR2119BLK†	
YZF-R3 ABS	FA663			FA663HH		MD2119X	MD2119XC		VR2119BLK†	
R5/5A/5B 350cc	Y513									
RD 350 A/B	FA011									
RD 350 LC	FA064*				MD2019LS	MD2019RS				
RD 350 LC	FA070*				MD2019LS	MD2019RS				
RD 350 YPVS	FA081*			FA081R	MD2011	MD2011	MD2011C*		VR2011*	
RD 350 F/F2	FA104*			FA104HH*	MD2011	MD2011	MD2011C*		VR2011*	
RD 350 N	FA104*			FA104HH*	MD2011	MD2011	MD2011C*		VR2011*	
RD 350 R	FA104*			FA104HH*	MD2011	MD2011	MD2011C*		VR2011*	
TT 350 A (3GJ)	FA105TT			FA105R	MD6039D					
TT 350 (1TJ)	FA105TT			FA105R	MD6039D					
XT 350	FA101TT			FA101R	MD6068D					
XT 350	FA101TT			FA101R	MD6068D					
YFM 350 FWT/FWU Big Bear	Y520*			Y520G*						
YFM 350 FWW/FWA/FWB/FWD/FWE/FWF/FWG	Y524*			Y524G*						
YFM 350 FWH/FWJ/FWK Big Bear	Y524*			Y524G*						
YFM 350 XD/XE/XF/XG/XH/XJ/XK/XL/XM/XN /XP/XR/XS (Warrior)	FA054TT*		MXS054*	FA054R*	MD6054D	MD6054D				
YFM 350 ERD	Y528*			Y528G*						
YFM 350 ERE/ERF/ERG	Y528*			Y528G*						
YFM 350 FXG/FXH/FXJ/FXK/FXL/FXM/FXN /FXP/FXR/FXS Wolverine	FA054TT*		MXS054*	FA054R*	MD6123D	MD6123D				
YFM 350 UH/UJ/UK	Y524*			Y524G*						
YFM 350 L Big Bear	FA054TT*		MXS054*	FA054R*	MD6123D	MD6123D				
YFM 350 FAS/FAT/FAV Bruin 4 x 4	FA054TT*		MXS054*	FA054R*	MD6215D	MD6215D				
YFM 350 ANS/ANT/ANV Bruin 2 x 4	FA054TT*		MXS054*	FA054R*	MD6215D	MD6215D				
YFM 350 S/T/V/R/W/RX/RX/RY Raptor	FA084TT*		MXS084*	FA084R*	MD6054D	MD6054D				
YFM 350 XV/XW/XX/XY 2WD Wolverine	FA054TT*		MXS054*	FA054R*	MD6215D	MD6215D				
YFM 350 GW/GX/GY/GZ Grizzly 2WD	FA054TT*		MXS054*	FA054R*	MD6215D	MD6215D				
YFM 350 FWA Grizzly 4WD	FA054TT*		MXS054*	FA054R*	MD6215D	MD6215D				
YFM 350 FGIW/FGIX/FGIY/FGIZ Grizzly 4WD IRS	FA054TT*		MXS054*	FA054R*	MD6215D	MD6215D				
YFZ 350 T/U/W Banshee	FA101TT*			FA101R*	MD6051D	MD6051D				
YFZ 350 A/B/D/E/F/G/H/J/K/L/M/N/P/R/S/T Banshee	FA054TT*		MXS054*	FA054R*	MD6054D	MD6054D				
XS 360 B	FA011									
XS 360 C	FA034		FA034V			MD2019RS				
DT 400 All models	Y528			Y528G						
FZ 400 N (1KF/4GK/33M)	FA088*			FA088HH*	MD2011	MD2011				
FZ 400 (4YR1)	FA244*			FA244HH*	MD2001X	MD2001X	MD2001XC*	MD2001CC*	VR2001BLK*†	
FZR 400 Genesis (1WG) F/No 1WG 000101-0305100	FA088*			FA088HH*	MD2020LS	MD2020RS				
FZR 400 RSP (2TK-EXUP) F/No 1WG 0305101-043100	FA123*			FA123HH*	MD2022LS	MD2022RS				
FZR 400 (3EN1) F/No 1WG 043101-080100	FA123*			FA123HH*	MD2022LS	MD2022RS				
FZR 400 R (3EN2) F/No 1WG 080101-	FA123*			FA123HH*	MD2001X	MD2001X	MD2001XC*	MD2001CC*	VR2001BLK*†	
FZR 400 RR (3TJ1)	FA252*			FA252HH*	MD2001X	MD2001X	MD2001XC*	MD2001CC*	VR2001BLK*†	
FZR 400 RRSP (3TJ2/6/7) (1TJ)	FA252*			FA252HH*	MD2001X	MD2001X	MD2001XC*	MD2001CC*	VR2001BLK*†	
FZR 400 RR (4DX)	FA252*			FA252HH*	MD2001X	MD2001X	MD2001XC*	MD2001CC*	VR2001BLK*†	
Majesty - See YP 400 Majesty										
Majesty - See YP 400 Majesty										
RD 400 C/D	FA011									
RD 400 E/F	FA041					MD2025RS				
SR 400 (3HT1)	Y526									
SR 400 (2RD)	FA179			FA179HH		MD2076				
SRX 400 (1JL)	FA088			FA088HH		MD2011				
SRX 400 (3VN1/3VN2/3VN5)	FA123			FA123HH		MD2003X	MD2003XC	MD2003CC	VR2003BLK*†	
XJR 400 (4HM1/4HM2/4HM4/4HM7)	FA199*			FA199HH*	MD2001X	MD2001X	MD2001XC*	MD2001CC*	VR2003BLK*†	
XJR 400 (4HM3/4HM5/4HM6/4HM9/4HMA/4HMB) Brembo calipers	FA244*			FA244HH*	MD2001X	MD2001X	MD2001XC*	MD2001CC*	VR2003BLK*†	
XP 400 RA T-Max - Iron Max (ABS)	SFA196*	SFAC196*		SFA196HH*						
XS 400 C	FA034		FA034V			MD2019RS				
XS 400	FA034					MD2019RS				

FRONT / AVANT / VORN / FRENTE / ANTERIORE

Line #

R Suffix = High Durability Sintered Pad. HH Suffix = High Performance Sintered Pad. TT Suffix = Hard Wearing Off Road Pad. V Suffix = Semi Sintered Pad. G Suffix = Grooved Shoe. D Suffix = Drilled Disc. X Suffix = Universal Left or Right Disc. XC Suffix = Contoured Disc. LS Suffix = Left/Steel Disc. RS = Right/Steel Disc.

*-2 Sets Required. † For Vee disc colours add RED, BLU, GRN, GLD, ORG suffix to part number. For Custom Finish Options for Vee-Rotors™ including Splatter discs add suffix CHR, CHGR, CHBL, CHBR - available in various colours see page iv. ☉ - Also available as a Vintage Motorcycle Disc.

JAPANESE Built Motorcycles

Line #	BRAKE DISC CHOICES - FRONT						DISC PAD CHOICES - REAR				BRAKE DISC CHOICES - REAR			
	OverSize 250 /280mm Disc Kit	OSX OverSize 250/280mm Disc Kit	Relocating Bracket for 250/ 280mm Disc	OverSize 320mm Disc Kit	SMX OverSize 320mm Disc Kit	Relocating Bracket for 320mm Disc	FA, SFA, TT Pad or Brake Shoe	SFAC Carbon Scooter Pads	Speciality Pads - SXR / Vee / MXS	Sintered/ HH Pads/ Grooved Shoes	Standard Replacement Disc	Contour Disc Rear fitment	Vee Discs CONTOUR	CX Extreme MX Race Disc
1							FA662			FA662HH	MD2123	MD2123C	VR2123	
2							FA662			FA662HH	MD2123	MD2123C	VR2123	
3							Y514							
4							Y514							
5							Y514							
6							Y514							
7							FA088				MD2011	MD2011C	VR2011	
8							FA104		FA104V	FA104HH	MD2011	MD2011C	VR2011	
9							FA104		FA104V	FA104HH	MD2011	MD2011C	VR2011	
10							FA104		FA104V	FA104HH	MD2011	MD2011C	VR2011	
11							Y527			Y527G				
12							Y527			Y527G				
13							Y506			Y506G				
14							Y527			Y527G				
15							FA021			FA021R				
16							FA021			FA021R				
17							Y516							
18														
19							FA084TT			FA084R	MD6055D			
20							FA021			FA021R				
21							FA021			FA021R				
22														
23							FA084TT			FA084R	MD6053D			
24							Y528			Y528G				
25							Y516			Y516G				
26							Y532			Y532G				
27							Y532			Y532G				
28							FA084TT	MXS084	FA084R	MD6236D				
29							Y532			Y532G				
30							Y532			Y532G				
31							Y532			Y532G				
32														
33							FA084TT			FA084R	MD6053D			
34							FA084TT	MXS084	FA084R	MD6237D				
35							Y514							
36							FA034	FA034V		MD2019RS				
37							Y510		Y510G					
38							FA104	FA104V	FA104HH	MD2002				
39							FA104	FA104V	FA104HH	MD2002	MD2002C	VR2002		
40							FA104	FA104V	FA104HH	MD2021				
41							FA104	FA104V	FA104HH	MD2021				
42							FA104	FA104V	FA104HH	MD2021				
43							FA104	FA104V	FA104HH	MD2021	MD2021C	VR2021		
44							FA104	FA104V	FA104HH	MD2021	MD2021C	VR2021		
45							FA104	FA104V	FA104HH	MD2021	MD2021C	VR2021		
46							FA104	FA104V	FA104HH	MD2021	MD2021C	VR2021		
47														
48														
49							FA011							
50							FA041			MD2025RS				
51							Y510							
52							Y510							
53							FA104	FA104V	FA104HH	MD2002				
54							FA104	FA104V	FA104HH	MD2002	MD2002C	VR2002		
55							FA104	FA104V	FA104HH	MD2002	MD2002C	VR2002		
56														
57							FA104	FA104V	FA104HH	MD2002	MD2002C	VR2002		
58							SFA275	SFAC275	SFA275HH					
59							FA034	FA034V		MD2019RS				
60							Y516							

REAR / ARRIÈRE / HINTEN / POSTERIOR / POSTERIORE

R Suffix = High Durability Sintered Pad. **HH** Suffix = High Performance Sintered Pad. **TT** Suffix = Hard Wearing Off Road Pad. **V** Suffix = Semi Sintered Pad. **G** Suffix = Grooved Shoe.
D Suffix = Drilled Disc. **X** Suffix = Universal Left or Right Disc. **XC** Suffix = Contoured Disc. **LS** Suffix = Left/Steel Disc. **RS** = Right/Steel Disc.

*-2 Sets Required. † For Vee disc colours add RED, BLU, GRN, GLD, ORG suffix to part number. For Custom Finish Options for Vee-Rotors™ including Splatter discs add suffix CHR, CHGR, CHBL, CHBR - available in various colours see page iv. ☉ - Also available as a Vintage Motorcycle Disc.

BRAKE APPLICATIONS

JAPANESE Built Motorcycles



YAMAHA Contd.



DISC PAD CHOICES - FRONT

BRAKE DISC CHOICES - FRONT

Line #

R Suffix = High Durability Sintered Pad. HH Suffix = High Performance Sintered Pad. TT Suffix = Hard Wearing Off Road Pad. V Suffix = Semi Sintered Pad. G Suffix = Grooved Shoe.

D Suffix = Drilled Disc. X Suffix = Universal Left or Right Disc. XC Suffix = Contoured Disc. LS Suffix = Left/Steel Disc. RS = Right/Steel Disc.

FRONT / AVANT / VORN / FRENTE / ANTERIORE

		FA, SFA, TT Pad or Brake Shoe	SFAC Carbon Scooter Pads	Speciality Pads - SXR / Vee / MXS	Sintered/HH Pads/ Grooved Shoes	Left / Gauche / Links Standard Replacement Disc	Right / Droite / Rechts Standard Replacement Disc	Contour Disc Universal left and right fitment	Custom Disc Universal left and right fitment	Vee-Disks Black † See note below	CX Extreme MX Race Disc/ UTVX Disc	
XS 400 SE	80-81	FA041					MD2019RS					1
XS 400	82	FA081			FA081R		MD2011					2
XVS 400	96	FA179			FA179HH		MD2076					3
YFM 400 FWE/FWF/FWG/FWH/FWJ/FWK/FWL Kodiak	93-99	Y524*			Y524G*							4
YFM 400 FAM/FAN	00-01	FA054TT*		MXS054*	FA054R*	MD6123D	MD6123D					5
YFM 400 FWP Big Bear 4 x 4	02	FA084TT*		MXS084*	FA084R*	MD6123D	MD6123D					6
YFM 400 FPR/FPS Big Bear	03-04	FA054TT*		MXS054*	FA054R*	MD6123D	MD6123D					7
YFM 400 FAR/FAS Kodiak Auto	03-04	FA054TT*		MXS054*	FA054R*	MD6215D	MD6215D					8
YFM 400 AR Kodiak (5VH3/4)	03	FA054TT*		MXS054*	FA054R*	MD6215D	MD6215D					9
YFM 400 FAT/FAV (Big Bear)	05-06	FA054TT*		MXS054*	FA054R*	MD6215D	MD6215D					10
YFM 400 FGW/FGX Grizzly	07-08	FA054TT*		MXS054*	FA054R*	MD6054D	MD6054D					11
YP 400 Majesty (5RU1/3 - Non ABS)	04	SFA179	SFAC179		SFA179HH	MD9102D				VR9102		12
YP 400 Majesty (5RU6/8 - Non ABS)	05-13	SFA199*	SFAC199*		SFA199HH*	MD9136D	MD9136D			VR9136*		13
YP 400 Majesty (ABS)	05-13	SFA199*	SFAC199*		SFA199HH*	MD9136D	MD9136D			VR9136*		14
YP 400 X-Max R (Non ABS)	13-16	SFA196*	SFAC196*		SFA196HH*		MD2098C*					15
YP 400 X-Max R ABS	13-17	SFA196*	SFAC196*		SFA196HH*		MD2098C*					16
YP 400 X-Max RA SH12 ABS	18-21	SFA196*	SFAC196*		SFA196HH*	MD2098	MD2098	MD2098C*				17
YP 400 X-Max ABS Tech Max	18-21	SFA196*	SFAC196*		SFA196HH*	MD2098	MD2098	MD2098C*				18
YP 400 X-Max Momo Design ABS	15	SFA196*	SFAC196*		SFA196HH*	MD2098	MD2098	MD2098C*				19
YZ 400 D/E/F (2T)	77-79	Y507			Y507G							20
YZ 400 FK (4T)	98	FA185TT		MXS185	FA185R	MD6028D		MD6028C			MD6028CX	21
YZ 400 FL (4T)	99	FA185TT		MXS185	FA185R	MD6028D		MD6028C			MD6028CX	22
WR 400 FK (4T)	98	FA185TT		MXS185	FA185R	MD6028D		MD6028C			MD6028CX	23
WR 400 FL/FM (4T)	99-00	FA185TT		MXS185	FA185R	MD6028D		MD6028C			MD6028CX	24
WR 400 FN (4T)	01	FA185TT		MXS185	FA185R	MD6356D		MD6356C			MD6356CX	25
IT 425 G	80	Y507			Y507G							26
WR 426 FN (4T)	01	FA185TT		MXS185	FA185R	MD6356D		MD6356C			MD6356CX	27
WR 426 FP (4T)	02	FA185TT		MXS185	FA185R	MD6356D		MD6356C			MD6356CX	28
♦ Plain undrilled disc for enduro use MD6190CE												29
YZ 426 FM (4T)	00	FA185TT		MXS185	FA185R	MD6028D		MD6028C			MD6028CX	30
YZ 426 FN (4T)	01	FA185TT		MXS185	FA185R	MD6356D		MD6356C			MD6356CX	31
YZ 426 FP (4T)	02	FA185TT		MXS185	FA185R	MD6356D		MD6356C			MD6356CX	32
♦ Plain undrilled disc for enduro use MD6190CE												33
WR 450 FR/FS/FT/FV (4T)	03-06	FA185TT		MXS185	FA185R	MD6356D		MD6356C			MD6356CX	34
♦ Plain undrilled disc for enduro use MD6190CE												35
WR 450 FW/FX/FY/FZ/FA/FB/FD/FE/FF (4T)	07-15	FA185TT		MXS185	FA185R			MD6356C			MD6356CX	36
♦ Plain undrilled disc for enduro use MD6190CE												37
WR 450 F (270mm F/Disc/4T)	16-19	FA450TT		MXS450	FA450R			MD6392C			MD6392CX	38
♦ Plain undrilled disc for enduro use MD6190CE												39
WR 450 F (270mm F/Disc/4T)	20-22	FA755TT		MXS755	FA755R			MD6392C			MD6392CX	40
♦ Plain undrilled disc for enduro use MD6190CE												41
YFM 450 FAR/FAS Kodiak (5ND3/4)	03-04	FA054TT*		MXS054*	FA054R*	MD6215D	MD6215D					42
YFM 450 FAT/FAHT/FAV (Kodiak)	05-06	FA054TT*		MXS054*	FA054R*	MD6215D	MD6215D					43
YFM 450 FXV/FXW/FXX/FXY/FXZ Wolverine	06-10	FA054TT*		MXS054*	FA054R*	MD6215D	MD6215D					44
YFM 450 FWAD Grizzly IRS	11-16	FA054TT*		MXS054*	FA054R*	MD6215D	MD6215D					45
YFM 450 FWAD Grizzly EPS (Power Steering)	11-14	FA054TT*		MXS054*	FA054R*	MD6215D	MD6215D					46
YFZ 450 S/T/R (Quad)	Left 04-05	FA165TT		MXS165	FA165R	MD6054D						47
	Right	FA135TT		MXS135	FA135R		MD6054D					48
YFZ 450 V/W/X (Quad)	Left 06-08	FA165TT		MXS165	FA165R	MD6054D						49
	Right	FA135TT		MXS135	FA135R		MD6054D					50
YFZ 450 B/D	13-14	FA054TT*		MXS054*	FA054R*	MD6054D	MD6054D					51
YFZ 450 RY/RZ (Quad)	Left 09-10	FA165TT		MXS165	FA165R	MD6054D						52
	Right	FA135TT		MXS135	FA135R		MD6054D					53
YFZ 450 RSEA/RSEB/RSED/RSE	Left 11-14	FA165TT		MXS165	FA165R	MD6054D						54
	Right	FA135TT		MXS135	FA135R		MD6054D					55
YXR 450 F Rhino 4WD Side x Side	Left 04-09	FA135TT	FA165TT	MXS135	FA135R	MD6241D					UTVX6241	56
	Right			MXS165	FA165R	MD6241D					UTVX6241	57
YZ 450 FR/FSFT/FV	03-06	FA185TT		MXS185	FA185R	MD6356D		MD6356C			MD6356CX	58
♦ Plain undrilled disc for enduro use MD6190CE												59
YZ 450 FW (4T)	07	FA185TT		MXS185	FA185R			MD6356C			MD6356CX	60

*-2 Sets Required. † For Vee disc colours add RED, BLU, GRN, GLD, ORG suffix to part number. For Custom Finish Options for Vee-Rotors™ including Splatter discs add suffix CHR, CHGR, CHBL, CHBR - available in various colours see page iv. ☼ - Also available as a Vintage Motorcycle Disc.

JAPANESE Built Motorcycles

Line #	BRAKE DISC CHOICES - FRONT						DISC PAD CHOICES - REAR				BRAKE DISC CHOICES - REAR			
	Oversize 250 /280mm Disc Kit	OSX Oversize 250/280mm Disc Kit	Relocating Bracket for 250/ 280mm Disc	Oversize 320mm Disc Kit	SMX Oversize 320mm Disc Kit	Relocating Bracket for 320mm Disc	FA, SFA, TT Pad or Brake Shoe	SFAC Carbon Scooter Pads	Speciality Pads - SXR / Vee / MXS	Sintered/ HH Pads/ Grooved Shoes	Standard Replacement Disc	Contour Disc Rear fitment	Vee Discs CONTOUR	CX Extreme MX Race Disc
1							Y516							
2							Y516							
3							Y515							
4							Y516		Y516G					
5							FA307TT		FA307R	MD6174D				
6							Y516		Y516G					
7							Y516		Y516G					
8							Y516		Y516G					
9							Y532		Y532G					
10							FA307TT		FA307R	MD6252D				
11							FA307TT		FA307R	MD6252D				
12							SFA408	SFAC408	SFA408HH	MD9103D		VR9103		
13							SFA408	SFAC408	SFA408HH	MD9103D		VR9103		
14							SFA408	SFAC408	SFA408HH	MD9103D		VR9103		
15							SFA275	SFAC275	SFA275HH	MD9103D				
16							SFA275	SFAC275	SFA275HH	MD9103D				
17							SFA607							
18							SFA607	SFAC275	SFA607HH	MD9103D				
19							SFA607		SFA607HH	MD9103D				
20							Y528		Y528G					
21	OS6028C	OSX6028	BRK008		SMX6028	BRK009	FA152/2TT		MXS152	FA152/2R	MD6011D			
22	OS6028C	OSX6028	BRK008		SMX6028	BRK009	FA131TT		MXS131	FA131R	MD6135D	MD6135C		MD6135CX
23	OS6028C	OSX6028	BRK008		SMX6028	BRK009	FA152/2TT		MXS152	FA152/2R	MD6011D			
24	OS6028C	OSX6028	BRK008		SMX6028	BRK009	FA131TT		MXS131	FA131R	MD6135D	MD6135C		MD6135CX
25	OS6028C	OSX6028	BRK008		SMX6028	BRK009	FA131TT		MXS131	FA131R	MD6135D	MD6135C		MD6135CX
26							Y528		Y528G					
27	OS6028C	OSX6028	BRK008		SMX6028	BRK009	FA131TT		MXS131	FA131R	MD6135D	MD6135C		MD6135CX
28	OS6028C	OSX6028	BRK008		SMX6028	BRK009	FA131TT		MXS131	FA131R	MD6190D	MD6190C♦		MD6190CX
29														
30	OS6028C	OSX6028	BRK008		SMX6028	BRK009	FA131TT		MXS131	FA131R	MD6135D	MD6135C		MD6135CX
31	OS6028C	OSX6028	BRK008		SMX6028	BRK009	FA131TT		MXS131	FA131R	MD6135D	MD6135C		MD6135CX
32	OS6028C	OSX6028	BRK008		SMX6028	BRK009	FA131TT		MXS131	FA131R	MD6190D	MD6190C♦		MD6190CX
33														
34	OS6028C	OSX6028	BRK008		SMX6028	BRK009	FA367TT		MXS367	FA367R	MD6190D	MD6190C♦		MD6190CX
35														
36	OS6028C	OSX6028	BRK008		SMX6028	BRK009	FA367TT		MXS367	FA367R		MD6190C♦		MD6190CX
37														
38		OSX6392C	BRK046				FA367TT		MXS367	FA367R		MD6190C♦		MD6190CX
39														
40		OSX6392C	BRK046				FA367TT		MXS367	FA367R		MD6190C♦		MD6190CX
41														
42							FA307TT			FA307R	MD6174D			
43							FA307TT			FA307R	MD6252D			
44							FA307TT			FA307R	MD6174D			
45														
46														
47														
48							FA084TT			FA084R	MD6236D			
49														
50							FA323TT			FA323R	MD6263D			
51							FA323TT			FA323R	MD6263D			
52														
53							FA323TT			FA323R		MD6263C		
54														
55							FA323TT			FA323R		MD6263C		
56							FA428TT			FA428R	MD6242D			UTVX6242
57														
58	OS6028C	OSX6028	BRK008		SMX6028	BRK009	FA367TT		MXS367	FA367R	MD6190D	MD6190C♦		MD6190CX
59														
60	OS6028C	OSX6028	BRK008		SMX6028	BRK009	FA367TT		MXS367	FA367R		MD6190C♦		MD6190CX

REAR / ARRIÈRE / HINTEN / POSTERIOR / POSTERIORE

R Suffix = High Durability Sintered Pad. **HH** Suffix = High Performance Sintered Pad. **TT** Suffix = Hard Wearing Off Road Pad. **V** Suffix = Semi Sintered Pad. **G** Suffix = Grooved Shoe.
D Suffix = Drilled Disc. **X** Suffix = Universal Left or Right Disc. **XC** Suffix = Contoured Disc. **LS** Suffix = Left/Steel Disc. **RS** = Right/Steel Disc.

BRAKE APPLICATIONS

*-2 Sets Required. † For Vee disc colours add RED, BLU, GRN, GLD, ORG suffix to part number. For Custom Finish Options for Vee-Rotors™ including Splatter discs add suffix CHR, CHGR, CHBL, CHBR - available in various colours see page iv. Ⓢ - Also available as a Vintage Motorcycle Disc.

JAPANESE Built Motorcycles



YAMAHA Contd.



DISC PAD CHOICES - FRONT

BRAKE DISC CHOICES - FRONT

FA, SFA, TT Pad or Brake Shoe	SFAC Carbon Scooter Pads	Speciality Pads - SXR / Vee / MXS	Sintered/HH Pads/Grooved Shoes	Left / Gauche / Links Standard Replacement Disc	Right / Droite / Rechts Standard Replacement Disc	Contour Disc Universal left and right fitment	Custom Disc Universal left and right fitment	Vee-Discs Black † See note below	CX Extreme MX Race Disc/ UTVX Disc
♦ Plain undrilled disc for enduro use MD6190CE									
YZ 450 FX/FY/FZ/FA/FB/FD/FE/FF (4T) 08-15	FA450TT		MXS450	FA450R			MD6356C		MD6356CX
♦ Plain undrilled disc for enduro use MD6190CE									
YZ 450 F (270mm Disc) 16-19	FA450TT		MXS450	FA450R			MD6392C		MD6392CX
♦ Plain undrilled disc for enduro use MD6190CE									
YZ 450 F (270mm Disc) 20-22	FA755TT		MXS755	FA755R			MD6392C		MD6392CX
♦ Plain undrilled disc for enduro use MD6190CE									
YZ 450 F (270mm Disc, 240mm rear disc) 19-20	FA450TT		MXS450	FA450R			MD6392C		MD6392CX
YZ 450 FGY (60th Anniversary Edition/270mm Disc) 16	FA450TT		MXS450	FA450R			MD6392C		MD6392CX
♦ Plain undrilled disc for enduro use MD6190CE									
IT 465 H/J 81-82	Y508			Y508G					
YZ 465 G 80	Y508			Y508G					
YZ 465 H 81	Y508			Y508G					
IT 490 L 84	Y508			Y508G					
YZ 490 H/J 81-82	Y508			Y508G					
YZ 490 K 83	Y508			Y508G					
YZ 490 L 84	Y508			Y508G					
YZ 490 N 85	FA105TT			FA105R	MD6324D				
YZ 490 S/T 86-87	FA105TT			FA105R	MD6067D				
YZ 490 U 88	FA105TT			FA105R	MD6039D				
IT 500 G/H 80-81	Y507			Y507G					
RD 500 LC 84-86	FA088*			FA088HH*	MD2069	MD2069			
RVZ 500 R (51X) 85	FA088*			FA088HH*	MD2069	MD2069			
SR 500 78-82	FA034				MD2023LS				
SR 500 (3GW1/3/4/6/7) 96-98	Y526								
SR 500 S (3GW5) 98	Y526								
TXXS 500 B 75-77	FA011								
XP 500 N/P/R T-Max 01-03	SFA179	SFAC179		SFA179HH	MD2087LS				
XP 500 S/T/V T-Max (5VU1/2) 04-07	SFA199*	SFAC199*		SFA199HH*	MD2098	MD2098	MD2098C*		
XP 500 T-Max (Non ABS Models) 08-11	SFA252*	SFAC252*		SFA252HH*	MD2107	MD2107	MD2107C*		
XP 500 T-Max (ABS Models) 08-11	SFA252*	SFAC252*		SFA252HH*	MD2107	MD2107	MD2107C*		
XP 500 T-Max (530cc Engine/Non ABS Models) 12-16	SFA252*			SFA252HH*	MD2098	MD2098	MD2098C*		
XP 500 T-Max (530cc Engine/Non ABS Models) - Parking Brake 12-16	SFA621V								
XP 500 A T-Max (530cc Engine/ABS Models) 12-16	SFA252*			SFA252HH*	MD2098	MD2098	MD2098C*		
XP 500 A T-Max (530cc Engine/ABS Models) - Parking Brake 12-16	SFA621V								
XP 500 (530cc Engine - Black & Bronze Max - Non & ABS Models) 13-15	SFA252*			SFA252HH*	MD2098	MD2098	MD2098C*		
XP 500 (530cc Engine - Black & Bronze Max - Non & ABS Models) - Parking Brake 13-15	SFA621V								
XP 530 A - Iron Max (530cc Engine - ABS Model) 15-16	SFA252*			SFA252HH*	MD2098	MD2098	MD2098C*		
XP 530 A - Iron Max (530cc Engine - ABS Model) - Parking Brake 15-16	SFA621V								
XP 500 A T-Max - Lux Max (ABS) 16	SFA252*			SFA252HH*	MD2098	MD2098	MD2098C*		
XP 500 A T-Max - Lux Max (ABS) - Parking Brake 16	SFA621V								
XP 530E-A T-Max (530cc Engine - ABS Model) 17-20	SFA252*			SFA252HH*	MD2098	MD2098	MD2098C*		
XP 530E-A T-Max (530cc Engine - ABS Model) - Parking Brake 17-20	SFA621V								
XP 530-A T-Max SX (530cc Engine - ABS Model) 17-20	SFA252*			SFA252HH*	MD2098	MD2098	MD2098C*		
XP 530-A T-Max SX (530cc Engine - ABS Model) - Parking Brake 17-20	SFA621V								
XP 530D-A T-Max DX (530cc Engine - ABS Model) 17-20	SFA252*			SFA252HH*	MD2098	MD2098	MD2098C*		
XP 530D-A T-Max DX (530cc Engine - ABS Model) - Parking Brake 17-20	SFA621V								
XS 500 C/D 78-79	FA034		FA034V			MD2024			
WR 500 ZD 92	FA135TT		MXS135	FA135R	MD6016D				
XT 500 76-80	Y528			Y528G					
XV 535 Virago 88-94	FA136						MD2023RS		
XV 535/535 S Virago 95-03	FA179		FA179V	FA179HH			MD2076		

FRONT / AVANT / VORN / FRENTE / ANTERIORE

Line #
1
2
3
4
5
6
7
8
9
10
11
12
13
14
15
16
17
18
19
20
21
22
23
24
25
26
27
28
29
30
31
32
33
34
35
36
37
38
39
40
41
42
43
44
45
46
47
48
49
50
51
52
53
54
55
56
57
58
59
60

*-2 Sets Required. † For Vee disc colours add RED, BLU, GRN, GLD, ORG suffix to part number. For Custom Finish Options for Vee-Rotors™ including Splatter discs add suffix CHR, CHGR, CHBL, CHBR - available in various colours see page iv. Ⓢ - Also available as a Vintage Motorcycle Disc.

R Suffix = High Durability Sintered Pad. HH Suffix = High Performance Sintered Pad. TT Suffix = Hard Wearing Off Road Pad. V Suffix = Semi Sintered Pad. G Suffix = Grooved Shoe.
D Suffix = Drilled Disc. X Suffix = Universal Left or Right Disc. XG Suffix = Contoured Disc. LS Suffix = Left/Steel Disc. RS = Right/Steel Disc.

JAPANESE Built Motorcycles

Line #	BRAKE DISC CHOICES - FRONT						DISC PAD CHOICES - REAR				BRAKE DISC CHOICES - REAR			
	Oversize 250 /280mm Disc Kit	OSX Oversize 250/280mm Disc Kit	Relocating Bracket for 250/ 280mm Disc	Oversize 320mm Disc Kit	SMX Oversize 320mm Disc Kit	Relocating Bracket for 320mm Disc	FA, SFA, TT Pad or Brake Shoe	SFAC Carbon Scooter Pads	Speciality Pads - SXR / Vee / MXS	Sintered/ HH Pads/ Grooved Shoes	Standard Replacement Disc	Contour Disc Rear fitment	Vee Discs CONTOUR	CX Extreme MX Race Disc
1														
2	OS6728C	OSX6728	BRK002		SMX6728	BRK034	FA367TT		MXS367	FA367R		MD6190C♦	MD6190CX	
3														
4	OSX6392C		BRK046				FA367TT		MXS367	FA367R		MD6190C♦	MD6190CX	
5														
6	OSX6392C		BRK046				FA367TT		MXS367	FA367R		MD6190C♦	MD6190CX	
7														
8	OSX6392C		BRK046				FA367TT		MXS367	FA367R				
9	OSX6392C		BRK046				FA367TT		MXS367	FA367R		MD6190C♦	MD6190CX	
10														
11							Y510			Y510G				
12							Y528			Y528G				
13							Y510			Y510G				
14							Y510			Y510G				
15							Y510			Y510G				
16							Y506			Y506G				
17							Y510			Y510G				
18							Y510			Y510G				
19							Y510			Y510G				
20							Y510			Y510G				
21							Y528			Y528G				
22							FA104	FA104V	FA104HH	MD2070				
23							FA104	FA104V	FA104HH	MD2070				
24							Y510							
25							Y510							
26							Y510							
27							Y512							
28							SFA319	SFAC319	SFA319HH	MD2011	MD2011C			
29							SFA408	SFAC408	SFA408HH	MD2011	MD2011C			
30							SFA408	SFAC408	SFA408HH	MD2011	MD2011C			
31							SFA408	SFAC408	SFA408HH	MD2011	MD2011C			
32							SFA319		SFA319HH	MD9143D		VR9143		
33														
34														
35							SFA319		SFA319HH	MD9143D		VR9143		
36														
37														
38														
39							SFA319		SFA319HH	MD9143D		VR9143		
40														
41														
42							SFA319		SFA319HH	MD9143D		VR9143		
43														
44														
45							SFA319		SFA319HH	MD9143D		VR9143		
46														
47							SFA319		SFA319HH	MD9143D		VR9143		
48														
49														
50							SFA319		SFA319HH	MD9143D		VR9143		
51														
52														
53							SFA319		SFA319HH	MD9143D		VR9143		
54														
55														
56							FA034	FA034V		MD2025RS Ⓞ				
57							FA152TT	MXS152	FA152R	MD6011D				
58							Y510		Y510G					
59							Y515							
60							Y515							

REAR / ARRIÈRE / HINTEN / POSTERIOR / POSTERIORE

R Suffix = High Durability Sintered Pad. **HH** Suffix = High Performance Sintered Pad. **TT** Suffix = Hard Wearing Off Road Pad. **V** Suffix = Semi Sintered Pad. **G** Suffix = Grooved Shoe.
D Suffix = Drilled Disc. **X** Suffix = Universal Left or Right Disc. **XC** Suffix = Contoured Disc. **LS** Suffix = Left/Steel Disc. **RS** = Right/Steel Disc.

*-2 Sets Required. † For Vee disc colours add RED, BLU, GRN, GLD, ORG suffix to part number. For Custom Finish Options for Vee-Rotors™ including Splatter discs add suffix CHR, CHGR, CHBL, CHBR - available in various colours see page iv. Ⓞ - Also available as a Vintage Motorcycle Disc.

BRAKE APPLICATIONS

JAPANESE Built Motorcycles



YAMAHA Contd.



DISC PAD CHOICES - FRONT

BRAKE DISC CHOICES - FRONT

R Suffix = High Durability Sintered Pad. **HH** Suffix = High Performance Sintered Pad. **TT** Suffix = Hard Wearing Off Road Pad. **V** Suffix = Semi Sintered Pad. **G** Suffix = Grooved Shoe.
D Suffix = Drilled Disc. **X** Suffix = Universal Left or Right Disc. **XS** Suffix = Contoured Disc. **LS** Suffix = Left/Steel Disc. **RS** = Right/Steel Disc.

FRONT / AVANT / VORN / FRENTE / ANTERIORE

Model	Left / Right	Year	DISC PAD CHOICES - FRONT				BRAKE DISC CHOICES - FRONT					Line #
			FA, SFA, TT Pad or Brake Shoe	SFAC Carbon Scooter Pads	Speciality Pads - SXR / Vee / MXS	Sintered/HH Pads/ Grooved Shoes	Left / Gauche / Links Standard Replacement Disc	Right / Droite / Rechts Standard Replacement Disc	Contour Disc Universal left and right fitment	Custom Disc Universal left and right fitment	Vee-Disks Black † See note below	
XJ 550		81-84	FA070*				MD2019LS	MD2019RS				1
XJ 550 H/J/K Maxim		81-83	FA070				MD2023LS					2
XJ 550 RH/RJ/RK Seca		81-83	FA070					MD2023RS				3
XT 550		82-83	Y510			Y510G						4
XZ 550		82-84	FA081*			FA081R	MD2011	MD2011	MD2011C*		VR2011*	5
YFM 550 FWA Grizzly IRS	Left	11-14	FA443TT			FA443R	MD6291D					6
	Right		FA444TT			FA444R		MD6291D				7
YFM 550 FWAD Grizzly EPS	Left	11-14	FA443TT			FA443R	MD6291D					8
(Power Steering)	Right		FA444TT			FA444R		MD6291D				9
T-Max 560 ABS		19-21	SFA252*			SFA252HH*	MD2098	MD2098	MD2098C*			10
T-Max 560 ABS Tech Max		19-21	SFA252*			SFA252HH*	MD2098	MD2098	MD2098C*			11
FZ 600		87-88	FA088*			FA088H*	MD2011	MD2011	MD2011C*		VR2011*	12
FZR 600		89	FA088*			FA088H*	MD2001X	MD2001X	MD2001XC*	MD2001CC*	VR2001BLK*†	13
FZR 600		90-93	FA160*			FA160H*	MD2001X	MD2001X	MD2001XC*	MD2001CC*	VR2001BLK*†	14
FZR 600 R		94-95	FA160*			FA160H*	MD2001X	MD2001X	MD2001XC*	MD2001CC*	VR2001BLK*†	15
FZS 600 Fazer		98-03	FA252*			FA252HH*	MD2001X	MD2001X	MD2001XC*	MD2001CC*	VR2001BLK*†	16
FZ6 Naked - Non ABS/2 Piston Caliper (1B3/1B3D)		04-07	FA199*			FA199H*	MD2082X	MD2082X	MD2082XC*	MD2082CC*	VR2082BLK*†	17
FZ6 NS - Naked/Non ABS/2 Piston Caliper (1B35/1B6)		05-06	FA199*			FA199H*	MD2082X	MD2082X	MD2082XC*	MD2082CC*	VR2082BLK*†	18
FZ6 S2 - Naked/Non ABS/4 Piston Caliper (5S51/5S5)		07-09	FA252*			FA252HH*	MD2082X	MD2082X	MD2082XC*	MD2082CC*	VR2082BLK*†	19
FZ6 Fazer - Half Fairing/Non ABS/2 Piston Caliper (5VX/5VXL)		04-07	FA199*			FA199H*	MD2082X	MD2082X	MD2082XC*	MD2082CC*	VR2082BLK*†	20
FZ6 Fazer - Half Fairing/ABS/2 Piston Caliper (4P5)		06-07	FA199*			FA199H*	MD2082X	MD2082X	MD2082XC*	MD2082CC*	VR2082BLK*†	21
FZ6 Fazer S2 - Half Fairing/Non ABS /4 Piston Caliper (4S81/4S8)		07-09	FA252*			FA252HH*	MD2082X	MD2082X	MD2082XC*	MD2082CC*	VR2082BLK*†	22
FZ6 Fazer S2 - Half Fairing/ABS/4 Piston Caliper (5S2)		08	FA252*			FA252HH*	MD2082X	MD2082X	MD2082XC*	MD2082CC*	VR2082BLK*†	23
SRX 600 (1JK)		85	FA104*			FA104H*	MD2011	MD2011	MD2011C*		VR2011*	24
SRX 600 (3SX)		90	FA123			FA123HH		MD2003X	MD2003XC	MD2003CC	VR2003BLK*†	25
SRX 600		86-87	FA104*			FA104H*	MD2011	MD2011	MD2011C*		VR2011*	26
TT 600 L		84	Y508			Y508G						27
TT 600 N (59X) Frame # 59X 000101 -007852		85-88	FA101TT		MXS101	FA101R	MD6039D					28
TT 600 W (2JT/3SW1) Frame # 59X 007853 Onwards		89-92	FA105TT			FA105R	MD6039D					29
TT 600 E (4LW3/4LW4/4GV4/4GV5)		94-01	FA181TT		MXS181	FA181R	MD6182D					30
TT 600 E (4GV2)		94-95	FA181TT		MXS181	FA181R	MD6182D					31
TT 600 K (4LW1/4GV1/4LW2) Up to 4GV 003403 (Nissan rear caliper)		93-95	FA181TT		MXS181	FA181R	MD6182D					32
TT 600 K From 4GV 003404 (Brembo rear caliper)		95-96	FA181TT		MXS181	FA181R	MD6182D					33
TT 600 R (5CH1)		97	FA181TT		MXS181	FA181R	MD6182D					34
TT 600 R (5CH2)		98-99	FA181TT		MXS181	FA181R	MD6182D					35
TT 600 R (5CH3)		00-02	FA181TT		MXS181	FA181R	MD6182D					36
TT 600 RE (5CH5)		04	FA181TT		MXS181	FA181R	MD6182D					37
XJ 600		84-91	FA088*			FA088H*	MD2011	MD2011	MD2011C*		VR2011*	38
XJ 600 S Diversion		92-97	FA179			FA179HH	MD2031LS					39
XJ 600 S Diversion		98-03	FA199*			FA199HH*	MD2074X	MD2074X	MD2074XC*	MD2074CC*	VR2074BLK*†	40
XJ 600 N		95-97	FA179			FA179HH	MD2031LS				VR2074BLK*†	41
XJ 600 N		98-03	FA199*			FA199HH*	MD2074X	MD2074X	MD2074XC*	MD2074CC*	VR2074BLK*†	42
XJ6-N Diversion 600 (Naked Diversion - Non ABS & ABS Models - 2DS)		09-13	FA199*			FA199HH*	MD2082X	MD2082X	MD2082XC*	MD2082CC*	VR2082BLK*†	43
XJ6-N Diversion 600 (Naked Diversion - Non ABS & ABS Models)		13-15	FA199*			FA199HH*	MD2082X	MD2082X	MD2082XC*	MD2082CC*	VR2082BLK*†	44
XJ6-F Diversion 600 (Full Fairing Diversion - Non ABS & ABS Models - 1CW)		10-13	FA199*			FA199HH*	MD2082X	MD2082X	MD2082XC*	MD2082CC*	VR2082BLK*†	45
XJ6-F Diversion 600 (Full Fairing Diversion - Non ABS & ABS Models)		13-15	FA199*			FA199HH*	MD2082X	MD2082X	MD2082XC*	MD2082CC*	VR2082BLK*†	46
XJ6-S Diversion 600 (Top Fairing Diversion - Non ABS & ABS Models-36C)		09-13	FA199*			FA199HH*	MD2082X	MD2082X	MD2082XC*	MD2082CC*	VR2082BLK*†	47
XJ6-S Diversion 600 (Top Fairing Diversion - Non ABS & ABS Models)		13-15	FA199*			FA199HH*	MD2082X	MD2082X	MD2082XC*	MD2082CC*	VR2082BLK*†	48
XJ6-SP Diversion 600 (Non ABS & ABS Models)		13	FA199*			FA199HH*	MD2082X	MD2082X	MD2082XC*	MD2082CC*	VR2082BLK*†	49
XT 600		84-86	FA081			FA081R*	MD6070D					50
XT 600		87	FA118				MD6070D					51

*-2 Sets Required. † For Vee disc colours add RED, BLU, GRN, GLD, ORG suffix to part number. For Custom Finish Options for Vee-Rotors™ including Splatter discs add suffix CHR, CHGR, CHBL, CHBR - available in various colours see page iv. ☼ - Also available as a Vintage Motorcycle Disc.

JAPANESE Built Motorcycles

Line #	BRAKE DISC CHOICES - FRONT						DISC PAD CHOICES - REAR				BRAKE DISC CHOICES - REAR			
	OverSize 250 /280mm Disc Kit	OSX OverSize 250/280mm Disc Kit	Relocating Bracket for 250/ 280mm Disc	OverSize 320mm Disc Kit	SMX OverSize 320mm Disc Kit	Relocating Bracket for 320mm Disc	FA, SFA, TT Pad or Brake Shoe	SFAC Carbon Scooter Pads	Speciality Pads - SXR / Vee / MXS	Sintered/ HH Pads/ Grooved Shoes	Standard Replacement Disc	Contour Disc Rear fitment	Vee Discs CONTOUR	CX Extreme MX Race Disc
1							Y512							
2							Y512							
3							Y516							
4							Y510		Y510G					
5							Y512							
6							FA445TT		FA445R	MD6292D				
7							FA446TT		FA446R	MD6292D				
8							FA445TT		FA445R	MD6292D				
9							FA446TT		FA446R	MD6292D				
10							SFA319		SFA319HH	MD9143D		VR9143		
11							SFA319		SFA319HH	MD9143D		VR9143		
12							FA104	FA104V	FA104HH	MD2002	MD2002C	VR2002		
13							FA088	FA088V	FA088HH	MD2002	MD2002C	VR2002		
14							FA088	FA088V	FA088HH	MD2002	MD2002C	VR2002		
15							FA088	FA088V	FA088HH	MD2002	MD2002C	VR2002		
16							FA104	FA104V	FA104HH	MD2002	MD2002C	VR2002		
17							FA174	FA174V	FA174HH	MD2093	MD2093C	VR2093		
18							FA174	FA174V	FA174HH	MD2093	MD2093C	VR2093		
19							FA174	FA174V	FA174HH	MD2093	MD2093C	VR2093		
20														
21							FA174	FA174V	FA174HH	MD2093	MD2093C	VR2093		
22							FA174	FA174V	FA174HH	MD2093	MD2093C	VR2093		
23														
24							FA174	FA174V	FA174HH	MD2093	MD2093C	VR2093		
25							FA174	FA174V	FA174HH	MD2093	MD2093C	VR2093		
26							FA104	FA104V	FA104HH	MD2002	MD2002C	VR2002		
27							FA104	FA104V	FA104HH	MD2002	MD2002C	VR2002		
28							FA104	FA104V	FA104HH	MD2002	MD2002C	VR2002		
29							Y506		Y506G					
30							Y527		Y527G					
31							Y527		Y527G					
32							FA208TT	MXS208	FA208R	MD6183D				
33							FA152/2TT	MXS152	FA152/2R	MD6183D				
34														
35							FA152TT	MXS152	FA152R	MD6183D				
36							FA208TT	MXS208	FA208R	MD6183D				
37							FA208TT	MXS208	FA208R	MD6183D				
38							FA208TT	MXS208	FA208R	MD6183D				
39							FA208TT	MXS208	FA208R	MD6183D				
40							FA208TT	MXS208	FA208R	MD6183D				
41							FA088	FA088V	FA088HH	MD2011	MD2011C	VR2011		
42							FA104	FA104V	FA104HH	MD2002	MD2002C	VR2002		
43							FA104	FA104V	FA104HH	MD2002	MD2002C	VR2002		
44							FA104	FA104V	FA104HH	MD2002	MD2002C	VR2002		
45							FA104	FA104V	FA104HH	MD2002	MD2002C	VR2002		
46														
47							FA140	FA140V	FA140HH	MD2117		VR2117		
48														
49							FA174		FA174HH	MD2117		VR2117		
50														
51							FA140		FA140HH	MD2117		VR2117		
52														
53							FA174		FA174HH	MD2117		VR2117		
54														
55							FA140		FA140HH	MD2117		VR2117		
56														
57							FA174		FA174HH	MD2117		VR2117		
58							FA174	FA174V	FA174HH	MD2117		VR2117		
59							Y510		Y510G					
60							FA101TT		FA101R	MD6072D				

REAR / ARRIÈRE / HINTEN / POSTERIOR / POSTERIORE

R Suffix = High Durability Sintered Pad. **HH** Suffix = High Performance Sintered Pad. **TT** Suffix = Hard Wearing Off Road Pad. **V** Suffix = Semi Sintered Pad. **G** Suffix = Grooved Shoe.
D Suffix = Drilled Disc. **X** Suffix = Universal Left or Right Disc. **XC** Suffix = Contoured Disc. **LS** Suffix = Left/Steel Disc. **RS** = Right/Steel Disc.

BRAKE APPLICATIONS

*-2 Sets Required. † For Vee disc colours add RED, BLU, GRN, GLD, ORG suffix to part number. For Custom Finish Options for Vee-Rotors™ including Splatter discs add suffix CHR, CHGR, CHBL, CHBR - available in various colours see page iv. Ⓢ - Also available as a Vintage Motorcycle Disc.

JAPANESE Built Motorcycles



YAMAHA Contd.



DISC PAD CHOICES - FRONT

BRAKE DISC CHOICES - FRONT

FA, SFA, TT Pad or Brake Shoe	SFAC Carbon Scooter Pads	Speciality Pads - SXR / Vee / MXS	Sintered/HH Pads/ Grooved Shoes	Left / Gauche / Links Standard Replacement Disc	Right / Droite / Rechts Standard Replacement Disc	Contour Disc Universal left and right fitment	Custom Disc Universal left and right fitment	Vee-Disks Black † See note below	CX Extreme MX Race Disc/ UTVX Disc
XT 600 Z Tenere	84	FA081	FA081R*	MD6070D					
XT 600 Z Tenere	85-88	FA118		MD6070D					
XT 600/600 Z Tenere	88-90	FA118		MD6070D					
XT 600 E	92-94	FA172TT	FA172R	MD6070D					
XT 600 E	95-03	FA172TT	FA172R	MD6116D					
YFM 600 FWAK/FWAL/FWAM/FWAN Grizzly	98-01	FA084TT*	FA084R*	MD6140D	MD6140D				
YFM 600 HM Grizzly Hunting	00	FA084TT*	FA084R*	MD6140D	MD6140D				
YX 600 S/SC/T/TC/UC/UW/WC/AAC Radian	86-90	FA088*	FA088HH*	MD2011	MD2011	MD2011C*		VR2011*	
YZF 600 R Thundercat	96-03	FA252*	FA252HH*	MD2074X	MD2074X	MD2074XC*	MD2074CC*	VR2074BLK*†	
YZF-R6	99-02	FA252*	FA252HH*	MD2074X	MD2074X	MD2074XC*	MD2074CC*	VR2074BLK*†	
YZF-R6	03-04	FA252*	FA252HH*	MD2082X	MD2082X	MD2082XC*	MD2082CC*	VR2082BLK*†	
YZF-R6	05-07		FA380HH*	MD2095X	MD2095X	MD2095XC*	MD2095CC*	VR2095BLK*†	
YZF-R6	08-16		FA380HH*	MD2105X	MD2105X	MD2105XC*		VR2105BLK*†	
YZF-R6	17-21		FA380HH*	MD2124X	MD2124X	MD2124XC*		VR2124BLK*†	
XJ 650 G/H/J/K Maxim	80-83	FA061		MD2023LS*					
XJ 650 LH Midnight	81	FA061		MD2023LS*					
XJ 650 RJ Seca	82	FA034*		MD2019LS	MD2019RS				
XJ 650 LK Seca	83	FA081*	FA081R*	MD2011	MD2011	MD2011C*		VR2011*	
XJ 650	80-84	FA034*		MD2019LS	MD2019RS				
XJ 650 Turbo	82	FA081*	FA081R*	MD2011	MD2011	MD2011C*		VR2011*	
XS 650	75	FA011*							
XS 650	77-81	FA034			MD2025RS*				
XS 650 SE	79-80	FA034			MD2024				
XS 650 SE	81	FA034			MD2024				
XVS 650 Drag Star	97-04	FA179	FA179HH		MD2076				
XVS 650 A Drag Star Classic	98-07	FA179	FA179HH		MD2076				
MT-03 (660cc)	06-12	FA199*	FA199HH*	MD2082X	MD2082X	MD2082XC*	MD2082CC*	VR2082BLK*†	
SZR 660	96-97	FA095	FA095HH		MD2003X	MD2003XC	MD2003CC	VR2003BLK*†	
XT 660 X Supermoto	04-16	FA244	FA244HH	MD6226D					
XT 660 R	04-16	FA209/2	FA209/2HH	MD6235D					
XT 660 Z Tenere (Non ABS)	08-16	FA181TT*	MXS181*	FA181R*	MD6235D	MD6235D			
XT 660 ZA Tenere (ABS)	11-16	FA181TT*	MXS181*	FA181R*	MD6235D	MD6235D			
XTZ 660 Tenere	91-98	FA172TT	FA172R	MD6116D					
YFM 660 R/VP/RR/RS/RT Raptor	01-05	FA084TT*	MXS084*	FA084R*	MD6054D	MD6054D			
YFM 660 FR/FS/FT Grizzly	03-05	FA084TT*	MXS084*	FA084R*	MD6189D	MD6189D			
YFM 660 FWAP/FWAR/FWAS/FWAT/FWAV /FGW/FGX Grizzly	02-08	FA084TT*	MXS084*	FA084R*	MD6189D	MD6189D			
YXR 660 FAS/FAT/FAV Rhino	Left 04-06	FA135TT	MXS135	FA135R	MD6241D				UTVX6241
4 x 4 Side x Side	Right	FA165TT	MXS165	FA165R	MD6241D				UTVX6241
MT-07 Non ABS (689cc/2Cyl)	14-16	FA252*	FA252HH*	MD2127X	MD2127X	MD2127XC*		VR2127BLK*†	
MT-07A ABS (689cc/2Cyl)	14-21	FA252*	FA252HH*	MD2127X	MD2127X	MD2127XC*		VR2127BLK*†	
MT-07A Moto Cage (ABS)	15-17	FA252*	FA252HH*	MD2127X	MD2127X	MD2127XC*		VR2127BLK*†	
MT-07A Moto Cage (Non ABS)	14-16	FA252*	FA252HH*	MD2127X	MD2127X	MD2127XC*		VR2127BLK*†	
FZX 700 S/SC/T/TC Fazer	86-87	FA088*	FA088V*	FA088HH*	MD2011	MD2011	MD2011C*	VR2011*	
XT 700 Z Tenere Rally Edition	18-21	FA181TT*	MXS181*	FA181HH*	MD2127X	MD2127XC			
Tracer 700 (MTT 690)	16-20	FA252*	FA252HH*			MD2127XC*		VR2127BLK*†	
Tracer 700 GT	19-21	FA252*	FA252HH*			MD2127XC*		VR2127BLK*†	
XSR 700 ABS	16-20	FA252*	FA252HH*			MD2127XC*		VR2127BLK*†	
XSR 700 ABS Xtribute	19-21	FA252*	FA252HH*			MD2127XC*		VR2127BLK*†	
YFM 700 RV/RW/RAA/R	Left 06-12	FA165TT	MXS165	FA165R	MD6054D				
	Right	FA135TT	MXS135	FA135R		MD6054D			
YFM 700 RD/RE	Left 13-14	FA165TT	MXS165	FA165R	MD6054D				
	Right	FA135TT	MXS135	FA135R		MD6054D			
YFM 700 RSE	Left 13-18	FA165TT	MXS165	FA165R	MD6054D				
	Right	FA135TT	MXS135	FA135R		MD6054D			
YFM 700 FWAD Grizzly EPS	Left 07-18	FA443TT		FA443R	MD6291D				
	Right	FA444TT		FA444R		MD6291D			
YXM 700 E Viking EPS Como	Left 16	FA642TT		FA642R	MD6382D				UTVX6382
(YXM70VPHG)	Right	FA645TT		FA645R		MD6382D			UTVX6382

FRONT / AVANT / VORN / FRENTE / ANTERIORE

Line #

R Suffix = High Durability Sintered Pad. HH Suffix = High Performance Sintered Pad. TT Suffix = Hard Wearing Off Road Pad. V Suffix = Semi Sintered Pad. G Suffix = Grooved Shoe. D Suffix = Drilled Disc. X Suffix = Universal Left or Right Disc. XC Suffix = Contoured Disc. LS Suffix = Left/Steel Disc. RS Suffix = Right/Steel Disc.

*-2 Sets Required. † For Vee disc colours add RED, BLU, GRN, GLD, ORG suffix to part number. For Custom Finish Options for Vee-Rotors™ including Splatter discs add suffix CHR, CHGR, CHBL, CHBR - available in various colours see page iv. * - Also available as a Vintage Motorcycle Disc.

JAPANESE Built Motorcycles

Line #	BRAKE DISC CHOICES - FRONT						DISC PAD CHOICES - REAR				BRAKE DISC CHOICES - REAR			
	OverSize 250 /280mm Disc Kit	OSX OverSize 250/280mm Disc Kit	Relocating Bracket for 250/ 280mm Disc	OverSize 320mm Disc Kit	SMX OverSize 320mm Disc Kit	Relocating Bracket for 320mm Disc	FA, SFA, TT Pad or Brake Shoe	SFAC Carbon Scooter Pads	Speciality Pads - SXR / Vee / MXS	Sintered/ HH Pads/ Grooved Shoes	Standard Replacement Disc	Contour Disc Rear fitment	Vee Discs CONTOUR	CX Extreme MX Race Disc
1							Y510		Y510G					
2							Y510		Y510G					
3							FA101TT		FA101R	MD6072D				
4							FA101TT		FA101R	MD6072D				
5							FA101TT		FA101R	MD6072D				
6							Y516		Y516G					
7							Y516		Y516G					
8							Y512							
9							FA088	FA088V	FA088HH	MD2002	MD2002C	VR2002		
10							FA275		FA275HH	MD2084	MD2084C	VR2084		
11							FA174		FA174HH	MD2091	MD2091C	VR2091		
12							FA174		FA174HH	MD2091	MD2091C	VR2091		
13							FA174		FA174HH	MD2091	MD2091C	VR2091		
14							FA436		FA436HH	MD2091	MD2091C	VR2091		
15							Y512							
16							Y512							
17							Y515							
18							Y515							
19							Y515							
20							Y515							
21							Y514							
22							Y514							
23							FA034			MD2025RS				
24							Y514							
25							Y515							
26							Y515							
27							FA213		FA213HH	MD2093	MD2093C	VR2093		
28							FA047		FA047HH	MD2021	MD2021C	VR2021		
29							FA213		FA213HH	MD6234D				
30							FA213		FA213HH	MD6234D				
31							FA208TT	MXS208	FA208R	MD6234D				
32							FA208TT	MXS208	FA208R	MD6234D				
33							FA101TT		FA101R	MD6072D				
34							FA084TT		FA084R	MD6237D				
35							FA344TT		FA344R	MD6197D				
36														
37							FA344TT		FA344R	MD6197D				
38							FA428TT		FA428R	MD6242D			UTVX6242	
39														
40							FA174	FA174V	FA174HH		MD2120C	VR2120		
41							FA174	FA174V	FA174HH		MD2120C	VR2120		
42							FA174	FA174V	FA174HH		MD2120C	VR2120		
43							FA174	FA174V	FA174HH		MD2120C	VR2120		
44							FA088	FA088V	FA088HH	MD2069				
45							FA208TT	MXS208	FA208R		MD2120C	VR2120		
46							FA174	FA174V	FA174HH		MD2120C	VR2120		
47							FA174	FA174V	FA174HH		MD2120C	VR2120		
48							FA174	FA174V	FA174HH		MD2120C	VR2120		
49							FA174	FA174V	FA174HH		MD2120C	VR2120		
50							FA428TT		FA428R	MD6263D				
51														
52							FA323TT		FA323R	MD6236D				
53														
54							FA323TT		FA323R	MD6236D				
55														
56							FA445TT		FA445R	MD6292D				
57							FA446TT		FA446R	MD6292D				
58							FA674TT		FA674R	MD6382D			UTVX6382	
59							FA675TT		FA675R	MD6382D			UTVX6382	
60														

REAR / ARRIÈRE / HINTEN / POSTERIOR / POSTERIORE

R Suffix = High Durability Sintered Pad. **HH** Suffix = High Performance Sintered Pad. **TT** Suffix = Hard Wearing Off Road Pad. **V** Suffix = Semi Sintered Pad. **G** Suffix = Grooved Shoe.
D Suffix = Drilled Disc. **X** Suffix = Universal Left or Right Disc. **XC** Suffix = Contoured Disc. **LS** Suffix = Left/Steel Disc. **RS** = Right/Steel Disc.

BRAKE APPLICATIONS

*-2 Sets Required. † For Vee disc colours add RED, BLU, GRN, GLD, ORG suffix to part number. For Custom Finish Options for Vee-Rotors™ including Splatter discs add suffix CHR, CHGR, CHBL, CHBR - available in various colours see page iv. ☉ - Also available as a Vintage Motorcycle Disc.

JAPANESE Built Motorcycles



YAMAHA Contd.



DISC PAD CHOICES - FRONT

BRAKE DISC CHOICES - FRONT

R Suffix = High Durability Sintered Pad. **HH** Suffix = High Performance Sintered Pad. **TT** Suffix = Hard Wearing Off Road Pad. **V** Suffix = Semi Sintered Pad. **G** Suffix = Grooved Shoe.

D Suffix = Drilled Disc. **X** Suffix = Universal Left or Right Disc. **XC** Suffix = Contoured Disc. **LS** Suffix = Left/Steel Disc. **RS** = Right/Steel Disc.

		FA, SFA, TT Pad or Brake Shoe	SFAC Carbon Scooter Pads	Speciality Pads - SXR / Vee / MXS	Sintered/HH Pads/ Grooved Shoes	Left / Gauche / Links Standard Replacement Disc	Right / Droite / Rechts Standard Replacement Disc	Contour Disc Universal left and right fitment	Custom Disc Universal left and right fitment	Vee-Disks Black † See note below	CX Extreme MX Race Disc/ UTVX Disc	Line #
YXM 700 E Viking EPS Como (YXM70VPHG)												1
- Parking Brake	16	FA497TT				MD6381D						2
YXM 700 E Wolverine R (YXE70WPHG) Left	16	FA642TT			FA642R	MD6382D					UTVX6382	3
Right		FA645TT			FA645R		MD6382D				UTVX6382	4
YXM 700 E Wolverine R (YXE70WPHG) - Parking Brake	16	FA497TT				MD6381D						5
YXM 700 ES Viking EPS SE Left	14-16	FA642TT			FA642R	MD6382D					UTVX6382	6
(YXM700PSE) Right		FA645TT			FA645R		MD6382D				UTVX6382	7
YXM 700 ES Viking EPS SE (YXM700PSE)												8
- Parking Brake	14-16	FA497TT				MD6381D						9
YXC 700 E Viking VI EP Left	15-18	FA642TT			FA642R	MD6382D					UTVX6382	10
(YXC700PF/PXG/PXH/PXJ) Right		FA645TT			FA645R		MD6382D				UTVX6382	11
YXC 700 E Viking VI EP (YXC700PF/PXG/PXH/PXJ)												12
- Parking Brake	15-18	FA497TT				MD6381D						13
YXP 700 AS/AT/AV Pro Hauler 700 Side x Side	04-06											14
YXR 700 Rhino 4 x 4 SE Left	09	FA165TT			FA165R	MD6241D					UTVX6241	15
Right		FA135TT			FA135R		MD6241D				UTVX6241	16
YXR 700 Rhino 4 x 4 SE - Parking Brake	09	FA497TT										17
YXR 700 FA/FB/FD Rhino Side x Side Left	11-13	FA165TT			FA165R	MD6241D					UTVX6241	18
Right		FA135TT			FA135R		MD6241D				UTVX6241	19
YZF-R7	22				FA252HH*	MD2119X	MD2119X					20
YXR 700 FA/FB/FD Rhino Side x Side - Parking Brake	11-13	FA497TT										21
FZ 750	85-86	FA088*			FA088HH*	MD2069	MD2069					22
FZ 750	87-88	FA088*			FA088HH*	MD2011	MD2011	MD2011C*		VR2011*		23
FZ 750	89-91	FA123*			FA123HH*	MD2001X	MD2001X	MD2001XC*	MD2001CC*	VR2001BLK*†		24
FZX 750	87	FA088*			FA088HH*	MD2011	MD2011	MD2011C*		VR2011*		25
FZR 750 Genesis	87	FA123*			FA123HH*	MD2003X	MD2003X	MD2003XC*	MD2003CC*	VR2003BLK*†		26
FZR 750 R OWO1	89-90	FA145*			FA145HH*	MD2009LS	MD2009RS					27
XJ 750 RF/RJ/RK Seca	81-83	FA070*		FA070V*		MD2023LS*	MD2023RS*					28
XJ 750	82-84	FA070*		FA070V*		MD2023LS*	MD2023RS*					29
XS 750	77-79	FA034*		FA034V*		MD2025LS*	MD2025RS*					30
XS 750 SE Left	79-80	FA061		FA061V		MD2025LS*						31
Right		FA041		FA041V			MD2025RS*					32
XTZ 750 Super Tenere Left	89-95	FA135TT		MXS135	FA135R	MD6118D						33
Right		FA165TT		MXS165	FA165R		MD6118D					34
XV 750 SE	81	FA061		FA061V		MD2024 *						35
XV 750 Virago	92-93	FA088*		FA088V*	FA088HH*	MD2011	MD2011	MD2011C*		VR2011*		36
XV 750 Virago	94-97	FA179*		FA179V*	FA179HH*	MD2067	MD2067					37
YZF 750 R/SP	93-97	FA190*			FA190HH*	MD2003X	MD2003X	MD2003XC*	MD2003CC*	VR2003BLK*†		38
YZF-R7 750 OWO2 (Race Version)	99-01	FA424*			FA424HH*							39
YZF-R7 750 OWO2 (Road Version) (5FL1)	99-01	FA252*			FA252HH*	MD2083	MD2083					40
FZ 8 N-800cc (Naked/Single Headlight/Non ABS)	11-15				FA380HH*	MD2095X	MD2095X	MD2095XC*	MD2095CC*	VR2095BLK*†		41
FZ 8 NA-800cc (Naked/Single Headlight/ABS)	11-15				FA380HH*	MD2095X	MD2095X	MD2095XC*	MD2095CC*	VR2095BLK*†		42
Fazer 8 S-800cc (Top Fairing/Twin Headlight/Non ABS)	11-15				FA380HH*	MD2095X	MD2095X	MD2095XC*	MD2095CC*	VR2095BLK*†		43
Fazer 8 SA-800cc (Top Fairing/Twin Headlight/ABS)	11-15				FA380HH*	MD2095X	MD2095X	MD2095XC*	MD2095CC*	VR2095BLK*†		44
TDM 850	91-95	FA123*		FA123V*	FA123HH*	MD2001X	MD2001X	MD2001XC*	MD2001CC*	VR2001BLK*†		45
TDM 850	96-01	FA160*			FA160HH*	MD2001X	MD2001X	MD2001XC*	MD2001CC*	VR2001BLK*†		46
TRX 850	96-99	FA123*		FA123V*	FA123HH*	MD2001X	MD2001X	MD2001XC*	MD2001CC*	VR2001BLK*†		47
XS 850	80	FA034*		FA034V*		MD2024 *	MD2024 *					48
MT-09 (1RC/Non ABS 847cc/3 Cyl Engine)	14-16	FA252*			FA252HH*	MD2119X	MD2119X	MD2119XC*		VR2119BLK*†		49
MT-09 A (2DR/ABS 847cc/3 Cyl Engine)	14-16	FA252*			FA252HH*	MD2119X	MD2119X	MD2119XC*		VR2119BLK*†		50
MT-09 A Sport Tracker ABS (847cc/3 Cyl Engine)	14-16	FA252*			FA252HH*	MD2119X	MD2119X	MD2119XC*		VR2119BLK*†		51
MT-09 A Street Rally ABS (847cc/3 Cyl Engine)	14-16	FA252*			FA252HH*	MD2119X	MD2119X	MD2119XC*		VR2119BLK*†		52
MT-09 ABS (MT850-A 847cc/3 Cyl Engine)	17-21	FA252*			FA252HH*	MD2119X	MD2119X	MD2119XC*		VR2119BLK*†		53
MT-09 SP ABS (MT850-D 847cc/3 Cyl Engine)	18-21	FA252*			FA252HH*	MD2119X	MD2119X	MD2119XC*		VR2119BLK*†		54
MT-09 Tracer 900 ABS (847cc/3 Cyl Engine)	15-21	FA252*			FA252HH*	MD2119X	MD2119X	MD2119XC*		VR2119BLK*†		55
MT-09 Tracer 900 GT ABS (847cc/3 Cyl Engine)	18-21	FA252*			FA252HH*	MD2119X	MD2119X	MD2119XC*		VR2119BLK*†		56
Niken ABS (847cc/3 Cyl Engine)	18-20				FA380HH*							57
Niken GT ABS (847cc/3 Cyl Engine)	19-20				FA380HH*							58
TDM 900 (5PS/Non ABS)	02-14	FA252*			FA252HH*	MD2074X	MD2074X	MD2074XC*	MD2074CC*	VR2074BLK*†		59
TDM 900 A (2B0/ABS)	05-13	FA252*			FA252HH*	MD2074X	MD2074X	MD2074XC*	MD2074CC*	VR2074BLK*†		60

FRONT / AVANT / VORN / FRENTE / ANTERIORE

*-2 Sets Required. † For Vee disc colours add RED, BLU, GRN, GLD, ORG suffix to part number. For Custom Finish Options for Vee-Rotors™ including Splatter discs add suffix CHR, CHGR, CHBL, CHBR - available in various colours see page iv. * - Also available as a Vintage Motorcycle Disc.

JAPANESE Built Motorcycles

Line #	BRAKE DISC CHOICES - FRONT						DISC PAD CHOICES - REAR				BRAKE DISC CHOICES - REAR			
	OverSize 250 /280mm Disc Kit	OSX OverSize 250/280mm Disc Kit	Relocating Bracket for 250/ 280mm Disc	OverSize 320mm Disc Kit	SMX OverSize 320mm Disc Kit	Relocating Bracket for 320mm Disc	FA, SFA, TT Pad or Brake Shoe	SFAC Carbon Scooter Pads	Speciality Pads - SXR / Vee / MXS	Sintered/ HH Pads/ Grooved Shoes	Standard Replacement Disc	Contour Disc Rear fitment	Vee Discs CONTOUR	CX Extreme MX Race Disc
1														
2														
3							FA674TT		FA674R	MD6382D			UTVX6382	
4							FA675TT		FA675R	MD6382D			UTVX6382	
5														
6							FA674TT		FA674R	MD6382D			UTVX6382	
7							FA675TT		FA675R	MD6382D			UTVX6382	
8														
9														
10							FA674TT		FA674R	MD6382D			UTVX6382	
11							FA675TT		FA675R	MD6382D			UTVX6382	
12														
13														
14							Y534		Y534G					
15							FA165TT		FA165R	MD6332D			UTVX6332	
16							FA135TT		FA135R	MD6332D			UTVX6332	
17														
18							FA165TT		FA165R	MD6332D			UTVX6332	
19							FA135TT		FA135R	MD6332D			UTVX6332	
20							FA174		FA174HH	MD2120	MD2120C		VR2120	
21														
22							FA088	FA088V	FA088HH	MD2069				
23							FA088	FA088V	FA088HH	MD2011	MD2011C	VR2011		
24							FA088	FA088V	FA088HH	MD2011	MD2011C	VR2011		
25							FA088	FA088V	FA088HH	MD2069				
26							FA088	FA088V	FA088HH	MD2011	MD2011C	VR2011		
27							FA088	FA088V	FA088HH	MD2008				
28							Y515							
29							Y515							
30							FA034	FA034V		MD2025RS				
31														
32							FA034	FA034V		MD2025RS				
33							FA165/2TT		FA165/2R	MD6119D				
34														
35							Y512							
36							Y512							
37							Y515							
38							FA088	FA088V	FA088HH	MD2002	MD2002C			
39														
40							FA267		FA267HH	MD2086	MD2086C	VR2086		
41							FA174	FA174V	FA174HH	MD2116	MD2116C	VR2116		
42							FA174	FA174V	FA174HH	MD2116	MD2116C	VR2116		
43							FA174	FA174V	FA174HH	MD2116	MD2116C	VR2116		
44							FA174	FA174V	FA174HH	MD2116	MD2116C	VR2116		
45							FA088	FA088V	FA088HH	MD2002	MD2002C	VR2002		
46							FA088	FA088V	FA088HH	MD2002	MD2002C	VR2002		
47							FA088	FA088V	FA088HH	MD2002	MD2002C	VR2002		
48							FA034	FA034V		MD2024				
49							FA174	FA174V	FA174HH	MD2120	MD2120C	VR2120		
50							FA174	FA174V	FA174HH	MD2120	MD2120C	VR2120		
51							FA174	FA174V	FA174HH	MD2120	MD2120C	VR2120		
52							FA174	FA174V	FA174HH	MD2120	MD2120C	VR2120		
53							FA174	FA174V	FA174HH	MD2120	MD2120C	VR2120		
54							FA174	FA174V	FA174HH	MD2120	MD2120C	VR2120		
55							FA174	FA174V	FA174HH	MD2120	MD2120C	VR2120		
56							FA174	FA174V	FA174HH	MD2120	MD2120C	VR2120		
57							FA436		FA436HH					
58							FA436		FA436HH					
59							FA319/2	FA319/2V	FA319/2HH	MD2002	MD2002C	VR2002		
60							FA319/2	FA319/2V	FA319/2HH	MD2002	MD2002C	VR2002		

REAR / ARRIÈRE / HINTEN / POSTERIOR / POSTERIORE

*-2 Sets Required. † For Vee disc colours add RED, BLU, GRN, GLD, ORG suffix to part number. For Custom Finish Options for Vee-Rotors™ including Splatter discs add suffix CHR, CHGR, CHBL, CHBR - available in various colours see page iv. ☉ - Also available as a Vintage Motorcycle Disc.

Part numbers, prefixes, suffixes, photos and illustrations shown in this catalogue are trademarks and/or copyrights of EBC Brakes or the trademark owner A C Freeman Investments Ltd and use without express written permission of the owners is punishable by law. 177

R Suffix = High Durability Sintered Pad. **HH** Suffix = High Performance Sintered Pad. **TT** Suffix = Hard Wearing Off Road Pad. **V** Suffix = Semi Sintered Pad. **G** Suffix = Grooved Shoe.
D Suffix = Drilled Disc. **X** Suffix = Universal Left or Right Disc. **XC** Suffix = Contoured Disc. **LS** Suffix = Left/Steel Disc. **RS** = Right/Steel Disc.

BRAKE APPLICATIONS

JAPANESE Built Motorcycles



YAMAHA Contd.



DISC PAD CHOICES - FRONT

BRAKE DISC CHOICES - FRONT

R Suffix = High Durability Sintered Pad. **HH** Suffix = High Performance Sintered Pad. **TT** Suffix = Hard Wearing Off Road Pad. **V** Suffix = Semi Sintered Pad. **G** Suffix = Grooved Shoe.

D Suffix = Drilled Disc. **X** Suffix = Universal Left or Right Disc. **XC** Suffix = Contoured Disc. **LS** Suffix = Left/Steel Disc. **RS** = Right/Steel Disc.

FRONT / AVANT / VORN / FRENTE / ANTERIORE

		FA, SFA, TT Pad or Brake Shoe	SFAC Carbon Scooter Pads	Speciality Pads - SXR / Vee / MXS	Sintered/HH Pads/ Grooved Shoes	Left / Gauche / Links Standard Replacement Disc	Right / Droite / Rechts Standard Replacement Disc	Contour Disc Universal left and right fitment	Custom Disc Universal left and right fitment	Vee-Discs Black † See note below	CX Extreme MX Race Disc/ UTVX Disc	Line #
XJ 900/900 F	83-86	FA088*			FA088HH*	MD2069	MD2069					1
XJ 900/900 F	87-94	FA088*			FA088HH*	MD2011	MD2011	MD2011C*		VR2011*		2
XJ 900 S Diversion	95-03	FA179*		FA179V*	FA179HH*	MD2012	MD2012					3
XSR 900 ABS (MTM 850)	16-20				FA380HH*	MD2119X	MD2119X	MD2119XC*		VR2119BLK*†		4
XSR 900 Abarth ABS (MTM 850)	17-18				FA380HH*	MD2119X	MD2119X	MD2119XC*		VR2119BLK*†		5
SCR 950 (XVS 950XR-A)	17-20	FA179		FA179V	FA179HH							6
XV 950 Racer (Remote Reservoir Rear Shocks)	15-16	FA179		FA179V	FA179HH							7
XVS 950 A Midnight Star	09-13	FA179		FA179V	FA179HH	MD2089X		MD2089XC	MD2089CC	VR2089BLK†		8
XV 950 - XVS 950 (Non ABS/Standard Rear Shocks)	14	FA179		FA179V	FA179HH							9
XV 950 CU - XVS 950 (1XC1/ABS/ Standard Rear Shocks)	14-16	FA179		FA179V	FA179HH							10
XV 950 R - XVS 950 R (2DE/ Remote Reservoir Rear Shocks)	14-20	FA179		FA179V	FA179HH			MD2074XC				11
FZR 1000 Genesis	87-88	FA123*			FA123HH*	MD2003X	MD2003X	MD2003XC*	MD2003CC*	VR2003BLK*†		12
FZR 1000 EX UP (STD Forks)	89-90	FA160*			FA160HH*	MD2003X	MD2003X	MD2003XC*	MD2003CC*	VR2003BLK*†		13
FZR 1000 EX UP (USD Forks)	91-93	FA182*			FA182HH*	MD2003X	MD2003X	MD2003XC*	MD2003CC*	VR2003BLK*†		14
FZR 1000 EX UP (6 piston caliper)	94-95	FA190*			FA190HH*	MD2003X	MD2003X	MD2003XC*	MD2003CC*	VR2003BLK*†		15
FZS 1000 Fazer	01-05	FA252*			FA252HH*	MD2074X	MD2074X	MD2074XC*	MD2074CC*	VR2074BLK*†		16
FZ1 (Naked) (2D1) (1000cc)	06-09				FA380HH*	MD2101X	MD2101X	MD2101XC*		VR2101BLK*†		17
FZ1 N/NA (Naked) (Non ABS & ABS)	10-15				FA380HH*	MD2101X	MD2101X	MD2101XC*		VR2101BLK*†		18
FZ1 Fazer (3C3) (Half fairing/Non ABS)	06-15				FA380HH*	MD2101X	MD2101X	MD2101XC*		VR2101BLK*†		19
FZ1 Fazer (Half fairing/ABS - 5D0)	08-15				FA380HH*	MD2101X	MD2101X	MD2101XC*		VR2101BLK*†		20
GTS 1000	93-99	FA191										21
MT-10 (MTN1000/998cc)	16-20				FA380HH*	MD2124X	MD2124X	MD2124XC*		VR2124BLK*†		22
MT-10 Tourer Edition (998cc)	18-20				FA380HH*	MD2124X	MD2124X	MD2124XC*		VR2124BLK*†		23
MT-10 SP (MTN 1000D/998cc)	17-21				FA380HH*	MD2124X	MD2124X	MD2124XC*		VR2124BLK*†		24
XV 1000 TR1	81	FA034*		FA034V*		MD2019LS	MD2019RS					25
XV 1000 Virago	86	FA088*		FA088V*	FA088HH*	MD2011	MD2011	MD2011C*		VR2011*		26
XV 1000 SE Virago	88	FA088*		FA088V*	FA088HH*	MD2011	MD2011	MD2011C*		VR2011*		27
YZF 1000 R Thunderace	96-01	FA252*			FA252HH*	MD2074X	MD2074X	MD2074XC*	MD2074CC*	VR2074BLK*†		28
YZF-R1	98-01	FA252*			FA252HH*	MD2074X	MD2074X	MD2074XC*	MD2074CC*	VR2074BLK*†		29
YZF-R1	02-03	FA252*			FA252HH*	MD2074X	MD2074X	MD2074XC*	MD2074CC*	VR2074BLK*†		30
YZF-R1	04-06				FA380HH*	MD2094X	MD2094X	MD2094XC*	MD2094CC*	VR2094BLK*†		31
YZF-R1 SP (4B1)	06				FA380HH*	MD2112X	MD2112X					32
YZF-R1 (6 piston radial caliper)	07-08	FA442/4*			FA442/4HH*	MD2102X	MD2102X	MD2102XC*	MD2102CC*	VR2102BLK*†		33
YZF-R1	09-14	FA442/4*			FA442/4HH*	MD2102X	MD2102X	MD2102XC*		VR2102BLK*†		34
YZF-R1	15-20				FA380HH*	MD2124X	MD2124X	MD2124XC*		VR2124BLK*†		35
YZF-R1M	15-21				FA380HH*	MD2124X	MD2124X	MD2124XC*		VR2124BLK*†		36
YZF-R1MI Mission	20				FA390HH*	MD2124X	MD2124X	MD2124XC*		VR2124BLK*†		37
YZF-R1 (60th Anniversary Edition)	16				FA380HH*	MD2124X	MD2124X	MD2124XC*		VR2124BLK*†		38
YXP 1000 AS/AT Pro Hauler 1000 Side x Side	04-05	Y534*			Y534G*							39
YZX 1000 R EPS (Side x Side) YXZ10PXG	16	FA676TT*			FA676R*	MD6382D	MD6382D				UTVX6382*	40
YZX 1000 R EPS (Side x Side) YXZ10PXG - Parking Brake	16	FA497TT				MD6381D						41
YZX 1000 R SE (Side x Side)	16	FA676TT*			FA676R*	MD6395D	MD6395D				UTVX6395*	42
YZX 1000 R SE (Side x Side) - Parking Brake	16	FA497TT				MD6381D						43
YZX 1000 R SS (Side x Side)	17-18	FA676TT*			FA676R*	MD6395D	MD6395D				UTVX6395*	44
YZX 1000 R SS (Side x Side) - Parking Brake	17-18	FA497TT				MD6381D						45
BT 1100 P/R/S/T/V Bulldog	02-06	FA252*			FA252HH*	MD2074X	MD2074X	MD2074XC*	MD2074CC*	VR2074BLK*†		46
FJ 1100	84-85	FA088*			FA088HH*	MD2068	MD2068					47
XS 1100	78-80	FA034*				MD2024 ☼	MD2024 ☼					48
XS 1100 SG	80	FA061		FA061V		MD2024 ☼						49
		FA041		FA041V			MD2024 ☼					50
XS 1100 S	81	FA070*				MD2024 ☼	MD2024 ☼					51
XV 1100 Virago	89-93	FA088*		FA088V*	FA088HH*	MD2011	MD2011	MD2011C*		VR2011*		52
XV 1100 Virago	94-98	FA179*		FA179V*	FA179HH*	MD2067	MD2067					53
XV 1100 Virago	99	FA199*		FA199V*	FA199HH*	MD2067	MD2067					54
XVS 1100 Drag Star	99-04	FA199*		FA199V*	FA199HH*	MD2076	MD2076					55
XVS 1100 A Dragstar Classic	00-06	FA199*		FA199V*	FA199HH*	MD2076	MD2076					56
FJ 1200 (ITX Type)	86-87	FA088*			FA088HH*	MD2068	MD2068					57
FJ 1200 (3CV/3XW Type)	88-95	FA123*			FA123HH*	MD2001X	MD2001X	MD2001XC*	MD2001CC*	VR2001BLK*†		58

*-2 Sets Required. † For Vee disc colours add RED, BLU, GRN, GLD, ORG suffix to part number. For Custom Finish Options for Vee-Rotors™ including Splatter discs add suffix CHR, CHGR, CHBL, CHBR - available in various colours see page iv. ☼ - Also available as a Vintage Motorcycle Disc.

JAPANESE Built Motorcycles

Line #	BRAKE DISC CHOICES - FRONT						DISC PAD CHOICES - REAR				BRAKE DISC CHOICES - REAR			
	OverSize 250 /280mm Disc Kit	OSX OverSize 250/280mm Disc Kit	Relocating Bracket for 250/ 280mm Disc	OverSize 320mm Disc Kit	SMX OverSize 320mm Disc Kit	Relocating Bracket for 320mm Disc	FA, SFA, TT Pad or Brake Shoe	SFAC Carbon Scooter Pads	Speciality Pads - SXR / Vee / MXS	Sintered/ HH Pads/ Grooved Shoes	Standard Replacement Disc	Contour Disc Rear fitment	Vee Discs CONTOUR	CX Extreme MX Race Disc
1							FA088		FA088V	FA088HH	MD2069			
2							FA088		FA088V	FA088HH	MD2069			
3							FA088		FA088V	FA088HH	MD2011			
4							FA174		FA174V	FA174HH	MD2120	MD2120C	VR2120	
5							FA174		FA174V	FA174HH	MD2120	MD2120C	VR2120	
6							FA319/2		FA319/2V	FA319/2HH		MD2130C		
7							FA319/2		FA319/2V	FA319/2HH		MD2130C		
8							FA319/2		FA319/2V	FA319/2HH	MD2103	MD2103C	VR2103	
9							FA319/2		FA319/2V	FA319/2HH		MD2130C		
10														
11							FA319/2		FA319/2V	FA319/2HH		MD2130C		
12														
13							FA319/2		FA319/2V	FA319/2HH		MD2130C		
14							FA088		FA088V	FA088HH	MD2011	MD2011C	VR2011	
15							FA088		FA088V	FA088HH	MD2011	MD2011C	VR2011	
16							FA088		FA088V	FA088HH	MD2011	MD2011C	VR2011	
17							FA088		FA088V	FA088HH	MD2011	MD2011C	VR2011	
18							FA348		FA348V	FA348HH	MD2011	MD2011C	VR2011	
19							FA174		FA174V	FA174HH	MD2093	MD2093C	VR2093	
20							FA174		FA174V	FA174HH	MD2093	MD2093C	VR2093	
21							FA174		FA174V	FA174HH	MD2093	MD2093C	VR2093	
22							FA174		FA174V	FA174HH	MD2093	MD2093C	VR2093	
23							FA088		FA088V		MD2075			
24							FA174		FA174V	FA174HH	MD2091	MD2091C	VR2091	
25							FA174		FA174V	FA174HH	MD2091	MD2091C	VR2091	
26							FA174		FA174V	FA174HH	MD2091	MD2091C	VR2091	
27							Y515							
28							Y515							
29							Y515							
30							FA088		FA088V	FA088HH	MD2002	MD2002C	VR2002	
31							FA267			FA267HH	MD2086	MD2086C	VR2086	
32							FA275			FA275HH	MD2084	MD2084C	VR2084	
33							FA174		FA174V	FA174HH	MD2091	MD2091C	VR2091	
34							FA174			FA174HH	MD2118	MD2091C	VR2091	
35							FA174		FA174V	FA174HH	MD2091	MD2091C	VR2091	
36							FA174		FA174V	FA174HH	MD2091	MD2091C	VR2091	
37							FA436		FA436V	FA436HH	MD2125	MD2125C	VR2125	
38							FA436		FA436V	FA436HH	MD2125	MD2125C	VR2125	
39									FA436HH		MD2125C	VR2125		
40							FA436		FA436V	FA436HH	MD2125	MD2125C	VR2125	
41							Y534		Y534G					
42							FA677TT*		SXR677HH*	FA677R*	MD6395D*			UTVX6395*
43														
44							FA677TT*		SXR677HH*	FA677R*	MD6395D*			UTVX6395*
45														
46							FA677TT*		SXR677HH*	FA677R*	MD6395D*			UTVX6395*
47														
48							FA088		FA088V	FA088HH	MD2011	MD2011C	VR2011	
49							FA088		FA088V	FA088HH	MD2068			
50							FA034		FA034V		MD2024			
51							FA034		FA034V		MD2024			
52														
53							FA034		FA034V		MD2024			
54							Y515							
55							Y515							
56							FA088		FA088V	FA088HH	MD2011			
57							FA088		FA088V	FA088HH	MD2092			
58							FA088		FA088V	FA088HH	MD2092			
59							FA088		FA088V	FA088HH	MD2068			
60							FA088		FA088V	FA088HH	MD2068			

REAR / ARRIÈRE / HINTEN / POSTERIOR / POSTERIORE

R Suffix = High Durability Sintered Pad. **HH** Suffix = High Performance Sintered Pad. **TT** Suffix = Hard Wearing Off Road Pad. **V** Suffix = Semi Sintered Pad. **G** Suffix = Grooved Shoe.
D Suffix = Drilled Disc. **X** Suffix = Universal Left or Right Disc. **XC** Suffix = Contoured Disc. **LS** Suffix = Left/Steel Disc. **RS** = Right/Steel Disc.

BRAKE APPLICATIONS

*-2 Sets Required. † For Vee disc colours add RED, BLU, GRN, GLD, ORG suffix to part number. For Custom Finish Options for Vee-Rotors™ including Splatter discs add suffix CHR, CHGR, CHBL, CHBR - available in various colours see page iv. ⦿ - Also available as a Vintage Motorcycle Disc.

JAPANESE Built Motorcycles



YAMAHA Contd.



DISC PAD CHOICES - FRONT

BRAKE DISC CHOICES - FRONT

FA, SFA, TT Pad or Brake Shoe	SFAC Carbon Scooter Pads	Speciality Pads - SXR / Vee / MXS	Sintered/HH Pads/ Grooved Shoes	Left / Gauche / Links Standard Replacement Disc	Right / Droite / Rechts Standard Replacement Disc	Contour Disc Universal left and right fitment	Custom Disc Universal left and right fitment	Vee-Discs Black † See note below	CX Extreme MX Race Disc/ UTVX Disc
FJ 1200 A (ABS Model)			FA160HH*	MD2046	MD2046				
XJR 1200			FA123HH*	MD2003X	MD2003X	MD2003XC*	MD2003CC*	VR2003BLK*†	
XT 1200 Z Super Tenere (ABS/UBS Brake System)			FA380HH*			MD2095XC*	MD2095CC*	VR2095BLK*†	
XT 1200 ZE Super Tenere (ABS/UBS Brake System)			FA380HH*			MD2095XC*	MD2095CC*	VR2095BLK*†	
XT 1200 ZE Super Tenere Raid Edition (ABS/UBS Brake System)			FA380HH*			MD2095XC*	MD2095CC*	VR2095BLK*	
XVZ 12 TD	FA088*	FA088V*	FA088HH*	MD2081	MD2081				
V-Max 12	FA088*		FA088HH*	MD2068	MD2068				
V-Max 12	FA160*		FA160HH*	MD2129X	MD2129X	MD2129XC*			
FJR 1300 (Non ABS/5JW)	FA252*		FA252HH*	MD2074X	MD2074X	MD2074XC*	MD2074CC*	VR2074BLK*†	
FJR 1300 A (ABS/2 Pad Front Caliper)	FA252*		FA252HH*	MD2089X	MD2089X	MD2089XC*	MD2089CC*	VR2089BLK*†	
FJR 1300 A (ABS/4 Pad Front Caliper)			FA423/4HH*	MD2089X	MD2089X	MD2089XC*	MD2089CC*	VR2089BLK*	
FJR 1300 AE (Electronic Suspension Adjustment /USD Forks)			FA423/4HH*	MD2089X	MD2089X	MD2089XC*	MD2089CC*	VR2089BLK*	
FJR 1300 AS (ABS - Electric G/Shift)			FA423/4HH*	MD2089X	MD2089X	MD2089XC*	MD2089CC*	VR2089BLK*†	
XJR 1300 L 5EA2/5EA3/5EA4	FA252*		FA252HH*	MD2074X	MD2074X	MD2074XC*	MD2074CC*	VR2074BLK*†	
XJR 1300 M 5EAA/5EAB/5EAC	FA252*		FA252HH*	MD2074X	MD2074X	MD2074XC*	MD2074CC*	VR2074BLK*†	
XJR 1300 (5EA1/5EA7) (320mm front discs) (Brembo calipers)	FA244*		FA244HH*	MD2003X	MD2003X	MD2003XC*	MD2003CC*	VR2003BLK*†	
XJR 1300 (5EA9/5EAG) (298mm front disc)	FA252*		FA252HH*	MD2074X	MD2074X	MD2074XC*	MD2074CC*	VR2074BLK*†	
XJR 1300 C/Racer	FA252*		FA252HH*	MD2074X	MD2074X	MD2074XC*	MD2074CC*	VR2074BLK*†	
XJR 1300 N/P (5EAP/5EAR/5EAS/5EAT/5EAW/5EAV/5EAY) (298mm front discs)	FA252*		FA252HH*	MD2074X	MD2074X	MD2074XC*	MD2074CC*	VR2074BLK*†	
XJR 1300 R/S (5WM1/5WM3/5WM5 /5WM6/5WM7/5WM9)	FA252*		FA252HH*	MD2074X	MD2074X	MD2074XC*	MD2074CC*	VR2074BLK*†	
XJR 1300 T/V/W/X 5WMA/5WMC/5WMD /5WMF/Y	FA252*		FA252HH*	MD2074X	MD2074X	MD2074XC*	MD2074CC*	VR2074BLK*†	
XJR 1300 SP (L) (5EA5/5EA6/5EA8)	FA252*		FA252HH*	MD2074X	MD2074X	MD2074XC*	MD2074CC*	VR2074BLK*†	
XJR 1300 SP (M) (5EAD/5EAE/5EAF)	FA252*		FA252HH*	MD2074X	MD2074X	MD2074XC*	MD2074CC*	VR2074BLK*†	
XJR 1300 SP (N) (5EAL/5EAM/5EAN)	FA252*		FA252HH*	MD2074X	MD2074X	MD2074XC*	MD2074CC*	VR2074BLK*†	
XVS 1300 A Midnight Star	FA199*	FA199V*	FA199HH*	MD2074X	MD2074X	MD2074XC*	MD2074CC*	VR2074BLK*†	
XVS 1300 CU Custom	FA179	FA179V	FA179HH						
XVS 1300 ACFD Midnight Star/Casual Full Dresser (With Handbar Faring)	FA199*	FA199V*	FA199HH*	MD2074X	MD2074X	MD2074XC*	MD2074CC*	VR2074BLK*†	
XVZ 13 AH/ATH Royal Star/Royal Star Tour Classic	FA123*	FA123V*	FA123HH*	MD2076	MD2076				
XVZ 1300 TF Venture Star	FA179*	FA179V*	FA179HH*	MD2076	MD2076				
XV 1600 A Wildstar	FA179*	FA179V*	FA179HH*	MD2076	MD2076				
MT-01 (1670cc) (4 piston caliper)			FA380HH*	MD2126X	MD2126X	MD2126XC*		VR2126BLK*†	
MT-01 (6 piston radial caliper)	FA442/4*		FA442/4HH*	MD2128X	MD2128X	MD2128XC*		VR2128BLK*†	
MT-01 S (6 piston radial caliper/5YUR)	FA442/4*		FA442/4HH*	MD2128X	MD2128X	MD2128XC*		VR2128BLK*†	
XV 1700 PCR Road Star Warrior	FA252*		FA252HH*	MD2074X	MD2074X	MD2074XC*	MD2074CC*	VR2074BLK*†	
XV 1700 V-Max	FA442/4*		FA442/4HH*			MD2109XC*			
XV 1900 A Midnight Star	FA252*		FA252HH*	MD2074X	MD2074X	MD2074XC*	MD2074CC*	VR2074BLK*†	
XV 1900 A Midnight Star			FA423/4HH*						
XV 1900 ACFD Midnight Star/Casual Full Dresser (With Handlebar Faring)			FA423/4HH*						

FRONT / AVANT / VORN / FRENTE / ANTERIORE

Line #
1
2
3
4
5
6
7
8
9
10
11
12
13
14
15
16
17
18
19
20
21
22
23
24
25
26
27
28
29
30
31
32
33
34
35
36
37
38
39
40
41
42
43
44
45
46
47
48
49
50
51
52
53
54
55
56
57
58
59
60

R Suffix = High Durability Sintered Pad. HH Suffix = High Performance Sintered Pad. TT Suffix = Hard Wearing Off Road Pad. V Suffix = Semi Sintered Pad. G Suffix = Grooved Shoe.
D Suffix = Drilled Disc. X Suffix = Universal Left or Right Disc. XC Suffix = Contoured Disc. LS Suffix = Left/Steel Disc. RS = Right/Steel Disc.

*-2 Sets Required. † For Vee disc colours add RED, BLU, GRN, GLD, ORG suffix to part number. For Custom Finish Options for Vee-Rotors™ including Splatter discs add suffix CHR, CHGR, CHBL, CHBR - available in various colours see page iv. ☼ - Also available as a Vintage Motorcycle Disc.

JAPANESE Built Motorcycles

Line #	BRAKE DISC CHOICES - FRONT						DISC PAD CHOICES - REAR				BRAKE DISC CHOICES - REAR			
	Oversize 250 /280mm Disc Kit	OSX Oversize 250/280mm Disc Kit	Relocating Bracket for 250/ 280mm Disc	Oversize 320mm Disc Kit	SMX Oversize 320mm Disc Kit	Relocating Bracket for 320mm Disc	FA, SFA, TT Pad or Brake Shoe	SFAC Carbon Scooter Pads	Speciality Pads - SXR / Vee / MXS	Sintered/ HH Pads/ Grooved Shoes	Standard Replacement Disc	Contour Disc Rear fitment	Vee Discs CONTOUR	CX Extreme MX Race Disc
1							FA088		FA088V	FA088HH	MD2068			
2							FA088		FA088V	FA088HH	MD2011	MD2011C	VR2011	
3							FA319/2			FA319/2HH		MD2115C		
4							FA319/2			FA319/2HH		MD2115C		
5														
6							FA319/2			FA319/2HH		MD2115C		
7							FA088		FA088V	FA088HH	MD2081			
8							FA088		FA088V	FA088HH	MD2068			
9							FA088		FA088V	FA088HH	MD2068			
10							FA319/2		FA319/2V	FA319/2HH	MD2092	MD2092C	VR2092	
11							FA319/2		FA319/2V	FA319/2HH	MD2092	MD2092C	VR2092	
12							FA319/2		FA319/2V	FA319/2HH	MD2100	MD2100C	VR2100	
13														
14							FA319/2		FA319/2V	FA319/2HH	MD2100	MD2100C	VR2100	
15							FA319/2		FA319/2V	FA319/2HH	MD2100	MD2100C	VR2100	
16							FA088		FA088V	FA088HH	MD2011	MD2011C	VR2011	
17							FA088		FA088V	FA088HH	MD2011	MD2011C	VR2011	
18														
19							FA088		FA088V	FA088HH	MD2011	MD2011C	VR2011	
20							FA267			FA267HH	MD2011	MD2011C	VR2011	
21							FA348			FA348HH	MD2011	MD2011C	VR2011	
22														
23							FA348			FA348HH	MD2011	MD2011C	VR2011	
24														
25							FA348			FA348HH	MD2011	MD2011C	VR2011	
26														
27							FA348			FA348HH	MD2011	MD2011C	VR2011	
28							FA088		FA088V	FA088HH	MD2011	MD2011C	VR2011	
29							FA088		FA088V	FA088HH	MD2011	MD2011C	VR2011	
30							FA088		FA088V	FA088HH	MD2011	MD2011C	VR2011	
31							FA319/2		FA319/2V	FA319/2HH	MD2103	MD2103C	VR2103	
32							FA319/2		FA319/2V	FA319/2HH	MD2103			
33														
34							FA319/2		FA319/2V	FA319/2HH	MD2103	MD2103C	VR2103	
35							FA123		FA123V	FA123HH	MD2078			
36							FA123		FA123V	FA123HH	MD2078			
37							FA123		FA123V	FA123HH	MD2088			
38							FA196		FA196V	FA196HH	MD2011			
39							FA196		FA196V	FA196HH	MD2011			
40							FA196		FA196V	FA196HH	MD2011			
41							FA319/2		FA319/2V	FA319/2HH	MD2092	MD2092C	VR2092	
42							FA319/2		FA319/2V	FA319/2HH		MD2108C		
43							FA319/2		FA319/2V	FA319/2HH	MD2099			
44							FA319/2		FA319/2V	FA319/2HH	MD2099			
45														
46							FA319/2		FA319/2V	FA319/2HH	MD2099			
47														
48														
49														
50														
51														
52														
53														
54														
55														
56														
57														
58														
59														
60														

REAR / ARRIÈRE / HINTEN / POSTERIOR / POSTERIORE

*-2 Sets Required. † For Vee disc colours add RED, BLU, GRN, GLD, ORG suffix to part number. For Custom Finish Options for Vee-Rotors™ including Splatter discs add suffix CHR, CHGR, CHBL, CHBR - available in various colours see page iv. Ⓢ - Also available as a Vintage Motorcycle Disc.

R Suffix = High Durability Sintered Pad. **HH** Suffix = High Performance Sintered Pad. **TT** Suffix = Hard Wearing Off Road Pad. **V** Suffix = Semi Sintered Pad. **G** Suffix = Grooved Shoe.
D Suffix = Drilled Disc. **X** Suffix = Universal Left or Right Disc. **XC** Suffix = Contoured Disc. **LS** Suffix = Left/Steel Disc. **RS** = Right/Steel Disc.

BRAKE APPLICATIONS

ROAD RACING APPLICATIONS

Make & Model	Year	FRONT				REAR		
		Organic Pads	Sintered/HH Pads	Brake Rotor Left	Brake Rotor Right	Custom Chrome Rotor	Organic Pads	Brake Rotor
HONDA								
RS 125	88-89	FA124	FA124HH		N/A		FA151	MD713
RS 125	90-94	FA226	EPFA226HH		MD1003X	MD1003CC	FA151	MD713
RS 125	95-03	FA239	EPFA239HH		MD1003X	MD1003CC	FA151	MD713
RS 125 (Radial caliper)	04-07		GPFAX347HH		MD1003X	MD1003CC	FA151	MD713
NSF 250 R	12-19		GPFAX347HH		N/A		FA151	N/A
RS 250	88-89	FA124*	FA124HH*	MD1003X	MD1003X	MD1003CC	FA151	MD724
RS 250	90-94	FA226*	EPFA226HH*	MD1003X	MD1003X	MD1003CC	FA151	MD724
RS 250	95-02	FA239*	EPFA239HH*	MD1003X	MD1003X	MD1003CC	FA151	MD724
MORIWAKI								
MD 250 H	08-13		GPFAX347HH		N/A		FA151	N/A
YAMAHA								
TZ 125	94-97	FA145	EPFA145HH*		MD711RD		FA162	MD732
TZ 250	89-90	FA145*	EPFA145HH*	MD711LD	MD711RD		FA162	MD732
TZ 250	91	FA145*	EPFA145HH*	MD711LD	MD711RD		FA162	MD2021
TZ 250	92-96	FA145*	EPFA145HH*	MD711LD	MD711RD		FA162	MD732
TZ 250	97-01	FA145*	EPFA145HH*	MD730LD	MD730RD		FA162	MD732
TZ 250	97-01	FA145*	EPFA145HH*	MD2133	MD2133		FA162	MD732
TZ 250 (Radial Caliper)	02-10		GPFAX347HH*	MD730LD	MD730RD		FA162	MD732
TZ 350	80-90		GPFAX743HH*	MD-TZ350/500	MD-TZ350/500		FA162	MD732
TZ 500				MD-TZ350/500	MD-TZ350/500			

PADS FOR AFTERMARKET CALIPERS

	Standard Organic Pad	Optional Organic Pad	Semi-Sintered Pad	Fully Sintered Pad	Fully Sintered Pad Track Day /Race Pad	Fully Sintered Race Pad
AMERICAN SUSPENSION						
B17 Phantom 2 piston brake caliper	FA018		FA018V			
B17 Mach 8 Radial mount 4 Piston caliper	N/A		N/A			
B17 Mach 8 Standard mount 2 Piston caliper	FA018		FA018V			
P26 2 Piston Caliper	FA018		FA018V			
AP LOCKHEED						
2 Piston/2 Pin (CP2195/CP2696 -38E0)	FA016	FA016S		FA016HH	EPFA016HH	GPFAX016HH
2 Piston Sidecar Caliper (CP2576/2577/3176/3177/3178)						
2 Piston/1 Pin (CP4226 - 2S0)	FA272					
2 Piston/1 Pin (CP4227 - 2S0)	FA272					
6 Piston/No Pins (CP3366/67)	FA217					
6 Piston/2 Pins (CP4466)					EPFA263HH	
4 Piston (CP3086/CP3369/CP4484 D27)	FA107A					
4 Piston (CP4485/CP4679)	FA107/2A					
4 Piston Radial 2 Piece (CP4488)						
4 Piston (CP4680) 1 Piece Pad						
4 Piston Radial Mount/4 Separate Pads (CP6688 - 8E0M/9E0M)				FA435/4HH	EPFA435/4HH	
2 Piston/1 Pin (CP7003-2S0) Radial mount	FA272					
4 Piston Sidecar Caliper (CP7030-3S0/5S0)						
4 Piston Radial Monobloc 1 Piece Pad (CP7853 D27 2E0/3E0)						
BERINGER						
2 Piston Quad Caliper						
4 Piston (Old Design)	FA158			FA158HH	EPFA158HH	
4 Piston (Radial)				MXS405		
6 Piston (Old Design)	FA249			FA249HH	EPFA249HH	
6 Piston (Old design/2 piston)	FA047	FA047S		FA047HH		
6 Piston (Old Design/Endurance)	FA249/2					
6 Piston (New Design)				MXS406		
BREMBO						
20 5161 43 or 81 - 2 Piston P 2/32 Rear caliper (Single Pad Fixing Pin/With Anti Rattle Shim)	FA047	FA047S		FA047HH		
20 6950 51 - 2 Piston P2/32 Rear Caliper (Single Pad Fixing Pin/With Wire Clip)	FA266		FA266V	FA266HH		
20 6951 12/50/63 - P2/34 Rear Caliper (Single Pad Fixing Pin/With Wire Clip)	FA266		FA266V	FA266HH		
20 7850 11/21 - 4 Piston P4/34 @ 65mm Spacing (Wire clip pad retention Only)				FA322/4HH	EPFA322/4HH	
20 8343 11/21 or 35/45 - 4 Piston P4/34 @ 100mm Spacing (Wire clip pad retention Only)				FA322/4HH	EPFA322/4HH	
220B01010 - GP4-RX 4 Piston Radial Mount @ 108mm Spacing				FA447HH	EPFA447HH	GPFAX447HH
X20-60-01 - 2 Piston P2/24 Rear Caliper Rear caliper @ 64mm Spacing						
X20-61-01 - 4 Piston P4/24 Rear Caliper Rear caliper @ 64mm Spacing						
X98-88-70 - 2 Piston P2/34 Rear Caliper Rear caliper @ 64mm Spacing						
X97.37.60/61 - 4 Piston Monobloc 32/36 Radial mount @ 108mm (Single Pin Fixing)				FA218HH	EPFA218HH	GPFAX218HH
20 5165 55/68 - Goldline 4 piston P4 30/34 @ 40mm Spacing (Single Pin pad Fixing)	FA095		FA095V	FA095HH	EPFA095HH	
20 6800 10/20 - Goldline 4 piston P4 30/34 @ 65mm Spacing (Two Pin Pad Fixing)	FA244		FA244V	FA244HH	EPFA244HH	GPFAX244HH

PADS FOR AFTERMARKET CALIPERS

	Standard Organic Pad	Optional Organic Pad	Semi-Sintered Pad	Fully Sintered Pad	Fully Sintered Pad Track Day /Race Pad	Fully Sintered Race Pad
BREMBO						
20 4756 52/62 - 4 Piston P4 30/34 @ 40mm Spacing (Single pin pad fixing)	FA095		FA095V	FA095HH	EPFA095HH	
X99.C04 60/61 - 4 Piston P34/34 Radial Mount Caliper @ 108mm Spacing (4 Pad Set)					EPFA435/4HH	
XA3.B8.30/31 - 4 Piston P32/36 Radial Mount Caliper @ 108mm Spacing (Titanium Pistons)					EPFA218/2HH	GPFA218/2HH
XA3.B8.60/61 - 4 Piston P32/36 Radial Mount Caliper @ 108mm Spacing (Aluminium Pistons)					EPFA218/2HH	GPFA218/2HH
XA3.J7.50/51 - 4 Piston P34/38 Radial Mount @ 108mm Spacing (Pinless Fixing)						GPFA218/2HH
XA3.J7.60/61 - 4 Piston P34/38 Radial Mount @ 108mm Spacing (Pinless Fixing/Lithium Body)						GPFA218/2HH
XA8.Y3.310/11 - 4 Piston P34/38 Radial Mount @ 130mm Spacing (Pinless Fixing)						GPFA218/2HH
XA9.33.10/11 - 4 Piston P32/36 Radial mount Monobloc @ 108mm Spacing (Single Pin Pad Fixing)					EPFA218/2HH	GPFA218/2HH
XA07680 - 2 Piston P2 34 Radial Mount (Note Only Sold As Set Of 4 Pads)				FA435/4HH	EPFA435/4HH	
X1017.40/41 - 4 Piston/40mm Axial Monobloc Caliper					EPFA218/2HH	GPFA218/2HH
XA7G2.40/41 - 4 Piston/100mm CNC Monobloc Caliper					EPFA218/2HH	GPFA218/2HH
XA32950 P4/34 Axial Radial Mount 65mm - 4 Pad Set				FA322/4HH	EPFA322/4HH	
XA1K480 Motocross Radial Caliper						
XQ21361 P2/28 Off Road Caliper	FA181TT			FA181R	EPFA181HH	
122A99021 P2/24 Off Road Caliper	FA181TT			FA181R	EPFA181HH	
XQ21390 PF 26 Off Road Rear Caliper	FA368TT				EPFA368HH	
120A44110 P2/34 Supersport Rear Caliper	FA266		FA266V	FA266HH		
206121 P4/24 Rear Caliper						
XA1J040 P2/30 Rear Caliper				FA730HH	EPFA730HH	
GPFA730HH						
XA69510 P4 30/34 Motard Radial Mount 108mm 2 Pin Pad Fixing	FA244		FA244V	FA244HH	EPFA244HH	GPFA244HH
XA78910 P4 30/34 Motard Radial Caliper 100mm Mount 2 Pin Pad Fixing	FA244		FA244V	FA244HH	EPFA244HH	GPFA244HH
220A80310 P4 30/34 Radial Mount 100mm 2 Pin Pad Fixing	FA244		FA244V	FA244HH	EPFA244HH	GPFA244HH
220A16820 P30/34 Yamaha R1 07-10 Radial Mount	FA244		FA244V	FA244HH	EPFA244HH	GPFA244HH
XA7G2 10/11 P4 32/36 Radial Mount Caliper 100mm					EPFA218/2HH	GPFA218/2HH
X97C4 60/61 P4/34 Radial Monobloc 108mm 4 Pad Type Caliper				FA435/4HH	EPFA435/4HH	
X9737 80/81 Radial Mount 108mm Endurance Caliper					EPFA295HH	
220A39710 P4/34 Radial Mount 108mm Monobloc Caliper				FA447HH	EPFA447HH	GPFA447HH
220988530 P4/34 Radial Mount 100mm Monobloc Caliper				FA447HH	EPFA447HH	GPFA447HH
220A0610 P4 30/34 Radial Mount Caliper 108mm 2 Pin Pad Fixing	FA244		FA244V	FA244HH	EPFA244HH	GPFA244HH
220A80210 P4 30/34 Radial Mount Caliper 108mm 2 Pin Pad Fixing	FA244		FA244V	FA244HH	EPFA244HH	GPFA244HH
220A16810 P4 30/34 Radial Mount Caliper 100mm 2 Pin Pad Fixing	FA244		FA244V	FA244HH	EPFA244HH	GPFA244HH
20.9883 Radial Mount Caliper 100mm				FA447HH	EPFA447HH	GPFA447HH
XB2P710/XB2P711 Endurance Caliper						
XB0B1 30/31 P4 30/34						GPFA673HH
EBC						
4 Piston	FA216/2				FA216/2HH	
FTE						
4 Piston Radial Supermoto					MXS405	
6 Piston Radial Supermoto					MXS406	
GMA						
2 Piston rear (large) caliper model A (CCI #09-997)	FA036		FA036V			
2 Piston (small) caliper model B (CCI # 09-996)	FA076		FA076V	FA076HH		
4 Piston model F	FA115		FA115V	FA115HH		
HARRISON BILLET						
Big 4 Piston (1296033)	FA047	FA047S		FA047HH		
Big 6 Piston (1296033)	FA047	FA047S		FA047HH		
2 Piston (1296040)	FA175			FA175HH	EPFA175HH	
Slim Design	FA175			FA175HH	EPFA175HH	
Mini 6	FA175			FA175HH	EPFA175HH	
HHI - HAWG HALTERS						
4 Piston - All Types	FA216/3		FA216/3V	FA216/3HH		
4 Piston - Sprocket Brake	FA623			FA623HH		
6 Piston - All Types	FA424			FA424HH		
IRON PEGASUS						
Small caliper (Single Pin Fixing)	FA047	FA047S		FA047HH		
Small caliper (2 Pin Fixing)	FA115		FA115V	FA115HH		
ISR						
22-023-0A (2 Piston)	FA011					
22-025-XX (4 Piston)	FA047	FA047S		FA047HH		
22-026-0A (Sprocket Caliper)	FA011					
22-027 (2 Piston Rear)	FA047	FA047S		FA047HH		
22-028 (2 Piston)	FA047	FA047S		FA047HH		
22-029 (Rear 2 Piston)	FA047	FA047S		FA047HH		
22-030 (2 Piston Rear)	FA016	FA016S		FA016HH	EPFA016HH	GPFA016HH
22-032 (6 Piston Large)	FA175			FA175HH		

PADS FOR AFTERMARKET CALIPERS

	Standard Organic Pad	Optional Organic Pad	Semi-Sintered Pad	Fully Sintered Pad	Fully Sintered Pad Track Day /Race Pad	Fully Sintered Race Pad
ISR						
22-033 (2 Piston HD)	FA016	FA016S		FA016HH	EPFA016HH	GPFA016HH
22-034 (6 Piston Small)	FA184					GPFA184HH
22-036 (2 Piston)	FA184					GPFA184HH
R22-042 (6 Piston Racing)	FA175			FA175HH	EPFA175HH	
22-043 (4 Piston)	FA184					GPFA184HH
adial 6 Piston Monoblock	FA184					GPFA184HH
JAYBRAKE						
Dual 7 Quad (300-04) (2 & 4 Piston)	FA115		FA115V	FA115HH		
J-Four (300-44) (4 Piston)	FA188			FA188HH	EPFA188HH	
J-Six (300-64) (6 Piston)	FA243			FA243HH		
6 PF-L (6 Piston/ 13" Disc - Full Height Friction)	N/A			FA455HH		
6 PF-L (6 Piston/ 11.5" Disc - Lower Height Friction)	N/A			FA649HH		
Early Design 2 Piston	FA076		FA076V	FA076HH		
MAGURA						
4 Piston	FA158			FA158HH	EPFA158HH	
MOTOMASTER						
4 Piston	FA158	N/A	N/A	FA158HH	EPFA158HH	N/A
NOVA/LEGENDS						
4 Piston	FA216/3		FA216/3V	FA216/3HH		
OMP						
4 Piston Caliper (Front or Rear)	FA095		FA095V	FA095HH	EPFA095HH	
6 Piston	FA116					
Sprocket caliper	FA116					
PERFORMANCE MACHINE						
112 X 6B	FA249			FA249HH	EPFA249HH	
112 X 6QC	FA249			FA249HH	EPFA249HH	
112 X 6RSB	FA190		FA190V	FA190HH	EPFA190HH	
112 X 6SSB	FA190		FA190V	FA190HH	EPFA190HH	
124 X 4HR	FA216/2			FA216/2HH		
125 X 2	FA115		FA115V	FA115HH		
125 X 4R	FA216/3		FA216/3V	FA216/3HH		
125 X 4RSPH	FA216/3		FA216/3V	FA216/3HH		
125 X 4S	FA115		FA115V	FA115HH		
125 X 4SL	FA115		FA115V	FA115HH		
125 X 6	FA210		FA210V			
125 X 6QC	FA190		FA190V	FA190HH	EPFA190HH	
137 X 4	FA216/2			FA216/2HH		
137 X 4 (2006)				FA420HH		
137 X 4B	FA216/3		FA216/3V	FA216/3HH		
137 X 6	FA210		FA210V			
162 X 2	FA032		FA032V			
PFM						
6 Piston Superbike caliper					EPFA263HH	
PRE TECH						
4 Piston (Uni P401)	FA180			FA180HH		
4 Piston (P402) Lockheed Replacement Caliper	FA158			FA158HH	EPFA158HH	
6 Piston	FA190		FA190V	FA190HH	EPFA190HH	
6 Piston (Radial Mount)	FA249			FA249HH	EPFA249HH	
PRO-ONE						
2 Piston	FA047	FA047S		FA047HH		
4 Piston	FA158			FA158HH	EPFA158HH	
P.V.M.						
2 Piston Rear Caliper (Note Only 2 Pads Required)				FA435/4HH	EPFA435/4HH	
4 Piston Radial Mount Caliper				FA435/4HH	EPFA435/4HH	
4 Piston Race Caliper (Old Design)	FA211/2	FA211				
6 Piston (old large design)						GFA183HH
6 Piston (new small design)						
REVTECH						
CCI Polished Caliper (Front/Rear)	FA095		FA095V	FA095HH	EPFA095HH	
New Black 4 Piston Caliper	FA216/3		FA216/3V	FA216/3HH		
6 Piston VR1000 Race Caliper	FA217					

PADS FOR AFTERMARKET CALIPERS

	Standard Organic Pad	Optional Organic Pad	Semi-Sintered Pad	Fully Sintered Pad	Fully Sintered Pad Track Day /Race Pad	Fully Sintered Race Pad
SPONDON						
4 Piston Caliper	FA107A					
4 Piston Caliper	FA107/2A					
SPIEGLER						
4 Piston Caliper S4B						
8 Piston Caliper S8B						
THUNDERHEART						
4 Piston Caliper	FA216/3		FA216/3V	FA216/3HH		
6 Piston Caliper	FA249			FA249HH		
WILWOOD						
PS1 Caliper (Part # 150-4091K)	FA271TT			FA271R		
GP300/310 (Part # 150-8733-2)	FA095		FA095V	FA095HH	EPFA095HH	
GP320 (Part # 154-8596K)	N/A					

NOTES

Non-JAPANESE Built Motorcycles



ACCOSSATO



50 Cross Mini	82-
50/80 Cross/Enduro	83-
C 50 Cross/Enduro/Competition	84-
CE 80/125 Cross/Enduro H 20	84-
CE 50/80/KR 80	87-
Enduro Codice 50	89-

ADIVA SCOOTERS

AD 125	09-11
AD1 125/150 (3 Wheel Type)	14-15
AD 200	09-11
AD 400	09-11
AD2 300 (2 Wheel Type)	14-15
AD3 300 (3 Wheel Type)	14-15
AR 125	10-11
AR 200	10-11

ADLY

AT 50 Air Tech 1	08-09
50 RS Supersonic	06-08
Jet 50/100 (X-1)	
City Bird	
Predator 50/100	
Fox 50	
NB 50 Noble 50	08-10
P50 Panther 50	02-09
Cosy 50/80	02-06
RT 50/100	
Road Tracer 50/90/100	04-06
SF 50 Silver Fox 50	06-09
SS 50 Supersonic	04-05
TB 50 Thunderbike	08-09
SS 100 Supersonic	04-05
Herchee Cat 125	98-02
Herchee Herkules 125 Mirage/Virtuality	11-12
Thunderbike 125 (Rear Drum Model)	
Thunderbike 125 (Rear Disc Model)	
GK 125 Buggy	03-07
NB 125 B Noble 125 (Rear Drum Model)	08-09
NB 125 D Noble 125 (Rear Disc Model)	08-10
SS 125 B/D Supersonic	04-05
150 Crusader Quad	06
150 Interceptor	06
Crossroad 150 Quad	07-09
Sport 150 Quad	08-09
Crossroad 220 Sentinel Quad	
Hurricane 280 Quad	08-09
Canyon 280 Quad	08-09
Canyon 320 Quad	08-09
Crossroad 300 Sentinel Quad	08-09
Hurricane 300 Quad	08-09
Interceptor 300	05-07
Interceptor 300 Quad	
300 Crusader Quad	05-07
300 RS Quad	07-08
300 XS Quad	07-08
Utility 300	05-07
320 S Quad	08
Hurricane 320 Quad	08-09
500 S	08

FRONT / AVANT / VORN / FRENTE / ANTERIORE

DISC PAD CHOICES - FRONT				BRAKE DISC CHOICES - FRONT							Line #
FA, SFA, TT Pad or Brake Shoe	SFAC Carbon Scooter Pads	Speciality Pads - SXR / Vee / MXS	Sintered/HH Pads/ Grooved Shoes	Left / Gauche / Links Standard Replacement Disc	Right / Droite / Rechts Standard Replacement Disc	Contour Disc Universal left and right filament	Universal Custom Disc	Vee-Discs Black † See note below	CX Extreme MX Race Disc/ UTVX Disc	Line #	
			926G							1	
			841G							2	
			841G							3	
			940G							4	
FA047			FA047R	N/A						5	
FA047			FA047R	N/A						6	
										7	
										8	
SFA264	SFAC264		SFA264HH	N/A						9	
SFA260*	SFAC260*		SFA260HH*	N/A	N/A					10	
SFA264	SFAC264		SFA264HH	N/A						11	
SFA266*	SFAC266*		SFA266HH*	N/A	N/A					12	
SFA266*	SFAC266*		SFA266HH*	N/A	N/A					13	
SFA260*	SFAC260*		SFA260HH*	N/A	N/A					14	
SFA264	SFAC264		SFA264HH	N/A						15	
SFA264	SFAC264		SFA264HH	N/A						16	
										17	
										18	
SFA083	SFAC083		SFA083HH	TBA						19	
SFA083*	SFAC083*		SFA083HH*	N/A	N/A					20	
SFA083	SFAC083		SFA083HH	MD904D				VR904		21	
SFA169	SFAC169		SFA169HH	TBA						22	
SFA083*	SFAC083*		SFA083HH*	MD923D	MD923D			VR923*		23	
SFA169	SFAC169		SFA169HH	MD904D				VR904		24	
SFA083	SFAC083		SFA083HH	N/A						25	
SFA083	SFAC083		SFA083HH	TBA						26	
SFA083	SFAC083		SFA083HH	TBA						27	
SFA083	SFAC083		SFA083HH	TBA						28	
SFA169	SFAC169		SFA169HH	MD904D				VR904		29	
SFA083	SFAC083		SFA083HH	N/A						30	
SFA083	SFAC083		SFA083HH	MD923D				VR923		31	
SFA083	SFAC083		SFA083HH	N/A						32	
SFA083	SFAC083		SFA083HH	MD923D				VR923		33	
SFAC083			SFA083HH	MD9181						34	
SFAC083			SFA083HH	MD9181						35	
SFA083	SFAC083		SFA083HH	MD923D				VR923		36	
SFA083	SFAC083		SFA083HH	MD923D				VR923		37	
H346*			H346G*							38	
SFA083	SFAC083		SFA083HH	N/A						39	
SFA083	SFAC083		SFA083HH	N/A						40	
SFA083	SFAC083		SFA083HH	MD923D				VR923		41	
FA083TT*			FA083R*	N/A	N/A					42	
FA083TT*			FA083R*	N/A	N/A					43	
FA083TT*			FA083R*	N/A	N/A					44	
FA083TT*			FA083R*	N/A	N/A					45	
FA377TT*			FA377R*	N/A	N/A					46	
FA377TT*			FA377R*	N/A	N/A					47	
FA377TT*			FA377R*	N/A	N/A					48	
FA377TT*			FA377R*	N/A	N/A					49	
FA377TT*			FA377R*	N/A	N/A					50	
FA377TT*			FA377R*	N/A	N/A					51	
FA083TT*			FA083R*	N/A	N/A					52	
FA416TT*			FA416R*	N/A	N/A					53	
FA083TT*			FA083R*	N/A	N/A					54	
FA377TT*			FA377R*	TBA	TBA					55	
FA377TT*			FA377R*	TBA	TBA					56	
FA377TT*			FA377R*	N/A	N/A					57	
FA377TT*			FA377R*	TBA	TBA					58	
FA377TT*			FA377R*	N/A	N/A					59	
FA377TT*			FA377R*	N/A	N/A					60	

*-2 Sets Required. † For Vee disc colours add RED, BLU, GRN, GLD, ORG suffix to part number.

⊗ - Also available as a Vintage Motorcycle Disc.

Non-JAPANESE Built Motorcycles

Line #	BRAKE DISC CHOICES - FRONT						DISC PAD CHOICES - REAR				BRAKE DISC CHOICES - REAR			
	Oversize 250 /280mm Disc Kit	OSX Oversize 250/280mm Disc Kit	Relocating Bracket for 250/ 280mm Disc	Oversize 320mm Disc Kit	SMX Oversize 320mm Disc Kit	Relocating Bracket for 320mm Disc	FA, SFA, TT Pad or Brake Shoe	SFAC Carbon Scooter Pads	Speciality Pads - SXR / Vee / MXS	Sintered/ HH Pads/ Grooved Shoes	Standard Replacement Disc	Contour Disc Rear fitment	Vee-Discs™ CONTOUR	CX Extreme MX Race Disc/ UTVX Disc
1									926G					
2									841G					
3									841G					
4									841G					
5							FA116			N/A				
6							FA116			N/A				
7														
8														
9							SFA199	SFAC199		SFA199HH	N/A			
10							SFA260	SFAC260		SFA260HH	N/A			
11							SFA199	SFAC199		SFA199HH	N/A			
12							SFA266	SFAC266		SFA266HH	N/A			
13							SFA427	SFAC427		SFA427HH	N/A			
14							SFA427	SFAC427		SFA427HH	N/A			
15							SFA199	SFAC199		SFA199HH	N/A			
16							SFA199	SFAC199		SFA199HH	N/A			
17														
18														
19							TBA							
20							SFA083	SFAC083		SFA083HH	N/A			
21							Y503							
22							Y503							
23							Y503							
24							Y503							
25							TBA							
26							Y503							
27							Y503							
28							897							
29							Y503							
30							Y503							
31							Y503							
32							TBA							
33							Y503							
34							Y503							
35							Y503							
36														
37							SFA083	SFAC083		SFA083HH	MD982D			
38							FA083TT			FA083R	MD6354D			
39							TBA							
40							SFA083	SFAC083		SFA083HH	N/A			
41							SFA083	SFAC083		SFA083HH	MD982D			
42							FA083TT			FA083R	N/A			
43							FA083TT			FA083R	N/A			
44							FA083TT			FA083R	N/A			
45							FA083TT			FA083R	N/A			
46							FA431TT			FA431R	N/A			
47							FA431TT			FA431R	N/A			
48							FA431TT			FA431R	N/A			
49							FA431TT			FA431R	N/A			
50							FA431TT			FA431R	N/A			
51							FA431TT			FA431R	N/A			
52							FA083TT			FA083R	N/A			
53							FA431TT			FA431R	N/A			
54							FA083TT			FA083R	N/A			
55							FA431TT			FA431R	TBA			
56							FA431TT			FA431R	TBA			
57							FA431TT			FA431R	N/A			
58							FA431TT			FA431R	TBA			
59							FA431TT			FA431R	N/A			
60							FA431TT			FA431R	N/A			

REAR / ARRIÈRE / HINTEN / POSTERIOR / POSTERIORE

R Suffix = High Durability Sintered Pad. **HH** Suffix = High Performance Sintered Pad. **TT** Suffix = Hard Wearing Off Road Pad. **V** Suffix = Semi Sintered Pad. **G** Suffix = Grooved Shoe.
D Suffix = Drilled Disc. **X** Suffix = Universal Left or Right Disc. **XC** Suffix = Contoured Disc. **LS** Suffix = Left/Steel Disc. **RS** = Right/Steel Disc.

*-2 Sets Required. † For Vee disc colours add RED, BLU, GRN, GLD, ORG suffix to part number.
 ☉ - Also available as a Vintage Motorcycle Disc.

Part numbers, prefixes, suffixes, photos and illustrations shown in this catalogue are trademarks and/or copyrights of EBC Brakes or the trademark owner A C Freeman Investments Ltd and use without express written permission of the owners is punishable by law.

Non-JAPANESE Built Motorcycles



AEON



DISC PAD CHOICES - FRONT

BRAKE DISC CHOICES - FRONT

R Suffix = High Durability Sintered Pad. **HH** Suffix = High Performance Sintered Pad. **TT** Suffix = Hard Wearing Off Road Pad. **V** Suffix = Semi Sintered Pad. **G** Suffix = Grooved Shoe.

D Suffix = Drilled Disc. **X** Suffix = Universal Left or Right Disc. **XC** Suffix = Contoured Disc. **LS** Suffix = Left/Steel Disc. **RS** = Right/Steel Disc.

FRONT / AVANT / VORN / FRENTE / ANTERIORE

		FA, SFA, TT Pad or Brake Shoe	SFAC Carbon Scooter Pads	Speciality Pads - SXR / Vee / MXS	Sintered/HH Pads/ Grooved Shoes	Left / Gauche / Links Standard Replacement Disc	Right / Droite / Rechts Standard Replacement Disc	Contour Disc Universal left and right fitment	Universal Custom Disc	Vee-Discs Black † See note below	CX Extreme MX Race Disc/ UTVX Disc	Line #
Aero 50/100 (Scooter)	06	SFA083	SFAC083		SFA083HH	N/A						1
Cobra 50	06-15	TBA*										2
CO-IN ECO (Electric)	13	SFA384						N/A				3
Echo 50 (Scooter)	04-06	SFA083	SFAC083			N/A						4
Minikolt 50 (AT06 Type) (Quad)	03-15	H346*										5
Nox 50/100/125/150 Scooter	06	SFA083	SFAC083		SFA083HH	N/A						6
Regal 50/90 (Scooter)	06	SFA083	SFAC083		SFA083HH	N/A						7
Revo R50 Cobra 2 (AT34 Type) (Quad)	04-06	TBA*										8
Cobra 60 (AT30 Type) (Quad)	04-11	H346*			H346G*							9
Cobra 100 (AT30 Type) (Quad)	04-06	H346*										10
Pulsar 100/125/150 (Scooter)	06	SFA083	SFAC083		SFA083HH	N/A						11
Revo R100 Cobra 2 (AT34 Type) (Quad)	04-11	TBA*										12
CO-IN 125 (4T)	13	SFA384						N/A				13
Elite 125 (4T)	12-13	SFA228	SFAC228		SFA228HH	N/A						14
MY 125	12-13	FA228			FA228HH	N/A						15
Urban 125 (Scooter)	11	SFA228			SFA228HH	N/A						16
Urban 125 (4T)	12-13	SFA228	SFAC228		SFA228HH	N/A						17
Overland 125 (AT08) (Quad)	02-06	TBA										18
OZ 125 (4T)	13	SFA384				N/A						19
Sporty 125 (AT05 Type) (Quad)	01-05	TBA*										20
OZ 150 (4T)	13	SFA384				N/A						21
Cobra RS 180 (Quad)	06	TBA*										22
Overland 180 (AT08) (Quad)	02-11	TBA*										23
Sporty 180 (AT05 Type) (Quad)	04-05	TBA*										24
Elite 200 i (Scooter)	11	SFA228			SFA228HH	N/A						25
200 Two Hundred Quad	06	FA083TT*			FA083R*	N/A	N/A					26
Cobra 220 (Quad)	06-11	FA083TT*			FA083R*	MD6274D	MD6274D					27
Cobra S 300	12-15	FA083TT*			FA083R*	N/A	N/A					28
Cube 300 - Side x Side	11	FA083TT*			FA083R*	N/A	N/A					29
Overland 300 (Quad) (AT20)	06-07	FA083TT*			FA083R*	MD6274D	MD6274D					30
Cobra 350 (Quad)	10-11	FA083TT*			FA083R*	MD6274D	MD6274D					31
Cube 350 - Side x Side	13-15	FA083TT*			FA083R*	N/A	N/A					32
Elite 350i (4T)	12-13	SFA228	SFAC228		SFA228HH	N/A						33
Urban 350i (4T)	12-13	SFA228	SFAC228		SFA228HH	N/A						34
Crossland RX 350	11	FA083TT*			FA083R*	TBA	TBA					35
Crossland X4 350	11	FA083TT*			FA083R*	TBA	TBA					36
Urban 350 i (Scooter)	11	SFA228	SFAC228		SFA228HH	N/A						37
Cobra 400 (Quad)	10-15	FA083TT*			FA083R*	MD6274D	MD6274D					38
Cobra 400 Supermoto Quad	13-15	FA083TT*			FA083R*	N/A	N/A					39
Crossland 400 (2 x 4)	12-15	FA083TT*			FA083R*	N/A	N/A					40
Crossland 400 (2 x 4) - Parking brake	12-15	FA083TT										41
Crossland 400 (4 x 4)	12-15	FA083TT*			FA083R*	N/A	N/A					42
Crossland 400 (4 x 4) - Parking brake	12-15	FA083TT										43
Elite 400i (ABS)	14-15	SFA627			SFA627HH	N/A						44
Overland 600 (Quad)	11	FA377TT*			FA377R*	N/A	N/A					45
Crossland 600i	14-15	FA083TT*			FA083R*	N/A	N/A					46
												47
												48
AGRALE												49
Elefantre 30		FA047			FA047R	N/A						50
												51
AJP												52
PR3 125 Enduro	08-12	FA167			FA194HH							53
PR3 125 Enduro	13-15	FA465TT		MXS465	FA465R	MD6400D						54
PR3 125 Enduro Pro	08-12	FA167			FA194HH							55
PR3 125 Enduro Pro	13-15	FA465TT		MXS465	FA465R	MD6400D						56
PR3 125 Extreme	13-15	FA465TT		MXS465	FA465R	MD6400D						57
PR3 125 Supermoto	08-12	FA167			FA194HH							58
PR3 125 Supermoto	13-15	FA465TT		MXS465	FA465R	MD6400D						59
PR3 125 Supermoto Pro	10-11	FA194			FA194HH							60
PR3 125 Trial	11-12	FA194			FA194HH							61

*-2 Sets Required. † For Vee disc colours add RED, BLU, GRN, GLD, ORG suffix to part number.

⊗ - Also available as a Vintage Motorcycle Disc.

Non-JAPANESE Built Motorcycles

Line #	BRAKE DISC CHOICES - FRONT						DISC PAD CHOICES - REAR				BRAKE DISC CHOICES - REAR			
	Oversize 250 /280mm Disc Kit	OSX Oversize 250/280mm Disc Kit	Relocating Bracket for 250/ 280mm Disc	Oversize 320mm Disc Kit	SMX Oversize 320mm Disc Kit	Relocating Bracket for 320mm Disc	FA, SFA, TT Pad or Brake Shoe	SFAC Carbon Scooter Pads	Speciality Pads - SXR / Vee / MXS	Sintered/ HH Pads/ Grooved Shoes	Standard Replacement Disc	Contour Disc Rear fitment	Vee-Discs™ CONTOUR	CX Extreme MX Race Disc/ UTVX Disc
1							TBA							
2							FA083TT							
3							H303							
4							TBA							
5							FA083TT		FA083R					
6							TBA							
7							TBA							
8							FA083TT		FA083R	N/A				
9							FA083TT		FA083R	N/A				
10							FA083TT		FA083R					
11							TBA							
12							FA083TT		FA083R	N/A				
13							H303							
14							SFA067	SFAC067	SFA067HH	N/A				
15							FA067		FA067HH	N/A				
16							SFA083		SFA083HH	N/A				
17							SFA067	SFAC067	SFA067HH	N/A				
18							FA165TT		FA165R	N/A				
19							H303							
20							FA083TT		FA083R	N/A				
21							H303							
22							FA165TT		FA165R	N/A				
23							FA165TT		FA165R	N/A				
24							FA083TT		FA083R	N/A				
25							SFA083		SFA083HH	N/A				
26							FA083TT		FA083R	N/A				
27							FA067TT		FA067R	N/A				
28							FA067TT		FA067R	N/A				
29							FA067TT		FA067R	N/A				
30							FA067TT		FA067R	N/A				
31							FA067TT		FA067R	TBA				
32							FA067TT		FA067R	N/A				
33							SFA067	SFAC067	SFA067HH	N/A				
34							SFA067	SFAC067	SFA067HH	N/A				
35							FA165TT		FA165R	TBA				
36							FA165TT		FA165R	TBA				
37							SFA083	SFAC083	SFA083HH	N/A				
38							FA067TT		FA067R	TBA				
39							FA067TT		FA067R	N/A				
40							FA135TT		FA135R	N/A				
41														
42							FA135TT		FA135R	N/A				
43														
44							SFA197	SFAC197	SFA197HH	N/A				
45							FA067TT		FA067R	N/A				
46							FA159TT*		FA159R*	N/A*				
47														
48														
49							845							
50														
51														
52							FA303TT			N/A				
53							FA634TT			MD6401D				
54							FA303TT			N/A				
55							FA634TT			MD6401D				
56							FA634TT			MD6401D				
57							FA303TT			N/A				
58							FA634TT			MD6401D				
59							FA303TT			N/A				
60							FA303TT			N/A				

REAR / ARRIÈRE / HINTEN / POSTERIOR / POSTERIORE

R Suffix = High Durability Sintered Pad. **HH** Suffix = High Performance Sintered Pad. **TT** Suffix = Hard Wearing Off Road Pad. **V** Suffix = Semi Sintered Pad. **G** Suffix = Grooved Shoe.
D Suffix = Drilled Disc. **X** Suffix = Universal Left or Right Disc. **XC** Suffix = Contoured Disc. **LS** Suffix = Left/Steel Disc. **RS** = Right/Steel Disc.

*-2 Sets Required. † For Vee disc colours add RED, BLU, GRN, GLD, ORG suffix to part number.
 Ⓢ - Also available as a Vintage Motorcycle Disc.

Part numbers, prefixes, suffixes, photos and illustrations shown in this catalogue are trademarks and/or copyrights of EBC Brakes or the trademark owner A C Freeman Investments Ltd and use without express written permission of the owners is punishable by law.

Non-JAPANESE Built Motorcycles



AJP Contd.



DISC PAD CHOICES - FRONT

BRAKE DISC CHOICES - FRONT

R Suffix = High Durability Sintered Pad. **HH** Suffix = High Performance Sintered Pad. **TT** Suffix = Hard Wearing Off Road Pad. **V** Suffix = Semi Sintered Pad. **G** Suffix = Grooved Shoe.

D Suffix = Drilled Disc. **X** Suffix = Universal Left or Right Disc. **XC** Suffix = Contoured Disc. **LS** Suffix = Left/Steel Disc. **RS** = Right/Steel Disc.

FRONT / AVANT / VORN / FRENTE / ANTERIORE

		FA, SFA, TT Pad or Brake Shoe	SFAC Carbon Scooter Pads	Speciality Pads - SXR / Vee / MXS	Sintered/HH Pads/ Grooved Shoes	Left / Gauche / Links Standard Replacement Disc	Right / Droite / Rechts Standard Replacement Disc	Contour Disc Universal left and right filament	Universal Custom Disc	Vee-Discs Black † See note below	CX Extreme MX Race Disc/ UTVX Disc	Line #
PR4 125 Trail	13-15	FA465TT		MXS465	FA465R							1
PR4 125 Enduro	04-09	FA167			FA167HH							2
PR4 125 Enduro	10-12	FA194			FA194HH							3
PR4 125 Enduro	13-15	FA465TT		MXS465	FA465R							4
PR4 125 Enduro Pro	10-12	FA194			FA194HH							5
PR4 125 Enduro Pro	13-15	FA465TT		MXS465	FA465R							6
PR4 125 Supermoto	04-09	FA167			FA167HH							7
PR4 125 Supermoto	10-12	FA194			FA194HH							8
PR4 125 Supermoto	13-15	FA465TT		MXS465	FA465R							9
PR4 125 Supermoto Pro	10-11	FA194			FA194HH							10
PR3 200 Enduro	08-11	FA167			FA194HH							11
PR3 200 Enduro	12-14	FA194			FA194HH							12
PR3 200 Enduro Pro	10-11	FA194			FA194HH							13
PR3 200 Enduro Pro	12-14	FA194			FA194HH							14
PR3 200 M/X	10-11	FA194			FA194HH							15
PR3 200 M/X Pro	10-11	FA194			FA194HH							16
PR3 200 M/X Pro	12-14	FA194			FA194HH							17
PR3 240 MX Pro	13-15	FA465TT		MXS465	FA465R							18
PR3 200 Supermoto	08-11	FA194			FA194HH							19
PR3 200 Supermoto	12-14	FA194			FA194HH							20
PR3 200 Supermotard Pro	10-11	FA194			FA194HH							21
PR4 200 Enduro	04-09	FA167			FA167HH							22
PR4 200 Enduro	10-11	FA194			FA194HH							23
PR4 200 Enduro	12-14	FA194			FA194HH	MD6400D						24
PR4 Enduro Pro 200	10-11	FA194			FA194HH							25
PR4 200 Enduro Pro	12-14	FA194			FA194HH	MD6400D						26
PR4 200 Extreme	12-14	FA194			FA194HH							27
PR4 200 Supermoto	04-09	FA167			FA167HH							28
PR4 200 Supermoto	10-11	FA194			FA194HH							29
PR4 200 Supermoto	12-14	FA194			FA194HH	MD6400D						30
PR4 200 Supermoto Pro	10-11	FA194			FA194HH							31
PR4 240 Extreme	13-15	FA465TT		MXS465	FA465R							32
PR5 250 Enduro	09	FA185TT		MXS185	FA185R							33
PR5 250 Enduro	10-15	FA465TT		MXS465	FA465R							34
PR5 250 Extreme	12-15	FA185TT		MXS185	FA185R			MD6404C				35
PR5 250 Supermoto	09	FA185TT		MXS185	FA185R							36
PR5 250 Supermoto	10-15	FA465TT		MXS465	FA465R							37
PR7 650 Adventure	19-21	FA465TT			FA465R							38
PR7 650 Adventure	19-20	FA209/2			FA209/2HH							39
												40
												41
AJS												42
Crazy 50 Naked	13-14	SFA264	SFAC264		SFA264HH			N/A				43
Digita 50	13-15	SFA235	SFAC235				N/A					44
Exactly 50 Scooter	08-11	SFA235	SFAC235					N/A				45
Firefox 50	13-15	SFA235	SFAC235				N/A					46
Regal Raptor DD 50 E	04-06	SFA054	SFAC054		FA054HH							47
JSM 50 Motard	13-15	FA086			FA086HH			N/A				48
Modena 50 (4T)	14-15	TBA				N/A						49
Regal Raptor DD 100 E	04-06	TBA										50
Bobber 125 (Custom)	10-15	FA086*			FA086HH*			N/A*				51
Cadwell 125	19	FA722										52
Cadwell Clubman 125	19	FA722										53
Daytona 125 E	10	FA086			FA086HH			N/A				54
125 Daytona	13-15	FA086*			FA086HH*			N/A*				55
EOS 125-Regal Raptor	09-15	FA086*			FA086HH*			N/A*				56
Exactly 125 Scooter (4T)	08-15	SFA235	SFAC235					N/A				57
JS 125-6C Custom	12-15	SFA086			FA086HH		N/A					58
JS 125-E (ECO 125)	07-09	SFA054	SFAC054		FA054HH		N/A					59
JS 125-E (ECO-2 125)	09-15	SFA054	SFAC054		FA054HH		N/A					60
JSM 125 Motard	10-15	FA086			FA086HH			N/A				60

*-2 Sets Required. † For Vee disc colours add RED, BLU, GRN, GLD, ORG suffix to part number.

⊗ - Also available as a Vintage Motorcycle Disc.

Non-JAPANESE Built Motorcycles

Line #	BRAKE DISC CHOICES - FRONT						DISC PAD CHOICES - REAR				BRAKE DISC CHOICES - REAR			
	Oversize 250 /280mm Disc Kit	OSX Oversize 250/280mm Disc Kit	Relocating Bracket for 250/ 280mm Disc	Oversize 320mm Disc Kit	SMX Oversize 320mm Disc Kit	Relocating Bracket for 320mm Disc	FA, SFA, TT Pad or Brake Shoe	SFAC Carbon Scooter Pads	Speciality Pads - SXR / Vee / MXS	Sintered/ HH Pads/ Grooved Shoes	Standard Replacement Disc	Contour Disc Rear fitment	Vee-Discs™ CONTOUR	CX Extreme MX Race Disc/ UTVX Disc
1							FA634TT							
2							FA303TT							
3							FA093							
4							FA634TT							
5							FA093							
6							FA634TT							
7							FA303TT							
8							FA093							
9							FA634TT							
10							FA093							
11							FA634TT							
12							FA303TT							
13							FA303TT							
14							FA634TT							
15							FA303TT							
16							FA303TT							
17							FA634TT							
18							FA634TT							
19							FA303TT							
20							FA634TT							
21							FA303TT							
22							FA303TT							
23							FA093							
24							FA634TT			MD6401D				
25							FA093							
26							FA634TT			MD6401D				
27							FA634TT							
28							FA303TT							
29							FA093							
30							FA634TT			MD6401D				
31							FA093							
32							FA634TT							
33							FA131TT		MXS131	FA131R				
34							FA131TT		MXS131	FA131R		MD6403C		
35							FA131TT		MXS131	FA131R		MD6405C		
36							FA131TT		MXS131	FA131R				
37							FA634TT				N/A			
38							FA208TT			FA208R				
39							FA208TT			FA208R				
40														
41														
42							FA453TT				N/A			
43							TBA							
44							TBA							
45							TBA							
46							TBA							
47							FA054TT			FA054HH		N/A		
48							TBA							
49							TBA							
50							FA197			FA197HH		N/A		
51							TBC							
52							TBC							
53							FA197			FA197HH		N/A		
54							FA197			FA197HH		N/A		
55							FA197			FA197HH		N/A		
56							Y527							
57							TBA							
58							TBA							
59							Y531							
60							FA054TT			FA054HH		N/A		

REAR / ARRIÈRE / HINTEN / POSTERIOR / POSTERIORE

R Suffix = High Durability Sintered Pad. **HH** Suffix = High Performance Sintered Pad. **TT** Suffix = Hard Wearing Off Road Pad. **V** Suffix = Semi Sintered Pad. **G** Suffix = Grooved Shoe.
D Suffix = Drilled Disc. **X** Suffix = Universal Left or Right Disc. **XC** Suffix = Contoured Disc. **LS** Suffix = Left/Steel Disc. **RS** = Right/Steel Disc.

*-2 Sets Required. † For Vee disc colours add RED, BLU, GRN, GLD, ORG suffix to part number.
 Ⓢ - Also available as a Vintage Motorcycle Disc.

Part numbers, prefixes, suffixes, photos and illustrations shown in this catalogue are trademarks and/or copyrights of EBC Brakes or the trademark owner A C Freeman Investments Ltd and use without express written permission of the owners is punishable by law.

Non-JAPANESE Built Motorcycles



AJS Contd.



DISC PAD CHOICES - FRONT

BRAKE DISC CHOICES - FRONT

FA, SFA, TT Pad or Brake Shoe	SFAC Carbon Scooter Pads	Speciality Pads - SXR / Vee / MXS	Sintered/HH Pads/ Grooved Shoes	Left / Gauche / Links Standard Replacement Disc	Right / Droite / Rechts Standard Replacement Disc	Contour Disc Universal left and right fitment	Universal Custom Disc	Vee-Disks Black † See note below	CX Extreme MX Race Disc/ UTVX Disc
JSM 125 Trail 13-14	FA086		FA086HH			N/A			
Modena 125 (4T) 14-15	TBA			N/A					
NAC 12 (125cc) 09-15	FA086*		FA086HH*			N/A*			
NKT1 125 Naked 08-10	FA197		FA197HH		N/A				
Regal Raptor DD 125 E 04-06	FA197		FA197HH		N/A				
Regal Raptor DD 125 E (Cast Wheels) 09-15	FA086		FA086HH			N/A			
Regal Raptor CR3-125 06	FA375	FA375V	FA375HH	MD644					
Regal Raptor CR3-125 - Floating Disc Conversion Option 06	FA375	FA375V	FA375HH	MD644					
R7 125 (4T) Sport 14-15	FA095*		FA095HH*	N/A	N/A				
Tempest Roadster 125 19	FA722								
Tempest Scrambler 125 19	FA722								
NKT2 250 Naked 08-09	FA197		FA197HH		N/A				
Regal Raptor DD 250 E 04-09	FA197		FA197HH		N/A				
350 E-9B 13-14	FA086*		FA086HH*			N/A*			
EOS 350 13-15	FA086*		FA086HH*			N/A*			
SPT 350 13-14	FA086*		FA086HH*			N/A*			
ALFER									
80 MC 87-	FA047TT		FA047R	N/A					
125 MC 87	FA047TT		FA047R	N/A					
125 MC 88-	FA126TT		FA126R	N/A					
VRE 125 4T 98-	FA181TT		FA181R	N/A					
AR 250 93-	FA185TT		FA185R	N/A					
Divertida 250 Super Motard 01-	FA181TT		FA181R	N/A					
Diferente Enduro 01-	FA181TT		FA181R	N/A					
250 MC 85-86	FA047TT		FA047R	N/A					
250 MC 87	FA047TT		FA047R	N/A					
250 MC 88-	FA126TT		FA126R	N/A					
250 GR/Enduro 85-87	FA047TT		FA047R	N/A					
250 GR/Enduro 88-	FA126TT		FA126R	N/A					
VR 250 98-	FA181TT		FA181R	N/A					
300 GR Enduro 85-87	FA047TT		FA047R	N/A					
300 GR Enduro 88-	FA126TT		FA126R	N/A					
ALTA MOTORS (ELECTRIC)									
Redshift MX 16-18	FA181TT	MXS181	FA181R			TBA			
Redshift SM 16-18	FA244		FA244HH			TBA			
ANCILLOTTI									
PS 80/PST 125 MX/GS 83-			841G						
PSV 250 MX 83-			841G						
APACHE									
Mini Tomahawk 50 (2T) 08-09	N/A								
Mini Tomahawk 50 (4T) 08-09	H346*		H346G*						
RLX 50	H346*		H346G*						
RLX 100	H346*		H346G*						
RLX 110	H346*		H346G*						
F 100	FA067TT*		FA067R*	N/A	N/A				
ZX 100	H346*		H346G*						
RLX 150 S	Y503*		Y503G*						
RLX 250 S (MK1) Rear Disc Model	FA067TT*		FA067R*	N/A	N/A				
RLX 250 SX (MK1) Rear Disc Model	FA067TT*		FA067R*	N/A	N/A				
RLX 320 S	FA067TT*		FA067R*	N/A	N/A				
RLX 320 Utility	FA067TT*		FA067R*	N/A	N/A				
RLX 450 S	FA067TT*		FA067R*	N/A	N/A				

FRONT / AVANT / VORN / FRENTE / ANTERIORE

Line #
1
2
3
4
5
6
7
8
9
10
11
12
13
14
15
16
17
18
19
20
21
22
23
24
25
26
27
28
29
30
31
32
33
34
35
36
37
38
39
40
41
42
43
44
45
46
47
48
49
50
51
52
53
54
55
56
57
58
59
60

R Suffix = High Durability Sintered Pad. HH Suffix = High Performance Sintered Pad. TT Suffix = Hard Wearing Off Road Pad. V Suffix = Semi Sintered Pad. G Suffix = Grooved Shoe.
D Suffix = Drilled Disc. X Suffix = Universal Left or Right Disc. XC Suffix = Contoured Disc. LS Suffix = Left/Steel Disc. RS = Right/Steel Disc.

*-2 Sets Required. † For Vee disc colours add RED, BLU, GRN, GLD, ORG suffix to part number.

⊗ - Also available as a Vintage Motorcycle Disc.

Non-JAPANESE Built Motorcycles

Line #	BRAKE DISC CHOICES - FRONT						DISC PAD CHOICES - REAR				BRAKE DISC CHOICES - REAR			
	Oversize 250 /280mm Disc Kit	OSX Oversize 250/280mm Disc Kit	Relocating Bracket for 250/ 280mm Disc	Oversize 320mm Disc Kit	SMX Oversize 320mm Disc Kit	Relocating Bracket for 320mm Disc	FA, SFA, TT Pad or Brake Shoe	SFAC Carbon Scooter Pads	Speciality Pads - SXR / Vee / MXS	Sintered/ HH Pads/ Grooved Shoes	Standard Replacement Disc	Contour Disc Rear fitment	Vee-Discs™ CONTOUR	CX Extreme MX Race Disc/ UTVX Disc
1							FA197			FA197HH		N/A		
2														
3							FA086			FA086HH		N/A		
4							FA197			FA197HH	N/A			
5							TBA							
6							FA197			FA197HH		N/A		
7							FA343			FA343HH	N/A			
8							FA343			FA343HH	N/A			
9							FA140			FA140HH				
10							TBC							
11							TBC							
12							FA197			FA197HH	N/A			
13							TBA							
14							FA197			FA197HH		N/A		
15							FA197			FA197HH		N/A		
16							FA197					FA197HH		
17														
18														
19							FA115TT			FA115R	N/A			
20							N/A							
21							FA047TT			FA047R	N/A			
22							FA208TT			FA208R	N/A			
23							FA067TT			FA067R	N/A			
24							FA208TT			FA208R	N/A			
25							FA208TT			FA208R	N/A			
26							N/A							
27							FA047TT			FA047R	N/A			
28							FA047TT			FA047R	N/A			
29							N/A							
30							FA047TT			FA047R	N/A			
31							FA208TT			FA208R	N/A			
32							N/A							
33							FA047TT			FA047R	N/A			
34														
35														
36							FA368TT	MXS368		FA368R		TBA		
37							FA368TT			FA368R		TBA		
38														
39														
40										841G				
41										843G				
42														
43														
44							FA232TT			FA232R	N/A			
45							H307			H307G				
46							FA083TT			FA083R	N/A			
47							FA083TT			FA083R	N/A			
48							FA083TT			FA083R	N/A			
49							FA067TT			FA067R	N/A			
50							FA067TT			FA067R	N/A			
51							FA165TT			FA165R	N/A			
52							FA135TT			FA135R	N/A			
53							FA135TT			FA135R	N/A			
54							FA067TT			FA067R	N/A			
55							FA067TT			FA067R	N/A			
56							FA067TT			FA067R	N/A			
57														
58														
59														
60														

REAR / ARRIÈRE / HINTEN / POSTERIOR / POSTERIORE

R Suffix = High Durability Sintered Pad. **HH** Suffix = High Performance Sintered Pad. **TT** Suffix = Hard Wearing Off Road Pad. **V** Suffix = Semi Sintered Pad. **G** Suffix = Grooved Shoe.
D Suffix = Drilled Disc. **X** Suffix = Universal Left or Right Disc. **XC** Suffix = Contoured Disc. **LS** Suffix = Left/Steel Disc. **RS** = Right/Steel Disc.

*-2 Sets Required. † For Vee disc colours add RED, BLU, GRN, GLD, ORG suffix to part number.
 Ⓢ - Also available as a Vintage Motorcycle Disc.

Part numbers, prefixes, suffixes, photos and illustrations shown in this catalogue are trademarks and/or copyrights of EBC Brakes or the trademark owner A C Freeman Investments Ltd and use without express written permission of the owners is punishable by law.

Non-JAPANESE Built Motorcycles



APRILIA



(Inc Scarabeo Models up to 2009/ See separate Scarabeo section for 2010 models onwards)

DISC PAD CHOICES - FRONT

BRAKE DISC CHOICES - FRONT

FA, SFA, TT Pad or Brake Shoe	SFAC Carbon Scooter Pads	Speciality Pads - SXR / Vee / MXS	Sintered/HH Pads/ Grooved Shoes	Left / Gauche / Links Standard Replacement Disc	Right / Droite / Rechts Standard Replacement Disc	Contour Disc Universal left and right filment	Universal Custom Disc	Vee-Discs Black † See note below	CX Extreme MX Race Disc/ UTVX Disc
AF1 Futura 50				MD625LS					
Amico (All models)	SFA193	SFAC193	SFA193HH	MD904D				VR904	
Area 51	SFA193	SFAC193	SFA193HH	MD936D				VR936	
Classic 50	FA116			N/A					
Europa 50	FA116			MD625LS					
Habana 50/Habana Custom	SFA193	SFAC193	SFA193HH	MD943D		MD943C		VR943	
Gulliver (All models)	SFA193	SFAC193	SFA193HH	MD943D		MD943C		VR943	
Mini RX 50 Experience	FA351TT			N/A					
MX 50	FA194		FA194HH	MD6214D					
Mojito Custom 50 (120mm Diameter Rear Drum)	SFA193	SFAC193	SFA193HH	MD943D		MD943C		VR943	
Mojito Custom 50 (110mm Diameter Rear Drum)	SFA193	SFAC193	SFA193HH	MD943D		MD943C		VR943	
Mojito Retro 50 (120mm Diameter Rear Drum)	SFA193	SFAC193	SFA193HH	MD943D		MD943C		VR943	
Pegaso 50	FA256TT		FA256HH	MD6214D					
(2 pads both same shape modification A)									
Pegaso 50	FA194		FA194HH	MD6214D					
(Pad with hook on one side modification B)									
Rally (All models) A/C	SFA193	SFAC193	SFA193HH	MD943D		MD943C		VR943	
Rally 50 All models L/C	SFA193	SFAC193	SFA193HH	MD943D		MD943C		VR943	
RS 50 (6 bolt disc fixing front & rear)	FA047		FA047HH	MD639LS					
RS 50 (5 bolt fixing front & rear)	FA194		FA194HH	MD672LS					
RS 50 (Radial Caliper - 6 bolt fixing front & rear)	FA266		FA266HH	MD685LS					
RS4 50 (4T) (AJP Calipers)	FA399			MD685LS					
RS4 50 (4T) (J.Juan Calipers)	FA095		FA095HH	MD685LS					
RX 3-5 Marce (M/N) (50cc)	FA167		FA167HH	MD6214D					
RX 3-5 Marce (P/R) (50cc)	FA167		FA167HH	MD6214D					
RX 50 C/CD	FA194		FA194HH	MD6214D					
RX 50 Racing	FA194		FA194HH	MD8002					
RX 50 Factory	FA194		FA194HH	MD811					
Scarabeo 50 (2T) (HS/HL) Front drum model	805								
Scarabeo 50 (2T) (H2/HL) Front disc model	SFA193	SFAC193	SFA193HH	MD917D					
Scarabeo 50 (2T) (PFO100) (Rear drum model)	SFA193	SFAC193	SFA193HH	MD945D				VR945	
Scarabeo 50 (2T) (Rear disc model) (PFO100)	SFA193	SFAC193	SFA193HH	MD945D				VR945	
Scarabeo 50 (2T) (Rear drum model) (PFG00/TH000)	SFA193	SFAC193	SFA193HH	MD945D				VR945	
Scarabeo 50 (2T) (Rear disc model) (PFG00/TH000)	SFA193	SFAC193	SFA193HH	MD945D				VR945	
Scarabeo 50 Classic 2T (PFO100) (Rear drum model)	SFA193	SFAC193	SFA193HH	MD990D				VR990	
Scarabeo Classic (2T) (PFO100) (Rear disc model)	SFA193	SFAC193	SFA193HH	MD990D				VR990	
Scarabeo 50 (Ditech) (2T) (SCA00)	SFA193	SFAC193	SFA193HH	MD945D				VR945	
Scarabeo 50 Street (2T) (TH00/THE00)	SFA193	SFAC193	SFA193HH	MD945D				VR945	
Scarabeo 50 (4T) (TG000)	SFA193	SFAC193	SFA193HH	MD945D				VR945	
Scarabeo 50 (4T) (TGA00/TGB00)	SFA193	SFAC193	SFA193HH	MD945D				VR945	
Scarabeo 50 (4T)	SFA193	SFAC193	SFA193HH	MD945D				VR945	
Sonic (All models)	SFA193	SFAC193	SFA193HH	MD935D					
Sport City One 50 (2T)	SFA353	SFAC353	SFA353HH	MD924D				VR924	
Sport City One 50 (4T)	SFA353	SFAC353	SFA353HH	MD924D				VR924	
SR 50 Ditech (LC) (RLD 100)	SFA193	SFAC193	SFA193HH	MD943D		MD943C		VR943	
SR 50 WWW (A/C) (LYH00)	SFA193	SFAC193	SFA193HH	MD943D		MD943C		VR943	
SR 50 Street (LC/2T) (TE00/TEA00)	SFA193	SFAC193	SFA193HH	MD943D		MD943C		VR943	
Note - Rear disc mounts onto a spacer carrier hub									
SR 50 R/Factory (LC/2T) (VFB00/VFD00)	SFA193	SFAC193	SFA193HH	MD943D		MD943C		VR943	
Note - Rear disc mounts onto a spacer carrier hub									
SR 50 R SBK/SBK Aitalia Replica (LC)	SFA193	SFAC193	SFA193HH			MD943C		VR943	
SR 50 H20 (Ditech) (RLA1/RLB1) (Rear disc model)	SFA193	SFAC193	SFA193HH	MD943D		MD943C		VR943	
SR 50 H20 (Ditech) (RLA1/RLB1) (Rear drum model)	SFA193	SFAC193	SFA193HH	MD943D		MD943C		VR943	
SR 50 (A/C) GP/LB/LF	SFA193	SFAC193	SFA193HH	MD943D		MD943C		VR943	
SR 50 (LC)	SFA193	SFAC193	SFA193HH	MD943D		MD943C		VR943	
SR 50 Motard (2T)	SFA353	SFAC353	SFA353HH	MD924D				VR924	
SR 50 Motard (4T/4V)	SFA353	SFAC353	SFA353HH	MD924D				VR924	
SR 50 Stealth/Racing (LC) (Drum rear brake) (MZCO)	SFA193	SFAC193	SFA193HH	MD943D		MD943C		VR943	

FRONT / AVANT / VORN / FRENTE / ANTERIORE

Line #

R Suffix = High Durability Sintered Pad. HH Suffix = High Performance Sintered Pad. TT Suffix = Hard Wearing Off Road Pad. V Suffix = Semi Sintered Pad. G Suffix = Grooved Shoe.
 D Suffix = Drilled Disc. X Suffix = Universal Left or Right Disc. XC Suffix = Contoured Disc. LS Suffix = Left/Steel Disc. RS = Right/Steel Disc.

*-2 Sets Required. † For Vee disc colours add RED, BLU, GRN, GLD, ORG suffix to part number.

⊗ - Also available as a Vintage Motorcycle Disc.

Non-JAPANESE Built Motorcycles

Line #	BRAKE DISC CHOICES - FRONT						DISC PAD CHOICES - REAR				BRAKE DISC CHOICES - REAR			
	Oversize 250 /280mm Disc Kit	OSX Oversize 250/280mm Disc Kit	Relocating Bracket for 250/ 280mm Disc	Oversize 320mm Disc Kit	SMX Oversize 320mm Disc Kit	Relocating Bracket for 320mm Disc	FA, SFA, TT Pad or Brake Shoe	SFAC Carbon Scooter Pads	Speciality Pads - SXR / Vee / MXS	Sintered/ HH Pads/ Grooved Shoes	Standard Replacement Disc	Contour Disc Rear fitment	Vee-Discs™ CONTOUR	CX Extreme MX Race Disc/ UTVX Disc
1														
2														
3							FA060			N/A				
4							893							
5							SFA193	SFAC193	SFA193HH	MD943D		VR943		
6							995							
7							FA060			N/A				
8							817							
9							893							
10							TBA							
11							FA060			MD6286D				
12							817							
13							899							
14							817							
15							FA337TT			MD6286D				
16														
17							FA337TT			MD6286D				
18														
19							893							
20							SFA193	SFAC193	SFA193HH	MD943D	MD943C	VR943		
21							FA060			N/A				
22							FA060			MD664				
23							FA115		FA115HH	MD686				
24							FA093			MD833				
25							FA083TT			MD833				
26							FA060			MD6286D				
27							FA060			MD6286D				
28							FA060			MD6286D				
29							FA060			MD6286D				
30							FA115		FA115HH	MD6248D				
31							893							
32							893							
33							893							
34							SFA193	SFAC193	SFA193HH	MD943D		VR943		
35							893							
36							SFA193	SFAC193	SFA193HH	MD943D		VR943		
37							893							
38							SFA193	SFAC193	SFA193HH	MD943D		VR943		
39							SFA298	SFAC298	SFA298HH	MD943D		VR943		
40							816							
41							816							
42							816							
43							816							
44							893							
45							816							
46							816							
47							SFA298	SFAC298	SFA298HH	MD943D	MD943C	VR943		
48							893							
49							SFA298	SFAC298	SFA298HH	MD996D		VR996		
50														
51							SFA298	SFAC298	SFA298HH	MD996D		VR996		
52														
53							SFA298	SFAC298	SFA298HH		TBA			
54							SFA298	SFAC298	SFA298HH	MD943D	MD943C	VR943		
55							817							
56							893							
57							893							
58							816							
59							816							
60							893							

REAR / ARRIÈRE / HINTEN / POSTERIOR / POSTERIORE

R Suffix = High Durability Sintered Pad. **HH** Suffix = High Performance Sintered Pad. **TT** Suffix = Hard Wearing Off Road Pad. **V** Suffix = Semi Sintered Pad. **G** Suffix = Grooved Shoe.
D Suffix = Drilled Disc. **X** Suffix = Universal Left or Right Disc. **XC** Suffix = Contoured Disc. **LS** Suffix = Left/Steel Disc. **RS** = Right/Steel Disc.

*-2 Sets Required. † For Vee disc colours add RED, BLU, GRN, GLD, ORG suffix to part number.
 ☉ - Also available as a Vintage Motorcycle Disc.

Part numbers, prefixes, suffixes, photos and illustrations shown in this catalogue are trademarks and/or copyrights of EBC Brakes or the trademark owner A C Freeman Investments Ltd and use without express written permission of the owners is punishable by law.

Non-JAPANESE Built Motorcycles



APRILIA Contd.



DISC PAD CHOICES - FRONT

BRAKE DISC CHOICES - FRONT

R Suffix = High Durability Sintered Pad. HH Suffix = High Performance Sintered Pad. TT Suffix = Hard Wearing Off Road Pad. V Suffix = Semi Sintered Pad. G Suffix = Grooved Shoe.

D Suffix = Drilled Disc. X Suffix = Universal Left or Right Disc. XC Suffix = Contoured Disc. LS Suffix = Left/Steel Disc. RS = Right/Steel Disc.

Model	Year	DISC PAD CHOICES - FRONT				BRAKE DISC CHOICES - FRONT						Line #
		FA, SFA, TT Pad or Brake Shoe	SFAC Carbon Scooter Pads	Speciality Pads - SXR / Vee / MXS	Sintered/HH Pads/ Grooved Shoes	Left / Gauche / Links Standard Replacement Disc	Right / Droite / Rechts Standard Replacement Disc	Contour Disc Universal left and right fitment	Universal Custom Disc	Vee-Discs Black † See note below	CX Extreme MX Race Disc/ UTVX Disc	
SR 50 Stealth/Racing (LC) (Disc rear brake) (MZCO)	97-99	SFA193	SFAC193		SFA193HH	MD943D		MD943C		VR943		1
SX 50	06-10	FA194			FA19HH	MD8002						2
SX 50	06-20	FA194			FA194HH	MD811						3
SX 50 Limited Edition	14-16	FA194			FA194HH	MD811						4
SX 50 Factory	19-20	FA194			FA194HH	MD811						5
Tuono 50	04	FA194			FA194HH	MD672LS						6
Scarabeo 100 (2T) (Yamaha Engine - RE00)	00	SFA301	SFAC301		SFA301HH	MD945D				VR945		7
Scarabeo 100 (2T) (Minarelli Engine - REA0)	00	SFA301	SFAC301		SFA301HH	MD945D				VR945		8
Scarabeo 100 (4T) (SA000/VA000)	01-09	SFA301	SFAC301		SFA301HH	MD945D				VR945		9
AF1 125	87	FA134						MD635RS				10
AF1 125	88-89	FA126			FA126HH			MD635RS				11
AF1 125	90-91	FA126			FA126HH			MD612RS				12
Atlantic 125	03-08	SFA324	SFAC324		SFA324HH	MD997D				VR997		13
Atlantic 125	10	SFA324	SFAC324		SFA324HH	MD997D				VR997		14
Classic 125	95-01	FA167			FA167HH			MD628RS				15
ETX 125	99-01	FA194			FA194HH	N/A						16
Habana 125/Habana Custom	00-02	SFA301	SFAC301		SFA301HH	MD943D		MD943C		VR943		17
Leonardo 125/150	96-98	SFA193	SFAC193		SFA193HH	MD942D				VR942		18
Leonardo 125/150 ST/SP	99-04	SFA301	SFAC301		SFA301HH	MD942D				VR942		19
Leonardo 125	05-06	SFA301	SFAC301		SFA301HH	MD942D				VR942		20
Mojito/Mojito Custom 125	03-12	SFA301	SFAC301		SFA301HH	MD943D		MD943C		VR943		21
MX 125	04-06	FA181TT			FA181R	MD2003X			MD2003CC	VR2003BLK		22
RS 125 (6 bolt rear disc/2T)	92-98	FA126			FA126HH		MD2003X	MD2003XC	MD2003CC	VR2003BLK		23
RS 125 (5 bolt rear disc/2T)	99-05	FA126			FA126HH		MD2003X	MD2003XC	MD2003CC	VR2003BLK		24
RS 125 (Radial Caliper/2T)	06-12	FA432			FA432HH		MD621X	MD621XC		VR621BLK		25
RS 125 (4T)	17-18	FA399				MD685LS						26
RS 125 (4T) GP Replica	18-20	FA399				MD685LS						27
RS4 125 (4T) (AJP Calipers)	11-20	FA399				MD685LS						28
RS4 125 (4T) (J.Juan Calipers)	11-20	FA095			FA095HH	MD685LS						29
Scarabeo 125/150	99-02	SFA256	SFAC256		SFA256HH	MD952D				VR952		30
Scarabeo 125/200	03	SFA256	SFAC256		SFA256HH	MD952D				VR952		31
Scarabeo 125/150 GT	04-06	SFA324	SFAC324		SFA324HH	MD952D				VR952		32
Scarabeo 125	07-10	SFA324	SFAC324		SFA324HH	MD952D				VR952		33
Tuareg Rally 125 (N)	-93	FA167			FA167HH			N/A				34
RX 125	92-99	FA194			FA194HH			N/A				35
RX 125	00-01	FA181TT			FA181R	N/A						36
RX 125 (Brembo Front & Grimeca Rear caliper)	08-12	FA181TT		MXS181	FA181R	TBA						37
RX 125 (AJP Calipers Front & Rear)	08-12	FA181TT		MXS181	FA181R	TBA						38
RX 125	18-21	FA181TT			FA181R	TBA						39
Pegaso 125	91	FA167			FA167HH			N/A				40
Pegaso 125 Kat	94-95	FA194			FA194HH			N/A				41
Red Rose 125 (Cast wheel)	87	FA256			FA256HH			N/A				42
Red Rose 125 (Spoke wheel)	88-94	FA256			FA256HH		MD628RS					43
Sport City 125	04-08	SFA256	SFAC256		SFA256HH	MD952D				VR952		44
Sport City Cube 125	08-12	SFA256	SFAC256		SFA256HH	MD952D				VR952		45
Sport City One - 125cc	08-11	SFA353	SFAC353		SFA353HH	MD924D				VR924		46
SR 125/150	99-02	SFA301	SFAC301		SFA301HH	MD943D		MD943C		VR943		47
SR 125 Motard (4T)	12-15	SFA353	SFAC353		SFA353HH	MD924D				VR924		48
SR 125 Max (4T)	11-15	SFA353	SFAC353		SFA353HH	MD983D				VR983		49
SX 125	08-13	FA181TT		MXS181	FA181R	TBA						50
SX 125	18-21	SFA353	SFAC353		SFA353HH	TBA						51
Tuareg Rally 125	89	FA163				N/A						52
Tuareg Rally 125 (L/M)	90-91	FA256TT			FA256HH	N/A						53
Tuono 125	03-04	FA126			FA126HH		MD2003X	MD2003XC	MD2003CC	VR2003BLK		54
Tuono 125	17-20	FA399				MD685						55
TX 125/240/311	86-88	FA115TT			FA115R			N/A				56
Atlantic 200	03-05	SFA324	SFAC324		SFA324HH	MD997D				VR997		57
Scarabeo 200	07-09	SFA324	SFAC324		SFA324HH	MD952D				VR952		58
Sport City 200	04-08	SFA256	SFAC256		SFA256HH	MD952D				VR952		59
Sport City Cube 200	08-09	SFA256	SFAC256		SFA256HH	MD952D				VR952		60

*-2 Sets Required. † For Vee disc colours add RED, BLU, GRN, GLD, ORG suffix to part number.

⊗ - Also available as a Vintage Motorcycle Disc.

Non-JAPANESE Built Motorcycles

Line #	BRAKE DISC CHOICES - FRONT						DISC PAD CHOICES - REAR				BRAKE DISC CHOICES - REAR			
	Oversize 250 /280mm Disc Kit	OSX Oversize 250/280mm Disc Kit	Relocating Bracket for 250/ 280mm Disc	Oversize 320mm Disc Kit	SMX Oversize 320mm Disc Kit	Relocating Bracket for 320mm Disc	FA, SFA, TT Pad or Brake Shoe	SFAC Carbon Scooter Pads	Speciality Pads - SXR / Vee / MXS	Sintered/ HH Pads/ Grooved Shoes	Standard Replacement Disc	Contour Disc Rear fitment	Vee-Discs™ CONTOUR	CX Extreme MX Race Disc/ UTVX Disc
1							SFA193	SFAC193		SFA193HH	MD943D	MD943C	VR943	
2							FA115			FA115H	MD6284D			
3							FA115			FA115HH	MD6248D			
4							FA083TT			FA083HH	MD833			
5							FA083TT			FA083HH	MD833			
6							FA060				MD664			
7							Y527							
8							Y527							
9							816							
10							FA047				MD658			
11							FA047			FA047HH	MD658			
12							FA047			FA047HH	MD658			
13							SFA298	SFAC298		SFA298HH	MD996D		VR996	
14							SFA298	SFAC298		SFA298HH	MD996D		VR996	
15							921							
16							FA173				N/A			
17							816							
18							SFA193	SFAC193		SFA193HH	MD943D		VR943	
19							SFA301	SFAC301		SFA301HH	MD943D		VR943	
20							SFA301	SFAC301		SFA301HH	MD990D		VR990	
21							816							
22							FA382				MD6315D			
23							FA047			FA047HH	MD659			
24							FA047			FA047HH	MD664	MD664C		
25							FA298			SFA298HH	MD664	MD664C		
26							FA083TT				MD833			
27							FA083TT				MD833			
28							FA093				MD833			
29							FA083TT				MD833			
30							SFA298	SFAC298		SFA298HH	MD942D		VR942	
31							SFA298	SFAC298		SFA298HH	MD942D		VR942	
32							SFA298	SFAC298		SFA298HH	MD942D		VR942	
33							SFA298	SFAC298		SFA298HH	TBA			
34							FA382				N/A			
35							FA382				MD6315D			
36							FA382				MD6315D			
37							FA067			FA067R	TBA			
38							FA093				TBA			
39							FA083TT				TBA			
40							FA382				N/A			
41							FA382				N/A			
42							FA047			FA047HH				
43							921							
44							SFA298	SFAC298		SFA298HH	MD942D		VR942	
45							SFA298	SFAC298		SFA298HH	MD942D		VR942	
46							816							
47							816							
48							816							
49							SFA353	SFAC353		SFA353HH	MD960D		VR960	
50							FA067			FA067R	TBA			
51							FA067			FA067R	TBA			
52							FA382				MD6315D			
53							FA382				MD6315D			
54							FA047			FA047HH	MD664	MD664C		
55							FA083TT				MD833			
56										841G				
57							SFA298	SFAC298		SFA298HH	MD996D		VR996	
58							SFA298	SFAC298		SFA298HH	TBA			
59							SFA298	SFAC298		SFA298HH	MD942D		VR942	
60							SFA298	SFAC298		SFA298HH	MD942D		VR942	

REAR / ARRIÈRE / HINTEN / POSTERIOR / POSTERIORE

R Suffix = High Durability Sintered Pad. **HH** Suffix = High Performance Sintered Pad. **TT** Suffix = Hard Wearing Off Road Pad. **V** Suffix = Semi Sintered Pad. **G** Suffix = Grooved Shoe.
D Suffix = Drilled Disc. **X** Suffix = Universal Left or Right Disc. **XC** Suffix = Contoured Disc. **LS** Suffix = Left/Steel Disc. **RS** = Right/Steel Disc.

*-2 Sets Required. † For Vee disc colours add RED, BLU, GRN, GLD, ORG suffix to part number.
 Ⓢ - Also available as a Vintage Motorcycle Disc.

Part numbers, prefixes, suffixes, photos and illustrations shown in this catalogue are trademarks and/or copyrights of EBC Brakes or the trademark owner A C Freeman Investments Ltd and use without express written permission of the owners is punishable by law.

Non-JAPANESE Built Motorcycles



APRILIA Contd.



DISC PAD CHOICES - FRONT

BRAKE DISC CHOICES - FRONT

FA, SFA, TT Pad or Brake Shoe	SFAC Carbon Scooter Pads	Speciality Pads - SXR / Vee / MXS	Sintered/HH Pads/ Grooved Shoes	Left / Gauche / Links Standard Replacement Disc	Right / Droite / Rechts Standard Replacement Disc	Contour Disc Universal left and right filament	Universal Custom Disc	Vee-Discs Black † See note below	CX Extreme MX Race Disc/ UTVX Disc
TRX 240 M									
250			FA047R		N/A				
Atlantic 250 ie	SFA324	SFAC324	SFA324HH	MD997D				VR997	
Atlantic 250	SFA324	SFAC324	SFA324HH	MD997D				VR997	
Leonardo 250 SP/ST Models	SFA256	SFAC256	SFA256HH	MD942D				VR942	
RS 250	FA095*		FA095HH*	MD660LS	MD660RS				
RS 250	FA244*		FA244HH*	MD660LS	MD660RS				
Scarabeo 250 ie	SFA324	SFAC324	SFA324HH	MD952D				VR952	
Sport City 250 ie	SFA256*	SFAC256*	SFA256HH*	MD952D	MD952D			VR952*	
Sport City Cube 250	SFA256*	SFAC256*	SFA256HH*	MD952D	MD952D			VR952*	
280 R Climber	FA115TT		FA115R		N/A				
280 Climber	FA115TT		FA115R		N/A				
Scarabeo 250	SFA324	SFAC324	SFA324HH	MD952D				VR952	
Atlantic 300	SFA324	SFAC324	SFA324HH	MD997D				VR997	
Leonardo 300	SFA256	SFAC256	SFA256HH	MD942D				VR942	
Scarabeo 300 S	SFA324	SFAC324	SFA324HH	MD952D				VR952	
Sport City Cube 300	SFA256*	SFAC256*	SFA256HH*	MD952D	MD952D			VR952*	
Sport City Cube 300 Blackline	SFA256*	SFAC256*	SFA256HH*	MD952D	MD952D			VR952*	
SR 300 Max (4T)	SFA353	SFAC353	SFA353HH	MD983D				VR983	
TX 311	FA115TT		FA115R		N/A				
Atlantic 400 Sprint	SFA324	SFAC324	SFA324HH	TBA					
Atlantic Sprint 400	SFA324	SFAC324	SFA324HH	TBA					
Scarabeo 400 ie	SFA256*	SFAC256*	SFA256HH*	MD952D	MD952D			VR952*	
MXV 450	FA185TT		MXS185 FA185R			TBA			
RXV 450/550 Enduro	FA185TT		MXS185 FA185R			TBA			
SVX 450/550 Supermoto			MXS405			TBA			
Atlantic 500	SFA256*	SFAC256*	SFA256HH*	MD952D	MD952D			VR952*	
Atlantic Sprint 500	SFA324	SFAC324	SFA324HH	TBA					
Scarabeo 500/500 ABS	SFA256*	SFAC256*	SFA256HH*	MD952D	MD952D			VR952*	
Scarabeo 500 Light	SFA256*	SFAC256*	SFA256HH*	MD952D	MD952D			VR952*	
Scarabeo 500 ie	SFA256*	SFAC256*	SFA256HH*	MD952D	MD952D			VR952*	
Pegaso 600	FA167		FA167HH		N/A				
Tuareg Wind 600	FA163			MD6180D					
Pegaso 650	FA177			MD6129D					
Pegaso 650	FA209/2		FA209/2HH	MD6129D					
Pegaso 650 ie	FA209/2		FA209/2HH	MD6129D					
Pegaso Strada 650	FA244		FA244HH	MD621X		MD621XC		VR621BLK	
Pegaso 650 Trial	FA209/2		FA209/2HH	MD6129D					
Pegaso 650	FA244		FA244HH	MD621X		MD621XC		VR621BLK	
Pegaso 650 Factory			MXS405	MD621X		MD621XC		VR621BLK	
Moto 6.5	FA209/2		FA209/2HH	MD673LS					
RS 660 8V ABS			FA630HH*						
RS 660 8V Tuono ABS			FA630HH*						
Shiver 750 (RA000)	FA432*		FA432HH*	MD621X	MD621X	MD621XC*		VR621BLK*	
Shiver 750 (RAE00/STD & ABS)	FA432*		FA432HH*			MD870XC*			
Shiver 750 GT	FA432*		FA432HH*	MD621X	MD621X	MD621XC*		VR621BLK*	
Shiver 750 GT ABS	FA432*		FA432HH*			MD621XC*		VR621BLK*	
Dorsoduro 750 (ABS)	FA432*		FA432HH*			MD870XC*			
Dorsoduro Factory 750	FA244*		FA244HH*			MD870XC*			
Dorsoduro Factory 750 (ABS)	FA244*		FA244HH*			MD870XC*			
NA 850 Mana (Non ABS)	FA432*		FA432HH*	MD621X	MD621X	MD621XC*		VR621BLK*	
NA 850 Mana (Non ABS) - Parking brake	SFA257/2								
NA 850 Mana (ABS)	FA432*		FA432HH*	MD621X	MD621X	MD621XC*		VR621BLK*	
NA 850 Mana (ABS) - Parking brake	SFA257/2								
NA 850 Mana GT (ABS Model)	FA432*		FA432HH*	MD621X	MD621X	MD621XC*		VR621BLK*	
NA 850 Mana GT (ABS Model) - Parking brake	SFA257/2								
SRV 850	SFA181*	SFAC181*	SFA181HH*	MD9125D	MD9125D				
SRV 850 - Parking brake	SFA257/2								
Dorsoduro 900 (ABS)	FA432*		FA432HH*	MD2003X	MD2003X	MD2003XC*		VR2003BLK*†	
Shiver 900 (ABS)	FA432*		FA432HH*	MD2003X	MD2003X	MD2003XC*		VR2003BLK*†	

Line #

FRONT / AVANT / VORN / FRENTE / ANTERIORE

R Suffix = High Durability Sintered Pad. HH Suffix = High Performance Sintered Pad. TT Suffix = Hard Wearing Off Road Pad. V Suffix = Semi Sintered Pad. G Suffix = Grooved Shoe.

D Suffix = Drilled Disc. X Suffix = Universal Left or Right Disc. XC Suffix = Contoured Disc. LS Suffix = Left/Steel Disc. RS = Right/Steel Disc.

*-2 Sets Required. † For Vee disc colours add RED, BLU, GRN, GLD, ORG suffix to part number.

⊗ - Also available as a Vintage Motorcycle Disc.

Non-JAPANESE Built Motorcycles

Line #	BRAKE DISC CHOICES - FRONT						DISC PAD CHOICES - REAR				BRAKE DISC CHOICES - REAR			
	Oversize 250 /280mm Disc Kit	OSX Oversize 250/280mm Disc Kit	Relocating Bracket for 250/ 280mm Disc	Oversize 320mm Disc Kit	SMX Oversize 320mm Disc Kit	Relocating Bracket for 320mm Disc	FA, SFA, TT Pad or Brake Shoe	SFAC Carbon Scooter Pads	Speciality Pads - SXR / Vee / MXS	Sintered/ HH Pads/ Grooved Shoes	Standard Replacement Disc	Contour Disc Rear fitment	Vee-Discs™ CONTOUR	CX Extreme MX Race Disc/ UTVX Disc
1							FA099			FA099R	N/A			
2										841G				
3							SFA298	SFAC298		SFA298HH	MD996D		VR996	
4							SFA298	SFAC298		SFA298HH	MD996D		VR996	
5							SFA298	SFAC298		SFA298HH	MD990D		VR990	
6							FA047			FA047HH	MD665			
7							FA047			FA047HH	MD665			
8							SFA298	SFAC298		SFA298HH	TBA			
9							SFA298	SFAC298		SFA298HH	MD942D		VR942	
10							SFA298	SFAC298		SFA298HH	MD942D		VR942	
11							FA337TT			FA337R	N/A			
12							FA156				N/A			
13							SFA298	SFAC298		SFA298HH	TBA			
14							SFA298	SFAC298		SFA298HH	MD996D		VR996	
15							SFA298	SFAC298		SFA298HH	MD990D		VR990	
16							SFA298	SFAC298		SFA298HH	TBA			
17							SFA298	SFAC298		SFA298HH	MD942D		VR942	
18							SFA298	SFAC298		SFA298HH	MD942D		VR942	
19							SFA353	SFAC353		SFA353HH	MD960D		VR960	
20							FA115TT			FA115R	N/A			
21							SFA298	SFAC298		SFA298HH	MD990D			
22							SFA298	SFAC298		SFA298HH	MD990D			
23							SFA298	SFAC298		SFA298HH	TBA			
24							FA367TT		MXS367	FA367R		TBA		
25							FA367TT		MXS367	FA367R		TBA		
26							FA367TT		MXS367	FA367R		TBA		
27							SFA298	SFAC298		SFA298HH	MD990D		VR990	
28							SFA298	SFAC298		SFA298HH	MD990D			
29							SFA298	SFAC298		SFA298HH	MD990D		VR990	
30							SFA298	SFAC298		SFA298HH	TBA			
31							SFA298	SFAC298		SFA298HH	TBA			
32							FA382				N/A			
33							FA382				N/A			
34							FA173				MD6128D			
35							FA173				MD6128D			
36							FA208TT			FA208R	TBA			
37							FA213		FA213V	FA213HH	TBA			
38							FA213		FA213V	FA213HH	TBA			
39							FA213		FA213V	FA213HH	TBA			
40							FA213		FA213V	FA213HH	TBA			
41							FA173				MD674			
42							FA266			FA266HH				
43							FA266			FA266HH				
44							FA213		FA213V	FA213HH	TBA			
45							FA213		FA213V	FA213HH	TBA			
46							FA213		FA213V	FA213HH	TBA			
47							FA213		FA213V	FA213HH	TBA			
48							FA213		FA213V	FA213HH	TBA			
49							FA213		FA213V	FA213HH	TBA			
50							FA213		FA213V	FA213HH	TBA			
51							FA256			FA256HH	MD858	MD858C	VR858	
52														
53							FA256			FA256HH	MD872	MD872C	VR872	
54														
55							FA256			FA256HH	MD872	MD872C	VR872	
56														
57							SFA353	SFAC353		SFA353HH	MD9124D			
58														
59							FA213		FA213V	FA213HH	MD613		VR613	
60							FA213		FA213V	FA213HH	MD613		VR613	

REAR / ARRIÈRE / HINTEN / POSTERIOR / POSTERIORE

R Suffix = High Durability Sintered Pad. **HH** Suffix = High Performance Sintered Pad. **TT** Suffix = Hard Wearing Off Road Pad. **V** Suffix = Semi Sintered Pad. **G** Suffix = Grooved Shoe.
D Suffix = Drilled Disc. **X** Suffix = Universal Left or Right Disc. **XC** Suffix = Contoured Disc. **LS** Suffix = Left/Steel Disc. **RS** = Right/Steel Disc.

*-2 Sets Required. † For Vee disc colours add RED, BLU, GRN, GLD, ORG suffix to part number.
 Ⓢ - Also available as a Vintage Motorcycle Disc.

BRAKE APPLICATIONS

Non-JAPANESE Built Motorcycles



APRILIA Contd.



DISC PAD CHOICES - FRONT

BRAKE DISC CHOICES - FRONT

		FA, SFA, TT Pad or Brake Shoe	SFAC Carbon Scooter Pads	Speciality Pads - SXR / Vee / MXS	Sintered/HH Pads/ Grooved Shoes	Left / Gauche / Links Standard Replacement Disc	Right / Droite / Rechts Standard Replacement Disc	Contour Disc Universal left and right fitment	Universal Custom Disc	Vee-Discs Black † See note below	CX Extreme MX Race Disc/ UTVX Disc	Line #
ETV 1000 Caponord (Non ABS - Bolt fixing)	01-03	FA209/2*		FA209/2V*	FA209/2HH*	MD6307D	MD6307D					1
ETV 1000 Caponord Rally (Non ABS - Bush fixing)	03	FA209/2*		FA209/2V*	FA209/2HH*	MD6406D	MD6406D					2
ETV 1000 Caponord (ABS - Bush fixing)	04-07	FA209/2*		FA209/2V*	FA209/2HH*	MD6406D	MD6406D					3
RST Futura 1000	01-04	FA244*			FA244HH*	MD2001X	MD2001X	MD2001XC*	MD2001CC*	VR2001BLK*†		4
RSV 1000 Mille	98-00	FA244*			FA244HH*	MD666X	MD666X	MD666XC*				5
RSV 1000 Mille	01-02				FA322/4HH*	MD621X	MD621X	MD621XC*		VR621BLK*†		6
RSV 1000 Mille (Radial caliper)	03				FA322/4HH*	MD621X	MD621X	MD621XC*		VR621BLK*†		7
RSV 1000 Mille R	00	FA244*			FA244HH*	MD666X	MD666X	MD666XC*				8
RSV 1000 R Mille	01-02				FA322/4HH*	MD621X	MD621X	MD621XC*		VR621BLK*†		9
RSV 1000 R Mille (Radial caliper)	03				FA322/4HH*	MD621X	MD621X	MD621XC*		VR621BLK*†		10
RSV 1000 R Racing/Factory (Radial caliper/4 pad)	04-08				FA322/4HH*	MD621X	MD621X	MD621XC*		VR621BLK*†		11
RSV 1000 R Tuono (Radial caliper/2 pin pad fixing)	07-08	FA244*			FA244HH*	MD621X	MD621X	MD621XC*		VR621BLK*†		12
RSV 1000 SP	99-00	FA244*			FA244HH*	MD621X	MD621X	MD621XC*		VR621BLK*†		13
RSV 1000 R Factory	04-08				FA322/4HH*	MD621X	MD621X	MD621XC*		VR621BLK*†		14
RSV 1000 R	04-08				FA322/4HH*	MD621X	MD621X	MD621XC*		VR621BLK*†		15
RSV 1000 R Tuono	02-06	FA244*			FA244HH*	MD621X	MD621X	MD621XC*		VR621BLK*†		16
RSV4R	10				FA447HH*	MD2003X	MD2003X	MD2003XC*	MD2003CC*	VR2003BLK*†		17
RSV4R APRC	11-13				FA447HH*	MD2003X	MD2003X	MD2003XC*	MD2003CC*	VR2003BLK*†		18
RSV4R APRC ABS	13-14				FA447HH*	MD2003X	MD2003X	MD2003XC*	MD2003CC*	VR2003BLK*†		19
RSV4 Factory	09-10				FA447HH*	MD2003X	MD2003X	MD2003XC*	MD2003CC*	VR2003BLK*†		20
RSV4 Factory APRC	11-13				FA447HH*	MD2003X	MD2003X	MD2003XC*	MD2003CC*	VR2003BLK*†		21
RSV4 Factory APRC ABS	13-14				FA447HH*	MD2003X	MD2003X	MD2003XC*	MD2003CC*	VR2003BLK*†		22
RSV4 RF 1000	15-18				FA447HH*	MD2003X	MD2003X	MD2003XC*				23
RSV4 RR 1000	15-18				FA447HH*	MD2003X	MD2003X	MD2003XC*		VR2003BLK*†		24
SL 1000 Falco	00-04	FA244*			FA244HH*	MD666X	MD666X	MD666XC*				25
Tuono R 1000 Radial caliper/4 pad type	02-05				FA322/4HH*	MD621X	MD621X	MD621XC*		VR621BLK*†		26
Tuono R Factory 1000 Radial caliper/4 pad type	06-10				FA322/4HH*	MD621X	MD621X	MD621XC*		VR621BLK*†		27
Tuono R 1000 Radial caliper/2 pad type	02-10	FA244*			FA244HH*	MD621X	MD621X	MD621XC*		VR621BLK*†		28
Tuono V4R	11-12	FA244*			FA244HH*	MD2003X	MD2003X	TBA*		VR2003BLK*†		29
Tuono V4R - APRC	11-13	FA244*			FA244HH*	MD2003X	MD2003X	TBA*		VR2003BLK*†		30
Tuono V4R - APRC ABS	13-14				FA630HH*	MD2003X	MD2003X			VR2003BLK*†		31
RSV4 1100 Factory	19-21				FA447HH*	MD8004X	MD8004X					32
RSV4 1100 RR	19-21				FA447HH*	MD8004X	MD8004X					33
Tuono Factory 1100 V4	15-16				FA630HH*	MD2003X	MD2003X	MD2003XC*		VR2003BLK*†		34
Tuono Factory 1100 V4	17-18				FA447HH*	MD8004X	MD8004X					35
Tuono 1100 RR V4	15-16				FA630HH*	MD2003X	MD2003X	MD2003XC*		VR2003BLK*†		36
Tuono 1100 RR V4	17-21				FA447HH*	MD8004X	MD8004X					37
Tuono V4 1100 Factory	19-21				FA447HH*	MD8004X	MD8004X					38
Caponord 1200 (Cast Wheels)	13-16			FA630V*	FA630HH*	MD2003X	MD2003X	MD2003XC*		VR2003BLK*†		39
Caponord Rally 1200 (Spoke Wheels)	15-19			FA630V*	FA630HH*	TBA	TBA					40
Dorsoduro 1200	11-12	FA244*			FA244HH*	MD2003X	MD2003X	MD2003XC*		VR2003BLK*†		41
Dorsoduro 1200 ATC/ABS	11-14	FA244*			FA244HH*	MD2003X	MD2003X	MD2003XC*		VR2003BLK*†		42
												43
												44
ARCTIC CAT (ATV)												
50 2 x 4 Youth (2T)	04-06	H338*			H338G*							45
50 DVX Sport (4T)	06-08	H338*			H338G*							46
50 4 x 4 Auto Youth	06-08	H338*			H338G*							47
90 2 x 4 Youth (2T) Rear Drum Model	02-04	H338*			H338G*							48
90 2 x 4 Youth (4T) Rear Drum Model	04-05	H338*			H338G*							49
90 2 x 4 Youth (4T) Rear Disc Model	06	H338*			H338G*							50
Alterra 90	17-19	H338*			H338G*							51
90 DVX	06-14	H338*			H338G*							52
90 DVX	18	H338*			H338G*							53
90 DVX SE	09	H338*			H338G*							54
90 Reverse Gear Model	10-14	H338*			H338G*							55
150 Utility 2x4	09-14	H303*			H303G*							56
150 Utility 2x4	15-18	H303*			H303G*							57
250 2 x 4 Utility	99-04	FA271TT*			FA271R*	MD6173D	MD6173D				UTVX6173*	58
250 2 x 4 Utility	05-09	FA395TT*			FA395R*	MD6173D	MD6173D				UTVX6173*	59
250 4 x 4 Utility	01-04	FA271TT*			FA271R*	MD6173D	MD6173D				UTVX6173*	60

FRONT / AVANT / VORN / FRENTE / ANTERIORE

R Suffix = High Durability Sintered Pad. HH Suffix = High Performance Sintered Pad. TT Suffix = Hard Wearing Off Road Pad. V Suffix = Semi Sintered Pad. G Suffix = Grooved Shoe.
D Suffix = Drilled Disc. X Suffix = Universal Left or Right Disc. XC Suffix = Contoured Disc. LS Suffix = Left/Steel Disc. RS Suffix = Right/Steel Disc.

*-2 Sets Required. † For Vee disc colours add RED, BLU, GRN, GLD, ORG suffix to part number.

⊗ - Also available as a Vintage Motorcycle Disc.

Non-JAPANESE Built Motorcycles

Line #	BRAKE DISC CHOICES - FRONT						DISC PAD CHOICES - REAR				BRAKE DISC CHOICES - REAR			
	Oversize 250 /280mm Disc Kit	OSX Oversize 250/280mm Disc Kit	Relocating Bracket for 250/ 280mm Disc	Oversize 320mm Disc Kit	SMX Oversize 320mm Disc Kit	Relocating Bracket for 320mm Disc	FA, SFA, TT Pad or Brake Shoe	SFAC Carbon Scooter Pads	Speciality Pads - SXR / Vee / MXS	Sintered/ HH Pads/ Grooved Shoes	Standard Replacement Disc	Contour Disc Rear fitment	Vee-Discs™ CONTOUR	CX Extreme MX Race Disc/ UTVX Disc
1							FA266		FA266V	FA266HH	MD6308D			
2							FA266		FA266V	FA266HH	MD6308D			
3							FA266		FA266V	FA266HH	MD6308D			
4							FA181TT			FA181HH	MD697	MD697C		
5							FA266			FA266HH	MD613	MD613C	VR613	
6							FA266			FA266HH	MD613	MD613C	VR613	
7							FA266			FA266HH	MD613	MD613C	VR613	
8							FA266			FA266HH	MD613	MD613C	VR613	
9							FA266			FA266HH	MD613	MD613C	VR613	
10							FA266			FA266HH	MD613	MD613C	VR613	
11							FA266			FA266HH	MD613	MD613C	VR613	
12							FA266			FA266HH	MD613	MD613C	VR613	
13							FA266			FA266HH	MD613	MD613C	VR613	
14							FA266			FA266HH	MD613	MD613C	VR613	
15							FA266			FA266HH	MD613	MD613C	VR613	
16							FA266			FA266HH	MD613	MD613C	VR613	
17							FA266			FA266HH	MD613	MD613C	VR613	
18							FA266			FA266HH	MD613	MD613C	VR613	
19							FA266			FA266HH	MD613	MD613C	VR613	
20							FA266			FA266HH	MD613	MD613C	VR613	
21							FA266			FA266HH	MD613	MD613C	VR613	
22							FA266			FA266HH	MD613	MD613C	VR613	
23							FA266			FA266HH	MD613		VR613	
24							FA266			FA266HH	MD613		VR613	
25							FA266			FA266HH	MD613	MD613C	VR613	
26							FA266			FA266HH	MD613	MD613C	VR613	
27							FA266			FA266HH	MD613	MD613C	VR613	
28							FA266			FA266HH	MD613	MD613C	VR613	
29							FA266			FA266HH	MD613	TBA		
30							FA266			FA266HH	MD613	TBA		
31							FA266			FA266HH	MD613			
32							FA266			FA266HH	MD613		VR613	
33							FA266			FA266HH	MD613		VR613	
34							FA266			FA266HH	MD613		VR613	
35							FA266			FA266HH	MD613		VR613	
36							FA266			FA266HH	MD613		VR613	
37							FA266			FA266HH	MD613		VR613	
38							FA266			FA266HH	MD613		VR613	
39							FA213		FA213V	FA213HH	TBA			
40							FA213		FA213V	FA213HH	TBA			
41							FA213		FA213V	FA213HH	TBA			
42							FA213		FA213V	FA213HH	TBA			
43														
44														
45							N/A							
46							FA305TT			FA305R	MD6267D			
47							FA305TT			FA305R	MD6267D			
48							H307			H307G				
49							H307			H307G				
50							FA305TT			FA305R	MD6267D			
51							FA377TT			FA377R	MD6267D			
52							FA305TT			FA305R	MD6267D			
53							FA377TT			FA377R	MD6267D			
54							FA305TT			FA305R	MD6267D			
55							FA305TT			FA305R	MD6267D			
56							FA305TT			FA305R	MD6267D			
57							FA377TT			FA377R	MD6267D			
58							FA271TT			FA271R	MD6173D		UTVX6173	
59							FA395TT			FA395R	MD6173D		UTVX6173	
60							FA271TT			FA271R	MD6173D		UTVX6173	

REAR / ARRIÈRE / HINTEN / POSTERIOR / POSTERIORE

R Suffix = High Durability Sintered Pad. **HH** Suffix = High Performance Sintered Pad. **TT** Suffix = Hard Wearing Off Road Pad. **V** Suffix = Semi Sintered Pad. **G** Suffix = Grooved Shoe.
D Suffix = Drilled Disc. **X** Suffix = Universal Left or Right Disc. **XC** Suffix = Contoured Disc. **LS** Suffix = Left/Steel Disc. **RS** = Right/Steel Disc.

BRAKE APPLICATIONS

*-2 Sets Required. † For Vee disc colours add RED, BLU, GRN, GLD, ORG suffix to part number.
 Ⓢ - Also available as a Vintage Motorcycle Disc.

Non-JAPANESE Built Motorcycles



ARCTIC CAT (ATV) Contd.



DISC PAD CHOICES - FRONT

BRAKE DISC CHOICES - FRONT

		FA, SFA, TT Pad or Brake Shoe	SFAC Carbon Scooter Pads	Speciality Pads - SXR / Vee / MXS	Sintered/HH Pads/ Grooved Shoes	Left / Gauche / Links Standard Replacement Disc	Right / Droite / Rechts Standard Replacement Disc	Contour Disc Universal left and right fitment	Universal Custom Disc	Vee-Discs Black † See note below	CX Extreme MX Race Disc/ UTVX Disc	Line #
250 4 x 4 Utility	05/08	FA395TT*			FA395R*	MD6173D	MD6173D				UTVX6173*	1
250 DVX Sport	06-08	FA377TT*			FA377R*	MD6267D	MD6267D					2
300 4 x 4	98-04	FA271TT*			FA271R*	MD6173D	MD6173D				UTVX6173*	3
300 4 x 4 Utility	05	FA395TT*			FA395R*	MD6173D	MD6173D				UTVX6173*	4
300 Alterra	17-19	FA377TT*			FA377R*	MD6267D	MD6267D					5
300 ATV	10-12	FA395TT*			FA395R*	MD6173D	MD6173D				UTVX6173*	6
300 2 x 4 Utility (Mid Size)	10-16	FA377TT*			FA377R*	MD6267D	MD6267D					7
300 DVX	09-14	FA377TT*			FA377R*	MD6267D	MD6267D					8
350 ATV	12	FA395TT*			FA395R*	MD6173D	MD6173D				UTVX6173*	9
366 4 x 4 Auto Utility	08-09	FA395TT*			FA395R*	MD6173D	MD6173D				UTVX6173*	10
366 SE	10	FA395TT*			FA395R*	MD6173D	MD6173D				UTVX6173*	11
400 4 x 4 ACT	04	FA271TT*			FA271R*	MD6173D	MD6173D				UTVX6173*	12
400 4 x 4 Auto ACT	04	FA271TT*			FA271R*	MD6173D	MD6173D				UTVX6173*	13
400 2 x 4 Utility	98-04	FA271TT*			FA271R*	MD6173D	MD6173D				UTVX6173*	14
400 2 x 4 Auto Utility	04	FA271TT*			FA271R*	MD6173D	MD6173D				UTVX6173*	15
400 4 x 4 Utility	00-04	FA271TT*			FA271R*	MD6173D	MD6173D				UTVX6173*	16
400 4 x 4 Utility	05-07	FA395TT*			FA395R*	MD6173D	MD6173D				UTVX6173*	17
400 4 x 4 VP Utility	05-06	FA395TT*			FA395R*	MD6173D	MD6173D				UTVX6173*	18
400 4 x 4 Auto Utility	04	FA271TT*			FA271R*	MD6173D	MD6173D				UTVX6173*	19
400 4 x 4 Auto Utility	05-08	FA395TT*			FA395R*	MD6173D	MD6173D				UTVX6173*	20
400 4 x 4 Auto LE Utility	05-07	FA395TT*			FA395R*	MD6173D	MD6173D				UTVX6173*	21
400 4 x 4 Auto VP Utility	05-06	FA395TT*			FA395R*	MD6173D	MD6173D				UTVX6173*	22
400 DVX Sport	04-08	FA084TT*			FA084R*	MD6210D	MD6210D					23
400 DVX TS Sport	06-07	FA084TT*			FA084R*	MD6210D	MD6210D					24
400 4 x 4 Auto TBX Utility	04	FA271TT*			FA271R*	MD6173D	MD6173D				UTVX6173*	25
400 4 x 4 Auto TBX Utility	05-06	FA395TT*			FA395R*	MD6173D	MD6173D				UTVX6173*	26
Alterra 400	16-18	FA395TT*			FA395R*	MD6383D	MD6383D					27
400 ATV (Mid Size)	13-14	FA395TT*			FA395R*	MD6383D	MD6383D					28
400 TRV	09	FA395TT*			FA395R*	MD6173D	MD6173D				UTVX6173*	29
400 TRV	13	FA395TT*			FA395R*	TBA	TBA					30
400 TRV H1	10	FA395TT*			FA395R*	MD6173D	MD6173D				UTVX6173*	31
400 4 x 4 Auto TRV Multirider	06	FA395TT*			FA395R*	MD6173D	MD6173D				UTVX6173*	32
400 4 x 4 Auto TRV Plus Multirider	07	FA395TT*			FA395R*	MD6173D	MD6173D				UTVX6173*	33
425i	12	FA395TT*			FA395R*	MD6173D	MD6173D				UTVX6173*	34
425i SE	12	FA395TT*			FA395R*	MD6173D	MD6173D				UTVX6173*	35
450 H1 EFI	10	FA395TT*			FA395R*	MD6173D	MD6173D				UTVX6173*	36
450i	11-12	FA395TT*			FA395R*	MD6173D	MD6173D				UTVX6173*	37
450i GT	12	FA395TT*			FA395R*	MD6173D	MD6173D				UTVX6173*	38
450 TRV	11-12	FA395TT*			FA395R*	MD6173D	MD6173D				UTVX6173*	39
450i TRV	11	FA395TT*			FA395R*	MD6173D	MD6173D				UTVX6173*	40
Alterra 450	16	FA395TT*			FA395R*	MD6173D	MD6173D				UTVX6173*	41
XC 450i	11-12	FA395TT*			FA395R*	MD6173D	MD6173D				UTVX6173*	42
450i XC	13-14	FA395TT*			FA395R*	TBA	TBA					43
450i XC	15-17	FA395TT*			FA395R*	MD6173D	MD6173D				UTVX6173*	44
500 ATV (Mid Size)	13-14	FA395TT*			FA395R*	MD6375D	MD6375D					45
454 Bearcat 2 x 4	97-98	FA271TT*			FA271R*	MD6173D	MD6173D				UTVX6173*	46
454 Bearcat 4 x 4	96-98	FA271TT*			FA271R*	MD6173D	MD6173D				UTVX6173*	47
500 4 x 4 Auto Utility	98-04	FA271TT*			FA271R*	MD6173D	MD6173D				UTVX6173*	48
500 4 x 4 Auto Utility	05-08	FA395TT*			FA395R*	MD6173D	MD6173D				UTVX6173*	49
500 4 x 4 Auto LE Utility	05-06	FA395TT*			FA395R*	MD6173D	MD6173D				UTVX6173*	50
500 4 x 4 Manual G/Box Utility	98-04	FA271TT*			FA271R*	MD6173D	MD6173D				UTVX6173*	51
500 4 x 4 Manual G/Box Utility	05-09	FA395TT*			FA395R*	MD6173D	MD6173D				UTVX6173*	52
500 4 x 4 Auto TBX Utility	04	FA271TT*			FA271R*	MD6173D	MD6173D				UTVX6173*	53
500 4 x 4 Auto TBX Utility	05-06	FA395TT*			FA395R*	MD6173D	MD6173D				UTVX6173*	54
500 4 x 4 Auto TRV Utility	04	FA271TT*			FA271R*	MD6173D	MD6173D				UTVX6173*	55
500 4 x 4 Auto TRV Multirider	05-06/08	FA395TT*			FA395R*	MD6173D	MD6173D				UTVX6173*	56
500 ATV (Mid Size)	13-14	FA395TT*			FA395R*	MD6383D	MD6383D					57
500 ATV XT (Mid Size)	13-14	FA395TT*			FA395R*	MD6383D	MD6383D					58
500 TRV (Core/2 Up)	13-14	FA395TT*			FA395R*	MD6383D	MD6383D					59
Alterra 500	16-19	FA395TT*			FA395R*	MD6383D	MD6383D					60

*-2 Sets Required. † For Vee disc colours add RED, BLU, GRN, GLD, ORG suffix to part number.

⊗ - Also available as a Vintage Motorcycle Disc.

Non-JAPANESE Built Motorcycles

Line #	BRAKE DISC CHOICES - FRONT						DISC PAD CHOICES - REAR				BRAKE DISC CHOICES - REAR			
	Oversize 250 /280mm Disc Kit	OSX Oversize 250/280mm Disc Kit	Relocating Bracket for 250/ 280mm Disc	Oversize 320mm Disc Kit	SMX Oversize 320mm Disc Kit	Relocating Bracket for 320mm Disc	FA, SFA, TT Pad or Brake Shoe	SFAC Carbon Scooter Pads	Speciality Pads - SXR / Vee / MXS	Sintered/ HH Pads/ Grooved Shoes	Standard Replacement Disc	Contour Disc Rear fitment	Vee-Discs™ CONTOUR	CX Extreme MX Race Disc/ UTVX Disc
1							FA395TT			FA395R	MD6173D			UTVX6173
2							FA355/4TT			FA355/4R	MD6268D			
3							FA271TT			FA271R	MD6173D			UTVX6173
4							FA395TT			FA395R	MD6173D			UTVX6173
5							FA377TT			FA377R	MD6267D			
6							FA395TT			FA395R	MD6173D			UTVX6173
7							FA377TT*			FA377R*	TBA			
8							FA355/4TT			FA355/4R	MD6268D			
9							FA395TT			FA395R	MD6173D			UTVX6173
10							FA395TT			FA395R	MD6173D			UTVX6173
11							FA395TT			FA395R	MD6173D			UTVX6173
12							FA271TT			FA271R	MD6173D			UTVX6173
13							FA271TT			FA271R	MD6173D			UTVX6173
14							FA271TT			FA271R	MD6173D			UTVX6173
15							FA271TT			FA271R	MD6173D			UTVX6173
16							FA271TT			FA271R	MD6173D			UTVX6173
17							FA395TT			FA395R	MD6173D			UTVX6173
18							FA395TT			FA395R	MD6173D			UTVX6173
19							FA271TT			FA271R	MD6173D			UTVX6173
20							FA395TT			FA395R	MD6173D			UTVX6173
21							FA395TT			FA395R	MD6173D			UTVX6173
22							FA395TT			FA395R	MD6173D			UTVX6173
23							FA137TT			FA137R	MD6211D			
24							FA137TT			FA137R	MD6211D			
25							FA271TT			FA271R	MD6173D			UTVX6173
26							FA395TT			FA395R	MD6173D			UTVX6173
27							FA395TT			FA395R	MD6383D			
28							FA395TT			FA395R	MD6383D			
29							FA395TT			FA395R	MD6173D			UTVX6173
30							FA395TT			FA395R	TBA			
31							FA395TT			FA395R	MD6173D			UTVX6173
32							FA395TT			FA395R	MD6173D			UTVX6173
33							FA395TT			FA395R	MD6173D			UTVX6173
34							FA395TT			FA395R	MD6173D			UTVX6173
35							FA395TT			FA395R	MD6173D			UTVX6173
36							FA395TT			FA395R	MD6173D			UTVX6173
37							FA395TT			FA395R	MD6173D			UTVX6173
38							FA395TT			FA395R	MD6173D			UTVX6173
39							FA395TT			FA395R	MD6173D			UTVX6173
40							FA395TT			FA395R	MD6173D			UTVX6173
41							FA395TT			FA395R	MD6173D			UTVX6173
42							FA395TT			FA395R	MD6173D			UTVX6173
43							FA395TT			FA395R	TBA			
44							FA395TT			FA395R	MD6173D			UTVX6173
45							FA395TT			FA395R	MD6375D			
46							FA271TT			FA271R	MD6173D			UTVX6173
47							FA271TT			FA271R	MD6173D			UTVX6173
48							FA271TT			FA271R	MD6173D			UTVX6173
49							FA395TT			FA395R	MD6173D			UTVX6173
50							FA395TT			FA395R	MD6173D			UTVX6173
51							FA271TT			FA271R	MD6173D			UTVX6173
52							FA395TT			FA395R	MD6173D			UTVX6173
53							FA271TT			FA271R	MD6173D			UTVX6173
54							FA395TT			FA395R	MD6173D			UTVX6173
55							FA271TT			FA271R	MD6173D			UTVX6173
56							FA395TT			FA395R	MD6173D			UTVX6173
57							FA395TT			FA395R	MD6383D			
58							FA395TT			FA395R	MD6383D			
59							FA395TT			FA395R	MD6383D			
60							FA395TT			FA395R	MD6383D			

REAR / ARRIÈRE / HINTEN / POSTERIOR / POSTERIORE

R Suffix = High Durability Sintered Pad. **HH** Suffix = High Performance Sintered Pad. **TT** Suffix = Hard Wearing Off Road Pad. **V** Suffix = Semi Sintered Pad. **G** Suffix = Grooved Shoe.
D Suffix = Drilled Disc. **X** Suffix = Universal Left or Right Disc. **XC** Suffix = Contoured Disc. **LS** Suffix = Left/Steel Disc. **RS** = Right/Steel Disc.

BRAKE APPLICATIONS

*-2 Sets Required. † For Vee disc colours add RED, BLU, GRN, GLD, ORG suffix to part number.
 Ⓢ - Also available as a Vintage Motorcycle Disc.

Non-JAPANESE Built Motorcycles



ARCTIC CAT (ATV) Contd.



DISC PAD CHOICES - FRONT

BRAKE DISC CHOICES - FRONT

FRONT / AVANT / VORN / FRENTE / ANTERIORE

	FA, SFA, TT Pad or Brake Shoe	SFAC Carbon Scooter Pads	Speciality Pads - SXR / Vee / MXS	Sintered/HH Pads/ Grooved Shoes	Left / Gauche / Links Standard Replacement Disc	Right / Droite / Rechts Standard Replacement Disc	Contour Disc Universal left and right fitment	Universal Custom Disc	Vee-Discs Black † See note below	CX Extreme MX Race Disc/ UTVX Disc
550 HI EFI	09-10	FA395TT*		FA395R*	MD6173D	MD6173D				UTVX6173*
550 HI EFI LE	09-10	FA395TT*		FA395R*	MD6173D	MD6173D				UTVX6173*
550 TRV	11	FA395TT*		FA395R*	MD6173D	MD6173D				UTVX6173*
550 TRV Cruiser	11	FA395TT*		FA395R*	MD6173D	MD6173D				UTVX6173*
550 TRV EFI	09-10	FA395TT*		FA395R*	MD6173D	MD6173D				UTVX6173*
550 TRV EFI LE	09-10	FA395TT*		FA395R*	MD6173D	MD6173D				UTVX6173*
550i	11-12	FA395TT*		FA395R*	MD6173D	MD6173D				UTVX6173*
550i LTD	11-12	FA395TT*		FA395R*	MD6173D	MD6173D				UTVX6173*
550i GT	11-12	FA395TT*		FA395R*	MD6173D	MD6173D				UTVX6173*
550i GT TRV	11	FA395TT*		FA395R*	MD6173D	MD6173D				UTVX6173*
550i TRV Cruiser	11	FA395TT*		FA395R*	MD6173D	MD6173D				UTVX6173*
550 GT TRV	11-12	FA395TT*		FA395R*	MD6173D	MD6173D				UTVX6173*
550 GT S TRV	10	FA395TT*		FA395R*	MD6173D	MD6173D				UTVX6173*
550 S	10	FA395TT*		FA395R*	MD6173D	MD6173D				UTVX6173*
550 S LTD	10	FA395TT*		FA395R*	MD6173D	MD6173D				UTVX6173*
550 ATV (Mid Size)	13-14	FA395TT*		FA395R*	MD6383D	MD6383D				
550 ATV LTD (Mid Size)	13-14	FA395TT*		FA395R*	MD6383D	MD6383D				
550 ATV XT (Mid Size)	13-14	FA395TT*		FA395R*	MD6383D	MD6383D				
550 TRV LTD/2 Up	13-14	FA395TT*		FA395R*	TBA	TBA				
Alterra TRV 550 XT	16-19	FA395TT*		FA395R*	MD6383D	MD6383D				
Alterra 570	19	FA395TT*		FA395R*	MD6383D	MD6383D				
650 H1 4 x 4 Auto Utility	04	FA271TT*		FA271R*	MD6173D	MD6173D				UTVX6173*
650 H1 4 x 4 Auto Utility	05/08	FA271TT*		FA271R*	MD6173D	MD6173D				UTVX6173*
650 H1 4 x 4 Auto LE Utility	07	FA271TT*		FA271R*	MD6173D	MD6173D				UTVX6173*
650 H1 4 x 4 SE Auto Utility	06	FA271TT*		FA271R*	MD6173D	MD6173D				UTVX6173*
650 H1	10	FA395TT*		FA395R*	MD6173D	MD6173D				UTVX6173*
650 H1 Mudpro	10-11	FA395TT*		FA395R*	MD6173D	MD6173D				UTVX6173*
650 H1 TRV	09	FA395TT*		FA395R*	MD6173D	MD6173D				UTVX6173*
650 H1 TBX 4 x 4 Auto Utility	07	FA395TT*		FA395R*	MD6173D	MD6173D				UTVX6173*
650 H1 TRV 4 x 4 Auto Plus Multirider	07	FA395TT*		FA395R*	MD6173D	MD6173D				UTVX6173*
650 H1 TRV 4 x 4 Auto Plus LE Multirider	07	FA395TT*		FA395R*	MD6173D	MD6173D				UTVX6173*
650 H1 TRV 4 x 4 Auto	08	FA395TT*		FA395R*	MD6173D	MD6173D				UTVX6173*
650 TBX	09	FA395TT*		FA395R*	MD6173D	MD6173D				UTVX6173*
650 V2 4 x 4 Auto Utility	04-06	FA395TT*		FA395R*	MD6173D	MD6173D				UTVX6173*
650 V2 4 x 4 Auto LE Utility	04-05	FA395TT*		FA395R*	MD6173D	MD6173D				UTVX6173*
650 V2 4 x 4 Auto LE TS Utility	06	FA395TT*		FA395R*	MD6173D	MD6173D				UTVX6173*
700 Diesel Utility	07-08	FA395TT*		FA395R*	MD6173D	MD6173D				UTVX6173*
700i GT	11-12	FA395TT*		FA395R*	MD6173D	MD6173D				UTVX6173*
700 TRV H2 EFI Cruiser	09-10	FA395TT*		FA395R*	MD6173D	MD6173D				UTVX6173*
700 TRV	11-12	FA395TT*		FA395R*	MD6173D	MD6173D				UTVX6173*
700 TRV Cruiser	11-12	FA395TT*		FA395R*	MD6173D	MD6173D				UTVX6173*
700 TRV GT	11-12	FA395TT*		FA395R*	MD6173D	MD6173D				UTVX6173*
700 EFI 4 x 4 Utility	07-08	FA395TT*		FA395R*	MD6173D	MD6173D				UTVX6173*
700 EFI 4 x 4 LE Utility	06	FA395TT*		FA395R*	MD6173D	MD6173D				UTVX6173*
700 EFI 4 x 4 SE Utility	06	FA395TT*		FA395R*	MD6173D	MD6173D				UTVX6173*
700 EFI Cruiser	11	FA395TT*		FA395R*	MD6173D	MD6173D				UTVX6173*
700 EFI 4 x 4 Auto M4	08	FA395TT*		FA395R*	MD6173D	MD6173D				UTVX6173*
700 EFI 4 x 4 Auto TRV LE	08	FA395TT*		FA395R*	MD6173D	MD6173D				UTVX6173*
700 H1 EFI	09-10	FA395TT*		FA395R*	MD6173D	MD6173D				UTVX6173*
700 H1 EFI LE	09-10	FA395TT*		FA395R*	MD6173D	MD6173D				UTVX6173*
700 H1 EFI 4 x 4 Auto SE	08-09	FA395TT*		FA395R*	MD6173D	MD6173D				UTVX6173*
700 H1 TBX EFI	10	FA395TT*		FA395R*	MD6173D	MD6173D				UTVX6173*
700 Super Duty Diesel	10-11	FA395TT*		FA395R*	MD6173D	MD6173D				UTVX6173*
700 Mudpro	10-11	FA395TT*		FA395R*	MD6173D	MD6173D				UTVX6173*
700 H1 EFI Mudpro	09-11	FA395TT*		FA395R*	MD6173D	MD6173D				UTVX6173*
700i	11-12	FA395TT*		FA395R*	MD6173D	MD6173D				UTVX6173*
700i LTD	11-12	FA395TT*		FA395R*	MD6173D	MD6173D				UTVX6173*
700i Mudpro	11-12	FA395TT*		FA395R*	MD6173D	MD6173D				UTVX6173*
700i Mudpro LTD	11	FA395TT*		FA395R*	MD6173D	MD6173D				UTVX6173*
700 S	10	FA395TT*		FA395R*	MD6173D	MD6173D				UTVX6173*

Line #

R Suffix = High Durability Sintered Pad. **HH** Suffix = High Performance Sintered Pad. **TT** Suffix = Hard Wearing Off Road Pad. **V** Suffix = Semi Sintered Pad. **G** Suffix = Grooved Shoe.
D Suffix = Drilled Disc. **X** Suffix = Universal Left or Right Disc. **XC** Suffix = Contoured Disc. **LS** Suffix = Left/Steel Disc. **RS** = Right/Steel Disc.

*-2 Sets Required. † For Vee disc colours add RED, BLU, GRN, GLD, ORG suffix to part number.

⊗ - Also available as a Vintage Motorcycle Disc.

Non-JAPANESE Built Motorcycles

Line #	BRAKE DISC CHOICES - FRONT						DISC PAD CHOICES - REAR				BRAKE DISC CHOICES - REAR			
	Oversize 250 /280mm Disc Kit	OSX Oversize 250/280mm Disc Kit	Relocating Bracket for 250/ 280mm Disc	Oversize 320mm Disc Kit	SMX Oversize 320mm Disc Kit	Relocating Bracket for 320mm Disc	FA, SFA, TT Pad or Brake Shoe	SFAC Carbon Scooter Pads	Speciality Pads - SXR / Vee / MXS	Sintered/ HH Pads/ Grooved Shoes	Standard Replacement Disc	Contour Disc Rear fitment	Vee-Discs™ CONTOUR	CX Extreme MX Race Disc/ UTVX Disc
1							FA395TT			FA395R	MD6173D			UTVX6173
2							FA395TT			FA395R	MD6173D			UTVX6173
3							FA395TT			FA395R	MD6173D			UTVX6173
4							FA395TT			FA395R	MD6173D			UTVX6173
5							FA395TT			FA395R	MD6173D			UTVX6173
6							FA395TT			FA395R	MD6173D			UTVX6173
7							FA395TT			FA395R	MD6173D			UTVX6173
8							FA395TT			FA395R	MD6173D			UTVX6173
9							FA395TT			FA395R	MD6173D			UTVX6173
10							FA395TT			FA395R	MD6173D			UTVX6173
11							FA395TT			FA395R	MD6173D			UTVX6173
12							FA395TT			FA395R	MD6173D			UTVX6173
13							FA395TT			FA395R	MD6173D			UTVX6173
14							FA395TT			FA395R	MD6173D			UTVX6173
15							FA395TT			FA395R	MD6173D			UTVX6173
16							FA395TT			FA395R	MD6383D			
17							FA395TT			FA395R	MD6383D			
18							FA395TT			FA395R	MD6383D			
19							FA395TT			FA395R	TBA			
20							FA395TT			FA395R	MD6383D			
21							FA395TT			FA395R	MD6383D			
22							FA271TT			FA271R	MD6173D			UTVX6173
23							FA271TT			FA271R	MD6173D			UTVX6173
24							FA271TT			FA271R	MD6173D			UTVX6173
25							FA271TT			FA271R	MD6173D			UTVX6173
26							FA395TT			FA395R	MD6173D			UTVX6173
27							FA395TT			FA395R	MD6173D			UTVX6173
28							FA395TT			FA395R	MD6173D			UTVX6173
29							FA395TT			FA395R	MD6173D			UTVX6173
30							FA395TT			FA395R	MD6173D			UTVX6173
31							FA395TT			FA395R	MD6173D			UTVX6173
32							FA395TT			FA395R	MD6173D			UTVX6173
33							FA395TT			FA395R	MD6173D			UTVX6173
34							FA395TT			FA395R	MD6173D			UTVX6173
35							FA395TT			FA395R	MD6173D			UTVX6173
36							FA395TT			FA395R	MD6173D			UTVX6173
37							FA395TT			FA395R	MD6173D			UTVX6173
38							FA395TT			FA395R	MD6173D			UTVX6173
39							FA395TT			FA395R	MD6173D			UTVX6173
40							FA395TT			FA395R	MD6173D			UTVX6173
41							FA395TT			FA395R	MD6173D			UTVX6173
42							FA395TT			FA395R	MD6173D			UTVX6173
43							FA395TT			FA395R	MD6173D			UTVX6173
44							FA395TT			FA395R	MD6173D			UTVX6173
45							FA395TT			FA395R	MD6173D			UTVX6173
46							FA395TT			FA395R	MD6173D			UTVX6173
47							FA395TT			FA395R	MD6173D			UTVX6173
48							FA395TT			FA395R	MD6173D			UTVX6173
49							FA395TT			FA395R	MD6173D			UTVX6173
50							FA395TT			FA395R	MD6173D			UTVX6173
51							FA395TT			FA395R	MD6173D			UTVX6173
52							FA395TT			FA395R	MD6173D			UTVX6173
53							FA395TT			FA395R	MD6173D			UTVX6173
54							FA395TT			FA395R	MD6173D			UTVX6173
55							FA395TT			FA395R	MD6173D			UTVX6173
56							FA395TT			FA395R	MD6173D			UTVX6173
57							FA395TT			FA395R	MD6173D			UTVX6173
58							FA395TT			FA395R	MD6173D			UTVX6173
59							FA395TT			FA395R	MD6173D			UTVX6173
60							FA395TT			FA395R	MD6173D			UTVX6173

REAR / ARRIÈRE / HINTEN / POSTERIOR / POSTERIORE

R Suffix = High Durability Sintered Pad. **HH** Suffix = High Performance Sintered Pad. **TT** Suffix = Hard Wearing Off Road Pad. **V** Suffix = Semi Sintered Pad. **G** Suffix = Grooved Shoe.
D Suffix = Drilled Disc. **X** Suffix = Universal Left or Right Disc. **XC** Suffix = Contoured Disc. **LS** Suffix = Left/Steel Disc. **RS** = Right/Steel Disc.

*-2 Sets Required. † For Vee disc colours add RED, BLU, GRN, GLD, ORG suffix to part number.
 Ⓢ - Also available as a Vintage Motorcycle Disc.

BRAKE APPLICATIONS

Non-JAPANESE Built Motorcycles



ARCTIC CAT (ATV) Contd.



DISC PAD CHOICES - FRONT

BRAKE DISC CHOICES - FRONT

R Suffix = High Durability Sintered Pad. **HH** Suffix = High Performance Sintered Pad. **TT** Suffix = Hard Wearing Off Road Pad. **V** Suffix = Semi Sintered Pad. **G** Suffix = Grooved Shoe.

D Suffix = Drilled Disc. **X** Suffix = Universal Left or Right Disc. **XC** Suffix = Contoured Disc. **LS** Suffix = Left/Steel Disc. **RS** = Right/Steel Disc.

		DISC PAD CHOICES - FRONT			BRAKE DISC CHOICES - FRONT						Line #	
		FA, SFA, TT Pad or Brake Shoe	SFAC Carbon Scooter Pads	Speciality Pads - SXR / Vee / MXS	Sintered/HH Pads/ Grooved Shoes	Left / Gauche / Links Standard Replacement Disc	Right / Droite / Rechts Standard Replacement Disc	Contour Disc Universal left and right fitment	Universal Custom Disc	Vee-Discs Black † See note below		CX Extreme MX Race Disc/ UTVX Disc
700 S LTD	10	FA395TT*			FA395R*	MD6173D	MD6173D				UTVX6173*	1
700 TBX LTD	11	FA395TT*			FA395R*	MD6173D	MD6173D				UTVX6173*	2
700 ATV/Core	13-14	FA395TT*			FA395R*	TBA	TBA					3
700 ATV Diesel	12-14	FA395TT*			FA395R*	MD6383D	MD6383D					4
700 ATV LTD	12-14	FA395TT*			FA395R*	MD6383D	MD6383D					5
700 ATV XT	13-14	FA395TT*			FA395R*	MD6383D	MD6383D					6
700 TRV XT	13-14	FA395TT*			FA395R*	TBA	TBA					7
Alterra 700 inc XT, inc Mudpro	16-19	FA395TT*			FA395R*	MD6383D	MD6383D					8
Alterra TBX 700	17-18	FA395TT*			FA395R*	MD6383D	MD6383D					9
Alterra VLX 700	17-18	FA395TT*			FA395R*	MD6383D	MD6383D					10
XR 700 LTD/XT	15	FA395TT*			FA395R*	MD6383D	MD6383D					11
1000 GT	11-12	FA395TT*			FA395R*	MD6173D	MD6173D				UTVX6173*	12
1000 Mudpro LTD	12-13	FA395TT*			FA395R*	MD6173D	MD6173D				UTVX6173*	13
Alterra 1000 TRV XT EPS	17	FA395TT*			FA395R*	MD6383D	MD6383D					14
1000 H2 Mudpro EFI	11-12	FA395TT*			FA395R*	MD6173D	MD6173D				UTVX6173*	15
1000 Mudpro SE EPS	16	FA395TT*			FA395R*	MD6383D	MD6383D					16
1000 TRV Cruiser	11	FA395TT*			FA395R*	MD6173D	MD6173D				UTVX6173*	17
1000 TRV H2 EFI Cruiser	09-10	FA395TT*			FA395R*	MD6173D	MD6173D				UTVX6173*	18
Thundercat 1000 H2	08-10	FA395TT*			FA395R*	MD6173D	MD6173D				UTVX6173*	19
Thundercat 1000 H2 LE	10	FA395TT*			FA395R*	MD6173D	MD6173D				UTVX6173*	20
1000 TRV H2 EFI	10	FA395TT*			FA395R*	MD6173D	MD6173D				UTVX6173*	21
1000 XT	13-14	FA395TT*			FA395R*	TBA	TBA					22
												23
												24
												25
												26
												27
												28
												29
												30
												31
												32
												33
												34
												35
												36
												37
												38
												39
												40
												41
												42
												43
												44
												45
												46
												47
												48
												49
												50
												51
												52
												53
												54
												55
												56
												57
												58
												59
												60

*-2 Sets Required. † For Vee disc colours add RED, BLU, GRN, GLD, ORG suffix to part number.

⊗ - Also available as a Vintage Motorcycle Disc.

Non-JAPANESE Built Motorcycles

Line #	BRAKE DISC CHOICES - FRONT						DISC PAD CHOICES - REAR				BRAKE DISC CHOICES - REAR			
	Oversize 250 /280mm Disc Kit	OSX Oversize 250/280mm Disc Kit	Relocating Bracket for 250/ 280mm Disc	Oversize 320mm Disc Kit	SMX Oversize 320mm Disc Kit	Relocating Bracket for 320mm Disc	FA, SFA, TT Pad or Brake Shoe	SFAC Carbon Scooter Pads	Speciality Pads - SXR / Vee / MXS	Sintered/ HH Pads/ Grooved Shoes	Standard Replacement Disc	Contour Disc Rear fitment	Vee-Discs™ CONTOUR	CX Extreme MX Race Disc/ UTVX Disc
1							FA395TT			FA395R	MD6173D			UTVX6173
2							FA395TT			FA395R	MD6173D			UTVX6173
3							FA395TT			FA395R	TBA			
4							FA395TT			FA395R	MD6383D			
5							FA395TT			FA395R	MD6383D			
6							FA395TT			FA395R	MD6383D			
7							FA395TT			FA395R	TBA			
8							FA395TT			FA395R	MD6383D			
9							FA395TT			FA395R	MD6383D			
10							FA395TT			FA395R	MD6383D			
11							FA395TT			FA395R	MD6383D			
12							FA395TT			FA395R	MD6173D			UTVX6173
13							FA395TT			FA395R	MD6173D			UTVX6173
14							FA395TT			FA395R	MD6383D			
15							FA395TT			FA395R	MD6173D			UTVX6173
16							FA395TT			FA395R	MD6383D			
17							FA395TT			FA395R	MD6173D			UTVX6173
18							FA395TT			FA395R	MD6173D			UTVX6173
19							FA395TT			FA395R	MD6173D			UTVX6173
20							FA395TT			FA395R	MD6173D			UTVX6173
21							FA395TT			FA395R	MD6173D			UTVX6173
22							FA395TT			FA395R	TBA			
23														
24														
25							FA377TT			FA377R	MD6267D			
26							FA395TT		SXR395HH	FA395R	N/A			
27							FA395TT		SXR395HH	FA395R	N/A			
28							FA395TT		SXR395HH	FA395R	N/A			
29							FA395TT		SXR395HH	FA395R	N/A			
30							FA395TT		SXR395HH	FA395R	N/A			
31							FA395TT		SXR395HH	FA395R	N/A			
32							FA395TT		SXR395HH	FA395R	N/A			
33							FA395TT		SXR395HH	FA395R	N/A			
34							FA395TT		SXR395HH	FA395R	N/A			
35							FA395TT		SXR395HH	FA395R	N/A			
36							FA395TT		SXR395HH	FA395R	N/A			
37							FA395TT		SXR395HH	FA395R	N/A			
38							FA395TT		SXR395HH*	FA395R	N/A			
39							FA395TT*		SXR395HH*	FA395R*	MD6173D*			UTVX6173*
40							FA395TT*		SXR395HH*	FA395R*	MD6173D*			UTVX6173*
41							FA395TT*		SXR395HH*	FA395R*				
42							FA395TT*		SXR395HH*	FA395R*				
43							FA395TT*		SXR395HH*	FA395R*				
44							FA395TT*		SXR395HH*	FA395R*				
45							FA395TT*		SXR395HH*	FA395R*	MD6384D*			
46							FA395TT*		SXR395HH*	FA395R*				
47							FA395TT*		SXR395HH*	FA395R*				
48														
49							FA395TT*		SXR395HH*	FA395R*	MD6173D*			UTVX6173*
50							FA395TT*		SXR395HH*	FA395R*	TBA*			
51							FA395TT*		SXR395HH*	FA395R*	MD6384D*			
52							FA395TT*		SXR395HH*	FA395R*	TBA*			
53							FA395TT*		SXR395HH*	FA395R*	MD6173D*			UTVX6173*
54							FA395TT*		SXR395HH*	FA395R*	MD6384D*			
55							FA395TT*		SXR395HH*	FA395R*	TBA*			
56							FA395TT*		SXR395HH*	FA395R*	MD6173D*			UTVX6173*
57							FA742TT*			FA742R*				
58							FA742TT*			FA742R*				
59							FA395TT*		SXR395HH*	FA395R*	MD6173D*			UTVX6173*
60							FA395TT*		SXR395HH*	FA395R*	MD6173D*			UTVX6173*

REAR / ARRIÈRE / HINTEN / POSTERIORE

R Suffix = High Durability Sintered Pad. **HH** Suffix = High Performance Sintered Pad. **TT** Suffix = Hard Wearing Off Road Pad. **V** Suffix = Semi Sintered Pad. **G** Suffix = Grooved Shoe.
D Suffix = Drilled Disc. **X** Suffix = Universal Left or Right Disc. **XC** Suffix = Contoured Disc. **LS** Suffix = Left/Steel Disc. **RS** = Right/Steel Disc.

BRAKE APPLICATIONS

*-2 Sets Required. † For Vee disc colours add RED, BLU, GRN, GLD, ORG suffix to part number.
 ⊗ - Also available as a Vintage Motorcycle Disc.

Non-JAPANESE Built Motorcycles



ARCTIC CAT Contd. (SIDE X SIDE)



Cushman Hauler 4x4 Diesel	19
Cushman Hauler 4x4 Crew and EPS Diesel	19

ARMSTRONG

250 Trial/320 Trial	
---------------------	--

ASPES

50 Navaho	
50 Vega Hybrid	10-14
CS 75 Navaho/125 Juma/Hopi	
CM 180	
RCL 80	
125 Duma	
Vega 125 Hybrid	11-14
Perseus Hybrid 150	11-14

ATALA

Hacker LC	97
Hacker Racing	97
Byte AT10	97
Hacker	97

AUSA QUADS

M 50 Task - Side x Side	
-------------------------	--

BAJAJ

Pulsar 180 (UG4)	12-16
Pulsar 150	07-16
Pulsar 220 F	15-16
Pulsar 220 S	15-16
Pulsar Adventure AS 150	15-16
Pulsar Adventure AS 200	15-17
XCD 125 (Disc Brake)	
Pulsar RS 200 (inc Lower Fairing)	15-16
Pulsar 200 NS	14-16
Boxer 150	12-15
Pulsar 135 LS	12-16
Discover 125 ST	13-15
Discover 150 S (Disc Brake)	14-16
Discover 150 F (Disc Brake)	14-16
Discover 125 M	14-16
Discover 125 (Disc Model)	14-16
Platina 100 ES	16
CT100	16
Avenger 150 Street (Cast Wheel)	15-16
Avenger Cruise 220 DTS-i (Spoke Wheel)	15-16
Avenger Cruise 220 DTS-i (Spoke Wheel)	08-14
Avenger 220 Street (Cast Wheel)	15-16

BAOTIAN

BT 49 QT-7	06-07
BT 49 QT-9 (Speedy 50-4T)	10-11
BT 50 QT-11 (Retro 50-4T)	06-11
BT 49 QT-12 (Rebel-4T)	06-11
BT 49 QT-12 (Rocky-2T)	10-11
Eagle 50	10-11
Falcon 50 (2T)	10-11
BT 110-2	06-07
BT 125 12C1 125 Warrior	07-16
BT 125 12C1 125 Rebel	07-16

DISC PAD CHOICES - FRONT

BRAKE DISC CHOICES - FRONT

FA, SFA, TT Pad or Brake Shoe	SFAC Carbon Scooter Pads	Speciality Pads - SXR / Vee / MXS	Sintered/HH Pads/ Grooved Shoes	Left / Gauche / Links Standard Replacement Disc	Right / Droite / Rechts Standard Replacement Disc	Contour Disc Universal left and right fitment	Universal Custom Disc	Vee-Discs Black † See note below	CX Extreme MX Race Disc/ UTVX Disc
FA740TT*			FA740R*						
FA740TT*			FA740R*						
			841G						
			926G						
SFA228	SFAC228		SFA228HH	N/A					
			841G						
			841G						
941									
FA076			FA076HH	N/A					
SFA086	SFAC086		SFA086HH		N/A				
SFA054	SFAC054		SFA054HH	N/A					
SFA193	SFAC193		SFA193HH	MD901D				VR901	
SFA193	SFAC193		SFA193HH	MD901D				VR901	
SFA193	SFAC193		SFA193HH	TBA					
SFA193	SFAC193		SFA193HH	MD901D				VR901	
N/A*			FA266R*	N/A	N/A				
FA181TT			FA181HH		TBA				
FA181TT			FA181HH		TBA				
FA181TT			FA181HH		TBA				
FA181TT			FA181HH		TBA				
FA181TT			FA181HH		TBA				
FA181TT			FA181HH		TBA				
FA181TT			FA181HH		TBA				
FA181TT			FA181HH		TBA				
V903									
FA181TT			FA181HH		TBA				
FA181TT			FA181HH		TBA				
FA181TT			FA181HH		TBA				
FA181TT			FA181HH		TBA				
FA181TT			FA181HH		TBA				
FA181TT			FA181HH		TBA				
V903									
V903									
FA197			FA197HH		TBA				
FA197			FA197HH		TBA				
FA197			FA197HH		TBA				
FA197			FA197HH		TBA				
TBA				N/A					
SFA169	SFAC169		SFA169HH	N/A					
SFA169	SFAC169		SFA169HH	N/A					
SFA235	SFAC235			N/A					
TBA				N/A					
SFA047			SFA047HH	N/A					
SFA047			SFA047HH			N/A			
SFA086	SFAC086		SFA086HH		N/A				
SFA086	SFAC086		SFA086HH		N/A				
SFA086	SFAC086		SFA086HH		N/A				

Line #
1
2
3
4
5
6
7
8
9
10
11
12
13
14
15
16
17
18
19
20
21
22
23
24
25
26
27
28
29
30
31
32
33
34
35
36
37
38
39
40
41
42
43
44
45
46
47
48
49
50
51
52
53
54
55
56
57
58
59
60

FRONT / AVANT / VORN / FRENTE / ANTERIORE

R Suffix = High Durability Sintered Pad. HH Suffix = High Performance Sintered Pad. TT Suffix = Hard Wearing Off Road Pad. V Suffix = Semi Sintered Pad. G Suffix = Grooved Shoe.
D Suffix = Drilled Disc. X Suffix = Universal Left or Right Disc. XC Suffix = Contoured Disc. LS Suffix = Left/Steel Disc. RS = Right/Steel Disc.

*-2 Sets Required. † For Vee disc colours add RED, BLU, GRN, GLD, ORG suffix to part number.

⊗ - Also available as a Vintage Motorcycle Disc.

Non-JAPANESE Built Motorcycles

Line #	BRAKE DISC CHOICES - FRONT						DISC PAD CHOICES - REAR				BRAKE DISC CHOICES - REAR			
	Oversize 250 /280mm Disc Kit	OSX Oversize 250/280mm Disc Kit	Relocating Bracket for 250/ 280mm Disc	Oversize 320mm Disc Kit	SMX Oversize 320mm Disc Kit	Relocating Bracket for 320mm Disc	FA, SFA, TT Pad or Brake Shoe	SFAC Carbon Scooter Pads	Speciality Pads - SXR / Vee / MXS	Sintered/ HH Pads/ Grooved Shoes	Standard Replacement Disc	Contour Disc Rear fitment	Vee-Discs™ CONTOUR	CX Extreme MX Race Disc/ UTVX Disc
1							FA742TT*			FA742R*				
2							FA742TT*			FA742R*				
3														
4														
5										841G				
6														
7														
8										926G				
9							TBA							
10										843G				
11										841G				
12							941							
13										843G				
14							TBA							
15							SFA086	SFAC086		SFA086HH	N/A			
16														
17														
18							S624							
19							S624							
20							S624							
21							S624							
22														
23														
24										FA266R*	N/A*			
25														
26														
27							TBA							
28							TBA							
29							FA213			FA213HH	TBA			
30							FA213			FA213HH	TBA			
31							TBA							
32							TBA							
33							TBA							
34							FA213			FA213HH	TBA			
35							FA213			FA213HH	TBA			
36							V903							
37							TBA							
38							TBA							
39							TBA							
40							TBA							
41							TBA							
42							TBA							
43							V903							
44							V903							
45							TBA							
46							TBA							
47							TBA							
48							TBA							
49														
50														
51							H303				TBA			
52							H303							
53							H303							
54							H303							
55							H303							
56							H303							
57							SFA298	SFAC298		SFA298HH	N/A			
58							H303							
59														
60														

REAR / ARRIÈRE / HINTEN / POSTERIOR / POSTERIORE

R Suffix = High Durability Sintered Pad. **HH** Suffix = High Performance Sintered Pad. **TT** Suffix = Hard Wearing Off Road Pad. **V** Suffix = Semi Sintered Pad. **G** Suffix = Grooved Shoe.
D Suffix = Drilled Disc. **X** Suffix = Universal Left or Right Disc. **XC** Suffix = Contoured Disc. **LS** Suffix = Left/Steel Disc. **RS** = Right/Steel Disc.

*-2 Sets Required. † For Vee disc colours add RED, BLU, GRN, GLD, ORG suffix to part number.
 Ⓢ - Also available as a Vintage Motorcycle Disc.

Part numbers, prefixes, suffixes, photos and illustrations shown in this catalogue are trademarks and/or copyrights of EBC Brakes or the trademark owner A C Freeman Investments Ltd and use without express written permission of the owners is punishable by law.

Non-JAPANESE Built Motorcycles



BAOTIAN Contd.

BT 125 T 12E1 125 Rocky	07-16
BT 125 T 12F1 125 Tanco	07-16
BT 125 T 2A 125 Smart Rider	05-16
BT 125 T 2B2 125	09-15
BT 125 T 3A2 125 Italo	08-12
BT 125 T 3B6 125	15
BT 125 T 8A 125	07-16
BT 125 T 8B 125	09-15
BT 125 T-2	06-07
BT 125 T-7 (13" wheels)	06-07
Tanco 125	08-11

BAROSSA

Mini 50/Python	03-05
100 Sport/Python	03-05
XS 125 T-13	07-10
170 Sport	03-04
170 Cheetah/Magna	03-05
170 Cheetah	03-06
250 Cheetah	03-06
Quarterback 250	05

BELINE

Veloce 50	08-10
Veloce GT 50	08-10

BENELLI

49X Scooter	07
50 G2 Elle	79-
S 50 Scooter	81-
Devil 50	92-
Mala 50 (2T)	13
Motorella	78-
Naked 50	02-03
Pepe 50 2T (7 Spoke Cast Wheel)	99-01
Pepe 50 2T (5 Spoke Cast Wheel)	10-14
Pepe 50 4T (7 Spoke Cast Wheel)	12-16
Pepe Classic 50 2T (7 Spoke Cast Wheel)	07-14
Pepe LX 50 2T (7 Spoke Cast Wheel)	03-09
Spring 50	93-
Quattro Nove X (50cc/All Rear Drum Models)	08-12
Quattro Nove X (50cc/All Rear Disc Models)	10-16
Devil 80	92-
491 (All drum rear models) 50cc	98-04
491 (All rear disc models) 50cc	99-04
K2 50	98-01
K2 100	99-01
Naked 100	02
Pepe 100 LX	99-06
125 T	83
124/125 2C/126 2T/2CSE	76-
125 2C Twin Brake	-76
Adiva 125 (12" front wheel/rear drum model)	00
Adiva 125 (13" front wheel/rear disc model)	01-04
Aurak MY 125 (BJ 125 10A)	16-17
BN125	18-21
Caffe Nero 125	11-16
Hobby 125 (4T)	13
Leoncino 125	18-20
Macis 125	10-16

DISC PAD CHOICES - FRONT				BRAKE DISC CHOICES - FRONT							Line #
FA, SFA, TT Pad or Brake Shoe	SFAC Carbon Scooter Pads	Speciality Pads - SXR / Vee / MXS	Sintered/HH Pads/ Grooved Shoes	Left / Gauche / Links Standard Replacement Disc	Right / Droite / Rechts Standard Replacement Disc	Contour Disc Universal left and right fitment	Universal Custom Disc	Vee-Discs Black † See note below	CX Extreme MX Race Disc/ UTVX Disc	Line #	
SFA086	SFAC086									1	
SFA086	SFAC086									2	
SFA086	SFAC086									3	
SFA086	SFAC086									4	
SFA086	SFAC086									5	
SFA086	SFAC086									6	
SFA086	SFAC086									7	
SFA086	SFAC086									8	
SFA086	SFAC086		SFA086HH	N/A						9	
TBA					N/A					10	
SFA235			SFAC235	N/A						11	
										12	
TBA										13	
TBA										14	
Y503*			Y503G*							15	
SFA264	SFAC264		SFA264HH	TBA						16	
TBA*										17	
TBA*										18	
Y503*			Y503G*							19	
Y503*			Y503G*							20	
TBA										21	
										22	
										23	
SFA235	SFAC235									24	
SFA235	SFAC235									25	
										26	
										27	
SFA235	SFAC235			TBA						28	
931			931G							29	
945										30	
FA126			FA126R	N/A						31	
SFA193	SFAC193		SFA193HH	N/A						32	
908										33	
SFA193	SFAC193		SFA193HH	MD901D				VR901		34	
SFA193	SFAC193		SFA193HH	MD956D				VR956		35	
SFA193	SFAC193		SFA193HH	MD956D				VR956		36	
SFA193	SFAC193		SFA193HH	MD956D				VR956		37	
SFA193	SFAC193		SFA193HH	MD956D				VR956		38	
SFA193	SFAC193		SFA193HH	MD956D				VR956		39	
FA126			FA126R	N/A						40	
SFA235	SFAC235			TBA						41	
SFA235	SFAC235					TBA				42	
FA126			FA126R	N/A						43	
SFA193	SFAC193		SFA193HH	MD901D				VR901		44	
SFA193	SFAC193		SFA193HH	MD901D				VR901		45	
SFA193	SFAC193		SFA193HH	MD901D				VR901		46	
SFA193	SFAC193		SFA193HH	MD901D				VR901		47	
SFA193	SFAC193		SFA193HH	MD901D				VR901		48	
SFA193	SFAC193		SFA193HH	TBA						49	
FA047			FA047HH		N/A					50	
FA047			FA047R	N/A						51	
946										52	
SFA193	SFAC193		SFA193HH	MD924D				VR924		53	
SFA193	SFAC193		SFA193HH	MD9101D						54	
SFA086	SFAC086		SFA086HH							55	
FA711		FA711V								56	
SFA228	SFAC228		SFA228HH	N/A						57	
SFA228	SFAC228		SFA228HH	N/A						58	
FA658		FA658V								59	
SFA228	SFAC228		SFA228HH	TBA						60	

FRONT / AVANT / VORN / FRENTE / ANTERIORE

R Suffix = High Durability Sintered Pad. HH Suffix = High Performance Sintered Pad. TT Suffix = Hard Wearing Off Road Pad. V Suffix = Semi Sintered Pad. G Suffix = Grooved Shoe.
D Suffix = Drilled Disc. X Suffix = Universal Left or Right Disc. XC Suffix = Contoured Disc. LS Suffix = Left/Steel Disc. RS = Right/Steel Disc.

*-2 Sets Required. † For Vee disc colours add RED, BLU, GRN, GLD, ORG suffix to part number.
⊗ - Also available as a Vintage Motorcycle Disc.

Non-JAPANESE Built Motorcycles

Line #	BRAKE DISC CHOICES - FRONT						DISC PAD CHOICES - REAR				BRAKE DISC CHOICES - REAR			
	Over-size 250 /280mm Disc Kit	OSX Over-size 250/280mm Disc Kit	Relocating Bracket for 250/ 280mm Disc	Over-size 320mm Disc Kit	SMX Over-size 320mm Disc Kit	Relocating Bracket for 320mm Disc	FA, SFA, TT Pad or Brake Shoe	SFAC Carbon Scooter Pads	Speciality Pads - SXR / Vee / MXS	Sintered/ HH Pads/ Grooved Shoes	Standard Replacement Disc	Contour Disc Rear fitment	Vee- Discs™ CONTOUR	CX Extreme MX Race Disc/ UTVX Disc
1														
2														
3														
4														
5														
6														
7														
8														
9							TBA			N/A				
10							Y506							
11							TBA							
12														
13														
14							H302		H302G					
15							FA067T		FA067R					
16							820							
17							FA135TT		FA135R	N/A				
18							FA135TT		FA135R	N/A				
19							FA067TT		FA067R	N/A				
20							FA067TT		FA067R	N/A				
21							FA135TT		FA135R	N/A				
22														
23														
24							Y503							
25							Y503							
26														
27														
28							TBA							
29							931		931G					
30							965							
31							FA099		FA099R	N/A				
32							816							
33							908							
34							893							
35							893							
36							816							
37							816							
38							Y503							
39							Y503							
40							FA099		FA099R	N/A				
41							Y503							
42							SFA235	SFAC235		N/A	TBA			
43							FA099		FA099R	N/A				
44							893							
45							SFA193	SFAC193	SFA193HH	MD943D	MD943C	VR943		
46							893							
47							Y527							
48							893							
49							893							
50														
51							929							
52							929							
53							816							
54							SFA321	SFAC321	SFA321HH	MD9106D				
55							SFA213							
56							FA629							
57							SFA228	SFAC228	SFA228HH					
58							SFA228	SFAC228	SFA228HH	N/A				
59							FA698							
60							SFA228	SFAC228	SFA228HH	TBA				

REAR / ARRIÈRE / HINTEN / POSTERIOR / POSTERIORE

R Suffix = High Durability Sintered Pad. **HH** Suffix = High Performance Sintered Pad. **TT** Suffix = Hard Wearing Off Road Pad. **V** Suffix = Semi Sintered Pad. **G** Suffix = Grooved Shoe.
D Suffix = Drilled Disc. **X** Suffix = Universal Left or Right Disc. **XC** Suffix = Contoured Disc. **LS** Suffix = Left/Steel Disc. **RS** = Right/Steel Disc.

*-2 Sets Required. † For Vee disc colours add RED, BLU, GRN, GLD, ORG suffix to part number.
 Ⓢ - Also available as a Vintage Motorcycle Disc.

Part numbers, prefixes, suffixes, photos and illustrations shown in this catalogue are trademarks and/or copyrights of EBC Brakes or the trademark owner A C Freeman Investments Ltd and use without express written permission of the owners is punishable by law.

Non-JAPANESE Built Motorcycles



BENELLI Contd.



DISC PAD CHOICES - FRONT

BRAKE DISC CHOICES - FRONT

Line #

		FA, SFA, TT Pad or Brake Shoe	SFAC Carbon Scooter Pads	Speciality Pads - SXR / Vee / MXS	Sintered/HH Pads/ Grooved Shoes	Left / Gauche / Links Standard Replacement Disc	Right / Droite / Rechts Standard Replacement Disc	Contour Disc Universal left and right fitment	Universal Custom Disc	Vee-Discs Black † See note below	CX Extreme MX Race Disc/ UTVX Disc
Tarno 125	89	FA126			FA126R	N/A					
TNT 125 (Tornado Naked T 125cc)	17-21	FA711		FA711V							
TRK125	18-20	FA658									
X 125	12-14	SFA228	SFAC228		SFA228HH			N/A			
Velvet 125 (13" front wheel)	99-07	SFA193	SFAC193		SFA193HH	MD9101D					
Velvet 125 (13" Front Wheel/Touring)	08-12	SFA194	SFAC194		SFA194HH	MD9101D					
Worx 125	17-18	FA711		FA711V							
TNT 135 (Tornado Naked T 135cc)	18	FA711		FA711V							
Adiva 150 (12" front wheel/rear drum model)	00	SFA193	SFAC193		SFA193HH	MD924D				VR924	
Adiva 150 (13" front wheel/rear disc model)	01-04	SFA193	SFAC193		SFA193HH	MD9101D					
Caffe Nero 150	11-16	SFA228	SFAC228		SFA228HH	N/A					
Hobby 151 (4T)	13	SFA228	SFAC228		SFA228HH	N/A					
Macis 150	10-16	SFA228	SFAC228		SFA228HH	TBA					
UNOC 150 (Single Cyl)	13	FA244			FA244HH			N/A			
Velvet 150 (13" front wheel)	99-07	SFA193	SFAC193		SFA193HH	MD9101D					
Velvet 150 (13" Front Wheel/Touring)	08-12	SFA194	SFAC194		SFA194HH	MD9101D					
X 150	12-14	SFA228	SFAC228		SFA228HH			N/A			
TNT 200 (Tornado Naked T 200cc)	17-18	FA658		FA658V	FA658HH						
BX Motard (250cc)	12	FA181TT		MXS181	FA181R				TBA		
BX 250 Motard	16-18	FA181TT		MXS181	FA181R						
Caffe Nero 250	Left 08-14	SFA197	SFAC197		SFA197HH	TBA	TBA				
	Right	SFA228	SFAC228		SFA228HH						
UNOC 250 (Single Cyl)	13	FA244			FA244HH			N/A			
Velvet 250	99-12	SFA194	SFAC194		SFA194HH	MD997D				VR997	
250 C/TS, 250/4	76-	FA047			FA047HH	N/A					
666 Scooter Born in Hell 125cc	98-99	FA095			FA095HH	N/A					
Leoncino 250	18-20	FA658		FA658V	FA658HH						
BN251	14-16	FA658		FA658V	FA658HH	N/A					
BN251	17-18	FA658		FA658V	FA658HH						
TRK 251	18-20	FA658		FA658V	FA658HH						
254	83	N/A				N/A					
302R	17-20	FA658*		FA658V*	FA658HH*	MD2003X	MD2003X	MD2003XC*			
302S	18-20	FA658*		FA658V*	FA658HH*	MD2003X	MD2003X	MD2003XC*			
BN302	15-16	FA658*		FA658V*	FA658HH*	MD2003X	MD2003X	MD2003XC*			
BN302	17-18	FA658*		FA658V*	FA658HH*	MD2003X	MD2003X	MD2003XC*			
TNT 300 (Tornado Naked 300cc)	16-18	FA658*		FA658V*	FA658HH*	MD2003X	MD2003X	MD2003XC*			
304	83	FA047			FA047HH	N/A					
Zenzero 350	12-16	SFA228	SFAC228		SFA228HH	N/A					
354	-82	FA047*			FA047HH*	N/A	N/A				
354 Sport 2	83	FA047*			FA047HH*	N/A	N/A				
Velvet 400 Dusk	03-04	SFA194	SFAC194		SFA194HH	TBA					
Imperiale 400	18-20	FA196			FA196HH						
402S	18	FA658*		FA658V*	FA658HH*						
BX Cross (449cc)	07-12	FA181TT		MXS181	FA181R			TBA			
500 4	76-	FA047*			FA047HH*	N/A	N/A				
Leoncino (500cc)	17-20				FA322/4HH*						
Leoncino Trail (500cc)	17-20				FA322/4HH*						
TRE-K 502	16	FA244*			FA244HH*						
TRK 502	17-20				FA322/4HH*						
TRK 502 X	17-20	FA209/2			FA209/2HH						
BX Enduro (505cc)	08-12	FA181TT		MXS181	FA181R	TBA					
BX 570 Motard	08-10				FA322/4HH	TBA					
BN 600 GT	14-17				FA322/4HH*	MD2003X	MD2003X	MD2003XC*			
BN 600i	14-17				FA322/4HH*	N/A	N/A				
BN 600 R	14-16				FA630HH*	N/A	N/A				
BN 600 S	14-15				FA630HH*	N/A	N/A				
654 Sport	83	FA047*			FA047HH*	N/A	N/A				
750 SEi (6 Cyl)	75-	FA018*		FA018V*	FA018HH*	MD837	MD837				
2UE 750	09-10	FA244*			FA244HH*	MD614X	MD614X	MD614XC*		VR614BLK*	
752S	18-20				FA322/4HH*						

FRONT / AVANT / VORN / FRENTE / ANTERIORE

R Suffix = High Durability Sintered Pad. HH Suffix = High Performance Sintered Pad. TT Suffix = Hard Wearing Off Road Pad. V Suffix = Semi Sintered Pad. G Suffix = Grooved Shoe.
D Suffix = Drilled Disc. X Suffix = Universal Left or Right Disc. XC Suffix = Contoured Disc. LS Suffix = Left/Steel Disc. RS = Right/Steel Disc.

*-2 Sets Required. † For Vee disc colours add RED, BLU, GRN, GLD, ORG suffix to part number.

⊗ - Also available as a Vintage Motorcycle Disc.

Non-JAPANESE Built Motorcycles

Line #	BRAKE DISC CHOICES - FRONT						DISC PAD CHOICES - REAR				BRAKE DISC CHOICES - REAR			
	Over-size 250 /280mm Disc Kit	OSX Over-size 250/280mm Disc Kit	Relocating Bracket for 250/ 280mm Disc	Over-size 320mm Disc Kit	SMX Over-size 320mm Disc Kit	Relocating Bracket for 320mm Disc	FA, SFA, TT Pad or Brake Shoe	SFAC Carbon Scooter Pads	Speciality Pads - SXR / Vee / MXS	Sintered/ HH Pads/ Grooved Shoes	Standard Replacement Disc	Contour Disc Rear fitment	Vee- Discs™ CONTOUR	CX Extreme MX Race Disc/ UTVX Disc
1							N/A							
2							FA629							
3							FA698							
4							SFA228	SFAC228		SFA228HH		N/A		
5							SFA193	SFAC193		SFA193HH	MD966D			
6							SFA298	SFAC298		SFA298HH	MD966D			
7														
8							FA629							
9							816							
10							SFA321	SFAC321		SFA321HH	MD9106D			
11							SFA228	SFAC228		SFA228HH	N/A			
12							SFA228	SFAC228		SFA228HH	N/A			
13							SFA228	SFAC228		SFA228HH	TBA			
14							FA047			FA047HH		N/A		
15							SFA193	SFAC193		SFA193HH	MD966D			
16							SFA298	SFAC298		SFA298HH	MD966D			
17							SFA228	SFAC228		SFA228HH		N/A		
18							FA629			FA629HH				
19							FA047TT					TBA		
20							FA298							
21							SFA413	SFAC413		SFA413HH	TBA			
22														
23							FA047			FA047HH		N/A		
24							SFA298	SFAC298		SFA298HH	MD966D		VR966	
25							929							
26							FA047			FA047HH	TBA			
27							FA698			FA698HH				
28							FA298				N/A			
29							FA698			FA698HH				
30							FA698			FA698HH				
31							929							
32							FA698			FA698HH				
33							FA698			FA698HH				
34							FA298				N/A			
35							FA698			FA698HH				
36							FA698			FA698HH				
37							929							
38							SFA083	SFAC083		SFA083HH	N/A			
39							FA018			FA018HH				
40							FA047			FA047HH	N/A			
41							SFA298	SFAC298		SFA298HH	TBA			
42							FA698			FA698HH				
43							FA698			FA698HH				
44							FA208TT		MXS208	FA208R		TBA		
45							929							
46							FA698			FA698HH				
47							FA698			FA698H				
48							FA266			FA266HH				
49							FA698			FA698HH				
50							FA698			FA698HH				
51							FA208TT		MXS208	FA208R	TBA			
52							FA208TT		MXS208	FA208R	TBA			
53							FA266			FA266HH	N/A			
54							FA266			FA266HH	N/A			
55							FA266			FA266HH	N/A			
56							FA266			FA266HH	N/A			
57							FA047			FA047HH	N/A			
58							N/A							
59							FA266		FA266V	FA266HH	TBA			
60							FA698		FA698V	FA698HH				

REAR / ARRIÈRE / HINTEN / POSTERIOR / POSTERIORE

R Suffix = High Durability Sintered Pad. **HH** Suffix = High Performance Sintered Pad. **TT** Suffix = Hard Wearing Off Road Pad. **V** Suffix = Semi Sintered Pad. **G** Suffix = Grooved Shoe.
D Suffix = Drilled Disc. **X** Suffix = Universal Left or Right Disc. **XC** Suffix = Contoured Disc. **LS** Suffix = Left/Steel Disc. **RS** = Right/Steel Disc.

*-2 Sets Required. † For Vee disc colours add RED, BLU, GRN, GLD, ORG suffix to part number.
 ☉ - Also available as a Vintage Motorcycle Disc.

Part numbers, prefixes, suffixes, photos and illustrations shown in this catalogue are trademarks and/or copyrights of EBC Brakes or the trademark owner A C Freeman Investments Ltd and use without express written permission of the owners is punishable by law.

Non-JAPANESE Built Motorcycles



BENELLI Contd.



DISC PAD CHOICES - FRONT

BRAKE DISC CHOICES - FRONT

R Suffix = High Durability Sintered Pad. **HH** Suffix = High Performance Sintered Pad. **TT** Suffix = Hard Wearing Off Road Pad. **V** Suffix = Semi Sintered Pad. **G** Suffix = Grooved Shoe.

D Suffix = Drilled Disc. **X** Suffix = Universal Left or Right Disc. **XC** Suffix = Contoured Disc. **LS** Suffix = Left/Steel Disc. **RS** = Right/Steel Disc.

		FA, SFA, TT Pad or Brake Shoe	SFAC Carbon Scooter Pads	Speciality Pads - SXR / Vee / MXS	Sintered/HH Pads/ Grooved Shoes	Left / Gauche / Links Standard Replacement Disc	Right / Droite / Rechts Standard Replacement Disc	Contour Disc Universal left and right fitment	Universal Custom Disc	Vee-Discs Black † See note below	CX Extreme MX Race Disc/ UTVX Disc	Line #	
800 Leoncino	20-21	FA244*			FA244HH*							1	
800 Trail	20-21	FA244*			FA244HH*							2	
Café Racer 899	10-12				FA322/4HH*			TBA*				3	
Century Racer 899	11-12				FA322/4HH*			TBA*				4	
TNT 899 Tornado Naked Tre	07-16	FA244*			FA244HH*	MD614X	MD614X	MD614XC*		VR614BLK*		5	
TNT 899 S Tornado Naked Tre	07-11	FA244*			FA244HH*	MD614X	MD614X	MD614XC*		VR614BLK*		6	
TRE-K 899	07-16	FA244*			FA244HH*	MD614X	MD614X	MD614XC*		VR614BLK*		7	
900 Sei (6 Cyl)	83	FA018*		FA018V*	FA018HH*	MD837	MD837					8	
Tornado 900	02	FA244*			FA244HH*	TBA	TBA					9	
Tornado Tre Novecento/LE/RS	03-05				FA322/4HH*	MD621X	MD621X	MD621XC*		VR621BLK*		10	
TNT 1130 Cafe Racer	05	FA244*			FA244HH*	MD621X	MD621X	MD621XC*		VR621BLK*		11	
TNT 1130 Cafe Racer	06-12				FA322/4HH*	MD621X	MD621X	MD621XC*		VR621BLK*		12	
TNT 1130 Sport/Sport.Evo	04-09				FA322/4HH*	MD621X	MD621X	MD621XC*		VR621BLK*		13	
TNT 1130 Titanium	05	FA244*			FA244HH*	MD621X	MD621X	MD621XC*		VR621BLK*		14	
TNT 1130 Titanium	06				FA322/4HH*	MD621X	MD621X	MD621XC*		VR621BLK*		15	
Tornado TRE 1130 (Radial caliper)	06-10				FA322/4HH*	MD621X	MD621X	MD621XC*		VR621BLK*		16	
Tornado Naked TRE R 160	09-12				FA322/4HH*	MD2003X	MD2003X	MD2003XC*				17	
Tornado Naked Tre TNT 1130	06-07	FA244*			FA244HH*	MD621X	MD621X	MD621XC*		VR621BLK*		18	
Tornado Naked Tre TNT 1130 R	13-16				FA447HH*	MD2003X	MD2003X	MD2003XC*				19	
TRE-K 1130	06-17	FA244*			FA244HH*	MD614X	MD614X	MD614XC*		VR614BLK*		20	
TRE-K 1130 Amazonas	07-15	FA244*			FA244HH*	MD2003X	MD2003X	MD2003XC*				21	
												22	
												23	
BETA													
Electric 16	18-19	CFA327			CFA327R							24	
Electric 20	18-19	CFA327			CFA327R							25	
Electric 20XL	18-19	CFA327			CFA327R							26	
Minicross Pro Race 12/10	04-06	FA351TT				N/A						27	
R 150 (Minicross /4T/49cc)	10-13	FA086			FA086HH	N/A						28	
ARK (Air Cooled Models)	96-14	SFA193	SFAC193		SFA193HH	MD901D				VR901		29	
ARK (LC Models)	97-14	SFA193	SFAC193		SFA193HH	MD901D				VR901		30	
Pro Race 50	05	FA115			FA115HH	N/A						31	
Quadra 50	97-01	SFA193	SFAC193		SFA193HH	MD901D				VR901		32	
Rev 50	00-08	FA115			FA115R	N/A						33	
50 RR Supermoto/Enduro	99-05	FA115			FA115HH	N/A						34	
RR Enduro Alu 50/Motard Alu 50	04-08	FA194			FA194HH	N/A						35	
RR 50 Standard	05-08	FA194			FA194HH	N/A						36	
RR 50 Enduro Racing	09-11	FA194			FA194HH	N/A						37	
RR 50 Enduro	04-07	FA194			FA194HH	N/A						38	
RR 50 Enduro	08-20	FA194			FA194HH	N/A						39	
RR 50 Enduro Factory	12-20	FA194			FA194HH	N/A						40	
RR 50 Enduro Standard	09-14	FA115TT			FA115R	N/A						41	
RR 50 Motard Standard	09-12	FA115TT			FA115R	N/A						42	
RR 50 Motard (Spoke Wheel)	09-12	FA194			FA194HH	N/A						43	
RR 50 Motard Skull	11	FA194			FA194HH	N/A						44	
RR Motard 50 Track (Cast Wheels)	08-14	FA194			FA194HH	N/A						45	
RR Motard 50 Track/Racing (Spoke Wheels)	14-20	FA194			FA194HH	N/A						46	
RR 50 Motard Standard (5 Spoke Cast Wheel)	13-14	FA194			FA194HH			N/A				47	
RR 50 Motard Sport (5 Spoke Cast Wheel)	14-20	FA194			FA194HH			N/A				48	
RR 50 Motard 50 (Spoke Wheel)	12-13	FA194			FA194HH			N/A				49	
RK6	93-96	FA167			FA167HH	MD6296D						50	
Tempo 16	94-97	SFA116				N/A						51	
Eickon 50	99-06	SFA115	SFAC115		SFA115HH	MD901D				VR901		52	
Minitrail 50 (A/C)	09-12	FA351TT				N/A						53	
Minitrail LC (Hydraulic Brakes)	13-15	FA351TT				N/A						54	
Minitrail Electric 20XL/20/16	14-20	CFA327	CFA327R		CFA327HH	N/A						55	
RK 50cc Enduro	97-02	FA167			FA167HH	N/A						56	
Tempo 50	98-02	SFA193	SFAC193		SFA193HH	MD901D				VR901		57	
Evo 80 Junior	09-20	FA115TT			FA115R	N/A						58	
Evo 80 Senior	09-20	FA303TT				N/A						59	
Rev 80	00-07	FA115			FA115R	N/A						60	

*-2 Sets Required. † For Vee disc colours add RED, BLU, GRN, GLD, ORG suffix to part number.

⊗ - Also available as a Vintage Motorcycle Disc.

Non-JAPANESE Built Motorcycles

Line #	BRAKE DISC CHOICES - FRONT						DISC PAD CHOICES - REAR				BRAKE DISC CHOICES - REAR			
	Oversize 250 /280mm Disc Kit	OSX Oversize 250/280mm Disc Kit	Relocating Bracket for 250/ 280mm Disc	Oversize 320mm Disc Kit	SMX Oversize 320mm Disc Kit	Relocating Bracket for 320mm Disc	FA, SFA, TT Pad or Brake Shoe	SFAC Carbon Scooter Pads	Speciality Pads - SXR / Vee / MXS	Sintered/ HH Pads/ Grooved Shoes	Standard Replacement Disc	Contour Disc Rear fitment	Vee-Discs™ CONTOUR	CX Extreme MX Race Disc/ UTVX Disc
1							FA266		FA266V	FA266HH				
2							FA266		FA266V	FA266HH				
3							FA266		FA266V	FA266HH		TBA		
4							FA266		FA266V	FA266HH		TBA		
5							FA266		FA266V	FA266HH	MD651			
6							FA266		FA266V	FA266HH	MD651			
7							FA266		FA266V	FA266HH	MD651			
8							FA077		FA077V		N/A			
9							FA266		FA266V	FA266HH	MD651			
10							FA266		FA266V	FA266HH	MD651			
11							FA266		FA266V	FA266HH	MD651			
12							FA266		FA266V	FA266HH	MD651			
13							FA266		FA266V	FA266HH	MD651			
14							FA266		FA266V	FA266HH	MD651			
15							FA266		FA266V	FA266HH	MD651			
16							FA266		FA266V	FA266HH	MD651			
17							FA266		FA266V	FA266HH		TBA		
18							FA266		FA266V	FA266HH	MD651			
19							FA266		FA266V	FA266HH		TBA		
20							FA266		FA266V	FA266HH	MD651			
21							FA266		FA266V	FA266HH		TBA		
22														
23														
24							CFA327			CFA327R				
25							CFA327			CFA327R				
26							CFA327			CFA327R				
27							FA351TT				N/A			
28							FA337TT			FA337R	N/A			
29							893							
30							SFA193	SFAC193		SFA193HH	MD901D		VR901	
31							FA351TT				N/A			
32							893							
33							FA115			FA115R	N/A			
34							FA115			FA115HH	N/A			
35							FA115			FA115HH	N/A			
36							FA115			FA115HH	N/A			
37							FA367/2TT			FA367/2R	N/A			
38							FA115			FA115HH	N/A			
39							FA367/2TT			FA367/2R	N/A			
40							FA367/2TT			FA367/2R	N/A			
41							FA367/2TT			FA367/2R	N/A			
42							FA367/2TT			FA367/2R	N/A			
43							FA367/2TT			FA367/2R	N/A			
44							FA367/2TT			FA367/2R	N/A			
45							FA367/2TT			FA367/2R	N/A			
46							FA367/2TT			FA367/2R	N/A			
47							FA367/2TT			FA367/2R	N/A			
48							FA367/2TT			FA367/2R	N/A			
49							FA367/2TT			FA367/2R	N/A			
50							FA116				N/A			
51							893							
52							FA115	SFAC115		SFA115HH	MD901D			
53							N/A				N/A			
54							N/A				N/A			
55							CFA327	CFA327R		CFA327HH	N/A			
56							FA115			FA115HH	N/A			
57							893							
58							FA115TT			FA115R	N/A			
59							FA403				N/A			
60							FA115			FA115R	N/A			

REAR / ARRIÈRE / HINTEN / POSTERIOR / POSTERIORE

R Suffix = High Durability Sintered Pad. **HH** Suffix = High Performance Sintered Pad. **TT** Suffix = Hard Wearing Off Road Pad. **V** Suffix = Semi Sintered Pad. **G** Suffix = Grooved Shoe.
D Suffix = Drilled Disc. **X** Suffix = Universal Left or Right Disc. **XC** Suffix = Contoured Disc. **LS** Suffix = Left/Steel Disc. **RS** = Right/Steel Disc.

*-2 Sets Required. † For Vee disc colours add RED, BLU, GRN, GLD, ORG suffix to part number.
 Ⓢ - Also available as a Vintage Motorcycle Disc.

Part numbers, prefixes, suffixes, photos and illustrations shown in this catalogue are trademarks and/or copyrights of EBC Brakes or the trademark owner A C Freeman Investments Ltd and use without express written permission of the owners is punishable by law.

Non-JAPANESE Built Motorcycles



BETA Contd.



DISC PAD CHOICES - FRONT

BRAKE DISC CHOICES - FRONT

R Suffix = High Durability Sintered Pad. **HH** Suffix = High Performance Sintered Pad. **TT** Suffix = Hard Wearing Off Road Pad. **V** Suffix = Semi Sintered Pad. **G** Suffix = Grooved Shoe.

D Suffix = Drilled Disc. **X** Suffix = Universal Left or Right Disc. **XS** Suffix = Contoured Disc. **LS** Suffix = Left/Steel Disc. **RS** = Right/Steel Disc.

FRONT / AVANT / VORN / FRENTE / ANTERIORE

		FA, SFA, TT Pad or Brake Shoe	SFAC Carbon Scooter Pads	Speciality Pads - SXR / Vee / MXS	Sintered/HH Pads/ Grooved Shoes	Left / Gauche / Links Standard Replacement Disc	Right / Droite / Rechts Standard Replacement Disc	Contour Disc Universal left and right fitment	Universal Custom Disc	Vee-Discs Black † See note below	CX Extreme MX Race Disc/ UTVX Disc	Line #
Rev 80	08	FA303TT				N/A						1
124 TR	80-83				841G							2
ALP 125 4T	98-04	FA115TT			FA115R	N/A						3
ALP 125 4T	05-15	FA194			FA194HH	N/A						4
Evo 125 (2T)	09-15	FA303TT			FA164R	N/A						5
Trial Evo 125 (2T) MY20	20	FA164										6
Rev 3 125/200	00-05	FA303TT			N/A	N/A						7
Rev 3 125/200	06-08	FA303TT				N/A						8
R 125 4T Mini Cross		SFA169	SFAC169		SFA169HH	N/A						9
RE 125 4T Enduro	09-10	FA194			FA194HH	N/A						10
RE 125 4T Enduro	10-14	FA115TT			FA115R	N/A						11
RR-S 125 CBS ZD3E9143 4T LC CBS	18-20	SFA324	SFAC324		SFA324HH							12
RR-S 125 CBS Motard ZD3E9143 4T LC CBS	18-20	SFA324	SFAC324		SFA324HH							13
Enduro RR 125 LC (2T) MY20	20-21	FA185TT		MXS185	FA185R							14
RR 125 4T Enduro (A/C)	09-14	FA194			FA194HH	N/A						15
RR 125 4T Enduro (L/C)	11-20	FA194			FA194HH	N/A						16
RR 125 4T Motard (A/C - Spoke Wheel)	08-14	FA194			FA194HH	N/A						17
RR 125 4T Motard (L/C - Cast Wheel)	11-20	FA194			FA194HH	N/A						18
RR 2T 125 RC	18-20	FA185TT		MXS185	FA185HH							19
TR 125	80-83				841G							20
TR 125 32/33	86-87	FA099				N/A						21
125 TR 34	88	FA115			FA115R	N/A						22
125 TR 34	89	FA115			FA115R	N/A						23
Eurotek/Techno 125/250	96-98	FA115			FA115R	N/A						24
Urban 125	08-15	FA194			FA194HH	N/A						25
Urban 125 Special	09-15	FA194			FA194HH	N/A						26
Eikon 125/150	00-06	SFA047			SFA047HH	MD924D				VR924		27
Jonathan 125	00-01	FA095			FA095HH		MD813					28
Jonathan 125	02-05	FA095			FA095HH		MD813					29
ALP 200 4T	00-04	FA115TT			FA115R	N/A						30
ALP 200 4T	05-20	FA194			FA194HH	N/A						31
Evo 200 (2T)	09-20	FA303TT				N/A						32
Trial Evo 200 (2T) MY20	20	FA164			FA164R							33
RR Enduro 200 (2T) MY20	20-21	FA185TT		MXS185	FA185R							34
Urban 200	08-15	FA194			FA194HH	N/A						35
Urban 200 Special	09-15	FA194			FA194HH		N/A					36
240 TR	80-83				841G							37
240 TR 32	84-85											38
240 TR 33	86	FA099				N/A						39
Evo 250 (2T)/Factory	09-20	FA303TT				N/A						40
Evo 250 (4T)	09-20	FA303TT				N/A						41
Rev 3 250/270	00-04	FA303TT			N/A	N/A						42
Rev 3 250/270	05-08	FA303TT			N/A	N/A						43
Rev 4T 250	07-08	FA303TT				N/A						44
RR 250 4T Enduro	05-07	FA185TT		MXS185	FA185R			MD6367C				45
RR 250 Enduro (2T)	13-14	FA185TT		MXS185	FA185R	MD6032D		MD6032C			MD6032CX	46
RR 250 Enduro (2T) RC	18-20	FA185TT		MXS185	FA185R	MD6032D		MD6032C			MD6032CX	47
Enduro RR 250 (2T) MY20	20-21	FA185TT		MXS185	FA185R	MD6032D					MD6032CX	48
Trial Evo 250 (2T) MY20	20	FA164			FA164R							49
Trial Evo 250 (2T) MY20 GB	20	FA164			FA164R							50
RR 250 Racing (2T)	15	FA185TT		MXS185	FA185R	MD6032D		MD6032C			MD6032CX	51
250 X-Trainer (2T)	20-21	FA185TT		MXS185	FA185R	MD6032D					MD6032CX	52
TR 34	86-88	FA099				N/A						53
TR 34	86	FA099				N/A						54
TR 34 260	89-91	FA099				N/A						55
SYNT	92	FA115TT			FA115R	N/A						56
Zero	92	FA115TT			FA115R	N/A						57
SYNT/GARA	93-95	FA115TT			FA115R	N/A						58
Super Trial ST	94	FA115TT			FA115R	N/A						59
												60

*-2 Sets Required. † For Vee disc colours add RED, BLU, GRN, GLD, ORG suffix to part number.

⊗ - Also available as a Vintage Motorcycle Disc.

Non-JAPANESE Built Motorcycles

Line #	BRAKE DISC CHOICES - FRONT						DISC PAD CHOICES - REAR				BRAKE DISC CHOICES - REAR			
	Over-size 250 /280mm Disc Kit	OSX Over-size 250/280mm Disc Kit	Relocating Bracket for 250/ 280mm Disc	Over-size 320mm Disc Kit	SMX Over-size 320mm Disc Kit	Relocating Bracket for 320mm Disc	FA, SFA, TT Pad or Brake Shoe	SFAC Carbon Scooter Pads	Speciality Pads - SXR / Vee / MXS	Sintered/ HH Pads/ Grooved Shoes	Standard Replacement Disc	Contour Disc Rear fitment	Vee-Discs™ CONTOUR	CX Extreme MX Race Disc/ UTVX Disc
1							FA403				N/A			
2									841G					
3							FA115TT		FA115R	N/A				
4							FA367/2TT		FA367/2R	N/A				
5							FA495			N/A				
6							FA495							
7							FA303TT		N/A	N/A				
8							FA403			N/A				
9							FA115		FA115HH	N/A				
10							FA367/2TT		FA367/2R	N/A				
11							FA367/2TT		FA367/2R	N/A				
12							FA367/2TT		FA367/2R					
13							FA367/2TT		FA367/2R					
14							FA367/2TT		FA367/2R					
15							FA367/2TT		FA367/2R	N/A				
16							FA367/2TT		FA367/2R	N/A				
17							FA367/2TT		FA367/2R	N/A				
18							FA367/2TT		FA367/2R	N/A				
19							FA367/2TT		FA367/2R					
20									841G					
21									841G					
22							FA116		N/A	N/A				
23							FA115		FA115R					
24							FA115		FA115R	N/A				
25							FA367/2TT		FA367/2R	N/A				
26							FA367/2TT		FA367/2R		N/A			
27							SFA298		SFA298HH	MD909D				
28							FA213		FA213HH	N/A				
29							FA173			N/A				
30							FA115TT		FA115R	N/A				
31							FA367/2TT		FA367/2R	N/A				
32							FA495			N/A				
33							FA495							
34							FA367/2TT		FA367/2R					
35							FA367/2TT		FA367/2R	N/A				
36							FA367/2TT		FA367/2R		N/A			
37									841G					
38									841G					
39									841G					
40							FA495			N/A				
41							FA495			N/A				
42							FA303TT		N/A	N/A				
43							FA403		N/A	N/A				
44							FA403			N/A				
45							FA367/2TT		FA367/2R		MD6368C			
46		OSX6032E				BRK015	FA367/2TT		FA367/2R	MD6269D	MD6269C			
47		OSX6032E				BRK015	FA367/2TT		FA367/2R	MD6269D	MD6269C			
48		OSX6032E				BRK015	FA367/2TT		FA367/2R	MD6269D	MD6269C			
49							FA495TT							
50							FA495TT							
51		OSX6032E				BRK015	FA367/2TT		FA367/2R	MD6269D	MD6269C			
52		OSX6032E				BRK015	FA367/2TT		FA367/2R	MD6269D	MD6269C			
53							FA116		N/A	N/A				
54							FA116		N/A	N/A				
55							FA164		FA164R	N/A				
56							FA164		FA164R	N/A				
57							FA164		FA164R	N/A				
58							FA156		N/A	N/A				
59							FA164		FA164R	N/A				
60														

REAR / ARRIÈRE / HINTEN / POSTERIOR / POSTERIORE

R Suffix = High Durability Sintered Pad. **HH** Suffix = High Performance Sintered Pad. **TT** Suffix = Hard Wearing Off Road Pad. **V** Suffix = Semi Sintered Pad. **G** Suffix = Grooved Shoe.
D Suffix = Drilled Disc. **X** Suffix = Universal Left or Right Disc. **XC** Suffix = Contoured Disc. **LS** Suffix = Left/Steel Disc. **RS** = Right/Steel Disc.

*-2 Sets Required. † For Vee disc colours add RED, BLU, GRN, GLD, ORG suffix to part number.
 ☉ - Also available as a Vintage Motorcycle Disc.

Part numbers, prefixes, suffixes, photos and illustrations shown in this catalogue are trademarks and/or copyrights of EBC Brakes or the trademark owner A C Freeman Investments Ltd and use without express written permission of the owners is punishable by law.

Non-JAPANESE Built Motorcycles



BETA Contd.



DISC PAD CHOICES - FRONT

BRAKE DISC CHOICES - FRONT

		FA, SFA, TT Pad or Brake Shoe	SFAC Carbon Scooter Pads	Speciality Pads - SXR / Vee / MXS	Sintered/HH Pads/ Grooved Shoes	Left / Gauche / Links Standard Replacement Disc	Right / Droite / Rechts Standard Replacement Disc	Contour Disc Universal left and right fitment	Universal Custom Disc	Vee-Discs Black † See note below	CX Extreme MX Race Disc/ UTVX Disc	Line #
Techno	95	FA115TT			FA115R	N/A						1
Enduro RR 300 (2T) MY20	20-21	FA185TT		MXS185	FA185R	MD6032D					MD6032CX	2
Evo 300 (2T)	09-20	FA303TT				N/A						3
Evo 300 (4T)	09-20	FA303TT				N/A						4
Trial Evo 300 (2T) MY20 Inc GB and SS	20	FA164			FA164R							5
RR 300 Enduro (2T)	13-14	FA185TT		MXS185	FA185R	MD6032D					MD6032CX	6
RR 300 Enduro (2T) RC	20-21	FA185TT		MXS185	FA185R	MD6032D					MD6032CX	7
RR 300 Racing (2T)	15	FA185TT		MXS185	FA185R	MD6032D		MD6032C			MD6032CX	8
300 X-Trainer (2T)	15-21	FA185TT		MXS185	FA185R	MD6032D		N/A			MD6032CX	9
ALP 4.0 (4T/349cc)	05-15	FA194			FA194HH	N/A						10
Enduro RR-S 350 (4T) MY20	20-21	FA185TT		MXS185	FA185R	MD6032D		MD6032C				11
Euro 350	00-01	FA126			FA126HH		MD813					12
Euro 350	02	FA126			FA126HH		MD813					13
Euro 350	03-06	FA095			FA095HH		MD813					14
Jonathan 350	03-06	FA095			FA095HH		N/A					15
M4 350 Supermotard	04-06	FA426				N/A						16
M4 350 Motard	07-15	FA426				N/A						17
RR 350 4T Enduro	11	FA185TT		MXS185	FA185R			MD6367C				18
RR 350 4T Enduro	12-14	FA185TT		MXS185	FA185R	MD6032D		MD6032C			MD6032CX	19
RR 350 EFI (4T)	15	FA185TT		MXS185	FA185R	MD6032D		MD6032C			MD6032CX	20
Enduro RR-S 350 (4T) MY20	13-20	FA185TT		MXS185	FA185R	MD6032D		MD6032C			MD6032CX	21
Enduro RR-S 350 (4T) MY20 (260mm front disc)	20-21	FA185TT		MXS185	FA185R			N/A				22
RR 350 Racing 4T	15	FA185TT		MXS185	FA185R	MD6032D		MD6032C			MD6032CX	23
Enduro RR 390 (4T) MY20	20-21	FA185TT		MXS185	FA185R	MD6032D					MD6032CX	24
RR 390 (4T)	15-20	FA185TT		MXS185	FA185R	MD6032D		MD6032C			MD6032CX	25
RR 400 4T Enduro	05-11	FA185TT		MXS185	FA185R			MD6367C				26
RR 400 4T Enduro	12-14	FA185TT		MXS185	FA185R	MD6032D		MD6032C			MD6032CX	27
Enduro RR 430 (4T) MY20	20-21	FA185TT		MXS185	FA185R	MD6032D		MD6032C			MD6032CX	28
RR 430 (4T)	15	FA185TT		MXS185	FA185R	MD6032D		MD6032C			MD6032CX	29
RR-S 430 4T Racing	15-21	FA185TT		MXS185	FA185R	MD6032D		N/A			MD6032CX	30
RR 450 4T Enduro	05-11	FA185TT		MXS185	FA185R			MD6367C				31
RR 450 4T Enduro	12-14	FA185TT		MXS185	FA185R	MD6032D		MD6032C			MD6032CX	32
RR 450 4T Enduro Racing	13-20	FA185TT		MXS185	FA185R	MD6032D		MD6032C			MD6032CX	33
RR 450 4T Cross Country	12	FA185TT		MXS185	FA185R	MD6032D		MD6032C			MD6032CX	34
Enduro RR 480 (4T) MY20	20	FA185TT		MXS185	FA185R	MD6032D		MD6032C			MD6032CX	35
RR 480 (4T)	15	FA185TT		MXS185	FA185R	MD6032D		MD6032C			MD6032CX	36
RR 480 4T Racing	15-20	FA185TT		MXS185	FA185R	MD6032D		MD6032C			MD6032CX	37
RR 498 4T Enduro	12-20	FA185TT		MXS185	FA185R	MD6032D		MD6032C			MD6032CX	38
RR 498 4T Enduro Racing	13-14	FA185TT		MXS185	FA185R	MD6032D		MD6032C			MD6032CX	39
500 RR-S 4T	20-21	FA185TT		FA185R	MXS185	MD6032D					MD6032CX	40
RR 520 4T Enduro	10-11	FA185TT		MXS185	FA185R			MD6367C				41
RR 525 4T Enduro	05-09	FA185TT		MXS185	FA185R			MD6367C				42
♦ Remove old speedo pick up magnet from old disc and refit to new EBC disc.												43
BETTER												44
BT 125-20	06-09	FA486				N/A						45
BIMOTA												46
All early models	-88	FA018*			FA018HH*	N/A	N/A					47
All models (Single pin fixing)	89-	FA095*			FA095HH*	N/A	N/A					48
Later models (Twin pin fixing)	98/99-	FA244*			FA244HH*	N/A	N/A					49
Delirio	06				FA322/4HH*	N/A	N/A					50
DB5 (All models)	06-07				FA322/4HH*	MD2003X	MD2003X	MD2003XC*				51
DB5 Desiderio (1078cc)	12-14				FA322/4HH*	N/A	N/A					52
DB5R	06-13				FA322/4HH*	TBA	TBA					53
DB6 Delirio (992cc) Ducati engine	07				FA322/4HH*	MD2003X	MD2003X		MD2003XC	MD2003XC		54
SB8K Gobert (Suzuki Engine) (996cc)	06	FA244*			FA244HH*	MD2003X	MD2003X		MD2003XC	MD2003XC		55
SB8K Santamonica (Suzuki Engine) (996cc)					FA322/4HH*	MD621X	MD621X	MD621XC*		VR621BLK*		56
Tesi 2D (Ducati) 992cc	04-06	FA095*			FA095HH*	N/A	N/A					57
Tesi-3D (1078cc)	09-13				FA322/4HH*	N/A	N/A					58

*-2 Sets Required. † For Vee disc colours add RED, BLU, GRN, GLD, ORG suffix to part number.

♦ - Also available as a Vintage Motorcycle Disc.

Non-JAPANESE Built Motorcycles

Line #	BRAKE DISC CHOICES - FRONT						DISC PAD CHOICES - REAR				BRAKE DISC CHOICES - REAR			
	OverSize 250 /280mm Disc Kit	OSX OverSize 250/280mm Disc Kit	Relocating Bracket for 250/ 280mm Disc	OverSize 320mm Disc Kit	SMX OverSize 320mm Disc Kit	Relocating Bracket for 320mm Disc	FA, SFA, TT Pad or Brake Shoe	SFAC Carbon Scooter Pads	Speciality Pads - SXR / Vee / MXS	Sintered/ HH Pads/ Grooved Shoes	Standard Replacement Disc	Contour Disc Rear fitment	Vee-Discs™ CONTOUR	CX Extreme MX Race Disc/ UTVX Disc
1							FA156			N/A	N/A			
2		OSX6032E				BRK015	FA367/2TT			FA367/2R	MD6269D	MD6269C		
3							FA495				N/A			
4							FA495				N/A			
5							FA495TT							
6		OSX6032E				BRK015	FA367/2TT			FA367/2R	MD6269D	MD6269C		
7		OSX6032E				BRK015	FA367/2TT			FA367/2R	MD6269D	MD6269C		
8		OSX6032E				BRK015	FA367/2TT			FA367/2R	MD6269D	MD6269C		
9		OSX6032E				BRK015	FA367/2TT			FA367/2R	MD6269D	MD6269C		
10							FA367/2TT			FA367/2R	N/A			
11		OSX6032E				BRK015	FA367/2TT			FA367/2R	MD6269D	MD6269C		
12							FA213			FA213HH	N/A			
13							FA173				N/A			
14							FA101				N/A			
15							FA101				N/A			
16							FA37TT				N/A			
17							FA367/2TT				N/A			
18							FA367/2TT			FA367/2R		MD6368C		
19		OSX6032E				BRK015	FA367/2TT			FA367/2R	MD6269D	MD6269C		
20		OSX6032E				BRK015	FA367/2TT			FA367/2R	MD6269D	MD6269C		
21		OSX6032E				BRK015	FA367/2TT			FA367/2R	MD6269D	MD6269C		
22							FA367/2TT			FA367/2R		N/A		
23		OSX6032E				BRK015	FA367/2TT			FA367/2R	MD6269D	MD6269C		
24		OSX6032E				BRK015	FA367/2TT			FA367/2R	MD6269D	MD6269C		
25		OSX6032E				BRK015	FA367/2TT			FA367/2R	MD6269D	MD6269C		
26							FA367/2TT			FA367/2R		MD6368C		
27		OSX6032E				BRK015	FA367/2TT			FA367/2R	MD6269D	MD6269C		
28		OSX6032E				BRK015	FA367/2TT			FA367/2R	MD6269D	MD6269C		
29		OSX6032E				BRK015	FA367/2TT			FA367/2R	MD6269D	MD6269C		
30		OSX6032E				BRK015	FA367/2TT			FA367/2R	MD6269D	MD6269C		
31							FA367/2TT			FA367/2R		MD6368C		
32		OSX6032E				BRK015	FA367/2TT			FA367/2R	MD6269D	MD6269C		
33		OSX6032E				BRK015	FA367/2TT			FA367/2R	MD6269D	MD6269C		
34		OSX6032E				BRK015	FA367/2TT			FA367/2R	MD6269D	MD6269C		
35		OSX6032E				BRK015	FA367/2TT			FA367/2R	MD6269D	MD6269C		
36		OSX6032E				BRK015	FA367/2TT			FA367/2R	MD6269D	MD6269C		
37		OSX6032E				BRK015	FA367/2TT			FA367/2R	MD6269D	MD6269C		
38		OSX6032E				BRK015	FA367/2TT			FA367/2R	MD6269D	MD6269C		
39		OSX6032E				BRK015	FA367/2TT			FA367/2R	MD6269D	MD6269C		
40		OSX6032E				BRK015	FA367/2TT			FA367/2R	MD6269D	MD6269C		
41							FA367/2TT			FA367/2R		MD6368C		
42							FA367/2TT			FA367/2R		MD6368C		
43														
44														
45														
46							TBA							
47														
48														
49							FA018			FA018HH	N/A			
50							FA047			FA047HH	N/A			
51							FA047			FA047HH	N/A			
52							FA266		FA266V	FA266HH	N/A			
53							FA266		FA266V	FA266HH	N/A			
54							FA266		FA266V	FA266HH	N/A			
55							FA266		FA266V	FA266HH	TBA			
56							FA266		FA266V	FA266HH	TBA			
57							FA047			FA047HH	TBA			
58							FA047			FA047HH	TBA			
59							FA047			FA047HH	N/A			
60							FA047			FA047HH	N/A			

REAR / ARRIÈRE / HINTEN / POSTERIOR / POSTERIORE

R Suffix = High Durability Sintered Pad. **HH** Suffix = High Performance Sintered Pad. **TT** Suffix = Hard Wearing Off Road Pad. **V** Suffix = Semi Sintered Pad. **G** Suffix = Grooved Shoe.
D Suffix = Drilled Disc. **X** Suffix = Universal Left or Right Disc. **XC** Suffix = Contoured Disc. **LS** Suffix = Left/Steel Disc. **RS** = Right/Steel Disc.

*-2 Sets Required. † For Vee disc colours add RED, BLU, GRN, GLD, ORG suffix to part number.
 Ⓢ - Also available as a Vintage Motorcycle Disc.

Part numbers, prefixes, suffixes, photos and illustrations shown in this catalogue are trademarks and/or copyrights of EBC Brakes or the trademark owner A C Freeman Investments Ltd and use without express written permission of the owners is punishable by law.

Non-JAPANESE Built Motorcycles



BIMOTA Contd.



DISC PAD CHOICES - FRONT

BRAKE DISC CHOICES - FRONT

R Suffix = High Durability Sintered Pad. **HH** Suffix = High Performance Sintered Pad. **TT** Suffix = Hard Wearing Off Road Pad. **V** Suffix = Semi Sintered Pad. **G** Suffix = Grooved Shoe.
D Suffix = Drilled Disc. **X** Suffix = Universal Left or Right Disc. **XC** Suffix = Contoured Disc. **LS** Suffix = Left/Steel Disc. **RS** = Right/Steel Disc.

FRONT / AVANT / VORN / FRENTE / ANTERIORE

		FA, SFA, TT Pad or Brake Shoe	SFAC Carbon Scooter Pads	Speciality Pads - SXR / Vee / MXS	Sintered/HH Pads/ Grooved Shoes	Left / Gauche / Links Standard Replacement Disc	Right / Droite / Rechts Standard Replacement Disc	Contour Disc Universal left and right fitment	Universal Custom Disc	Vee-Discs Black † See note below	CX Extreme MX Race Disc/ UTVX Disc	Line #
DB5R/S (1078cc)	08-09				FA322/4HH*	N/A	N/A					1
DB6 (1078cc)	08-09				FA322/4HH*	N/A	N/A					2
DB6 (1100cc)	08				FA322/4HH*	N/A	N/A					3
DB6 (1100cc)	12-13				FA322/4HH*			N/A				4
DB6/R (1078cc)	08-09				FA322/4HH*	N/A	N/A					5
DB6R Delirio (1100cc)	08				FA322/4HH*	MD2003X	MD2003X			MD2003XC	MD2003XC	6
DB7 (1098cc)	08				FA322/4HH*	TBA	TBA					7
DB7 (1099cc)	09-14				FA447HH*	N/A	N/A					8
DB8 (1198cc)	10-14				FA447HH*	N/A	N/A					9
DB8 SP (1198cc)	10-13				FA447HH*	N/A	N/A					10
DB9 Brivido (1198cc)	12-14				FA322/4HH*	N/A	N/A					11
DB9 Brivido S (6 Piston BCA Caliper/1198cc)	12-14				FA322/4HH*	N/A	N/A					12
DB10 Motard (1078cc)	12-14				FA322/4HH*			N/A*				13
DB11 VLX (1198cc)	12-14				FA322/4HH*	N/A	N/A					14
DBX 1100	12-14	FA209/2*			FA209/2HH*	N/A	N/A					15
DB12 B. Tourist (1198cc)	12-13				FA322/4HH*	N/A	N/A					16
												17
												18
BLANEY (Quads)												19
XC 125 Trojan	03-04	TBA*										20
XL 200 Trooper	03-04	TBA*										21
												22
BLATA												23
Enduro 125	07-08	FA399				N/A						24
Motard 125	07-08	FA399				N/A						25
												26
BMW												27
C Evolution Electric	18-20	SFA142*			SFA142HH*							28
C1 125	99-03	SFA209/2			SFA209/2HH	MD968D				VR968		29
C1 200	01-03	SFA209/2			SFA209/2HH	MD968D				VR968		30
G 310 R	17-21	FA606			FA606HH	MD881						31
G 310 GS	17-21	FA606			FA606HH	MD881						32
G 310 GS edition 40	20-21	FA606			FA606HH	MD881						33
C 400 X	18-20	FA606			FA606HH	MD671	MD671					34
C 400 GT	18-20	FA606			FA606HH							35
G 450 X	08-11	FA181TT		MXS181	FA181R			MD6343C				36
C 600 Sport Scooter	12-15	SFA142*	SFAC142*		SFA142HH*	MD9182D	MD9182D					37
C 600 Sport Scooter - Parking brake	13-15	SFA257/2										38
C 600 Sport Highline Scooter	13-15	SFA142*	SFAC142*		SFA142HH*	MD9182D	MD9182D					39
C 600 Sport Highline Scooter - Parking brake	13-15	SFA257/2										40
C 600 Evolution Scooter	14-20	SFA142*	SFAC142*		SFA142HH*	MD9182D	MD9182D					41
C 600 Evolution Scooter - Parking brake	14-20	SFA257/2										42
C 650 GT Scooter	12-20	SFA142*	SFAC142*		SFA142HH*	MD9182D	MD9182D					43
C 650 GT Scooter - Parking brake	12-20	SFA257/2										44
C 650 GT Highline Scooter	13-18	SFA142*	SFAC142*		SFA142HH*	MD9182D	MD9182D					45
C 650 GT Highline Scooter - Parking brake	13-18	SFA257/2										46
C 650 Sport Scooter	16-20	SFA142*	SFAC142*		SFA142HH*	MD9182D	MD9182D					47
C 650 Sport Scooter - Parking brake	16-20	SFA257/2										48
G 650 Xchallenge	07-09	FA209/2		FA209/2V	FA209/2HH	MD809		MD809C				49
G 650 Xmoto (Cast wheel)	07-09	FA244		FA244V	FA244HH	MD621X		MD621XC		VR621BLK		50
G 650 Xcountry	07-09	FA209/2		FA209/2V	FA209/2HH	MD809		MD809C				51
G 650 GS												52
(R131/Single cylinder/chain drive/Cast Wheels)	09-15	FA209/2		FA209/2V	FA209/2HH	MD834						53
G 650 GS Sertao												54
(Single cylinder/chain drive/Spoke Wheels)	12-14	FA209/2		FA209/2V	FA209/2HH	MD834X						55
F 650 (E169/0161/Standard)	09/93-96	FA209/2		FA209/2V	FA209/2HH	MD650⊗						56
F 650 (E169/0162/Funduro												57
/High Screen/19" Front Wheel)	97-00	FA209/2		FA209/2V	FA209/2HH	MD650⊗						58
F 650 CS/Scarver K14/0174/0184												59
/Belt drive/17" Cast Wheels)	00-03	FA209/2		FA209/2V	FA209/2HH		MD834⊗					60

*-2 Sets Required. † For Vee disc colours add RED, BLU, GRN, GLD, ORG suffix to part number.

⊗ - Also available as a Vintage Motorcycle Disc.

Non-JAPANESE Built Motorcycles

Line #	BRAKE DISC CHOICES - FRONT						DISC PAD CHOICES - REAR				BRAKE DISC CHOICES - REAR			
	Oversize 250 /280mm Disc Kit	OSX Oversize 250/280mm Disc Kit	Relocating Bracket for 250/ 280mm Disc	Oversize 320mm Disc Kit	SMX Oversize 320mm Disc Kit	Relocating Bracket for 320mm Disc	FA, SFA, TT Pad or Brake Shoe	SFAC Carbon Scooter Pads	Speciality Pads - SXR / Vee / MXS	Sintered/ HH Pads/ Grooved Shoes	Standard Replacement Disc	Contour Disc Rear fitment	Vee-Discs™ CONTOUR	CX Extreme MX Race Disc/ UTVX Disc
1							FA047			FA047HH	N/A			
2							FA047			FA047HH	N/A			
3							FA266		FA266V	FA266HH	TBA			
4							FA047			FA047HH		N/A		
5							FA047			FA047HH	N/A			
6							FA266		FA266V	FA266HH	TBA			
7							FA266		FA266V	FA266HH	TBA			
8							FA047			FA047HH	N/A			
9							FA266		FA266V	FA266HH	N/A			
10							FA047			FA047HH	N/A			
11							FA266		FA266V	FA266HH	N/A			
12							FA266		FA266V	FA266HH	N/A			
13							FA047			FA047HH		N/A		
14							FA266		FA266V	FA266HH		N/A		
15							FA209/2			FA209/2HH		N/A		
16							FA266		FA266V	FA266HH		N/A		
17														
18														
19							FA083TT			FA083R	N/A			
20							FA165TT			FA165R	N/A			
21														
22														
23							FA115				TBA			
24							FA115				TBA			
25														
26														
27							SFA196			SFA196HH				
28							SFA213			SFA213HH	MD968D	VR968		
29							SFA213			SFA213HH	MD968D	VR968		
30							FA213			FA213HH	MD882			
31							FA213			FA213HH	MD882			
32							FA213			FA213HH	MD882			
33							FA213			FA213HH	MD671			
34							FA213			FA213HH	MD671			
35		OSX6343	BRK011		SMX6343	BRK012	FA368TT		MXS368	FA368R	MD6342D	MD6342C		
36							SFA196	SFAC196		SFA196HH	MD9182D			
37														
38							SFA196	SFAC196		SFA196HH	MD9182D			
39														
40							SFA196	SFAC196		SFA196HH	MD9182D			
41														
42							SFA196	SFAC196		SFA196HH	MD9182D			
43														
44							SFA196	SFAC196		SFA196HH	MD9182D			
45														
46							SFA196	SFAC196		SFA196HH	MD9182D			
47														
48							FA213		FA213V	FA213HH	MD810	MD810C		
49							FA213		FA213V	FA213HH	MD845			
50							FA213		FA213V	FA213HH	MD810	MD810C		
51														
52							FA213		FA213V	FA213HH	MD651			
53														
54							FA213		FA213V	FA213HH	MD651			
55							FA213		FA213V	FA213HH	MD651			
56														
57							FA213		FA213V	FA213HH	MD651			
58														
59							FA213		FA213V	FA213HH	MD651			
60														

REAR / ARRIÈRE / HINTEN / POSTERIOR / POSTERIORE

R Suffix = High Durability Sintered Pad. HH Suffix = High Performance Sintered Pad. TT Suffix = Hard Wearing Off Road Pad. V Suffix = Semi Sintered Pad. G Suffix = Grooved Shoe.
D Suffix = Drilled Disc. X Suffix = Universal Left or Right Disc. XC Suffix = Contoured Disc. LS Suffix = Left/Steel Disc. RS = Right/Steel Disc.

*-2 Sets Required. † For Vee disc colours add RED, BLU, GRN, GLD, ORG suffix to part number.
⊗ - Also available as a Vintage Motorcycle Disc.

Part numbers, prefixes, suffixes, photos and illustrations shown in this catalogue are trademarks and/or copyrights of EBC Brakes or the trademark owner A C Freeman Investments Ltd and use without express written permission of the owners is punishable by law.

Non-JAPANESE Built Motorcycles



BMW Contd.



DISC PAD CHOICES - FRONT

BRAKE DISC CHOICES - FRONT

	FA, SFA, TT Pad or Brake Shoe	SFAC Carbon Scooter Pads	Speciality Pads - SXR / Vee / MXS	Sintered/HH Pads/ Grooved Shoes	Left / Gauche / Links Standard Replacement Disc	Right / Droite / Rechts Standard Replacement Disc	Contour Disc Universal left and right fitment	Universal Custom Disc	Vee-Discs Black † See note below	CX Extreme MX Race Disc/ UTVX Disc
F 650 CS/Scarver K14/0177/0187										
/Belt drive/17" Cast Wheels)	04-07	FA209/2		FA209/2V	FA209/2HH		MD834Ⓞ			
F 650 GS (R13/0172/0182/Single Cylinder/19" Front Wheel)	99-03	FA209/2		FA209/2V	FA209/2HH	MD834Ⓞ				
F 650 GS (R13/0175/0185 /Single Cylinder/19" Front Wheel)	04-07	FA209/2		FA209/2V	FA209/2HH	MD834Ⓞ				
F 650 GS (K72/0218/0228 /Twin cylinder 798cc/Cast wheel)	07-12	FA209/2		FA209/2V	FA209/2HH	MD834X	MD834X			
F 650 GS (30 Years GS/Twin cylinder 798cc/Cast wheel)	11	FA209/2		FA209/2V	FA209/2HH		MD834Ⓞ			
F 650 GS Dakar (R13/0173/0183 /Single Cylinder/ 21" front wheel)	99-03	FA209/2		FA209/2V	FA209/2HH	MD834Ⓞ				
F 650 GS Dakar (R13/0176/0186 /Single Cylinder/ 21" front wheel)	04-07	FA209/2		FA209/2V	FA209/2HH	MD834Ⓞ				
F 650 ST (E169/0163/0168/Strada /Low Screen/18" Front Wheel)	97-00	FA209/2		FA209/2V	FA209/2HH	MD650Ⓞ				
F 700 GS	13-18	FA209/2*		FA209/2V*	FA209/2HH*	MD834X	MD834X			
F 750 GS	16-20	FA209/2*		FA209/2V*	FA209/2HH*	MD687	MD687			
F 750 GS Edition 40	20-21	FA209/2*		FA209/2V*	FA209/2HH*	MD687	MD687			
F 800 GT	13-20	FA244*		FA244V*	FA244HH*	N/A	N/A			
F 800 GS	08-18	FA209/2*		FA209/2V*	FA209/2HH*	MD834X	MD834X			
F 800 GS Adventure	12-18	FA209/2*		FA209/2V*	FA209/2HH*	MD834X	MD834X			
F 800 GS (30 Years GS)	11	FA209/2*		FA209/2V*	FA209/2HH*	MD834X	MD834X			
F 800 GS Triple Black	12	FA209/2*		FA209/2V*	FA209/2HH*	MD834X	MD834X			
F 800 GS Trophy	12-18	FA209/2*		FA209/2V*	FA209/2HH*	MD834X	MD834X			
F 800 R (Disc has fixed bobbins)	09-13	FA244*		FA244V*	FA244HH*	MD804	MD804			
F 800 R K73 (Disc has fixed bobbins)	14-20				FA630HH*	MD804	MD804			
F 800 R Sport K73 (Disc has fixed bobbins)	15				FA630HH*	MD804	MD804			
F 800 R Chris Pfeiffer Edition (Disc has fixed bobbins)	09-11	FA244*		FA244V*	FA244HH*	MD804	MD804			
F 800 S (Half fairing/Disc has loose bobbins)	06-08	FA244*		FA244V*	FA244HH*	MD803	MD803			
F 800 S (Half fairing/Disc has fixed bobbins)	08-17	FA244*		FA244V*	FA244HH*	MD804	MD804			
F 800 ST (Full fairing/Disc has loose bobbins)	06-08	FA244*		FA244V*	FA244HH*	MD803	MD803			
F 800 ST (Full fairing/Disc has fixed bobbins)	08-12	FA244*		FA244V*	FA244HH*	MD804	MD804			
F 800 ST (Touring/Disc has fixed bobbins)	10-17	FA244*		FA244V*	FA244HH*	MD804	MD804			
F 850 GS	16-20	FA209/2*		FA209/2*	FA209/2HH*	MD687	MD687			
F 850 GS Edition 40	20-21	FA209/2*	FA209/2V*	FA209/2*	FA209/2HH*	MD687	MD687			
F 850 GS Adventure	16-20	FA209/2*	FA209/2V*	FA209/2*	FA209/2HH*	MD687	MD687			
F 850 GS Adventure Edition 40	20-21	FA209/2*	FA209/2V*	FA209/2*	FA209/2HH*	MD687	MD687			
F900 R	20				FA630HH*	MD804	MD804			
F900 XR	20				FA630HH*	MD804	MD804			
HP2 Enduro	05-09	FA209/2		FA209/2V	FA209/2HH	MD687				
HP2 Megamoto (Disc has fixed bobbins)	07-10				FA335HH*	MD804	MD804			
HP2 Sport (Disc has fixed bobbins)	08-11				FA447HH*	MD804	MD804			
HP4	13-14				FA447HH*	MD862X	MD862X			
HP4 Carbon	13-14				FA447HH*	MD862X	MD862X			
HP4 Race	19-20				FA447HH*					
K75/75-S (Non ABS)	84-08/88	FA018*		FA018V*	FA018HH*	MD604LS	MD604RS			
K75/75-2 (Non ABS)	84-07/90	FA018*		FA018V*	FA018HH*	MD603LS	MD603RS			
K75/75-2 (Non ABS)	09/88-96	FA171*		FA171V*	FA171HH*	MD604LS	MD604RS			
K75/75-S (ABS Model)	08/90-96	FA171*		FA171V*	FA171HH*	MD603LSⓄ	MD603RSⓄ			
K75 C	85-08/88	FA018*		FA018V*	FA018HH*	MD604LS	MD604RS			
K75 C	09/88-90	FA171*		FA171V*	FA171HH*	MD604LS	MD604RS			
K75 RT (Non ABS)	89-96	FA171*		FA171V*	FA171HH*	MD604LS	MD604RS			
K75 RT (ABS Model)	89-96	FA171*		FA171V*	FA171HH*	MD603LSⓄ	MD603RSⓄ			
K75 S (Non ABS)	85-09/88	FA018*		FA018V*	FA018HH*	MD604LS	MD604RS			
K75 S (Non ABS Model)	09/88-95	FA171*		FA171V*	FA171HH*	MD604LS	MD604RS			
K75 S (ABS Model)	85-09/88	FA018*		FA018V*	FA018HH*	MD603LSⓄ	MD603RSⓄ			
K75 S (ABS Model)	09/88-95	FA171*		FA171V*	FA171HH*	MD603LSⓄ	MD603RSⓄ			
K1000 (Non ABS - 8 valve model)	82-09/88	FA018*		FA018V*	FA018HH*	MD604LS	MD604RS			
K100/2 (Non ABS - 8 valve model)	87-08/88	FA018*		FA018V*	FA018HH*	MD604LS	MD604RS			

FRONT / AVANT / VORN / FRENTE / ANTERIORE

Line # 1 2 3 4 5 6 7 8 9 10 11 12 13 14 15 16 17 18 19 20 21 22 23 24 25 26 27 28 29 30 31 32 33 34 35 36 37 38 39 40 41 42 43 44 45 46 47 48 49 50 51 52 53 54 55 56 57 58 59 60

R Suffix = High Durability Sintered Pad. HH Suffix = High Performance Sintered Pad. TT Suffix = Hard Wearing Off Road Pad. V Suffix = Semi Sintered Pad. G Suffix = Grooved Shoe.

D Suffix = Drilled Disc. X Suffix = Universal Left or Right Disc. XC Suffix = Contoured Disc. LS Suffix = Left/Steel Disc. RS Suffix = Right/Steel Disc.

Ⓞ - Remove ABS ring from old rotor and refit to new EBC rotor. Ensure all mounting surfaces are clean and when refitting bolts use a thread lock cement to hold them in place.

*-2 Sets Required. † For Vee disc colours add RED, BLU, GRN, GLD, ORG suffix to part number.

Ⓞ - Also available as a Vintage Motorcycle Disc.

Non-JAPANESE Built Motorcycles

Line #	BRAKE DISC CHOICES - FRONT						DISC PAD CHOICES - REAR				BRAKE DISC CHOICES - REAR			
	Over-size 250 /280mm Disc Kit	OSX Over-size 250/280mm Disc Kit	Relocating Bracket for 250/ 280mm Disc	Over-size 320mm Disc Kit	SMX Over-size 320mm Disc Kit	Relocating Bracket for 320mm Disc	FA, SFA, TT Pad or Brake Shoe	SFAC Carbon Scooter Pads	Speciality Pads - SXR / Vee / MXS	Sintered/ HH Pads/ Grooved Shoes	Standard Replacement Disc	Contour Disc Rear fitment	Vee- Discs™ CONTOUR	CX Extreme MX Race Disc/ UTVX Disc
1														
2							FA213		FA213V	FA213HH	MD651			
3														
4							FA213		FA213V	FA213HH	MD651			
5														
6							FA213		FA213V	FA213HH	MD651			
7														
8							FA213		FA213V	FA213HH	MD671			
9							FA213		FA213V	FA213HH	MD671			
10														
11							FA213		FA213V	FA213HH	MD651			
12														
13							FA213		FA213V	FA213HH	MD651			
14														
15							FA213		FA213V	FA213HH	MD651			
16							FA213		FA213V	FA213HH	MD671			
17							FA213		FA213V	FA213HH	MD671			
18							FA213		FA213V	FA213HH	MD671			
19							FA213		FA213V	FA213HH	MD671			
20							FA213		FA213V	FA213HH	MD671			
21							FA213		FA213V	FA213HH	MD671			
22							FA213		FA213V	FA213HH	MD671			
23							FA213		FA213V	FA213HH	MD671			
24							FA213		FA213V	FA213HH	MD671			
25							FA213		FA213V	FA213HH	MD671			
26							FA213		FA213V	FA213HH	MD671			
27							FA213		FA213V	FA213HH	MD671			
28							FA213		FA213V	FA213HH	MD671			
29							FA213		FA213V	FA213HH	MD671			
30							FA213		FA213V	FA213HH	MD671			
31							FA213		FA213V	FA213HH	MD671			
32							FA213		FA213V	FA213HH	MD671			
33							FA213		FA213V	FA213HH	MD671			
34							FA213		FA213V	FA213HH	MD671			
35							FA213		FA213V	FA213HH	MD671			
36							FA213		FA213V	FA213HH	MD671			
37							FA213		FA213V	FA213HH	MD671			
38								FA213			FA213HH			
39								FA213			FA213HH			
40							FA363		FA363V	FA363HH	MD671			
41							FA363		FA363V	FA363HH	MD671			
42							FA363		FA363V	FA363HH	MD671			
43							FA213		FA213V	FA213HH	MD832			
44							FA213		FA213V	FA213HH	MD832			
45							FA213		FA213V	FA213HH				
46							863							
47							861							
48							861							
49							FA018		FA018V	FA018HH	MD611			
50							861							
51							861							
52							FA018		FA018V	FA018HH	MD611			
53							FA018		FA018V	FA018HH	MD661			
54							FA018		FA018V	FA018HH	MD611			
55							FA018		FA018V	FA018HH	MD611			
56							FA018		FA018V	FA018HH	MD661			
57							FA018		FA018V	FA018HH	MD661			
58							FA018		FA018V	FA018HH	MD611			
59							FA018		FA018V	FA018HH	MD611			
60														

REAR / ARRIÈRE / HINTEN / POSTERIOR / POSTERIORE

R Suffix = High Durability Sintered Pad. **HH** Suffix = High Performance Sintered Pad. **TT** Suffix = Hard Wearing Off Road Pad. **V** Suffix = Semi Sintered Pad. **G** Suffix = Grooved Shoe.
D Suffix = Drilled Disc. **X** Suffix = Universal Left or Right Disc. **XC** Suffix = Contoured Disc. **LS** Suffix = Left/Steel Disc. **RS** = Right/Steel Disc.

*-2 Sets Required. † For Vee disc colours add RED, BLU, GRN, GLD, ORG suffix to part number.
 ⊗ - Also available as a Vintage Motorcycle Disc.

Part numbers, prefixes, suffixes, photos and illustrations shown in this catalogue are trademarks and/or copyrights of EBC Brakes or the trademark owner A C Freeman Investments Ltd and use without express written permission of the owners is punishable by law.

Non-JAPANESE Built Motorcycles



BMW Contd.



DISC PAD CHOICES - FRONT

BRAKE DISC CHOICES - FRONT

Model	Date	DISC PAD CHOICES - FRONT				BRAKE DISC CHOICES - FRONT						Line #
		FA, SFA, TT Pad or Brake Shoe	SFAC Carbon Scooter Pads	Semi-Sintered V-Pads™	Sintered/HH Pads/ Grooved Shoes	Left / Gauche / Links Standard Replacement Disc	Right / Droite / Rechts Standard Replacement Disc	Contour Disc Universal left and right filament	Universal Custom Disc	Vee-Discs Black **See note below	CX Extreme MX Race Disc	
K100/2 (Non ABS - 8 valve model)	09/88-90	FA171*		FA171V*	FA171HH*	MD604LS	MD604RS					1
K100/2 (ABS - 8 valve model)	87-08/88	FA018*		FA018V*	FA018HH*	MD603LS	MD603RS					2
K100/2 (ABS - 8 valve model)	09/88-90	FA171*		FA171V*	FA171HH*	MD603LS	MD603RS					3
K100 LT (Non ABS - 8 valve model)	86-08/88	FA018*		FA018V*	FA018HH*	MD604LS	MD604RS					4
K100 LT (Non ABS - 8 valve model)	09/88-91	FA171*		FA171V*	FA171HH*	MD604LS	MD604RS					5
K100 LT (ABS - 8 valve model)	86/-8/88	FA018*		FA018V*	FA018HH*	MD603LS	MD603RS					6
K100 LT (ABS - 8 valve model)	09/88-91	FA171*		FA171V*	FA171HH*	MD603LS	MD603RS					7
K100 RS (Non ABS - 8 valve)	83-09/88	FA018*		FA018V*	FA018HH*	MD604LS	MD604RS					8
K100 RS (Non ABS - 8 valve)	10/88-89	FA171*		FA171V*	FA171HH*	MD604LS	MD604RS					9
K100 RS (ABS Model - 8 valve)	83-09/88	FA018*		FA018V*	FA018HH*	MD603LS	MD603RS					10
K100 RS (ABS Model - 8 valve)	10/88-89	FA171*		FA171V*	FA171HH*	MD603LS	MD603RS					11
K100 RT (Non ABS - 8 valve)	83-09/88	FA018*		FA018V*	FA018HH*	MD604LS	MD604RS					12
K100 RT (Non ABS - 8 valve)	10/88-89	FA171*		FA171V*	FA171HH*	MD604LS	MD604RS					13
K100 RT (ABS - 8 valve)	83-09/88	FA018*		FA018V*	FA018HH*	MD603LS	MD603RS					14
K100 RT (ABS - 8 valve)	10/88-89	FA171*		FA171V*	FA171HH*	MD603LS	MD603RS					15
K100 RS (16 valve - Non ABS)	89-92	FA407*			FA407HH*	MD607LS	MD607RS					16
K100 RS (16 valve - ABS Models)	89-92	FA407*			FA407HH*	MD607LS	MD607RS					17
K1 (16 valve - Non ABS)	88-93	FA407*			FA407HH*	MD607LS	MD607RS					18
K1 (16 valve - ABS models)	88-93	FA407*			FA407HH*	MD607LS	MD607RS					19
K1100 LT (Non ABS)	89-07/93	FA407*			FA407HH*	MD607LS	MD607RS					20
K1100 LT (ABS Model)	89-07/93	FA407*			FA407HH*	MD607LS	MD607RS					21
K1100 LT (Non ABS)	08/93-99	FA407*			FA407HH*	MD607LS	MD607RS					22
K1100 LT (ABS Model)	08/93-99	FA407*			FA407HH*	MD607LS	MD607RS					23
K1100 RS (Non ABS Model)	92-96	FA407*			FA407HH*	MD607LS	MD607RS					24
K1100 RS (ABS Model)	92-96	FA407*			FA407HH*	MD607LS	MD607RS					25
K1200 RS (Non ABS & ABS Models)	96-00	FA407*			FA407HH*	MD652	MD652	MD652C*				26
K1200 RS (With & Without Integral ABS)	01-04				FA335HH*	MD620	MD620					27
K1200 LT (Integral ABS & STD ABS Models)	97-10/00	FA407*			FA407HH*	MD652	MD652	MD652C*				28
K1200 LT	11/00-07				FA294HH*	MD616	MD616					29
(Evo-Integral ABS/Disc Has Loose Bobbins)												30
K1200 LT (Evo-Integral ABS/Disc Has Fixed Bobbins)	08-09				FA294HH*	N/A	N/A					31
(Evo-Integral ABS/Disc Has Loose Bobbins)												32
K1200 GT (2 pin rear pad K41) Disc has loose bobbins	03-06				FA335HH*	MD620	MD620					33
K1200 GT (K44) Disc has fixed bobbins	Left 06-08				FA335HH*	MD804						34
	Right				FA441HH		MD804					35
Bike is fitted with pad wear sensors. These are not available from BMW. EBC Part No. for these are as follows (you will need to order 1 kit for the front RH pad and 1 kit for the rear pad set)												36
												37
												38
					MWL001							39
K1200 R (K27/0378/Tokico Caliper - Disc has loose bobbins)	11/05-11/07				FA294HH*	MD616	MD616					40
K1200 R (K27/0378/Tokico Caliper - Disc has fixed bobbins)	12/07-10				FA294HH*	MD804	MD804					41
K1200 S (K40) 5mm thick disc	05-08				FA335HH*	MD620	MD620					42
K1300 GT (Disc has fixed bobbins) 4.5mm disc	09-11				FA335HH*	MD804	MD804					43
K1300 GT SE (Disc has fixed bobbins)	10-11				FA335HH*	MD804	MD804					44
K1300 R (Disc has fixed bobbins)	09-12				FA294HH*	MD804	MD804					45
K1300 R Carbon (Disc has fixed bobbins)	12				FA294HH*	MD804	MD804					46
K1300 R Dynamic (Disc has fixed bobbins)	11-15				FA294HH*	MD804	MD804					47
K1300 S (Fixed bobbins - Non and ABS Models)	09-15				FA335HH*	MD804	MD804					48
K1300 S HP (Fixed bobbins - Non and ABS Models)	12				FA335HH*	MD804	MD804					49
K1300 S Sport (Fixed bobbins - Non and ABS Models)	12-15				FA335HH*	MD804	MD804					50
K1600 B Bagger	17-20				FA613HH*	MD616	MD616					51
K1600 B Grand America	18-20				FA613HH*	MD616	MD616					52
K1600 GT K48 (Disc has fixed bobbins)	11-20				FA613HH*	MD804	MD804					53
K1600 GT SE K48 (Disc has fixed bobbins)	12-15				FA613HH*	MD616	MD616					54
K1600 GT Sport K48 (Disc has fixed bobbins)	15				FA613HH*	MD616	MD616					55
K1600 GTL (Disc has fixed bobbins)	11-20				FA613HH*	MD616	MD616					56
K1600 GTL-Exclusive (Disc has fixed bobbins)	13-19				FA613HH*	MD616	MD616					57

FRONT / AVANT / VORN / FRENTE / ANTERIORE

R Suffix = High Durability Sintered Pad. HH Suffix = High Performance Sintered Pad. TT Suffix = Hard Wearing Off Road Pad. V Suffix = Semi Sintered Pad. G Suffix = Grooved Shoe. D Suffix = Drilled Disc. X Suffix = Universal Left or Right Disc. XC Suffix = Contoured Disc. LS Suffix = Left/Steel Disc. RS = Right/Steel Disc.

*-2 Sets Required. † For Vee disc colours add RED, BLU, GRN, GLD, ORG suffix to part number.

⊗ - Also available as a Vintage Motorcycle Disc.

Non-JAPANESE Built Motorcycles

Line #	BRAKE DISC CHOICES - FRONT						DISC PAD CHOICES - REAR				BRAKE DISC CHOICES - REAR			
	Oversize 250 /280mm Disc Kit	OSX Oversize 250/280mm Disc Kit	Relocating Bracket for 250/ 280mm Disc	Oversize 320mm Disc Kit	SMX Oversize 320mm Disc Kit	Relocating Bracket for 320mm Disc	FA, SFA, TT Pad or Brake Shoe	SFAC Carbon Scooter Pads	Speciality Pads - SXR / Vee / MXS	Sintered/ HH Pads/ Grooved Shoes	Standard Replacement Disc	Contour Disc Rear fitment	Vee-Discs™ CONTOUR	CX Extreme MX Race Disc/ UTVX Disc
1							FA018		FA018V	FA018HH	MD611			
2							FA018		FA018V	FA018HH	MD661Ⓣ			
3							FA018		FA018V	FA018HH	MD661Ⓣ			
4							FA018		FA018V	FA018HH	MD611			
5							FA018		FA018V	FA018HH	MD611			
6							FA018		FA018V	FA018HH	MD661Ⓣ			
7							FA018		FA018V	FA018HH	MD661Ⓣ			
8							FA018		FA018V	FA018HH	MD611			
9							FA018		FA018V	FA018HH	MD611			
10							FA018		FA018V	FA018HH	MD661Ⓣ			
11							FA018		FA018V	FA018HH	MD661Ⓣ			
12							FA018		FA018V	FA018HH	MD611			
13							FA018		FA018V	FA018HH	MD661			
14							FA018		FA018V	FA018HH	MD661Ⓣ			
15							FA018		FA018V	FA018HH	MD661Ⓣ			
16							FA018		FA018V	FA018HH	MD611			
17							FA018		FA018V	FA018HH	MD661Ⓣ			
18							FA018		FA018V	FA018HH	MD611			
19							FA018		FA018V	FA018HH	MD661Ⓣ			
20							FA018		FA018V	FA018HH	MD611			
21							FA018		FA018V	FA018HH	MD661Ⓣ			
22							FA018		FA018V	FA018HH	MD661			
23							FA018		FA018V	FA018HH	MD661Ⓣ			
24							FA018		FA018V	FA018HH	MD661			
25							FA018		FA018V	FA018HH	MD661Ⓣ			
26							FA018		FA018V	FA018HH	MD661Ⓣ			
27							FA018		FA018V	FA018HH	MD661Ⓣ			
28							FA304		FA304V	FA304HH	MD615Ⓣ			
29							FA304		FA304V	FA304HH	MD615Ⓣ			
30														
31							FA304		FA304V	FA304HH	MD615Ⓣ			
32														
33							FA018		FA018V	FA018HH	MD661			
34										MD688				
35										FA438HH				
36														
37														
38														
39														
40									MWL002					
41							FA671		FA671V	FA671HH	MD671			
42														
43							FA671		FA671V	FA671HH	MD671			
44							FA671		FA671V	FA671HH	MD671			
45							FA363		FA363V	FA363HH	MD688			
46							FA363		FA363V	FA363HH	MD688			
47							FA671		FA671V	FA671HH	MD671			
48							FA671		FA671V	FA671HH	MD671			
49							FA671		FA671V	FA671HH	MD671			
50							FA671		FA671V	FA671HH	MD671			
51							FA363		FA363V	FA363HH	MD671			
52							FA671		FA671V	FA671HH	MD671			
53							N/A		FA209/2V	FA209/2HH	TBA			
54							N/A		FA209/2V	FA209/2HH	TBA			
55							N/A		FA209/2V	FA209/2HH	TBA			
56							N/A		FA209/2V	FA209/2HH	TBA			
57							N/A		FA209/2V	FA209/2HH	TBA			
58							N/A		FA209/2V	FA209/2HH	TBA			
59							N/A		FA209/2V	FA209/2HH	TBA			
60														

REAR / ARRIÈRE / HINTEN / POSTERIOR / POSTERIORE

*-2 Sets Required. † For Vee disc colours add RED, BLU, GRN, GLD, ORG suffix to part number.
 Ⓣ - Also available as a Vintage Motorcycle Disc.

R Suffix = High Durability Sintered Pad. **HH** Suffix = High Performance Sintered Pad. **TT** Suffix = Hard Wearing Off Road Pad. **V** Suffix = Semi Sintered Pad. **G** Suffix = Grooved Shoe.
D Suffix = Drilled Disc. **X** Suffix = Universal Left or Right Disc. **XC** Suffix = Contoured Disc. **LS** Suffix = Left/Steel Disc. **RS** = Right/Steel Disc.

BRAKE APPLICATIONS

Non-JAPANESE Built Motorcycles



BMW Contd.



DISC PAD CHOICES - FRONT

BRAKE DISC CHOICES - FRONT

FA, SFA, TT Pad or Brake Shoe	SFAC Carbon Scooter Pads	Speciality Pads - SXR / Vee / MXS	Sintered/HH Pads/ Grooved Shoes	Left / Gauche / Links Standard Replacement Disc	Right / Droite / Rechts Standard Replacement Disc	Contour Disc Universal left and right fitment	Universal Custom Disc	Vee-Disks Black † See note below	CX Extreme MX Race Disc/ UTVX Disc
R 18 Classic 1800CC			FA748HH*						
R45/45 N (Single rotor with ATE caliper)		FA057V		MD606LS					
R45/45 N (Twin rotor with ATE caliper)		FA057*		MD606LS	MD606RS				
R45/45 N (Single rotor with ATE caliper)		FA057V		MD606LS					
R45/45 N (Twin rotor with ATE caliper)		FA057*		MD606LS	MD606RS				
R45/45 N (Single rotor with Brembo caliper)		FA018	FA018HH	MD606LS					
R45/45 N (Twin rotor with Brembo caliper)		FA018*	FA018HH*	MD606LS	MD606RS				
R45/45 N (Single rotor with Brembo caliper)		FA018*	FA018HH*	MD606LS					
R45/45 N (Twin rotor with Brembo caliper)		FA018*	FA018HH*	MD606LS	MD606RS				
R45 T		FA057V		MD606LS					
R50/5 / 60/5 / 60/6 / 75/5		864							
R60/7 (Single rotor)		FA022	FA022V	MD602LS					
R60/7 (Double rotor model)		FA022*	FA022V*	MD602LS	MD602RS				
R60 TIC (Single rotor)		FA022	FA022V	MD602LS					
R60 TIC (Double rotor model)		FA022*	FA022V*	MD602LS	MD602RS				
R65 (Single rotor)		FA077	FA077V	MD605LS					
R65 (Double rotor model)		FA018*	FA018V*	MD605LS	MD605RS				
R65 GS		FA018	FA018HH	MD606LS	MD606RS				
R65 LS (ATE Caliper)		FA057*	FA057V*	MD606LS	MD606RS				
R65 LS (Brembo Caliper)		FA018*	FA018V*	MD606LS	MD606RS				
R65 T (Brembo Caliper)		FA018	FA018HH	MD606LS					
R65 RT		FA018*	FA018V*	MD605LS	MD605RS				
R65 T (ATE caliper)		FA057V		MD606LS					
R75/6 (Single rotor) 75/7		FA022	FA022V	MD602LS					
R75/6 (Twin rotor) 75/7		FA022*	FA022V*	MD602LS	MD602RS				
R80 (Single rotor)		FA022	FA022V	MD602LS					
R80 (Double rotor)		FA022*	FA022V*	MD602LS	MD602RS				
R80 (Single rotor)		FA022	FA022V	MD602LS					
R80 (Double rotor)		FA022*	FA022V*	MD602LS	MD602RS				
R80/R 80 RT (Single rotor)		FA077	FA077V	MD605LS					
R80 RT (Double rotor)		FA018*	FA018V*	MD602LS	MD602RS				
R80/R 80 RT (Double rotor)		FA018*	FA018V*	MD605LS	MD605RS				
R80/R 80 RT (Single rotor)		FA077	FA077V	MD605LS	MD605RS				
R80/R 80 RT (Double rotor)		FA171*	FA171V*	MD605LS	MD605RS				
R80 GS		FA018	FA018HH	MD606LS					
R80 GS		FA077	FA077V	MD605RS					
R80 PD/CH		FA077	FA077V	MD605RS					
R80 ST		FA018	FA018HH	MD606RS					
R80 TIC		FA022*	FA022V*	MD602LS	MD602RS				
R80 TIC		FA018*	FA018V*	MD602LS	MD602RS				
R80 Mystic		FA407*	FA407HH*	MD605LS	MD605RS				
R80 R		FA407*	FA407HH*	MD605LS	MD605RS				
R850 C (Cast wheel/ABS)		FA407*	FA407HH*	MD652⊗	MD652⊗	MD652C*			
R850 C (Spoke wheel/ABS)		FA407*	FA407HH*	MD652⊗	MD652⊗	MD652C*			
R850 GS		FA077	FA077V	MD605RS					
R850 GS (Std & ABS models)		FA407*	FA407HH*	MD652⊗	MD652⊗	MD652C*			
R850 R (Cast wheel/ABS)		FA407*	FA407HH*	MD607LS⊗	MD607RS⊗				
R850 R (Spoke wheel)		FA407*	FA407HH*	MD652	MD652	MD652C*			
R850 R			FA294HH*	MD616	MD616				
R850 RT (Cast wheel/ABS)		FA407*	FA407HH*	MD607LS⊗	MD607RS⊗				
R850 RT (Spoke wheel)		FA407*	FA407HH*	MD652	MD652	MD652C*			
R850 RT			FA335HH*	MD620	MD620				
R90 S		FA022*	FA022V*	MD602LS	MD602RS				
R90/6 (Single rotor)		FA022	FA022V	MD602LS					
R90/6 (Twin rotor)		FA022*	FA022V*	MD602LS	MD602RS				
R100 (Single rotor)		FA022	FA022V	MD602LS					
R100 (Twin rotor)		FA022*	FA022V*	MD602LS	MD602RS				
R100 GS		FA077	FA077V	MD605RS					

FRONT / AVANT / VORN / FRENTE / ANTERIORE

Line #
1
2
3
4
5
6
7
8
9
10
11
12
13
14
15
16
17
18
19
20
21
22
23
24
25
26
27
28
29
30
31
32
33
34
35
36
37
38
39
40
41
42
43
44
45
46
47
48
49
50
51
52
53
54
55
56
57
58
59
60

R Suffix = High Durability Sintered Pad. HH Suffix = High Performance Sintered Pad. TT Suffix = Hard Wearing Off Road Pad. V Suffix = Semi Sintered Pad. G Suffix = Grooved Shoe.

D Suffix = Drilled Disc. X Suffix = Universal Left or Right Disc. XC Suffix = Contoured Disc. LS Suffix = Left/Steel Disc. RS = Right/Steel Disc.

⊗ - Remove rotor outer ring from centre casting and refit.

⊙ - Remove ABS ring from old rotor and refit to new EBC rotor. Ensure all mounting surfaces are clean and when refitting bolts use a thread lock cement to hold them in place.

*-2 Sets Required. † For Vee disc colours add RED, BLU, GRN, GLD, ORG suffix to part number.

⊗ - Also available as a Vintage Motorcycle Disc.

Non-JAPANESE Built Motorcycles

Line #	BRAKE DISC CHOICES - FRONT						DISC PAD CHOICES - REAR				BRAKE DISC CHOICES - REAR			
	Oversize 250 /280mm Disc Kit	OSX Oversize 250/280mm Disc Kit	Relocating Bracket for 250/ 280mm Disc	Oversize 320mm Disc Kit	SMX Oversize 320mm Disc Kit	Relocating Bracket for 320mm Disc	FA, SFA, TT Pad or Brake Shoe	SFAC Carbon Scooter Pads	Speciality Pads - SXR / Vee / MXS	Sintered/ HH Pads/ Grooved Shoes	Standard Replacement Disc	Contour Disc Rear fitment	Vee-Discs™ CONTOUR	CX Extreme MX Race Disc/ UTVX Disc
1									FA749HH					
2							860							
3							860							
4							861							
5							861							
6							860							
7							860							
8							861							
9							861							
10							861							
11							860							
12							860							
13							860							
14							860							
15							860							
16							861							
17							861							
18							861							
19							862							
20							862							
21							861							
22							861							
23							861							
24							860							
25							860							
26							860							
27							860							
28							861							
29							861							
30							861							
31							861							
32							861							
33							861							
34							859							
35							861							
36							859							
37							859							
38							861							
39							860							
40							861							
41							859							
42							859							
43							FA363		FA363V	FA363HH	N/A			
44							FA363		FA363V	FA363HH	N/A			
45							859							
46							FA363		FA363V	FA363HH	MD653⓪	MD653C		
47							FA363		FA363V	FA363HH	MD653⓪			
48							FA363		FA363V	FA363HH	MD653	MD653C		
49							FA363		FA363V	FA363HH	MD653			
50							FA363		FA363V	FA363HH	MD653⓪			
51							FA363		FA363V	FA363HH	MD653	MD653C		
52							FA363		FA363V	FA363HH	MD653			
53							860							
54							860							
55							860							
56							860							
57							860							
58							859							
59														
60														

REAR / ARRIÈRE / HINTEN / POSTERIOR / POSTERIORE

R Suffix = High Durability Sintered Pad. **HH** Suffix = High Performance Sintered Pad. **TT** Suffix = Hard Wearing Off Road Pad. **V** Suffix = Semi Sintered Pad. **G** Suffix = Grooved Shoe.
D Suffix = Drilled Disc. **X** Suffix = Universal Left or Right Disc. **XC** Suffix = Contoured Disc. **LS** Suffix = Left/Steel Disc. **RS** = Right/Steel Disc.

*-2 Sets Required. † For Vee disc colours add RED, BLU, GRN, GLD, ORG suffix to part number.
 ⓪ - Also available as a Vintage Motorcycle Disc.

Part numbers, prefixes, suffixes, photos and illustrations shown in this catalogue are trademarks and/or copyrights of EBC Brakes or the trademark owner A C Freeman Investments Ltd and use without express written permission of the owners is punishable by law.

Non-JAPANESE Built Motorcycles



BMW Contd.



DISC PAD CHOICES - FRONT

BRAKE DISC CHOICES - FRONT

FA, SFA, TT Pad or Brake Shoe	SFAC Carbon Scooter Pads	Speciality Pads - SXR / Vee / MXS	Sintered/HH Pads/ Grooved Shoes	Left / Gauche / Links Standard Replacement Disc	Right / Droite / Rechts Standard Replacement Disc	Contour Disc Universal left and right fitment	Universal Custom Disc	Vee-Discs Black † See note below	CX Extreme MX Race Disc/ UTVX Disc
R100 PD	89-96	FA077	FA077V		MD605RS				
R100/7T (Single rotor)	77-09/80	FA022	FA022V	MD602LS					
R100/7T (Twin rotor)	77-09/80	FA022*	FA022V*	MD602LS	MD602RS				
R100/7T (Spoke wheel)	09/80-84	FA018*	FA018V*	FA018HH*	MD606RS				
R100/7T (Cast wheel)	09/80-84	FA018*	FA018V*	FA018HH*	MD602LS	MD602RS			
R100 S	76-80	FA022*	FA022V*	MD602LS	MD602RS				
R100 RS	76-09/80	FA022*	FA022V*	MD602LS	MD602RS				
R100 RS	10/80-84	FA018*	FA018V*	FA018HH*	MD602RS				
R100 RS	86-08/88	FA018*	FA018V*	FA018HH*	MD605RS				
R100 RS	09/88-08/89	FA171*	FA171V*	FA171HH*	MD605RS				
R100 RS	90-9/92	FA171*	FA171V*	FA171HH*	MD605LS	MD605RS			
R100 RT	78-09/80	FA022*	FA022V*	MD602LS	MD602RS				
R100 RT	10/80-84	FA018*	FA018V*	FA018HH*	MD602LS	MD602RS			
R100 RT	87-08/88	FA018*	FA018V*	FA018HH*	MD605LS	MD605RS			
R100 RT	09/88-08/89	FA171*	FA171V*	FA171HH*	MD605LS	MD605RS			
R100 RT	09/89-95	FA171*	FA171V*	FA171HH*	MD605LS	MD605RS			
R100 Mystic	93-96	FA407*	FA407H*	MD605LS	MD605RS				
R100 R	91-95	FA407*	FA407H*	MD605LS	MD605RS				
R1100 GS (STD & ABS)	93-99	FA407*	FA407H*	MD652	MD652	MD652C*			
R1100 R (Spoke wheel)	93-05/96	FA407*	FA407H*	MD652	MD652	MD652C*			
R1100 R (Spoke wheel)	06/96	FA407*	FA407H*	MD652	MD652	MD652C*			
R1100 R (Cast wheel)	93-01	FA407*	FA407H*	MD607LS	MD607RS				
R1100 RS	92-01	FA407*	FA407H*	MD607LS	MD607RS				
R1100 S (ABS)	96-11/00	FA407*	FA407H*	MD652	MD652	MD652C*			
R1100 S (With integral ABS)	12/00-06		FA294HH*	MD616	MD616				
R1100 S (Without integral ABS)	12/00-03		FA335HH*	MD803	MD803				
R1100 RT (Cast wheel/ABS)	94-01	FA407*	FA407H*	MD607LS	MD607RS				
R1100 RT (Spoke wheel)	94-01	FA407*	FA407H*	MD652	MD652	MD652C*			
R1150 GS (R21/0415/0495)	98-10/01	FA407*	FA407H*	MD652	MD652	MD652C*			
R1150 GS (Evo R21/0415/0495)	11/01-03		FA294HH*	MD652	MD652	MD652C*			
R1150 GS-Adventure (Evo R21A 0441/0492)	07/01-06		FA294HH*	MD652	MD652	MD652C*			
R1150 R	01-06		FA294HH*	MD616	MD616				
R1150 RS (Integral ABS)	01-04		FA294HH*	MD616	MD616				
R1150 RT (Integral ABS)	00-06		FA335HH*	MD620	MD620				
R1150 R Rockster	03-06		FA294HH*	MD616	MD616				
R1150 R Rockster Edition 80	04		FA294HH*	MD616	MD616				
R Nine T (K21/1170cc)	14-20		FA630HH*	MD804	MD804				
R Nine T /5 K21/1170cc	20-21	FA244*	FA244H*	MD804	MD804				
R Nine T Pure (K22/1170cc)	16-21	FA244*	FA244V*	FA244HH*	MD804	MD804			
R Nine T Scrambler (K21/1170cc)	16-21	FA244*	FA244V*	FA244HH*	MD804	MD804			
R Nine T Café Racer (K32/1170cc)	16-20	FA244*	FA244V*	FA244HH*	MD804	MD804			
R Nine T Urban GS (K33/1170cc)	17-21	FA244*	FA244V*	FA244HH*	MD804	MD804			
R1200 (Independence/Cast Wheel)	00-02	FA407*	FA407H*	MD652	MD652	MD652C*			
R1200 (Independence/Spoke Wheel)	00-02	FA407*	FA407H*	MD652	MD652	MD652C*			
R1200 C (Cast Wheel/ABS)	96-02	FA407*	FA407H*	MD652	MD652	MD652C*			
R1200 C (Spoke Wheel/ABS)	96-02	FA407*	FA407H*	MD652	MD652	MD652C*			
R1200 C Independent (Cast Wheel)	03-04		FA294HH*	MD652	MD652	MD652C*			
R1200 C Montauk	04		FA294HH*	MD652	MD652	MD652C*			
R1200 C Classic	03-04		FA294HH*	MD652	MD652	MD652C*			
R1200 CL	02-04		FA294HH*	MD652	MD652	MD652C*			
R1200 GS (K25/0307) (Discs have loose bobbins)	02-11/07		FA335HH*	MD687	MD687				
R1200 GS Adventure (K25/0382/Spoke Wheel)									
(Disc has fixed bobbins)	05-11/07		FA335HH*	MD687	MD687				
R1200 GS Adventure/M (K25/0380/Spoke wheel)									
(Disc has fixed bobbins)	06-09		FA335HH*	MD687	MD687				
R1200 GS/M (K25/0303 Cast/Spoke wheel)									
(Disc has fixed bobbins)	06-09		FA335HH*	MD687	MD687				
R1200 GS (Cast wheels/Disc has fixed bobbins)	10-11		FA335HH*	MD687	MD687				

FRONT / AVANT / VORN / FRENTE / ANTERIORE

Line #

R Suffix = High Durability Sintered Pad. HH Suffix = High Performance Sintered Pad. TT Suffix = Hard Wearing Off Road Pad. V Suffix = Semi Sintered Pad. G Suffix = Grooved Shoe.

D Suffix = Drilled Disc. X Suffix = Universal Left or Right Disc. XC Suffix = Contoured Disc. LS Suffix = Left/Steel Disc. RS = Right/Steel Disc.

*-2 Sets Required. † For Vee disc colours add RED, BLU, GRN, GLD, ORG suffix to part number.

⊗ - Also available as a Vintage Motorcycle Disc.

Non-JAPANESE Built Motorcycles

Line #	BRAKE DISC CHOICES - FRONT						DISC PAD CHOICES - REAR				BRAKE DISC CHOICES - REAR			
	Oversize 250 /280mm Disc Kit	OSX Oversize 250/280mm Disc Kit	Relocating Bracket for 250/ 280mm Disc	Oversize 320mm Disc Kit	SMX Oversize 320mm Disc Kit	Relocating Bracket for 320mm Disc	FA, SFA, TT Pad or Brake Shoe	SFAC Carbon Scooter Pads	Speciality Pads - SXR / Vee / MXS	Sintered/ HH Pads/ Grooved Shoes	Standard Replacement Disc	Contour Disc Rear fitment	Vee-Discs™ CONTOUR	CX Extreme MX Race Disc/ UTVX Disc
1							859							
2							860							
3							860							
4							861							
5							861							
6							860							
7							860							
8							FA018		FA018V	FA018HH	MD602LS			
9							861							
10							861							
11							859							
12							860							
13							FA018		FA018V	FA018HH	MD602LS			
14							861							
15							861							
16							859							
17							859							
18							859							
19							FA363		FA363V	FA363HH	MD653Ⓞ	MD653C		
20							FA363		FA363V	FA363HH	MD653	MD653C		
21							FA363		FA363V	FA363HH	MD653	MD653C		
22							FA363		FA363V	FA363HH	MD653Ⓞ			
23							FA018		FA018V	FA018HH	MD661			
24							FA363		FA363V	FA363HH	MD653	MD653C		
25							FA363		FA363V	FA363HH	MD653Ⓞ			
26							FA363		FA363V	FA363HH	MD653			
27							FA363		FA363V	FA363HH	MD653Ⓞ			
28							FA363		FA363V	FA363HH	MD653	MD653C		
29							FA363		FA363V	FA363HH	MD653Ⓞ	MD653C		
30							FA363		FA363V	FA363HH	MD653Ⓞ	MD653C		
31							FA363		FA363V	FA363HH	MD653Ⓞ	MD653C		
32							FA363		FA363V	FA363HH	MD653			
33							FA363		FA363V	FA363HH	MD653Ⓞ			
34							FA363		FA363V	FA363HH	MD653Ⓞ			
35							FA363		FA363V	FA363HH	MD653			
36							FA363		FA363V	FA363HH	MD653			
37							FA363		FA363V	FA363HH	MD671			
38							FA363		FA363V	FA363HH	MD671			
39							FA363		FA363V	FA363HH	MD671			
40							FA363		FA363V	FA363HH	MD671			
41							FA363		FA363V	FA363HH	MD671			
42							FA363		FA363V	FA363HH	MD671			
43							FA363		FA363V	FA363HH	N/A			
44							FA363		FA363V	FA363HH	N/A			
45							FA363		FA363V	FA363HH	N/A			
46							FA363		FA363V	FA363HH	N/A			
47							FA363		FA363V	FA363HH	N/A			
48							FA363		FA363V	FA363HH	N/A			
49							FA363		FA363V	FA363HH	N/A			
50							FA304		FA304V	FA304HH	MD615Ⓞ			
51							FA363			FA363HH	MD671			
52														
53							FA363			FA363HH	MD671			
54														
55							FA363			FA363HH	MD671			
56														
57							FA363			FA363HH	MD671			
58							FA363			FA363HH	MD671			
59														
60														

REAR / ARRIÈRE / HINTEN / POSTERIOR / POSTERIORE

R Suffix = High Durability Sintered Pad. HH Suffix = High Performance Sintered Pad. TT Suffix = Hard Wearing Off Road Pad. V Suffix = Semi Sintered Pad. G Suffix = Grooved Shoe.
D Suffix = Drilled Disc. X Suffix = Universal Left or Right Disc. XC Suffix = Contoured Disc. LS Suffix = Left/Steel Disc. RS = Right/Steel Disc.

*-2 Sets Required. † For Vee disc colours add RED, BLU, GRN, GLD, ORG suffix to part number.
Ⓞ - Also available as a Vintage Motorcycle Disc.

Part numbers, prefixes, suffixes, photos and illustrations shown in this catalogue are trademarks and/or copyrights of EBC Brakes or the trademark owner A C Freeman Investments Ltd and use without express written permission of the owners is punishable by law.

Non-JAPANESE Built Motorcycles



BMW Contd.



DISC PAD CHOICES - FRONT

BRAKE DISC CHOICES - FRONT

FA, SFA, TT Pad or Brake Shoe	SFAC Carbon Scooter Pads	Speciality Pads - SXR / Vee / MXS	Sintered/HH Pads/ Grooved Shoes	Left / Gauche / Links Standard Replacement Disc	Right / Droite / Rechts Standard Replacement Disc	Contour Disc Universal left and right fitment	Universal Custom Disc	Vee-Discs Black † See note below	CX Extreme MX Race Disc/ UTVX Disc
R1200 GS (30 Years GS/Spoke wheels /Disc has fixed bobbins) 11			FA335HH*	MD687	MD687				
R1200 GS (Triple Black/Spoke wheels /Disc has fixed bobbins) 11-13			FA335HH*	MD687	MD687				
R1200 GS Adventure (Spoke wheels /Disc has fixed bobbins) 10-13			FA335HH*	MD687	MD687				
R1200 GS Adventure (30 Years GS/Spoke wheels /Disc has fixed bobbins) 11			FA335HH*	MD687	MD687				
R1200 GS Adventure (Triple Black/Disc has fixed bobbins) 12			FA335HH*	MD687	MD687				
R1200 GS Rallye (Disc has fixed bobbins) 12			FA335HH*	MD687	MD687				
R1200 GS (K50/Liquid Cooled/Radial Calipers) 13-18			FA630HH*	MD687	MD687				
R1200 GS Adventure (K51/Inc TE/XE Models /LC/Radial Calipers) 14-18			FA630HH*	MD687	MD687				
R1200 RS K54 (Disc has fixed bobbins) 15-18			FA630HH*	MD804	MD804				
R1200 RS Sport K54 (Disc has fixed bobbins) 15-18			FA630HH*	MD804	MD804				
R1200 RT (K26/0368) (Brembo caliper /Disc has loose buttons) 05-11/07			FA335HH*	MD803	MD803				
R1200 RT (K26/0368) (Disc has fixed bobbins) 12/07-09			FA335HH*	MD804	MD804				
R1200 RT K52 (Disc has fixed bobbins) 10-13			FA335HH*	MD804	MD804				
R1200 RT-SE K52 (Disc has fixed bobbins) 10-13			FA335HH*	MD804	MD804				
R1200 RT (K52/LC/Radial Calipers) 14-18			FA335HH*	MD804	MD804				
R1200 ST (K28/0328) (Disc has loose bobbins) 03-11/07			FA335HH*	MD803	MD803				
R1200 ST (K28/0328) (Disc has fixed bobbins) 12/07-08			FA335HH*	MD804	MD804				
R1200 S (K29/0366) (Disc has loose bobbins) 06-11/07			FA335HH*	MD803	MD803				
R1200 S (K29/0366) (Disc has fixed bobbins) 12/07-08			FA335HH*	MD804	MD804				
R1200 R (K27/0378) (Disc has loose bobbins) 06-07			FA294HH*	MD804	MD804				
R1200 R (K27/0378) (Disc has fixed bobbins) 12/07-14			FA294HH*	N/A	N/A				
R1200 R Classic (Disc has fixed bobbins) 11-14			FA294HH*	MD804	MD804				
R1200 R (Disc has fixed bobbins) 15-18			FA630HH*	MD804	MD804				
R1200 R SE (Disc has fixed bobbins) 10-11			FA294HH*	N/A	N/A				
R1200 R Sport (Disc has fixed bobbins) 15-18			FA630HH*	MD804	MD804				
R1250 GS (Disc has fixed bobbins) 19-20			FA724HH*	MD687	MD687				
R 1250 GS Edition 40 (Disc has fixed bobbins) 20-21			FA724HH*	MD687	MD687				
R 1250 GS Adventure 19-20			FA724HH*	MD687	MD687				
R 1250 GS Adventure Edition 40 (Disc has fixed bobbins) 20-21			FA724HH*	MD687	MD687				
R 1250 GS TE (Disc has fixed bobbins) 19-20			FA724HH*	MD687	MD687				
R 1250 GS Exclusive TE (Disc has fixed bobbins) 19-20			FA724HH*	MD687	MD687				
R 1250 GS Rallye (Disc has fixed bobbins) 19-20			FA724HH*	MD687	MD687				
R 1250 GS Rallye TE (Disc has fixed bobbins) 19-20			FA724HH*	MD687	MD687				
R 1250 R (Disc has fixed bobbins) 20-21			FA724HH*	MD687	MD687				
R 1250 RS (Disc has fixed bobbins) 19-21			FA630HH*	MD687	MD687				
R 1250 RT (Disc has fixed bobbins) 19-21			FA724HH*	MD687	MD687				
R 1250 RT SE (Disc has fixed bobbins) 19-21			FA724HH*	MD687	MD687				
R 1250 RT LE (Disc has fixed bobbins) 19-21			FA724HH*	MD687	MD687				
M 1000 RR M Sport 21				TBA	TBA				
S 1000 R Naked (K47) 14-18			FA604/4HH*	MD804	MD804				
S 1000 R Naked 20-21			FA724HH*	MD804	MD804				
S 1000 RR (K46) (Disc has fixed bobbins) 10-18			FA604/4HH*	MD804	MD804				
S 1000 R/RR (Models fitted with Forged race wheels - 7 Spoke type) 10-18			FA604/4HH*	MD862X	MD862X				
S 1000 XR (Disc has fixed bobbins) 15-18			FA630HH*	MD804	MD804				
S 1000 XR 19-20			FA724HH*	MD804	MD804				
S 1000 XR (Disc has fixed bobbins) 18-20			FA724HH*	TBA	TBA				
S 1000 R 18-20			FA724HH*						
S 1000 RR HP4 Race K60 17-18									
S 1000 RR/RR Sport/RR M Sport 18-20			FA724HH*						
R 18 1802cc 20-21			FA748HH*						
R 18 1802cc Classic 20-21			FA748HH*						

FRONT / AVANT / VORN / FRENTE / ANTERIORE

Line #
1
2
3
4
5
6
7
8
9
10
11
12
13
14
15
16
17
18
19
20
21
22
23
24
25
26
27
28
29
30
31
32
33
34
35
36
37
38
39
40
41
42
43
44
45
46
47
48
49
50
51
52
53
54
55
56
57
58
59
60

R Suffix = High Durability Sintered Pad. HH Suffix = High Performance Sintered Pad. TT Suffix = Hard Wearing Off Road Pad. V Suffix = Semi Sintered Pad. G Suffix = Grooved Shoe.
D Suffix = Drilled Disc. X Suffix = Universal Left or Right Disc. XC Suffix = Contoured Disc. LS Suffix = Left/Steel Disc. RS = Right/Steel Disc.

*-2 Sets Required. † For Vee disc colours add RED, BLU, GRN, GLD, ORG suffix to part number.

⊗ - Also available as a Vintage Motorcycle Disc.

Non-JAPANESE Built Motorcycles

Line #	BRAKE DISC CHOICES - FRONT						DISC PAD CHOICES - REAR				BRAKE DISC CHOICES - REAR			
	Oversize 250 /280mm Disc Kit	OSX Oversize 250/280mm Disc Kit	Relocating Bracket for 250/ 280mm Disc	Oversize 320mm Disc Kit	SMX Oversize 320mm Disc Kit	Relocating Bracket for 320mm Disc	FA, SFA, TT Pad or Brake Shoe	SFAC Carbon Scooter Pads	Speciality Pads - SXR / Vee / MXS	Sintered/ HH Pads/ Grooved Shoes	Standard Replacement Disc	Contour Disc Rear fitment	Vee-Discs™ CONTOUR	CX Extreme MX Race Disc/ UTVX Disc
1														
2							FA363		FA363HH	MD671				
3														
4							FA363		FA363HH	MD671				
5														
6							FA363		FA363HH	MD671				
7														
8							FA363		FA363HH	MD671				
9														
10							FA363		FA363HH	MD671				
11							FA363		FA363HH	MD671				
12							N/A		FA209/2HH	MD8001				
13														
14							N/A		FA209/2HH	MD8001				
15									FA209/2HH	MD8001				
16									FA209/2HH	MD8001				
17														
18							FA363	FA363V	FA363HH	MD671				
19							FA363	FA363V	FA363HH	MD671				
20							FA363	FA363V	FA363HH	MD671				
21							FA363	FA363V	FA363HH	MD671				
22							N/A	FA209/2V	FA209/2HH	MD8001				
23							FA363	FA363V	FA363HH	MD671				
24							FA363	FA363V	FA363HH	MD671				
25							FA363	FA363V	FA363HH	MD671				
26							FA363	FA363V	FA363HH	MD671				
27							FA363	FA363V	FA363HH	MD671				
28							FA363	FA363V	FA363HH	MD671				
29							FA363	FA363V	FA363HH	MD671				
30								FA209/2V	FA209/2HH	MD8001				
31							FA363	FA363V	FA363HH	MD671				
32								FA209/2V	FA209/2HH	MD8001				
33									FA209/2HH	MD8001				
34									FA209/2HH	MD8001				
35									FA209/2HH	MD8001				
36									FA209/2HH	MD8001				
37									FA209/2HH	MD8001				
38									FA209/2HH	MD8001				
39									FA209/2HH	MD8001				
40									FA209/2HH	MD8001				
41									FA209/2HH	MD8001				
42									FA209/2HH	MD8001				
43									FA209/2HH	MD8001				
44									FA209/2HH	MD8001				
45									FA209/2HH	MD8001				
46									FA254HH	MD832				
47							FA213		FA213HH	MD832				
48							FA213		FA213HH	MD832				
49							FA213		FA213HH	MD832				
50														
51							FA213		FA213HH	MD832				
52							FA363		FA363HH	MD671				
53							FA363		FA363HH	MD671				
54							FA363		FA363HH	MD671				
55							FA213		FA213HH	MD832				
56									FA730HH					
57							FA213		FA213HH	MD832				
58									FA749HH					
59									FA749HH					
60														

REAR / ARRIÈRE / HINTEN / POSTERIOR / POSTERIORE

R Suffix = High Durability Sintered Pad. **HH** Suffix = High Performance Sintered Pad. **TT** Suffix = Hard Wearing Off Road Pad. **V** Suffix = Semi Sintered Pad. **G** Suffix = Grooved Shoe.
D Suffix = Drilled Disc. **X** Suffix = Universal Left or Right Disc. **XC** Suffix = Contoured Disc. **LS** Suffix = Left/Steel Disc. **RS** = Right/Steel Disc.

*-2 Sets Required. † For Vee disc colours add RED, BLU, GRN, GLD, ORG suffix to part number.
 Ⓢ - Also available as a Vintage Motorcycle Disc.

Part numbers, prefixes, suffixes, photos and illustrations shown in this catalogue are trademarks and/or copyrights of EBC Brakes or the trademark owner A C Freeman Investments Ltd and use without express written permission of the owners is punishable by law.

Non-JAPANESE Built Motorcycles



BOOM TRIKE



Various Models (Rear disc only) 10-18

BORILE

B 500 CR 02-04 FA095 FA095HH N/A

B 500 MT 02 FA095 FA095HH N/A

BRAMMO (ELECTRIC BIKES)

Empulse R 12-13 FA244* FA244V* FA244HH* MD614X MD614X MD614XC* VR614BLK*

Enerzia 12-13 FA209/2 FA209/2V FA209/2HH N/A

BRANSON

BS 50 Cuba 08 SFA235 SFAC235 MD923D VR923

BS 50 Sting 08 SFA235 SFAC235 MD923D VR923

BM 125 08 SFA093 N/A

BM 125 Retro 08 SFA093 N/A

BM 125 Sport 08 FA093 N/A

BS 125 Snooker 08 SFA257 SFAC257 N/A

BS 125 Boulevard 08 SFA257 SFAC257 N/A

BM 200 08 TBA N/A

BSA

Bantam D7 858

BSM

TB 100 SFA083* SFAC083* SFA083HH* MD923D MD923D VR923*

TB 125 SFA083* SFAC083* SFA083HH* MD923D MD923D VR923*

FT 125 FA056 N/A

BULTACO

Astro SM 50 FA167 FA167HH N/A

Lobito 125 and 250cc 831G

Sherpa 250/350 N/A/I 831G

Sherpa (91-250cc & 92-350cc) 831G

Sherpa (124-250cc, 125-350cc), (150-250cc, 151) 831G

Sherpa (198-250cc & 199-350cc) 831G

Frontera 250/360/370 all models 833G

Pursang MK6 125/175/200/250/350 831G

Pursang MK7 and MK8 125/250/360 831G

Pursang MK9 125/200 831G

Pursang MK9 250/370 833G

Pursang MK10 250cc 831G

Pursang MK10 370cc 833G

Pursang MK11 250cc 831G

Pursang MK11 370cc 833G

Pursang MK12 250cc 831G

Pursang MK12 370cc 833G

Brinco (Electric Trials Bike- C/R/RE/S Models) 15-17 CFA689 N/A

CAGIVA

Cucciolo 50 98-99 SFA047 SFA047HH TBA

Stella 50 97 SFA264 SFAC264 SFA264HH TBA

Blues 50 93-95 FA156 N/A

Mantis 50 99 SFA193 SFAC193 SFA193HH TBA

Nag 50 Scooter 08 SFA235 SFAC235 N/A

Nuvola 50 00 SFA193 SFAC193 SFA193HH TBA

Progress 50 97-99 SFA115 SFAC115 SFA115HH N/A

Super City 50/80 93-95 FA156 N/A

Prima 50 92-94 FA156 N/A

W4 50 91-95 FA047 FA047HH N/A

City 50 91-94 SFA257 SFAC257 MD933D VR933

FRONT / AVANT / VORN / FRENTE / ANTERIORE

DISC PAD CHOICES - FRONT				BRAKE DISC CHOICES - FRONT							Line #
FA, SFA, TT Pad or Brake Shoe	SFAC Carbon Scooter Pads	Speciality Pads - SXR / Vee / MXS	Sintered/HH Pads/ Grooved Shoes	Left / Gauche / Links Standard Replacement Disc	Right / Droite / Rechts Standard Replacement Disc	Contour Disc Universal left and right fitment	Universal Custom Disc	Vee-Discs Black † See note below	CX Extreme MX Race Disc/ UTVX Disc	Line #	
										1	
										2	
										3	
										4	
										5	
										6	
										7	
										8	
										9	
										10	
										11	
										12	
										13	
										14	
										15	
										16	
										17	
										18	
										19	
										20	
										21	
										22	
										23	
										24	
										25	
										26	
										27	
										28	
										29	
										30	
										31	
										32	
										33	
										34	
										35	
										36	
										37	
										38	
										39	
										40	
										41	
										42	
										43	
										44	
										45	
										46	
										47	
										48	
										49	
										50	
										51	
										52	
										53	
										54	
										55	
										56	
										57	
										58	
										59	
										60	

*-2 Sets Required. † For Vee disc colours add RED, BLU, GRN, GLD, ORG suffix to part number.

⊗ - Also available as a Vintage Motorcycle Disc.

Non-JAPANESE Built Motorcycles

Line #	BRAKE DISC CHOICES - FRONT						DISC PAD CHOICES - REAR				BRAKE DISC CHOICES - REAR			
	Oversize 250 /280mm Disc Kit	OSX Oversize 250/280mm Disc Kit	Relocating Bracket for 250/ 280mm Disc	Oversize 320mm Disc Kit	SMX Oversize 320mm Disc Kit	Relocating Bracket for 320mm Disc	FA, SFA, TT Pad or Brake Shoe	SFAC Carbon Scooter Pads	Speciality Pads - SXR / Vee / MXS	Sintered/ HH Pads/ Grooved Shoes	Standard Replacement Disc	Contour Disc Rear fitment	Vee-Discs™ CONTOUR	CX Extreme MX Race Disc/ UTVX Disc
1										MD8005				
2														
3														
4							FA213		FA213HH	N/A				
5							FA213		FA213HH	N/A				
6														
7														
8							FA266	FA266V	FA266HH	N/A				
9							FA266	FA266V	FA266HH	N/A				
10														
11														
12							TBA							
13							TBA							
14							TBA							
15							TBA							
16							TBA							
17							TBA							
18							TBA			N/A				
19							TBA			N/A				
20														
21														
22							858							
23														
24														
25							Y503							
26							SFA083	SFAC083	SFA083HH	MD923D		VR923		
27							S602							
28														
29														
30							FA115		FA115HH	N/A				
31									831G					
32									831G					
33									N/A					
34									833G					
35									831G					
36									833G					
37									N/A					
38									833G					
39									831G					
40									833G					
41									833G					
42									833G					
43									833G					
44									833G					
45									833G					
46									833G					
47							CFA619			N/A				
48														
49														
50							S624							
51							SFA264	SFAC264		TBA				
52							SFA186			N/A				
53							TBA							
54							TBA							
55							TBA							
56							S624							
57							SFA186			MD805				
58							SFA186			MD805				
59							FA060			N/A				
60							893							

REAR / ARRIÈRE / HINTEN / POSTERIOR / POSTERIORE

R Suffix = High Durability Sintered Pad. **HH** Suffix = High Performance Sintered Pad. **TT** Suffix = Hard Wearing Off Road Pad. **V** Suffix = Semi Sintered Pad. **G** Suffix = Grooved Shoe.
D Suffix = Drilled Disc. **X** Suffix = Universal Left or Right Disc. **XC** Suffix = Contoured Disc. **LS** Suffix = Left/Steel Disc. **RS** = Right/Steel Disc.

*-2 Sets Required. † For Vee disc colours add RED, BLU, GRN, GLD, ORG suffix to part number.

⊗ - Also available as a Vintage Motorcycle Disc.

Part numbers, prefixes, suffixes, photos and illustrations shown in this catalogue are trademarks and/or copyrights of EBC Brakes or the trademark owner A C Freeman Investments Ltd and use without express written permission of the owners is punishable by law.

Non-JAPANESE Built Motorcycles



CAGIVA Contd.



DISC PAD CHOICES - FRONT

BRAKE DISC CHOICES - FRONT

R Suffix = High Durability Sintered Pad. HH Suffix = High Performance Sintered Pad. TT Suffix = Hard Wearing Off Road Pad. V Suffix = Semi Sintered Pad. G Suffix = Grooved Shoe.

D Suffix = Drilled Disc. X Suffix = Universal Left or Right Disc. XC Suffix = Contoured Disc. LS Suffix = Left/Steel Disc. RS = Right/Steel Disc.

FRONT / AVANT / VORN / FRENTE / ANTERIORE

		FA, SFA, TT Pad or Brake Shoe	SFAC Carbon Scooter Pads	Speciality Pads - SXR / Vee / MXS	Sintered/HH Pads/ Grooved Shoes	Left / Gauche / Links Standard Replacement Disc	Right / Droite / Rechts Standard Replacement Disc	Contour Disc Universal left and right fitment	Universal Custom Disc	Vee-Discs Black † See note below	CX Extreme MX Race Disc/ UTVX Disc	Line #
Mito 50	98-99	FA167			FA167HH	MD806LS						1
Brillio 125	08	FA086				N/A						2
Cruiser 125	87	FA134				N/A						3
125 Elefant RE	87	FA047TT			FA047R	N/A						4
Elafant 125	88-90	FA163				N/A						5
Tamanaco 125	88-89	FA163				TBA						6
WSXT 125 Aletta Rossa	83-84	FA060				N/A						7
XSST 125	-80	N/A				N/A						8
XSST 125	81-82	FA060				N/A						9
SXT 125	82	FA060				N/A						10
Blues 125	92-95	FA256			FA256HH	N/A						11
Cucciolo 125	00	SFA047			SFA047HH	MD9110D				VR9110		12
Mito 125	91-92	FA163					MD614X	MD614XC		VR614BLK		13
Mito 125 All models	93-07	FA095			FA095HH		MD614X	MD614XC		VR614BLK		14
Mito 125 (SP525)	08-10	FA095			FA095HH		MD614X	MD614XC		VR614BLK		15
Passing 125	93-97	SFA264	SFAC264		SFA264HH	N/A						16
Raptor 125	03-10	FA095			FA095HH		MD614X	MD614XC		VR614BLK		17
Roadster 125 (521 1A Model)	92-94	FA256			FA256HH		N/A					18
Roadster 125 (1AA Model)	95-99	FA256			FA256HH			N/A				19
Super City 125	92-00	FA163					MD614X	MD614XC		VR614BLK		20
Freccia 125 SY	89	FA163					N/A					21
Nuvola 125	00	SFA193	SFAC193		SFA193HH	N/A						22
Planet 125 (3 Spoke Wheels Model/6 Bolt Rear Disc)	99-03	FA095			FA095HH		MD614X	MD614XC		VR614BLK		23
Planet 125 (6 Spoke Wheels Model - 1st Series/3 Bolt Rear Disc)	99-03	FA095			FA095HH		MD614X	MD614XC		VR614BLK		24
Planet 125 (6 Spoke Wheels Model - 2nd Series/ 6 Bolt Rear Disc)	99-03	FA095			FA095HH		MD614X	MD614XC		VR614BLK		25
Planet 125 (6 Spoke Wheels Model - 2nd Series/ 6 Bolt Rear Disc)	99-03	FA095			FA095HH		MD614X	MD614XC		VR614BLK		26
WMX 125 (Rimoldi Hub)	-85				944G							27
WMX 125	86	FA047			FA047R	N/A						28
WM 125	87-88	FA134			FA134R	N/A						29
WMX 125	89	FA134			FA134R	N/A						30
W8 125	93-98	FA163					N/A					31
N1 125	97	FA095			FA095HH		MD614X	MD614XC		VR614BLK		32
SST 250	-80	N/A				N/A						33
SST 250/350	80-82	FA047			FA047HH	N/A						34
SX 250/350	-82				842G							35
SX 250	82	FA047			FA047HH	N/A						36
WMX 250	-85	FA047			FA047R	N/A						37
WMX 250	86-88	FA134			FA134R	N/A						38
WMX 250	89	FA134			FA134R	N/A						39
WMX 500	84-86	FA047			FA047R	N/A						40
W12 350	93-95	FA163				N/A						41
Canyon 500	96-00	FA124/2			FA124/2HH	MD6168D						42
Mito 500 (4T)	07	FA095			FA095HH		MD614X	MD614XC		VR614BLK		43
Mito 500 (4T)	08				FA322/4HH	MD614X		MD614XC		VR614BLK		44
Excaliber 501 RLX	92	FA134				N/A						45
W16 600	94-98	FA163				N/A						46
River 600	95-99	FA095			FA095HH		MD614X	MD614XC		VR614BLK		47
Canyon 600	96-99	FA124/2			FA124/2HH	MD6168D						48
650 Elefant	85					N/A						49
650 Elefant	88-89					MD6265D						50
V-Raptor/Raptor 650	01-07	FA244*		FA244V*	FA244HH*	MD660LS	MD660RS					51
750 Elefant	90-92	FA134				MD6265D						52
E 750 Elefant	93-95	FA124/2			FA124/2HH	MD6168D						53
900 IE Canyon/Gran Canyon	98-00	FA142*				MD6168D	MD6168D					54
E 900 Elefant Dakar Rep (300mm front disc)	90	FA124/2			FA124/2HH	TBA						55
E 900 ie Lucky Explorer (296mm front disc)	91-92	FA124/2			FA124/2HH	MD6168D						56
E 900 ie GT (296mm front disc)	91-92	FA124/2			FA124/2HH	MD6168D						57
E 900 C Elefant (282mm front discs/USD forks /Brembo front calipers/rear)	93-97	FA181TT*		MXS181	FA181R*	MD6303D	MD6303D					58
												59
												60

*-2 Sets Required. † For Vee disc colours add RED, BLU, GRN, GLD, ORG suffix to part number.

⊗ - Also available as a Vintage Motorcycle Disc.

Non-JAPANESE Built Motorcycles

Line #	BRAKE DISC CHOICES - FRONT						DISC PAD CHOICES - REAR				BRAKE DISC CHOICES - REAR			
	Oversize 250 /280mm Disc Kit	OSX Oversize 250/280mm Disc Kit	Relocating Bracket for 250/ 280mm Disc	Oversize 320mm Disc Kit	SMX Oversize 320mm Disc Kit	Relocating Bracket for 320mm Disc	FA, SFA, TT Pad or Brake Shoe	SFAC Carbon Scooter Pads	Speciality Pads - SXR / Vee / MXS	Sintered/ HH Pads/ Grooved Shoes	Standard Replacement Disc	Contour Disc Rear fitment	Vee-Discs™ CONTOUR	CX Extreme MX Race Disc/ UTVX Disc
1							FA115			FA115HH	MD805			
2							FA101				N/A			
3							FA060				N/A			
4							953							
5							FA060				MD861			
6							FA060				MD861			
7							845							
8							844			844G				
9							844			844G				
10										841G				
11							FA047			FA047HH	N/A			
12							816							
13							FA047				MD638			
14							FA047			FA047HH	MD638			
15							FA047			FA047HH	MD638			
16							H303							
17							FA047			FA047HH	MD638			
18							949							
19							949							
20							FA047				MD638			
21							FA047				N/A			
22							816							
23							FA047			FA047HH	MD638			
24														
25							FA047			FA047HH	MD839			
26														
27							FA047			FA047HH	MD638			
28										841G				
29										977G				
30										977G				
31							FA067			FA067R	N/A			
32							FA060				MD659			
33							FA047			FA047HH	TBA			
34							844			844G				
35										842G				
36										842G				
37										842G				
38										841G				
39										977G				
40							FA067			FA067R	N/A			
41										982G				
42							FA173				N/A			
43							FA165/2TT				MD6160D			
44							FA047			FA047HH	MD638			
45							FA047			FA047HH	MD638			
46							FA047				N/A			
47							FA173				N/A			
48							FA047			FA047HH	MD638			
49							FA165/2TT				MD6160D			
50							FA047				N/A			
51							FA047				MD6259D			
52							FA266	FA266V	FA266HH		MD617			
53							FA163				MD6259D			
54							FA181TT		FA181HH		MD1020			
55							FA165/2TT				MD6160D			
56							FA165/2TT				MD6160D			
57							FA165/2TT				MD6160D			
58							FA165/2TT				MD6160D			
59														
60							FA181TT	MXS181	FA181R		MD1020			

REAR / ARRIÈRE / HINTEN / POSTERIOR / POSTERIORE

R Suffix = High Durability Sintered Pad. **HH** Suffix = High Performance Sintered Pad. **TT** Suffix = Hard Wearing Off Road Pad. **V** Suffix = Semi Sintered Pad. **G** Suffix = Grooved Shoe.
D Suffix = Drilled Disc. **X** Suffix = Universal Left or Right Disc. **XC** Suffix = Contoured Disc. **LS** Suffix = Left/Steel Disc. **RS** = Right/Steel Disc.

*-2 Sets Required. † For Vee disc colours add RED, BLU, GRN, GLD, ORG suffix to part number.
 Ⓢ - Also available as a Vintage Motorcycle Disc.

Part numbers, prefixes, suffixes, photos and illustrations shown in this catalogue are trademarks and/or copyrights of EBC Brakes or the trademark owner A C Freeman Investments Ltd and use without express written permission of the owners is punishable by law.

Non-JAPANESE Built Motorcycles



CAGIVA Contd.



E 900 C ie Lucky Explorer (282mm front discs)	95-97
Navigator 1000	00-05
Raptor/V-Raptor/X-tra	00-05
Raptor X3 1000	03-04

CANNONDALE

FX 400	Left	01
	Right	
Cannibal 440	Left	02-03
	Right	
Speed/Glamis 440	Left	02-03
	Right	
Blaze 440	Left	02-03
	Right	
Moto 440	Left	02-03
	Right	

CASAL

All disc models		
Mofas		875
Boss		875
Mofas drum dia. 110mm		894
Mofas drum dia. 140mm		895
50 Ciclomotori (140mm drum)		895

CCM

CR 40 S Cafe Racer (Full Fairing)		07-08
CR 40 Cafe Racer (Handlebar Fairing)		07-08
SR 40 Street Scrambler		07-09
C-XR 125 M		07-09
C-XR 125 E		08-09
C-XR 125 S		08-09
RL 125		08-09
SM 125		08-09
TL 125		08-09
C-XR 230 E		07-09
C-XR 230 S		07-09
C-XR 230 M		07-09
XTR 250		09
LX 350-4A Quad		08-09
FT 35 S (400cc) (DRZ 400 Motor)		07-09
404 E (Front disc has 260mm O/D)		03-04
404 DS (Front disc has 260mm O/D)		03-04
404 DS Supermoto (Front disc has 320mm O/D)		03-04
404 DS Supermoto		07-09
404 DS Trail		07-09
CMX 450 (MX)		08
450 DS Trail		07-09
GP 450 (4T)		13-15
600 Spitfire		19
600 Spitfire Scrambler		19
Spitfire Flat Tracker		19-20
Spitfire Bobber		19-20
Spitfire Bobber Stealth Edition		19-20
Spitfire Foggy Edition		19-20
Spitfire Foggy Edition S		19-20
Spitfire Foggy Stealth Edition		19-20
Spitfire RAFBF 100		19-20
Spitfire Six		19-20
Spitfire Six Stealth Edition		19-20

FRONT / AVANT / VORN / FRENTE / ANTERIORE

			DISC PAD CHOICES - FRONT				BRAKE DISC CHOICES - FRONT					
FA, SFA, TT Pad or Brake Shoe	SFAC Carbon Scooter Pads	Speciality Pads - SXR / Vee / MXS	Sintered/HH Pads/ Grooved Shoes	Left / Gauche / Links Standard Replacement Disc	Right / Droite / Rechts Standard Replacement Disc	Contour Disc Universal left and right fitment	Universal Custom Disc	Vee-Disks Black † See note below	CX Extreme MX Race Disc/ UTVX Disc			Line #
FA181TT*		MXS181	FA181R*	MD6303D	MD6303D							1
FA142*			FA142HH*	MD6168D	MD6168D							2
FA244*			FA244HH*	MD660LS	MD660RS							3
			FA322/4HH*	MD666X	MD666X	MD666XC*						4
												5
												6
FA307TT			FA307R	N/A	N/A							7
FA317TT			FA317R									8
FA307TT			FA307R	N/A	N/A							9
FA317TT			FA317R									10
FA307TT			FA307R	N/A	N/A							11
FA317TT			FA317R									12
FA307TT			FA307R	N/A	N/A							13
FA317TT			FA317R									14
FA307TT			FA307R	N/A	N/A							15
FA317TT			FA317R									16
												17
FA050				N/A								19
875												20
875												21
894												22
895												23
895												24
												25
												26
FA095			FA095HH	N/A								27
FA095			FA095HH		MD813							28
FA194			FA194HH									29
FA086			FA086HH	TBA								30
FA086			FA086HH	TBA								31
FA086			FA086HH	TBA								32
FA197			FA197HH	N/A								33
FA197			FA197HH	TBA								34
FA086			FA086HH									35
FA086			FA086HH	TBA								36
FA086			FA086HH	TBA								37
FA086			FA086HH	TBA								38
FA086			FA086HH	N/A								39
FA054TT*			FA054R*	TBA	TBA							40
FA181TT		MXS181	FA181R	TBA								41
FA181TT		MXS181	FA181R	MD6260D								42
FA181TT		MXS181	FA181R	MD6260D								43
FA181TT		MXS181	FA181R	MD6209D								44
FA181TT		MXS181	FA181R	TBA								45
FA181TT		MXS181	FA181R	TBA								46
FA181TT		MXS181	FA181R	N/A								47
FA181TT		MXS181	FA181R	TBA								48
FA181TT		MXS181	FA181R			N/A						49
FA209/2			FA209/2HH									51
			FA630HH									52
			FA630HH									53
			FA630HH									54
			FA630HH									55
			FA630HH									56
			FA630HH									57
			FA630HH									58
			FA630HH									59
			FA630HH									60

*-2 Sets Required. † For Vee disc colours add RED, BLU, GRN, GLD, ORG suffix to part number.

⊗ - Also available as a Vintage Motorcycle Disc.

Non-JAPANESE Built Motorcycles

Line #	BRAKE DISC CHOICES - FRONT						DISC PAD CHOICES - REAR				BRAKE DISC CHOICES - REAR			
	Oversize 250 /280mm Disc Kit	OSX Oversize 250/280mm Disc Kit	Relocating Bracket for 250/ 280mm Disc	Oversize 320mm Disc Kit	SMX Oversize 320mm Disc Kit	Relocating Bracket for 320mm Disc	FA, SFA, TT Pad or Brake Shoe	SFAC Carbon Scooter Pads	Speciality Pads - SXR / Vee / MXS	Sintered/ HH Pads/ Grooved Shoes	Standard Replacement Disc	Contour Disc Rear fitment	Vee-Discs™ CONTOUR	CX Extreme MX Race Disc/ UTVX Disc
1							FA181TT		MXS181	FA181R	MD1020			
2							FA165/2TT				MD6160D			
3							FA266		FA266V	FA266HH	MD617			
4							FA266		FA266V	FA266HH	MD617			
5														
6														
7							FA307TT			FA307R	N/A			
8														
9							FA307TT			FA307R	N/A			
10														
11							FA307TT			FA307R	N/A			
12														
13							FA307TT			FA307R	N/A			
14														
15							FA307TT			FA307R	N/A			
16														
17														
18														
19							N/A							
20							875							
21							875							
22							894							
23							895							
24							895							
25														
26														
27							FA213		FA213V	FA213HH	MD6276D			
28							FA213		FA213V	FA213HH	TBA			
29							FA213		FA213V	FA213HH	TBA			
30							FA054TT			FA054HH	TBA			
31							FA054TT			FA054HH	TBA			
32							FA054TT			FA054HH	TBA			
33							TBA							
34							FA197			FA197HH	TBA			
35							FA197			FA197HH	TBA			
36							FA054TT			FA054HH	TBA			
37							FA054TT			FA054HH	TBA			
38							FA054TT			FA054HH	TBA			
39							FA101				N/A			
40							FA083TT			FA083R	TBA			
41							FA208TT		MXS208	FA208R	TBA			
42							FA208TT		MXS208	FA208R	MD6276D			
43							FA208TT		MXS208	FA208R	MD6276D			
44							FA208TT		MXS208	FA208R	MD6276D			
45							FA208TT		MXS208	FA208R	TBA			
46							FA208TT		MXS208	FA208R	TBA			
47							FA208TT		MXS208	FA208R	N/A			
48							FA208TT		MXS208	FA208R	TBA			
49							FA368TT			FA368R	N/A			
50							FA208TT			FA208R				
51							FA368TT		MXS368	FA368R				
52							FA368TT			FA368R				
53							FA208TT							
54														
55							FA208TT			FA208R				
56							FA208TT			FA208R				
57							FA208TT			FA208R				
58							FA208TT			FA208R				
59							FA208TT			FA208R				
60							FA208TT			FA208R				

REAR / ARRIÈRE / HINTEN / POSTERIOR / POSTERIORE

R Suffix = High Durability Sintered Pad. **HH** Suffix = High Performance Sintered Pad. **TT** Suffix = Hard Wearing Off Road Pad. **V** Suffix = Semi Sintered Pad. **G** Suffix = Grooved Shoe.
D Suffix = Drilled Disc. **X** Suffix = Universal Left or Right Disc. **XC** Suffix = Contoured Disc. **LS** Suffix = Left/Steel Disc. **RS** = Right/Steel Disc.

*-2 Sets Required. † For Vee disc colours add RED, BLU, GRN, GLD, ORG suffix to part number.
 Ⓢ - Also available as a Vintage Motorcycle Disc.

Part numbers, prefixes, suffixes, photos and illustrations shown in this catalogue are trademarks and/or copyrights of EBC Brakes or the trademark owner A C Freeman Investments Ltd and use without express written permission of the owners is punishable by law.

Non-JAPANESE Built Motorcycles



CCM Contd.



DISC PAD CHOICES - FRONT

BRAKE DISC CHOICES - FRONT

R Suffix = High Durability Sintered Pad. **HH** Suffix = High Performance Sintered Pad. **TT** Suffix = Hard Wearing Off Road Pad. **V** Suffix = Semi Sintered Pad. **G** Suffix = Grooved Shoe.
D Suffix = Drilled Disc. **X** Suffix = Universal Left or Right Disc. **XS** Suffix = Contoured Disc. **LS** Suffix = Left/Steel Disc. **RS** = Right/Steel Disc.

Spitfire Stealth	19-20
604 E DS (Dual Sport/Trail) (Front disc has 260mm O/D)	98-03
604 E Supermoto (Front disc has 320mm O/D)	99-03
604 RS Roadster (Front disc has 320mm O/D)	00-03
644 DS Supermoto (Front disc has 320mm O/D)	04
644 DS (Front disc has 320mm O/D)	04
R 30 (Spoke wheel) (604/644) (Front disc has 320mm O/D)	02-04
R 30 (Mag wheel) (604/644) (Front disc has 320mm O/D)	02-04
R 35/R 35 S	07-09
R 45	07-09
FT 650	08
LX 700-4A Quad	08-09
FT 710 S Flat Tracker	08-09

CEKTEK

500 EFI King Cobra	09-10
500 EFI Gladiator	09-10
500 EFI Quadrift	09-10
500i Estoc	10

CF MOTO

CF 125 T-22/22A Glory	10-11
CF 125 T-21A E-Charm	10-12
CF 125-3A ST Papio	21
CF 150 T-6/6A Glory	10-11
CF 150 T-5i E-Charm	10-12
CF 150-3 (150 NK)	15
CF 150 Leader	10-12
250 NK	20
250 SR	21
CF 250 T - 5 Custom	11-12
CF 250 T - 6A (Scooter) Jetmax	12-15
300 NK	20
300 SR	21
400 C-Force	18-19
400 NK	20
400 GT	
500 C-Force	17-19
CF 500-5 (Rancher 500 UTV) Left	11-14
Right	
CF 500-5 (Rancher 500 UTV) - Parking brake	11-14
CF 500 5B/5C - C/Force 500 Classic	14-15
CF 500 5B/5C - C/Force 500 Classic - Parking brake	14-15
CF 500- AU-6L C/Force 550 ATV	15
CF 500- C/Force (X5 Terralander)	11-15
CF 500- C/Force (X5 Terralander) - Parking brake	11-15
CF 500 US Z-Force 550 (Side x Side) Left	15
Right	
CF 500 UU-A U-Force 550 Left	15
(Side x Side) Right	
600 C-Force	20
600 C-Force EPS	18-19
CF 600 Z-Force Z6 EX (Side x Side) Left	13-15
Right	
CF 625 - C/Force (X6 Terralander)	11-15
CF 625 - C/Force (X6 Terralander) - Parking brake	11-15
650 GT Left	20
Right	
650 MT Left	20-21
Right	

FRONT / AVANT / VORN / FRENTE / ANTERIORE

FA, SFA, TT Pad or Brake Shoe	SFAC Carbon Scooter Pads	Speciality Pads - SXR / Vee / MXS	Sintered/HH Pads/ Grooved Shoes	Left / Gauche / Links Standard Replacement Disc	Right / Droite / Rechts Standard Replacement Disc	Contour Disc Universal left and right filment	Universal Custom Disc	Vee-Discs Black † See note below	CX Extreme MX Race Disc/ UTVX Disc
			FA630HH						
FA181TT		MXS181	FA181R	MD6260D					
FA181TT		MXS181	FA181R	MD6209D					
FA181TT		MXS181	FA181R	MD6209D					
FA181TT		MXS181	FA181R	MD6209D					
FA181TT		MXS181	FA181R	MD6209D					
FA181TT		MXS181	FA181R	MD6209D					
FA181TT		MXS181	FA181R	MD6306D					
FA181TT		MXS181	FA181R	TBA					
FA181TT		MXS181	FA181R	TBA					
FA181TT		MXS181	FA181R	TBA	TBA				
FA054TT*			FA054R*	TBA	TBA				
FA181TT		MXS181	FA181R	TBA					
FA484TT*			FA484R*	N/A	N/A				
FA377TT*			FA377R*	N/A	N/A				
FA484TT*			FA484R*	N/A	N/A				
FA484TT*			FA484R*	N/A	N/A				
SFA228	SFAC228		SFA228HH	N/A					
SFA228	SFAC228		SFA228HH	N/A					
SFA228	SFAC228		SFA228HH						
SFA228	SFAC228		SFA228HH	N/A					
SFA228	SFAC228		SFA228HH	N/A					
FA658			FA658HH		N/A				
FA093				N/A					
FA179		FA179V	FA179HH						
FA179		FA179V	FA179HH						
FA179			FA179HH	N/A					
SFA086*	SFAC086*		SFA086HH*	N/A	N/A				
FA179		FA179V	FA179HH						
FA179		FA179V	FA179HH						
		SXR726HH*	FA726R*						
FA229	FA231								
FA229	FA231								
		SXR726HH*	FA726R*						
FA135TT			FA135R	N/A	N/A				
FA165TT			FA165R						
FA232TT									
FA453TT*			FA453R*	N/A	N/A				
FA232TT									
FA453TT*			FA453R*	N/A	N/A				
FA453TT*			FA453R*	N/A	N/A				
FA232TT									
FA135TT		SXR135HH	FA135R	N/A	N/A				
FA165TT		SXR165HH	FA165R						
FA135TT		SXR135HH	FA135R	N/A	N/A				
FA165TT		SXR165HH	FA165R						
		SXR726HH*	FA726R*						
		SXR726HH*	FA726R*						
FA135TT		SXR135HH	FA135R	N/A	N/A				
FA165TT		SXR165HH	FA165R						
FA453TT*			FA453R*	N/A	N/A				
FA232TT									
FA229			FA229HH						MD4152XC
FA231			FA231HH						MD4152XC
FA229			FA229HH						
FA231			FA231HH						

Line #

*-2 Sets Required. † For Vee disc colours add RED, BLU, GRN, GLD, ORG suffix to part number.

⊗ - Also available as a Vintage Motorcycle Disc.

Non-JAPANESE Built Motorcycles

Line #	BRAKE DISC CHOICES - FRONT						DISC PAD CHOICES - REAR				BRAKE DISC CHOICES - REAR			
	OverSize 250 /280mm Disc Kit	OSX OverSize 250/280mm Disc Kit	Relocating Bracket for 250/ 280mm Disc	OverSize 320mm Disc Kit	SMX OverSize 320mm Disc Kit	Relocating Bracket for 320mm Disc	FA, SFA, TT Pad or Brake Shoe	SFAC Carbon Scooter Pads	Speciality Pads - SXR / Vee / MXS	Sintered/ HH Pads/ Grooved Shoes	Standard Replacement Disc	Contour Disc Rear fitment	Vee-Discs™ CONTOUR	CX Extreme MX Race Disc/ UTVX Disc
1							FA208TT			FA208R				
2							FA208TT		MXS208	FA208R	MD6276D			
3							FA208TT		MXS208	FA208R	MD6276D			
4							FA208TT		MXS208	FA208R	MD6276D			
5							FA208TT		MXS208	FA208R	MD6276D			
6							FA208TT		MXS208	FA208R	MD6276D			
7							FA208TT		MXS208	FA208R	MD6276D			
8							FA208TT		MXS208	FA208R	N/A			
9							FA208TT		MXS208	FA208R	TBA			
10							FA208TT		MXS208	FA208R	MD6276D			
11							FA208TT		MXS208	FA208R	TBA			
12							FA344TT			FA344R	TBA			
13							FA208TT		MXS208	FA208R	MD6276D			
14														
15														
16							FA067TT*			FA067R*	N/A			
17							FA067TT*			FA067R*	N/A			
18							FA067TT*			FA067R*	N/A			
19							FA067TT*			FA067R*	N/A			
20														
21														
22							TBA				N/A			
23							TBA				N/A			
24														
25							TBA				N/A			
26							TBA				N/A			
27							TBA				N/A			
28							S602							
29							FA208TT			FA208R				
30							FA208TT			FA208R				
31							FA101TT				N/A			
32							TBA				N/A			
33							FA208TT			FA208R				
34							FA208TT			FA208R				
35								SXR651HH*	FA651R*					
36							FA208TT			FA208R				
37							FA208TT			FA208R				
38								SXR651HH*	FA651R*					
39							FA344TT			FA344R	N/A			
40														
41														
42							FA344TT			FA344R	N/A			
43														
44							FA135TT			FA135R	N/A			
45							FA344TT			FA344R	N/A			
46														
47							FA651TT		SXR651HH	FA651R	N/A			
48							FA651TT		SXR651HH	FA651R	N/A			
49							FA651TT		SXR651HH	FA651R	N/A			
50							FA651TT		SXR651HH	FA651R	N/A			
51								SXR651HH*	FA651R*					
52								SXR651HH*	FA651R*					
53							FA651TT		SXR651HH	FA651R	N/A			
54							FA651TT		SXR651HH	FA651R	N/A			
55							FA344TT			FA344R	N/A			
56														
57							FA208TT			FA208R				
58							FA208TT			FA208R				
59														
60							FA208TT			FA208R				

REAR / ARRIÈRE / HINTEN / POSTERIOR / POSTERIORE

R Suffix = High Durability Sintered Pad. HH Suffix = High Performance Sintered Pad. TT Suffix = Hard Wearing Off Road Pad. V Suffix = Semi Sintered Pad. G Suffix = Grooved Shoe.
D Suffix = Drilled Disc. X Suffix = Universal Left or Right Disc. XC Suffix = Contoured Disc. LS Suffix = Left/Steel Disc. RS = Right/Steel Disc.

*-2 Sets Required. † For Vee disc colours add RED, BLU, GRN, GLD, ORG suffix to part number.
⊗ - Also available as a Vintage Motorcycle Disc.

Part numbers, prefixes, suffixes, photos and illustrations shown in this catalogue are trademarks and/or copyrights of EBC Brakes or the trademark owner A C Freeman Investments Ltd and use without express written permission of the owners is punishable by law.

Non-JAPANESE Built Motorcycles



CF MOTO Contd.



DISC PAD CHOICES - FRONT

BRAKE DISC CHOICES - FRONT

FA, SFA, TT Pad or Brake Shoe	SFAC Carbon Scooter Pads	Speciality Pads - SXR / Vee / MXS	Sintered/HH Pads/ Grooved Shoes	Left / Gauche / Links Standard Replacement Disc	Right / Droite / Rechts Standard Replacement Disc	Contour Disc Universal left and right filament	Universal Custom Disc	Vee-Discs Black † See note below	CX Extreme MX Race Disc/ UTVX Disc
650 NK Left 12-16	FA229		FA229HH						MD4152XC
650 NK Right 12-16	FA231		FA231HH						MD4152XC
650 NK 17-19	FA209/2*		FA209/2HH*						MD4152XC*
650 TR Left 13-14	FA229		FA229HH						MD4152XC
650 TR Right 13-14	FA231		FA231HH						MD4152XC
650 TK Left 13-15	FA229		FA229HH						MD4152XC
650 TK Right 13-15	FA231		FA231HH						MD4152XC
CLX 700 Adventure, Heritage and Sport models 20-21	FA244*		FA244HH*						
CF 800-2 - C/Force ATV 14-15	FA453TT*		FA453R*	N/A	N/A				
CF 800 UU-A U-Force 800 Left 14-16	FA135TT	SXR135HH	FA135R	N/A	N/A				
(Side x Side) Right 14-16	FA165TT	SXR165HH	FA165R						
CF 800 Z-Force Z8 (Side x Side) Left 13-15	FA135TT	SXR135HH	FA135R	N/A	N/A				
CF 800 Z-Force Z8-EX (Side x Side) Right 13-15	FA165TT	SXR165HH	FA165R						
CF 800 Z-Force Z8-EX (Side x Side) Left 14-15	FA135TT	SXR135HH	FA135R	N/A	N/A				
CF 800 Z-Force Z8-EX (Side x Side) Right 14-15	FA165TT	SXR165HH	FA165R						
MT 800 21			FA244HH*						
950 Z-Force 20		SXR726HH*	FA726R*						
1000 U-Force 20		SXR726HH*	FA726R*						
1000 Z-Force 18-19		SXR726HH*	FA726R*						
CH RACING									
WXE 50 Enduro 05	FA167		FA167HH	N/A					
WSM 50 Motard 05	FA167		FA167HH	N/A					
WXE 125 Enduro 05	FA167		FA167HH	N/A					
WSM 125 Motard 05	FA167		FA167HH	N/A					
CIMATTI									
Gringo -85	FA050			N/A					
Gringo 85-	FA099			N/A					
CONTI									
RX 356 V3 (12" wheels) 05-06	FA399			N/A					
RX 356 V3 (17" wheels) 05-06	FA399			N/A					
CPI									
Aragon 50 07-09	SFA235	SFAC235		TBA					
Aragon GP50 07-12	SFA235	SFAC235		TBA					
Aragon GP Paddock 08-12	SFA235	SFAC235		N/A					
Aragon Club 50 07-12	SFA235	SFAC235		TBA					
Aragon S-Line 50 07-12	SFA235	SFAC235		TBA					
Baby J 50 02	SFA083	SFAC083	SFA083HH	MD923D				VR923	
Bravo 50 12	SFA086	SFAC086	SFA086HH		TBA				
Formula 50 Basic 07-08	SFA235	SFAC235		TBA					
Formula 50 R 07-08	SFA235	SFAC235		TBA					
Freaky 50 07	SFA235	SFAC235		TBA					
GTR 50 (2 Pin Pad Fixing Front Caliper) 02	SFA194	SFAC194	SFA194HH	N/A					
GTR 50 (1 Pin Pad Fixing Front Caliper) 03-13	SFA266	SFAC266	SFA266HH	N/A					
GTS 50/125/200 02-03	SFA194	SFAC194	SFA194HH	N/A					
Hussar 50 01-02	SFA083	SFAC083	SFA083HH	MD923D				VR923	
Hussar 50 03-05	SFA235	SFAC235		MD923D				VR923	
Mars 50 01-02	SFA083	SFAC083	SFA083HH	MD923D				VR923	
Oliver 50 (All models) 03-12	SFA235	SFAC235		MD923D				VR923	
Popcom 50 02	SFA083	SFAC083	SFA083HH	MD923D				VR923	
Popcom 50 03-06	SFA235	SFAC235		MD923D				VR923	
Quad 50/100cc (Crab) 03-04	H338*		H338G*						
Supermoto 50 SMX 03-08	FA115		FA115R	N/A					
Supermoto 50 (Low level exhaust) 06-09	FA115		FA115HH	N/A					
Supercross 50 03-09	FA115		FA115R	N/A					
SM 50 11-12	FA115TT		FA115R	N/A					
SM 50 Black Tiger 08-09	FA115		FA115HH	N/A					

Line #

FRONT / AVANT / VORN / FRENTE / ANTERIORE

R Suffix = High Durability Sintered Pad. HH Suffix = High Performance Sintered Pad. TT Suffix = Hard Wearing Off Road Pad. V Suffix = Semi Sintered Pad. G Suffix = Grooved Shoe.

D Suffix = Drilled Disc. X Suffix = Universal Left or Right Disc. XC Suffix = Contoured Disc. LS Suffix = Left/Steel Disc. RS = Right/Steel Disc.

*-2 Sets Required. † For Vee disc colours add RED, BLU, GRN, GLD, ORG suffix to part number.

⊗ - Also available as a Vintage Motorcycle Disc.

Non-JAPANESE Built Motorcycles

Line #	BRAKE DISC CHOICES - FRONT						DISC PAD CHOICES - REAR				BRAKE DISC CHOICES - REAR			
	Oversize 250 /280mm Disc Kit	OSX Oversize 250/280mm Disc Kit	Relocating Bracket for 250/ 280mm Disc	Oversize 320mm Disc Kit	SMX Oversize 320mm Disc Kit	Relocating Bracket for 320mm Disc	FA, SFA, TT Pad or Brake Shoe	SFAC Carbon Scooter Pads	Speciality Pads - SXR / Vee / MXS	Sintered/ HH Pads/ Grooved Shoes	Standard Replacement Disc	Contour Disc Rear fitment	Vee-Discs™ CONTOUR	CX Extreme MX Race Disc/ UTVX Disc
1							FA192		FA192V	FA192HH		N/A		
2														
3							FA192			FA192HH		N/A		
4												N/A		
5														
6							FA192		FA192V	FA192HH		N/A		
7														
8							FA208TT			FA208R				
9							FA344TT			FA344R	N/A			
10							FA067TT			FA067R	N/A			
11							FA067TT			FA067R	N/A			
12							FA651TT		SXR651HH	FA651R	N/A			
13							FA651TT		SXR651HH	FA651R	N/A			
14							FA651TT		SXR651HH	FA651R	N/A			
15							FA651TT		SXR651HH	FA651R	N/A			
16										FA181HH				
17								SXR651HH*		FA651R*				
18								SXR651HH*		FA651R*				
19							FA747TT			FA747R*				
20														
21														
22							FA115			FA115HH	N/A			
23							FA115			FA115HH	N/A			
24							FA115			FA115HH	N/A			
25							FA115			FA115HH	N/A			
26														
27														
28							N/A							
29							N/A							
30														
31														
32							FA115				N/A			
33							FA115				N/A			
34														
35														
36							Y503							
37							Y503							
38							Y503							
39							Y503							
40							Y503							
41							Y503							
42							Y503							
43							Y503							
44							Y503							
45							Y503							
46							SFA260	SFAC260		SFA260HH	N/A			
47							SFA298	SFAC298		SFA298HH	N/A			
48							SFA260	SFAC260		SFA260HH	N/A			
49							Y503							
50							Y503							
51							Y503							
52							Y503							
53							Y503							
54							Y504							
55							FA083TT			FA083R	N/A			
56							FA115			FA115R	N/A			
57							FA115			FA115HH	N/A			
58							FA115			FA115R	N/A			
59							FA115TT			FA115R	N/A			
60							FA115			FA115HH	N/A			

REAR / ARRIÈRE / HINTEN / POSTERIOR / POSTERIORE

R Suffix = High Durability Sintered Pad. HH Suffix = High Performance Sintered Pad. TT Suffix = Hard Wearing Off Road Pad. V Suffix = Semi Sintered Pad. G Suffix = Grooved Shoe.
D Suffix = Drilled Disc. X Suffix = Universal Left or Right Disc. XC Suffix = Contoured Disc. LS Suffix = Left/Steel Disc. RS = Right/Steel Disc.

*-2 Sets Required. † For Vee disc colours add RED, BLU, GRN, GLD, ORG suffix to part number.
⊗ - Also available as a Vintage Motorcycle Disc.

Part numbers, prefixes, suffixes, photos and illustrations shown in this catalogue are trademarks and/or copyrights of EBC Brakes or the trademark owner A C Freeman Investments Ltd and use without express written permission of the owners is punishable by law.

Non-JAPANESE Built Motorcycles



CPI Contd.

DISC PAD CHOICES - FRONT

BRAKE DISC CHOICES - FRONT

	FA, SFA, TT Pad or Brake Shoe	SFAC Carbon Scooter Pads	Speciality Pads - SXR / Vee / MXS	Sintered/HH Pads/ Grooved Shoes	Left / Gauche / Links Standard Replacement Disc	Right / Droite / Rechts Standard Replacement Disc	Contour Disc Universal left and right fitment	Universal Custom Disc	Vee-Discs Black † See note below	CX Extreme MX Race Disc/ UTVX Disc
SX 50	FA194			FA194HH	N/A					
SX 50	FA115TT			FA115R	N/A					
XT 50 Quad	Y503*			Y503G*						
Aragon S-Line 125	SFA235	SFAC235			TBA					
Aragon GP 125	SFA235	SFAC235			TBA					
Bravo 125	SFA086	SFAC086		SFA086HH		TBA				
GTR 125 (2 Pin Pad Fixing Front Caliper)	SFA194	SFAC194		SFA194HH	N/A					
GTR 125 (1 Pin Pad Fixing Front Caliper)	SFA266	SFAC266		SFA266HH	N/A					
125 Prince	FA197			FA197HH	N/A					
Oliver 125	SFA235	SFAC235			N/A					
SM 125	FA115TT			FA115R	N/A					
SX 125	FA115TT			FA115R	N/A					
X-Large 125/150/200	SFA266*	SFAC266*		SFA266HH*	N/A	N/A				
X-Large 125/300	SFA197	SFAC197		SFA197HH		N/A				
XR 125 Sprint	FA086			FA086HH	N/A					
Sauel 125	FA185TT		MXS185	FA185R	MD6087D					
GTR 150 (2 Pin Pad Fixing Front Caliper)	SFA194	SFAC194		SFA194HH	N/A					
GTR 150 (1 Pin Pad Fixing Front Caliper)	SFA266	SFAC266		SFA266HH	N/A					
X-Large 250	SFA086	SFAC086		SFA086HH		N/A				
SM 250	FA115						N/A			
SX 250	FA115						N/A			
XR 250	FA086			FA086HH	N/A					
XS 250 Quad	FA377TT*			FA377R*	N/A	N/A				
X-Large 300	SFA197	SFAC197		SFA197HH		N/A				
CQR										
DN 50/50 E	TBA*									
DN 100	TBA*									
DN 100/100 E	TBA*									
DN 150	TBA*									
DN 150 Extreme	TBA*									
DN 150/150 E	TBA*									
DN 250/Hammel	FA083TT*			FA083R*	N/A	N/A				
DN 250 Dolphin	TBA*									
DN 250	TBA*									
Utility 250	FA083TT*			FA083R*	N/A	N/A				
RX 260	FA083TT*			FA083R*	N/A	N/A				
CSR										
Ona 125 (4T)	SFA235	SFAC235			N/A					
Scoo 125 (4T)	SFA235	SFAC235			N/A					
Moped	804									
C.Z./JAWA										
50 Minarelli	FA115			FA115HH		N/A				
50/100 Robby	FA115			FA115HH	N/A					
Scrambler Cross 125-380 (Single & twin port models)	950									
125 Sport	FA115			FA115HH		N/A				
125 Dandy	FA115			FA115HH		N/A				
125 Travel	FA115			FA115HH		N/A				
125 Chopper	FA198					N/A				
125/175/250/350	949									
125/175/250/350	951									
250/380 (Models 513/514) Full width front hub models	N/A									
Jawa 250/400 Cross	950									
350	FA198				N/A					
350 Chopper	FA198					N/A				
350 Tramp	FA198					N/A				
350 Californian	FA198					N/A				
350 Californian	FA142			FA142HH		TBA				

FRONT / AVANT / VORN / FRENTE / ANTERIORE

Line #

R Suffix = High Durability Sintered Pad. HH Suffix = High Performance Sintered Pad. TT Suffix = Hard Wearing Off Road Pad. V Suffix = Semi Sintered Pad. G Suffix = Grooved Shoe.

D Suffix = Drilled Disc. X Suffix = Universal Left or Right Disc. XC Suffix = Contoured Disc. LS Suffix = Left/Steel Disc. RS Suffix = Right/Steel Disc.

*-2 Sets Required. † For Vee disc colours add RED, BLU, GRN, GLD, ORG suffix to part number.

⊗ - Also available as a Vintage Motorcycle Disc.

Non-JAPANESE Built Motorcycles

Line #	BRAKE DISC CHOICES - FRONT						DISC PAD CHOICES - REAR				BRAKE DISC CHOICES - REAR			
	OverSize 250 /280mm Disc Kit	OSX OverSize 250/280mm Disc Kit	Relocating Bracket for 250/ 280mm Disc	OverSize 320mm Disc Kit	SMX OverSize 320mm Disc Kit	Relocating Bracket for 320mm Disc	FA, SFA, TT Pad or Brake Shoe	SFAC Carbon Scooter Pads	Speciality Pads - SXR / Vee / MXS	Sintered/ HH Pads/ Grooved Shoes	Standard Replacement Disc	Contour Disc Rear fitment	Vee-Discs™ CONTOUR	CX Extreme MX Race Disc/ UTVX Disc
1							FA115			FA115HH	N/A			
2							FA115TT			FA115R	N/A			
3							FA165TT			FA165R	N/A			
4							Y503							
5							Y527							
6							Y503							
7							SFA260	SFAC260		SFA260HH	N/A			
8							SFA298	SFAC298		SFA298HH	N/A			
9							TBA							
10							Y506							
11							FA115TT			FA115R	N/A			
12							FA115TT			FA115R	N/A			
13							SFA266	SFAC266		SFA266HH	N/A			
14							SFA197	SFAC197		SFA197HH	N/A			
15							TBA							
16							FA131TT		MXS131	FA131R	MD6013D			
17							SFA260	SFAC260		SFA260HH	N/A			
18							SFA298	SFAC298		SFA298HH	N/A			
19							SFA086	SFAC086		SFA086HH	N/A			
20							FA665				N/A			
21							FA665				N/A			
22							FA086			FA086HH	N/A			
23							FA431TT			FA431R	N/A			
24							SFA197	SFAC197		SFA197HH	N/A			
25														
26														
27							FA083TT			FA083R	N/A			
28							FA083TT			FA083R	TBA			
29							FA083TT			FA083R	N/A			
30							FA083TT			FA083R	N/A			
31							FA083TT			FA083R	TBA			
32							FA083TT			FA083R	N/A			
33							FA083TT			FA083R	N/A			
34							FA083TT			FA083R	TBA			
35							FA083TT			FA083R	N/A			
36							FA083TT			FA083R	N/A			
37							FA083TT			FA083R	N/A			
38														
39														
40							SFA235	SFAC235			N/A			
41							SFA235	SFAC235			N/A			
42							TBA							
43														
44														
45							TBA							
46							TBA							
47							950							
48							FA115			FA115HH	N/A			
49							FA115			FA115HH	N/A			
50							FA115			FA115HH	N/A			
51							949							
52							949							
53							949							
54							950							
55							950							
56							949							
57							949							
58							949							
59							949							
60							949							

REAR / ARRIÈRE / HINTEN / POSTERIOR / POSTERIORE

R Suffix = High Durability Sintered Pad. **HH** Suffix = High Performance Sintered Pad. **TT** Suffix = Hard Wearing Off Road Pad. **V** Suffix = Semi Sintered Pad. **G** Suffix = Grooved Shoe.
D Suffix = Drilled Disc. **X** Suffix = Universal Left or Right Disc. **XC** Suffix = Contoured Disc. **LS** Suffix = Left/Steel Disc. **RS** = Right/Steel Disc.

*-2 Sets Required. † For Vee disc colours add RED, BLU, GRN, GLD, ORG suffix to part number.
 Ⓢ - Also available as a Vintage Motorcycle Disc.

Part numbers, prefixes, suffixes, photos and illustrations shown in this catalogue are trademarks and/or copyrights of EBC Brakes or the trademark owner A C Freeman Investments Ltd and use without express written permission of the owners is punishable by law.

Non-JAPANESE Built Motorcycles



C.Z./JAWA Contd.



DISC PAD CHOICES - FRONT

BRAKE DISC CHOICES - FRONT

R Suffix = High Durability Sintered Pad. **HH** Suffix = High Performance Sintered Pad. **TT** Suffix = Hard Wearing Off Road Pad. **V** Suffix = Semi Sintered Pad. **G** Suffix = Grooved Shoe.

D Suffix = Drilled Disc. **X** Suffix = Universal Left or Right Disc. **XS** Suffix = Contoured Disc. **LS** Suffix = Left/Steel Disc. **RS** = Right/Steel Disc.

FRONT / AVANT / VORN / FRENTE / ANTERIORE

		FA, SFA, TT Pad or Brake Shoe	SFAC Carbon Scooter Pads	Speciality Pads - SXR / Vee / MXS	Sintered/HH Pads/ Grooved Shoes	Left / Gauche / Links Standard Replacement Disc	Right / Droite / Rechts Standard Replacement Disc	Contour Disc Universal left and right fitment	Universal Custom Disc	Vee-Discs Black † See note below	CX Extreme MX Race Disc/ UTVX Disc	Line #
350 Classic	03-04	FA198					N/A					1
350 New Classic	13-14	FA142		FA142V	FA142HH		N/A					2
DAELIM												
A-Four (50cc) (SJ 50 R)	06-09	SFA228	SFAC228		SFA228HH	N/A						3
Bonita 50 (SE50C)	09-12	SFA257	SFAC257			N/A						4
Cordi 50/SE 50 R	05-12	SFA257	SFAC257			N/A						5
DX 50 D Camper	03	SFA169	SFAC169		SFA169HH	MD904D				VR904		6
GZ 50 Message	97-02	SFA257	SFAC257			TBA						7
M 50 D/MD Millennium	03	SFA169	SFAC169		SFA169HH	MD904D				VR904		8
Tapo Message 50	04	SFA054	SFAC054		SFA054HH	N/A						9
E-Five (SJ50A)	03-06	SFA257	SFAC257			N/A						10
S-Four (ES 50)	10-12	SFA197	SFAC197		SFA197HH		N/A					11
S-Five (SJ50)	01-12	SFA257	SFAC257			TBA						12
ST 90 Pro Monkey	03	SFA169	SFAC169		SFA169HH	MD904D				VR904		13
Delfino 100 (SH100)	01-04	SFA257	SFAC257			TBA						14
Citi Ace 110	03-11	SFA086	SFAC086		SFA086HH		N/A					15
Altino 125/125 ES	01-04	SFA054	SFAC054		SFA054HH		N/A					16
Besbi 125 (SC125)	08-13	SFA233				TBA						17
B-Bone 125 (SN125)	09-14	SFA661/4	SFAC661/4			N/A						18
History 125 (SL 125)	01-06	SFA054	SFAC054		SFA054HH		MD814					19
History 125 (SL 125) - Parking brake	01-06	H303										20
Otello 125 (NS 125) DLX	00-02	SFA054	SFAC054		SFA054HH		N/A					21
Roadwin (VJ125)	04-13	FA196			FA196HH	N/A						22
Roadwin R 125 Fi (VJF 125)	08-14	FA196			FA196HH	TBA						23
SL 125 Otello Fi	07-09	SFA661/4	SFAC661/4			TBA						24
SQ 125 S2 Freewing	07-09	SFA661/4	SFAC661/4			TBA						25
ST 125	03	FA194			FA194HH	N/A						26
SU 125 Delfino	07-11	SFA197	SFAC197		SFA197HH		N/A					27
S1 125 (SL125)	07-14	SFA661/4	SFAC661/4			N/A						28
S3 125 (SV125)	10-11	SFA661/4	SFAC661/4			N/A		N/A				29
S3 125 (SV125)	12-14	SFA661/4	SFAC661/4			N/A		N/A				30
VL 125 Daystar/L	03-14	FA196			FA196HH		N/A					31
VS 125 Evolution	01-04	FA196			FA196HH	N/A						32
VT 125 Evolution	03	FA196			FA196HH	N/A						33
NS 125 DLX/III Trans Eagle	03-07	SFA054	SFAC054		SFA054HH	N/A						34
SQ 125 Freewing S2	06	SFA142	SFAC142		SFA142HH							35
ET 250 Quad	05-08	FA083TT*			FA083R*	N/A	N/A					36
Roadsport 250 (VJF 250)	10-14	FA142*			FA142HH*	N/A	N/A					37
Roadwin R 250 Fi (VJF 250)	08-10	FA142*			FA142HH*	N/A	N/A					38
SQ 250 Freeway S2	06	SFA142	SFAC142		SFA142HH	N/A						39
S3 250 (SV250)	12-14	SFA661/4	SFAC661/4			N/A		N/A				40
ST 250 Sector Quad	05-06	FA083TT*			FA083R*	N/A	N/A					41
VL 250 Daystar	13-14	FA142*		FA142V*	FA142HH*	N/A	N/A					42
ET 300 Quad	07-09	FA083TT*			FA083R*	TBA	TBA					43
DAYTONA												
DY 125 RS Euro 4	17	SFA709	SFAC709		SFA709HH							44
DERBI												
Atlantis 50 (AC/2T)	99-01	SFA115	SFAC115		SFA115HH	MD964D						45
Atlantis 50 (AC/2T)	02	SFA115	SFAC115		SFA115HH	MD964D						46
Atlantis 50 Bullet (AC/2T)	03-05	SFA115	SFAC115		SFA115HH	MD964D						47
Atlantis 50 City (AC/2T)	03-06	SFA115	SFAC115		SFA115HH	MD964D						48
Atlantis 50 Red Bullet (AC/2T)	03	SFA115	SFAC115		SFA115HH	MD964D						49
Atlantis 50 Two Chic (AC/2T)	05	SFA115	SFAC115		SFA115HH	MD964D						50
Atlantis 50 (4T) (13" - 3 spoke wheels)	04-06	SFA115	SFAC115		SFA115HH	MD991D						51
Atlantis 50 (2T) Up to ref no. 8G253171 12"/5 spoke wheels/190mm disc 3 bolt	07	SFA115	SFAC115		SFA115HH	MD964D						52

*-2 Sets Required. † For Vee disc colours add RED, BLU, GRN, GLD, ORG suffix to part number.

⊗ - Also available as a Vintage Motorcycle Disc.

Non-JAPANESE Built Motorcycles

Line #	BRAKE DISC CHOICES - FRONT						DISC PAD CHOICES - REAR				BRAKE DISC CHOICES - REAR			
	Oversize 250 /280mm Disc Kit	OSX Oversize 250/280mm Disc Kit	Relocating Bracket for 250/ 280mm Disc	Oversize 320mm Disc Kit	SMX Oversize 320mm Disc Kit	Relocating Bracket for 320mm Disc	FA, SFA, TT Pad or Brake Shoe	SFAC Carbon Scooter Pads	Speciality Pads - SXR / Vee / MXS	Sintered/ HH Pads/ Grooved Shoes	Standard Replacement Disc	Contour Disc Rear fitment	Vee-Discs™ CONTOUR	CX Extreme MX Race Disc/ UTVX Disc
1							949							
2							949							
3														
4														
5							H303							
6							TBA							
7							TBA							
8							Y503							
9							TBA							
10							Y503							
11							TBA							
12							H303							
13							TBA							
14							H303							
15							Y503							
16							H303							
17							TBA							
18							TBA							
19							TBA							
20							SFA054	SFAC054			N/A			
21							SFA054	SFAC054	SFA054HH		N/A			
22														
23							H303							
24							FA197		FA197HH	TBA				
25							FA197		FA197HH	TBA				
26							SFA054	SFAC054			TBA			
27							SFA054	SFAC054			TBA			
28							FA115		FA115HH	N/A				
29							TBA							
30							SFA054	SFAC054			N/A			
31							SFA197	SFAC197			N/A			
32							SFA427	SFAC427			N/A			
33							H310	H310G						
34							H310	H310G						
35							TBA							
36							SFA054	SFAC054	SFA054HH		N/A			
37							SFA197	SFAC197	SFA197HH		N/A			
38							FA427TT		FA427R		N/A			
39							FA197		FA197HH		N/A			
40							FA197		FA197HH		N/A			
41							SFA197	SFAC197	SFA197HH		N/A			
42							SFA608				N/A			
43							FA427TT		FA427R		N/A			
44							FA197		FA197HH		N/A			
45							FA427TT		FA427R		TBA			
46														
47														
48														
49														
50														
51							S624							
52							899							
53							899							
54							899							
55							899							
56							899							
57							816							
58														
59							899							
60														

REAR / ARRIÈRE / HINTEN / POSTERIOR / POSTERIORE

R Suffix = High Durability Sintered Pad. **HH** Suffix = High Performance Sintered Pad. **TT** Suffix = Hard Wearing Off Road Pad. **V** Suffix = Semi Sintered Pad. **G** Suffix = Grooved Shoe.
D Suffix = Drilled Disc. **X** Suffix = Universal Left or Right Disc. **XC** Suffix = Contoured Disc. **LS** Suffix = Left/Steel Disc. **RS** = Right/Steel Disc.

*-2 Sets Required. † For Vee disc colours add RED, BLU, GRN, GLD, ORG suffix to part number.
 Ⓢ - Also available as a Vintage Motorcycle Disc.

Part numbers, prefixes, suffixes, photos and illustrations shown in this catalogue are trademarks and/or copyrights of EBC Brakes or the trademark owner A C Freeman Investments Ltd and use without express written permission of the owners is punishable by law.

Non-JAPANESE Built Motorcycles



DERBI Contd.



DISC PAD CHOICES - FRONT

BRAKE DISC CHOICES - FRONT

R Suffix = High Durability Sintered Pad. **HH** Suffix = High Performance Sintered Pad. **TT** Suffix = Hard Wearing Off Road Pad. **V** Suffix = Semi Sintered Pad. **G** Suffix = Grooved Shoe.

D Suffix = Drilled Disc. **X** Suffix = Universal Left or Right Disc. **XC** Suffix = Contoured Disc. **LS** Suffix = Left/Steel Disc. **RS** = Right/Steel Disc.

FRONT / AVANT / VORN / FRENTE / ANTERIORE

		DISC PAD CHOICES - FRONT				BRAKE DISC CHOICES - FRONT					Line #	
		FA, SFA, TT Pad or Brake Shoe	SFAC Carbon Scooter Pads	Speciality Pads - SXR / Vee / MXS	Sintered/HH Pads/ Grooved Shoes	Left / Gauche / Links Standard Replacement Disc	Right / Droite / Rechts Standard Replacement Disc	Contour Disc Universal left and right fitment	Universal Custom Disc	Vee-Disks Black † See note below		CX Extreme MX Race Disc/ UTVX Disc
Atlantis 50 (2T/AC) (12"/5 spoke wheels/200mm disc From ref no. 8G253172/5 bolt)	07-11	SFA093				MD910D		MD910C		VR910		1
Atlantis 50 (4T)	07-09	SFA093				MD910D		MD910C		VR910		2
Atlantis 50 LC (4T)	99-01	SFA115	SFAC115		SFA115HH	MD964D						3
Boulevard 50 (2T)	09-12	SFA353	SFAC353		SFA353HH	MD910D		MD910C		VR910		4
Boulevard 50 (4T)	09	SFA353	SFAC353		SFA353HH	MD910D		MD910C		VR910		5
Hunter	96-99	SFA115	SFAC115		SFA115HH	MD964D						6
DFW 50 Quad	04-07	H338*			H338G*							7
DRD 50 Supermoto/Racer	03-04	FA115TT*			FA115R*	N/A	N/A					8
GP1 50cc	01-03											9
GP1 50 Open	06-11	SFA194	SFAC194		SFA194HH	MD956D				VR956		10
GP1 50 Euro 2 Chain driven/radial caliper												11
/5 bolt fixing front disc	05	SFA266	SFAC266		SFA266HH	MD9113D						12
GP1 50 Race Chain driven/radial caliper												13
/5 bolt fixing front disc	05-07	SFA266	SFAC266		SFA266HH	MD9113D						14
GP1 50cc	01-03	SFA115	SFAC115		SFA115HH	MD991D						15
GPR 50 R (218mm Rear Disc)	97-01	FA167			FA167HH	MD806LS						16
GPR 50 Replica Racing (218mm Rear Disc)	99-03	FA167			FA167HH	MD806LS						17
GPR 50 (40mm Forks/180mm Rear Disc/Radial Caliper)	04-07	FA266			FA266HH	MD685LS						18
GPR 50 Racing (40mm Forks/180mm Rear Disc/Radial Caliper)	08-10	FA266			FA266HH	MD685LS						19
GPR 50 2T (41mm Forks/218mm Rear Disc/Radial Caliper)	09-11	FA399				MD685LS						20
GPR 50 Nude (Radial caliper/180mm Rear Disc)	04-09	FA266			FA266HH	MD685LS						21
Paddock 50 (AC/2T)	98-99	SFA115	SFAC115		SFA115HH	MD964D						22
Predator 50 (AC/2T)	98-01	SFA115	SFAC115		SFA115HH	MD964D						23
Predator 50 (LC/2T) 3 bolt front disc/USD Showa forks	98-03	SFA115	SFAC115		SFA115HH	MD964D						24
Predator 50 (LC/2T) 5 bolt front disc/STD Paioli forks	98-03	SFA115	SFAC115		SFA115HH	MD991D						25
Red Bullet 50	04-05	SFA115	SFAC115		SFA115HH	MD964D						26
Senda-R	96-99	FA115TT			FA115R	MD6175D						27
Senda-R	00-02	FA115TT			FA115R	MD6250D						28
Senda SM DRD 50 (Double disc model/SDR1DB)	02-03	FA167*			FA167HH*	MD6361D	MD6361D					29
Senda SM DRD 50 (Double disc model/SR3A1A)	05	FA115*			FA115HH*	MD6361D	MD6361D					30
Senda SM DRD 50 Black Edition	03	FA167			FA167HH	TBA						31
Senda SM DRD 50 Black Edition	05	FA115TT*			FA115R*	MD6361D	MD6361D					32
Senda SM DRD Racing LTD (SR2A2B Model/Cast Wheels)	05-07	FA115*			FA115HH*			MD836C*				33
Senda R DR	02	FA194			FA194HH	TBA						34
Senda DRD X Treme 50 R (21" Spoke Front Wheel /260mm disc)	11-14	FA083TT			FA083R	TBA						35
Senda DRD X Treme 50 SM (17" Cast Front Wheel/260mm disc)	11-14	FA266			FA266HH	TBA						36
Senda DRD Racing 50 SM (300mm disc/Std mounted caliper)	04-10	FA194			FA194HH	MD811						37
Senda DRD Racing 50 R (300mm disc/Std mounted caliper)	04-10	FA194			FA194HH	MD811						38
Senda DRD Racing 50 SM (260mm disc/Std mounted caliper)	11-12	FA194			FA194HH	MD811						39
Senda DRD Racing 50 R (260mm disc/Std mounted caliper)	11-12	FA194			FA194HH	MD811						40
Senda DRD Pro 50 R Radial Caliper/260mm disc	05-13	FA266			FA266HH	TBA						41
Senda DRD Pro 50 SM Radial Caliper/300mm disc	05-14	FA266			FA266HH	MD811						42
Senda DRD 50 Evo SM (Cast wheels)	08-11	FA266			FA266HH	MD8002						43
Senda X-treme 50 R (240mm disc)	03-11	FA115			FA115HH	MD6250D						44
Senda X-treme 50 SM (260mm disc)	03-11	FA115			FA115HH	TBA						45
Senda X-Race 50 R (240mm disc)	05-11	FA115			FA115HH	MD6250D						46
Senda X-Race 50 SM (260mm disc)	06-11	FA115			FA115HH	TBA						47
Sonar 50 (2T)	10-11	SFA260	SFAC260		SFA260HH	TBA						48
Vamos 50	93-95	S624										49
Vamos/Vamos FL	96-99	SFA115	SFAC115		SFA115HH	N/A						50
Variant Sport 50 (2T)	12	SFA353	SFAC353		SFA353HH	MD924D				VR924		51
X Race 50	06	FA115			FA115HH	TBA						52
GPR 80 Cup Radial Caliper	04-05	FA266			FA266HH	N/A						53

*-2 Sets Required. † For Vee disc colours add RED, BLU, GRN, GLD, ORG suffix to part number.

⊗ - Also available as a Vintage Motorcycle Disc.

Non-JAPANESE Built Motorcycles

Line #	BRAKE DISC CHOICES - FRONT						DISC PAD CHOICES - REAR				BRAKE DISC CHOICES - REAR			
	OverSize 250 /280mm Disc Kit	OSX OverSize 250/280mm Disc Kit	Relocating Bracket for 250/ 280mm Disc	OverSize 320mm Disc Kit	SMX OverSize 320mm Disc Kit	Relocating Bracket for 320mm Disc	FA, SFA, TT Pad or Brake Shoe	SFAC Carbon Scooter Pads	Speciality Pads - SXR / Vee / MXS	Sintered/ HH Pads/ Grooved Shoes	Standard Replacement Disc	Contour Disc Rear fitment	Vee-Discs™ CONTOUR	CX Extreme MX Race Disc/ UTVX Disc
1														
2							899							
3							816							
4							S624							
5							816							
6							816							
7							S624							
8							H330			H330G				
9							FA115TT			FA115R	N/A			
10														
11							SFA115	SFAC115		SFA115HH	MD932D	VR932		
12														
13							SFA115	SFAC115		SFA115HH	MD9123D			
14														
15							SFA115	SFAC115		SFA115HH	MD9123D			
16							SFA115	SFAC115		SFA115HH	MD932D			
17							FA115			FA115HH	MD805			
18							FA115			FA115HH	MD805			
19							FA115			FA115HH	MD686			
20														
21							FA115			FA115HH	MD686			
22							FA115			FA115HH	MD833			
23							FA115			FA115HH	MD686			
24							S624							
25							S624							
26							SFA115	SFAC115		SFA115HH	MD964D			
27							SFA115	SFAC115		SFA115HH	MD964D			
28							S624							
29							FA115TT			FA115R	N/A			
30							FA115TT			FA115R	MD6248D			
31							FA115			FA115HH	MD6248D			
32							FA115			FA115HH	MD6248D			
33							FA115			FA115HH	N/A			
34							FA115TT			FA115R	TBA			
35							FA115			FA115HH	MD805C			
36							FA115			FA115HH	TBA			
37														
38							FA083TT			FA083R	TBA			
39														
40							FA083TT			FA083R	TBA			
41														
42							FA115			FA115HH	MD808			
43														
44							FA115			FA115HH	MD808			
45														
46							FA083TT			FA083R	MD805			
47							FA083TT			FA083R	MD805			
48							FA350			SFA350HH	TBA			
49							FA350			SFA350HH	MD808			
50							FA350			SFA350HH	N/A			
51							FA115			FA115HH	MD6248D			
52							FA115			FA115HH	MD6248D			
53							FA115			FA115HH	MD6248D			
54							FA115			FA115HH	MD6248D			
55							816							
56							S624							
57							S624							
58							816							
59							FA115			FA115HH	TBA			
60							FA115			FA115HH	N/A			

REAR / ARRIÈRE / HINTEN / POSTERIOR / POSTERIORE

R Suffix = High Durability Sintered Pad. HH Suffix = High Performance Sintered Pad. TT Suffix = Hard Wearing Off Road Pad. V Suffix = Semi Sintered Pad. G Suffix = Grooved Shoe.
D Suffix = Drilled Disc. X Suffix = Universal Left or Right Disc. XC Suffix = Contoured Disc. LS Suffix = Left/Steel Disc. RS = Right/Steel Disc.

*-2 Sets Required. † For Vee disc colours add RED, BLU, GRN, GLD, ORG suffix to part number.
⊗ - Also available as a Vintage Motorcycle Disc.

Part numbers, prefixes, suffixes, photos and illustrations shown in this catalogue are trademarks and/or copyrights of EBC Brakes or the trademark owner A C Freeman Investments Ltd and use without express written permission of the owners is punishable by law.

Non-JAPANESE Built Motorcycles



DERBI Contd.



DISC PAD CHOICES - FRONT

BRAKE DISC CHOICES - FRONT

Line #

		FA, SFA, TT Pad or Brake Shoe	SFAC Carbon Scooter Pads	Speciality Pads - SXR / Vee / MXS	Sintered/HH Pads/ Grooved Shoes	Left / Gauche / Links Standard Replacement Disc	Right / Droite / Rechts Standard Replacement Disc	Contour Disc Universal left and right fitment	Universal Custom Disc	Vee-Discs Black † See note below	CX Extreme MX Race Disc/ UTVX Disc	
Atlantis 100 (AC/2T)	00-01	SFA115	SFAC115		SFA115HH	MD964D						1
Atlantis 100 (4T) (13" - 3 spoke wheels)	04-06	SFA115	SFAC115		SFA115HH	MD991D						2
Boulevard 125	03-07	SFA350	SFAC350		SFA350HH	MD924D		MD924C		VR924		3
Boulevard S 125	07	SFA256	SFAC256		SFA256HH	MD952D				VR952		4
Boulevard 125 (4T)	08-12	SFA353	SFAC353		SFA353HH	MD910D				VR910		5
Cross City 125	07-08	FA194			FA194HH	MD807LS						6
Cross City 125	09-14	FA465TT		MXS465	FA465R	MD807LS						7
GP1 125cc Scooter Full height seat/5 bolt fixing front disc	06	SFA266	SFAC266		SFA266HH	MD9113D						8
GP1 125cc Racing Low Seat/Radial Caliper												9
/6 bolt disc fixing	07-09	FA399				MD9122D						10
GPR 125 Racing (Radial caliper) (2T)	04-07	FA399				MD685LS						11
GPR 125 Nude (Radial caliper) (2T)	04-08	FA399				MD685LS						12
GPR 125 (4T) 4V	09-14	FA399				MD685LS						13
Mulhacen 125 (4T) Up to ref no.: 7N001790												14
Spoke wheel/2 pin pad fixing	07	FA194			FA194HH	MD807LS						15
Mulhacen 125 (4T) From ref no.: 7N001791												16
Spoke wheel/Single pin fixing	07-10	FA465TT		MXS465	FA465R	MD807LS						17
Mulhacen 125 Cafe Cast wheel/radial caliper	08-11	FA266			FA266HH	MD685LS						18
Rambla 125	08-12	SFA256	SFAC256		SFA256HH	MD952D				VR952		19
Senda 125 R Vin # SCB1A	04	FA167			FA167HH	MD698LS						20
Senda 125 R Vin # SCA1A	04	FA194			FA194HH	MD698LS						21
Senda 125 SM (Twin headlight)	04-07	FA194			FA194HH	MD698LS						22
Senda 125 Baja R (4T) (260mm disc)	06-12	FA194			FA194HH	TBA						23
Senda 125 Baja SM (4T) (300mm disc)	06-12	FA194			FA194HH	MD698LS						24
Senda DRD 125 R	10-12	FA266			FA266HH			TBA				25
Senda DRD 125 SM	10-14	FA266			FA266HH	TBA						26
Sonar 125 (4T)	10-11	SFA260	SFAC260		SFA260HH	TBA						27
Terra 125 E3	08-10	FA228			FA228HH	MD8002						28
Terra 125 Adventure	07-14	FA465TT		MXS465	FA465R	MD807LS						29
Terra 125 Euro (Single pin pad fixing)	07-11	FA465TT		MXS465	FA465R	MD807LS						30
Variant Sport 125 (4T)	12	SFA353	SFAC353		SFA353HH	MD924D				VR924		31
Boulevard 150	03-07	SFA350	SFAC350		SFA350HH	MD924D				VR924		32
Sonar 150 (4T)	09-10	SFA260	SFAC260		SFA260HH	TBA						33
Boulevard 200	05	SFA350	SFAC350		SFA350HH	MD924D				VR924		34
DXR 200 Quad (Front drum model)	04	Y503*			Y503G*							35
DXR 200 Quad (Front drum model)	04-05	Y503*			Y503G*							36
DXR 200 Quad (Front disc model)	04-07	FA083TT*			FA083R*	MD6054D	MD6054D					37
DXR 250 Quad (Front drum model)	04-05	Y503*			Y503G*							38
DXR 250 Quad (Front disc model)	04-07	FA083TT*			FA083R*	MD6054D	MD6054D					39
GP1 250cc Scooter	06-07	SFA266*	SFAC266*		SFA266HH*	MD9113D	MD9113D					40
GP1 250cc Racing Low Seat/Radial Caliper												41
/6 bolt disc fixing	07-09	FA399				MD9122D						42
Rambla 250 i	08-09	SFA256*	SFAC256*		SFA256HH*	MD952D	MD952D			VR952*		43
Rambla 300 i	10-12	SFA256*	SFAC256*		SFA256HH*	MD952D	MD952D			VR952*		44
Mulhacen 659	06-08				FA322/4HH	TBA						45
												46
												47
												48
												49
												50
												51
												52
												53
												54
												55
												56
												57
												58
												59
												60

FRONT / AVANT / VORN / FRENTE / ANTERIORE

R Suffix = High Durability Sintered Pad. HH Suffix = High Performance Sintered Pad. TT Suffix = Hard Wearing Off Road Pad. V Suffix = Semi Sintered Pad. G Suffix = Grooved Shoe. D Suffix = Drilled Disc. X Suffix = Universal Left or Right Disc. LS Suffix = Left/Steel Disc. RS = Right/Steel Disc.

DINLI

QZ 150 CUV (Front drum model)		Y503*			Y503G*							48
DL 450 RS (DL901)	06-09	FA067TT*			FA067R*	N/A	N/A					49

DUCATI

250/350/450 Desmo/Single	-76	928										52
250/350/450 Desmo/Single (4 bolt disc fixing)	74-77	FA018			FA018HH	MD634LS						53
Supersport 400 (Single disc)	93-97	FA095			FA095HH	MD2003X		MD2003XC	MD2003CC	VR2003BLK†		54
Supersport 400 (Twin disc)	93-97	FA095*			FA095HH*	MD2003X	MD2003X	MD2003XC*	MD2003CC*	VR2003BLK*†		55
400 Monster	95-97	FA095			FA095HH	MD633X		MD633XC				56
Monster 400 (Single disc)	00-02	FA244			FA244HH	MD614X		MD614XC		VR614BLK†		57
Monster 400 (Twin disc)	03-04	FA244*			FA244HH*	MD614X	MD614X	MD614XC*		VR614BLK*†		58
400 Monster (Japan)	00-04	FA244			FA244HH	MD614X		MD614XC		VR614BLK†		59
Monster Dark ie 400 (Japan)	05-06	FA244*			FA244HH*	MD614X	MD614X	MD614XC*		VR614BLK*†		60

*-2 Sets Required. † For Vee disc colours add RED, BLU, GRN, GLD, ORG suffix to part number.
 ☉ - Also available as a Vintage Motorcycle Disc.

Non-JAPANESE Built Motorcycles

Line #	BRAKE DISC CHOICES - FRONT						DISC PAD CHOICES - REAR				BRAKE DISC CHOICES - REAR			
	Oversize 250 /280mm Disc Kit	OSX Oversize 250/280mm Disc Kit	Relocating Bracket for 250/ 280mm Disc	Oversize 320mm Disc Kit	SMX Oversize 320mm Disc Kit	Relocating Bracket for 320mm Disc	FA, SFA, TT Pad or Brake Shoe	SFAC Carbon Scooter Pads	Speciality Pads - SXR / Vee / MXS	Sintered/ HH Pads/ Grooved Shoes	Standard Replacement Disc	Contour Disc Rear fitment	Vee-Discs™ CONTOUR	CX Extreme MX Race Disc/ UTVX Disc
1							S624							
2							816							
3							816							
4							SFA298	SFAC298		SFA298HH	MD942D		VR942	
5							816							
6							FA350			FA350HH	MD808			
7							FA350TT				MD808			
8							SFA266	SFAC266		SFA266HH	MD944D			
9														
10							SFA350				MD956D			
11							FA115				MD686			
12							FA115				MD686			
13							FA093				MD833			
14														
15							FA093				MD808			
16														
17							FA093				MD808			
18							FA093				MD833			
19							SFA298	SFAC298		SFA298HH	MD942D		VR942	
20							FA350			FA350HH	MD808			
21							FA350			FA350HH	MD808			
22							FA350			FA350HH	MD808			
23							FA350			FA350HH	MD808			
24							FA350			FA350HH	MD808			
25							FA093					TBA		
26							FA093				TBA			
27							816							
28							FA093				MD808			
29							FA093				MD808			
30							FA093				MD808			
31							816							
32							816							
33							816							
34							816							
35							FA135TT			FA135R	N/A			
36							FA067TT			FA067R	MD6053D			
37							FA067TT			FA067R	MD6053D			
38							FA135TT			FA135R	MD6053D			
39							FA067TT			FA067R	MD6053D			
40							SFA266	SFAC266		SFA266HH	MD944D			
41														
42							SFA350	SFAC350			MD956D			
43							SFA298	SFAC298		SFA298HH	MD942D		VR942	
44							SFA298	SFAC298		SFA298HH	MD942D		VR942	
45							FA266		FA266V	FA266HH	TBA			
46														
47														
48							TBA							
49							FA067TT			FA067R	MD6348D			
50														
51														
52							929							
53							921							
54							FA047		FA047V	FA047HH	MD2002	MD2002C	VR2002	
55							FA047		FA047V	FA047HH	MD2002	MD2002C	VR2002	
56							FA047		FA047V	FA047HH	MD2002	MD2002C		
57							FA047		FA047V	FA047HH	MD2002	MD2002C	VR2002	
58							FA047		FA047V	FA047HH	MD2002	MD2002C	VR2002	
59							FA047		FA047V	FA047HH	MD2002	MD2002C	VR2002	
60							FA047		FA047V	FA047HH	MD2002	MD2002C	VR2002	

REAR / ARRIÈRE / HINTEN / POSTERIOR / POSTERIORE

R Suffix = High Durability Sintered Pad. **HH** Suffix = High Performance Sintered Pad. **TT** Suffix = Hard Wearing Off Road Pad. **V** Suffix = Semi Sintered Pad. **G** Suffix = Grooved Shoe.
D Suffix = Drilled Disc. **X** Suffix = Universal Left or Right Disc. **XC** Suffix = Contoured Disc. **LS** Suffix = Left/Steel Disc. **RS** = Right/Steel Disc.

*-2 Sets Required. † For Vee disc colours add RED, BLU, GRN, GLD, ORG suffix to part number.
 Ⓢ - Also available as a Vintage Motorcycle Disc.

Part numbers, prefixes, suffixes, photos and illustrations shown in this catalogue are trademarks and/or copyrights of EBC Brakes or the trademark owner A C Freeman Investments Ltd and use without express written permission of the owners is punishable by law.

Non-JAPANESE Built Motorcycles



DUCATI



DISC PAD CHOICES - FRONT

BRAKE DISC CHOICES - FRONT

		DISC PAD CHOICES - FRONT			BRAKE DISC CHOICES - FRONT						Line #	
		FA, SFA, TT Pad or Brake Shoe	SFAC Carbon Scooter Pads	Speciality Pads - SXR / Vee / MXS	Sintered/HH Pads/ Grooved Shoes	Left / Gauche / Links Standard Replacement Disc	Right / Droite / Rechts Standard Replacement Disc	Contour Disc Universal left and right fitment	Universal Custom Disc	Vee-Discs Black † See note below		CX Extreme MX Race Disc/ UTVX Disc
Monster Dark ie 400 (Single disc)	05	FA244			FA244HH	MD614X		MD614XC			VR614BLK†	1
Monster 400 ie (Japan)	07-08	FA181TT*			FA181HH*	MD626X	MD626X	MD626XC*			VR626BLK†	2
400 Scrambler Sixty 2	16-21	FA209/2			FA209/2HH	TBA						3
500 GTL	75	FA047*			FA047HH*	N/A	N/A					4
500 GTV Pantah	77	FA047*			FA047HH*	N/A	N/A					5
500 Sport Desmo	77	FA047*			FA047HH*	N/A	N/A					6
500 Pantah	79	FA047*			FA047HH*	MD657LS	MD657RS					7
(549cc) Supermono	93-95	FA095*			FA095HH*	N/A	N/A					8
600 Pantah	81	FA018*			FA018HH*	MD657LS	MD657RS					9
Monster 600 (Twin disc)	93-97	FA095*			FA095HH*	MD633X	MD633X	MD633XC*				10
600 Monster (Single disc)	93-99	FA095			FA095HH	MD633X		MD633XC				11
600 Monster Dark	98-99	FA095			FA095HH	MD633X		MD633XC				12
600 Monster City/City Dark	99	FA095			FA095HH	MD614X		MD614XC			VR614BLK†	13
600 Monster	00-01	FA244			FA244HH	MD614X		MD614XC			VR614BLK†	14
600 Supersport (Single disc)	91-97	FA095			FA095HH	MD2003X		MD2003XC	MD2003CC		VR2003BLK†	15
Monster 620 ie (Single disc)	03-04	FA244			FA244HH	MD614X		MD614XC			VR614BLK†	16
620 IE Monster (First series)	02-05	FA244*			FA244HH*	MD614X	MD614X	MD614XC*			VR614BLK†	17
620 IE Monster (Second series)	03-05	FA181TT*			FA181HH*	MD626X	MD626X	MD626XC*			VR626BLK†	18
620 Sport	03	FA244*			FA244HH*	MD614X	MD614X	MD614XC*			VR614BLK†	19
Monster 620	05-06	FA181TT*			FA181HH*	MD626X	MD626X	MD626XC*			VR626BLK†	20
620 Multistrada (Twin Disc/Single Pin Pad Fixing)	06	FA181TT*			FA181HH*	MD626X	MD626X	MD626XC*			VR626BLK†	21
620 Multistrada Dark (Single Disc/Twin Pin Pad Fixing)	06	FA244			FA244HH	MD2003X		MD2003XC	MD2003CC		VR2003BLK†	22
650 Pantah	-84	FA018*			FA018HH*	N/A	N/A					23
695 Monster	07-08	FA181TT*			FA181HH*	MD626X	MD626X	MD626XC*			VR626BLK†	24
696 Monster	08-14	FA244*			FA244HH*	MD614X	MD614X	MD614XC*			VR614BLK†	25
696+ Monster (Inc ABS Models)	09-12	FA244*			FA244HH*	MD614X	MD614X	MD614XC*			VR614BLK†	26
748 R (2 pad caliper)	00	FA244*			FA244HH*	MD624	MD624					27
748 R (4 pad caliper)	01				FA322/4HH*	MD636X	MD636X	MD636XC*				28
748 R (4 pad caliper)	02				FA322/4HH*	MD636X	MD636X	MD636XC*				29
748 Biposto	95-98	FA095			FA095HH	MD2003X	MD2003X	MD2003XC*	MD2003CC*		VR2003BLK†	30
748 Biposto	99-02	FA244*			FA244HH*	MD614X	MD614X	MD614XC*			VR614BLK†	31
748 SP	95-97	FA095*			FA095HH*	MD2003X	MD2003X			MD2003XC	MD2003XC	32
748 SP	98	FA095*			FA095HH*	MD633X	MD633X	MD633XC*				33
748 SP/Monoposto	99-02	FA244*			FA244HH*	MD614X	MD614X	MD614XC*			VR614BLK†	34
748 S (Biposto)	00-02	FA244*			FA244HH*	TBA	TBA					35
748 S (Monoposto)	00-02	FA244*			FA244HH*	TBA	TBA					36
748 SPS	98-99	FA244			FA244HH	MD633X	MD633X	MD633XC*				37
748 Testa Bassa (Mono/Biposto)	01	FA244*			FA244HH*	MD614X	MD614X	MD614XC*			VR614BLK†	38
749 Dark (Monoposto/Biposto)	04-06				FA322/4HH*	MD622X	MD622X	MD622XC*			VR622BLK†	39
749 R (Radial caliper)	04-06				FA322/4HH*	MD622X	MD622X	MD622XC*			VR622BLK†	40
749 S (Monoposto/Biposto)	03-06				FA322/4HH*	MD622X	MD622X	MD622XC*			VR622BLK†	41
749 (Monoposto/Biposto)	03-06				FA322/4HH*	MD622X	MD622X	MD622XC*			VR622BLK†	42
750 Sport (4 bolt disc fixing)	74	FA016			FA016HH	MD634LS						43
750 SS (4 bolt disc fixing) (Note thinner pad version for shaved down caliper)	75-76	FA019*				MD634LS	MD634RS					44
751 F1	98	FA018*			FA018HH*	N/A	N/A					46
750 Paso	87-90	FA018*			FA018HH*	MD630LS	MD630RS					47
750 Sport	88-90	FA018*			FA018HH*	MD630LS	MD630RS					48
750 Supersport (Single disc)	91-98	FA095			FA095HH	MD633X		MD633XC				49
Supersport 750 (Twin disc)	91-98	FA095*			FA095HH*	MD633X	MD633X	MD633XC*				50
750 Supersport	99	FA244*			FA244HH*	MD2003X	MD2003X	MD2003XC*	MD2003CC*		VR2003BLK†	51
750 Supersport IE	00-02	FA244*			FA244HH*	MD614X	MD614X	MD614XC*			VR614BLK†	52
750 Sport	01-02	FA244*			FA244HH*	MD614X	MD614X	MD614XC*			VR614BLK†	53
750 Monster (Single disc)	96-97	FA095			FA095HH	MD2003X		MD2003XC	MD2003CC		VR2003BLK†	54
750 Monster (Twin disc)	96-98	FA095*			FA095HH*	MD2003X	MD2003X	MD2003XC*	MD2003CC*		VR2003BLK†	55
750 Monster City/City Dark	99	FA095*			FA095HH*	MD2003X	MD2003X	MD2003XC*	MD2003CC*		VR2003BLK†	56
750 Monster/Monster Dark	99	FA095*			FA095HH*	MD633X	MD633X	MD633XC*				57
750 Monster	00-01	FA244*			FA244HH*	MD614X	MD614X	MD614XC*			VR614BLK†	58
750 ie Monster	02	FA244*			FA244HH*	MD614X	MD614X	MD614XC*			VR614BLK†	59
796 Hypertotard	10-13	FA244*			FA244HH*	MD865X	MD865X	MD865XC*				60

FRONT / AVANT / VORN / FRENTE / ANTERIORE

R Suffix = High Durability Sintered Pad. HH Suffix = High Performance Sintered Pad. TT Suffix = Hard Wearing Off Road Pad. V Suffix = Semi Sintered Pad. G Suffix = Grooved Shoe.
D Suffix = Drilled Disc. X Suffix = Universal Left or Right Disc. XC Suffix = Contoured Disc. LS Suffix = Left/Steel Disc. RS = Right/Steel Disc.

*-2 Sets Required. † For Vee disc colours add RED, BLU, GRN, GLD, ORG suffix to part number.

⊗ - Also available as a Vintage Motorcycle Disc.

Non-JAPANESE Built Motorcycles

Line #	BRAKE DISC CHOICES - FRONT						DISC PAD CHOICES - REAR				BRAKE DISC CHOICES - REAR			
	OverSize 250 /280mm Disc Kit	OSX OverSize 250/280mm Disc Kit	Relocating Bracket for 250/ 280mm Disc	OverSize 320mm Disc Kit	SMX OverSize 320mm Disc Kit	Relocating Bracket for 320mm Disc	FA, SFA, TT Pad or Brake Shoe	SFAC Carbon Scooter Pads	Speciality Pads - SXR / Vee / MXS	Sintered/ HH Pads/ Grooved Shoes	Standard Replacement Disc	Contour Disc Rear fiment	Vee-Discs™ CONTOUR	CX Extreme MX Race Disc/ UTVX Disc
1							FA047		FA047V	FA047HH	MD2002	MD2002C	VR2002	
2							FA047		FA047V	FA047HH	MD2002	MD2002C	VR2002	
3							FA213			FA213HH	MD899			
4							N/A							
5							FA047		FA047V	FA047HH	N/A			
6							FA047		FA047V	FA047HH				
7							FA047			FA047HH	MD657RS			
8							FA115			FA115HH	N/A			
9							FA047		FA047V	FA047HH	N/A			
10							FA047		FA047V	FA047HH	MD2002	MD2002C		
11							FA047		FA047V	FA047HH	MD2002	MD2002C		
12							FA047		FA047V	FA047HH	MD2002	MD2002C		
13							FA047		FA047V	FA047HH	MD2002	MD2002C	VR2002	
14							FA047		FA047V	FA047HH	MD2002	MD2002C	VR2002	
15							FA047		FA047V	FA047HH	MD2002	MD2002C	VR2002	
16							FA047		FA047V	FA047HH	MD2002	MD2002C	VR2002	
17							FA047		FA047V	FA047HH	MD2002	MD2002C	VR2002	
18							FA047		FA047V	FA047HH	MD2002	MD2002C	VR2002	
19							FA047		FA047V	FA047HH	MD2002	MD2002C	VR2002	
20							FA047		FA047V	FA047HH	MD2002	MD2002C	VR2002	
21							FA047			FA047HH	MD2002	MD2002C	VR2002	
22							FA047			FA047HH	MD2002	MD2002C	VR2002	
23							FA018			FA018HH	N/A			
24							FA047		FA047V	FA047HH	MD899			
25							FA266		FA266V	FA266HH	MD899			
26							FA266		FA266V	FA266HH	MD899			
27							FA047			FA047HH	MD632			
28							FA047			FA047HH	MD632	MD632C		
29							FA047			FA047HH	MD632	MD632C		
30							FA047			FA047HH	MD632	MD632C	VR632	
31							FA047			FA047HH	MD899			
32							FA047			FA047HH	MD632	MD632C		
33							FA047			FA047HH	MD632	MD632C		
34							FA047			FA047HH	MD2002	MD2002C	VR2002	
35							FA047			FA047HH	MD632			
36							FA047			FA047HH	MD632			
37							FA047			FA047HH	MD632	MD632C		
38							FA047			FA047HH	MD632	MD632C	VR632	
39							FA266			FA266HH	MD618		VR618	
40							FA266			FA266HH	MD618		VR618	
41							FA266			FA266HH	MD618		VR618	
42							FA266			FA266HH	MD618		VR618	
43							N/A							
44														
45							FA019				N/A			
46							FA018			FA018HH	N/A			
47							FA047		FA047V	FA047HH	MD631			
48							FA018			FA018HH	MD631			
49							FA047		FA047V	FA047HH	MD2002	MD2002C		
50							FA047		FA047V	FA047HH	MD2002	MD2002C		
51							FA266		FA266V	FA266HH	MD2002	MD2002C	VR2002	
52							FA266		FA266V	FA266HH	MD2002	MD2002C	VR2002	
53							FA266		FA266V	FA266HH	MD2002	MD2002C	VR2002	
54							FA047		FA047V	FA047HH	MD2002	MD2002C	VR2002	
55							FA047		FA047V	FA047HH	MD2002	MD2002C	VR2002	
56							FA047		FA047V	FA047HH	MD2002	MD2002C	VR2002	
57							FA047		FA047V	FA047HH	MD2002	MD2002C	VR2002	
58							FA047		FA047V	FA047HH	MD2002	MD2002C	VR2002	
59							FA047		FA047V	FA047HH	MD2002	MD2002C	VR2002	
60							FA266		FA266V	FA266HH	MD627			

REAR / ARRIÈRE / HINTEN / POSTERIOR / POSTERIORE

R Suffix = High Durability Sintered Pad. HH Suffix = High Performance Sintered Pad. TT Suffix = Hard Wearing Off Road Pad. V Suffix = Semi Sintered Pad. G Suffix = Grooved Shoe.
D Suffix = Drilled Disc. X Suffix = Universal Left or Right Disc. XC Suffix = Contoured Disc. LS Suffix = Left/Steel Disc. RS = Right/Steel Disc.

*-2 Sets Required. † For Vee disc colours add RED, BLU, GRN, GLD, ORG suffix to part number.
⊗ - Also available as a Vintage Motorcycle Disc.

Part numbers, prefixes, suffixes, photos and illustrations shown in this catalogue are trademarks and/or copyrights of EBC Brakes or the trademark owner A C Freeman Investments Ltd and use without express written permission of the owners is punishable by law.

Non-JAPANESE Built Motorcycles



DUCATI



DISC PAD CHOICES - FRONT

BRAKE DISC CHOICES - FRONT

FA, SFA, TT Pad or Brake Shoe	SFAC Carbon Scooter Pads	Speciality Pads - SXR / Vee / MXS	Sintered/HH Pads/ Grooved Shoes	Left / Gauche / Links Standard Replacement Disc	Right / Droite / Rechts Standard Replacement Disc	Contour Disc Universal left and right fitment	Universal Custom Disc	Vee-Discs Black † See note below	CX Extreme MX Race Disc/ UTVX Disc
796 Monster (Non ABS Models)	10-13		FA244H*	MD841X	MD841X	MD841XC*		VR841BLK*†	
796 Monster (ABS Models)	10-14		FA244H*	MD841X	MD841X	MD841XC*		VR841BLK*†	
796 Monster 20th Anniversary Model (Non ABS Models)	13		FA244H*	MD841X	MD841X	MD841XC*		VR841BLK*†	
796 Monster 20th Anniversary Model (ABS Models)	13		FA244H*	MD841X	MD841X	MD841XC*		VR841BLK*†	
797 Monster	17-21		FA630HH*	MD841X	MD841X	MD841XC*		VR841BLK*†	
797+ Monster	18-20		FA630HH*	MD841X	MD841X	MD841XC*		VR841BLK*†	
Monster 800	03-04	FA244*	FA244HH*	MD614X	MD614X	MD614XC*		VR614BLK*†	
Monster S2R (803cc)	05-07	FA181TT*	FA181HH*	MD626X	MD626X	MD626XC*		VR626BLK*†	
Monster S2R Dark (803cc)	05-06	FA181TT*	FA181HH*	MD626X	MD626X	MD626XC*		VR626BLK*†	
800 Sport	03	FA244*	FA244HH*	MD614X	MD614X	MD614XC*		VR614BLK*†	
800 Supersport	03-05	FA244*	FA244HH*	MD614X	MD614X	MD614XC*		VR614BLK*†	
803 Scrambler Café Racer (Spoke Wheels)	17-21		FA630HH	MD868X		MD868XC			
803 Scrambler Classic (Spoke Wheels)	15-20		FA630HH	MD868X		MD868XC			
803 Scrambler Desert Sled (Spoke Wheels)	17-21		FA630HH	MD868X		MD868XC			
803 Scrambler Flat Track Pro	16		FA630HH	MD868X		MD868XC			
803 Scrambler Full Throttle (Cast Wheels)	15-21		FA630HH	MD868X		MD868XC			
803 Scrambler Icon (Cast Wheels)	15-21		FA630HH	MD868X		MD868XC			
803 Scrambler Icon Dark (Cast Wheels)	15-21		FA630HH	MD868X		MD868XC			
803 Scrambler Mach 2 (Cast Wheels)	18-20		FA630HH	MD868X		MD868XC			
803 Scrambler Nightshift (Spoke Wheels)	20-21		FA630HH	MD868X		MD868XC			
803 Scrambler Street Classic (Spoke Wheels)	18-20		FA630HH	MD868X		MD868XC			
803 Scrambler Urban Enduro (Spoke Wheels)	15-16		FA630HH	MD868X		MD868XC			
821 Hypermotard	13-16		FA630HH*	MD841X	MD841X	MD841XC*		VR841BLK*†	
821 Hypermotard SP	13-16		FA630HH*	MD841X	MD841X	MD841XC*		VR841BLK*†	
821 Hyperstrada	13-16		FA630HH*	MD841X	MD841X	MD841XC*		VR841BLK*†	
821 Monster	15-21		FA630HH*	MD841X	MD841X	MD841XC*		VR841BLK*†	
821 Monster Dark	15-20		FA630HH*	MD841X	MD841X	MD841XC*		VR841BLK*†	
821 Monster	21		FA630HH*	MD841X	MD841X	MD841XC*		VR841BLK*†	
821 Monster Stripe	15-21		FA630HH*	MD841X	MD841X	MD841XC*		VR841BLK*†	
848 (Radial 2 pad caliper)	08-10	FA244*	FA244HH*	MD843X	MD843X	MD843XC*		VR843BLK*†	
848 Evo (Monobloc front calipers)	10-13		FA447HH*	MD843X	MD843X	MD843XC*		VR843BLK*†	
848 Evo Corse SE	12-13		FA447HH*	N/A	N/A				
848 Evo Dark	12		FA447HH*	MD843X	MD843X	MD843XC*			
848 Streetfighter	11-15	FA244*	FA244HH*	MD843X	MD843X	MD843XC*		VR843BLK*†	
851 Superbike Biposto	89-92	FA095*	FA095HH*	MD633X	MD633X	MD633XC*			
860 GT/GTS	75-76	FA018*	FA018HH*	MD634LS	MD634RS				
888 SP4/SP5	92-93	FA095*	FA095HH*	MD633X	MD633X	MD633XC*			
888 Superbike Strada	94-95	FA095*	FA095HH*	MD633X	MD633X	MD633XC*			
899 Panigale	14-15		FA630HH*	MD843X	MD843X	MD843XC*		VR843BLK*†	
900 GTS (4 bolt disc fixing) (front & rear)	75-76	FA018*	FA018HH*	MD634LS	MD634RS				
900 Hailwood Replica (6 bolt disc fixing)	79	FA018*	FA018HH*	MD609LS	MD609RS				
900 SS (Note thinner pad version for shaved down caliper)	75-76	FA019*		MD634LS	MD634RS				
900 Supersport	89-90	FA095*	FA095HH*	MD2001X	MD2001X	MD2001XC*	MD2001CC*	VR2001BLK*†	
900 Supersport/Superlight	91-97	FA095*	FA095HH*	MD633X	MD633X	MD633XC*			
900 Supersport	98-99	FA244*	FA244HH*	MD633X	MD633X	MD633XC*			
900 Supersport CR USA	98	FA095*	FA095HH*	MD633X	MD633X	MD633XC*			
900 Supersport FE	98	FA095*	FA095HH*	MD633X	MD633X	MD633XC*			
900 Supersport IE	00-01	FA244*	FA244HH*	MD614X	MD614X	MD614XC*		VR614BLK*†	
900 Sport	02	FA244*	FA244HH*	MD614X	MD614X	MD614XC*		VR614BLK*†	
900 Monster	93-99	FA095*	FA095HH*	MD633X	MD633X	MD633XC*			
900 Monster Cromo/Special	98	FA095*	FA095HH*	MD633X	MD633X	MD633XC*			
900 Monster City/City Dark	99	FA095*	FA095HH*	MD633X	MD633X	MD633XC*			
900 IE Monster	00-01	FA244*	FA244HH*	MD614X	MD614X	MD614XC*		VR614BLK*†	
900 MH Evoluzione	00-01	FA244*	FA244HH*	MD614X	MD614X	MD614XC*		VR614BLK*†	
900 SD Darmah (4 bolt front and rear disc fixing)	77	FA018*	FA018HH*	MD634LS	MD634RS				
900 SD Darmah (6 bolt front disc fixing /4 bolt rear disc fixing)	78	FA018*	FA018HH*	MD609LS	MD609RS				
900 SD Darmah (6 bolt disc fixing front & rear)	78	FA018*	FA018HH*	MD609LS	MD609RS				
906 Paso	88-89	FA018*	FA018HH*	TBA	TBA				
907 IE	90-91	FA095*	FA095HH*	MD2001X	MD2001X	MD2001XC*	MD2001CC*	VR2001BLK*†	

FRONT / AVANT / VORN / FRENTE / ANTERIORE

Line #

R Suffix = High Durability Sintered Pad. **HH** Suffix = High Performance Sintered Pad. **TT** Suffix = Hard Wearing Off Road Pad. **V** Suffix = Semi Sintered Pad. **G** Suffix = Grooved Shoe. **D** Suffix = Drilled Disc. **X** Suffix = Universal Left or Right Disc. **XC** Suffix = Contoured Disc. **LS** Suffix = Left/Steel Disc. **RS** = Right/Steel Disc.

*-2 Sets Required. † For Vee disc colours add RED, BLU, GRN, GLD, ORG suffix to part number.

⊗ - Also available as a Vintage Motorcycle Disc.

Non-JAPANESE Built Motorcycles

Line #	BRAKE DISC CHOICES - FRONT						DISC PAD CHOICES - REAR				BRAKE DISC CHOICES - REAR			
	Oversize 250 /280mm Disc Kit	OSX Oversize 250/280mm Disc Kit	Relocating Bracket for 250/ 280mm Disc	Oversize 320mm Disc Kit	SMX Oversize 320mm Disc Kit	Relocating Bracket for 320mm Disc	FA, SFA, TT Pad or Brake Shoe	SFAC Carbon Scooter Pads	Speciality Pads - SXR / Vee / MXS	Sintered/ HH Pads/ Grooved Shoes	Standard Replacement Disc	Contour Disc Rear fitment	Vee-Discs™ CONTOUR	CX Extreme MX Race Disc/ UTVX Disc
1							FA266		FA266V	FA266HH	MD627	MD627C	VR627	
2							FA266		FA266V	FA266HH	MD878	MD878C	VR878	
3							FA266		FA266V	FA266HH	MD627	MD627C	VR627	
4							FA266		FA266V	FA266HH	MD878	MD878C	VR878	
5							FA213		FA213V	FA213HH	MD899			
6							FA213		FA213V	FA213HH	MD899			
7							FA047		FA047V	FA047HH	MD2002	MD2002C	VR2002	
8							FA047		FA047V	FA047HH	MD627	MD627C	VR627	
9							FA047		FA047V	FA047HH	MD627	MD627C	VR627	
10							FA047		FA047V	FA047HH	MD2002	MD2002C	VR2002	
11							FA266		FA266V	FA266HH	MD2002	MD2002C	VR2002	
12							FA213		FA213V	FA213HH	MD899			
13							FA213		FA213V	FA213HH	MD899			
14							FA213		FA213V	FA213HH	MD899			
15							FA213		FA213V	FA213HH	MD899			
16							FA213		FA213V	FA213HH	MD899			
17							FA213		FA213V	FA213HH	MD899			
18														
19							FA213		FA213V	FA213HH	MD899			
20							FA213		FA213V	FA213HH	MD899			
21							FA213		FA213V	FA213HH	MD899			
22							FA213		FA213V	FA213HH	MD899			
23							FA266		FA266V	FA266HH	MD878	MD878C	VR878	
24							FA266		FA266V	FA266HH	MD878	MD878C	VR878	
25							FA266		FA266V	FA266HH	MD878	MD878C	VR878	
26							FA266		FA266V	FA266HH	MD899			
27							FA266		FA266V	FA266HH	MD899			
28							FA266		FA266V	FA266HH	MD899			
29							FA266		FA266V	FA266HH	MD899			
30							FA266		FA266V	FA266HH	MD627	MD627C	VR627	
31							FA266		FA266V	FA266HH	MD627	MD627C	VR627	
32							FA266		FA266V	FA266HH	MD627	MD627C	VR627	
33							FA266		FA266V	FA266HH	MD627	MD627C	VR627	
34							FA266		FA266V	FA266HH	MD878	MD878C	VR878	
35							FA047		FA047V	FA047HH	MD2002	MD2002C		
36							FA018		FA018V	FA018HH	MD634LS			
37							FA047		FA047V	FA047HH	MD2002	MD2002C		
38							FA047		FA047V	FA047HH	MD2002	MD2002C		
39							FA266		FA266V	FA266HH	MD2002	MD2002C	VR2002	
40							FA018			FA018HH	MD634LS			
41							FA018			FA018HH	MD609LS			
42							FA019				N/A			
43							FA047		FA047V	FA047HH	MD2002	MD2002C	VR2002	
44							FA047		FA047V	FA047HH	MD2002	MD2002C		
45							FA266		FA266V	FA266HH	MD2002	MD2002C		
46							FA047		FA047V	FA047HH	MD2002	MD2002C		
47							FA047		FA047V	FA047HH	MD2002	MD2002C		
48							FA266		FA266V	FA266HH	MD2002	MD2002C	VR2002	
49							FA266		FA266V	FA266HH	MD2002	MD2002C	VR2002	
50							FA047		FA047V	FA047HH	MD2002	MD2002C		
51							FA047		FA047V	FA047HH	MD2002	MD2002C		
52							FA047		FA047V	FA047HH	MD2002	MD2002C		
53							FA047		FA047V	FA047HH	MD2002	MD2002C	VR2002	
54							FA266		FA266V	FA266HH	MD632	MD632C	VR632	
55							FA018			FA018HH	MD634LS			
56														
57							FA018			FA018HH	MD634LS			
58							FA018			FA018HH	MD609LS			
59							FA018			FA018HH	MD631			
60							FA047			FA047HH	MD2002	MD2002C	VR2002	

REAR / ARRIÈRE / HINTEN / POSTERIOR / POSTERIORE

R Suffix = High Durability Sintered Pad. **HH** Suffix = High Performance Sintered Pad. **TT** Suffix = Hard Wearing Off Road Pad. **V** Suffix = Semi Sintered Pad. **G** Suffix = Grooved Shoe.
D Suffix = Drilled Disc. **X** Suffix = Universal Left or Right Disc. **XC** Suffix = Contoured Disc. **LS** Suffix = Left/Steel Disc. **RS** = Right/Steel Disc.

BRAKE APPLICATIONS

*-2 Sets Required. † For Vee disc colours add RED, BLU, GRN, GLD, ORG suffix to part number.
 Ⓢ - Also available as a Vintage Motorcycle Disc.

Non-JAPANESE Built Motorcycles



DUCATI



DISC PAD CHOICES - FRONT

BRAKE DISC CHOICES - FRONT

Line #

		FA, SFA, TT Pad or Brake Shoe	SFAC Carbon Scooter Pads	Speciality Pads - SXR / Vee / MXS	Sintered/HH Pads/ Grooved Shoes	Left / Gauche / Links Standard Replacement Disc	Right / Droite / Rechts Standard Replacement Disc	Contour Disc Universal left and right fitment	Universal Custom Disc	Vee-Discs Black † See note below	CX Extreme MX Race Disc/ UTVX Disc	
907 IE	92-93	FA095*			FA095HH*	MD633X	MD633X	MD633XC*				1
Monster S4 Foggy (916cc)	02	FA244*			FA244HH*	MD624	MD624			VR624BLK†		2
Monster S4 (916cc)	01-02	FA244*			FA244HH*	MD624	MD624			VR624BLK†		3
ST4 (916cc)	99-00	FA244*			FA244HH*	MD633X	MD633X	MD633XC*				4
ST4 (916cc)	01-02	FA244*			FA244HH*	MD614X	MD614X	MD614XC*		VR614BLK*†		5
916 (Biposto)	94-96	FA095*			FA095HH*	MD633X	MD633X	MD633XC*				6
916 Senna	94-98	FA095*			FA095HH*	MD633X	MD633X	MD633XC*				7
916 SP	94-96	FA095*			FA095HH*	MD633X	MD633X	MD633XC*				8
Monster 937cc (New Monster ABS)	21				FA630HH*	MD841X	MD841X	MD841XC*				9
Monster 937cc Plus (New Monster ABS)	21				FA630HH*	MD841X	MD841X	MD841XC*				10
950 Supersport (937cc)	17-21				FA630HH*	MD841X	MD841X	MD841XC*		VR841BLK*†		11
950 Supersport S (937cc)	17-21				FA630HH*	MD841X	MD841X	MD841XC*		VR841BLK*†		12
939 Hypermotard	16-20				FA630HH*					VR841BLK*†		13
939 Hypermotard SP	16-20				FA630HH*	MD841X	MD841X	MD841XC*		VR841BLK*†		14
939 Hyperstrada	16-17				FA630HH*	MD841X	MD841X	MD841XC*		VR841BLK*†		15
ST2 (944cc)	97-99	FA244*			FA244HH*	MD633X	MD633X	MD633XC*				16
ST2 (944cc)	00-03	FA244			FA244HH	MD614X	MD614X	MD614XC*		VR614BLK*†		17
950 Hypermotard 950 937cc	17-21				FA630HH*		MD841X	MD841XC		VR841BLK*†		18
950 Hypermotard 950 RVE	937cc 17-21				FA630HH*		MD841X	MD841XC		VR841BLK*†		19
950 Hypermotard 950 SP	937cc 17-21				FA447HH*							20
950 Multistrada (937cc)	17-21				FA630HH*	MD841X	MD841X	MD841XC*		VR841BLK*†		21
950 Multistrada S (937cc)	19-21				FA630HH*	MD841X	MD841X	MD841XC*		VR841BLK*†		22
959 Panigale (ABS)	16-19				FA630HH*	MD843X	MD843X	MD843XC*		VR843BLK*†		23
959 Panigale Corse (ABS)	18-19				FA630HH*	MD843X	MD843X	MD843XC*		VR843BLK*†		24
955 Panigale V2	19-21				FA630HH*	MD843X	MD843X	MD843XC*		VR843BLK*†		25
955 Panigale V2 Bomber	19-21				FA630HH*	MD843X	MD843X	MD843XC*		VR843BLK*†		26
ST3 (Non ABS) (992cc)	04-07	FA244*			FA244HH*	MD614X	MD614X	MD614XC*		VR614BLK*†		27
ST3S (ABS Model) (992cc)	06-07	FA244*			FA244HH*	MD624	MD624			VR624BLK*†		28
916 SPS (996cc)	97-98	FA095*			FA095HH*	MD2003X	MD2003X	MD2003XC*				29
Monster S4R (996cc) (2 pad caliper)	05-06	FA244*			FA244HH*	MD624	MD624			VR624BLK*†		30
996 SPS (996cc)	99	FA244*			FA244HH*	MD624	MD624			VR624BLK*†		31
996 (996cc) (Monoposto/Biposto)	99-01	FA244*			FA244HH*	MD624	MD624			VR624BLK*†		32
996 R	01				FA322/4HH*	MD636X	MD636X	MD636XC*				33
996 S	01	FA244*			FA244HH*	MD624	MD624			VR624BLK*†		34
Monster S4R (996cc)	03-06	FA244*			FA244HH*	MD624	MD624			VR624BLK*†		35
Panigale Superleggera 998cc	21				FA447HH*	MD694X	MD694X	MD694XC*		VR624BLK*†		36
S4RS Monster (998cc) (Radial 4 pad caliper)	06				FA322/4HH*	MD843X	MD843X	MD843XC*		VR843BLK*†		37
S4R Testastretta Monster (998cc) (Radial 4 pad caliper)	07-08				FA322/4HH*	MD843X	MD843X	MD843XC*		VR843BLK*†		38
S4RS Testastretta Monster (998cc) (Radial 4 pad caliper)	07-				FA322/4HH*	MD843X	MD843X	MD843XC*		VR843BLK*†		39
S4RS (Tricolore/Monster Testastretta) (998cc) (Radial 4 pad caliper)	08				FA322/4HH*	MD843X	MD843X	MD843XC*		VR843BLK*†		40
ST4S (Non ABS/996cc)	01-05	FA244*			FA244HH*	MD624	MD624			VR624BLK*†		42
ST4S (ABS Model/996cc)	03-05	FA244*			FA244HH*	MD624	MD624			VR624BLK*†		43
Desmosedici RR (D16RR/989cc)	08				FA447HH*	MD694X	MD694X	MD694XC*		VR694BLK*†		44
998 Matrix (998cc)	04	FA244*			FA244HH*	MD633X	MD633X	MD633XC*				45
998 R (998cc)	02				FA322/4HH*	TBA	TBA					46
998 S Bayliss/Bostrom	02				FA322/4HH*	MD633X	MD633X	MD633XC*				47
998 S (998cc) (4 pad caliper)	02-04				FA322/4HH*	MD633X	MD633X	MD633XC*				48
998 (998cc) (2 pad caliper) (Monoposto/Biposto)	02-03	FA244			FA244HH	MD633X	MD633X	MD633XC*				49
999 S (Std Caliper Mount) (Monoposto/Biposto)	03-04				FA322/4HH*	MD622X	MD622X	MD622XC*		VR622BLK*†		50
999 (Std mount caliper)	03-06				FA322/4HH*	MD622X	MD622X	MD622XC*		VR622BLK*†		51
999 R (Radial mount caliper)	03-06				FA322/4HH*	MD622X	MD622X	MD622XC*		VR622BLK*†		52
999 R Fila (Radial mount caliper)	03-				FA322/4HH*	MD622X	MD622X	MD622XC*		VR622BLK*†		53
999 R Xerox	06				FA322/4HH*	MD622X	MD622X	MD622XC*		VR622BLK*†		54
999 S (Radial caliper) Monoposto/Biposto	05-06				FA322/4HH*	MD622X	MD622X	MD622XC*		VR622BLK*†		55
1000 R1 Hailwood Replica (6 bolt disc)	84	FA018*			FA018HH*	MD609LS	MD609RS					56
GT 1000 (992cc)	07-10	FA209/2*			FA209/2HH*	MD614X	MD614X	MD614XC*		VR614BLK*†		57
GT 1000 Touring (992cc)	09	FA209/2*			FA209/2HH*	MD614X	MD614X	MD614XC*		VR614BLK*†		58
Monster 1000 Dark	03	FA244*			FA244HH*	MD614X	MD614X	MD614XC*		VR614BLK*†		59
Monster 1000 ie (992cc)	04-05	FA244*			FA244HH*	MD614X	MD614X	MD614XC*		VR614BLK*†		60

FRONT / AVANT / VORN / FRENTE / ANTERIORE

R Suffix = High Durability Sintered Pad. HH Suffix = High Performance Sintered Pad. TT Suffix = Hard Wearing Off Road Pad. V Suffix = Semi Sintered Pad. G Suffix = Grooved Shoe. D Suffix = Drilled Disc. X Suffix = Universal Left or Right Disc. XC Suffix = Contoured Disc. LS Suffix = Left/Steel Disc. RS = Right/Steel Disc.

*-2 Sets Required. † For Vee disc colours add RED, BLU, GRN, GLD, ORG suffix to part number.

⊗ - Also available as a Vintage Motorcycle Disc.

Non-JAPANESE Built Motorcycles

Line #	BRAKE DISC CHOICES - FRONT						DISC PAD CHOICES - REAR				BRAKE DISC CHOICES - REAR			
	Over-size 250 /280mm Disc Kit	OSX Over-size 250/280mm Disc Kit	Relocating Bracket for 250/ 280mm Disc	Over-size 320mm Disc Kit	SMX Over-size 320mm Disc Kit	Relocating Bracket for 320mm Disc	FA, SFA, TT Pad or Brake Shoe	SFAC Carbon Scooter Pads	Speciality Pads - SXR / Vee / MXS	Sintered/ HH Pads/ Grooved Shoes	Standard Replacement Disc	Contour Disc Rear fitment	Vee- Discs™ CONTOUR	CX Extreme MX Race Disc/ UTVX Disc
1							FA047			FA047HH	MD2002	MD2002C		
2							FA047			FA047HH	MD2002		VR2002	
3							FA047			FA047HH	MD2002		VR2002	
4							FA266		FA266V	FA266HH	MD2002	MD2002C		
5							FA266		FA266V	FA266HH	MD2002	MD2002C	VR2002	
6							FA047			FA047HH	MD632	MD632C		
7							FA047			FA047HH	MD632			
8							FA047			FA047HH	MD632	MD632C		
9							FA213		FA213V	FA213HH	MD899			
10							FA213		FA213V	FA213HH	MD899			
11							FA266		FA266V	FA266HH	MD880			
12							FA266		FA266V	FA266HH	MD880			
13							FA266		FA266V	FA266HH	MD878	MD878C	VR878	
14							FA266		FA266V	FA266HH	MD878	MD878C	VR878	
15							FA266		FA266V	FA266HH	MD878	MD878C	VR878	
16							FA266		FA266V	FA266HH	MD2002	MD2002C		
17							FA266		FA266V	FA266HH	MD2002	MD2002C	VR2002	
18							FA266			FA266HH	MD880	MD880C		
19							FA266			FA266HH	MD880	MD880C		
20							FA266			FA266HH	MD880	MD880C		
21							FA181TT			FA181HH				
22							FA181TT			FA181HH				
23							FA266			FA266HH	MD880	MD880C		
24							FA266			FA266HH	MD880	MD880C		
25							FA266			FA266HH	MD880	MD880C		
26							FA266			FA266HH	MD880	MD880C		
27							FA266		FA266V	FA266HH	MD2002	MD2002C	VR2002	
28							FA266		FA266V	FA266HH	MD2002		VR2002	
29							FA047			FA047HH	MD632			
30							FA047			FA047HH	MD627		VR627	
31							FA047			FA047HH	MD632		VR632	
32							FA047			FA047HH	MD632		VR632	
33							FA047			FA047HH	MD632	MD632C		
34							FA047			FA047HH	MD632		VR632	
35							FA047			FA047HH	MD627		VR627	
36							FA266			FA266HH	MD880	MD880C		
37							FA047			FA047HH	MD627	MD627C	VR627	
38							FA047			FA047HH	MD627	MD627C	VR627	
39							FA047			FA047HH	MD627	MD627C	VR627	
40														
41							FA047			FA047HH	MD627	MD627C	VR627	
42							FA266		FA266V	FA266HH	MD2002		VR2002	
43							FA266		FA266V	FA266HH	MD2002		VR2002	
44							FA266		FA266V	FA266HH	MD618	MD618C	VR618	
45							FA047			FA047HH	MD632	MD632C		
46							FA047			FA047HH	MD632			
47							FA047			FA047HH	MD632	MD632C		
48							FA047			FA047HH	MD632	MD632C		
49							FA047			FA047HH	MD632	MD632C		
50							FA266		FA266V	FA266HH	MD618		VR618	
51							FA266		FA266V	FA266HH	MD618		VR618	
52							FA266		FA266V	FA266HH	MD618		VR618	
53							FA266		FA266V	FA266HH	MD618		VR618	
54							FA266		FA266V	FA266HH	MD618		VR618	
55							FA266		FA266V	FA266HH	MD618		VR618	
56							FA018			FA018HH	MD609LS			
57							FA213		FA213V	FA213HH	MD899			
58							FA213		FA213V	FA213HH	MD899			
59							FA047		FA047V	FA047HH	MD2002	MD2002C	VR2002	
60							FA047		FA047V	FA047HH	MD2002	MD2002C	VR2002	

REAR / ARRIÈRE / HINTEN / POSTERIOR / POSTERIORE

R Suffix = High Durability Sintered Pad. HH Suffix = High Performance Sintered Pad. TT Suffix = Hard Wearing Off Road Pad. V Suffix = Semi Sintered Pad. G Suffix = Grooved Shoe.
D Suffix = Drilled Disc. X Suffix = Universal Left or Right Disc. XC Suffix = Contoured Disc. LS Suffix = Left/Steel Disc. RS = Right/Steel Disc.

*-2 Sets Required. † For Vee disc colours add RED, BLU, GRN, GLD, ORG suffix to part number.
⊗ - Also available as a Vintage Motorcycle Disc.

Part numbers, prefixes, suffixes, photos and illustrations shown in this catalogue are trademarks and/or copyrights of EBC Brakes or the trademark owner A C Freeman Investments Ltd and use without express written permission of the owners is punishable by law.

Non-JAPANESE Built Motorcycles



DUCATI Contd.



DISC PAD CHOICES - FRONT

BRAKE DISC CHOICES - FRONT

Line #

		FA, SFA, TT Pad or Brake Shoe	SFAC Carbon Scooter Pads	Speciality Pads - SXR / Vee / MXS	Sintered/HH Pads/ Grooved Shoes	Left / Gauche / Links Standard Replacement Disc	Right / Droite / Rechts Standard Replacement Disc	Contour Disc Universal left and right fitment	Universal Custom Disc	Vee-Discs Black † See note below	CX Extreme MX Race Disc/ UTVX Disc	
Monster 1000 S ie (992cc)	03-05	FA244*			FA244HH*	MD614X	MD614X	MD614XC*		VR614BLK*†		1
Monster S2R 1000 (992cc)	06-08	FA244*			FA244HH*	MD626X	MD626X	MD626XC*		VR626BLK*		2
Multistrada 1000 DS (992cc)	03-05	FA244*			FA244HH*	MD682	MD682					3
Multistrada S 1000 DS (992cc)	05-06	FA244*			FA244HH*	MD682	MD682					4
Paul Smart 1000 LE (992cc)	06	FA209/2*			FA209/2HH*	MD614X	MD614X	MD614XC*		VR614BLK*†		5
Sport 1000 S	07-09	FA209/2*			FA209/2HH*	MD614X	MD614X	MD614XC*		VR614BLK*†		6
Sport Classic 1000 (992cc) (Monoposto - Japan/Biposto - Europe)	06-08	FA209/2*			FA209/2HH*	MD614X	MD614X	MD614XC*		VR614BLK*†		8
Supersport 1000 DS (992cc)	03-06	FA244*			FA244HH*	MD614X	MD614X	MD614XC*		VR614BLK*†		9
1098	07-08				FA447HH*	MD694X	MD694X	MD694XC*		VR694BLK*†		10
1098 S Tricolore	07				FA447HH*	MD694X	MD694X	MD694XC*		VR694BLK*†		11
1098 S	07-08				FA447HH*	MD694X	MD694X	MD694XC*		VR694BLK*†		12
1098 R	08-09				FA447HH*	N/A	N/A					13
1100 Hypermotard	07-09	FA244*			FA244HH*	MD865X	MD865X	MD865XC*				14
1100 S Hypermotard	07-09				FA447HH*	MD865X	MD865X	MD865XC*				15
1100 EVO Hypermotard	10-12	FA244*			FA244HH*	MD865X	MD865X	MD865XC*				16
1100 EVO SP Hypermotard	10-12				FA447HH*	MD865X	MD865X	MD865XC*				17
1100 Monster (Non ABS)	09-10	FA244*			FA244HH*	MD841X	MD841X	MD841XC*		VR841BLK*†		18
1100 Monster (ABS)	09-10	FA244*			FA244HH*	MD841X	MD841X	MD841XC*		VR841BLK*†		19
1100 S Monster (Non ABS)	09-10	FA244*			FA244HH*	MD843X	MD843X	MD843XC*		VR843BLK*†		20
1100 S Monster (ABS)	09-10	FA244*			FA244HH*	MD843X	MD843X	MD843XC*		VR843BLK*†		21
1100 Monster EVO	11-13	FA244*			FA244HH*	MD841X	MD841X	MD841XC*		VR841BLK*†		22
1100 Monster EVO 20th Anniversary Model	13	FA244*			FA244HH*	MD841X	MD841X	MD841XC*		VR841BLK*†		23
1100 Monster Diesel	13	FA244*			FA244HH*	MD841X	MD841X	MD841XC*		VR841BLK*†		24
1100 Multistrada (1078cc)	07-09	FA244*			FA244HH*	MD682	MD682					25
1100 S Multistrada (1078cc)	07-09	FA244*			FA244HH*	MD682	MD682					26
1100 Scrambler Pro (1079cc)	18-21				FA630HH*	MD841X	MD841X	MD841XC*				27
1100 Scrambler Sport Pro (1079cc)	18-21				FA630HH*	MD841X	MD841X	MD841XC*				28
1100 Scrambler Dark Pro (1079cc)	18-21				FA630HH*	MD841X	MD841X	MD841XC*				29
1100 Streetfighter (1099cc)	09-10				FA447HH*	MD694X	MD694X	MD694XC*		VR694BLK*†		30
1100 S Streetfighter (1099cc)	09-13				FA447HH*							31
1103 Panigale V4	18-21				FA447HH*	MD694X	MD694X	MD694XC*		VR694BLK*†		32
1103 Panigale V4 R	21				FA447HH*	MD694X	MD694X	MD694XC*		VR694BLK*†		33
1103 Panigale V4 S	18-21				FA447HH*	MD694X	MD694X	MD694XC*		VR694BLK*†		34
1103 Panigale V4 SP	21				FA447HH*	MD694X	MD694X	MD694XC*		VR694BLK*†		35
Streetfighter V4 (1103cc)	19-21				FA447HH*	MD694X	MD694X	MD694XC*		VR694BLK*†		36
Streetfighter V4 S (1103cc)	19-21				FA447HH*	MD694X	MD694X	MD694XC*		VR694BLK*†		37
Multistrada V4 (1158cc)	21				FA630HH	MD8011X	MD8011X					38
Multistrada V4 S (1158cc)	21				FA447HH	MD8011X	MD8011X					39
Multistrada V4 Sport (1158cc)	21				FA630HH	MD8011X	MD8011X					40
198	09-11				FA447HH*	N/A	N/A					41
1198 R Corse	10				FA447HH*	N/A	N/A					42
1198 S	09-10				FA447HH*	N/A	N/A					43
1198 S Corse	10				FA447HH*	N/A	N/A					44
1198 SP	11				FA447HH*	N/A	N/A					45
1199 Panigale	12-13				FA447HH*	TBA	TBA					46
1199 Panigale ABS	12-15				FA447HH*	TBA	TBA					47
1199 Panigale S ABS	12-15				FA447HH*	TBA	TBA					48
1199 Panigale S Tricolore	12-13				FA447HH*	TBA	TBA					49
1199 Panigale R	13-16				FA447HH*	TBA	TBA					50
1199 Superleggera	14				FA447HH*	N/A	N/A					51
Diavel ABS	11-18				FA447HH*	MD841X	MD841X	MD841XC*		VR841BLK*†		52
Diavel AMG	11-12				FA447HH*	MD841X	MD841X	MD841XC*		VR841BLK*†		53
Diavel Carbon ABS	11-19				FA447HH*	MD841X	MD841X	MD841XC*		VR841BLK*†		54
Diavel Chromo ABS	12				FA447HH*	MD841X	MD841X	MD841XC*		VR841BLK*†		55
Diavel Dark	13-14				FA447HH*	MD841X	MD841X	MD841XC*		VR841BLK*†		56
Diavel Diesel (1200cc)	17-18				FA447HH*	MD841X	MD841X	MD841XC*		VR841BLK*†		57
Diavel Strada	13-14				FA447HH*	MD841X	MD841X	MD841XC*		VR841BLK*†		58
1200 Multistrada Standard Edition	10-11	FA244*			FA244HH*	MD841X	MD841X	MD841XC*		VR841BLK*†		59
1200 Multistrada ABS	10-14	FA244*			FA244HH*	MD841X	MD841X	MD841XC*		VR841BLK*†		60

FRONT / AVANT / VORN / FRENTE / ANTERIORE

R Suffix = High Durability Sintered Pad. HH Suffix = High Performance Sintered Pad. TT Suffix = Hard Wearing Off Road Pad. V Suffix = Semi Sintered Pad. G Suffix = Grooved Shoe. D Suffix = Drilled Disc. X Suffix = Universal Left or Right Disc. XC Suffix = Contoured Disc. LS Suffix = Left/Steel Disc. RS = Right/Steel Disc.

*-2 Sets Required. † For Vee disc colours add RED, BLU, GRN, GLD, ORG suffix to part number.

⊗ - Also available as a Vintage Motorcycle Disc.

Non-JAPANESE Built Motorcycles

Line #	BRAKE DISC CHOICES - FRONT						DISC PAD CHOICES - REAR				BRAKE DISC CHOICES - REAR			
	Oversize 250 /280mm Disc Kit	OSX Oversize 250/280mm Disc Kit	Relocating Bracket for 250/ 280mm Disc	Oversize 320mm Disc Kit	SMX Oversize 320mm Disc Kit	Relocating Bracket for 320mm Disc	FA, SFA, TT Pad or Brake Shoe	SFAC Carbon Scooter Pads	Speciality Pads - SXR / Vee / MXS	Sintered/ HH Pads/ Grooved Shoes	Standard Replacement Disc	Contour Disc Rear fitment	Vee-Discs™ CONTOUR	CX Extreme MX Race Disc/ UTVX Disc
1							FA047		FA047V	FA047HH	MD2002	MD2002C	VR2002	
2							FA047		FA047V	FA047HH	MD627	MD627C	VR627	
3							FA266		FA266V	FA266HH	MD627			
4							FA266		FA266V	FA266HH	MD627			
5							FA213		FA213V	FA213HH	MD2002	MD2002C	VR2002	
6							FA213		FA213V	FA213HH	MD2002	MD2002C	VR2002	
7														
8							FA213		FA213V	FA213HH	MD2002	MD2002C	VR2002	
9							FA266		FA266V	FA266HH	MD2002	MD2002C	VR2002	
10							FA266		FA266V	FA266HH	MD695	MD695C	VR695	
11							FA266		FA266V	FA266HH	MD695	MD695C	VR695	
12							FA266		FA266V	FA266HH	MD695	MD695C	VR695	
13							FA266		FA266V	FA266HH	MD695	MD695C	VR695	
14							FA266		FA266V	FA266HH	MD627			
15							FA266		FA266V	FA266HH	MD627			
16							FA266		FA266V	FA266HH	MD627			
17							FA266		FA266V	FA266HH	MD627			
18							FA266		FA266V	FA266HH	MD627	MD627C	VR627	
19							FA266		FA266V	FA266HH	MD878	MD878C	VR878	
20							FA266		FA266V	FA266HH	MD627	MD627C	VR627	
21							FA266		FA266V	FA266HH	MD878	MD878C	VR878	
22							FA266		FA266V	FA266HH	MD878	MD878C	VR878	
23							FA266		FA266V	FA266HH	MD878	MD878C	VR878	
24							FA266		FA266V	FA266HH	MD878	MD878C	VR878	
25							FA266		FA266V	FA266HH	MD627			
26							FA266		FA266V	FA266HH	MD627			
27							FA213		FA213V	FA213HH	MD899			
28							FA213		FA213V	FA213HH	MD899			
29							FA213		FA213V	FA213HH	MD899			
30							FA266			FA266HH	MD695	MD695C	VR695	
31							FA266			FA266HH	MD695	MD695C	VR695	
32							FA266			FA266HH	MD880	MD880C	VR878	
33							FA266			FA266HH	MD880	MD880C	VR878	
34							FA266			FA266HH	MD880	MD880C	VR878	
35							FA266			FA266HH	MD880	MD880C	VR878	
36							FA266			FA266HH	MD880	MD880C	VR878	
37							FA266			FA266HH	MD878	MD878C	VR878	
38							FA209/2			FA209/2HH	MD8006			
39							FA209/2			FA209/2HH	MD8006			
40							FA209/2			FA209/2HH	MD8006			
41							FA266			FA266HH	MD695	MD695C	VR695	
42							FA266			FA266HH	MD695	MD695C	VR695	
43							FA266			FA266HH	MD695	MD695C	VR695	
44							FA266			FA266HH	MD695	MD695C	VR695	
45							FA266			FA266HH	MD695	MD695C	VR695	
46							FA266			FA266HH	TBA			
47							FA266			FA266HH	TBA			
48							FA266			FA266HH	TBA			
49							FA266			FA266HH	TBA			
50							FA266			FA266HH	TBA			
51							FA266			FA266HH	N/A			
52									FA209/2HH	MD879				
53									FA209/2HH	TBA				
54									FA209/2HH	MD879				
55									FA209/2HH	TBA				
56									FA209/2HH	TBA				
57									FA209/2HH	TBA				
58									FA209/2HH	TBA				
59							FA266			FA266HH	TBA			
60							FA266			FA266HH	TBA			

REAR / ARRIÈRE / HINTEN / POSTERIOR / POSTERIORE

*-2 Sets Required. † For Vee disc colours add RED, BLU, GRN, GLD, ORG suffix to part number.

⊗ - Also available as a Vintage Motorcycle Disc.

Part numbers, prefixes, suffixes, photos and illustrations shown in this catalogue are trademarks and/or copyrights of EBC Brakes or the trademark owner A C Freeman Investments Ltd and use without express written permission of the owners is punishable by law.

R Suffix = High Durability Sintered Pad. HH Suffix = High Performance Sintered Pad. TT Suffix = Hard Wearing Off Road Pad. V Suffix = Semi Sintered Pad. G Suffix = Grooved Shoe.

D Suffix = Drilled Disc. X Suffix = Universal Left or Right Disc. XC Suffix = Contoured Disc. LS Suffix = Left/Steel Disc. RS = Right/Steel Disc.

BRAKE APPLICATIONS

Non-JAPANESE Built Motorcycles



DUCATI Contd.



DISC PAD CHOICES - FRONT

BRAKE DISC CHOICES - FRONT

		FA, SFA, TT Pad or Brake Shoe	SFAC Carbon Scooter Pads	Speciality Pads - SXR / Vee / MXS	Sintered/HH Pads/ Grooved Shoes	Left / Gauche / Links Standard Replacement Disc	Right / Droite / Rechts Standard Replacement Disc	Contour Disc Universal left and right fitment	Universal Custom Disc	Vee-Discs Black † See note below	CX Extreme MX Race Disc/ UTVX Disc	Line #
1200 Multistrada ABS (Single Pin F/Caliper)	15-18				FA630HH*	MD841X	MD841X	MD841XC*		VR841BLK*†		1
1200 Multistrada Granturismo	13	FA244*			FA244HH*	MD841X	MD841X	MD841XC*		VR841BLK*†		2
1200 Multistrada DVT	15-17				FA630HH*	MD841X	MD841X	MD841XC*		VR841BLK*†		3
1200 Multistrada Enduro	16				FA630HH*	MD841X	MD841X	MD841XC*		VR841BLK*†		4
1200 Multistrada Enduro	17-18				FA630HH*	MD841X	MD841X	MD841XC*		VR841BLK*†		5
1200 Multistrada Enduro Pro	18-19				FA630HH*	MD841X	MD841X	MD841XC*		VR841BLK*†		6
1200 S Multistrada DVT	15-17				FA447HH*	MD8011X	MD8011X					7
1200 S Multistrada Sports Edition	10-12	FA244*			FA244HH*	MD8011X	MD8011X	MD841XC*		VR841BLK*†		8
1200 S Multistrada Touring Edition	10-14	FA244*			FA244HH*	MD8011X	MD8011X	MD841XC*		VR841BLK*†		9
1200 Multistrada Touring	15-17	FA244*			FA244HH*	MD841X	MD841X					10
1200 S Multistrada Touring	15-18	FA244*			FA244HH*	MD8011X	MD8011X					11
1200 S Multistrada	15-18				FA447HH*	MD8011X	MD8011X					12
1200 S Multistrada D air	15-17				FA447HH*	MD8011X	MD8011X					13
1200 S Multistrada D air DVT	15-17				FA447HH*	MD8011X	MD8011X					14
1200 S Multistrada Pikes Peak	11-14	FA244*			FA244HH*	MD8011X	MD8011X					15
1200 S Multistrada Pikes Peak	16-17				FA447HH*	MD8011X	MD8011X					16
1200 Monster	14-21				FA630HH*	MD841X	MD841X	MD841XC*		VR841BLK*†		17
1200 S Monster	14-21				FA447HH*	MD841X	MD841X	MD841XC*		VR841BLK*†		18
1200 S Monster Stripe	15-19				FA447HH*	TBA	TBA					19
1200 R Monster	16-18				FA447HH*	MD841X	MD841X	MD841XC*		VR841BLK*†		20
1260 Multistrada	18-21				FA630HH*	MD8011X	MD8011X					21
1260 Multistrada Touring	18				FA630HH*	MD8011X	MD8011X					22
1260 S Multistrada	18-19				FA447HH*	MD8011X	MD8011X					23
1260 S Multistrada D air	18-20				FA447HH*	MD8011X	MD8011X					24
1260 S Multistrada Pikes Peak	18-20				FA447HH*	MD8011X	MD8011X					25
1260 Multistrada Enduro	18-21				FA447HH*	MD8011X	MD8011X					26
1260 Multistrada S Grand Tour	19-21				FA447HH*	MD8011X	MD8011X					27
Diavel (1260cc)	11-21				FA630HH*	MD841X	MD841X	MD841XC		VR841BLK*†		28
Diavel S (1260cc)	20-21				FA630HH*	MD8011X	MD8011X					29
Diavel Diesel (1262cc)	17-18				FA447HH*	MD841X	MD841X	MD841XC*		VR841BLK*†		30
1262 XDiavel	16-21				FA630HH*	MD841X	MD841X	MD841XC*		VR841BLK*†		31
1262 XDiavel S	16-21				FA447HH*	MD841X	MD841X	MD841XC*		VR841BLK*†		32
1262 XDiavel Dark	21				FA447HH*	MD841X	MD841X	MD841XC		VR691BLK*†		33
1262 XDiavel Dark Stark	21				FA447HH*	MD841X	MD841X	MD841XC		VR691BLK*†		34
1299 Panigale	15-18				FA447HH*	MD694X	MD694X	MD691XC*		VR691BLK*†		35
1299 Panigale S	15-18				FA447HH*	MD694X	MD694X	MD691XC*		VR691BLK*†		36
1299 Panigale R	15-17				MD694X	MD694X	MD691XC*			VR691BLK*†		37
1299 Panigale V4 Corse/ Speciale	18-20				FA447HH*	MD694X	MD694X	MD691XC*		VR691BLK*†		38
1299 Panigale V4 R	19-20				FA447HH*	MD694X	MD694X	MD691XC*		VR691BLK*†		39
1299 Panigale R Final Edition	18				FA447HH*	MD694X	MD694X	MD691XC*		VR691BLK*†		40
1299 Superleggera	17				FA447HH*	MD694X	MD694X	MD691XC*		VR691BLK*†		41
												42
												43
EASYRIDER												44
M 50 Monkey/Monkey O.R.	98	H303										44
JC 125/8 Dragon	98	FA093				N/A						45
												46
												47
ECO												48
Bushman 150 (LX 150 GY)		FA135TT				N/A						48
												49
												50
ELSTARS												51
Various models (Check parts before fitting)		FA448				N/A						51
												52
												53
E-MAX												54
90 S	08	SFA086				N/A						54
100 L	08	SFA086				N/A						55
110 S	08	SFA086				N/A						56
120 L	08	SFA086				N/A						57
140 L	08	SFA086				N/A						58
190 L	08	SFA086				N/A						59

FRONT / AVANT / VORN / FRENTE / ANTERIORE

R Suffix = High Durability Sintered Pad. HH Suffix = High Performance Sintered Pad. TT Suffix = Hard Wearing Off Road Pad. V Suffix = Semi Sintered Pad. G Suffix = Grooved Shoe.
D Suffix = Drilled Disc. X Suffix = Universal Left or Right Disc. LS Suffix = Left/Steel Disc. RS = Right/Steel Disc.

*-2 Sets Required. † For Vee disc colours add RED, BLU, GRN, GLD, ORG suffix to part number.

⊗ - Also available as a Vintage Motorcycle Disc.

Non-JAPANESE Built Motorcycles

Line #	BRAKE DISC CHOICES - FRONT						DISC PAD CHOICES - REAR				BRAKE DISC CHOICES - REAR			
	Oversize 250 /280mm Disc Kit	OSX Oversize 250/280mm Disc Kit	Relocating Bracket for 250/ 280mm Disc	Oversize 320mm Disc Kit	SMX Oversize 320mm Disc Kit	Relocating Bracket for 320mm Disc	FA, SFA, TT Pad or Brake Shoe	SFAC Carbon Scooter Pads	Speciality Pads - SXR / Vee / MXS	Sintered/ HH Pads/ Grooved Shoes	Standard Replacement Disc	Contour Disc Rear fitment	Vee-Discs™ CONTOUR	CX Extreme MX Race Disc/ UTVX Disc
1							FA209/2			FA209/2HH	MD879			
2							FA266			FA266HH	TBA			
3							FA181TT			FA181HH	TBA			
4							FA209/2			FA209/2HH	TBA			
5							FA181TT			FA181HH	TBA			
6							FA181TT			FA181HH	TBA			
7							FA181TT			FA181HH	TBA			
8							FA266			FA266HH	MD880	MD880C		
9							FA266			FA266HH	MD880	MD880C		
10							FA181TT			FA181HH	TBA			
11							FA181TT			FA181HH	MD879			
12							FA209/2			FA209/2HH	MD879			
13							FA181TT			FA181HH	MD879			
14							FA209/2			FA209/2HH	MD879			
15							FA266			FA266HH	MD880			
16							FA209/2			FA209/2HH	MD879			
17							FA266	FA266V	FA266V	FA266HH	MD880	MD880C	VR880	
18							FA266	FA266V	FA266V	FA266HH	MD880	MD880C	VR880	
19							FA266	FA266V	FA266V	FA266HH	TBA			
20							FA266	FA266V	FA266V	FA266HH	MD880	MD880C	VR880	
21										FA209/2HH	MD879			
22										FA209/2HH	MD879			
23										FA181HH	MD879			
24										FA209/2HH	MD879			
25										FA209/2HH	MD879			
26										FA209/2HH	TBA			
27										FA209/2HH	MD879			
28										FA209/2HH	MD879			
29										FA209/2HH	MD879			
30										FA209/2HH	MD879			
31							FA209/2			FA209/2HH	MD879			
32							FA209/2			FA209/2HH	MD879			
33							FA209/2			FA209/2HH	MD879			
34							FA209/2			FA209/2HH	MD879			
35							FA266			FA266HH	MD880	MD880C	VR880	
36							FA266			FA266HH	MD880	MD880C	VR880	
37							FA266			FA266HH	MD880	MD880C	VR880	
38										FA266HH	MD880			
39										FA266HH	MD880			
40							FA266			FA266HH	MD880	MD880C	VR880	
41							FA266			FA266HH	MD880	MD880C	VR880	
42														
43														
44							H303							
45							TBA							
46														
47														
48							FA115TT				N/A			
49														
50														
51							FA448				N/A			
52														
53														
54							TBA				SFA083			
55							TBA				SFA083			
56							TBA				SFA083			
57							TBA				SFA083			
58							TBA				SFA083			
59							TBA				SFA083			
60														

REAR / ARRIÈRE / HINTEN / POSTERIOR / POSTERIORE

R Suffix = High Durability Sintered Pad. HH Suffix = High Performance Sintered Pad. TT Suffix = Hard Wearing Off Road Pad. V Suffix = Semi Sintered Pad. G Suffix = Grooved Shoe.
D Suffix = Drilled Disc. X Suffix = Universal Left or Right Disc. XC Suffix = Contoured Disc. LS Suffix = Left/Steel Disc. RS = Right/Steel Disc.

*-2 Sets Required. † For Vee disc colours add RED, BLU, GRN, GLD, ORG suffix to part number.
⊗ - Also available as a Vintage Motorcycle Disc.

Part numbers, prefixes, suffixes, photos and illustrations shown in this catalogue are trademarks and/or copyrights of EBC Brakes or the trademark owner A C Freeman Investments Ltd and use without express written permission of the owners is punishable by law.

Non-JAPANESE Built Motorcycles



ENERGICA



Electric EVA	20
Electric EGO	20
Electric EVA Esse Esse 9	20
Electric EVA Ribelle	21
Electric EVA Ribelle RS	21

E-TON

IXL 40 Rascal	98-01	N/A									
RXL-40 E Viper Junior	01-07	N/A									
Viper 40 E	99-00	N/A									
AXL-50 Lightning 50	99-00	H338*			H338G*						
BXL-50 Draco	05-06	H338*			H338G*						
EXL 50 Viper 50	90	H338*			H338G*						
NXL 50 Lightning 50	01-02	H338*			H338G*						
TXL 50 Wizz 50	98-99	H338*			H338G*						
Viper 50 Mini RXL 50M	03-07	N/A									
Viper 50 RXL 50	03-07	N/A									
Viper 70 RXL 70	05-07	H338			H338G						
AXL 90 Thunder	99-00	H338			H338G						
DXL-90 Sierra	99-03	S614*			S614G*						
NXL-90 Thunder	01-02	H338*			H338G*						
RXL 90 Viper 90	03-07	H338*			H338G*						
RXL 90 R Viper 90 R Reverse	03-07	H338*			H338G*						
BXL 100 Draco	05-06	H338*			H338G*						
CXL 150 Challenger (Rear disc)	02-07	H303*			H303G*						
CXL 150 Challenger (Drum brake model)	02-07	H303*			H303G*						
EXL 150 Yukon S.T. (Rear drum)	05-07	FA083TT*			FA083R*	N/A	N/A				
EXL 150 Eukon ST (Drum front/disc rear)	05-07	S614*			S614G*						
RXL 150 Viper	05-06	H303*			H303G*						
RXL 150 Viper	07	H303*			H303G*						
Viper EXL 150 ST Quad	05-07	FA083TT*			FA083R*	N/A	N/A				
YXL 150 Yukon	00-02	H303*			H303G*						
RXL 150 Viper R	05	H303*			H303G*						
VXL 250 ST Vector	06-07	FA083TT*			FA083R*	N/A	N/A				
VXL Vector 250	06-07	FA083TT*			FA083R*	N/A	N/A				
VXL 300 Vector	07	FA083TT*			FA083R*	TBA	TBA				
VXL 300 ST Vector ST	07	FA083TT*			FA083R*	TBA	TBA				
VTX 300 Vortex	07	FA083TT*			FA083R*	TBA	TBA				
VTX 300 ST Vortex ST	07	FA083TT*			FA083R*	TBA	TBA				

E-TROPOLIS (ELECTRIC SCOOTERS)

Bel-Air	13-14	SFA086	SFAC086				N/A				
Bel-Air Lithium	14	SFA086	SFAC086				N/A				
Future	13	SFA086	SFAC086				N/A				
Miami	13	SFA086	SFAC086			N/A					
Milano	14	SFA086	SFAC086				N/A				
Retro	13-14	SFA086	SFAC086				N/A				
Retro Lithium	14	SFA086	SFAC086				N/A				

EXPLORER

KBR 200	05	FA167			FA167HH	N/A					
Ranger 300 2x4/4x4	08-09	FA416TT*			FA416R*	N/A	N/A				
Trasher 450	08-09	FA067TT*			FA067R*	N/A	N/A				
Atlas 500/4x4	08-09	FA453TT*			FA453R*	N/A	N/A				
Everest 500 L/4x4	08-09	FA453TT*			FA453R*	N/A	N/A				

		DISC PAD CHOICES - FRONT			BRAKE DISC CHOICES - FRONT						Line #	
		FA, SFA, TT Pad or Brake Shoe	SFAC Carbon Scooter Pads	Speciality Pads - SXR / Vee / MXS	Sintered/HH Pads/ Grooved Shoes	Left / Gauche / Links Standard Replacement Disc	Right / Droite / Rechts Standard Replacement Disc	Contour Disc Universal left and right filament	Universal Custom Disc	Vee-Discs Black † See note below		CX Extreme MX Race Disc/ UTVX Disc
FRONT / AVANT / VORN / FRENTE / ANTERIORE												
ENERGICA												
Electric EVA	20				FA447HH*							1
Electric EGO	20				FA447HH*							2
Electric EVA Esse Esse 9	20				FA447HH*							3
Electric EVA Ribelle	21				FA447HH*							4
Electric EVA Ribelle RS	21				FA447HH*							5
E-TON												
IXL 40 Rascal	98-01	N/A										8
RXL-40 E Viper Junior	01-07	N/A										9
Viper 40 E	99-00	N/A										10
AXL-50 Lightning 50	99-00	H338*			H338G*							11
BXL-50 Draco	05-06	H338*			H338G*							12
EXL 50 Viper 50	90	H338*			H338G*							13
NXL 50 Lightning 50	01-02	H338*			H338G*							14
TXL 50 Wizz 50	98-99	H338*			H338G*							15
Viper 50 Mini RXL 50M	03-07	N/A										16
Viper 50 RXL 50	03-07	N/A										17
Viper 70 RXL 70	05-07	H338			H338G							18
AXL 90 Thunder	99-00	H338			H338G							19
DXL-90 Sierra	99-03	S614*			S614G*							20
NXL-90 Thunder	01-02	H338*			H338G*							21
RXL 90 Viper 90	03-07	H338*			H338G*							22
RXL 90 R Viper 90 R Reverse	03-07	H338*			H338G*							23
BXL 100 Draco	05-06	H338*			H338G*							24
CXL 150 Challenger (Rear disc)	02-07	H303*			H303G*							25
CXL 150 Challenger (Drum brake model)	02-07	H303*			H303G*							26
EXL 150 Yukon S.T. (Rear drum)	05-07	FA083TT*			FA083R*	N/A	N/A					27
EXL 150 Eukon ST (Drum front/disc rear)	05-07	S614*			S614G*							28
RXL 150 Viper	05-06	H303*			H303G*							29
RXL 150 Viper	07	H303*			H303G*							30
Viper EXL 150 ST Quad	05-07	FA083TT*			FA083R*	N/A	N/A					31
YXL 150 Yukon	00-02	H303*			H303G*							32
RXL 150 Viper R	05	H303*			H303G*							33
VXL 250 ST Vector	06-07	FA083TT*			FA083R*	N/A	N/A					34
VXL Vector 250	06-07	FA083TT*			FA083R*	N/A	N/A					35
VXL 300 Vector	07	FA083TT*			FA083R*	TBA	TBA					36
VXL 300 ST Vector ST	07	FA083TT*			FA083R*	TBA	TBA					37
VTX 300 Vortex	07	FA083TT*			FA083R*	TBA	TBA					38
VTX 300 ST Vortex ST	07	FA083TT*			FA083R*	TBA	TBA					39
E-TROPOLIS (ELECTRIC SCOOTERS)												
Bel-Air	13-14	SFA086	SFAC086				N/A					42
Bel-Air Lithium	14	SFA086	SFAC086				N/A					43
Future	13	SFA086	SFAC086				N/A					44
Miami	13	SFA086	SFAC086			N/A						45
Milano	14	SFA086	SFAC086				N/A					46
Retro	13-14	SFA086	SFAC086				N/A					47
Retro Lithium	14	SFA086	SFAC086				N/A					48
EXPLORER												
KBR 200	05	FA167			FA167HH	N/A						51
Ranger 300 2x4/4x4	08-09	FA416TT*			FA416R*	N/A	N/A					52
Trasher 450	08-09	FA067TT*			FA067R*	N/A	N/A					53
Atlas 500/4x4	08-09	FA453TT*			FA453R*	N/A	N/A					54
Everest 500 L/4x4	08-09	FA453TT*			FA453R*	N/A	N/A					55
												56
												57
												58
												59
												60

*-2 Sets Required. † For Vee disc colours add RED, BLU, GRN, GLD, ORG suffix to part number.
 ☉ - Also available as a Vintage Motorcycle Disc.

Non-JAPANESE Built Motorcycles

Line #	BRAKE DISC CHOICES - FRONT						DISC PAD CHOICES - REAR				BRAKE DISC CHOICES - REAR			
	OverSize 250 /280mm Disc Kit	OSX OverSize 250/280mm Disc Kit	Relocating Bracket for 250/ 280mm Disc	OverSize 320mm Disc Kit	SMX OverSize 320mm Disc Kit	Relocating Bracket for 320mm Disc	FA, SFA, TT Pad or Brake Shoe	SFAC Carbon Scooter Pads	Speciality Pads - SXR / Vee / MXS	Sintered/ HH Pads/ Grooved Shoes	Standard Replacement Disc	Contour Disc Rear fitment	Vee-Discs™ CONTOUR	CX Extreme MX Race Disc/ UTVX Disc
1							FA266		FA266V	FA266HH				
2							FA266		FA266V	FA266HH				
3							FA266		FA266V	FA266HH				
4							FA266		FA266V	FA266HH				
5							FA266		FA266V	FA266HH				
6														
7														
8							H330			H330G				
9							H330			H330G				
10							H330			H330G				
11														
12							FA083TT			FA083R	N/A			
13							FA083TT			FA083R	TBA			
14							TBA							
15							TBA							
16							FA083TT			FA083R	N/A			
17							FA083TT			FA083R	N/A			
18							FA083TT			FA083R	N/A			
19							H330			H330G				
20							H330			H330G				
21							H330			H330G				
22							FA083TT			FA083R	N/A			
23							FA083TT			FA083R	N/A			
24							FA083TT			FA083R	N/A			
25							FA165TT			FA165R	N/A			
26							H330			H330G				
27							H330			H330G				
28							FA165TT			FA165R	TBA			
29							FA165TT			FA165R	N/A			
30							FA427TT			FA427R	TBA			
31							H330			H330G				
32							H330			H330G				
33							FA165TT			FA165R	N/A			
34							FA427TT			FA427R	N/A			
35							FA427TT			FA427R	N/A			
36							FA427TT			FA427R	TBA			
37							FA427TT			FA427R	TBA			
38							FA427TT			FA427R	TBA			
39							FA427TT			FA427R	TBA			
40														
41														
42							SFA086	SFAC086			N/A			
43							SFA086	SFAC086			N/A			
44							SFA086	SFAC086			N/A			
45							SFA086	SFAC086			N/A			
46							SFA086	SFAC086			N/A			
47							SFA086	SFAC086			N/A			
48							SFA086	SFAC086			N/A			
49														
50														
51							FA115			FA115HH	N/A			
52							FA431TT			FA431R	N/A			
53							FA067TT			FA067R	N/A			
54							FA344TT			FA344R	N/A			
55							FA344TT			FA344R	N/A			
56														
57														
58														
59														
60														

REAR / ARRIÈRE / HINTEN / POSTERIOR / POSTERIORE

R Suffix = High Durability Sintered Pad. HH Suffix = High Performance Sintered Pad. TT Suffix = Hard Wearing Off Road Pad. V Suffix = Semi Sintered Pad. G Suffix = Grooved Shoe.
D Suffix = Drilled Disc. X Suffix = Universal Left or Right Disc. XC Suffix = Contoured Disc. LS Suffix = Left/Steel Disc. RS = Right/Steel Disc.

BRAKE APPLICATIONS

*-2 Sets Required. † For Vee disc colours add RED, BLU, GRN, GLD, ORG suffix to part number.
⊗ - Also available as a Vintage Motorcycle Disc.

Non-JAPANESE Built Motorcycles



FACTORY

Chrono SM 50	04
Phantom R14 Agua	04
RP 50	05
YM 50	05
YR 50 Desert	02-03
YR 50 Desert	04-05
YR 125 4T	05
YR 250 Desert	03

FANTIC

50 Iссimo spoke wheel	
50 Iссimo Alu wheel	
50 Trial	-83
50 Strada Super Six	73-
50 Strada	-82
50 Strada	82-
50 Repl./Enduro Repl.	-85
50 Enduro Competition	-82
50 Enduro	83-
50 Sprinter/3V.R	83-
50 Casa/Competition	75-
50 Caballero	-83
50 Caballero/Caballero RC	91-
Caballero 50 Regularita Competizione	06-09
Caballero Regularita Competizione Mini 50	08-09
Caballero 50 Regularita Casa	06-09
Caballero 50 Supersei Competizione	07-08
Caballero 50 Supersei Motard	06-09
50/50.1 Raider	81-
50.1 Oasis	86-
50.1 Oasis KS/Rally	86-
50.1 Oasis E.S.	87-
50.1 Oasis Kick	87-
50.1 Trial	86-
50.1 Trial H 20	87-
50.5 Trial	89
50.7 Trial	90
50.9 Trial	91-
50 Fast	88-
50 Joy	92-
50 Koala	
50 Clubman	95-
Trial 50 Junior	87-
Trial 50	06
125 E Competition 125cc 4T	21
TX 180 E (49cc/2T) Regularita Casa 50E	12-15
TX 180 ER (49cc/2T) Regularita Competizione 50ER	12-15
TX 180 ES (49cc/2T) Regularita Scuderia 50ES	12-15
TX 180 M (49cc/2T) Motard Casa 50M	12-15
TX 180 MR (49cc/2T) Motard Competizione 50MR	12-15
80 Trial	-83
80 Trial	83-
80 Enduro	80-
80 Caballero/Caballero RC	91-
80 Cross Competition	-81
80 Cross Competition	81-
80 Kaloa	
80 Clubman	95-
Caballero 125 Regularita Competizione	07-09
Caballero 50 Regularita Casa	07-08

DISC PAD CHOICES - FRONT				BRAKE DISC CHOICES - FRONT						Line #
FA, SFA, TT Pad or Brake Shoe	SFAC Carbon Scooter Pads	Speciality Pads - SXR / Vee / MXS	Sintered/HH Pads/ Grooved Shoes	Left / Gauche / Links Standard Replacement Disc	Right / Droite / Rechts Standard Replacement Disc	Contour Disc Universal left and right filament	Universal Custom Disc	Vee-Discs Black † See note below	CX Extreme MX Race Disc/ UTVX Disc	Line #
FA194			FA194HH	N/A						1
FA351TT				N/A						2
FA194			FA194HH	N/A						3
FA194			FA194HH	N/A						4
FA115			FA115HH	N/A						5
FA194			FA194HH	N/A						6
FA194			FA194HH	N/A						7
FA181TT		MXS181	FA181R	N/A						8
										9
										10
945										11
945										12
			926G							13
FA050				N/A						14
			841G							15
FA067/2				N/A						16
			841G							17
			841G							18
			922G							19
909										20
			841G							21
			922G							22
FA047			FA047R	N/A						23
FA181TT		MXS181	FA181R	TBA						24
FA181TT		MXS181	FA181R	N/A						25
FA194			FA194HH	TBA						26
FA181TT		MXS181	FA181R	TBA						27
FA194			FA194HH	TBA						28
FA067/2				N/A						29
FA116				N/A						30
FA116				N/A						31
FA116				N/A						32
FA099				N/A						33
FA099				N/A						34
FA099				N/A						35
FA115			FA115R	N/A						36
FA115			FA115R	N/A						37
FA115			FA115R	N/A						38
FA116				N/A						39
945										40
FA060				N/A						41
FA115			FA115R	N/A						42
			930G							43
FA291				N/A						44
FA185TT		MXS185	FA185R							45
FA465TT		MXS465	FA465R			N/A				46
FA465TT		MXS465	FA465R			N/A				47
FA465TT		MXS465	FA465R			N/A				48
FA465TT		MXS465	FA465R			N/A				49
FA465TT		MXS465	FA465R			N/A				50
		MXS922	922G							51
		MXS930	930G							52
		MXS841	841G							53
FA047			FA047R	N/A						54
			841G							55
			841G							56
FA060				N/A						57
FA115			FA115R	N/A						58
FA181TT		MXS181	FA181R	TBA						59
FA194			FA194HH	TBA						60

FRONT / AVANT / VORN / FRENTE / ANTERIORE

R Suffix = High Durability Sintered Pad. HH Suffix = High Performance Sintered Pad. TT Suffix = Hard Wearing Off Road Pad. V Suffix = Semi Sintered Pad. G Suffix = Grooved Shoe.
D Suffix = Drilled Disc. X Suffix = Universal Left or Right Disc. XC Suffix = Contoured Disc. LS Suffix = Left/Steel Disc. RS = Right/Steel Disc.

*-2 Sets Required. † For Vee disc colours add RED, BLU, GRN, GLD, ORG suffix to part number.

⊗ - Also available as a Vintage Motorcycle Disc.

Non-JAPANESE Built Motorcycles

Line #	BRAKE DISC CHOICES - FRONT						DISC PAD CHOICES - REAR				BRAKE DISC CHOICES - REAR			
	Oversize 250 /280mm Disc Kit	OSX Oversize 250/280mm Disc Kit	Relocating Bracket for 250/ 280mm Disc	Oversize 320mm Disc Kit	SMX Oversize 320mm Disc Kit	Relocating Bracket for 320mm Disc	FA, SFA, TT Pad or Brake Shoe	SFAC Carbon Scooter Pads	Speciality Pads - SXR / Vee / MXS	Sintered/ HH Pads/ Grooved Shoes	Standard Replacement Disc	Contour Disc Rear fitment	Vee-Discs™ CONTOUR	CX Extreme MX Race Disc/ UTVX Disc
1							FA115			FA115HH	N/A			
2							FA115				N/A			
3							FA115			FA115HH	N/A			
4							FA115			FA115HH	N/A			
5							FA115			FA115HH	N/A			
6							FA115			FA115HH	N/A			
7							FA115			FA115HH	N/A			
8							FA208TT		MXS208	FA208R	N/A			
9														
10														
11							945							
12							945							
13										922G				
14										843G				
15										841G				
16										843G				
17										841G				
18										841G				
19										922G				
20							909							
21										841G				
22										922G				
23							FA060				N/A			
24							FA367TT		MXS367	FA367R	TBA			
25							FA367TT		MXS367	FA367R	N/A			
26							FA382				TBA			
27							FA367TT		MXS367	FA367R	TBA			
28							FA382				TBA			
29							930G							
30							FA060				N/A			
31							930G							
32							FA060				N/A			
33							995							
34							930G							
35							995							
36							FA115			FA115R	N/A			
37							FA115			FA115R	N/A			
38							FA115			FA115R	N/A			
39										841G				
40							945							
41							FA060				N/A			
42							FA115			FA115R	N/A			
43										930G				
44							FA291				N/A			
45							FA131TT		MXS131	FA131R				
46							FA346TT			FA346R	N/A			
47							FA346TT			FA346R	N/A			
48							FA346TT			FA346R	N/A			
49							FA346TT			FA346R	N/A			
50							FA346TT			FA346R	N/A			
51										922G				
52										930G				
53										843G				
54							FA060				N/A			
55										841G				
56										843G				
57							FA060							
58							FA115			FA115R				
59							FA367TT		MXS367	FA367R	TBA			
60							FA382				TBA			

REAR / ARRIÈRE / HINTEN / POSTERIOR / POSTERIORE

R Suffix = High Durability Sintered Pad. **HH** Suffix = High Performance Sintered Pad. **TT** Suffix = Hard Wearing Off Road Pad. **V** Suffix = Semi Sintered Pad. **G** Suffix = Grooved Shoe.
D Suffix = Drilled Disc. **X** Suffix = Universal Left or Right Disc. **XC** Suffix = Contoured Disc. **LS** Suffix = Left/Steel Disc. **RS** = Right/Steel Disc.

*-2 Sets Required. † For Vee disc colours add RED, BLU, GRN, GLD, ORG suffix to part number.

⊗ - Also available as a Vintage Motorcycle Disc.

Part numbers, prefixes, suffixes, photos and illustrations shown in this catalogue are trademarks and/or copyrights of EBC Brakes or the trademark owner A C Freeman Investments Ltd and use without express written permission of the owners is punishable by law.

Non-JAPANESE Built Motorcycles



FANTIC Contd.



DISC PAD CHOICES - FRONT

BRAKE DISC CHOICES - FRONT

R Suffix = High Durability Sintered Pad. **HH** Suffix = High Performance Sintered Pad. **TT** Suffix = Hard Wearing Off Road Pad. **V** Suffix = Semi Sintered Pad. **G** Suffix = Grooved Shoe.

D Suffix = Drilled Disc. **X** Suffix = Universal Left or Right Disc. **XC** Suffix = Contoured Disc. **LS** Suffix = Left/Steel Disc. **RS** = Right/Steel Disc.

FRONT / AVANT / VORN / FRENTE / ANTERIORE

		FA, SFA, TT Pad or Brake Shoe	SFAC Carbon Scooter Pads	Speciality Pads - SXR / Vee / MXS	Sintered/HH Pads/ Grooved Shoes	Left / Gauche / Links Standard Replacement Disc	Right / Droite / Rechts Standard Replacement Disc	Contour Disc Universal left and right fitment	Universal Custom Disc	Vee-Discs Black † See note below	CX Extreme MX Race Disc/ UTVX Disc	Line #
Caballero 125 Supersei Motard	07-09	FA194			FA194HH	TBA						1
Caballero 125 Deluxe	17-22	FA606			FA606HH							2
Caballero 125 Flat Track	17-22	FA606			FA606HH							3
Caballero 125 Scrambler	17-22	FA606			FA606HH							4
Trial 125		841G										5
Trial 125/2		FA099				N/A						6
Section 125/249 R	-95	FA115			FA115R	N/A						7
TR 125 CR (2T) Cross Competizione	13	FA465TT		MXS465	FA465R			N/A				8
TR 125 MR (2T) Motard Competizione	13	FA465TT		MXS465	FA465R			N/A				9
TZ 125 CS (2T) Caballero Cross	11-12	FA465TT		MXS465	FA465R			N/A				10
TZ 125 ES (2T) Regolarita Scuderia	11-12	FA465TT		MXS465	FA465R			N/A				11
TZ 125 SM (2T) Caballero Motard	11-12	FA095			FA095HH							12
125 E Competition 125cc 4T	21	FA185TT			FA185R							13
XE 125 125cc 2T	21	FA755TT		FA755R	MXS755			MD6392C			MD6392CX	14
XX 125 125cc 2T	21	FA755TT		FA755R	MXS755			MD6392C			MD6392CX	15
TZ 170 E (125 E/4T) Regolarita Casa	11-15	FA465TT		MXS465	FA465R			N/A				16
TZ 170 ER (125 ER/4T) Caballero Regolarita Competizione	11-15	FA465TT		MXS465	FA465R			N/A				17
TZ 170 M (125 SM/4T) Motard Casa	11-15	FA465TT		MXS465	FA465R			N/A				18
TZ 170 MR (125 SM/4T) Motard Competizione	11-15	FA465TT		MXS465	FA465R			N/A				19
200					841G							20
TZ 200 ER (200 ER/4T) Caballero Regolarita Competizione	11-15	FA465TT		MXS465	FA465R			N/A				21
TZ 200 MR (200 MR/4T) Motard	11-15	FA465TT		MXS465	FA465R			N/A				22
201 Monoshock	86	FA099				N/A						23
240					841G							24
Trial 243	87-	FA099				N/A						25
Casa E 250cc 4T Carb model	17	FA664TT			FA664R							26
Casa Efi 250cc 4T Injection model	17	FA185TT			FA185R							27
250 E Competition 250cc 4T	21	FA185TT		MXS185	FA185R							28
TF 250 ES (4T)	11-13	FA465TT		MXS465	FA465R			N/A				29
TR 250 ES (2T) Enduro Six Day	13	FA465TT		MXS465	FA465R			N/A				30
XX 250 2T 270 F/Disc, 245 R/Disc	21-22	FA755TT		MXS755	FA755R			MD6392C			MD6392CX	31
XEF 250 4T 270 F/Disc, 245 R/Disc	21-22	FA755TT		MXS755	FA755R			MD6392C			MD6392CX	32
XEX 250 4T 270 F/Disc, 245 R/Disc	21-22	FA755TT		MXS755	FA755R			MD6392C			MD6392CX	33
TR 300 ES (2T) Enduro Six Day	13	FA465TT		MXS465	FA465R			N/A				34
TZ 300 ES Regolarita Scuderia	11-12	FA465TT		MXS465	FA465R			N/A				35
300 Trial												36
301 Monoshock	86	FA099				N/A						37
303 Monoshock	87	FA099				N/A						38
125.5/245/305	89	FA115			FA115R	N/A						39
All series 7 models	90	FA115			FA115R	N/A						40
309	92	FA115			FA115R	N/A						41
K-R00 All Models	92-95	FA115			FA115R	N/A						42
Section 125/249 R	95-	FA115			FA115R	N/A						43
XEF 450 4T 270 F/Disc, 245 R/Disc	21-22	FA755TT		MXS755	FA755R			MD6392C			MD6392CX	44
XXF 450 4T 270 F/Disc, 245 R/Disc	21-22	FA755TT		MXS755	FA755R			MD6392C			MD6392CX	45
Caballero 500 Anniversary	17-22	FA606			FA606HH							46
Caballero 500 Deluxe	17-22	FA606			FA606HH							47
Caballero 500 Flat Track	17-22	FA606			FA606HH							48
Caballero 500 Rally	17-22	FA606			FA606HH							49
Caballero 500 Scrambler	17-22	FA606			FA606HH							50
FB MINARELLI (SPAIN)												51
Rieju Marathon	74-	985										52
MR 80		FA115			FA115R	N/A						53
												54
												55
												56
												57
												58
												59
												60

*-2 Sets Required. † For Vee disc colours add RED, BLU, GRN, GLD, ORG suffix to part number.

⊗ - Also available as a Vintage Motorcycle Disc.

Non-JAPANESE Built Motorcycles

Line #	BRAKE DISC CHOICES - FRONT						DISC PAD CHOICES - REAR				BRAKE DISC CHOICES - REAR			
	Oversize 250 /280mm Disc Kit	OSX Oversize 250/280mm Disc Kit	Relocating Bracket for 250/ 280mm Disc	Oversize 320mm Disc Kit	SMX Oversize 320mm Disc Kit	Relocating Bracket for 320mm Disc	FA, SFA, TT Pad or Brake Shoe	SFAC Carbon Scooter Pads	Speciality Pads - SXR / Vee / MXS	Sintered/ HH Pads/ Grooved Shoes	Standard Replacement Disc	Contour Disc Rear fitment	Vee-Discs™ CONTOUR	CX Extreme MX Race Disc/ UTVX Disc
1							FA382				TBA			
2							FA213		FA213V	FA213HH				
3							FA213		FA213V	FA213HH				
4							FA213		FA213V	FA213HH				
5							841G							
6							FA099			FA099R	N/A			
7							FA115			FA115R	N/A			
8							FA346TT			FA346R		N/A		
9							FA346TT			FA346R		N/A		
10							FA346TT			FA346R		N/A		
11							FA346TT			FA346R		N/A		
12							FA346TT			FA346R		N/A		
13							FA131TT		MXS131	FA131R				
14		OSX6392C	BRK046				FA367TT		MXS367	FA367R		MD6190C	MD6190CX	
15		OSX6392C	BRK046				FA367TT		MXS367	FA367R		MD6190C	MD6190CX	
16							FA346TT			FA346R		N/A		
17							FA346TT			FA346R		N/A		
18							FA346TT			FA346R		N/A		
19							FA346TT			FA346R		N/A		
20										841G				
21							FA346TT			FA346R		N/A		
22							FA346TT			FA346R		N/A		
23										841G				
24										841G				
25							FA099			FA099R	N/A			
26							FA346TT		MXS346	FA346R				
27														
28							FA131TT		MXS131	FA131R				
29							FA346TT			FA346R		N/A		
30							FA346TT			FA346R		N/A		
31		OSX6392C	BRK046				FA367TT		MXS367	FA367R		MD6190C	MD6190CX	
32		OSX6392C	BRK046				FA367TT		MXS367	FA367R		MD6190C	MD6190CX	
33		OSX6392C	BRK046				FA367TT		MXS367	FA367R		MD6190C	MD6190CX	
34							FA346TT			FA346R		N/A		
35							FA346TT			FA346R		N/A		
36										841G				
37										841G				
38							FA099			FA099R	N/A			
39							FA115			FA115R	N/A			
40							FA115			FA115R	N/A			
41							FA115			FA115R	N/A			
42							FA115			FA115R	N/A			
43							FA115			FA115R	N/A			
44		OSX6392C	BRK046				FA367TT		MXS367	FA367R		MD6190C	MD6190CX	
45		OSX6392C	BRK046				FA367TT		MXS367	FA367R		MD6190C	MD6190CX	
46							FA213		FA213V	FA213HH				
47							FA213		FA213V	FA213HH				
48							FA213		FA213V	FA213HH				
49							FA213	FA213V		FA213HH				
50							FA213	FA213V		FA213HH				
51														
52														
53							985							
54										936G				
55														
56														
57														
58														
59														
60														

REAR / ARRIÈRE / HINTEN / POSTERIOR / POSTERIORE

R Suffix = High Durability Sintered Pad. HH Suffix = High Performance Sintered Pad. TT Suffix = Hard Wearing Off Road Pad. V Suffix = Semi Sintered Pad. G Suffix = Grooved Shoe.
D Suffix = Drilled Disc. X Suffix = Universal Left or Right Disc. XC Suffix = Contoured Disc. LS Suffix = Left/Steel Disc. RS = Right/Steel Disc.

*-2 Sets Required. † For Vee disc colours add RED, BLU, GRN, GLD, ORG suffix to part number.
⊗ - Also available as a Vintage Motorcycle Disc.

Part numbers, prefixes, suffixes, photos and illustrations shown in this catalogue are trademarks and/or copyrights of EBC Brakes or the trademark owner A C Freeman Investments Ltd and use without express written permission of the owners is punishable by law.

Non-JAPANESE Built Motorcycles



FYM/X-SPORT



DISC PAD CHOICES - FRONT

BRAKE DISC CHOICES - FRONT

R Suffix = High Durability Sintered Pad. **HH** Suffix = High Performance Sintered Pad. **TT** Suffix = Hard Wearing Off Road Pad. **V** Suffix = Semi Sintered Pad. **G** Suffix = Grooved Shoe.

D Suffix = Drilled Disc. **X** Suffix = Universal Left or Right Disc. **XC** Suffix = Contoured Disc. **LS** Suffix = Left/Steel Disc. **RS** = Right/Steel Disc.

FRONT / AVANT / VORN / FRENTE / ANTERIORE

	FA, SFA, TT Pad or Brake Shoe	SFAC Carbon Scooter Pads	Speciality Pads - SXR / Vee / MXS	Sintered/HH Pads/ Grooved Shoes	Left / Gauche / Links Standard Replacement Disc	Right / Droite / Rechts Standard Replacement Disc	Contour Disc Universal left and right fitment	Universal Custom Disc	Vee-Discs Black † See note below	CX Extreme MX Race Disc/ UTVX Disc
CR 90 E	SFA169	SFAC169		SFA169HH	N/A					
110 ES R X-Sport	SFA169	SFAC169		SFA169HH	N/A					
110 ES	SFA169	SFAC169		SFA169HH	N/A					
CR 110	SFA169	SFAC169		SFA169HH	N/A					
CR 110 ESR	SFA169	SFAC169		SFA169HH	N/A					
X-Sport CR3	TBA				N/A					
CR 125 R	SFA169	SFAC169		SFA169HH	N/A					
CR3 125	SFA169	SFAC169		SFA169HH	N/A					
FYM 125 EY-5 (X Sport CR3/CR125)	SFA169	SFAC169		SFA169HH	N/A					
X-Sport Typhoon 125 Quad	SFA169*	SFAC169*		SFA169HH*	N/A	N/A				
GARELLI										
Queenie	SFA083	SFAC083		SFA083HH	MD904D			VR904		
Grinta	SFA083	SFAC083		SFA083HH	MD904D			VR904		
Capri 50 (DF50QT-7)	SFA169	SFAC169		SFA169HH	TBA					
Capri LX 50	SFA169	SFAC169		SFA169HH	TBA					
Ciclone 50	SFA169	SFAC169		SFA169HH	TBA					
Flexi 50	SFA235	SFAC235			TBA					
FLO 50	SFA193	SFAC193		SFA193HH	MD916D					
FX 50	SFA169	SFAC169		SFA169HH	MD923D			VR923		
GSP 50 (2T)	SFA235	SFAC235					TBA			
KRS 50	SFA264	SFAC264	FA264V	SFA264HH	MD923D			VR923		
Tiesse 50 (2T)	SFA235	SFAC235			N/A					
Tiesse 50 (4T)	SFA235	SFAC235			N/A					
VIP 50	SFA235	SFAC235			TBA					
VIP 50	SFA169	SFAC169		SFA169HH	N/A					
XO 50	SFA235	SFAC235			TBA					
XO 50 (2T/4T - TM50QT-31)	SFA235	SFAC235			TBA					
XO 50'e (Electric)	SFA086	SFAC086		SFA086HH	TBA					
Comfort 125	SFA086	SFAC086		SFA086HH			N/A			
Freeland 125/150	SFA264	SFAC264		SFA264HH	MD923D			VR923		
Joker 125/150	SFA264	SFAC264		SFA264HH	N/A					
Panther 125/150/250	SFA257	SFAC257			N/A					
Skynet 250/400	SFA281	SFAC281		SFA281HH	N/A					
Eureka, Gulp	908									
50 Ciclone/KL 50 SV				926G						
50 Vip/Noi/Basic spoke wheel	908									
50 Vip/Noi/Basic Alu Wheel	931			931G						
Junior Turismo	909									
Gran Turismo				926G						
50 Tiger XLE	FA256				N/A					
Formuno 50 till chassis no. 2701551	N/A									
Formuno 50 from chassis no. 2701552	N/A									
50 Team Matic	877									
Sahel 50	FA116				N/A					
Urka 50	FA047			FA047R	N/A					
Sahel 80	FA116									
Flexi 125	SFA235	SFAC235			TBA					
RSX 125				821G						
Strada/Sport 125	N/A				N/A					
TSR 125	FA076			FA076HH	N/A					
TSR 125	N/A				N/A					
125 XR/XRD Tiger	FA047			FA047R	N/A					
125 Tiger XLE	FA256				N/A					
Tiger 125	FA197			FA197HH	N/A					
GTA 125	FA060*				N/A					
GTA 125	FA060*				N/A					
XO 125i (TM 125 T)	SFA086	SFAC086		SFA086HH	N/A					
Fashion 150	SFA054	SFAC054		FA054HH		N/A				
Mosquito 150	FA086			FA086HH	N/A					

Line #

*-2 Sets Required. † For Vee disc colours add RED, BLU, GRN, GLD, ORG suffix to part number.

⊗ - Also available as a Vintage Motorcycle Disc.

Non-JAPANESE Built Motorcycles

Line #	BRAKE DISC CHOICES - FRONT						DISC PAD CHOICES - REAR				BRAKE DISC CHOICES - REAR			
	OverSize 250 /280mm Disc Kit	OSX OverSize 250/280mm Disc Kit	Relocating Bracket for 250/ 280mm Disc	OverSize 320mm Disc Kit	SMX OverSize 320mm Disc Kit	Relocating Bracket for 320mm Disc	FA, SFA, TT Pad or Brake Shoe	SFAC Carbon Scooter Pads	Speciality Pads - SXR / Vee / MXS	Sintered/ HH Pads/ Grooved Shoes	Standard Replacement Disc	Contour Disc Rear fitment	Vee-Discs™ CONTOUR	CX Extreme MX Race Disc/ UTVX Disc
1							H338			H338G				
2							SFA115	SFAC115		SFA115HH	N/A			
3							H338			H338G				
4							SFA115	SFAC115		SFA115HH	N/A			
5							SFA115	SFAC115		SFA115HH	N/A			
6							SFA115	SFAC115		SFA115HH	N/A			
7							SFA115	SFAC115		SFA115HH	N/A			
8							SFA115	SFAC115		SFA115HH	N/A			
9							SFA115	SFAC115		SFA115HH	N/A			
10							SFA115	SFAC115		SFA115HH	N/A			
11														
12														
13							Y503							
14							Y503							
15							TBA							
16							TBA							
17							TBA							
18							TBA							
19							TBA							
20							Y503							
21							SFA115	SFAC115			TBA			
22							S624							
23							Y503							
24							Y503							
25							TBA							
26							TBA							
27							Y503							
28							SFA235	SFAC235			N/A			
29							SFA101	SFAC101		SFA101HH	N/A			
30							TBA							
31							S624							
32							TBA							
33							TBA							
34							SFA193			SFA193HH	N/A			
35							908							
36										926G				
37							908							
38							931			931G				
39							909							
40										926G				
41							FA099				N/A			
42							931			931G				
43							931			931G				
44							931			931G				
45							FA115			FA115R	N/A			
46							N/A							
47							FA115			FA115R	N/A			
48							TBA							
49										821G				
50							921							
51							921							
52							921							
53							N/A							
54							FA060				N/A			
55							FA197			FA197HH	N/A			
56														
57							FA060				N/A			
58							SFA101	SFAC101		SFA101HH	N/A			
59							TBA							
60							TBA							

REAR / ARRIÈRE / HINTEN / POSTERIOR / POSTERIORE

R Suffix = High Durability Sintered Pad. **HH** Suffix = High Performance Sintered Pad. **TT** Suffix = Hard Wearing Off Road Pad. **V** Suffix = Semi Sintered Pad. **G** Suffix = Grooved Shoe.
D Suffix = Drilled Disc. **X** Suffix = Universal Left or Right Disc. **XC** Suffix = Contoured Disc. **LS** Suffix = Left/Steel Disc. **RS** = Right/Steel Disc.

*-2 Sets Required. † For Vee disc colours add RED, BLU, GRN, GLD, ORG suffix to part number.
 Ⓢ - Also available as a Vintage Motorcycle Disc.

Part numbers, prefixes, suffixes, photos and illustrations shown in this catalogue are trademarks and/or copyrights of EBC Brakes or the trademark owner A C Freeman Investments Ltd and use without express written permission of the owners is punishable by law.

Non-JAPANESE Built Motorcycles



GARELLI Contd.



DISC PAD CHOICES - FRONT

BRAKE DISC CHOICES - FRONT

Line #

		FA, SFA, TT Pad or Brake Shoe	SFAC Carbon Scooter Pads	Speciality Pads - SXR / Vee / MXS	Sintered/HH Pads/ Grooved Shoes	Left / Gauche / Links Standard Replacement Disc	Right / Droite / Rechts Standard Replacement Disc	Contour Disc Universal left and right fitment	Universal Custom Disc	Vee-Disks Black † See note below	CX Extreme MX Race Disc/ UTVX Disc
XO 150i (TM 150 T)	09-12	SFA086	SFAC086		SFA086HH	N/A					
XO 200i (TM 200 T)	10-12	SFA086	SFAC086		SFA086HH	N/A					
Trial 320	-85				841G						
Trial 323	86-	FA115			FA115R	N/A					
GAS-GAS											
MC-E 5 Electric	21	FA325TT			FA325R						
Cross MC 50	06	FA291				N/A					
EC 50 (Boy)	01-04	FA291				N/A					
EC 50 Boy (Air Cooled)	05	FA115		MXS115	FA115HH	N/A					
EC 50 Boy (LC)	05-07	FA303TT				N/A					
EC 50 (Rookie)	01-04	FA167			FA167HH	N/A					
EC 50	05	FA194			FA194HH	N/A					
EC 50	06-07	FA115TT			FA115R	N/A					
J50 Quad	06	TBA*									
MC 50 50cc	21	FA325TT			FA325R						
Quad Wild HP 50	04-07	FA181TT*		MXS181	FA181R*	N/A					
SM 50 (Rookie)	01-04	FA167			FA167HH	N/A					
SM 50	05	FA194			FA194HH	N/A					
TXT 50 (Boy)	01	FA291				N/A					
TXT 50 (Boy)	04-15	FA115TT		MXS115	FA115R	N/A					
TXT 50 (Rookie)	02-03	FA291				N/A					
TXT 50 (Rookie)	04-08	FA303TT				N/A					
TXT 50 (Cadet)	06-09	FA115TT		MXS115	FA115R	N/A					
TXE (Electric Bike)	20	FA291									
Cross MC 65	06	FA351TT				N/A					
MC 65 65cc	21	FA357TT			FA357R			MD6379C			MD6243CX
MX 65 (MC)	05-08	FA351TT				N/A					
TXT 80 (Rookie)	02-03	FA291				N/A					
TXT 80 (Rookie)	04-09	FA303TT				N/A					
TXT 80 Cadet	06	FA351TT				N/A					
TXT 80 Cadet	07-09	FA303TT				N/A					
TXT 80 Pro Racing (2T)	15	FA303TT				N/A					
MC 85 85cc	21	FA612TT			FA612R			MD6032C			MD6032CX
Enduro EC 125/200/250/300 (Brembo)	97-99	FA181TT		MXS181	FA181R	N/A					
EC 125/200/250/300 (Nissin/2T)	00-08	FA185TT		MXS185	FA185R	MD6289D		MD6289C			
EC 125/200/250/300 (Nissin/2T)	09-10	FA185TT		MXS185	FA185R	MD6289D		MD6289C			
EC 125/200/250/300 (All Models/2T)	11-15	FA185TT		MXS185	FA185R			MD6289C			
JTX 125/200/270/320	95-98	FA115TT		MXS115	FA115R	N/A					
MC 125 125cc	21	FA181TT		MXS181	FA181R			MD6032C			MD6032CX
MX 125/250 (MC)	01-08	FA185TT		MXS185	FA185R	MD6289D					
MX 125/250 (MC)	09-11	FA185TT		MXS185	FA185R	MD6289D					
Pampera 125/250/370	96-97	FA115TT		MXS115	FA115R	N/A					
Pampera 125/250/280	04	FA194			FA194HH	N/A					
Pampera 125 (2T)	05-08	FA194			FA194HH	TBA					
SM 125 (2T) Supermotard	03-06	FA095			FA095HH	MD6209D					
SM Halley 125cc	09	FA095			FA095HH	N/A					
Trail Halley 125cc	09	FA185TT		MXS185	FA185R	N/A					
TXT 125 Randonne (4T)	11-15	FA303TT				N/A					
TXT 125/200/249/280/321	00-03	FA291				N/A					
TXT 125/200/250/280/300 (TXT Pro)	04-11	FA303TT				N/A					
TXT 125/250/280/300											
(For All models with AJP caliper/2 pin pad fixing)	12-13	FA303TT				N/A					
TXT 125/250/280/300 (For All models with Formula caliper/1 pin pad fixing)	12-14	FA612TT			FA612R	N/A					
TXT 125/250/280/300 Replica Factory Models (2T Monobloc Caliper)	13-14	FA644TT						N/A			
TXT 125/250/280/300 Racing Models (2T Monobloc Caliper)	14-19	FA644TT						N/A			
TXT GP 125 2T Trials Machine	20	FA291									

FRONT / AVANT / VORN / FRENTE / ANTERIORE

R Suffix = High Durability Sintered Pad. HH Suffix = High Performance Sintered Pad. TT Suffix = Hard Wearing Off Road Pad. V Suffix = Semi Sintered Pad. G Suffix = Grooved Shoe.

D Suffix = Drilled Disc. X Suffix = Universal Left or Right Disc. XC Suffix = Contoured Disc. LS Suffix = Left/Steel Disc. RS = Right/Steel Disc.

*-2 Sets Required. † For Vee disc colours add RED, BLU, GRN, GLD, ORG suffix to part number.

⊗ - Also available as a Vintage Motorcycle Disc.

Non-JAPANESE Built Motorcycles

Line #	BRAKE DISC CHOICES - FRONT						DISC PAD CHOICES - REAR				BRAKE DISC CHOICES - REAR			
	Oversize 250 /280mm Disc Kit	OSX Oversize 250/280mm Disc Kit	Relocating Bracket for 250/ 280mm Disc	Oversize 320mm Disc Kit	SMX Oversize 320mm Disc Kit	Relocating Bracket for 320mm Disc	FA, SFA, TT Pad or Brake Shoe	SFAC Carbon Scooter Pads	Speciality Pads - SXR / Vee / MXS	Sintered/ HH Pads/ Grooved Shoes	Standard Replacement Disc	Contour Disc Rear fitment	Vee-Discs™ CONTOUR	CX Extreme MX Race Disc/ UTVX Disc
1							SFA101	SFAC101		SFA101HH	N/A			
2							SFA101	SFAC101		SFA101HH	N/A			
3										841G				
4										930G				
5														
6														
7							FA325TT			FA325R				
8							FA351TT				N/A			
9							FA291				N/A			
10							FA351TT				N/A			
11							FA351TT				N/A			
12							FA291				N/A			
13							FA291				N/A			
14							FA351TT				N/A			
15							FA115TT			FA115R	N/A			
16							FA325TT			FA325R				
17							FA181TT		MXS181	FA181R	N/A			
18							FA291				N/A			
19							FA291				N/A			
20							FA291				N/A			
21							FA115TT		MXS115	FA115R	N/A			
22							FA291				N/A			
23							FA351TT				N/A			
24							FA351TT				N/A			
25							FA351TT							
26							FA351TT				N/A			
27							FA357TT			FA357R				
28							FA115				N/A			
29							FA291				N/A			
30							FA351TT				N/A			
31							FA351TT				N/A			
32							FA351TT				N/A			
33							FA351TT				N/A			
34							FA602TT			FA602R		MD6249C		
35							FA208TT		MXS208	FA208R	MD6253D			
36							FA131TT		MXS131	FA131R	MD6253D	MD6253C		
37							FA367TT		MXS367	FA367R	MD6253D	MD6253C		
38							FA367TT		MXS367	FA367R		MD6253C		
39							FA115TT		MXS115	FA115R	N/A			
40							FA368TT			FA368R		MD6360C		
41							FA131TT		MXS131	FA131R	MD6253D			
42							FA367TT		MXS367	FA367R	MD6253D			
43							FA115TT		MXS115	FA115R	N/A			
44							FA291				N/A			
45							FA131TT		MXS131	FA131R	TBA			
46							FA131TT		MXS131	FA131R	MD6253D			
47							FA131TT		MXS131	FA131R	N/A			
48							FA131TT		MXS131	FA131R	N/A			
49							FA351TT				N/A			
50							FA291				N/A			
51							FA351TT				N/A			
52														
53							FA351TT				N/A			
54														
55							FA351TT				N/A			
56														
57							FA351TT				N/A			
58														
59							FA351TT				N/A			
60							FA351TT							

REAR / ARRIÈRE / HINTEN / POSTERIOR / POSTERIORE

R Suffix = High Durability Sintered Pad. HH Suffix = High Performance Sintered Pad. TT Suffix = Hard Wearing Off Road Pad. V Suffix = Semi Sintered Pad. G Suffix = Grooved Shoe.
D Suffix = Drilled Disc. X Suffix = Universal Left or Right Disc. XC Suffix = Contoured Disc. LS Suffix = Left/Steel Disc. RS = Right/Steel Disc.

BRAKE APPLICATIONS

*-2 Sets Required. † For Vee disc colours add RED, BLU, GRN, GLD, ORG suffix to part number.
⊗ - Also available as a Vintage Motorcycle Disc.

Non-JAPANESE Built Motorcycles



GAS-GAS Contd.



DISC PAD CHOICES - FRONT

BRAKE DISC CHOICES - FRONT

R Suffix = High Durability Sintered Pad. **HH** Suffix = High Performance Sintered Pad. **TT** Suffix = Hard Wearing Off Road Pad. **V** Suffix = Semi Sintered Pad. **G** Suffix = Grooved Shoe.

D Suffix = Drilled Disc. **X** Suffix = Universal Left or Right Disc. **XC** Suffix = Contoured Disc. **LS** Suffix = Left/Steel Disc. **RS** = Right/Steel Disc.

FRONT / AVANT / VORN / FRENTE / ANTERIORE

GAS-GAS (Pierer Mobility)

Model	Year	FA, SFA, TT Pad or Brake Shoe	SFAC Carbon Scooter Pads	Speciality Pads - SXR / Vee / MXS	Sintered/HH Pads/ Grooved Shoes	Left / Gauche / Links Standard Replacement Disc	Right / Droite / Rechts Standard Replacement Disc	Contour Disc Universal left and right fitment	Universal Custom Disc	Vee-Discs Black † See note below	CX Extreme MX Race Disc/ UTVX Disc	Line #
TXT-E (Full Size Electric Bike)	12-14	FA303TT				N/A						1
TXT Racing 125 2T Trials Machine	21	FA291										2
EC 200-250-300 XC 250-300 Euro4	18-20	FA185TT		MXS185	FA185R							3
EC Ranger 200/300	18-20	FA185TT		MXS185	FA185R							4
MX 200/250/300	99-00	FA185TT		MXS185	FA185R	N/A						5
TX 200/270/320	98	FA115TT		MXS115	FA115R	N/A						6
TXT 200/270/321	99	FA291				N/A						7
TXT 200 Randonne (4T)	11-15	FA303TT				N/A						8
XC 200/250/300	20	FA185TT		MXS185	FA185R							9
Contact JT25 (238cc)	93-94	FA115TT		MXS115	FA115R	N/A						10
Contact RR 250/280	20	FA303TT										11
TXT Racing 250 2T Trials Machine	21	FA291										12
TXT GP 250 2T Trials Machine	20	FA291										13
EC 250 250cc 2T	21	FA181TT		MXS181	FA181R			MD6032C			MD6032CX	14
EC 250 F 250cc 4T	21	FA181TT		MXS181	FA181R			MD6032C			MD6032CX	15
EC Six Days 250/300	19	FA185TT		MXS185	FA185R							16
EC Cami 250F (4T)	14-15	FA465TT		MXS465	FA465R			N/A				17
EC 250 F (All Models/4T)	12-15	FA185TT		MXS185	FA185R			N/A				18
Quad HP 240	04-06	FA181TT*		MXS181	FA181R*	N/A	N/A					19
KS 250 RV Quad	06	FA135TT			FA135R	N/A	N/A					20
		FA165TT			FA165R							21
MC 250 F 250cc 4T	21	FA181TT		MXS181	FA181R			MD6032C			MD6032CX	22
Pampera 250/320	98-99	FA115TT		MXS115	FA115R	N/A	N/A					23
Pampera 250	02-03	FA194			FA194HH	N/A						24
TXT 250 Contact (4T)	15	FA303TT						N/A				25
TXT Racing 280 2T Trials Machine	21	FA291										26
TXT GP 280 2T Trials Machine	20	FA291										27
EC 300 F (All Models/4T)	13-15	FA185TT		MXS185	FA185R			N/A				28
EC 300 2T	21	FA181TT		MXS181	FA181R			MD6032C			MD6032CX	29
TXT Racing 300 2T Trials Machine	21	FA291										30
TXT GP 300 2T Trials Machine	20	FA291										31
Quad HP 300 RV	03-06	FA181TT*		MXS181	FA181R*	N/A	N/A					32
EC 350 F 4T	21	FA181TT		MXS181	FA181R			MD6032C			MD6032CX	33
Pampera 400	06	FA181TT		MXS181	FA181R	N/A						34
SM 400 FSE (2T)	01-02	FA095			FA095HH	MD6209D						35
EC 450 FSR (4T) Enduro/FSE	05-09	FA185TT		MXS185	FA185R	MD6289D		N/A				36
EC 450 F (All Models/4T)	13-15	FA185TT		MXS185	FA185R			N/A				37
EC 450 Raid (4T)	14	FA185TT		MXS185	FA185R							38
MC 450 F 4T	21	FA181TT		MXS181	FA181R			MD6032C			MD6032CX	39
Pampera 450 (4T)	07-08	FA185TT		MXS185	FA185R	MD6289D						40
SM 450 FSR (4T) Supermotard	07-09	FA095			FA095HH	MD6209D						41
SM Halley 450cc	09	FA185TT		MXS185	FA185R	N/A						42
Trail Halley 450cc	09	FA185TT		MXS185	FA185R	N/A						43
Wild HP 450 Quad	04-09	FA181TT*		MXS181	FA181R*	TBA	TBA					44
EC 515 FSR/FSE (4T) Enduro	05-09	FA185TT		MXS185	FA185R	MD6289D						45
SM 515 FSR (4T) Supermotard	07-09	FA095			FA095HH	MD6209D						46
Wild HP 515cc Quad	09	FA181TT		MXS181	FA181R	N/A	N/A					47
												48
												49
MC-E 5 Electric	21	FA325TT			FA325R							50
MC 50	21	FA325TT			FA325R							51
MC 65	21	FA357TT			FA357R			MD6379C			MD6243CX	52
MC 85	21	FA612TT			FA612R			MD6032C			MD6032CX	53
MC 125	21	FA181TT			FA181R			MD6032C			MD6032CX	54
EC 250 2T	21	FA181TT			FA181R			MD6032C			MD6032CX	55
EC 250 F 4T	21	FA181TT			FA181R			MD6032C			MD6032CX	56
MC 250 F 4T	21	FA181TT			FA181R			MD6032C			MD6032CX	57
EC 300 2T	21	FA181TT			FA181R			MD6032C			MD6032CX	58
EC 350 F 4T	21	FA181TT			FA181R			MD6032C			MD6032CX	59
MC 450 F 4T	21	FA181TT			FA181R			MD6032C			MD6032CX	60

*-2 Sets Required. † For Vee disc colours add RED, BLU, GRN, GLD, ORG suffix to part number.

⊗ - Also available as a Vintage Motorcycle Disc.

Non-JAPANESE Built Motorcycles

Line #	BRAKE DISC CHOICES - FRONT						DISC PAD CHOICES - REAR				BRAKE DISC CHOICES - REAR			
	Oversize 250 /280mm Disc Kit	OSX Oversize 250/280mm Disc Kit	Relocating Bracket for 250/ 280mm Disc	Oversize 320mm Disc Kit	SMX Oversize 320mm Disc Kit	Relocating Bracket for 320mm Disc	FA, SFA, TT Pad or Brake Shoe	SFAC Carbon Scooter Pads	Speciality Pads - SXR / Vee / MXS	Sintered/ HH Pads/ Grooved Shoes	Standard Replacement Disc	Contour Disc Rear fitment	Vee-Discs™ CONTOUR	CX Extreme MX Race Disc/ UTVX Disc
1							FA351TT					N/A		
2							FA351TT							
3							FA367TT		MXS367	FA367R				
4							FA367TT		MXS367	FA367R				
5							FA131TT		MXS131	FA131R	MD6253D			
6							FA115TT		MXS115	FA115R	N/A			
7							FA291				N/A			
8							FA351TT					N/A		
9							FA367TT		MXS367	FA367R				
10							FA115TT		MXS115	FA115R	N/A			
11							FA351TT							
12							FA351TT							
13							FA351TT							
14							FA368TT			FA368R		MD6035C		MD6035CX
15							FA368TT			FA368R		MD6035C		MD6035CX
16							FA367TT		MXS367	FA367R				
17							FA093					N/A		
18							FA367TT		MXS367	FA367R		N/A		
19							FA181TT		MXS181	FA181R	N/A			
20							TBA							
21														
22							FA368TT			FA368R		MD6035C		MD6035CX
23							FA115TT		MXS115	FA115R	N/A			
24							FA291				N/A			
25							FA351TT					N/A		
26							FA351TT							
27							FA351TT							
28							FA367TT		MXS367	FA367R		N/A		
29							FA368TT			FA368R		MD6035C		MD6035CX
30							FA351TT							
31							FA351TT							
32							FA181TT		MXS181	FA181R	N/A			
33							FA368TT			FA368R		MD6035C		MD6035CX
34							FA131TT		MXS131	FA131R	N/A			
35							FA131TT		MXS131	FA131R	MD6253D			
36							FA131TT		MXS131	FA131R	TBA			
37							FA367TT		MXS367	FA367R		N/A		
38							FA367TT		MXS367	FA367R		N/A		
39							FA368TT			FA368R		MD6035C		MD6035CX
40							FA131TT		MXS131	FA131R	TBA			
41							FA131TT		MXS131	FA131R	MD6253D			
42							FA131TT		MXS131	FA131R	N/A			
43							FA131TT		MXS131	FA131R	N/A			
44							FA181TT		MXS181	FA181R	TBA			
45							FA131TT		MXS131	FA131R	TBA			
46							FA131TT		MXS131	FA131R	MD6253D			
47							FA181TT		MXS181	FA181R	N/A			
48														
49														
50							FA325TT			FA325R				
51							FA325TT			FA325R				
52							FA357TT			FA357R				
53							FA602TT			FA602R		MD6249C		
54							FA368TT			FA368R		MD6360C		
55							FA368TT			FA368R		MD6035C		MD6035CX
56							FA368TT			FA368R		MD6035C		MD6035CX
57							FA368TT			FA368R		MD6035C		MD6035CX
58							FA368TT			FA368R		MD6035C		MD6035CX
59							FA368TT			FA368R		MD6035C		MD6035CX
60							FA368TT			FA368R		MD6035C		MD6035CX

REAR / ARRIÈRE / HINTEN / POSTERIOR / POSTERIORE

R Suffix = High Durability Sintered Pad. **HH** Suffix = High Performance Sintered Pad. **TT** Suffix = Hard Wearing Off Road Pad. **V** Suffix = Semi Sintered Pad. **G** Suffix = Grooved Shoe.
D Suffix = Drilled Disc. **X** Suffix = Universal Left or Right Disc. **XC** Suffix = Contoured Disc. **LS** Suffix = Left/Steel Disc. **RS** = Right/Steel Disc.

*-2 Sets Required. † For Vee disc colours add RED, BLU, GRN, GLD, ORG suffix to part number.
 Ⓢ - Also available as a Vintage Motorcycle Disc.

Part numbers, prefixes, suffixes, photos and illustrations shown in this catalogue are trademarks and/or copyrights of EBC Brakes or the trademark owner A C Freeman Investments Ltd and use without express written permission of the owners is punishable by law.

Non-JAPANESE Built Motorcycles



GAS-GAS (Pierer Mobility) Contd.



DISC PAD CHOICES - FRONT

BRAKE DISC CHOICES - FRONT

R Suffix = High Durability Sintered Pad. **HH** Suffix = High Performance Sintered Pad. **TT** Suffix = Hard Wearing Off Road Pad. **V** Suffix = Semi Sintered Pad. **G** Suffix = Grooved Shoe.

D Suffix = Drilled Disc. **X** Suffix = Universal Left or Right Disc. **XC** Suffix = Contoured Disc. **LS** Suffix = Left/Steel Disc. **RS** = Right/Steel Disc.

Model	Year	FA, SFA, TT Pad or Brake Shoe	SFAC Carbon Scooter Pads	Speciality Pads - SXR / Vee / MXS	Sintered/HH Pads/ Grooved Shoes	Left / Gauche / Links Standard Replacement Disc	Right / Droite / Rechts Standard Replacement Disc	Contour Disc Universal left and right filament	Universal Custom Disc	Vee-Discs Black † See note below	CX Extreme MX Race Disc/ UTVX Disc
TXT Racing 125 2T Trials Machine	21	FA291									
TXT GP 125 2T Trials Machine	20	FA291									
TXT Racing 250 2T Trials Machine	21	FA291									
TXT GP 250 2T Trials Machine	20	FA291									
TXT Racing 280 2T Trials Machine	21	FA291									
TXT GP 280 2T Trials Machine	20	FA291									
TXT Racing 300 2T Trials Machine	21	FA291									
TXT GP 300 2T Trials Machine	20	FA291									
GENERIC / KSR											
TTX (Electric)	16-18	SFA086									
Vionis (Electric)	18	SFA086									
Classic 50	17-18	SFA086	SFAC086		SFA086HH						
Cracker 50 (2T/4T)	09-18	SFA235	SFAC235			MD923D				VR923	
Demonio 50	17-18	FA707									
50 GT Race Explorer	09	SFA235	SFAC235			MD971D				VR971	
Epico 50 (2T)	10-18	SFA235	SFAC235			TBA					
Epico Electric	12-13	SFA235	SFAC235			TBA					
Ideo 50	05-14	SFA235	SFAC235			MD923D				VR923	
Mini Trigger SM 50	08-09	FA448				N/A					
Mini Trigger X 50	08-09	FA448				N/A					
Pandora 50 (2T/4T)	13-18	SFA235	SFAC235			N/A					
Jump 50 (2T)	12-18	SFA083	SFAC083		SFA083HH	TBA					
Onyx 50 (2T/4T)	10-18	SFA193	SFAC193		SFA193HH	TBA					
Race 2 50 (2T/4T)	10-14	SFA235	SFAC235			TBA					
Roc 50	08-11	SFA235	SFAC235			MD923D				VR923	
Sirion 50 (2T/4T)	12-20	SFA235	SFAC235							VR923	
Toxic 50	07-08	FA194			FA194HH	N/A					
Toxic 50 Sport (2T)	12-18	SFA235	SFAC235			TBA					
Trigger SM50 (All Models)	06-18	FA194			FA194HH	TBA					
Trigger X50 (All Models/TR X 50)	06-18	FA194			FA194HH	TBA					
Vendetta 50 (2T)	12-13	SFA264	SFAC264		SFA264HH	TBA					
Vertigo 50 (4T)	12-14	SFA086	SFAC086			N/A					
XOR 50 (2T)	05-14	SFA235	SFAC235			MD923D				VR923	
Madison 110 (4T)	13-14	SFA086	SFAC086		SFA086HH		N/A				
Venos 110 (4T)	13-14	SFA086	SFAC086		SFA086HH		N/A				
Inox 125 (4T)	12-14	SFA228	SFAC228		SFA228HH		N/A	N/A			
Classic 125	17-18	FA707									
Code 125	17-20	FA707									
Code S 125/150/200 (4T)	12-16	FA658		FA658V	FA658HH			N/A			
Code X 125/150/200 (4T)	12-16	FA658		FA658V	FA658HH						
Demonio 125	17-18	FA707									
GRS 125	13-16	FA658		FA658V	FA658HH			N/A			
GRS 125	17-20	FA707									
Race 2 125 (4T)	10-14	SFA235	SFAC235			TBA					
Race 2 125 (4T) GT	18	SFA707									
Sirion 125 (4T) Rear Drum	12-18	SFA235	SFAC235							VR923	
Sirion 125 (4T) Rear Disc	18-20	SFA707									
Soho 125/150	06-15	SFA235	SFAC235			TBA		N/A			
TR 125 SM (4T)	12-16	FA228			FA228HH						
TR 125 SM (4T)	17-18	FA707									
Trigger 125 SM	08-09	FA194			FA194HH	N/A					
Trigger 125 X	08-09	FA194			FA194HH	N/A					
TR 125 X	17-18	FA707									
TW 125 SM	13-16	TBA						N/A			
TW 125 SM	17-20	FA707									
Vertigo 125	13-18	SFA086	SFAC086		SFA086HH	N/A					
Worx 125	17-18	FA711		FA711V							
Worx 125/150 (4T)	12-16	FA197			FA197HH		N/A				
XOR 125	05-11	SFA235	SFAC235			MD923D				VR923	

FRONT / AVANT / VORN / FRENTE / ANTERIORE

Line #

*-2 Sets Required. † For Vee disc colours add RED, BLU, GRN, GLD, ORG suffix to part number.

⊗ - Also available as a Vintage Motorcycle Disc.

Non-JAPANESE Built Motorcycles

Line #	BRAKE DISC CHOICES - FRONT						DISC PAD CHOICES - REAR				BRAKE DISC CHOICES - REAR			
	Oversize 250 /280mm Disc Kit	OSX Oversize 250/280mm Disc Kit	Relocating Bracket for 250/ 280mm Disc	Oversize 320mm Disc Kit	SMX Oversize 320mm Disc Kit	Relocating Bracket for 320mm Disc	FA, SFA, TT Pad or Brake Shoe	SFAC Carbon Scooter Pads	Speciality Pads - SXR / Vee / MXS	Sintered/ HH Pads/ Grooved Shoes	Standard Replacement Disc	Contour Disc Rear fitment	Vee-Discs™ CONTOUR	CX Extreme MX Race Disc/ UTVX Disc
1							FA351TT							
2							FA351TT							
3							FA351TT							
4							FA351TT							
5							FA351TT							
6							FA351TT							
7							FA351TT							
8							FA351TT							
9														
10														
11							SFA086							
12							Y503							
13							Y503							
14							Y503							
15							SFA083							
16							Y503							
17							Y503							
18							Y503							
19							Y503							
20							FA448			N/A				
21							FA448			N/A				
22							Y503							
23							Y503							
24							Y503							
25							Y503							
26							Y503							
27							Y503							
28							FA060			N/A				
29							Y503			N/A				
30							FA060			TBA				
31							FA060			TBA				
32							Y503							
33							Y503							
34							Y503							
35							TBA							
36							TBA							
37							TBA							
38							SFA415							
39							FA197							
40							FA298				N/A			
41							FA298				N/A			
42							SFA083							
43							SFA298		SFA298HH		N/A			
44							FA298							
45							Y503							
46							SFA083							
47							Y503							
48							SFA083							
49							Y527							
50							FA298		SFA298HH		N/A			
51							FA298							
52							FA060			N/A				
53							FA060			N/A				
54							FA298							
55							FA298					N/A		
56							FA298							
57							Y503							
58							FA197							
59							FA298							
60							Y527							

REAR / ARRIÈRE / HINTEN / POSTERIOR / POSTERIORE

R Suffix = High Durability Sintered Pad. **HH** Suffix = High Performance Sintered Pad. **TT** Suffix = Hard Wearing Off Road Pad. **V** Suffix = Semi Sintered Pad. **G** Suffix = Grooved Shoe.
D Suffix = Drilled Disc. **X** Suffix = Universal Left or Right Disc. **XC** Suffix = Contoured Disc. **LS** Suffix = Left/Steel Disc. **RS** = Right/Steel Disc.

*-2 Sets Required. † For Vee disc colours add RED, BLU, GRN, GLD, ORG suffix to part number.
 Ⓢ - Also available as a Vintage Motorcycle Disc.

Part numbers, prefixes, suffixes, photos and illustrations shown in this catalogue are trademarks and/or copyrights of EBC Brakes or the trademark owner A C Freeman Investments Ltd and use without express written permission of the owners is punishable by law.

Non-JAPANESE Built Motorcycles



GENERIC/KSR Contd.



DISC PAD CHOICES - FRONT

BRAKE DISC CHOICES - FRONT

		FA, SFA, TT Pad or Brake Shoe	SFAC Carbon Scooter Pads	Speciality Pads - SXR / Vee / MXS	Sintered/HH Pads/ Grooved Shoes	Left / Gauche / Links Standard Replacement Disc	Right / Droite / Rechts Standard Replacement Disc	Contour Disc Universal left and right fitment	Universal Custom Disc	Vee-Discs Black † See note below	CX Extreme MX Race Disc/ UTVX Disc	Line #
Zion 125/150 (Rear Drum Model)	08-10	SFA228	SFAC228		SFA228HH	N/A						1
Zion 125/150 (Rear Disc Model)	11-16	SFA228	SFAC228		SFA228HH	N/A						2
GRS 150	13-15	FA658		FA658V	FA658HH			N/A				3
GRS 600	13-14				FA322/4HH*	N/A	N/A					4
GILERA												
Built 50	90-	FA099				N/A						7
CBA 50		908										8
ec1 50		908										9
ECO 50		908										10
503 50cc	91-	FA099				N/A						11
50 GR 2		922										12
50 GSA/Vale		909										13
50 Rally	87-	FA047/2				N/A						14
SMT 50 Supermotard	03-06	FA115			FA115HH	N/A						15
R1/50	90-	FA047/2				N/A						16
50 RC Top Rally	90-	FA173				N/A						17
50 Trend	89-	909										18
50 Trial/Enduro		909										19
DNA 50 (Grimeca Caliper)	01-06	SFA194	SFAC194		SFA194HH	MD944D				VR944		20
DNA 50 (Heng Tong Caliper)	01-05	SFA353	SFAC353		SFA353HH	MD944D				VR944		21
Eaglet 50	96	FA099				N/A						22
Easy Moving 50	95-96	SFA193	SFAC193		SFA193HH	MD904D				VR904		23
GSM 50	99-01	FA115			FA115HH	N/A						24
GSM 50	02-03	FA115			FA115HH	N/A						25
H@K 50	00-02	FA115			FA115HH	N/A						26
Zulu 50	01-02	FA115			FA115HH	N/A						27
Ice 50cc	01-02	SFA193	SFAC193		SFA193HH	MD910D		MD910C		VR910		28
Runner 50 (5 Bolt Fixing On Front Disc)	98	SFA193	SFAC193		SFA193HH	MD924D				VR924		29
Runner/Purejet 50 DD/SP (5 Bolt Fixing On Front Disc)	99-05	SFA193	SFAC193		SFA193HH	MD924D				VR924		30
Runner 50 PJ/SP (6 Bolt Fixing On Front Disc)	06-14	SFA353	SFAC353		SFA353HH	MD956D				VR956		31
Stalker 50 (Rear disc models) (Grimeca calipers)	97-06	SFA193	SFAC193		SFA193HH	MD9126D						32
Stalker 50 (Rear Drum Model) (Grimeca calipers)	97-06	SFA193	SFAC193		SFA193HH	MD9126D						33
Stalker 50 (Rear disc model) (Heng Tong caliper)	03-06	SFA083/2			SFA083/2HH	MD9126D						34
Stalker 50 (Rear drum model) (Heng Tong caliper)	03-11	SFA083/2			SFA083/2HH	MD9126D						35
RCR 50 Enduro	03-06	FA115			FA115HH	N/A						36
RK 50 Cannibal	96-98	FA115			FA115HH	N/A						37
RV 50 NGR	88	FA060*				N/A	N/A					38
SKP 50	98	SFA193	SFAC193		SFA193HH	MD943D		MD943C		VR943		39
SKP 50	99-01	SFA193	SFAC193		SFA193HH	MD943D		MD943C		VR943		40
SMT 50 Supermotard	03-06	FA115			FA115HH	N/A						41
SMT 50	07	FA115			FA115HH	N/A						42
Storm 50	94-95	SFA193	SFAC193		SFA193HH	MD943D		MD943C		VR943		43
Typhoon 50 All models	93-95	SFA193	SFAC193		SFA193HH	MD901D				VR901		44
Typhoon 50	96-	SFA193	SFAC193		SFA193HH	MD901D				VR901		45
80 TG 36191		FA076			FA076HH							46
98 Giubileo					821G							47
124 Giubileo					821G							48
125 Apache	91-	FA134			FA134R	N/A						49
125 Arcore					843G							50
125 CX	91-	FA126			FA126R	N/A						51
125 GR 1		FA076			FA076HH	N/A						52
125 E 1/E 1 Competition					841G							53
125 TG 36191		FA076			FA076HH							54
125 HX LC	83-	FA047			FA047R	N/A						55
125 RX	84-	FA047			FA047R	N/A						56
125 MX1/MXR	89-	FA126			FA126R	N/A						57
125 SP 01/SP 2	89-	FA126			FA126R	N/A						58
125 XR1/XR2	89-	FA256			FA256HH	N/A						59
												60

FRONT / AVANT / VORN / FRENTE / ANTERIORE

R Suffix = High Durability Sintered Pad. HH Suffix = High Performance Sintered Pad. TT Suffix = Hard Wearing Off Road Pad. V Suffix = Semi Sintered Pad. G Suffix = Grooved Shoe.

D Suffix = Drilled Disc. X Suffix = Universal Left or Right Disc. XC Suffix = Contoured Disc. LS Suffix = Left/Steel Disc. RS = Right/Steel Disc.

*-2 Sets Required. † For Vee disc colours add RED, BLU, GRN, GLD, ORG suffix to part number.

⊗ - Also available as a Vintage Motorcycle Disc.

Non-JAPANESE Built Motorcycles

Line #	BRAKE DISC CHOICES - FRONT						DISC PAD CHOICES - REAR				BRAKE DISC CHOICES - REAR			
	Oversize 250 /280mm Disc Kit	OSX Oversize 250/280mm Disc Kit	Relocating Bracket for 250/ 280mm Disc	Oversize 320mm Disc Kit	SMX Oversize 320mm Disc Kit	Relocating Bracket for 320mm Disc	FA, SFA, TT Pad or Brake Shoe	SFAC Carbon Scooter Pads	Speciality Pads - SXR / Vee / MXS	Sintered/ HH Pads/ Grooved Shoes	Standard Replacement Disc	Contour Disc Rear fitment	Vee-Discs™ CONTOUR	CX Extreme MX Race Disc/ UTVX Disc
1							Y527							
2							SFA228	SFAC228		SFA228HH	N/A			
3							FA060					N/A		
4							FA266		FA266V	FA266HH	N/A	N/A		
5														
6														
7							883							
8							V907							
9							V907							
10							V907							
11							FA099				N/A			
12							N/A							
13							924							
14							845							
15							FA115			FA115HH	MD6248D			
16							N/A							
17							FA173				N/A			
18							909							
19							909							
20							SFA260	SFAC260		SFA260HH	MD910D		VR910	
21							SFA260	SFAC260		SFA260HH	MD910D		VR910	
22							FA382				N/A			
23							806							
24							FA115			FA115HH	MD6394D			
25							FA115			FA115HH	N/A			
26							FA115			FA115HH	N/A			
27							FA115			FA115HH	MD6394D			
28							899							
29							899							
30							SFA260	SFAC260		SFA260HH	MD932D		VR932	
31							SFA260	SFAC260		SFA260HH	MD932D		VR932	
32							SFA260	SFAC260		SFA260HH	MD932D			
33							899							
34							SFA260			SFA260HH	MD932D			
35							899							
36							FA115			FA115HH	MD6248D			
37							FA115			FA115HH	MD6394D			
38							FA047				N/A			
39							899							
40							SFA260	SFAC260		SFA260HH	MD932D		VR932	
41							FA115			FA115HH	MD6248D			
42							FA115			FA115HH	MD6248D			
43							806							
44							886							
45							806							
46										843G				
47														
48							922							
49							922							
50							FA101TT			FA101R	N/A			
51							922							
52							FA047			FA047R	N/A			
53										843G				
54										843G				
55							921							
56							N/A							
57							954							
58							FA047			FA047R	N/A			
59							FA047			FA047R	N/A			
60							FA047			FA047R	N/A			

REAR / ARRIÈRE / HINTEN / POSTERIOR / POSTERIORE

R Suffix = High Durability Sintered Pad. HH Suffix = High Performance Sintered Pad. TT Suffix = Hard Wearing Off Road Pad. V Suffix = Semi Sintered Pad. G Suffix = Grooved Shoe.
D Suffix = Drilled Disc. X Suffix = Universal Left or Right Disc. XC Suffix = Contoured Disc. LS Suffix = Left/Steel Disc. RS = Right/Steel Disc.

*-2 Sets Required. † For Vee disc colours add RED, BLU, GRN, GLD, ORG suffix to part number.
⊗ - Also available as a Vintage Motorcycle Disc.

Part numbers, prefixes, suffixes, photos and illustrations shown in this catalogue are trademarks and/or copyrights of EBC Brakes or the trademark owner A C Freeman Investments Ltd and use without express written permission of the owners is punishable by law.

Non-JAPANESE Built Motorcycles



GILERA Contd.



DISC PAD CHOICES - FRONT

BRAKE DISC CHOICES - FRONT

R Suffix = High Durability Sintered Pad. **HH** Suffix = High Performance Sintered Pad. **TT** Suffix = Hard Wearing Off Road Pad. **V** Suffix = Semi Sintered Pad. **G** Suffix = Grooved Shoe.

D Suffix = Drilled Disc. **X** Suffix = Universal Left or Right Disc. **XC** Suffix = Contoured Disc. **LS** Suffix = Left/Steel Disc. **RS** = Right/Steel Disc.

Model	Year
DNA 125/180	01-03
DNA 125/180 (Heng Tong Caliper)	01-03
FX/FXR 125/180 Runner (Rear drum brake model /Grimeca front caliper)	97-02
FX/FXR 125/180 Runner (Rear drum brake model /Heng Tong front caliper)	97-02
GFR 125	94
Nexus 125	07-12
RC 125 Rally	87-88
RC 125 Top Rally	89-92
RV 125	88
RX 125 Arizona	88
Coquar 125	99-02
Runner 125/180 FX/FXR/SP 2 stroke (Grimeca caliper)	99-02
Runner 125/180 FX/FXR/SP 2 stroke (Heng Tong caliper)	99-02
SC 125	06-07
Typhoon 125	95-98
Typhoon 125 X-XR	99-00
125 VX4T/180 VXR4T Runner 4 stroke (Grimeca Caliper)	01-04
125 VX4T/180 VXR4T Runner 4 stroke (Heng Tong Caliper)	01-04
VX 125 Runner/ST (4T)	05-14
150 Arcore	925
RX 200/Arizona/Enduro	85-
200 Arizona Hawk	85-
200 RTX	85-
200 T4/T4 C/T4 S	
200 ER	87-
200 Fast Bike	87-
RV 200	85-86
RV 200 ES	87-
VXR 200 Runner (4T) (6 bolt rear disc) Heng Tong caliper	02-04
VXR 200 Runner (4T) (6 bolt rear disc) Grimeca caliper	02-04
VX 200 Runner/ST (4T) (6 bolt rear disc) Heng Tong caliper	05-11
HX 250 LC	83-
Nexus 250 ie	07
NGR 250	85-
★ See SFA681 if rear pad SFA321 is incorrect shape - ONLY AVAILABLE AS SFA ORGANIC VERSION	
250 RX Arizona Rally	86-
Oregon 250 Quad	07
RC 250 Rally	87-88
Nexus 300i	08-12
350 Dakota	85-
ER 350	87-
Saturno 350 Bialbero	90-
XRT 350	90-
500 Dakota	87-
ER 500	87-
Fuoco 500 RC/ie	07-13
Fuoco 500 RC/ie - Parking brake	07-13
Fuoco 500 LT (4V/4T)	13-15
Fuoco 500 LT (4V/4T) - Parking brake	13-15
Saturno 500 S/Bialbero/Pioma	90-
Nexus 500	03-12
Nexus 500 SP	06-07
Nordwest 600	90-
RC 600	89-90
R 600	91-92
RC 600 Cobra	91-93
XRT 600	88-

FRONT / AVANT / VORN / FRENTE / ANTERIORE

FA, SFA, TT Pad or Brake Shoe	SFAC Carbon Scooter Pads	Speciality Pads - SXR / Vee / MXS	Sintered/HH Pads/ Grooved Shoes	Left / Gauche / Links Standard Replacement Disc	Right / Droite / Rechts Standard Replacement Disc	Contour Disc Universal left and right filament	Universal Custom Disc	Vee-Disks Black † See note below	CX Extreme MX Race Disc/ UTVX Disc
SFA194	SFAC194		SFA194HH	MD944D				VR944	
SFA353	SFAC353		SFA353HH	MD944D				VR944	
SFA194	SFAC194		SFA194HH	MD924D				VR924	
SFA353	SFAC353		SFA353HH	MD924D				VR924	
FA126			FA126HH	N/A					
SFA353	SFAC353		SFA353HH	MD983D				VR983	
FA256			FA256HH	MD6359D					
FA134			FA134R	MD6378D					
N/A				N/A					
FA047			FA047R	N/A					
FA256			FA256HH	MD983D				VR983	
SFA194	SFAC194		SFA194HH	MD924D				VR924	
SFA353	SFAC353		SFA353HH	MD924D				VR924	
FA399				MD685LS					
SFA193	SFAC193		SFA193HH	MD9126D					
SFA193	SFAC193		SFA193HH	MD9126D					
SFA194	SFAC194		SFA194HH	MD924D				VR924	
SFA353	SFAC353		SFA353HH	MD924D				VR924	
SFA353	SFAC353		SFA353HH	MD9112D				VR9112	
925									
FA047			FA047R	N/A					
FA256			FA256HH	N/A					
FA256			FA256HH	N/A					
FA076			FA076HH	N/A					
FA256			FA256HH	N/A					
FA256			FA256HH	N/A					
N/A				N/A					
FA256			FA256HH	N/A					
SFA353	SFAC353		SFA353HH	MD924D				VR924	
SFA194	SFAC194		SFA194HH	MD924D				VR924	
SFA353	SFAC353		SFA353HH	MD9112D				VR9112	
FA047			FA047R	N/A					
SFA353	SFAC353		SFA353HH	MD961D				VR961	
FA060*				N/A	N/A				
FA047			FA047R	N/A					
FA101TT*			FA101R*	TBA	TBA				
FA256			FA256HH	N/A					
SFA353	SFAC353		SFA353HH	MD983D				VR983	
FA256			FA256HH	N/A					
FA256			FA256HH	N/A					
FA095			FA095HH	N/A					
FA256			FA256HH	N/A					
FA256			FA256HH	N/A					
FA256			FA256HH	N/A					
SFA260*	SFAC260*		SFA260HH*	MD9112D	MD9112D			VR9112*	
SFA257/2									
SFA260*	SFAC260*		SFA260HH*	MD9112D	MD9112D			VR9112*	
SFA257/2									
FA095			FA095HH	N/A					
SFA181*	SFAC181*		SFA181HH*	MD983D	MD983D			VR983*	
SFA181*	SFAC181*		SFA181HH*	MD983D	MD983D			VR983*	
FA126*			FA126HH*	MD869	MD869				
FA134				N/A					
FA134				N/A					
FA134				N/A					
FA256			FA256HH	N/A					

Line #

*-2 Sets Required. † For Vee disc colours add RED, BLU, GRN, GLD, ORG suffix to part number.

⊗ - Also available as a Vintage Motorcycle Disc.

Non-JAPANESE Built Motorcycles

Line #	BRAKE DISC CHOICES - FRONT						DISC PAD CHOICES - REAR				BRAKE DISC CHOICES - REAR			
	Oversize 250 /280mm Disc Kit	OSX Oversize 250/280mm Disc Kit	Relocating Bracket for 250/ 280mm Disc	Oversize 320mm Disc Kit	SMX Oversize 320mm Disc Kit	Relocating Bracket for 320mm Disc	FA, SFA, TT Pad or Brake Shoe	SFAC Carbon Scooter Pads	Speciality Pads - SXR / Vee / MXS	Sintered/ HH Pads/ Grooved Shoes	Standard Replacement Disc	Contour Disc Rear fitment	Vee-Discs™ CONTOUR	CX Extreme MX Race Disc/ UTVX Disc
1							SFA321★	SFAC321		SFA321HH	MD944D		VR944	
2							SFA321★	SFAC321		SFA321HH	MD944D		VR944	
3														
4							816							
5														
6							816							
7							FA047			FA047HH	N/A			
8							SFA353	SFAC353		SFA353HH	MD960D		VR960	
9							954							
10							FA101TT			FA101R	N/A			
11							921							
12							954							
13							921							
14							SFA260	SFAC260		SFA260HH	MD944D		VR944	
15							SFA260	SFAC260		SFA260HH	MD944D		VR944	
16							FA115				MD686			
17							899							
18							899							
19							SFA321★	SFAC321		SFA321HH	MD910D			
20							SFA321★	SFAC321		SFA321HH	MD910D			
21							SFA321★	SFAC321		SFA321HH	MD956D		VR956	
22										843G				
23														
24							954							
25							954							
26							921							
27							954							
28							FA047				N/A			
29							FA047				N/A			
30							FA047				N/A			
31							SFA321★	SFAC321		SFA321HH	MD956D		VR956	
32							SFA321★	SFAC321		SFA321HH	MD956D		VR956	
33							SFA321★	SFAC321		SFA321HH	MD956D		VR956	
34							N/A							
35							SFA353	SFAC353		SFA353HH	MD960D		VR960	
36							FA047				N/A			
37														
38														
39										N/A				
40							FA355/4TT			FA355/4R	TBA			
41							FA047			FA047HH	N/A			
42							SFA353	SFAC353		SFA353HH	MD960D		VR960	
43							987							
44							987							
45							FA047			FA047HH	N/A			
46							FA047			FA047HH	N/A			
47							987							
48							987							
49							SFA353	SFAC353		SFA353HH	MD960D		VR960	
50														
51							SFA353	SFAC353		SFA353HH	MD960D		VR960	
52														
53							FA047			FA047R	N/A			
54							SFA266	SFAC266		SFA266HH	MD960D		VR960	
55							SFA266	SFAC266		SFA266HH	MD960D		VR960	
56							FA047			FA047HH				
57							FA101TT				N/A			
58							FA101TT				N/A			
59							FA101TT				N/A			
60							FA047			FA047HH	N/A			

REAR / ARRIÈRE / HINTEN / POSTERIOR / POSTERIORE

R Suffix = High Durability Sintered Pad. HH Suffix = High Performance Sintered Pad. TT Suffix = Hard Wearing Off Road Pad. V Suffix = Semi Sintered Pad. G Suffix = Grooved Shoe.
D Suffix = Drilled Disc. X Suffix = Universal Left or Right Disc. XC Suffix = Contoured Disc. LS Suffix = Left/Steel Disc. RS = Right/Steel Disc.

*-2 Sets Required. † For Vee disc colours add RED, BLU, GRN, GLD, ORG suffix to part number.
⊗ - Also available as a Vintage Motorcycle Disc.

Part numbers, prefixes, suffixes, photos and illustrations shown in this catalogue are trademarks and/or copyrights of EBC Brakes or the trademark owner A C Freeman Investments Ltd and use without express written permission of the owners is punishable by law.

Non-JAPANESE Built Motorcycles



GILERA Contd.

GP 800 (Chain drive)	08-14
GP 800 (Chain drive) - Parking brake	08-14

GOCCIA (Electric Scooters)

E-Gora (Li/SI)	12-15
Sunday	12-15

GOES

GS 50 X	08-09
Slam 50 (Scooter)	10-12
G 55 R Scooter	08-14
G 90 XS	10-13
G 125 M	08-14
G 125 RT Retro (Scooter)	10-14
G 125 XM	08-09
G 125 X	08-09
SPR 125 (Motorcycle)	10-12
W1KI 125 (Scooter)	10-11
220 UTS (Side X Side)	10-14
G 225 S	12-13
G 250 XM	08-09
G 350 S (Quad)	08-14
360 Max (Quad)	08-14
G 520 (Quad)	07-13
520 Max (Quad)	07-12
G 520 UTX (Side x Side)	Left 10-12
	Right
G 525 (4X4)	12-13
G 525 MAX (4X4)	12-13
G 620 i	11-12
G 625i (4X4)	12-14
G 625i MAX (4X4)	12-14
G 625i MAX (4X4) UTX 4 X 4 (Side x Side)	12-14
625i UTS (Side x Side)	13-14
GE - SSV Electric (Side x Side)	12-13

GOGORO (E Scooter)

Smart Scooter	15-17
---------------	-------

GOVECS (Electric Scooters)

GO S 1.2	11-14
GO S 1.4	11-14
GO S 2.4	11-14
GO S 3.4	11-14
GO T 1.2	11-14
GO T 1.4	13-14
GO T 2.4	11-14
GO T 3.4	11-14

HAMMERHEAD BUGGIES

Mini (45cc)	08-09
80T	08-09
150 Supersport ES 150 11 R	08-09
VR-125 Z Velo Sport	00-03
VR-125 X/H Velo-Cross	00-03
VR-125/150 H/X/Z	04
HD 125 L/150 L	00-04
Cabriolet 125	01

DISC PAD CHOICES - FRONT

BRAKE DISC CHOICES - FRONT

FA, SFA, TT Pad or Brake Shoe	SFAC Carbon Scooter Pads	Speciality Pads - SXR / Vee / MXS	Sintered/HH Pads/ Grooved Shoes	Left / Gauche / Links Standard Replacement Disc	Right / Droite / Rechts Standard Replacement Disc	Contour Disc Universal left and right fitment	Universal Custom Disc	Vee-Discs Black † See note below	CX Extreme MX Race Disc/ UTVX Disc
SFA181*	SFAC181*		SFA181HH*	MD9125D	MD9125D				
SFA257/2									
SFA086	SFAC086		SFA086HH		N/A				
SFA151	SFAC151			N/A					
FA167			FA167HH	N/A					
SFA235	SFAC235					N/A			
SFA086	SFAC086		SFA086HH	N/A					
TBA*									
FA086			FA086HH	N/A					
SFA235	SFAC235			N/A					
FA185TT		MXS185	FA185R	N/A					
FA086			FA086HH	N/A					
FA086			FA086HH			N/A			
SFA235	SFAC235			N/A					
FA453TT*			FA453R*	N/A	N/A				
FA083TT*			FA083R*	N/A	N/A				
FA185TT		MXS185	FA185R	N/A					
FA083TT*			FA083R*	N/A	N/A				
FA453TT*			FA453R*	N/A	N/A				
FA453TT*			FA453R*	N/A	N/A				
FA453TT*			FA453R*	N/A	N/A				
FA165TT			FA165R	N/A	N/A				
FA135TT			FA135R						
FA453TT*			FA453R*	N/A	N/A				
FA453TT*			FA453R*	N/A	N/A				
FA453TT*			FA453R*	N/A	N/A				
FA453TT*			FA453R*	N/A	N/A				
FA453TT*			FA453R*	N/A	N/A				
FA453TT*			FA453R*	N/A	N/A				
FA453TT*			FA453R*	N/A	N/A				
FA453TT*			FA453R*	N/A	N/A				
SFA266	SFAC266		SFA266HH	MD9162D				VR9162	
SFA193	SFAC193		SFA193HH					VR901	
SFA193	SFAC193		SFA193HH					VR901	
SFA193	SFAC193		SFA193HH					VR901	
SFA193	SFAC193		SFA193HH					VR901	
SFA193	SFAC193		SFA193HH	MD901D				VR901	
SFA193	SFAC193		SFA193HH	MD901D				VR901	
SFA193	SFAC193		SFA193HH	MD901D				VR901	
SFA193	SFAC193		SFA193HH	MD901D				VR901	
N/A									
N/A									
FA416TT*			FA416R*	N/A	N/A				
FA228			FA228HH	N/A					
FA228			FA228HH	N/A					
FA228			FA228HH	N/A					
FA093				N/A					
FA167			FA167HH	N/A					

Line #
1
2
3
4
5
6
7
8
9
10
11
12
13
14
15
16
17
18
19
20
21
22
23
24
25
26
27
28
29
30
31
32
33
34
35
36
37
38
39
40
41
42
43
44
45
46
47
48
49
50
51
52
53
54
55
56
57
58
59
60

*-2 Sets Required. † For Vee disc colours add RED, BLU, GRN, GLD, ORG suffix to part number.

⊗ - Also available as a Vintage Motorcycle Disc.

R Suffix = High Durability Sintered Pad. HH Suffix = High Performance Sintered Pad. TT Suffix = Hard Wearing Off Road Pad. V Suffix = Semi Sintered Pad. G Suffix = Grooved Shoe. D Suffix = Drilled Disc. X Suffix = Universal Left or Right Disc. XC Suffix = Contoured Disc. LS Suffix = Left/Steel Disc. RS = Right/Steel Disc.

FRONT / AVANT / VORN / FRENTE / ANTERIORE

Non-JAPANESE Built Motorcycles

Line #	BRAKE DISC CHOICES - FRONT						DISC PAD CHOICES - REAR				BRAKE DISC CHOICES - REAR			
	Oversize 250 /280mm Disc Kit	OSX Oversize 250/280mm Disc Kit	Relocating Bracket for 250/ 280mm Disc	Oversize 320mm Disc Kit	SMX Oversize 320mm Disc Kit	Relocating Bracket for 320mm Disc	FA, SFA, TT Pad or Brake Shoe	SFAC Carbon Scooter Pads	Speciality Pads - SXR / Vee / MXS	Sintered/ HH Pads/ Grooved Shoes	Standard Replacement Disc	Contour Disc Rear fitment	Vee-Discs™ CONTOUR	CX Extreme MX Race Disc/ UTVX Disc
1							SFA353	SFAC353		SFA353HH	MD9124D			
2														
3														
4														
5							H303							
6							H303							
7														
8														
9							FA167			FA167HH	N/A			
10							TBA							
11							TBA							
12							FA083TT			FA083R	N/A			
13							FA197			FA197HH	N/A			
14							TBA				N/A			
15							FA131TT		MXS131	FA131R	N/A			
16							FA086			FA086HH	N/A			
17							FA197			FA197HH		N/A		
18							TBA							
19							TBA			TBA	N/A			
20							FA067TT			FA067R	N/A			
21							FA131TT		MXS131	FA131R	N/A			
22							FA067TT			FA067R	N/A			
23											N/A			
24							FA344TT			FA344R	N/A			
25							FA344TT			FA344R	N/A			
26							FA344TT			FA344R	N/A			
27														
28							FA344TT			FA344R	N/A			
29							FA344TT			FA344R	N/A			
30							FA344TT			FA344R	N/A			
31							FA344TT			FA344R	N/A			
32							FA344TT			FA344R	N/A			
33							FA344TT			FA344R	N/A			
34							TBA				N/A			
35							FA344TT			FA344R	N/A			
36														
37														
38							SFA067	SFAC067		SFA067HH	MD9163D		VR9163	
39														
40														
41							SFA083	SFAC083		SFA083HH		TBA		
42							SFA083	SFAC083		SFA083HH		TBA		
43							SFA083	SFAC083		SFA083HH		TBA		
44							SFA083	SFAC083		SFA083HH		TBA		
45							SFA083	SFAC083		SFA083HH	TBA	TBA		
46							SFA083	SFAC083		SFA083HH	TBA	TBA		
47							SFA083	SFAC083		SFA083HH	TBA	TBA		
48							SFA083	SFAC083		SFA083HH	TBA	TBA		
49														
50														
51							FA485TT				N/A			
52							FA416TT			FA416R	N/A			
53							FA431TT			FA431R	N/A			
54							H304							
55							H304							
56							FA197				N/A			
57							S602							
58							FA115				N/A			
59														
60														

REAR / ARRIÈRE / HINTEN / POSTERIOR / POSTERIORE

*-2 Sets Required. † For Vee disc colours add RED, BLU, GRN, GLD, ORG suffix to part number.

⊗ - Also available as a Vintage Motorcycle Disc.

Part numbers, prefixes, suffixes, photos and illustrations shown in this catalogue are trademarks and/or copyrights of EBC Brakes or the trademark owner A C Freeman Investments Ltd and use without express written permission of the owners is punishable by law.

R Suffix = High Durability Sintered Pad. HH Suffix = High Performance Sintered Pad. TT Suffix = Hard Wearing Off Road Pad. V Suffix = Semi Sintered Pad. G Suffix = Grooved Shoe.

D Suffix = Drilled Disc. X Suffix = Universal Left or Right Disc. XC Suffix = Contoured Disc. LS Suffix = Left/Steel Disc. RS = Right/Steel Disc.

BRAKE APPLICATIONS

Non-JAPANESE Built Motorcycles



HERO HONDA



DISC PAD CHOICES - FRONT

BRAKE DISC CHOICES - FRONT

R Suffix = High Durability Sintered Pad. **HH** Suffix = High Performance Sintered Pad. **TT** Suffix = Hard Wearing Off Road Pad. **V** Suffix = Semi Sintered Pad. **G** Suffix = Grooved Shoe.
D Suffix = Drilled Disc. **X** Suffix = Universal Left or Right Disc. **XC** Suffix = Contoured Disc. **LS** Suffix = Left/Steel Disc. **RS** = Right/Steel Disc.

FRONT / AVANT / VORN / FRENTE / ANTERIORE

Line #

		FA, SFA, TT Pad or Brake Shoe	SFAC Carbon Scooter Pads	Speciality Pads - SXR / Vee / MXS	Sintered/HH Pads/ Grooved Shoes	Left / Gauche / Links Standard Replacement Disc	Right / Droite / Rechts Standard Replacement Disc	Contour Disc Universal left and right fitment	Universal Custom Disc	Vee-Disks Black † See note below	CX Extreme MX Race Disc/ UTVX Disc
Nipster 50	06	SFA169	SFAC169		SFA169HH	TBA					
CD Dawn (100cc 4T) (Spoke wheel)	08	TBA									
CD Deluxe (100cc 4T) (Cast wheel)	08	TBA									
Passion Plus (100cc 4T) (Cast wheel)	08	H352									
Passion Plus (100cc 4T) (Spoke wheel)	08	H352									
Splendor NXG (100cc 4T) (Cast wheel)	08	H352									
Splendor+ (100cc 4T) (Front drum model)	08	H352									
Splendor+ (100cc 4T) (Front disc model)	08	TBA				TBA					
Pleasure (102cc 4T)	08	H352					TBA				
Super Splendor (125cc 4T)	08	H352					TBA				
Glamour PGM Fi (125cc 4T) (Cast wheel)	08	H352					TBA				
Glamour (125cc 4T) (Cast wheel)	08	H352					TBA				
Magellan 125	06	FA197			FA197HH		N/A				
Punto 125	06	FA197			FA197HH		N/A				
Quickster 125	06	FA101					TBA				
Slickster 125	06	FA086			FA086HH		N/A				
Achiever (150cc 4T) (Cast Wheel)	08	FA197					TBA				
CBZ X-treme (Cast wheel)	08	FA197					TBA				
Hunk (150cc 4T) (Cast wheel)	08	TBA					TBA				
Karizma (223cc 4T)	08	TBA					TBA				
Splendor NXG 100	11-12	H353									
Splendor Pro 100	11-12	H353									
Pleasure 102	11-12	H353									
Glamour 125 (PGM Fi)	11-12	TBA					MD1030				
Super Splendor 125	11-12	TBA					MD1030				
Hunk 150	11-12	TBA					MD1030				
Karizma ZMR 230	11-12	FA375		FA375V	FA375HH		N/A				
HIGHLAND											
950 V2 Outback	00-04	FA181TT		MXS181	FA181R	N/A					
950 V2 Motard	00-04	FA181TT		MXS181	FA181R	N/A					
HONDA DALL-ARA											
XR 125 SM	04	FA185TT		MXS185	FA185R	TBA					
XR 250 R	04	FA185TT		MXS185	FA185R	MD6001D		MD6001C			MD6001CX
XR 250 SM	04	FA185TT		MXS185	FA185R	TBA					
XR 400/440 R	04	FA185TT		MXS185	FA185R	MD6037D		MD6037C			MD6037CX
XR 400/440 SM	04	FA185TT		MXS185	FA185R	MD6037D		MD6037C			MD6037CX
XR 650 R	04	FA185TT		MXS185	FA185R	MD6001D		MD6001C			MD6001CX
XR 650 R	04	FA185TT		MXS185	FA185R	TBA					
HONDA-HM (ITALY)											
Baja 10/10 JR & SR	99-07	FA351TT				N/A					
Baja 12/14 MX	99-09	FA351TT				N/A					
CRE 50 Six/Baja/Derapage Brembo caliper twin pin/41mm Paioli forks	95-02	FA194			FA194HH	N/A					
CRE 50 Six/Baja/Derapage Brembo caliper single pin/Kayaba forks	95-02	FA134			FA134R	N/A					
CRE 50 Six/Baja/Derapage Grimeca caliper twin pin/Kayaba forks	95-02	FA166				N/A					
CRE 50 Six/Baja/Derapage Grimeca	95-02	FA382				N/A					
Ⓢ Note choice of 3 different pads on rear caliper - check shape in buyers guide - FA47 / FA101 / FA382.											
CRE 50 Six	01-02	FA181TT		MXS181	FA181R	N/A					
CRE 50 Baja/Derapage	01-02	FA181TT		MXS181	FA181R	N/A					
CRE 50 Baja/Six/Derapage	03-09	FA194			FA194HH	N/A					
CRE 50 Six Competition	07-12	FA654				N/A					
CRE 50 Baja RR Up to ZEN50XACEA7700324	07-09	FA194			FA194HH	N/A					
CRE 50 Baja RR From ZEN50XACEA7700325	07-09	FA194			FA194HH	N/A					
CRE 50 Baja RR	10-12	FA194			FA194HH		N/A				

*-2 Sets Required. † For Vee disc colours add RED, BLU, GRN, GLD, ORG suffix to part number.

Ⓢ - Also available as a Vintage Motorcycle Disc.

Non-JAPANESE Built Motorcycles

Line #	BRAKE DISC CHOICES - FRONT						DISC PAD CHOICES - REAR				BRAKE DISC CHOICES - REAR			
	OverSize 250 /280mm Disc Kit	OSX OverSize 250/280mm Disc Kit	Relocating Bracket for 250/ 280mm Disc	OverSize 320mm Disc Kit	SMX OverSize 320mm Disc Kit	Relocating Bracket for 320mm Disc	FA, SFA, TT Pad or Brake Shoe	SFAC Carbon Scooter Pads	Speciality Pads - SXR / Vee / MXS	Sintered/ HH Pads/ Grooved Shoes	Standard Replacement Disc	Contour Disc Rear fitment	Vee-Discs™ CONTOUR	CX Extreme MX Race Disc/ UTVX Disc
1							TBA							
2							TBA							
3							TBA							
4							H304							
5							H304							
6							H304							
7							H304							
8							H304							
9							H352							
10							H352							
11							H304							
12							H304							
13							TBA							
14							TBA							
15							TBA							
16							TBA							
17							H352							
18							H352							
19							TBA							
20							TBA							
21							H353							
22							H353							
23							H353							
24							H352							
25							H352							
26							H352							
27							FA343		FA343HH	N/A				
28														
29														
30							FA208TT	MXS208	FA208R	N/A				
31							FA208TT	MXS208	FA208R	N/A				
32														
33														
34							FA115	MXS115	FA115R	TBA				
35							FA131TT	MXS131	FA131R	MD6013D	MD6013C		MD6013CX	
36							FA346TT	MXS346	FA346R	MD6013D	MD6013C			
37							FA346TT	MXS346	FA346R	MD6013D	MD6013C		MD6013CX	
38							FA346TT	MXS346	FA346R	MD6013D	MD6013C			
39							FA131TT	MXS131	FA131R	MD6181D			MD6181CX	
40							FA131TT	MXS131	FA131R	MD6181D				
41														
42														
43							FA351TT			N/A				
44							FA351TT			N/A				
45														
46							FA047 / FA101 / FA382 Ⓢ			N/A				
47														
48							FA047 / FA101 / FA382 Ⓢ			N/A				
49														
50							FA047 / FA101 / FA382 Ⓢ			N/A				
51							FA047 / FA101 / FA382 Ⓢ			N/A				
52														
53														
54							FA382			N/A				
55							FA115TT	MXS115	FA115R	N/A				
56							FA350		FA350HH	MD6401D				
57							FA346TT			N/A				
58							FA350		FA350HH	N/A				
59							FA346TT		FA346R	N/A				
60							FA346TT		FA346R		N/A			

REAR / ARRIÈRE / HINTEN / POSTERIOR / POSTERIORE

R Suffix = High Durability Sintered Pad. **HH** Suffix = High Performance Sintered Pad. **TT** Suffix = Hard Wearing Off Road Pad. **V** Suffix = Semi Sintered Pad. **G** Suffix = Grooved Shoe.
D Suffix = Drilled Disc. **X** Suffix = Universal Left or Right Disc. **XC** Suffix = Contoured Disc. **LS** Suffix = Left/Steel Disc. **RS** = Right/Steel Disc.

*-2 Sets Required. † For Vee disc colours add RED, BLU, GRN, GLD, ORG suffix to part number.
 Ⓢ - Also available as a Vintage Motorcycle Disc.

Part numbers, prefixes, suffixes, photos and illustrations shown in this catalogue are trademarks and/or copyrights of EBC Brakes or the trademark owner A C Freeman Investments Ltd and use without express written permission of the owners is punishable by law.

Non-JAPANESE Built Motorcycles



HONDA-HM (ITALY) Contd.



DISC PAD CHOICES - FRONT

BRAKE DISC CHOICES - FRONT

R Suffix = High Durability Sintered Pad. **HH** Suffix = High Performance Sintered Pad. **TT** Suffix = Hard Wearing Off Road Pad. **V** Suffix = Semi Sintered Pad. **G** Suffix = Grooved Shoe.

D Suffix = Drilled Disc. **X** Suffix = Universal Left or Right Disc. **XC** Suffix = Contoured Disc. **LS** Suffix = Left/Steel Disc. **RS** = Right/Steel Disc.

FRONT / AVANT / VORN / FRENTE / ANTERIORE

		FA, SFA, TT Pad or Brake Shoe	SFAC Carbon Scooter Pads	Speciality Pads - SXR / Vee / MXS	Sintered/HH Pads/ Grooved Shoes	Left / Gauche / Links Standard Replacement Disc	Right / Droite / Rechts Standard Replacement Disc	Contour Disc Universal left and right fitment	Universal Custom Disc	Vee-Discs Black † See note below	CX Extreme MX Race Disc/ UTVX Disc	Line #
CRE 50 Derapage RR Up to ZEN50XACMA7700384	07-09	FA194			FA194HH	N/A						1
CRE 50 Derapage RR From ZEN50XACMA7700385	07-09	FA194			FA194HH	N/A						2
CRE 50 Six Competition	07-08	FA194			FA194HH	N/A						3
CRM 50 Derapage Competition	07-08	FA194			FA194HH	N/A						4
CRM 50 Derapage Competition	09-12	FA654				N/A						5
CRE 80	98-02	FA084TT		MXS084	FA084R	MD6058D		MD6058C			MD6058CX	6
CR 85 R/R2	03-07	FA084TT		MXS084	FA084R	MD6058D		MD6058C			MD6058CX	7
CRE 125	95-97	FA185TT		MXS185	FA185R	MD6037D		MD6037C			MD6037CX	8
CRE 125	98-01	FA185TT		MXS185	FA185R	MD6037D		MD6037C			MD6037CX	9
CRE 125 R Supermotard	02-06	FA185TT		MXS185	FA185R	N/A		MD6037C			MD6037CX	10
CRE 125 R Enduro	02-03	FA185TT		MXS185	FA185R	MD6037D		MD6037C			MD6037CX	11
CRE 125 R Enduro	04-07	FA185TT		MXS185	FA185R	MD6037D		MD6037C			MD6037CX	12
CRE 125 Baja RR 2T	11	FA465TT		MXS465	FA465R			N/A				13
CRE 125 (Six Competition 2T)	11	FA185TT		MXS185	FA185R	N/A						14
CRE F 125 X	09	FA194			FA194HH	N/A						15
CRE F 125 X Six (4T)	11-12	FA654						N/A				16
CR 125 Motard	04-06	FA185TT		MXS185	FA185R			SM6437C				17
CRM 125 R Supermoto	07	FA433/4			FA433/4HH	N/A						18
CRM 125 (Derapage Competition 2T)	11-12	FA654						N/A				19
CRM 125 (Derapage RR 2T)	11	FA185TT		MXS185	FA185R			N/A				20
CRM F 125 X	09	FA194			FA194HH	N/A						21
CRM F 125 X Derapage Competition (4T)	10-11	FA654						N/A				22
CRF 150 R/R2	07-09	FA084TT			FA084R	MD6314D		MD6314C			MD6314CX	23
CRF 230 Easy Trail	04-07	FA185TT		MXS185	FA185R	MD6037D		MD6037C			MD6037CX	24
CRF 230 Easy Enduro	04-07	FA185TT		MXS185	FA185R	MD6037D		MD6037C			MD6037CX	25
CRF 230 Easy Motard	04-07	FA185TT		MXS185	FA185R	MD6037D		MD6037C			MD6037CX	26
CRF 230 F Easy Trial (All models)	04-07	FA185TT		MXS185	FA185R	MD6037D		MD6037C			MD6037CX	27
CRE 250	97-01	FA185TT		MXS185	FA185R	MD6037D		MD6037C			MD6037CX	28
CRE 250	02	FA185TT		MXS185	FA185R	MD6037D		MD6037C			MD6037CX	29
CRE 250 R Supermotard	02-03	FA185TT		MXS185	FA185R	MD6037D		MD6037C			MD6037CX	30
CRE 250 R Enduro	02-07	FA185TT		MXS185	FA185R	MD6037D		MD6037C			MD6037CX	31
CR 250 R Moto	04	FA185TT		MXS185	FA185R	MD6037D		MD6037C			MD6037CX	32
CRE F 250 R	04-09	FA185TT		MXS185	FA185R	MD6037D		MD6037C			MD6037CX	33
CRE F 250 R	08-09	FA185TT		MXS185	FA185R	MD6037D		MD6037C			MD6037CX	34
CRE F 250 X	08-11	FA185TT		MXS185	FA185R	MD6037D		MD6037C			MD6037CX	35
CRE 250 R Enduro	04-07	FA185TT		MXS185	FA185R	MD6037D		MD6037C			MD6037CX	36
CRF 250 Motard	04-06	FA185TT		MXS185	FA185R	MD6037D		MD6037C			MD6037CX	37
CRF 250 F	04-08	FA185TT		MXS185	FA185R	MD6037D		MD6037C			MD6037CX	38
CRF 250 R	08-09	FA185TT		MXS185	FA185R	MD6037D		MD6037C			MD6037CX	39
CRM 250 X Supermoto	07	FA433/4			FA433/4HH	N/A						40
CRE 260	95-96	FA185TT		MXS185	FA185R	MD6001D		MD6001C			MD6001CX	41
CRE 260	97-98	FA185TT		MXS185	FA185R	MD6001D		MD6001C			MD6001CX	42
CRE F 290 C	07	FA185TT		MXS185	FA185R	MD6037D		MD6037C			MD6037CX	43
CRE F 300 X	08-09	FA185TT		MXS185	FA185R	MD6037D		MD6037C			MD6037CX	44
CRE 450 F	02-03	FA185TT		MXS185	FA185R	MD6037D		MD6037C			MD6037CX	45
CRE 450 R Enduro	02-07	FA185TT		MXS185	FA185R	MD6037D		MD6037C			MD6037CX	46
CRE F 450 R Enduro	04-08	FA185TT		MXS185	FA185R	MD6037D		MD6037C			MD6037CX	47
CRE 450 F Supermoto	02-03	FA185TT		MXS185	FA185R	MD6037D		MD6037C			MD6037CX	48
CRE F 450 X	04-09	FA185TT		MXS185	FA185R	MD6037D		MD6037C			MD6037CX	49
CRF 450 Motard	04-06	FA185TT		MXS185	FA185R	MD6037D		MD6037C			MD6037CX	50
CRF 450 R	04-09	FA185TT		MXS185	FA185R	MD6037D		MD6037C			MD6037CX	51
CRM F 450 R Supermoto	07-08	FA433/4			FA433/4HH	N/A						52
CRM F 450 X Supermoto	07-09	FA433/4			FA433/4HH	N/A						53
CRE F 490 X	07	FA185TT		MXS185	FA185R	MD6037D		MD6037C			MD6037CX	54
CRM F 490 X Supermoto	07	FA433/4			FA433/4HH	N/A						55
CRE F 500 X	08-09	FA185TT		MXS185	FA185R	MD6037D		MD6037C			MD6037CX	56
CRM F 500 X	11	FA433/4			FA433/4HH	N/A						57
♦ Plain undrilled disc for enduro use MD6191CE												58
												59
												60

*-2 Sets Required. † For Vee disc colours add RED, BLU, GRN, GLD, ORG suffix to part number.

⊗ - Also available as a Vintage Motorcycle Disc.

Non-JAPANESE Built Motorcycles

Line #	BRAKE DISC CHOICES - FRONT						DISC PAD CHOICES - REAR				BRAKE DISC CHOICES - REAR			
	Oversize 250 /280mm Disc Kit	OSX Oversize 250/280mm Disc Kit	Relocating Bracket for 250/ 280mm Disc	Oversize 320mm Disc Kit	SMX Oversize 320mm Disc Kit	Relocating Bracket for 320mm Disc	FA, SFA, TT Pad or Brake Shoe	SFAC Carbon Scooter Pads	Speciality Pads - SXR / Vee / MXS	Sintered/ HH Pads/ Grooved Shoes	Standard Replacement Disc	Contour Disc Rear fitment	Vee-Discs™ CONTOUR	CX Extreme MX Race Disc/ UTVX Disc
1							FA350			FA350HH	N/A			
2							FA346TT			FA346R	N/A			
3							FA346TT			FA346R	N/A			
4							FA346TT			FA346R	N/A			
5							FA346TT			FA346R	N/A			
6							FA131TT		MXS131	FA131R	MD6005D	MD6005C		MD6005CX
7							FA131TT		MXS131	FA131R	MD6005D	MD6005C		MD6005CX
8							FA131TT		MXS131	FA131R	MD6002D			MD6002CX
9							FA131TT		MXS131	FA131R	MD6124D	MD6124C		MD6124CX
10							FA346TT		MXS346	FA346R	MD6191D	MD6191C		MD6191CX
11							FA346TT		MXS346	FA346R	MD6191D	MD6191C		MD6191CX
12							FA346TT		MXS346	FA346R	MD6191D	MD6191C		MD6191CX
13							FA346TT			FA346R		N/A		
14							FA346TT		MXS346	FA346R		N/A		
15							FA346TT			FA346R	N/A			
16							FA346TT				N/A			
17							FA346TT		MXS346	FA346R		MD6191C		MD6191CX
18							FA346TT			FA346R	MD6191D	MD6191C		
19							FA346TT					N/A		
20							FA346TT			FA346R		N/A		
21							FA346TT			FA346R	N/A			
22							FA346TT					N/A		
23							FA346TT		MXS346	FA346R	MD6316D	MD6316C		MD6316CX
24							FA346TT		MXS346	FA346R	MD6191D	MD6191C		MD6191CX
25							FA346TT		MXS346	FA346R	MD6191D	MD6191C		MD6191CX
26							FA346TT		MXS346	FA346R	MD6191D	MD6191C		MD6191CX
27							H304							
28							FA131TT		MXS131	FA131R	MD6124D	MD6124C		MD6124CX
29							FA346TT		MXS346	FA346R	MD6191D	MD6191C		MD6191CX
30							FA346TT		MXS346	FA346R	MD6191D	MD6191C		MD6191CX
31							FA346TT		MXS346	FA346R	MD6191D	MD6191C		MD6191CX
32							FA346TT		MXS346	FA346R	MD6191D	MD6191C		MD6191CX
33							FA346TT		MXS346	FA346R	MD6191D	MD6191C		MD6191CX
34							FA131TT		MXS131	FA131R	MD6191D	MD6191C		MD6191CX
35							FA346TT		MXS346	FA346R	MD6191D	MD6191C		MD6191CX
36							FA346TT		MXS346	FA346R	MD6191D	MD6191C		MD6191CX
37							FA346TT		MXS346	FA346R	MD6191D	MD6191C		MD6191CX
38							FA346TT		MXS346	FA346R	MD6191D	MD6191C		MD6191CX
39							FA346TT		MXS346	FA346R	MD6191D	MD6191C		MD6191CX
40							FA346TT			FA346R	MD6191D	MD6191C		MD6191CX
41							FA131TT		MXS131	FA131R	MD6002D			MD6002CX
42							FA131TT		MXS131	FA131R	MD6124D	MD6124C		MD6124CX
43							FA346TT		MXS346	FA346R	MD6191D	MD6191C		MD6191CX
44							FA346TT		MXS346	FA346R	MD6191D	MD6191C		MD6191CX
45							FA346TT		MXS346	FA346R	MD6191D	MD6191C		MD6191CX
46							FA346TT		MXS346	FA346R	MD6191D	MD6191C		MD6191CX
47							FA346TT		MXS346	FA346R	MD6191D	MD6191C		MD6191CX
48							FA346TT		MXS346	FA346R	MD6191D	MD6191C		MD6191CX
49							FA346TT		MXS346	FA346R	MD6191D	MD6191C		MD6191CX
50							FA346TT		MXS346	FA346R	MD6191D	MD6191C		MD6191CX
51							FA346TT		MXS346	FA346R	MD6191D	MD6191C		MD6191CX
52							FA346TT			FA346R	MD6191D	MD6191C		
53							FA346TT		MXS346	FA346R	MD6191D	MD6191C		
54							FA346TT		MXS346	FA346R	MD6191D	MD6191C		MD6191CX
55							FA346TT		MXS346	FA346R	MD6191D	MD6191C		MD6191CX
56							FA346TT		MXS346	FA346R	MD6191D	MD6191C		MD6191CX
57							FA346TT			FA346R	N/A			
58														
59														
60														

REAR / ARRIÈRE / HINTEN / POSTERIORE

*-2 Sets Required. † For Vee disc colours add RED, BLU, GRN, GLD, ORG suffix to part number.
 Ⓢ - Also available as a Vintage Motorcycle Disc.

BRAKE APPLICATIONS
R Suffix = High Durability Sintered Pad. **HH** Suffix = High Performance Sintered Pad. **TT** Suffix = Hard Wearing Off Road Pad. **V** Suffix = Semi Sintered Pad. **G** Suffix = Grooved Shoe.
D Suffix = Drilled Disc. **X** Suffix = Universal Left or Right Disc. **XC** Suffix = Contoured Disc. **LS** Suffix = Left/Steel Disc. **RS** = Right/Steel Disc.

Non-JAPANESE Built Motorcycles



HONGDOU

CTM 125 Chituma	04
HD 125-7	05-07
GY 125	

HONLEY

Classic 125	16-17
HD1 125	14-15
HD2 125	16-17
HD3 SE 125	16-17
HD3 125	16-17
Oliver 125	15-16
RX-3 Venture 250	15-17

HOREX

Rebell 80 N	
Rebell 80 T	
Sport 80 L	
HRD 600	85
500/600 Columbus	88-
VR6 Classic	13-14
VR6 Roadster	11-14
Copper 50 (4T)	10-12
Iron 50 (2T)	10-12
Tin 50 (4T/4V)	10-12
Chromel 125 (4T/LC)	11-12
Lithium 125 (2T/LC)	10-12
Chromel 150 (4T/LC)	11-12
Lithium 150 (4T/2V/LC)	10-12
Nickel 150 (4T/2V)	10-11
Barum 260 (4T/2V/LC)	10-12
Radium 300	11-12
Pantera 600	11

HRD

GS 50	
RP 50 Cross	
Sonic 2 Trail 50	
Sonic 2 Supermotard 50	
SX 50 Mini Cross	
RP 80 Cross	83-
Cabriolet Trail 125	
Cabriolet Supermotard 125	
WH 125 Road/Red Horse	85-

HUSABERG

Enforcer Four	00-03
All models (central fixing pin in pad)	89-92
All models (fixing pin at end of brake pad)	93-94
All models (fixing pin at end of brake pad)	95-99
All MX/Enduro models	
(Brembo 2 piston caliper 260mm front disc)	00-05
All Supermotard models (Beringer 4 piston caliper central in fixing 310mm front disc)	00-03
TE 125 (2T)	12-14
TE 250 (2T)	11-14
TE 300 (2T)	11-14
FE 250 (4T)	13-14
FE 350 (4T)	13-14
FE 390 (New 70° Engine)	10-12
FE 450 E	06-08

		DISC PAD CHOICES - FRONT			BRAKE DISC CHOICES - FRONT					Line #
FA, SFA, TT Pad or Brake Shoe	SFAC Carbon Scooter Pads	Speciality Pads - SXR / Vee / MXS	Sintered/HH Pads/Grooved Shoes	Left / Gauche / Links Standard Replacement Disc	Right / Droite / Rechts Standard Replacement Disc	Contour Disc Universal left and right fitment	Universal Custom Disc	Vee-Discs Black † See note below	CX Extreme MX Race Disc/ UTVX Disc	Line #
FA086			FA086HH			N/A				1
FA486					TBA					2
TBA					N/A					3
										4
H303										5
FA464						MD2104RS				6
FA464						MD2104RS				7
FA464						MD2104RS				8
FA464						MD2104RS				9
SFA151						N/A				10
FA664						N/A				11
										12
										13
										14
FA050					N/A					15
FA050*					N/A	N/A				16
FA050*					N/A	N/A				17
FA018*			FA018HH*		N/A	N/A				18
FA018*			FA018HH*		N/A	N/A				19
FA244*			FA244HH*			N/A*				20
FA244*			FA244HH*			N/A*				21
SFA086	SFAC086		SFA086HH			N/A				22
SFA047			SFA047HH			N/A				23
SFA235	SFAC235				N/A					24
SFA086	SFAC086		SFA086HH			N/A				25
SFA086	SFAC086		SFA086HH	N/A						26
SFA086	SFAC086		SFA086HH			N/A				27
SFA086	SFAC086		SFA086HH	N/A						28
SFA086	SFAC086		SFA086HH			N/A				29
SFA197	SFAC197		SFA197HH			N/A				30
SFA086	SFAC086		SFA086HH			N/A				31
FA231		FA231V	FA231HH			N/A				32
										33
										34
FA194					N/A					35
			944G							36
FA167			FA167HH	N/A						37
FA167			FA167HH	N/A						38
FA293					N/A					39
										40
			944G							41
FA167			FA167HH	N/A						42
FA167			FA167HH	N/A						43
FA047			FA047R	N/A						44
										45
FA181TT*		MXS181*	FA181R*	MD6141D	MD6141D					46
FA134			FA134R	N/A						47
FA181TT		MXS181	FA181R	MD6125D						48
FA181TT		MXS181	FA181R	MD6125D						49
FA181TT		MXS181	FA181R	MD6032D		MD6032C			MD6032CX	50
FA181TT		MXS181	FA181R	MD6032D		MD6032C			MD6032CX	51
FA158			FA158HH	N/A						52
FA181TT		MXS181	FA181R			MD6032C			MD6032CX	53
FA181TT		MXS181	FA181R			MD6032C			MD6032CX	54
FA181TT		MXS181	FA181R			MD6032C			MD6032CX	55
FA181TT		MXS181	FA181R			MD6032C			MD6032CX	56
FA181TT		MXS181	FA181R			MD6032C			MD6032CX	57
FA181TT		MXS181	FA181R			MD6032C			MD6032CX	58
FA181TT		MXS181	FA181R			MD6032C			MD6032CX	59
FA181TT		MXS181	FA181R	MD6032D		MD6032C			MD6032CX	60

*-2 Sets Required. † For Vee disc colours add RED, BLU, GRN, GLD, ORG suffix to part number.

☼ - Also available as a Vintage Motorcycle Disc.

Non-JAPANESE Built Motorcycles

Line #	BRAKE DISC CHOICES - FRONT						DISC PAD CHOICES - REAR				BRAKE DISC CHOICES - REAR			
	Oversize 250 /280mm Disc Kit	OSX Oversize 250/280mm Disc Kit	Relocating Bracket for 250/ 280mm Disc	Oversize 320mm Disc Kit	SMX Oversize 320mm Disc Kit	Relocating Bracket for 320mm Disc	FA, SFA, TT Pad or Brake Shoe	SFAC Carbon Scooter Pads	Speciality Pads - SXR / Vee / MXS	Sintered/ HH Pads/ Grooved Shoes	Standard Replacement Disc	Contour Disc Rear fitment	Vee-Discs™ CONTOUR	CX Extreme MX Race Disc/ UTVX Disc
1							Y516							
2							TBA							
3							H304							
4														
5														
6							H303							
7							Y535							
8							Y535							
9							Y535							
10							Y535							
11							TBA							
12							FA086							
13														
14														
15							N/A							
16							N/A							
17							N/A							
18							FA018			FA018HH	N/A			
19							FA018			FA018HH	N/A			
20							FA266			FA266HH	N/A			
21							FA266			FA266HH	N/A			
22							SFA115			SFA115HH	N/A			
23							SFA298			SFA298HH	N/A			
24							TBA							
25							SFA086	SFAC086		SFA086HH	N/A			
26							SFA086	SFAC086		SFA086HH	N/A			
27							SFA086	SFAC086		SFA086HH	N/A			
28							SFA086	SFAC086		SFA086HH	N/A			
29							SFA197	SFAC197		SFA197HH	N/A			
30							SFA427	SFAC427		SFA427HH	N/A			
31							SFA086	SFAC086		SFA086HH	N/A			
32							FA213		FA213V	FA213HH	N/A			
33														
34														
35							FA208TT				N/A			
36										944G				
37							FA115			FA115R	N/A			
38							FA115			FA115R	N/A			
39							FA293				N/A			
40										944G				
41							FA115			FA115R	N/A			
42							FA115			FA115R	N/A			
43							N/A							
44														
45														
46							FA181TT		MXS181	FA181R	MD6142D			
47							FA067TT			FA067R	N/A			
48		OSX6125	BRK010		SMX6125	BRK007	FA067TT			FA067R	MD6126D			
49		OSX6125	BRK010		SMX6125	BRK007	FA208TT		MXS208	FA208R	MD6126D			
50														
51		OSX6032	BRK011		SMX6032	BRK012	FA208TT		MXS208	FA208R	MD6035D	MD6035C	MD6035CX	
52														
53							FA208TT		MXS208	FA208R	MD6035D			
54		OSX6932	BRK013		SMX6932	BRK014	FA368TT		MXS368	FA368R	MD6035CE	MD6035C	MD6035CX	
55		OSX6932	BRK013		SMX6932	BRK014	FA368TT		MXS368	FA368R	MD6035CE	MD6035C	MD6035CX	
56		OSX6932	BRK013		SMX6932	BRK014	FA368TT		MXS368	FA368R	MD6035CE	MD6035C	MD6035CX	
57		OSX6932	BRK013		SMX6932	BRK014	FA368TT		MXS368	FA368R	MD6035CE	MD6035C	MD6035CX	
58		OSX6932	BRK013		SMX6932	BRK014	FA368TT		MXS368	FA368R	MD6035CE	MD6035C	MD6035CX	
59		OSX6932	BRK013		SMX6932	BRK014	FA368TT		MXS368	FA368R	MD6035CE	MD6035C	MD6035CX	
60		OSX6032	BRK011		SMX6032	BRK012	FA208TT		MXS368	FA208R	MD6035D	MD6035C	MD6035CX	

REAR / ARRIÈRE / HINTEN / POSTERIOR / POSTERIORE

HH Suffix = High Performance Sintered Pad. **TT** Suffix = Hard Wearing Off Road Pad. **V** Suffix = Semi Sintered Pad. **G** Suffix = Grooved Shoe.
D Suffix = Drilled Disc. **X** Suffix = Universal Left or Right Disc. **XC** Suffix = Contoured Disc. **LS** Suffix = Left/Steel Disc. **RS** = Right/Steel Disc.

*-2 Sets Required. † For Vee disc colours add RED, BLU, GRN, GLD, ORG suffix to part number.
 Ⓢ - Also available as a Vintage Motorcycle Disc.

Part numbers, prefixes, suffixes, photos and illustrations shown in this catalogue are trademarks and/or copyrights of EBC Brakes or the trademark owner A C Freeman Investments Ltd and use without express written permission of the owners is punishable by law.

Non-JAPANESE Built Motorcycles



HUSABERG Contd.



DISC PAD CHOICES - FRONT

BRAKE DISC CHOICES - FRONT

FA, SFA, TT Pad or Brake Shoe	SFAC Carbon Scooter Pads	Speciality Pads - SXR / Vee / MXS	Sintered/HH Pads/ Grooved Shoes	Left / Gauche / Links Standard Replacement Disc	Right / Droite / Rechts Standard Replacement Disc	Contour Disc Universal left and right fitment	Universal Custom Disc	Vee-Discs Black † See note below	CX Extreme MX Race Disc/ UTVX Disc
FE 450 (New 70° Engine)		MXS181	FA181R			MD6032C			MD6032CX
FS 450 C		MXS405		N/A					
FS 450 E		MXS405		N/A					
FX 450 (New 70° Engine)	FA181TT	MXS181	FA181R			MD6032C			MD6032CX
FE 501 (4T)	FA181TT	MXS181	FA181R			MD6032C			MD6032CX
FE 550 E	FA181TT	MXS181	FA181R	MD6032D		MD6032C			MD6032CX
FS 550 E Supermoto		MXS405		MD6270D		MD6270C			
FE 570 (New 70° Engine)	FA181TT	MXS181	FA181R			MD6032C			MD6032CX
FS 570 (Supermoto)	FA433/4		FA433/4HH			TBA			
FE 650 E	FA181TT	MXS181	FA181R	MD6032D		MD6032C			MD6032CX
FS 650 C Supermoto		MXS405		MD6270D		MD6270C			
FS 650 E Supermoto		MXS405		MD6270D		MD6270C			
FS Supermotard Models (Beringer/FTE)									
6 piston caliper 310mm front disc		MXS406		MD6270D		MD6270C			
FS Supermotard Models (FTE 4 piston radial caliper)		MXS405		MD6270D		MD6270C			
♦ Plain undrilled disc for enduro use MD6035CE									
HUSQVARNA									
Husky Boy Racing S	H301								
Husky Boy Drum front & rear	H301								
Husky Boy Racing J	H301								
Husky Boy J	FA115TT	MXS115	FA115R						
Husky Boy R	FA115TT	MXS115	FA115R						
Husky Boy S	FA115TT	MXS115	FA115R						
CR 50 Junior	FA351TT								
CR 50 Senior Pro	FA351TT								
CR 50	FA325TT		FA325R						
EE 5 Electric	FA325TT		FA325R						
SM 50	FA167								
SM 50	FA325TT		FA325R						
TC 50/ Mini	FA325TT		FA325R						
WR 50	FA167		FA167HH						
WRS 50 Scooter	SFA115	SFAC115	SFA115HH		MD964D				
CR 65	FA357TT		FA357R						
TC 65	FA357TT		FA357R						
TC 85 (2T/17 Inch/14 Inch Wheels)	FA612TT		FA612R			MD6258C			
TC 85 (2T/17 Inch/14 Inch Wheels)	FA612TT		FA612R			MD6379C			
TC 85 (2T/19 Inch/14 Inch Wheels)	FA612TT		FA612R			MD6379C			
TC 85 (2T/17 Inch/14 Inch Wheels, 220 f/disc, 210 r/disc)	FA181TT	MXS181	FA181R			MD6379C			MD6379CX
TC 85 (2T/19 Inch/14 Inch Wheels, 240 f/disc & 220 r/disc)	FA181TT	MXS181	FA181R			MD6379C			MD6379CX
TE 100	FA351TT								
CR 125	N/A		801G						
CR 125			801G						
CR 125			801G						
CR 125			803G						
CR 125	FA047TT		FA047R						
CR 125	FA134		FA134R						
CR 125	FA135TT	MXS135	FA135R	MD6125D					
CR 125	FA181TT	MXS181	FA181R	MD6125D					
CR 125 (45mm diameter Marzocchi forks with 60mm caliper mount centres)	FA181TT	MXS181	FA181R	MD6184D		MD6184C			
CR 125 (48mm diameter Marzocchi forks or 48mm diameter Kayaba forks with 95mm caliper mount centres)	FA181TT	MXS181	FA181R	MD6184D		MD6184C			
CR 125 (45mm diameter Marzocchi forks with 60mm caliper mount centres)	FA181TT	MXS181	FA181R	MD6184D		MD6184C			
CR 125 (48mm diameter Marzocchi forks or 48mm diameter Kayaba forks with 95mm caliper mount centres)	FA181TT	MXS181	FA181R	MD6184D		MD6184C			

Line #

1

2

3

4

5

6

7

8

9

10

11

12

13

14

15

16

17

18

19

20

21

22

23

24

25

26

27

28

29

30

31

32

33

34

35

36

37

38

39

40

41

42

43

44

45

46

47

48

49

50

51

52

53

54

55

56

57

58

59

60

FRONT / AVANT / VORN / FRENTE / ANTERIORE

R Suffix = High Durability Sintered Pad. HH Suffix = High Performance Sintered Pad. TT Suffix = Hard Wearing Off Road Pad. V Suffix = Semi Sintered Pad. G Suffix = Grooved Shoe.

D Suffix = Drilled Disc. X Suffix = Universal Left or Right Disc. XC Suffix = Contoured Disc. LS Suffix = Left/Steel Disc. RS = Right/Steel Disc.

*-2 Sets Required. † For Vee disc colours add RED, BLU, GRN, GLD, ORG suffix to part number.

⊗ - Also available as a Vintage Motorcycle Disc.

Non-JAPANESE Built Motorcycles

Line #	BRAKE DISC CHOICES - FRONT					DISC PAD CHOICES - REAR				BRAKE DISC CHOICES - REAR				
	OverSize 250 /280mm Disc Kit	OSX OverSize 250/280mm Disc Kit	Relocating Bracket for 250/ 280mm Disc	OverSize 320mm Disc Kit	SMX OverSize 320mm Disc Kit	Relocating Bracket for 320mm Disc	FA, SFA, TT Pad or Brake Shoe	SFAC Carbon Scooter Pads	Speciality Pads - SXR / Vee / MXS	Sintered/ HH Pads/ Grooved Shoes	Standard Replacement Disc	Contour Disc Rear fitment	Vee-Discs™ CONTOUR	CX Extreme MX Race Disc/ UTVX Disc
1		OSX6932	BRK013		SMX6932	BRK014	FA368TT		MXS368	FA368R	MD6035CE	MD6035C		MD6035CX
2							FA208TT		MXS208	FA208R	MD6035D	MD6035C		
3							FA208TT		MXS208	FA208R	MD6035D	MD6035C		
4		OSX6932	BRK013		SMX6932	BRK014	FA368TT		MXS368	FA368R	MD6035CE	MD6035C		MD6035CX
5		OSX6932	BRK013		SMX6932	BRK014	FA368TT		MXS368	FA368R	MD6035CE	MD6035C		MD6035CX
6		OSX6032	BRK011		SMX6032	BRK012	FA208TT		MXS208	FA208R	MD6035D	MD6035C		MD6035CX
7							FA208TT		MXS208	FA208R	MD6035D	MD6035C		
8		OSX6932	BRK013		SMX6932	BRK014	FA368TT		MXS368	FA368R	MD6035CE	MD6035C		MD6035CX
9							FA368TT		MXS368	FA368R	MD6035CE	MD6035C		
10		OSX6032	BRK011		SMX6032	BRK012	FA208TT		MXS208	FA208R	MD6035D	MD6035C		MD6035CX
11							FA208TT		MXS208	FA208R	MD6035D	MD6035C		
12							FA208TT		MXS208	FA208R	MD6035D	MD6035C		
13														
14							FA208TT		MXS208	FA208R	MD6035D	MD6035C		
15							FA208TT		MXS208	FA208R	MD6035D	MD6035C		
16														
17														
18														
19							H301							
20							H301							
21							H301							
22							984							
23							984							
24							984							
25														
26							FA325TT							
27							FA325TT			FA325R				
28							FA325TT			FA325R				
29							FA115			FA115HH				
30							FA325TT			FA325R				
31							FA325TT			FA325R				
32							FA115			FA115HH				
33							S624							
34							FA602TT			FA602R				
35							FA357TT			FA357R				
36		OSX6258	BRK028				FA602TT			FA602R		MD6360C		
37							FA602TT			FA602R		MD6360C		
38							FA602TT			FA602R		MD6360C		
39							FA368TT		MXS368	FA368R		MD6407C		
40							FA368TT		MXS368	FA368R		MD6407C		
41														
42														
43										801G				N/A
44										801G				
45										801G				
46														
47										802G				
48							FA251				MD6126D			
49		OSX6125	BRK010		SMX6125	BRK007	FA084TT			FA084R	MD6126D			
50							FA208TT		MXS208	FA208R	MD6126D			
51		OSX6184HC	BRK010		SMX6184H	BRK007	FA208TT		MXS208	FA208R	MD6287D			
52														
53														
54		OSX6184K	BRK011		SMX6184K	BRK012	FA208TT		MXS208	FA208R	MD6287D			
55														
56		OSX6184HC	BRK010		SMX6184H	BRK007	FA208TT		MXS208	FA208R	MD6295D			
57														
58														
59		OSX6184K	BRK011		SMX6184K	BRK012	FA208TT		MXS208	FA208R	MD6295D			
60														

REAR / ARRIERE / HINTEN / POSTERIOR / POSTERIORE

R Suffix = High Durability Sintered Pad. **HH** Suffix = High Performance Sintered Pad. **TT** Suffix = Hard Wearing Off Road Pad. **V** Suffix = Semi Sintered Pad. **G** Suffix = Grooved Shoe.
D Suffix = Drilled Disc. **X** Suffix = Universal Left or Right Disc. **XC** Suffix = Contoured Disc. **LS** Suffix = Left/Steel Disc. **RS** = Right/Steel Disc.

BRAKE APPLICATIONS

*-2 Sets Required. † For Vee disc colours add RED, BLU, GRN, GLD, ORG suffix to part number.
 Ⓢ - Also available as a Vintage Motorcycle Disc.

Non-JAPANESE Built Motorcycles



HUSQVARNA Contd.



DISC PAD CHOICES - FRONT

BRAKE DISC CHOICES - FRONT

FA, SFA, TT Pad or Brake Shoe	SFAC Carbon Scooter Pads	Speciality Pads - SXR / Vee / MXS	Sintered/HH Pads/ Grooved Shoes	Left / Gauche / Links Standard Replacement Disc	Right / Droite / Rechts Standard Replacement Disc	Contour Disc Universal left and right fitment	Universal Custom Disc	Vee-Discs Black † See note below	CX Extreme MX Race Disc/ UTVX Disc
CR 125 (45mm diameter Marzocchi forks with 60mm caliper mount centres) 05	FA181TT	MXS181	FA181R	MD6184D		MD6184C			
CR 125 (48mm diameter Marzocchi forks or 48mm diameter Kayaba forks with 95mm caliper mount centres) 05	FA181TT	MXS181	FA181R	MD6184D		MD6184C			
CR 125 (45mm diameter Marzocchi forks with 60mm caliper mount centres) 06-08	FA181TT	MXS181	FA181R	MD6184D		MD6184C			
CR 125 (48mm diameter Marzocchi forks or 48mm diameter Kayaba forks with 95mm caliper mount centres) 06-08	FA181TT	MXS181	FA181R	MD6184D		MD6184C			
CR 125 (45mm diameter Marzocchi forks with 60mm caliper mount centres) 09-13	FA181TT	MXS181	FA181R	MD6184D		MD6184C			
CR 125 (48mm diameter Marzocchi forks or 48mm diameter Kayaba forks with 95mm caliper mount centres) 09-13	FA181TT	MXS181	FA181R	MD6184D		MD6184C			
SC 125 73-74	N/A		801G						
SM 125 (6 bolt fixing) 98-99	FA181TT	MXS181	FA181R	MD6125D					
SM 125 (4 bolt fixing) (45mm diameter Marzocchi forks with 60mm caliper mount centres) 00	FA181TT	MXS181	FA181R	MD6184D		MD6184C			
SM 125 (4 bolt fixing) (48mm diameter Marzocchi forks or 48mm diameter Kayaba forks with 95mm caliper mount centres) 00	FA181TT	MXS181	FA181R	MD6184D		MD6184C			
SM 125 S (4 bolt fixing/2T) (45mm diameter Marzocchi forks with 60mm caliper mount centres) 02-13	FA181TT	MXS181	FA181R	MD6184D		MD6184C			
SM 125 S (4 bolt fixing/2T) (48mm diameter Marzocchi forks or 48mm diameter Kayaba forks with 95mm caliper mount centres) 02-13	FA181TT	MXS181	FA181R	MD6184D		MD6184C			
SMS4 125 (4T) (45mm diameter Marzocchi forks with 60mm caliper mount centres) 11	FA181TT	MXS181	FA181R	MD6184D		MD6184C			
SMS4 125 (4T) (48mm diameter Marzocchi forks or 48mm diameter Kayaba forks with 95mm caliper mount centres) 11	FA181TT	MXS181	FA181R	MD6184D		MD6184C			
Svartpilen 125 21	FA606		FA606HH						
TC 125 (2T) 14-22	FA181TT	MXS181	FA181R			MD6032C			MD6032CX
TE 125 (4T) (45mm diameter Marzocchi forks with 60mm caliper mount centres) 11-13	FA181TT	MXS181	FA181R	MD6184D		MD6184C			
TE 125 (4T) (48mm diameter Marzocchi forks or 48mm diameter Kayaba forks with 95mm caliper mount centres) 11-13	FA181TT	MXS181	FA181R	MD6184D		MD6184C			
TE 125 (2T) 14-19	FA181TT	MXS181	FA181R			MD6032C			MD6032CX
♦ Plain undrilled disc for enduro use MD6035CE									
TX 125 (2T) 18-19	FA181TT	MXS181	FA181R						
WR 125 73-74	N/A		801G						
WR 125 79			801G						
WR 125 80-81			802G						
WR 125 82-84			803G						
WR 125 87-88	FA134		FA134R						
WR 125 91	FA134		FA134R						
WR 125 93-94	FA135TT	MXS135	FA135R	MD6125D					
WR 125 95-99	FA181TT	MXS181	FA181R	MD6125D					
WR 125 (45mm diameter Marzocchi forks with 60mm caliper mount centres) 00-01	FA181TT	MXS181	FA181R	MD6184D		MD6184C			
WR 125 (48mm diameter Marzocchi forks or 48mm diameter Kayaba forks with 95mm caliper mount centres) 00-01	FA181TT	MXS181	FA181R	MD6184D		MD6184C			
WR 125 (45mm diameter Marzocchi forks with 60mm caliper mount centres) 02-05	FA181TT	MXS181	FA181R	MD6184D		MD6184C			
WR 125 (48mm diameter Marzocchi forks or 48mm diameter Kayaba forks with 95mm caliper mount centres) 02-05	FA181TT	MXS181	FA181R	MD6184D		MD6184C			

FRONT / AVANT / VORN / FREITE / ANTERIORE

Line #
1
2
3
4
5
6
7
8
9
10
11
12
13
14
15
16
17
18
19
20
21
22
23
24
25
26
27
28
29
30
31
32
33
34
35
36
37
38
39
40
41
42
43
44
45
46
47
48
49
50
51
52
53
54
55
56
57
58
59
60

R Suffix = High Durability Sintered Pad. HH Suffix = High Performance Sintered Pad. TT Suffix = Hard Wearing Off Road Pad. V Suffix = Semi Sintered Pad. G Suffix = Grooved Shoe.
D Suffix = Drilled Disc. X Suffix = Universal Left or Right Disc. XC Suffix = Contoured Disc. LS Suffix = Left/Steel Disc. RS = Right/Steel Disc.

*-2 Sets Required. † For Vee disc colours add RED, BLU, GRN, GLD, ORG suffix to part number.

⊗ - Also available as a Vintage Motorcycle Disc.

Non-JAPANESE Built Motorcycles

Line #	BRAKE DISC CHOICES - FRONT						DISC PAD CHOICES - REAR				BRAKE DISC CHOICES - REAR			
	Oversize 250 /280mm Disc Kit	OSX Oversize 250/280mm Disc Kit	Relocating Bracket for 250/ 280mm Disc	Oversize 320mm Disc Kit	SMX Oversize 320mm Disc Kit	Relocating Bracket for 320mm Disc	FA, SFA, TT Pad or Brake Shoe	SFAC Carbon Scooter Pads	Speciality Pads - SXR / Vee / MXS	Sintered/ HH Pads/ Grooved Shoes	Standard Replacement Disc	Contour Disc Rear fitment	Vee-Discs™ CONTOUR	CX Extreme MX Race Disc/ UTVX Disc
1														
2		OSX6184HC	BRK010		SMX6184H	BRK007	FA368TT		MXS368	FA368R	MD6295D			
3														
4														
5		OSX6184K	BRK011		SMX6184K	BRK012	FA368TT		MXS368	FA368R	MD6295D			
6														
7		OSX6184HC	BRK010		SMX6184H	BRK007	FA368TT		MXS368	FA368R	MD6288D			
8														
9														
10		OSX6184K	BRK011		SMX6184K	BRK012	FA368TT		MXS368	FA368R	MD6288D			
11														
12		OSX6184HC	BRK010		SMX6184H	BRK007	FA368TT		MXS368	FA368R				
13														
14														
15		OSX6184K	BRK011		SMX6184K	BRK012	FA368TT		MXS368	FA368R				
16														
17		OSX6125	BRK010		SMX6125	BRK007	FA208TT		MXS208	FA208R	MD6126D			
18														
19		OSX6184HC	BRK010		SMX6184H	BRK007	FA208TT		MXS208	FA208R	MD6287D			
20														
21														
22		OSX6184K	BRK011		SMX6184K	BRK012	FA208TT		MXS208	FA208R	MD6287D			
23														
24		OSX6184HC	BRK010		SMX6184H	BRK007	FA208TT		MXS208	FA208R	MD6287D			
25														
26														
27		OSX6184K	BRK011		SMX6184K	BRK012	FA208TT		MXS208	FA208R	MD6287D			
28														
29		OSX6184HC	BRK010		SMX6184H	BRK007	FA208TT		MXS208	FA208R	MD6287D			
30														
31														
32		OSX6184K	BRK011		SMX6184K	BRK012	FA208TT		MXS208	FA208R	MD6287D			
33							FA208TT		MXS208	FA208R				
34		OSX6932	BRK013		SMX6932	BRK014	FA368TT		MXS368	FA368R		MD6035C	MD6035CX	
35														
36		OSX6184HC	BRK010		SMX6184H	BRK007	FA208TT		MXS208	FA208R	MD6287D			
37														
38														
39		OSX6184K	BRK011		SMX6184K	BRK012	FA208TT		MXS208	FA208R	MD6287D			
40		OSX6932	BRK013		SMX6932	BRK014	FA368TT		MXS368	FA368R	MD6035CE	MD6035C	MD6035CX	
41														
42							FA368TT		MXS368	FA368R				
43							N/A			801G				
44										801G				
45										802G				
46										802G				
47										802G				
48							FA251				MD6126D			
49							FA084TT		MXS084	FA084R	MD6126D			
50		OSX6125	BRK010		SMX6125	BRK007	FA208TT		MXS208	FA208R	MD6126D			
51														
52		OSX6184HC	BRK010		SMX6184H	BRK007	FA208TT		MXS208	FA208R	MD6287D			
53														
54														
55		OSX6184K	BRK011		SMX6184K	BRK012	FA208TT		MXS208	FA208R	MD6287D			
56														
57		OSX6184HC	BRK010		SMX6184H	BRK007	FA208TT		MXS208	FA208R	MD6295D			
58														
59														
60		OSX6184K	BRK011		SMX6184K	BRK012	FA208TT		MXS208	FA208R	MD6295D			

REAR / ARRIÈRE / HINTEN / POSTERIOR / POSTERIORE

R Suffix = High Durability Sintered Pad. HH Suffix = High Performance Sintered Pad. TT Suffix = Hard Wearing Off Road Pad. V Suffix = Semi Sintered Pad. G Suffix = Grooved Shoe.
D Suffix = Drilled Disc. X Suffix = Universal Left or Right Disc. XC Suffix = Contoured Disc. LS Suffix = Left/Steel Disc. RS = Right/Steel Disc.

*-2 Sets Required. † For Vee disc colours add RED, BLU, GRN, GLD, ORG suffix to part number.
⊙ - Also available as a Vintage Motorcycle Disc.

Non-JAPANESE Built Motorcycles



HUSQVARNA Contd.



DISC PAD CHOICES - FRONT

BRAKE DISC CHOICES - FRONT

FA, SFA, TT Pad or Brake Shoe	SFAC Carbon Scooter Pads	Speciality Pads - SXR / Vee / MXS	Sintered/HH Pads/ Grooved Shoes	Left / Gauche / Links Standard Replacement Disc	Right / Droite / Rechts Standard Replacement Disc	Contour Disc Universal left and right fitment	Universal Custom Disc	Vee-Discs Black † See note below	CX Extreme MX Race Disc/ UTVX Disc
WR 125 (45mm diameter Marzocchi forks with 60mm caliper mount centres) 06-08		MXS181	FA181R	MD6184D		MD6184C			
WR 125 (48mm diameter Marzocchi forks or 48mm diameter Kayaba forks with 95mm caliper mount centres) 06-08		MXS181	FA181R	MD6184D		MD6184C			
WR 125 (45mm diameter Marzocchi forks with 60mm caliper mount centres) 09-13		MXS181	FA181R			MD6184C			
WR 125 (48mm diameter Marzocchi forks or 48mm diameter Kayaba forks with 95mm caliper mount centres) 09-13		MXS181	FA181R			MD6184C			
WRE 125 93-99		MXS181	FA181R	MD6125D					
WRE 125 (45mm diameter Marzocchi forks with 60mm caliper mount centres) 00		MXS181	FA181R	MD6184D		MD6184C			
WRE 125 (48mm diameter Marzocchi forks or 48mm diameter Kayaba forks with 95mm caliper mount centres) 00		MXS181	FA181R	MD6184D		MD6184C			
WRE 125 (45mm diameter Marzocchi forks with 60mm caliper mount centres) 02-13		MXS181	FA181R	MD6184D		MD6184C			
WRE 125 (48mm diameter Marzocchi forks or 48mm diameter Kayaba forks with 95mm caliper mount centres) 02-13		MXS181	FA181R	MD6184D		MD6184C			
WRE 125 (45mm diameter Marzocchi forks with 60mm caliper mount centres) 07			FA167	MD6184D		MD6184C			
WRE 125 (48mm diameter Marzocchi forks or 48mm diameter Kayaba forks with 95mm caliper mount centres) 07			FA167	MD6184D		MD6184C			
XC 125 82-84			803G						
XC 125 85-86			FA047R						
TE 150 TPI (2T) 18-22			FA181R	MD6032C					
CR 240 81-81			802G						
CR 240 82-84			803G						
CR 240 85-86			FA047R						
CR 240 87-88			FA134R						
WR 240 78			801G						
WR 240 80-81			802G						
WR 240 82-84			803G						
WR 240 87-88			FA134R						
WR 240 90-91			FA134R						
CR 250 71-74			N/A						
CR 250 75-79			801G						
CR 250 80-81			802G						
CR 250 82-84			803G						
CR 250 85-86			FA047R						
CR 250 87-88			FA134R						
CR 250 91			FA134R						
CR 250 92-94		MXS135	FA135R	MD6125D					
CR 250 95-99		MXS181	FA181R	MD6125D					
CR 250 (45mm diameter Marzocchi forks with 60mm caliper mount centres) 00-01		MXS181	FA181R	MD6184D		MD6184C			
CR 250 (48mm diameter Marzocchi forks or 48mm diameter Kayaba forks with 95mm caliper mount centres) 00-01		MXS181	FA181R	MD6184D		MD6184C			
CR 250 (45mm diameter Marzocchi forks with 60mm caliper mount centres) 02-04		MXS181	FA181R	MD6184D		MD6184C			
CR 250 (48mm diameter Marzocchi forks or 48mm diameter Kayaba forks with 95mm caliper mount centres) 02-04		MXS181	FA181R	MD6184D		MD6184C			
CR 250 (45mm diameter Marzocchi forks with 60mm caliper mount centres) 05-07		MXS181	FA181R	MD6184D		MD6184C			

FRONT / AVANT / VORN / FRENTE / ANTERIORE

Line #
1
2
3
4
5
6
7
8
9
10
11
12
13
14
15
16
17
18
19
20
21
22
23
24
25
26
27
28
29
30
31
32
33
34
35
36
37
38
39
40
41
42
43
44
45
46
47
48
49
50
51
52
53
54
55
56
57
58
59
60

R Suffix = High Durability Sintered Pad. HH Suffix = High Performance Sintered Pad. TT Suffix = Hard Wearing Off Road Pad. V Suffix = Semi Sintered Pad. G Suffix = Grooved Shoe.
D Suffix = Drilled Disc. X Suffix = Universal Left or Right Disc. XC Suffix = Contoured Disc. LS Suffix = Left/Steel Disc. RS = Right/Steel Disc.

*-2 Sets Required. † For Vee disc colours add RED, BLU, GRN, GLD, ORG suffix to part number.

⊗ - Also available as a Vintage Motorcycle Disc.

Non-JAPANESE Built Motorcycles

Line #	BRAKE DISC CHOICES - FRONT						DISC PAD CHOICES - REAR				BRAKE DISC CHOICES - REAR			
	OverSize 250 /280mm Disc Kit	OSX OverSize 250/280mm Disc Kit	Relocating Bracket for 250/ 280mm Disc	OverSize 320mm Disc Kit	SMX OverSize 320mm Disc Kit	Relocating Bracket for 320mm Disc	FA, SFA, TT Pad or Brake Shoe	SFAC Carbon Scooter Pads	Speciality Pads - SXR / Vee / MXS	Sintered/ HH Pads/ Grooved Shoes	Standard Replacement Disc	Contour Disc Rear fitment	Vee-Discs™ CONTOUR	CX Extreme MX Race Disc/ UTVX Disc
1														
2		OSX6184HC	BRK010		SMX6184H	BRK007	FA368TT		MXS368	FA368R	MD6288D			
3														
4														
5		OSX6184K	BRK011		SMX6184K	BRK012	FA368TT		MXS368	FA368R	MD6288D			
6														
7		OSX6184HC	BRK010		SMX6184H	BRK007	FA368TT		MXS368	FA368R				
8														
9														
10		OSX6184K	BRK011		SMX6184K	BRK012	FA368TT		MXS368	FA368R				
11		OSX6125	BRK010		SMX6125	BRK007	FA208TT		MXS208	FA208R	MD6126D			
12														
13		OSX6184HC	BRK010		SMX6184H	BRK007	FA208TT		MXS208	FA208R	MD6287D			
14														
15														
16		OSX6184K	BRK011		SMX6184K	BRK012	FA208TT		MXS208	FA208R	MD6287D			
17														
18		OSX6184HC	BRK010		SMX6184H	BRK007	FA208TT		MXS208	FA208R	MD6287D			
19														
20														
21		OSX6184K	BRK011		SMX6184K	BRK012	FA208TT		MXS208	FA208R	MD6287D			
22														
23		OSX6184HC	BRK010		SMX6184H	BRK007	FA131TT		MXS131	FA131R				
24														
25														
26		OSX6184K	BRK011		SMX6184K	BRK012	FA131TT		MXS131	FA131R				
27														
28										802G				
29		OSX6032E	BRK013				FA368TT		MXS368	FA368R	MD6035C			
30										801G				
31										801G				
32										802G				
33										802G				
34										801G				
35										802G				
36										802G				
37														
38							FA251				MD6126D			
39										801G				
40										801G				
41										801G				
42										801G				
43										802G				
44										802G				
45							FA251				MD6126D			
46							FA084TT			FA084R	MD6126D			
47		OSX6125	BRK010		SMX6125	BRK007	FA208TT		MXS208	FA208R	MD6126D			
48														
49		OSX6184HC	BRK010		SMX6184H	BRK007	FA208TT		MXS208	FA208R	MD6287D			
50														
51														
52		OSX6184K	BRK011		SMX6184K	BRK012	FA208TT		MXS208	FA208R	MD6287D			
53														
54		OSX6184HC	BRK010		SMX6184H	BRK007	FA208TT		MXS208	FA208R	MD6295D			
55														
56														
57		OSX6184K	BRK011		SMX6184K	BRK012	FA208TT		MXS208	FA208R	MD6295D			
58														
59		OSX6184HC	BRK010		SMX6184H	BRK007	FA368TT		MXS368	FA368R	MD6295D			
60														

REAR / ARRIÈRE / HINTEN / POSTERIOR / POSTERIORE

R Suffix = High Durability Sintered Pad. HH Suffix = High Performance Sintered Pad. TT Suffix = Hard Wearing Off Road Pad. V Suffix = Semi Sintered Pad. G Suffix = Grooved Shoe.
D Suffix = Drilled Disc. X Suffix = Universal Left or Right Disc. XC Suffix = Contoured Disc. LS Suffix = Left/Steel Disc. RS = Right/Steel Disc.

*-2 Sets Required. † For Vee disc colours add RED, BLU, GRN, GLD, ORG suffix to part number.
⊗ - Also available as a Vintage Motorcycle Disc.

Non-JAPANESE Built Motorcycles



HUSQVARNA Contd.



DISC PAD CHOICES - FRONT

BRAKE DISC CHOICES - FRONT

R Suffix = High Durability Sintered Pad. **HH** Suffix = High Performance Sintered Pad. **TT** Suffix = Hard Wearing Off Road Pad. **V** Suffix = Semi Sintered Pad. **G** Suffix = Grooved Shoe.

D Suffix = Drilled Disc. **X** Suffix = Universal Left or Right Disc. **XC** Suffix = Contoured Disc. **LS** Suffix = Left/Steel Disc. **RS** = Right/Steel Disc.

FRONT / AVANT / VORN / FRENTE / ANTERIORE

Model / Description / Part No.	FA, SFA, TT Pad or Brake Shoe	SFAC Carbon Scooter Pads	Speciality Pads - SXR / Vee / MXS	Sintered/HH Pads/ Grooved Shoes	BRAKE DISC CHOICES - FRONT						Line #
					Left / Gauche / Links Standard Replacement Disc	Right / Droite / Rechts Standard Replacement Disc	Contour Disc Universal left and right fitment	Universal Custom Disc	Vee-Disks Black † See note below	CX Extreme MX Race Disc/ UTVX Disc	
CR 250 (48mm diameter Marzocchi forks or 48mm diameter Kayaba)											1
with 95mm caliper mount centres) 05-07	FA181TT		MXS181	FA181R	MD6184D		MD6184C				2
FC 250 (4T) 14-22	FA181TT		MXS181	FA181R			MD6032C			MD6032CX	4
FE 250 (4T) 14-22	FA181TT		MXS181	FA181R			MD6032C			MD6032CX	5
♦ Plain undrilled disc for enduro use MD6035CE											6
TC 250 (45mm diameter Marzocchi forks with 60mm caliper mount centres) 02-03	FA181TT		MXS181	FA181R	MD6184D		MD6184C				7
TC 250 (48mm diameter Marzocchi forks or 48mm diameter Kayaba forks)											8
with 95mm caliper mount centres) 02-03	FA181TT		MXS181	FA181R	MD6184D		MD6184C				9
TC 250 (45mm diameter Marzocchi forks with 60mm caliper mount centres) 05-08	FA181TT		MXS181	FA181R	MD6184D		MD6184C				10
TC 250 (48mm diameter Marzocchi forks or 48mm diameter Kayaba forks)											11
with 95mm caliper mount centres) 05-08	FA181TT		MXS181	FA181R	MD6184D		MD6184C				12
TC 250 (4T) 09-13	FA181TT		MXS181	FA181R	MD6184D		MD6184C				13
TC 250 (2T) 14-22	FA181TT		MXS181	FA181R	MD6032C					MD6032CX	14
TE 250 (4T) (45mm diameter Marzocchi forks with 60mm caliper mount centres) 02-05	FA181TT		MXS181	FA181R	MD6184D		MD6184C				15
TE 250 (4T) (48mm diameter Marzocchi forks or 48mm diameter Kayaba forks)											16
with 95mm caliper mount centres) 02-05	FA181TT		MXS181	FA181R	MD6184D		MD6184C				17
TE 250 (4T) (45mm diameter Marzocchi forks with 60mm caliper mount centres) 06-08	FA181TT		MXS181	FA181R	MD6184D		MD6184C				18
TE 250 (4T) (48mm diameter Marzocchi forks or 48mm diameter Kayaba forks)											19
with 95mm caliper mount centres) 06-08	FA181TT		MXS181	FA181R	MD6184D		MD6184C				20
TE 250 (4T) 09-10	FA181TT		MXS181	FA181R	MD6184D		MD6184C				21
TE 250 (4T) 11-13	FA181TT		MXS181	FA181R	MD6184D		MD6184C				22
TE 250 Meo Replica (4T) 11	FA181TT		MXS181	FA181R	MD6184D		MD6184C				23
TE 250 R (4T) 13	FA181TT		MXS181	FA181R	MD6184D		MD6184C				24
TE 250 (2T) 14-20	FA181TT		MXS181	FA181R	MD6184D		MD6032C			MD6032CX	25
TE 250 TPI (2T) 19-22	FA181TT		MXS181	FA181R			MD6032C			MD6032CX	26
WR 250 71-74				801G							27
WR 250 75-78				801G							28
WR 250 80-81				802G							29
WR 250 82-84				803G							30
WR 250 87-88	FA134			FA134R							31
WR 250 90-91	FA134			FA134R							32
WR 250 92-94	FA135TT		MXS135	FA135R	MD6125D						33
WR 250 95-99	FA181TT		MXS181	FA181R	MD6125D						34
WR 250 (45mm diameter Marzocchi forks with 60mm caliper mount centres) 00-01	FA181TT		MXS181	FA181R	MD6184D		MD6184C				35
WR 250 (48mm diameter Marzocchi forks or 48mm diameter Kayaba forks)											36
with 95mm caliper mount centres) 00-01	FA181TT		MXS181	FA181R	MD6184D		MD6184C				37
WR 250 (45mm diameter Marzocchi forks with 60mm caliper mount centres) 02-05	FA181TT		MXS181	FA181R	MD6184D		MD6184C				38
WR 250 (48mm diameter Marzocchi forks or 48mm diameter Kayaba forks)											39
with 95mm caliper mount centres) 02-05	FA181TT		MXS181	FA181R	MD6184D		MD6184C				40
WR 250 (45mm diameter Marzocchi forks with 60mm caliper mount centres) 06-08	FA181TT		MXS181	FA181R	MD6184D		MD6184C				41
WR 250 (48mm diameter Marzocchi forks or 48mm diameter Kayaba forks)											42
with 95mm caliper mount centres) 06-08	FA181TT		MXS181	FA181R	MD6184D		MD6184C				43
WR 250 (2T) (45mm diameter Marzocchi forks with 60mm caliper mount centres) 09-13	FA181TT		MXS181	FA181R	MD6184D		MD6184C				44

*-2 Sets Required. † For Vee disc colours add RED, BLU, GRN, GLD, ORG suffix to part number.

⊗ - Also available as a Vintage Motorcycle Disc.

Non-JAPANESE Built Motorcycles

Line #	BRAKE DISC CHOICES - FRONT						DISC PAD CHOICES - REAR				BRAKE DISC CHOICES - REAR			
	OverSize 250 /280mm Disc Kit	OSX OverSize 250/280mm Disc Kit	Relocating Bracket for 250/ 280mm Disc	OverSize 320mm Disc Kit	SMX OverSize 320mm Disc Kit	Relocating Bracket for 320mm Disc	FA, SFA, TT Pad or Brake Shoe	SFAC Carbon Scooter Pads	Speciality Pads - SXR / Vee / MXS	Sintered/ HH Pads/ Grooved Shoes	Standard Replacement Disc	Contour Disc Rear fitment	Vee-Discs™ CONTOUR	CX Extreme MX Race Disc/ UTVX Disc
1														
2														
3		OSX6184K	BRK011		SMX6184K	BRK012	FA368TT		MXS368	FA368R	MD6295D			
4		OSX6032E	BRK013		SMX6932	BRK014	FA368TT		MXS368	FA368R		MD6035C	MD6035CX	
5		OSX6032E	BRK013		SMX6932	BRK014	FA368TT		MXS368	FA368R	MD6035CE♦	MD6035C	MD6035CX	
6														
7														
8		OSX6184HC	BRK010		SMX6184H	BRK007	FA208TT		MXS208	FA208R	MD6295D			
9														
10														
11		OSX6184K	BRK011		SMX6184K	BRK012	FA208TT		MXS208	FA208R	MD6295D			
12														
13		OSX6184HC	BRK010		SMX6184H	BRK007	FA368TT		MXS368	FA368R	MD6288D			
14														
15														
16		OSX6184K	BRK011		SMX6184K	BRK012	FA368TT		MXS368	FA368R	MD6288D			
17		OSX6184K9	BRK013		SMX6184K9	BRK014	FA368TT		MXS368	FA368R				
18		OSX6032E	BRK013		SMX6932	BRK014	FA368TT		MXS368	FA368R		MD6035C	MD6035CX	
19														
20		OSX6184HC	BRK010		SMX6184H	BRK007	FA208TT		MXS208	FA208R	MD6295D			
21														
22														
23		OSX6184K	BRK011		SMX6184K	BRK012	FA208TT		MXS208	FA208R	MD6295D			
24														
25		OSX6184HC	BRK010		SMX6184H	BRK007	FA368TT		MXS368	FA368R	MD6288D			
26														
27														
28		OSX6184K	BRK011		SMX6184K	BRK012	FA368TT		MXS368	FA368R	MD6288D			
29		OSX6184K9	BRK013		SMX6184K9	BRK014	FA368TT		MXS368	FA368R		MD6288C		
30		OSX6184K9	BRK013		SMX6184K9	BRK014	FA368TT		MXS368	FA368R		MD6377C		
31		OSX6184K9	BRK013		SMX6184K9	BRK014	FA368TT		MXS368	FA368R		MD6377C		
32		OSX6184K9	BRK013		SMX6184K9	BRK014	FA368TT		MXS368	FA368R		MD6377C		
33		OSX6032E	BRK013		SMX6932	BRK014	FA368TT		MXS368	FA368R	MD6035CE♦	MD6035C	MD6035CX	
34		OSX6032E	BRK013		SMX6932	BRK014	FA368TT		MXS368	FA368R	MD6035CE♦	MD6035C	MD6035CX	
35														
36									801G					
37									802G					
38									802G					
39									802G					
40							FA251				MD6126D			
41							FA084TT		MXS084	FA084R	MD6126D			
42		OSX6125	BRK010		SMX6125	BRK007	FA208TT		MXS208	FA208R	MD6126D			
43														
44		OSX6184HC	BRK010		SMX6184H	BRK007	FA208TT		MXS208	FA208R	MD6287D			
45														
46														
47		OSX6184K	BRK011		SMX6184K	BRK012	FA208TT		MXS208	FA208R	MD6287D			
48														
49		OSX6184HC	BRK010		SMX6184H	BRK007	FA208TT		MXS208	FA208R	MD6295D			
50														
51														
52		OSX6184K	BRK011		SMX6184K	BRK012	FA208TT		MXS208	FA208R	MD6295D			
53														
54		OSX6184HC	BRK010		SMX6184H	BRK007	FA208TT		MXS208	FA208R	MD6295D			
55														
56														
57		OSX6184K	BRK011		SMX6184K	BRK012	FA208TT		MXS208	FA208R	MD6295D			
58														
59		OSX6184HC	BRK010		SMX6184H	BRK007	FA208TT		MXS208	FA208R	MD6295D			
60														

REAR / ARRIÈRE / HINTEN / POSTERIOR / POSTERIORE

R Suffix = High Durability Sintered Pad. **HH** Suffix = High Performance Sintered Pad. **TT** Suffix = Hard Wearing Off Road Pad. **V** Suffix = Semi Sintered Pad. **G** Suffix = Grooved Shoe.
D Suffix = Drilled Disc. **X** Suffix = Universal Left or Right Disc. **XC** Suffix = Contoured Disc. **LS** Suffix = Left/Steel Disc. **RS** = Right/Steel Disc.

BRAKE APPLICATIONS

*-2 Sets Required. † For Vee disc colours add RED, BLU, GRN, GLD, ORG suffix to part number.
 ♦ - Also available as a Vintage Motorcycle Disc.

Non-JAPANESE Built Motorcycles



HUSQVARNA Contd.



DISC PAD CHOICES - FRONT

BRAKE DISC CHOICES - FRONT

R Suffix = High Durability Sintered Pad. **HH** Suffix = High Performance Sintered Pad. **TT** Suffix = Hard Wearing Off Road Pad. **V** Suffix = Semi Sintered Pad. **G** Suffix = Grooved Shoe.

D Suffix = Drilled Disc. **X** Suffix = Universal Left or Right Disc. **XS** Suffix = Contoured Disc. **LS** Suffix = Left/Steel Disc. **RS** = Right/Steel Disc.

FRONT / AVANT / VORN / FRENTE / ANTERIORE

Model / Year	Year	DISC PAD CHOICES - FRONT			BRAKE DISC CHOICES - FRONT						Line #	
		FA, SFA, TT Pad or Brake Shoe	SFAC Carbon Scooter Pads	Speciality Pads - SXR / Vee / MXS	Sintered/HH Pads/ Grooved Shoes	Left / Gauche / Links Standard Replacement Disc	Right / Droite / Rechts Standard Replacement Disc	Contour Disc Universal left and right fitment	Universal Custom Disc	Vee-Discs Black † See note below		CX Extreme MX Race Disc/ UTVX Disc
WR 250 (2T) (48mm diameter Marzocchi forks or 48mm diameter Kayaba forks with 95mm caliper mount centres)	09-13	FA181TT		MXS181	FA181R			MD6184C				1
XC 250	80-81				802G							2
XC 250	82-84				803G							3
XC 250	85-86	FA047TT			FA047R							4
XC 250	87-88	FA134			FA134R							5
WR 260	90-91	FA134			FA134R							6
WR 300 (2T) (45mm diameter Marzocchi forks with 60mm caliper mount centres)	09-13	FA181TT		MXS181	FA181R			MD6184C				7
WR 300 (2T) (48mm diameter Marzocchi forks or 48mm diameter Kayaba forks with 95mm caliper mount centres)	09-13	FA181TT		MXS181	FA181R			MD6184C				8
TE 300 (2T)	14-20	FA181TT		MXS181	FA181R			MD6032C			MD6032CX	9
TE 300 TPI (2T)	19-22	FA181TT		MXS181	FA181R			MD6032C			MD6032CX	10
TE 300i Jarvis Edition (2T)	19-21	FA181TT		MXS181	FA181R			MD6032C			MD6032CX	11
TE 300 TPI RockStar Edition 2T	22	FA181TT		MXS181	FA181R			MD6032C			MD6032CX	12
TX 300 (2T)	18-21	FA181TT		MXS181	FA181R			MD6032C			MD6032CX	13
TE 310 (4T)	10	FA181TT		MXS181	FA181R			MD6184C				14
TE 310 (4T)	11-13	FA181TT		MXS181	FA181R			MD6184C				15
TE 310 R (4T)	13	FA181TT		MXS181	FA181R			MD6184C				16
FC 350 (4T)	14-22	FA181TT		MXS181	FA181R			MD6032C			MD6032CX	17
FE 350 (4T) inc S model	14-22	FA181TT		MXS181	FA181R			MD6032C			MD6032CX	18
FE 350 RockStar Edition	22	FA181TT		MXS181	FA181R			MD6032C			MD6032CX	19
FX 350 (4T)	18-21	FA181TT		MXS181	FA181R			MD6032C			MD6032CX	20
♦ Plain undrilled disc for enduro use MD6035CE												21
TE 350	90-91	FA134			FA134R							22
TE 350	92-94	FA135TT		MXS135	FA135R	MD6125D						23
TE 350	95-97	FA181TT		MXS181	FA181R	MD6125D						24
360 Automatic	75-77	N/A										25
CR 360	75-78				801G							26
CR 360	92-94	FA135TT		MXS135	FA135R	MD6125D						27
WR 360	75-78				801G							28
WR 360	92-94	FA135TT		MXS135	FA135R	MD6125D						29
WR 360	95-99	FA181TT		MXS181	FA181R	MD6125D						30
WR 360 (45mm diameter Marzocchi forks with 60mm caliper mount centres)	00-01	FA181TT		MXS181	FA181R	MD6184D		MD6184C				31
WR 360 (48mm diameter Marzocchi forks or 48mm diameter Kayaba forks with 95mm caliper mount centres)	00-01	FA181TT		MXS181	FA181R	MD6184D		MD6184C				32
WR 360 (45mm diameter Marzocchi forks with 60mm caliper mount centres)	02	FA181TT		MXS181	FA181R	MD6184D		MD6184C				33
WR 360 (48mm diameter Marzocchi forks or 48mm diameter Kayaba forks with 95mm caliper mount centres)	02	FA181TT		MXS181	FA181R	MD6184D		MD6184C				34
ACC 390	80-81				801G							35
ACCE 390	80-81				801G							36
CR 390	75-79				801G							37
CR 390	80-81				801G							38
CR 390 Automatic	78				801G							39
WR 390	78				801G							40
CR 400	71-74				801G							41
SM 400 R	02	FA095			FA095HH	MD6293D						42
TE 400 (45mm diameter Marzocchi forks with 60mm caliper mount centres)	02	FA181TT		MXS181	FA181R	MD6184D		MD6184C				43
TE 400 (48mm diameter Marzocchi forks or 48mm diameter Kayaba forks with 95mm caliper mount centres)	02	FA181TT		MXS181	FA181R	MD6184D		MD6184C				44
WR 400	75-78				801G							45
WR 400	87-88	FA134			FA134R							46

*-2 Sets Required. † For Vee disc colours add RED, BLU, GRN, GLD, ORG suffix to part number.

⊗ - Also available as a Vintage Motorcycle Disc.

Non-JAPANESE Built Motorcycles

Line #	BRAKE DISC CHOICES - FRONT						DISC PAD CHOICES - REAR				BRAKE DISC CHOICES - REAR			
	OverSize 250 /280mm Disc Kit	OSX OverSize 250/280mm Disc Kit	Relocating Bracket for 250/ 280mm Disc	OverSize 320mm Disc Kit	SMX OverSize 320mm Disc Kit	Relocating Bracket for 320mm Disc	FA, SFA, TT Pad or Brake Shoe	SFAC Carbon Scooter Pads	Speciality Pads - SXR / Vee / MXS	Sintered/ HH Pads/ Grooved Shoes	Standard Replacement Disc	Contour Disc Rear fitment	Vee-Discs™ CONTOUR	CX Extreme MX Race Disc/ UTVX Disc
1														
2														
3		OSX6184K	BRK011		SMX6184K	BRK012	FA208TT		MXS208	FA208R	MD6295D			
4										802G				
5										802G				
6										801G				
7										802G				
8							FA251				MD6126D			
9														
10		OSX6184HC	BRK010		SMX6184H	BRK007	FA208TT		MXS208	FA208R	MD6295D			
11														
12														
13		OSX6184K	BRK011		SMX6184K	BRK012	FA208TT		MXS208	FA208R	MD6295D			
14		OSX6032E	BRK013		SMX6932	BRK014	FA368TT		MXS368	FA368R	MD6035CE	MD6035C		MD6035CX
15		OSX6032E	BRK013		SMX6932	BRK014	FA368TT		MXS368	FA368R	MD6035CE	MD6035C		MD6035CX
16		OSX6032E	BRK013		SMX6932	BRK014	FA368TT		MXS368	FA368R	MD6035CE	MD6035C		MD6035CX
17		OSX6032E	BRK013		SMX6932	BRK014	FA368TT		MXS368	FA368R	MD6035CE	MD6035C		MD6035CX
18		TBA	TBA		TBA	TBA	FA368TT		MXS368	FA368R	MD6035CE	MD6035C		MD6035CX
19		OSX6184K9	BRK013		SMX6184K9	BRK014	FA368TT		MXS368	FA368R		MD6288C		
20		OSX6184K9	BRK013		SMX6184K9	BRK014	FA368TT		MXS368	FA368R		MD6377C		
21		OSX6184K9	BRK013		SMX6184K9	BRK014	FA368TT		MXS368	FA368R		MD6377C		
22		OSX6932	BRK013		SMX6932	BRK014	FA368TT		MXS368	FA368R		MD6035C		MD6035CX
23		OSX6932	BRK013		SMX6932	BRK014	FA368TT		MXS368	FA368R	MD6035CE	MD6035C		MD6035CX
24		OSX6932	BRK013		SMX6932	BRK014	FA368TT		MXS368	FA368R	MD6035CE	MD6035C		MD6035CX
25							FA368TT		MXS368	FA368R	MD6035CE	MD6035C		MD6035CX
26														
27							FA251				MD6126D			
28							FA084TT		MXS084	FA084R	MD6126D			
29		OSX6125	BRK010		SMX6125	BRK007	FA208TT		MXS208	FA208R	MD6126D			
30										801G				
31										801G				
32							FA084TT		MXS084	FA084R	MD6126D			
33										801G				
34							FA084TT		MXS084	FA084R	MD6126D			
35		OSX6125	BRK010		SMX6125	BRK007	FA208TT		MXS208	FA208R	MD6126D			
36														
37		OSX6184HC	BRK010		SMX6184H	BRK007	FA208TT		MXS208	FA208R	MD6287D			
38														
39														
40		OSX6184K	BRK011		SMX6184K	BRK012	FA208TT		MXS208	FA208R	MD6287D			
41														
42		OSX6184HC	BRK010		SMX6184H	BRK007	FA208TT		MXS208	FA208R	MD6295D			
43														
44														
45		OSX6184K	BRK011		SMX6184K	BRK012	FA208TT		MXS208	FA208R	MD6295D			
46										801G				
47										801G				
48										801G				
49										801G				
50										801G				
51										801G				
52										801G				
53							FA208TT		MXS208	FA208R	MD6295D			
54														
55		OSX6184HC	BRK010		SMX6184H	BRK007	FA208TT		MXS208	FA208R	MD6295D			
56														
57														
58		OSX6184K	BRK011		SMX6184K	BRK012	FA208TT		MXS208	FA208R	MD6295D			
59										801G				
60										802G				

REAR / ARRIÈRE / HINTEN / POSTERIOR / POSTERIORE

R Suffix = High Durability Sintered Pad. **HH** Suffix = High Performance Sintered Pad. **TT** Suffix = Hard Wearing Off Road Pad. **V** Suffix = Semi Sintered Pad. **G** Suffix = Grooved Shoe.
D Suffix = Drilled Disc. **X** Suffix = Universal Left or Right Disc. **XC** Suffix = Contoured Disc. **LS** Suffix = Left/Steel Disc. **RS** = Right/Steel Disc.

*-2 Sets Required. † For Vee disc colours add RED, BLU, GRN, GLD, ORG suffix to part number.
 Ⓢ - Also available as a Vintage Motorcycle Disc.

Non-JAPANESE Built Motorcycles



HUSQVARNA Contd.



DISC PAD CHOICES - FRONT

BRAKE DISC CHOICES - FRONT

R Suffix = High Durability Sintered Pad. **HH** Suffix = High Performance Sintered Pad. **TT** Suffix = Hard Wearing Off Road Pad. **V** Suffix = Semi Sintered Pad. **G** Suffix = Grooved Shoe.

D Suffix = Drilled Disc. **X** Suffix = Universal Left or Right Disc. **XC** Suffix = Contoured Disc. **LS** Suffix = Left/Steel Disc. **RS** = Right/Steel Disc.

FRONT / AVANT / VORN / FRENTE / ANTERIORE

		FA, SFA, TT Pad or Brake Shoe	SFAC Carbon Scooter Pads	Speciality Pads - SXR / Vee / MXS	Sintered/HH Pads/ Grooved Shoes	Left / Gauche / Links Standard Replacement Disc	Right / Droite / Rechts Standard Replacement Disc	Contour Disc Universal left and right filament	Universal Custom Disc	Vee-Discs Black † See note below	CX Extreme MX Race Disc/ UTVX Disc	Line #
Svartpilen 401 (4T)	18-21	FA606			FA606HH							1
Vitpilen 401 (4T)	18-21	FA606			FA606HH							2
TE 410	95-99	FA181TT		MXS181	FA181R	MD6125D						3
TE 410 (45mm diameter Marzocchi forks with 60mm caliper mount centres)	00	FA181TT		MXS181	FA181R	MD6184D		MD6184C				4
TE 410 (48mm diameter Marzocchi forks or 48mm diameter Kayaba forks with 95mm caliper mount centres)	00	FA181TT		MXS181	FA181R	MD6184D		MD6184C				5
TE 410 (45mm diameter Marzocchi forks with 60mm caliper mount centres)	06	FA181TT		MXS181	FA181R	MD6184D		MD6184C				6
TE 410 (48mm diameter Marzocchi forks or 48mm diameter Kayaba forks with 95mm caliper mount centres)	06	FA181TT		MXS181	FA181R	MD6184D		MD6184C				7
TE 410 E (45mm diameter Marzocchi forks with 60mm caliper mount centres)	00	FA181TT		MXS181	FA181R	MD6184D		MD6184C				8
TE 410 E (48mm diameter Marzocchi forks or 48mm diameter Kayaba forks with 95mm caliper mount centres)	00	FA181TT		MXS181	FA181R	MD6184D		MD6184C				9
430 Automatic	87-88	FA134			FA134R							10
CR 430	80-81				802G							11
CR 430	87-88	FA134			FA134R							12
WR 430	80-81				802G							13
WR 430	87-88	FA134			FA134R							14
WR-E 430	80-81				802G							15
WR-E 430	82-84				803G							16
WRU 430	82-84				803G							17
XC 430	80-81				802G							18
XC 430	87-88	FA134			FA134R							19
SMR 449 (4T)	11				FA322/4HH							20
TC 449 (4T)	11-13	FA181TT		MXS181	FA181R			MD6184C				21
TE 449 (4T)	11-13	FA181TT		MXS181	FA181R			MD6184C				22
CR 450	71-74				801G							23
FC 450 (4T)	14-22	FA181TT		MXS181	FA181R			MD6032C			MD6032CX	24
FC 450 Rockstar Edition (4T)	19-22	FA181TT		MXS181	FA181R			MD6032C			MD6032CX	25
FE 450 (4T)	14-22	FA181TT		MXS181	FA181R			MD6032C			MD6032CX	26
♦ Plain undrilled disc for enduro use MD6035CE												27
FR 450 Rally (4T)	16-20	FA209/2			FA209/2HH	MD6032D		MD6032C			MD6032CX	28
FS 450 (4T)	15-20				FA447HH	MD6032D		MD6032C				29
FX 450 (4T)	17-21	FA181TT		MXS181	FA181R	MD6032D		MD6032C			MD6032CX	30
SM 450 R	03-06	FA095			FA095HH	MD6293D						31
SMR 450 RR (Radial caliper)	06-07				FA322/4HH	MD6293D						32
SM 450 R Radial caliper	07-10				FA322/4HH	MD6293D						33
SM 450 RR	08-10				FA322/4HH							34
TC 450 (45mm diameter Marzocchi forks with 60mm caliper mount centres)	03-04	FA181TT		MXS181	FA181R	MD6184D		MD6184C				35
TC 450 (48mm diameter Marzocchi forks or 48mm diameter Kayaba forks with 95mm caliper mount centres)	03-04	FA181TT		MXS181	FA181R	MD6184D		MD6184C				36
TC 450 (45mm diameter Marzocchi forks with 60mm caliper mount centres)	05-08	FA181TT		MXS181	FA181R	MD6184D		MD6184C				37
TC 450 (48mm diameter Marzocchi forks or 48mm diameter Kayaba forks with 95mm caliper mount centres)	05-08	FA181TT		MXS181	FA181R	MD6184D		MD6184C				38
TC 450 (45mm diameter Marzocchi forks with 60mm caliper mount centres)	09-10	FA181TT		MXS181	FA181R			MD6184C				39
TC 450 (48mm diameter Marzocchi forks or 48mm diameter Kayaba forks with 95mm caliper mount centres)	09-10	FA181TT		MXS181	FA181R			MD6184C				40
TE 450 (45mm diameter Marzocchi forks with 60mm caliper mount centres)	03-05	FA181TT		MXS181	FA181R	MD6184D		MD6184C				41

*-2 Sets Required. † For Vee disc colours add RED, BLU, GRN, GLD, ORG suffix to part number.

⊗ - Also available as a Vintage Motorcycle Disc.

Non-JAPANESE Built Motorcycles

Line #	BRAKE DISC CHOICES - FRONT						DISC PAD CHOICES - REAR				BRAKE DISC CHOICES - REAR			
	OverSize 250 /280mm Disc Kit	OSX OverSize 250/280mm Disc Kit	Relocating Bracket for 250/ 280mm Disc	OverSize 320mm Disc Kit	SMX OverSize 320mm Disc Kit	Relocating Bracket for 320mm Disc	FA, SFA, TT Pad or Brake Shoe	SFAC Carbon Scooter Pads	Speciality Pads - SXR / Vee / MXS	Sintered/ HH Pads/ Grooved Shoes	Standard Replacement Disc	Contour Disc Rear fitment	Vee-Discs™ CONTOUR	CX Extreme MX Race Disc/ UTVX Disc
1							FA208TT			FA208R				
2							FA208TT			FA208R				
3		OSX6125	BRK010		SMX6125	BRK007	FA208TT		MXS208	FA208R	MD6126D			
4														
5		OSX6184HC	BRK010		SMX6184H	BRK007	FA208TT		MXS208	FA208R	MD6287D			
6														
7														
8		OSX6184K	BRK011		SMX6184K	BRK012	FA208TT		MXS208	FA208R	MD6287D			
9														
10		OSX6184HC	BRK010		SMX6184H	BRK007	FA368TT		MXS368	FA368R	MD6288D			
11														
12														
13		OSX6184K	BRK011		SMX6184K	BRK012	FA368TT		MXS368	FA368R	MD6288D			
14														
15		OSX6184HC	BRK010		SMX6184H	BRK007	FA208TT		MXS208	FA208R	MD6126D			
16														
17														
18		OSX6184K	BRK011		SMX6184K	BRK012	FA208TT		MXS208	FA208R	MD6126D			
19														
20										802G				
21										801G				
22										802G				
23										802G				
24										802G				
25										802G				
26										802G				
27										802G				
28										802G				
29							FA368TT		MXS368	FA368R				
30		OSX6184K9	BRK013		SMX6184K9	BRK014	FA368TT		MXS368	FA368R				
31		OSX6184K9	BRK013		SMX6184K9	BRK014	FA368TT		MXS368	FA368R				
32										801G				
33		OSX6932	BRK013		SMX6932	BRK014	FA368TT		MXS368	FA368R		MD6035C		MD6035CX
34		OSX6032E	BRK013		SMX6932	BRK014	FA368TT		MXS368	FA368R		MD6035C		MD6035CX
35		OSX6032E	BRK013		SMX6932	BRK014	FA368TT		MXS368	FA368R	MD6035C	MD6035C		MD6035CX
36														
37		OSX6032	BRK013		SMX6932	BRK014	FA208TT		MXS208	FA208R		MD6035C		MD6035CX
38					SMX6932	BRK014	FA368TT		MXS368	FA368R		MD6035C		MD6035CX
39		OSX6032	BRK013		SMX6932	BRK014	FA368TT		MXS368	FA368R		MD6035C		MD6035CX
40							FA208TT		MXS208	FA208R	MD6295D			
41							FA368TT		MXS368	FA368R	MD6288D			
42							FA368TT		MXS368	FA368R	MD6288D			
43							FA368TT		MXS368	FA368R				
44														
45		OSX6184HC	BRK010		SMX6184H	BRK007	FA208TT		MXS208	FA208R	MD6295D			
46														
47														
48		OSX6184K	BRK011		SMX6184K	BRK012	FA208TT		MXS208	FA208R	MD6295D			
49														
50		OSX6184HC	BRK010		SMX6184H	BRK007	FA368TT		MXS368	FA368R	MD6288D			
51														
52														
53		OSX6184K	BRK011		SMX6184K	BRK012	FA368TT		MXS368	FA368R	MD6288D			
54														
55		OSX6184HC	BRK010		SMX6184H	BRK007	FA368TT		MXS368	FA368R		MD6288C		
56														
57														
58		OSX6184K	BRK011		SMX6184K	BRK012	FA368TT		MXS368	FA368R		MD6288C		
59														
60		OSX6184HC	BRK010		SMX6184H	BRK007	FA208TT		MXS208	FA208R	MD6295D			

REAR / ARRIÈRE / HINTEN / POSTERIOR / POSTERIORE

R Suffix = High Durability Sintered Pad. HH Suffix = High Performance Sintered Pad. TT Suffix = Hard Wearing Off Road Pad. V Suffix = Semi Sintered Pad. G Suffix = Grooved Shoe.
D Suffix = Drilled Disc. X Suffix = Universal Left or Right Disc. XC Suffix = Contoured Disc. LS Suffix = Left/Steel Disc. RS = Right/Steel Disc.

*-2 Sets Required. † For Vee disc colours add RED, BLU, GRN, GLD, ORG suffix to part number.
⊗ - Also available as a Vintage Motorcycle Disc.

Part numbers, prefixes, suffixes, photos and illustrations shown in this catalogue are trademarks and/or copyrights of EBC Brakes or the trademark owner A C Freeman Investments Ltd and use without express written permission of the owners is punishable by law.

Non-JAPANESE Built Motorcycles



HUSQVARNA Contd.



DISC PAD CHOICES - FRONT

BRAKE DISC CHOICES - FRONT

FA, SFA, TT Pad or Brake Shoe	SFAC Carbon Scooter Pads	Speciality Pads - SXR / Vee / MXS	Sintered/HH Pads/ Grooved Shoes	Left / Gauche / Links Standard Replacement Disc	Right / Droite / Rechts Standard Replacement Disc	Contour Disc Universal left and right fitment	Universal Custom Disc	Vee-Disks Black † See note below	CX Extreme MX Race Disc/ UTVX Disc
TE 450 (48mm diameter Marzocchi forks or 48mm diameter Kayaba forks with 95mm caliper mount centres) 03-05	FA181TT	MXS181	FA181R	MD6184D		MD6184C			
TE 450 (45mm diameter Marzocchi forks with 60mm caliper mount centres) 06-08	FA181TT	MXS181	FA181R	MD6184D		MD6184C			
TE 450 (48mm diameter Marzocchi forks or 48mm diameter Kayaba forks with 95mm caliper mount centres) 06-08	FA181TT	MXS181	FA181R	MD6184D		MD6184C			
TE 450 (4T) (45mm diameter Marzocchi forks with 60mm caliper mount centres) 09-10	FA181TT	MXS181	FA181R			MD6184C			
TE 450 (4T) (48mm diameter Marzocchi forks or 48mm diameter Kayaba forks with 95mm caliper mount centres) 09-10	FA181TT	MXS181	FA181R			MD6184C			
WR 450 71-72			801G						
AE 500 82-84			803G						
CR 500 82-84			803G						
CR 500 85-86	FA047TT		FA047R						
CR 500 87-88	FA134		FA134R						
XC 500 82-84			803G						
XC 500 85-86	FA047TT		FA047R						
XC 500 87-88	FA134		FA134R						
FE 501 (4T) 14-22	FA181TT	MXS181	FA181R			MD6032C			MD6032CX
♦ Plain undrilled disc for enduro use MD6035CE									
SM 510 R 05	FA095		FA095HH	MD6293D					
SM 510 R (Radial caliper) 06-10			FA322/4HH	MD6293D					
TC 510 87-88	FA047TT		FA047R						
TC 510 89-	FA134		FA134R						
TC 510 1990	FA134		FA134R						
TC 510 (45mm diameter Marzocchi forks with 60mm caliper mount centres) 04	FA181TT	MXS181	FA181R	MD6184D		MD6184C			
TC 510 (48mm diameter Marzocchi forks or 48mm diameter Kayaba forks with 95mm caliper mount centres) 04	FA181TT	MXS181	FA181R	MD6184D		MD6184C			
TC 510 (45mm diameter Marzocchi forks with 60mm caliper mount centres) 05-08	FA181TT	MXS181	FA181R	MD6184D		MD6184C			
TC 510 (48mm diameter Marzocchi forks or 48mm diameter Kayaba forks with 95mm caliper mount centres) 05-08	FA181TT	MXS181	FA181R	MD6184D		MD6184C			
TC 510 09	FA181TT	MXS181	FA181R						
TE 510 87-88	FA047TT		FA047R						
TE 510 89-	FA134		FA134R						
TE 510 90	FA134		FA134R						
TE 510 (45mm diameter Marzocchi forks with 60mm caliper mount centres) 04-05	FA181TT	MXS181	FA181R			MD6184C			
TE 510 (48mm diameter Marzocchi forks or 48mm diameter Kayaba forks with 95mm caliper mount centres) 04-05	FA181TT	MXS181	FA181R	MD6184D		MD6184C			
TE 510 (45mm diameter Marzocchi forks with 60mm caliper mount centres) 06-08	FA181TT	MXS181	FA181R	MD6184D		MD6184C			
TE 510 (48mm diameter Marzocchi forks or 48mm diameter Kayaba forks with 95mm caliper mount centres) 06-08	FA181TT	MXS181	FA181R	MD6184D		MD6184C			
TE 510 (45mm diameter Marzocchi forks with 60mm caliper mount centres) 09-10	FA181TT	MXS181	FA181R			MD6184C			
TE 510 (48mm diameter Marzocchi forks or 48mm diameter Kayaba forks with 95mm caliper mount centres) 09-10	FA181TT	MXS181	FA181R			MD6184C			
TX 510 87-88	FA047TT		FA047R						
WMX 510 89	FA134		FA134R						
WXE 510 89	FA134		FA134R						
SMR 511 11-13			FA322/4HH						

FRONT / AVANT / VORN / FRENTE / ANTERIORE

Line #
1
2
3
4
5
6
7
8
9
10
11
12
13
14
15
16
17
18
19
20
21
22
23
24
25
26
27
28
29
30
31
32
33
34
35
36
37
38
39
40
41
42
43
44
45
46
47
48
49
50
51
52
53
54
55
56
57
58
59
60

R Suffix = High Durability Sintered Pad. HH Suffix = High Performance Sintered Pad. TT Suffix = Hard Wearing Off Road Pad. V Suffix = Semi Sintered Pad. G Suffix = Grooved Shoe.
D Suffix = Drilled Disc. X Suffix = Universal Left or Right Disc. XC Suffix = Contoured Disc. LS Suffix = Left/Steel Disc. RS = Right/Steel Disc.

*-2 Sets Required. † For Vee disc colours add RED, BLU, GRN, GLD, ORG suffix to part number.

⊗ - Also available as a Vintage Motorcycle Disc.

Non-JAPANESE Built Motorcycles

Line #	BRAKE DISC CHOICES - FRONT						DISC PAD CHOICES - REAR				BRAKE DISC CHOICES - REAR			
	OverSize 250 /280mm Disc Kit	OSX OverSize 250/280mm Disc Kit	Relocating Bracket for 250/ 280mm Disc	OverSize 320mm Disc Kit	SMX OverSize 320mm Disc Kit	Relocating Bracket for 320mm Disc	FA, SFA, TT Pad or Brake Shoe	SFAC Carbon Scooter Pads	Speciality Pads - SXR / Vee / MXS	Sintered/ HH Pads/ Grooved Shoes	Standard Replacement Disc	Contour Disc Rear fitment	Vee-Discs™ CONTOUR	CX Extreme MX Race Disc/ UTVX Disc
1														
2														
3		OSX6184K	BRK011		SMX6184K	BRK012	FA208TT		MXS208	FA208R	MD6295D			
4														
5		OSX6184HC	BRK010		SMX6184H	BRK007	FA368TT		MXS368	FA368R	MD6288D			
6														
7														
8		OSX6184K	BRK011		SMX6184K	BRK012	FA368TT		MXS368	FA368R	MD6288D			
9														
10		OSX6184HC	BRK010		SMX6184H	BRK007	FA368TT		MXS368	FA368R		MD6288C		
11														
12														
13		OSX6184K	BRK011		SMX6184K	BRK012	FA368TT		MXS368	FA368R	MD6288C			
14										801G				
15										802G				
16										801G				
17										802G				
18										802G				
19										802G				
20										801G				
21										802G				
22		OSX6932	BRK013		SMX6932	BRK014	FA368TT		MXS368	FA368R	MD6035CE♦	MD6035C	MD6035CX	
23														
24							FA208TT		MXS208	FA208R	MD6295D			
25							FA368TT		MXS368	FA368R	MD6288D			
26										801G				
27										801G				
28							FA251				MD6126D			
29														
30		OSX6184HC	BRK010		SMX6184H	BRK007	FA208TT		MXS208	FA208R	MD6295D			
31														
32														
33		OSX6184K	BRK011		SMX6184K	BRK012	FA208TT		MXS208	FA208R	MD6295D			
34														
35		OSX6184HC	BRK010		SMX6184H	BRK007	FA368TT		MXS208	FA368R	MD6288D			
36														
37														
38		OSX6184K	BRK011		SMX6184K	BRK012	FA368TT		MXS368	FA368R	MD6288D			
39							FA368TT		MXS368	FA368R				
40										801G				
41										801G				
42							FA251				MD6126D			
43														
44		OSX6184HC	BRK010		SMX6184H	BRK007	FA208TT		MXS208	FA208R	MD6295D			
45														
46														
47		OSX6184K	BRK011		SMX6184K	BRK012	FA208TT		MXS208	FA208R	MD6295D			
48														
49		OSX6184HC	BRK010		SMX6184H	BRK007	FA368TT		MXS368	FA368R	MD6288D			
50														
51		OSX6184K	BRK011		SMX6184K	BRK012	FA368TT		MXS368	FA368R	MD6288D			
52														
53		OSX6184HC	BRK010		SMX6184H	BRK007	FA368TT		MXS368	FA368R				
54														
55														
56		OSX6184K	BRK011		SMX6184K	BRK012	FA368TT		MXS368	FA368R				
57										801G				
58										801G				
59										801G				
60							FA368TT		MXS368	FA368R				

REAR / ARRIÈRE / HINTEN / POSTERIOR / POSTERIORE

R Suffix = High Durability Sintered Pad. **HH** Suffix = High Performance Sintered Pad. **TT** Suffix = Hard Wearing Off Road Pad. **V** Suffix = Semi Sintered Pad. **G** Suffix = Grooved Shoe.
D Suffix = Drilled Disc. **X** Suffix = Universal Left or Right Disc. **XC** Suffix = Contoured Disc. **LS** Suffix = Left/Steel Disc. **RS** = Right/Steel Disc.

*-2 Sets Required. † For Vee disc colours add RED, BLU, GRN, GLD, ORG suffix to part number.
♦ - Also available as a Vintage Motorcycle Disc.

Part numbers, prefixes, suffixes, photos and illustrations shown in this catalogue are trademarks and/or copyrights of EBC Brakes or the trademark owner A C Freeman Investments Ltd and use without express written permission of the owners is punishable by law.

Non-JAPANESE Built Motorcycles



HUSQVARNA Contd.



DISC PAD CHOICES - FRONT

BRAKE DISC CHOICES - FRONT

R Suffix = High Durability Sintered Pad. **HH** Suffix = High Performance Sintered Pad. **TT** Suffix = Hard Wearing Off Road Pad. **V** Suffix = Semi Sintered Pad. **G** Suffix = Grooved Shoe.

D Suffix = Drilled Disc. **X** Suffix = Universal Left or Right Disc. **XC** Suffix = Contoured Disc. **LS** Suffix = Left/Steel Disc. **RS** = Right/Steel Disc.

FRONT / AVANT / VORN / FRENTE / ANTERIORE

		FA, SFA, TT Pad or Brake Shoe	SFAC Carbon Scooter Pads	Speciality Pads - SXR / Vee / MXS	Sintered/HH Pads/ Grooved Shoes	Left / Gauche / Links Standard Replacement Disc	Right / Droite / Rechts Standard Replacement Disc	Contour Disc Universal left and right fitment	Universal Custom Disc	Vee-Discs Black † See note below	CX Extreme MX Race Disc/ UTVX Disc	Line #
TE 511 (4T)	11-12	FA181TT		MXS181	FA181R			MD6367C				1
M 530 RR	08-10				FA322/4HH	MD6293D						2
SM 570 R (4 bolt front disc)	01	FA095			FA095HH	MD6293D						3
SM 570 R	02-04	FA095			FA095HH	MD6293D						4
TC 570 (45mm diameter Marzocchi forks with 60mm caliper mount centres)	02-03	FA181TT		MXS181	FA181R	MD6184D		MD6184C				5
TC 570 (48mm diameter Marzocchi forks or 48mm diameter Kayaba forks with 95mm caliper mount centres)	02-03	FA181TT		MXS181	FA181R	MD6184D		MD6184C				6
TE 570 (45mm diameter Marzocchi forks with 60mm caliper mount centres)	01	FA181TT		MXS181	FA181R	MD6184D		MD6184C				7
TE 570 (48mm diameter Marzocchi forks or 48mm diameter Kayaba forks with 95mm caliper mount centres)	01	FA181TT		MXS181	FA181R	MD6184D		MD6184C				8
TE 570 (45mm diameter Marzocchi forks with 60mm caliper mount centres)	02-04	FA181TT		MXS181	FA181R	MD6184D		MD6184C				9
TE 570 (48mm diameter Marzocchi forks or 48mm diameter Kayaba forks with 95mm caliper mount centres)	02-04	FA181TT		MXS181	FA181R	MD6184D		MD6184C				10
LT 610 (6 bolt front disc)	00	FA244			FA244HH	MD6294D						11
SM 610 (6 bolt front disc)	98-99	FA244			FA244HH	MD6294D						12
SM 610 R (45mm diameter Marzocchi forks with 60mm caliper mount centres)	00	FA244			FA244HH	MD6184D		MD6184C				13
SM 610 R (48mm diameter Marzocchi forks or 48mm diameter Kayaba forks with 95mm caliper mount centres)	00	FA244			FA244HH	MD6184D		MD6184C				14
SM 610 S (4 bolt front disc)	02-06	FA244			FA244HH	MD6293D						15
SM 610 S (Radial caliper)	05				FA322/4HH	MD6293D						16
SM 610 IE	07-09				FA322/4HH	MD6293D						17
TC 610	91	FA134			FA134R							18
TC 610	92-94	FA135TT		MXS135	FA135R	MD6125D						19
TC 610/E	95-99	FA181TT		MXS181	FA181R	MD6125D						20
TC 610 (45mm diameter Marzocchi forks with 60mm caliper mount centres)	00	FA181TT		MXS181	FA181R	MD6184D		MD6184C				21
TC 610 (48mm diameter Marzocchi forks or 48mm diameter Kayaba forks with 95mm caliper mount centres)	00	FA181TT		MXS181	FA181R	MD6184D		MD6184C				22
TE 610	91	FA134			FA134R							23
TE 610	92-94	FA135TT		MXS135	FA135R	MD6125D						24
TE 610 (6 bolt fixing)	00	FA181TT		MXS181	FA181R	MD6125D						25
TE 610/E (6 bolt fixing)	95-99	FA181TT		MXS181	FA181R	MD6125D						26
TE 610/E (6 bolt fixing)	00	FA181TT		MXS181	FA181R	MD6125D						27
TE 610/E (6 bolt fixing)	03-04	FA181TT		MXS181	FA181R	MD6125D						28
TE 610/IE (45mm diameter Marzocchi forks with 60mm caliper mount centres)	06-09	FA181TT		MXS181	FA181R	MD6184D		MD6184C				29
TE 610/IE (48mm diameter Marzocchi forks or 48mm diameter Kayaba forks with 95mm caliper mount centres)	06-09	FA181TT		MXS181	FA181R	MD6184D		MD6184C				30
SMR 630	06	FA095			FA095HH	MD6293D						31
SMR 630 (4T)	10-12				FA322/4HH	MD6293D						32
STR 650 CRC	07				FA322/4HH	MD6293D						33
TE 630 (45mm diameter Marzocchi forks with 60mm caliper mount centres)	10-12	FA181TT		MXS181	FA181R	MD6184D		MD6184C				34
TE 630 (48mm diameter Marzocchi forks or 48mm diameter Kayaba forks with 95mm caliper mount centres)	10-12	FA181TT		MXS181	FA181R	MD6184D		MD6184C				35
TR 650 Terra (Spoke Wheel)	12-13	FA209/2			FA209/2HH	MD834						36
TR 650 Strada (Cast Wheel)	12-13	FA209/2			FA209/2HH	MD834						37
701 Enduro	16-20	FA209/2		FA209/2V	FA209/2HH	MD6299D		MD6299C				38
701 Enduro LR	19-20	FA209/2			FA209/2HH	MD6299D		MD6299C				39

*-2 Sets Required. † For Vee disc colours add RED, BLU, GRN, GLD, ORG suffix to part number.

⊗ - Also available as a Vintage Motorcycle Disc.

Non-JAPANESE Built Motorcycles

Line #	BRAKE DISC CHOICES - FRONT						DISC PAD CHOICES - REAR				BRAKE DISC CHOICES - REAR			
	Oversize 250 /280mm Disc Kit	OSX Oversize 250/280mm Disc Kit	Relocating Bracket for 250/ 280mm Disc	Oversize 320mm Disc Kit	SMX Oversize 320mm Disc Kit	Relocating Bracket for 320mm Disc	FA, SFA, TT Pad or Brake Shoe	SFAC Carbon Scooter Pads	Speciality Pads - SXR / Vee / MXS	Sintered/ HH Pads/ Grooved Shoes	Standard Replacement Disc	Contour Disc Rear fitment	Vee-Discs™ CONTOUR	CX Extreme MX Race Disc/ UTVX Disc
1		OSX6184K9	BRK013		SMX6184K9	BRK014	FA368TT		MXS368	FA368R		MD6377C		
2							FA368TT		MXS368	FA368R				
3							FA208TT		MXS208	FA208R	MD6287D			
4							FA208TT		MXS208	FA208R	MD6295D			
5														
6		OSX6184HC	BRK010		SMX6184H	BRK007	FA208TT		MXS208	FA208R	MD6295D			
7														
8														
9		OSX6184K	BRK011		SMX6184K	BRK012	FA208TT		MXS208	FA208R	MD6295D			
10														
11		OSX6184HC	BRK010		SMX6184H	BRK007	FA208TT		MXS208	FA208R	MD6287D			
12														
13														
14		OSX6184K	BRK011		SMX6184K	BRK012	FA208TT		MXS208	FA208R	MD6287D			
15														
16		OSX6184HC	BRK010		SMX6184H	BRK007	FA208TT		MXS208	FA208R	MD6287D			
17														
18														
19		OSX6184K	BRK011		SMX6184K	BRK012	FA208TT		MXS208	FA208R	MD6287D			
20							FA208TT		MXS208	FA208R	MD6295D			
21							FA208TT		MXS208	FA208R	MD6126D			
22														
23		OSX6184HC	BRK010		SMX6184H	BRK007	FA208TT		MXS208	FA208R	MD6287D			
24														
25														
26		OSX6184K	BRK011		SMX6184K	BRK012	FA208TT		MXS208	FA208R	MD6287D			
27							FA208TT		MXS208	FA208R	MD6287D			
28							FA208TT		MXS208	FA208R	MD6288D			
29							FA208TT		MXS208	FA208R	MD6295D			
30							FA251				MD6126D			
31							FA084TT		MXS084	FA084R	MD6126D			
32		OSX6125	BRK010		SMX6125	BRK007	FA208TT		MXS208	FA208R	MD6126D			
33														
34		OSX6184HC	BRK010		SMX6184H	BRK007	FA208TT		MXS208	FA208R	MD6287D			
35														
36														
37		OSX6184K	BRK011		SMX6184K	BRK012	FA208TT		MXS208	FA208R	MD6287D			
38							FA251				MD6126D			
39							FA084TT		MXS084	FA084R	MD6126D			
40		OSX6125	BRK010		SMX6125	BRK007	FA208TT		MXS208	FA208R	MD6287D			
41		OSX6125	BRK010		SMX6125	BRK007	FA208TT		MXS208	FA208R	MD6126D			
42		OSX6125	BRK010		SMX6125	BRK007	FA208TT		MXS208	FA208R	MD6126D			
43		OSX6125	BRK010		SMX6125	BRK007	FA208TT		MXS208	FA208R	MD6287D			
44														
45		OSX6184HC	BRK010		SMX6184H	BRK007	FA208TT		MXS208	FA208R				
46														
47														
48		OSX6184K	BRK011		SMX6184K	BRK012	FA208TT		MXS208	FA208R	MD6295D			
49							FA208TT		MXS208	FA208R	MD6295D			
50							FA208TT		MXS208	FA208R	MD6287D			
51							FA208TT		MXS208	FA208R	MD6295D			
52														
53		OSX6184HC	BRK010		SMX6184H	BRK007	FA208TT		MXS208	FA208R	MD6287D			
54														
55														
56		OSX6184K	BRK011		SMX6184K	BRK012	FA208TT		MXS208	FA208R	MD6287D			
57							FA213			FA213HH	MD651			
58							FA213		FA213V	FA213HH	MD651			
59							FA208TT		MXS208	FA208R		MD6417C		
60							FA208TT		MXS208	FA208R		MD6417C		

REAR / ARRIÈRE / HINTEN / POSTERIOR / POSTERIORE

R Suffix = High Durability Sintered Pad. **HH** Suffix = High Performance Sintered Pad. **TT** Suffix = Hard Wearing Off Road Pad. **V** Suffix = Semi Sintered Pad. **G** Suffix = Grooved Shoe.
D Suffix = Drilled Disc. **X** Suffix = Universal Left or Right Disc. **XC** Suffix = Contoured Disc. **LS** Suffix = Left/Steel Disc. **RS** = Right/Steel Disc.

BRAKE APPLICATIONS

*-2 Sets Required. † For Vee disc colours add RED, BLU, GRN, GLD, ORG suffix to part number.
 ☉ - Also available as a Vintage Motorcycle Disc.

Non-JAPANESE Built Motorcycles



HUSQVARNA Contd.



DISC PAD CHOICES - FRONT

BRAKE DISC CHOICES - FRONT

		FA, SFA, TT Pad or Brake Shoe	SFAC Carbon Scooter Pads	Speciality Pads - SXR / Vee / MXS	Sintered/HH Pads/ Grooved Shoes	Left / Gauche / Links Standard Replacement Disc	Right / Droite / Rechts Standard Replacement Disc	Contour Disc Universal left and right fitment	Universal Custom Disc	Vee-Discs Black † See note below	CX Extreme MX Race Disc/ UTVX Disc	Line #
701 Supermoto	16-20				FA322/4HH	MD6414D		MD6414C				1
701 Vitpilen	18-20	FA244			FA244HH							2
701 Svartpilen	18-20	FA244			FA244HH							3
Nuda 900 (Inc ABS)	12-13	FA244*			FA244HH*							4
Nuda R 900 (Inc ABS)	12-13				FA447HH*							5
												6
												7
HYOSUNG												
Eva Electric Scooter	13-14	SFA083	SFAC083		SFA083HH	TBA						8
50 Newtee Up (4T)	14-15	SFA169	SFAC169		SFA169HH	MD904D						9
Super Cab/Cab Plus/Sense 50/Prima Avanti	99-06	SFA083	SFAC083		SFA083HH	TBA						10
SD 50	00-06	SFA083	SFAC083		SFA083HH	TBA						11
SF 50 R Rally Prima/Racing	00-06	SFA083	SFAC083		SFA083HH	TBA						12
STE3 (Electric Scooter)	10-11	SFA083	SFAC083		SFA083HH	TBA						13
TE 50	05-07	938*										14
TE 90	05-07	938*										15
EZ 100	99-05	SFA083	SFAC083		SFA083HH	TBA						16
SF 100 R	05-06	SFA083	SFAC083		SFA083HH	N/A						17
TE 100	05-07	938*										18
FX 110 Midas - ECO/STD	99-02	S603										19
FX 110 DLX Midas	99-04	SFA083	SFAC083		SFA083HH	TBA						20
KR 110 Master	04-05	SFA083	SFAC083		SFA083HH	N/A						21
GPS 125 Grand Prix/Hyper Rear drum model	99-04	SFA047			SFA047HH		N/A					22
GPS 125 Grand Prix Plus Rear disc model	00-04	SFA047			SFA047HH		N/A					23
Cruise II GA 125 F	99-06	FA056				N/A						24
Boomer/Exceed 125	02-03	SFA047			SFA047HH		N/A					25
Comet 125/250	04	FA086			FA086HH	N/A						26
Exceed 125 (MS1-125/150)	02-04	FA047			FA047HH	N/A						27
Comet GT 125 (Naked)	04-06	FA086/2			FA086/2HH	MD690		MD690C				28
GT 125 Naked	03-06	FA086/2			FA086/2HH	MD690		MD690C				29
GT 125 Naked	07-12	FA086/2			FA086/2HH	MD690		MD690C				30
GT 125 i (Naked)	13-15	FA086/2			FA086/2HH	MD690		MD690C				31
GT 125 R	06-14	FA086/2			FA086/2HH	MD690		MD690C				32
GV 125 Aquila	01-06	FA086			FA086HH	N/A						33
GV 125 Classic	07-15	FA086/2			FA086/2HH	N/A						34
RT Karion 125	02-07	FA086			FA086HH	TBA						35
RT 125 D Karion	08-15	FA086/2			FA086/2HH	TBA						36
MS1 125/150	05	SFA047			SFA047HH	N/A						37
MS3 (125cc)	07-09	SFA197*	SFAC197*		SFA197HH*	MD9152D	MD9152D					38
RX 125	01-07	FA086			FA086HH	N/A						39
RX 125 D (XRX)	08-11	FA086/2			FA086/2HH	N/A						40
RX 125 D (Karion)	07-11	FA086/2			FA086/2HH	N/A						41
XRX 125 Enduro	00-06	FA086			FA086HH	N/A						42
XRX 125 Supermoto	07-11	FA086/2			FA086/2HH	N/A						43
XRX 125 LC Enduro	14-15	FA054TT			FA054R							44
XRX 125 LC Supermoto	14-15	FA054TT			FA054R							45
Comet 250	02	FA129			FA129HH	N/A						46
Comet GT 250 (Naked)	04-05	FA086			FA086HH	MD690		MD690C				47
GD 250 i Naked	13-15				FA296HH			N/A				48
GT 250 (Naked)	06-12	FA086/2			FA086/2HH	MD690		MD690C				49
GT 250 i (Naked)	13-15	FA086/2			FA086/2HH	N/A						50
GT 250 R (Carbs)	05-07	FA086/2*			FA086/2HH*	MD690	MD690	MD690C*				51
GT 250 i R	08-13	FA086/2*			FA086/2HH*	MD690	MD690	MD690C*				52
GT 250 i R	14-15	FA086/2*			FA086/2HH*	MD690	MD690	MD690C*				53
GV 250 Aquilia	04-07	FA086			FA086HH	N/A						54
GV 250 i Classic	08-15	FA086/2			FA086/2HH	N/A						55
MS3 250i	07-09	SFA197*	SFAC197*		SFA197HH*	MD9152D	MD9152D					56
RX 400	05	FA086			FA086HH	N/A						57
TE 450 Quad Rapier	06-09	FA054TT*		MXS054	FA054R*	N/A	N/A					58
Comet 600	02	FA129			FA129HH	N/A						59
Comet GT 650 (Naked)	04-06	FA086*			FA086HH*	TBA	TBA					60

FRONT / AVANT / VORN / FRENTE / ANTERIORE

R Suffix = High Durability Sintered Pad. HH Suffix = High Performance Sintered Pad. TT Suffix = Hard Wearing Off Road Pad. V Suffix = Semi Sintered Pad. G Suffix = Grooved Shoe.
D Suffix = Drilled Disc. X Suffix = Universal Left or Right Disc. XC Suffix = Contoured Disc. LS Suffix = Left/Steel Disc. RS = Right/Steel Disc.

*-2 Sets Required. † For Vee disc colours add RED, BLU, GRN, GLD, ORG suffix to part number.

⊗ - Also available as a Vintage Motorcycle Disc.

Non-JAPANESE Built Motorcycles

Line #	BRAKE DISC CHOICES - FRONT						DISC PAD CHOICES - REAR				BRAKE DISC CHOICES - REAR			
	Oversize 250 /280mm Disc Kit	OSX Oversize 250/280mm Disc Kit	Relocating Bracket for 250/ 280mm Disc	Oversize 320mm Disc Kit	SMX Oversize 320mm Disc Kit	Relocating Bracket for 320mm Disc	FA, SFA, TT Pad or Brake Shoe	SFAC Carbon Scooter Pads	Speciality Pads - SXR / Vee / MXS	Sintered/ HH Pads/ Grooved Shoes	Standard Replacement Disc	Contour Disc Rear fitment	Vee-Discs™ CONTOUR	CX Extreme MX Race Disc/ UTVX Disc
1							FA208TT		MXS208	FA208R	MD6415D	MD6415C		
2							FA208TT			FA208R				
3							FA208TT			FA208R				
4							FA213		FA213V	FA213HH	MD671			
5							FA213		FA213V	FA213HH	MD671			
6														
7														
8							SFA083	SFAC083		SFA083HH	TBA			
9							TBA							
10							TBA							
11							TBA							
12							TBA							
13							N/A							
14											MD6301D			
15											MD6301D			
16							TBA							
17							TBA							
18											MD6301D			
19							S603							
20							S603							
21							S603							
22							897							
23							SFA086			SFA086HH	N/A			
24							S602							
25							TBA				N/A			
26							FA086			FA086HH	N/A			
27							FA086			FA086HH	N/A			
28							FA086/2			FA086/2HH	MD689	MD689C		
29							FA086/2			FA086/2HH	MD689	MD689C		
30							FA086/2			FA086/2HH	MD689	MD689C		
31							FA086/2			FA086/2HH	MD689	MD689C		
32							FA086/2			FA086/2HH	MD689	MD689C		
33							S602							
34							S602							
35							S602							
36							S602							
37							TBA							
38							SFA197	SFAC197		SFA197HH	TBA			
39							S602							
40							S602							
41							S602							
42							S602							
43							FA165/2TT			FA165/2R	N/A			
44							FA083TT			FA083R				
45							FA083TT			FA083R				
46							FA063			FA063HH	TBA			
47							FA086			FA086HH	MD689	MD689C		
48							FA298			SFA298HH		N/A		
49							FA086/2			FA086/2HH	MD689	MD689C		
50							FA298			SFA298HH	N/A			
51							FA086/2			FA086/2HH	MD689	MD689C		
52							FA086/2			FA086/2HH	MD689	MD689C		
53							FA298			SFA298HH	MD689	MD689C		
54							S606							
55							S606							
56							SFA197	SFAC197		SFA197HH	N/A			
57							FA131TT				N/A			
58							FA054TT			FA054R	N/A			
59							FA063			FA063HH	TBA			
60							FA086			FA086HH	MD689			

REAR / ARRIÈRE / HINTEN / POSTERIOR / POSTERIORE

R Suffix = High Durability Sintered Pad. **HH** Suffix = High Performance Sintered Pad. **TT** Suffix = Hard Wearing Off Road Pad. **V** Suffix = Semi Sintered Pad. **G** Suffix = Grooved Shoe.
D Suffix = Drilled Disc. **X** Suffix = Universal Left or Right Disc. **XC** Suffix = Contoured Disc. **LS** Suffix = Left/Steel Disc. **RS** = Right/Steel Disc.

*-2 Sets Required. † For Vee disc colours add RED, BLU, GRN, GLD, ORG suffix to part number.
 Ⓢ - Also available as a Vintage Motorcycle Disc.

Part numbers, prefixes, suffixes, photos and illustrations shown in this catalogue are trademarks and/or copyrights of EBC Brakes or the trademark owner A C Freeman Investments Ltd and use without express written permission of the owners is punishable by law.

Non-JAPANESE Built Motorcycles



HYOSUNG Contd.



Comet GT 650 (Naked)	07-08
GT 650 (Naked)	09-11
GT 650 i (Naked)	12-15
GT 650 R	07-08
GT 650 i R	09-13
GT 650 i R	14-15
GT 650 X	07
GT 650 S	05-08
GV 650 Aquilia (Carb)	04-06
GV 650 (EFI)	07-12
GV 650 i Pro (Naked)	12-15
GV 700 C	06-09
ST7 (ST 700 i)	10-15
ST7 Deluxe (ST 700 i)	12-15

ITALJET

Dragster 50 LC	98-12
Formula 50 LC	96-03
Formula Air 50	99-03
50 it Scooter	09
Jet Set 50cc 2T	02-03
Pit Jet 50 (2T)	07-09
SX 150 Scooter	09
Velocifero 50	98-02
Torpedo 50 (All models)	98-03
(All models 125cc)	
Dragster 125/180 LC	99
Dragster 125/180 LC	00-12
Formula 125 LC (2T/Twin Cyl)	96-03
Formula 125 (4T/Single Cyl)	14-15
Jack 125/150	07
Jet Set 125/150 2T	02-03
Jupiter 125/150	02
Millennium M 100/125/150 LC	00-01
Millennium M 100/125/150 LC	02-04
Pit Jet 125 4T	07-08
Pit Jet 125 4T	07-09
Torpedo 125 4T (Pro)	99-09
Torpedo 125	07-08
Dragster 250	07-09
Jupiter 250	02-03
Marco Polo 400cc Scooter	07-09
Bazooka (650cc)	06
Griffon #59 (650cc)	06
Griffon #59	07

JAWA - SEE CZ/JAWA

JCB UTILITY VEHICLES

Groundhog 800D (4x4)	08-09
Groundhog 1000D (4x4)	08-09
Groundhog 1000D (6x4)	08-09
Workmax 800D (4x4)	10-14
Workmax 1000D (4x4)	10-14
Workmax 1000D (6x4)	10-14
JH 125 B Roadstar	98
JE 125 E Dragon	98

JCM

240 Europa	89
------------	----

	DISC PAD CHOICES - FRONT				BRAKE DISC CHOICES - FRONT						Line #
	FA, SFA, TT Pad or Brake Shoe	SFAC Carbon Scooter Pads	Speciality Pads - SXR / Vee / MXS	Sintered/HH Pads/ Grooved Shoes	Left / Gauche / Links Standard Replacement Disc	Right / Droite / Rechts Standard Replacement Disc	Contour Disc Universal left and right fitment	Universal Custom Disc	Vee-Discs Black † See note below	CX Extreme MX Race Disc/ UTVX Disc	
	FA086/2*			FA086/2HH*	MD690	MD690	MD690C*				1
				FA296HH*	MD690	MD690	MD690C*				2
				FA296HH*	MD690	MD690	MD690C*				3
	FA086/2*			FA086/2HH*	MD690	MD690	MD690C*				4
				FA296HH*	MD690	MD690	MD690C*				5
				FA296HH*	MD690	MD690	MD690C*				6
	FA086*			FA086HH*	TBA	TBA					7
	FA086*			FA086HH*	MD690	MD690	MD690C*				8
	FA086*			FA086HH*	TBA	TBA					9
	FA086/2*			FA086/2HH*	MD691	MD691					10
	FA086/2*			FA086/2HH*	MD691	MD691					11
	FA086/2*			FA086/2HH*	MD691						12
				FA296HH	MD691						13
				FA296HH	MD691						14
											15
											16
	SFA115	SFAC115		SFA115HH	MD941D				VR941		17
	SFA115	SFAC115		SFA115HH	MD941D				VR941		18
	SFA115	SFAC115		SFA115HH	MD941D				VR941		19
	SFA197	SFAC197		SFA197HH		N/A					20
	SFA350	SFAC350		SFA350HH	TBA						21
	FA448				N/A						22
	SFA235	SFAC235			N/A						23
	H350										24
	SFA115	SFAC115		SFA115HH	MD951D						25
	965										26
	SFA115	SFAC115		SFA115HH	MD941D				VR941		27
	SFA115	SFAC115		SFA115HH	MD941D				VR941		28
	SFA115	SFAC115		SFA115HH	MD941D				VR941		29
	SFA086	SFAC086		SFA086HH			N/A				30
	SFA323	SFAC323		SFA323HH	TBA						31
	SFA350	SFAC350		SFA350HH	TBA						32
	SFA199	SFAC199		SFA199HH		MD999D					33
	SFA101	SFAC101		SFA101HH		MD9114D					34
	SFA350	SFAC350		SFA350HH		MD9114D					35
	FA448				N/A						36
	FA448				N/A						37
	SFA115	SFAC115		SFA115HH	MD951D						38
	SFA323	SFAC323		SFA323HH	N/A						39
	SFA115	SFAC115		SFA115HH	MD941D				VR941		40
	SFA199	SFAC199		SFA199HH		MD999D					41
	SFA142*	SFAC142*		SFA142HH*	N/A	N/A					42
	FA086*			FA086HH*	N/A	N/A					43
	FA086*			FA086HH*	N/A	N/A					44
	TBA*				TBA	TBA					45
											46
											47
											48
											49
	N/A*			FA609R*	N/A	N/A					50
	N/A*			FA609R*	N/A	N/A					51
	N/A*			FA609R*	N/A	N/A					52
	N/A*			FA609R*	N/A	N/A					53
	N/A*			FA609R*	N/A	N/A					54
	N/A*			FA609R*	N/A	N/A					55
	FA054TT					TBA					56
	FA086			FA086HH		TBA					57
											58
											59
	FA115			FA115R	N/A						60

*-2 Sets Required. † For Vee disc colours add RED, BLU, GRN, GLD, ORG suffix to part number.

⊗ - Also available as a Vintage Motorcycle Disc.

Non-JAPANESE Built Motorcycles

Line #	BRAKE DISC CHOICES - FRONT						DISC PAD CHOICES - REAR				BRAKE DISC CHOICES - REAR			
	OverSize 250 /280mm Disc Kit	OSX OverSize 250/280mm Disc Kit	Relocating Bracket for 250/ 280mm Disc	OverSize 320mm Disc Kit	SMX OverSize 320mm Disc Kit	Relocating Bracket for 320mm Disc	FA, SFA, TT Pad or Brake Shoe	SFAC Carbon Scooter Pads	Speciality Pads - SXR / Vee / MXS	Sintered/ HH Pads/ Grooved Shoes	Standard Replacement Disc	Contour Disc Rear fitment	Vee-Discs™ CONTOUR	CX Extreme MX Race Disc/ UTVX Disc
1							FA086/2			FA086/2HH	MD689	MD689C		
2							FA086/2			FA086/2HH	MD689	MD689C		
3							FA086/2			FA086/2HH	MD689	MD689C		
4							FA086/2			FA086/2HH	MD689	MD689C		
5							FA086/2			FA086/2HH	MD689	MD689C		
6							FA298			SFA298HH	MD689	MD689C		
7							FA086			FA086HH	MD689	MD689C		
8							FA086			FA086HH	MD689	MD689C		
9							FA319/2			FA319/2HH	N/A			
10							FA086/2			FA086/2HH	N/A			
11							FA086/2			FA086/2HH	N/A			
12							FA086/2			FA086/2HH	TBA			
13							FA086/2			FA086/2HH	N/A			
14							FA086/2			FA086/2HH	N/A			
15														
16														
17							SFA115	SFAC115		SFA115HH	MD948D			
18							SFA115	SFAC115		SFA115HH	MD950D			
19							S624							
20							TBA							
21							816							
22							FA448				N/A			
23							TBA							
24							S624							
25							S624							
26							965			965G				
27							816							
28							SFA115	SFAC115		SFA115HH	MD949D			
29							SFA115	SFAC115		SFA115HH	MD950D			
30							SFA260	SFAC260		SFA260HH		N/A		
31							SFA323	SFAC323		SFA323HH	TBA			
32							816							
33							SFA275	SFAC275		SFA275HH	MD953D			
34							Y527							
35							Y527							
36							FA448				N/A			
37							FA115				N/A			
38							816							
39							S624							
40							SFA115	SFAC115		SFA115HH	MD949D			
41							SFA374				MD953D			
42							SFA298	SFAC298		SFA298HH	N/A			
43							FA086			FA086HH	N/A			
44							FA086			FA086HH	N/A			
45							FA209/2		FA209/2V		TBA			
46														
47														
48														
49														
50							N/A*			FA609R*	N/A			
51							N/A*			FA609R*	N/A			
52							N/A*			FA609R*	N/A			
53							N/A*			FA609R*	N/A			
54							N/A*			FA609R*	N/A			
55							N/A*			FA609R*	N/A			
56							TBA							
57							TBA							
58														
59														
60							FA337TT			FA337R	N/A			

REAR / ARRIÈRE / HINTEN / POSTERIOR / POSTERIORE

*-2 Sets Required. † For Vee disc colours add RED, BLU, GRN, GLD, ORG suffix to part number.

⊗ - Also available as a Vintage Motorcycle Disc.

R Suffix = High Durability Sintered Pad. HH Suffix = High Performance Sintered Pad. TT Suffix = Hard Wearing Off Road Pad. V Suffix = Semi Sintered Pad. G Suffix = Grooved Shoe.

D Suffix = Drilled Disc. X Suffix = Universal Left or Right Disc. XC Suffix = Contoured Disc. LS Suffix = Left/Steel Disc. RS = Right/Steel Disc.

BRAKE APPLICATIONS

Non-JAPANESE Built Motorcycles



J.J.COBAS



DISC PAD CHOICES - FRONT

BRAKE DISC CHOICES - FRONT

		FA, SFA, TT Pad or Brake Shoe	SFAC Carbon Scooter Pads	Speciality Pads - SXR / Vee / MXS	Sintered/HH Pads/ Grooved Shoes	Left / Gauche / Links Standard Replacement Disc	Right / Droite / Rechts Standard Replacement Disc	Contour Disc Universal left and right fitment	Universal Custom Disc	Vee-Discs Black † See note below	CX Extreme MX Race Disc/ UTVX Disc	Line #
TR1		FA095			FA095HH	N/A						1
Trial		FA115			FA115R	N/A						2
JOHN DEERE (ATV & SIDE X SIDE MODELS)												
Trail Buck 500/650 EX/EXT	Left	FA307TT			FA307R	MD6245D	MD6245D					3
	Right	FA317TT			FA317R							4
Buck 500/650 EX/EXT	Left	FA307TT			FA307R	MD6245D	MD6245D					5
	Right	FA317TT			FA317R							6
TX Gator Utility 9461					FA398R*	N/A	N/A					7
TX Turf Gator 9462					FA398R*	N/A	N/A					8
4PX Gator 4x2/4x4 Trail 9345					FA398R*	N/A	N/A					9
HPX Gator 4x2/4x4 9446					FA398R*	N/A	N/A					10
HPX 4x2 (Petrol) Gator					FA398R*	N/A	N/A					11
HPX 4x4/4x4 Trail (Petrol) - Gator					FA398R*	N/A	N/A					12
HPX 4x4 (Diesel) - Gator - (SN040000)					FA398R*	N/A	N/A					13
HPX 4x4 (Diesel) - Gator - (SN040001 - 90000/SN090001 -)					FA609R*	N/A	N/A					14
XUV 620 i (Petrol) - Gator					FA609R*	N/A	N/A					15
XUV 625 i (Petrol) - Gator					FA610R*	N/A	N/A					16
XUV 825 i (Petrol) - Gator					FA610R*	N/A	N/A					17
XUV 850 D (Diesel) - Gator					FA609R*	N/A	N/A					18
XUV 855 D (Diesel) - Gator					FA610R*	N/A	N/A					19
JONWAY												
YY 50 QT-5 (2T) Neo		TBA										20
YY 50 QT-5 (4T) Neo		TBA										21
YY 50 QT-6 (2T) Agility		SFA086	SFAC086		SFA086HH	N/A						22
YY 50 QT-6 (4T) Agility		SFA086	SFAC086		SFA086HH	N/A						23
YY 50 QT-10 (2T) Viper		SFA086	SFAC086		SFA086HH	N/A						24
YY 50 QT-10 (4T) Viper		SFA086	SFAC086		SFA086HH	N/A						25
YY 50 QT-28 (2T) Raptor		SFA086	SFAC086		SFA086HH	N/A						26
YY 50 QT-28 (4T) Raptor		SFA086	SFAC086		SFA086HH	N/A						27
YY 80 QT-6 (4T) Agility		SFA086	SFAC086		SFA086HH	N/A						28
YY 125		FA165TT			FA165R	N/A						29
YY 150		FA165TT			FA165R	N/A						30
YY 150 T-19		SFA086	SFAC086		SFA086HH		N/A					31
YY 250/250 A		FA165TT			FA165R	N/A						32
YY 250 T-19		SFA086	SFAC086		SFA086HH		N/A					33
JORDAN												
Easy 50/100		SFA169	SFAC169		SFA169HH	MD904D				VR904		34
Hipo/Mars/Bob 50/90/100 Anti Vibrate Model		H338*			H338G							35
Hipo/Mars/Bob 50/90/100 Street Model		H338*			H338G							36
KAWATA												
Fever 50/90		SFA169	SFAC169		SFA169HH	TBA	TBA					37
Stinger 90		SFA169	SFAC169		SFA169HH	TBA	TBA					38
KAZUMA QUADS												
MF90 Falcon		FA416TT*			FA416R*	N/A	N/A					39
110 Falcon (Drum Brake Model)		TBA*			TBA*							40
KEEWAY												
Agora 50 (4T)		SFA086	SFAC086		SFA086HH		N/A					41
ARN 50 (25/45)		SFA047			SFA047HH	TBA						42
Easy/Hurricane 50 (25/45)		TBA				N/A						43
Focus 50		SFA235	SFAC235			TBA						44
F-Act 50		SFA235	SFAC235			TBA						45
F-Act 50 EVO DD (2T)		SFA235	SFAC235				N/A					46
F-Act 50 EVO City (2T)		SFA235	SFAC235				N/A					47
F-Act NKD 50		SFA235	SFAC235			TBA						48

FRONT / AVANT / VORN / FRENTE / ANTERIORE

R Suffix = High Durability Sintered Pad. HH Suffix = High Performance Sintered Pad. TT Suffix = Hard Wearing Off Road Pad. V Suffix = Semi Sintered Pad. G Suffix = Grooved Shoe.
D Suffix = Drilled Disc. X Suffix = Universal Left or Right Disc. XC Suffix = Contoured Disc. LS Suffix = Left/Steel Disc. RS = Right/Steel Disc.

*-2 Sets Required. † For Vee disc colours add RED, BLU, GRN, GLD, ORG suffix to part number.

⊗ - Also available as a Vintage Motorcycle Disc.

Non-JAPANESE Built Motorcycles

Line #	BRAKE DISC CHOICES - FRONT						DISC PAD CHOICES - REAR				BRAKE DISC CHOICES - REAR			
	Oversize 250 /280mm Disc Kit	OSX Oversize 250/280mm Disc Kit	Relocating Bracket for 250/ 280mm Disc	Oversize 320mm Disc Kit	SMX Oversize 320mm Disc Kit	Relocating Bracket for 320mm Disc	FA, SFA, TT Pad or Brake Shoe	SFAC Carbon Scooter Pads	Speciality Pads - SXR / Vee / MXS	Sintered/ HH Pads/ Grooved Shoes	Standard Replacement Disc	Contour Disc Rear fitment	Vee-Discs™ CONTOUR	CX Extreme MX Race Disc/ UTVX Disc
1							FA115			FA115R	N/A			
2							N/A							
3														
4														
5							FA317TT			FA317R	MD6225D			
6														
7							FA317TT			FA317R	MD6225D			
8														
9										FA398*	N/A*			
10										FA398*	N/A*			
11										FA398*	N/A*			
12										FA398*	N/A*			
13										FA398*	N/A*			
14										FA398*	N/A*			
15										FA398*	N/A*			
16										FA609*	N/A*			
17										FA609*	N/A*			
18										FA609*	N/A*			
19										FA609*	N/A*			
20										FA609*	N/A*			
21										FA609*	N/A*			
22														
23														
24							TBA							
25							TBA							
26							TBA							
27							TBA							
28							TBA							
29							TBA							
30							TBA							
31							TBA							
32							TBA							
33							FA165TT			FA165R	N/A			
34							FA165TT			FA165R	N/A			
35							SFA086	SFAC086		SFA086HH	N/A			
36							FA165TT			FA165R	N/A			
37							SFA086	SFAC086		SFA086HH	N/A			
38														
39														
40							Y503							
41							FA232TT			FA232R	N/A			
42							FA232TT			FA232R	N/A			
43														
44														
45							TBA							
46							TBA							
47														
48														
49							FA416TT			FA416R	N/A			
50							H330			H330G				
51														
52														
53							Y503							
54							Y503							
55							Y503							
56							Y503							
57							Y503							
58							SFA083	SFAC083			N/A			
59							Y503							
60							Y503							

REAR / ARRIÈRE / HINTEN / POSTERIOR / POSTERIORE

R Suffix = High Durability Sintered Pad. **HH** Suffix = High Performance Sintered Pad. **TT** Suffix = Hard Wearing Off Road Pad. **V** Suffix = Semi Sintered Pad. **G** Suffix = Grooved Shoe.
D Suffix = Drilled Disc. **X** Suffix = Universal Left or Right Disc. **XC** Suffix = Contoured Disc. **LS** Suffix = Left/Steel Disc. **RS** = Right/Steel Disc.

*-2 Sets Required. † For Vee disc colours add RED, BLU, GRN, GLD, ORG suffix to part number.
 Ⓢ - Also available as a Vintage Motorcycle Disc.

BRAKE APPLICATIONS

Non-JAPANESE Built Motorcycles



KEEWAY Contd.



DISC PAD CHOICES - FRONT

BRAKE DISC CHOICES - FRONT

R Suffix = High Durability Sintered Pad. **HH** Suffix = High Performance Sintered Pad. **TT** Suffix = Hard Wearing Off Road Pad. **V** Suffix = Semi Sintered Pad. **G** Suffix = Grooved Shoe.

D Suffix = Drilled Disc. **X** Suffix = Universal Left or Right Disc. **XC** Suffix = Contoured Disc. **LS** Suffix = Left/Steel Disc. **RS** = Right/Steel Disc.

FRONT / AVANT / VORN / FRENTE / ANTERIORE

		FA, SFA, TT Pad or Brake Shoe	SFAC Carbon Scooter Pads	Speciality Pads - SXR / Vee / MXS	Sintered/HH Pads/ Grooved Shoes	Left / Gauche / Links Standard Replacement Disc	Right / Droite / Rechts Standard Replacement Disc	Contour Disc Universal left and right filament	Universal Custom Disc	Vee-Discs Black † See note below	CX Extreme MX Race Disc/ UTVX Disc	Line #
F-Act 50 Racing (25/45)			SFA235	SFAC235		N/A						1
F-Act 50 RS			SFA235	SFAC235		N/A						2
Flash 50			SFA083	SFAC083	SFA083HH	TBA						3
Flash 50 Electric			SFA235	SFAC235		TBA						4
Goccia 50 (2T/4T)			SFA193	SFAC193	SFA193HH	N/A						5
Hacker 50			SFA047		SFA047HH	N/A						6
Hurricane 50			SFA083	SFAC083	SFA083HH	TBA						7
Hurricane 50 Base			SFA083	SFAC083	SFA083HH	TBA						8
Matrix 50 (2T)			SFA235	SFAC235		N/A						9
Matrix V4 50 (25/45)			SFA235	SFAC235		N/A						10
Pixel 50			SFA083	SFAC083	SFA083HH	N/A						11
RY6 50cc (25/45)			SFA235	SFAC235				N/A				12
RY8 50cc (All models)			SFA235	SFAC235		TBA						13
RY8 Racing 50cc (25/45)			SFA235	SFAC235				N/A				14
RY8 SP 50cc (25/45)			SFA235	SFAC235				N/A				15
Swan 50 (25/45)			SFA235	SFAC235		N/A						16
TX 50			FA194		FA194HH		N/A					17
X-Ray 50 Supermoto			FA194		FA194HH	N/A						18
50 Zahara (2T/4T)			SFA086	SFAC086	SFA086HH	N/A						19
110 Kee			SFA086	SFAC086	SFA086HH		N/A					20
Partner 110			SFA228	SFAC228	SFA228HH		N/A					21
110 Target			TBA				N/A					22
ARN 125			SFA047		SFA047HH	TBA						23
Cityblade 125			SFA228	SFAC228	SFA228HH			N/A				24
Cityblade 125 Euro 4			FA707		FA707V							25
F-Act 125			SFA235	SFAC235		N/A						26
Focus 125			SFA235	SFAC235		TBA						27
Hacker 125			SFA047		SFA047HH	N/A						28
Hacker 125			TBA			N/A						29
K2 125/150/250			SFA353	SFAC353	SFA353HH	TBA						30
125 Link			SFA086	SFAC086	SFA086HH	N/A						31
125 Logik			SFA228	SFAC228	SFA228HH	N/A						32
125 Logik			FA707		FA707V							33
Matrix 125			SFA083	SFAC083	SFA083HH	N/A						34
Matrix 125			SFA235	SFAC235		TBA						35
Outlook 125/150			SFA228	SFAC228	SFA228HH	N/A						36
RKS 125			FA086		FA086HH		N/A					37
RKS 125			FA197		FA197HH		N/A					38
RKV 125			FA658		FA658HH			N/A				39
RKV 125 Euro 4			FA707		FA707V							40
Silverblade 125/150/250			SFA181*	SFAC181*	SFA181HH*	TBA	TBA					41
Silverblade 125			SFA197	SFAC197	SFA197HH		N/A					42
125i Silverblade	Left		SFA228	SFAC228	SFA228HH	N/A	N/A					43
	Right		SFA197	SFAC197	SFA197HH							44
Speed 125/150			SFA093			N/A						45
125 New Strike			Y506									46
125 Strike			FA086		FA086HH	N/A						47
Superlight Ltd 125			FA228		FA228HH	TBA						48
Superlight 125 Euro 4			FA707		FA707V							49
125 Target			TBA				N/A					50
TX 125			FA194		FA194HH		N/A					51
TX 125 TXM			FA707		FA707V							52
TX 125 SM (17" F/Wheel)			FA194		FA194HH			N/A				53
125 Zahara (2T/4T)			SFA086	SFAC086	SFA086HH	N/A						54
ARN 150			SFA047		SFA047HH	N/A						55
Cityblade 150			SFA228	SFAC228	SFA228HH			N/A				56
F-Act 150			SFA235	SFAC235		N/A						57
Hacker 150			SFA047		SFA047HH	N/A						58
150 Link			SFA086	SFAC086	SFA086HH	N/A						59
150 Logik			SFA228	SFAC228	SFA228HH	N/A						60

*-2 Sets Required. † For Vee disc colours add RED, BLU, GRN, GLD, ORG suffix to part number.

⊗ - Also available as a Vintage Motorcycle Disc.

Non-JAPANESE Built Motorcycles

Line #	BRAKE DISC CHOICES - FRONT						DISC PAD CHOICES - REAR				BRAKE DISC CHOICES - REAR			
	Oversize 250 /280mm Disc Kit	OSX Oversize 250/280mm Disc Kit	Relocating Bracket for 250/ 280mm Disc	Oversize 320mm Disc Kit	SMX Oversize 320mm Disc Kit	Relocating Bracket for 320mm Disc	FA, SFA, TT Pad or Brake Shoe	SFAC Carbon Scooter Pads	Speciality Pads - SXR / Vee / MXS	Sintered/ HH Pads/ Grooved Shoes	Standard Replacement Disc	Contour Disc Rear fitment	Vee-Discs™ CONTOUR	CX Extreme MX Race Disc/ UTVX Disc
1							Y503							
2							Y503							
3							Y503							
4							Y503							
5							Y503							
6							Y503							
7							Y503							
8							Y503							
9							Y503							
10							Y503							
11							Y503							
12							Y503							
13							Y503							
14							TBA				N/A			
15							Y503							
16							Y503							
17							FA060			N/A				
18							FA060			N/A				
19							Y503							
20							Y506							
21							TBA							
22							Y506							
23							Y503							
24							SFA298	SFAC298		SFA298HH		N/A		
25							FA298							
26							Y503							
27							Y506							
28							TBA							
29							TBA			TBA				
30							SFA353	SFAC353		SFA353HH	TBA			
31							SFA086	SFAC086		SFA086HH	N/A			
32							SFA228	SFAC228		SFA228HH	N/A			
33							TBA							
34							Y506							
35							Y506							
36							SFA228	SFAC228		SFA228HH	N/A			
37							Y506							
38							Y506							
39							FA298				N/A			
40							FA197							
41							SFA266	SFAC266		SFA266HH	TBA			
42							SFA197	SFAC197		SFA197HH	N/A			
43							SFA197	SFAC197		SFA197HH	N/A			
44														
45							SFA093				N/A			
46							Y506							
47							Y506							
48							Y516							
49							SFA197	SFAC197		SFA197HH				
50							Y506							
51							FA060				N/A			
52							FA298							
53							FA298			SFA298HH		N/A		
54							Y503							
55							Y506							
56							SFA260	SFAC260		SFA260HH		N/A		
57							Y506							
58							TBA							
59							SFA086	SFAC086		SFA086HH	N/A			
60							SFA228	SFAC228		SFA228HH	N/A			

REAR / ARRIÈRE / HINTEN / POSTERIOR / POSTERIORE

R Suffix = High Durability Sintered Pad. **HH** Suffix = High Performance Sintered Pad. **TT** Suffix = Hard Wearing Off Road Pad. **V** Suffix = Semi Sintered Pad. **G** Suffix = Grooved Shoe.
D Suffix = Drilled Disc. **X** Suffix = Universal Left or Right Disc. **XC** Suffix = Contoured Disc. **LS** Suffix = Left/Steel Disc. **RS** = Right/Steel Disc.

*-2 Sets Required. † For Vee disc colours add RED, BLU, GRN, GLD, ORG suffix to part number.
 Ⓢ - Also available as a Vintage Motorcycle Disc.

BRAKE APPLICATIONS

Non-JAPANESE Built Motorcycles



KEEWAY Contd.



DISC PAD CHOICES - FRONT

BRAKE DISC CHOICES - FRONT

R Suffix = High Durability Sintered Pad. **HH** Suffix = High Performance Sintered Pad. **TT** Suffix = Hard Wearing Off Road Pad. **V** Suffix = Semi Sintered Pad. **G** Suffix = Grooved Shoe.

D Suffix = Drilled Disc. **X** Suffix = Universal Left or Right Disc. **XC** Suffix = Contoured Disc. **LS** Suffix = Left/Steel Disc. **RS** = Right/Steel Disc.

		FA, SFA, TT Pad or Brake Shoe	SFAC Carbon Scooter Pads	Speciality Pads - SXR / Vee / MXS	Sintered/HH Pads/ Grooved Shoes	Left / Gauche / Links Standard Replacement Disc	Right / Droite / Rechts Standard Replacement Disc	Contour Disc Universal left and right filament	Universal Custom Disc	Vee-Discs Black † See note below	CX Extreme MX Race Disc/ UTVX Disc	Line #
Matrix 150	07-10	SFA235	SFAC235			N/A						1
RKS 150	12-14	FA197			FA197HH		N/A					2
RKX 150	13-14	FA658		FA658V	FA658HH			N/A				3
RKV 150	13-15	FA658		FA658V	FA658HH			N/A				4
Superlight 150	07-12	FA228			FA228HH	TBA						5
150 New Strike	13-14	Y506										6
150 Strike	13-14	FA086			FA086HH	N/A						7
KXM 200	14	FA181TT			FA181R							8
KXV 200	14	FA181TT			FA181R							9
200 Link	13-14	SFA086	SFAC086		SFA086HH	N/A						10
RKS 200	12-14	FA197			FA197HH		N/A					11
RKX 200	13-14	FA658		FA658V	FA658HH			N/A				12
RKV 200S	14	FA658		FA658V	FA658HH			N/A				13
RKV 200S Factory	14	FA658		FA658V	FA658HH			N/A				14
200 New Strike	13-14	Y506										15
TX 200 (19" F/Wheel)	13-14	FA194			FA194HH			N/A				16
250i Blackster	14-15	FA228			FA228HH	N/A						17
Cruiser 250i	09-14	FA228			FA228HH	TBA						18
Dragon 250 Quad	07-09	FA083TT*			FA083R*	N/A	N/A					19
250i Silverblade	Left 13-15	SFA228	SFAC228		SFA228HH	N/A	N/A					20
	Right 13-15	SFA197	SFAC197		SFA197HH							21
GTX 300 Quad	10-11	FA483TT*			FA483R*	N/A	N/A					22
350i Index	13-15	SFA228	SFAC228		SFA228HH	N/A						23
												24
												25
KIOTI/MECHRON (Side x Side)												26
2200 UTV (Side x Side)	09-14	FA622TT*			FA622R*	TBA	TBA					27
2200 UTV (Side x Side) - Parking brake	09-14	FA659TT										28
2200 PS UTV (Side x Side)	14-15	FA622TT*			FA622R*	TBA	TBA					29
2200 PS UTV (Side x Side) - Parking brake	14-15	FA659TT										30
2210 UTV (Side x Side)	11-14	FA622TT*			FA622R*	TBA	TBA					31
2210 UTV (Side x Side) - Parking brake	11-14	FA659TT										32
2240 UTV (Side x Side)	14-15	FA622TT*			FA622R*	TBA	TBA					33
2240 UTV (Side x Side) - Parking brake	14-15	FA659TT										34
												35
K.M. (Keemotorbikes)												36
Badboy 50 CX	05	SFA235	SFAC235			N/A						37
Badboy 100 CX	05	SFA235	SFAC235			N/A						38
												39
												40
KRAM-IT (KRAMER)												41
EP 250/EC 250												42
GS 250	00-	FA181TT		MXS181	FA181R	N/A						43
MC 250/MC 250 LC												44
SM 250	00-	FA181TT		MXS181	FA181R	N/A						45
SMR 250	00-	TBA										46
EC 450/MC 450												47
MC 500												48
ER 125/250/300 RV3	88-	FA134			FA134R	N/A						49
ER 500/600	96-	FA134			FA134R	N/A						50
												51
KREIDLER												52
e-Florett 3.00 (4.0KW)	14-15	SFA086	SFAC086		SFA086HH	N/A						53
e-Florett 1.00 (3.0KW)	14-15	SFA086	SFAC086		SFA086HH	N/A						54
Florett City (50cc/2T/A-C)	14-15	SFA235	SFAC235			MD943D		MD943C		VR943		55
Florett 2.1 RS (50cc/2T/A-C)	14-15	SFA235	SFAC235			MD943D		MD943C		VR943		56
Galactica 3.0 LC (50cc/2T/L-C)	14-15	SFA086	SFAC086		SFA086HH			N/A				57
Galactica 3.0 RS (50cc/2T/A-C)	14-15	SFA086	SFAC086		SFA086HH			N/A				58
50 MF2		H322										59
50 MF4 Early Models		908										60
50 MF4 Later Models		H322										61
50 Flory MF 40147		932										62

*-2 Sets Required. † For Vee disc colours add RED, BLU, GRN, GLD, ORG suffix to part number.

⊗ - Also available as a Vintage Motorcycle Disc.

Non-JAPANESE Built Motorcycles

Line #	BRAKE DISC CHOICES - FRONT						DISC PAD CHOICES - REAR				BRAKE DISC CHOICES - REAR			
	Oversize 250 /280mm Disc Kit	OSX Oversize 250/280mm Disc Kit	Relocating Bracket for 250/ 280mm Disc	Oversize 320mm Disc Kit	SMX Oversize 320mm Disc Kit	Relocating Bracket for 320mm Disc	FA, SFA, TT Pad or Brake Shoe	SFAC Carbon Scooter Pads	Speciality Pads - SXR / Vee / MXS	Sintered/ HH Pads/ Grooved Shoes	Standard Replacement Disc	Contour Disc Rear fitment	Vee-Discs™ CONTOUR	CX Extreme MX Race Disc/ UTVX Disc
1							Y506							
2							Y506							
3							FA298					N/A		
4							FA298					N/A		
5							Y516							
6							Y506							
7							Y506							
8							FA298			SFA298HH		N/A		
9							FA298			SFA298HH		N/A		
10							FA086			FA086HH	N/A			
11							Y506							
12							FA298					N/A		
13							FA298					N/A		
14							FA298					N/A		
15							Y506							
16							FA298			SFA298HH		N/A		
17							FA197			FA197HH	N/A			
18							TBA							
19							FA054TT			FA054R	N/A			
20							SFA197	SFAC197		SFA197HH	N/A			
21														
22							FA482TT			FA482R	N/A			
23							SFA083	SFAC083		SFA083HH		N/A		
24														
25														
26							FA622TT*			FA622R*	TBA*			
27														
28							FA622TT*			FA622R*	TBA*			
29														
30							FA622TT*			FA622R*	TBA*			
31														
32							FA622TT*			FA622R*	TBA*			
33														
34														
35														
36							H303							
37							H303							
38														
39														
40														
41							FA208TT		MXS208	843G FA208R	N/A			
42										843G				
43							FA208TT		MXS208	FA208R	N/A			
44							FA208TT			FA208R	N/A			
45										843G				
46										843G				
47							FA067/3			FA067R	N/A			
48							FA067/3			FA067R	N/A			
49														
50														
51							SFA083	SFAC083		SFA083HH	N/A			
52							SFA083	SFAC083		SFA083HH	N/A			
53							Y503							
54							Y503							
55							SFA260	SFAC260		SFA260HH		N/A		
56							SFA260	SFAC260		SFA260HH		N/A		
57							H322							
58							908							
59							H322							
60							932							

REAR / ARRIÈRE / HINTEN / POSTERIOR / POSTERIORE

R Suffix = High Durability Sintered Pad. **HH** Suffix = High Performance Sintered Pad. **TT** Suffix = Hard Wearing Off Road Pad. **V** Suffix = Semi Sintered Pad. **G** Suffix = Grooved Shoe.
D Suffix = Drilled Disc. **X** Suffix = Universal Left or Right Disc. **XC** Suffix = Contoured Disc. **LS** Suffix = Left/Steel Disc. **RS** = Right/Steel Disc.

*-2 Sets Required. † For Vee disc colours add RED, BLU, GRN, GLD, ORG suffix to part number.
 Ⓢ - Also available as a Vintage Motorcycle Disc.

Part numbers, prefixes, suffixes, photos and illustrations shown in this catalogue are trademarks and/or copyrights of EBC Brakes or the trademark owner A C Freeman Investments Ltd and use without express written permission of the owners is punishable by law.

Non-JAPANESE Built Motorcycles



KREIDLER Contd.



DISC PAD CHOICES - FRONT

BRAKE DISC CHOICES - FRONT

FA, SFA, TT Pad or Brake Shoe	SFAC Carbon Scooter Pads	Speciality Pads - SXR / Vee / MXS	Sintered/HH Pads/ Grooved Shoes	Left / Gauche / Links Standard Replacement Disc	Right / Droite / Rechts Standard Replacement Disc	Contour Disc Universal left and right fitment	Universal Custom Disc	Vee-Discs Black † See note below	CX Extreme MX Race Disc/ UTVX Disc
50 Flory MF 20/22									
50 Flory MF 23/24/25									
50 Flory Classic (50cc/4T/A-C)	14-15	SFA086	SFAC086	SFA086HH	N/A				
50 MP1 Early Models		908							
50 MP1 Later Models		H322							
50 RM		966							
50 LH/LF/LFF		932							
50 RMC/RMC-BG		932							
50 Supermoto (2T)	14-15	FA228		FA228HH		N/A			
50 RS-G/RSH-G and GS		FA056				N/A			
80E/L Florett		FA056				N/A			
Mustang 125		FA076		FA076HH	N/A				
125		N/A							
125 RS		FA056			N/A				
125 Enduro (4T)	14-15	FA228		FA228HH		N/A			
125 Insignio (4T)	Left 14-15	SFA197	SFAC197	SFA197HH	N/A	N/A			
	Right 14-15	SFA228	SFAC228	SFA228HH					
125 Supermoto (4T)	14-15	FA228		FA228HH		N/A			
250 Insignio (4T)	Left 14-15	SFA197	SFAC197	SFA197HH	N/A	N/A			
	Right 14-15	SFA228	SFAC228	SFA228HH					
KSR (SEE GENERIC SECTION)									
KTM									
SX-E 5 Electric	20-22	FA325TT		FA325R					
Freeride E-SM (Electric Powered)	15-17	FA612TT		FA612R		TBA			
Freeride E-SX (Electric Powered)	14-17	FA612TT		FA612R		TBA			
Freeride E-XC (Electric Powered)	15-20	FA612TT		FA612R		TBA			
50 Supermoto	06	FA325TT		FA325R	N/A				
50 SX Mini (10" Wheels)	08-22	FA325TT		FA325R					
50 SX/SXR Pro Junior/Senior/Adventure	96-03	H322							
50 SX Mini Adventure	04-07	H322							
50 SX Pro Senior LC	02-03	FA325TT		FA325R	N/A				
50 SX Senior Adventure	02-07	FA325TT		FA325R	N/A				
50 SX Pro Senior LC (12" Front Wheel)	04-22	FA325TT		FA325R	N/A				
50 SX	06-20	FA325TT		FA325R					
60 SX	98-99	FA115TT		FA115R	MD6192D	MD6192C			
60 SX	00	FA115TT		FA115R	MD6192D	MD6192C			
65 SX	98-99	FA115TT		FA115R	MD6192D	MD6192C			
65 SX	00-01	FA115TT		FA115R	MD6192D	MD6192C			
65 SX	02-03	FA357TT		FA357R	MD6192D	MD6192C			
65 SX	04-08	FA357TT		FA357R	MD6243D	MD6243C			MD6243CX
65 SX	09-22	FA357TT		FA357R		MD6243C			MD6243CX
80 MX	86-92	FA047/2			N/A				
SX 85 (17"/14" wheels)	03-10	FA357TT		FA357R		MD6258C			
SX 85 (19"/16" wheels)	03-10	FA357TT		FA357R		MD6258C			
SX 85 (17"/14" wheels)	11	FA357TT		FA357R		MD6258C			
SX 85 (19"/16" wheels)	11	FA357TT		FA357R		MD6258C			
SX 85 (17"/14" wheels - 220mm F/Disc/Radial Caliper)	12-15	FA612TT		FA612R		MD6407C			
SX 85 (19"/16" wheels - 220mm F/Disc/Radial Caliper)	12	FA612TT		FA612R		MD6407C			
SX 85 (17"/14" wheels - 240mm F/Disc/Radial Caliper)	16-20	FA612TT		FA612R		MD6379C			
SX 85 (17"/14" wheels - 240mm F/Disc/Radial Caliper)	21-22	FA181TT	MXS181	FA181R		MD6379C			
SX 85 (19"/16" wheels - 240mm F/Disc/Radial Caliper)	13-20	FA612TT		FA612R		MD6379C			
SX 85 (19"/16" wheels - 240mm F/Disc/Radial Caliper)	21-22	FA181TT	MXS181	FA181R		MD6379C			
SX 85 (220mm Oversize Rear disc only & Rear pads for aftermarket kit)	03-17								
125/175	-84			812G					
125 GS	83			811G					
125 Duke (280mm F/Disc)	11-12	FA606		FA606HH	MD849				
125 Duke (300mm F/Disc)	13-20	FA606		FA606HH	MD864	MD864XC			

FRONT / AVANT / VORN / FRENTE / ANTERIORE

Line #
1
2
3
4
5
6
7
8
9
10
11
12
13
14
15
16
17
18
19
20
21
22
23
24
25
26
27
28
29
30
31
32
33
34
35
36
37
38
39
40
41
42
43
44
45
46
47
48
49
50
51
52
53
54
55
56
57
58
59
60

R Suffix = High Durability Sintered Pad. HH Suffix = High Performance Sintered Pad. TT Suffix = Hard Wearing Off Road Pad. V Suffix = Semi Sintered Pad. G Suffix = Grooved Shoe.
D Suffix = Drilled Disc. X Suffix = Universal Left or Right Disc. XC Suffix = Contoured Disc. LS Suffix = Left/Steel Disc. RS = Right/Steel Disc.

*-2 Sets Required. † For Vee disc colours add RED, BLU, GRN, GLD, ORG suffix to part number.

⊗ - Also available as a Vintage Motorcycle Disc.

Non-JAPANESE Built Motorcycles

Line #	BRAKE DISC CHOICES - FRONT						DISC PAD CHOICES - REAR				BRAKE DISC CHOICES - REAR			
	Oversize 250 /280mm Disc Kit	OSX Oversize 250/280mm Disc Kit	Relocating Bracket for 250/ 280mm Disc	Oversize 320mm Disc Kit	SMX Oversize 320mm Disc Kit	Relocating Bracket for 320mm Disc	FA, SFA, TT Pad or Brake Shoe	SFAC Carbon Scooter Pads	Speciality Pads - SXR / Vee / MXS	Sintered/ HH Pads/ Grooved Shoes	Standard Replacement Disc	Contour Disc Rear fitment	Vee-Discs™ CONTOUR	CX Extreme MX Race Disc/ UTVX Disc
1							H322							
2							932							
3							Y503							
4							908							
5							H322							
6							966							
7							932							
8							932							
9							FA197			FA197HH		N/A		
10							TBA							
11							966							
12							932							
13							932							
14							932							
15							FA054TT			FA054HH		N/A		
16							TBA				N/A			
17														
18							FA054TT			FA054HH		N/A		
19							TBA				N/A			
20														
21														
22														
23														
24														
25							FA325TT			FA325R				
26							FA602TT			FA602R		TBA		
27							FA602TT			FA602R		TBA		
28							FA602TT			FA602R		TBA		
29							FA325TT			FA325R	N/A			
30							FA325TT			FA325R				
31							H322							
32							H322							
33							H322							
34							H322							
35							FA325TT			FA325R	N/A			
36							FA325TT			FA325R				
37														
38							FA337TT			FA337R	MD6216D			
39							873							
40							FA337TT			FA337R	MD6216D			
41							FA337TT			FA337R	MD6216D			
42							FA325TT			FA325R		MD6249C	MD6249CX	
43							FA357TT			FA357R		MD6249C	MD6249CX	
44							814G							
45		OSX6258	BRK028ORG			N/A	FA357TT			FA357R		MD6257C		
46		OSX6258	BRK028ORG			N/A	FA357TT			FA357R		MD6257C		
47		OSX6258	BRK028ORG			N/A	FA602TT			FA602R		MD6360C		
48		OSX6258	BRK028ORG			N/A	FA602TT			FA602R		MD6360C		
49		OSX6407	BRK027			N/A	FA602TT			FA602R		MD6360C		
50		OSX6407	BRK027			N/A	FA602TT			FA602R		MD6360C		
51			N/A			N/A	FA602TT			FA602R		MD6360C		
52			N/A			N/A	FA368TT	MXS368		FA368R		MD6407C		
53			N/A			N/A	FA602TT			FA602R		MD6360C		
54			N/A			N/A	FA368TT	MXS368		FA368R		MD6407C		
55														
56							FA367/2TT			FA367/2R		MD6360COS		
57										812G				
58										812G				
59							FA213	FA213V		FA213HH	MD850			
60							FA213			FA213HH	MD850			

REAR / ARRIÈRE / HINTEN / POSTERIOR / POSTERIORE

R Suffix = High Durability Sintered Pad. HH Suffix = High Performance Sintered Pad. TT Suffix = Hard Wearing Off Road Pad. V Suffix = Semi Sintered Pad. G Suffix = Grooved Shoe.
D Suffix = Drilled Disc. X Suffix = Universal Left or Right Disc. XC Suffix = Contoured Disc. LS Suffix = Left/Steel Disc. RS = Right/Steel Disc.

*-2 Sets Required. † For Vee disc colours add RED, BLU, GRN, GLD, ORG suffix to part number.
⊗ - Also available as a Vintage Motorcycle Disc.

Part numbers, prefixes, suffixes, photos and illustrations shown in this catalogue are trademarks and/or copyrights of EBC Brakes or the trademark owner A C Freeman Investments Ltd and use without express written permission of the owners is punishable by law.

Non-JAPANESE Built Motorcycles



KTM Contd.



DISC PAD CHOICES - FRONT

BRAKE DISC CHOICES - FRONT

FA, SFA, TT Pad or Brake Shoe	SFAC Carbon Scooter Pads	Speciality Pads - SXR / Vee / MXS	Sintered/HH Pads/ Grooved Shoes	Left / Gauche / Links Standard Replacement Disc	Right / Droite / Rechts Standard Replacement Disc	Contour Disc Universal left and right fitment	Universal Custom Disc	Vee-Disks Black † See note below	CX Extreme MX Race Disc/ UTVX Disc
125 Duke (300mm F/Disc)	17-21	FA606	FA606HH	MD8009					
D-XC/E-XC/E-GS 125	90-91	FA067TT	FA067R	MD6034D					
D-XC/E-XC/E-GS 125 Grimeca Calipers	90-91	FA132	FA132R	MD6034D					
D-XC/E-XC/E-GS 125 Brembo Calipers	92-93	FA181TT	FA181R	MD6034D					
D-XC/E-XC/E-GS 125 Grimeca Calipers	92-93	FA132	FA132R	MD6034D					
EXC 125	87	FA126TT	FA126R	N/A					
EXC 125	88	FA132	FA132R	N/A					
EXC 125 Brembo Calipers	89	FA067TT	FA067R	MD6034D					
EXC 125 Grimeca Calipers	89	FA132	FA132R	MD6034D					
EXC/EGS 125 (Standard forks)	94	FA181TT	MXS181 FA181R	MD6032D		MD6032C			MD6032CX
EXC 125 (Standard forks)	95-99	FA181TT	MXS181 FA181R	MD6032D		MD6032C			MD6032CX
EXC 125 (Upside down forks)	00-03	FA181TT	MXS181 FA181R	MD6032D		MD6032C			MD6032CX
EXC 125 (Upside down forks)	04-08	FA181TT	MXS181 FA181R	MD6032D		MD6032C			MD6032CX
EXC 125 (Upside down forks)	09-17	FA181TT	MXS181 FA181R	MD6032D		MD6032C			MD6032CX
EXC 125 Six Days (Upside down forks)	11-17	FA181TT	MXS181 FA181R	MD6032D		MD6032C			MD6032CX
EXE 125	00	FA181TT	MXS181 FA181R	MD6032D		MD6032C			MD6032CX
GSXC/GS 125	85	FA047TT	FA047R	N/A					
LC2 125	96-98	FA181TT	MXS181 FA181R	MD6032D		MD6032C			MD6032CX
Sting 125	97-99	FA095	FA095HH	N/A					
MX 125	83		811G						
MX 125	84		814G						
MX/MXC 125	85	FA047TT	FA047R	N/A					
MX/MXC/GS 125	86	FA047TT	FA047R	N/A					
MX 125	87	FA126TT	FA126R	N/A					
MX 125	88	FA132	FA132R						
MX 125 Brembo Calipers	89	FA067TT	FA067R	N/A					
MX 125 Grimeca Calipers	89	FA132	FA132R	N/A					
MX 125 Brembo Calipers	90-91	FA067TT	FA067R	N/A					
MX 125 Grimeca Calipers	90-91	FA132	FA132R	N/A					
MX 125 Brembo Calipers	92-93	FA181TT	MXS181 FA181R	MD6032D		MD6032C			MD6032CX
MX 125 Grimeca Calipers	92-93	FA132	FA132R	MD6032D		MD6032C			MD6032CX
RC 125	14-19	FA606	FA606HH	MD864		MD864XC			
RC125 (F/disc has larger I/D)	17-21	FA606	FA606HH	MD8009					
SM 125 Supermoto	00	FA181TT	MXS181 FA181R	TBA					
SX 125 (Standard forks)	94-99	FA181TT	MXS181 FA181R	MD6032D		MD6032C			MD6032CX
SX 125 (Upside down forks)	00-03	FA181TT	MXS181 FA181R	MD6032D		MD6032C			MD6032CX
SX 125 (Upside down forks)	04-08	FA181TT	MXS181 FA181R	MD6032D		MD6032C			MD6032CX
SX 125 (Upside down forks)	09-22	FA181TT	MXS181 FA181R	MD6032D		MD6032C			MD6032CX
XC-W 125 (2T)	17-19	FA181TT	MXS181 FA181R	MD6032D		MD6032C			MD6032CX
150 EXC Tpi	21-22	FA181TT	MXS181 FA181R	MD6032D		MD6032C			MD6032CX
SX 150 (Upside Down Forks)	08	FA181TT	MXS181 FA181R	MD6032D		MD6032C			MD6032CX
SX 150 (Upside Down Forks)	09-22	FA181TT	MXS181 FA181R	MD6032D		MD6032C			MD6032CX
XC 150 (Upside Down Forks)	11-13	FA181TT	MXS181 FA181R	MD6032D		MD6032C			MD6032CX
XC-W 150 (2T) inc Tpi	17-21	FA181TT	MXS181 FA181R	MD6032D		MD6032C			MD6032CX
200 Duke (280mm F/Disc)	12	FA606	FA606HH	MD849					
200 Duke (300mm F/Disc)	13-15	FA606	FA606HH	MD864		MD864XC			
200 Duke (300mm F/Disc)	17-21	FA606	FA606HH	MD8009					
EXC/EGS 200 (Standard forks)	98-99	FA181TT	MXS181 FA181R	MD6032D		MD6032C			MD6032CX
EXC/EGS 200 (Upside down forks)	00-03	FA181TT	MXS181 FA181R	MD6032D		MD6032C			MD6032CX
EXC 200 (Upside down forks)	04-08	FA181TT	MXS181 FA181R	MD6032D		MD6032C			MD6032CX
EXC 200 (Upside down forks/Inc Six Days)	09-16	FA181TT	MXS181 FA181R	MD6032D		MD6032C			MD6032CX
RC 200	14-15	FA606	FA606HH	MD864		MD864XC			
250	-82		812G						
250 Adventure	20	FA606	FA606HH						
250 Duke	15-20	FA606	FA606HH	MD864		MD864XC			
250 MX Leleu	82		811G						
250 XC/GS	83		811G						
DXC/EXC 250 Grimeca Calipers	90	FA132	FA132R	MD6034D					
D-XC/E-XC/E-GS 250 Brembo Calipers	91	FA067TT	FA067R	MD6034D					

FRONT / AVANT / VORN / FRENTE / ANTERIORE

Line #
1
2
3
4
5
6
7
8
9
10
11
12
13
14
15
16
17
18
19
20
21
22
23
24
25
26
27
28
29
30
31
32
33
34
35
36
37
38
39
40
41
42
43
44
45
46
47
48
49
50
51
52
53
54
55
56
57
58
59
60

R Suffix = High Durability Sintered Pad. HH Suffix = High Performance Sintered Pad. TT Suffix = Hard Wearing Off Road Pad. V Suffix = Semi Sintered Pad. G Suffix = Grooved Shoe.
D Suffix = Drilled Disc. X Suffix = Universal Left or Right Disc. XC Suffix = Contoured Disc. LS Suffix = Left/Steel Disc. RS = Right/Steel Disc.

NOTE: Most KTM models changed the caliper bracket design in 2009. O/E BRACKET REF 770 13 14 0 type is used in the OS/SM6932C type disc.
* -2 Sets Required. † For Vee disc colours add RED, BLU, GRN, GLD, ORG suffix to part number.
⊗ - Also available as a Vintage Motorcycle Disc.

Non-JAPANESE Built Motorcycles

Line #	BRAKE DISC CHOICES - FRONT						DISC PAD CHOICES - REAR				BRAKE DISC CHOICES - REAR			
	Oversize 250 /280mm Disc Kit	OSX Oversize 250/280mm Disc Kit	Relocating Bracket for 250/ 280mm Disc	Oversize 320mm Disc Kit	SMX Oversize 320mm Disc Kit	Relocating Bracket for 320mm Disc	FA, SFA, TT Pad or Brake Shoe	SFAC Carbon Scooter Pads	Speciality Pads - SXR / Vee / MXS	Sintered/ HH Pads/ Grooved Shoes	Standard Replacement Disc	Contour Disc Rear fitment	Vee-Discs™ CONTOUR	CX Extreme MX Race Disc/ UTVX Disc
1							FA213			FA213HH	MD850			
2							FA067TT			FA067R	N/A			
3							FA132			FA132R	N/A			
4							FA067TT			FA067R	N/A			
5							FA067TT			FA067R	N/A			
6							FA126TT			FA126R	N/A			
7							FA132			FA132R	MD6227D			
8							FA067TT			FA067R	MD6227D			
9							FA132			FA132R	MD6227D			
10		OSX6032EORG	BRK015ORG		SMX6032EORG	BRK016ORG	FA208TT	MXS208	FA208R	MD6035D	MD6035C		MD6035CX	
11		OSX6032EORG	BRK015ORG		SMX6032EORG	BRK016ORG	FA208TT	MXS208	FA208R	MD6035D	MD6035C		MD6035CX	
12		OSX6032ORG	BRK011ORG		SMX6032ORG	BRK012ORG	FA208TT	MXS208	FA208R	MD6035D	MD6035C		MD6035CX	
13		OSX6032ORG	BRK011ORG		SMX6032ORG	BRK012ORG	FA368TT	MXS368	FA368R	MD6035D	MD6035C		MD6035CX	
14		OSX6932ORG	BRK013ORG		SMX6932ORG	BRK014ORG	FA368TT	MXS368	FA368R	MD6035D	MD6035C		MD6035CX	
15		OSX6932ORG	BRK013ORG		SMX6932ORG	BRK014ORG	FA368TT	MXS368	FA368R	MD6035D	MD6035C		MD6035CX	
16		OSX6032ORG	BRK011ORG		SMX6032ORG	BRK012ORG	FA208TT	MXS208	FA208R	MD6035D	MD6035C		MD6035CX	
17									814G					
18							FA208TT	MXS208	FA208R	MD6035D	MD6035C			
19							FA208TT		FA208R	N/A				
20									812G					
21									814G					
22									814G					
23							FA047TT		FA047R	MD6227D				
24							FA126TT		FA126R	N/A				
25							FA132		FA132R	MD6227D				
26							FA067TT		FA067R	MD6227D				
27							FA132		FA132R	MD6227D				
28							FA067TT		FA067R	N/A				
29							FA132		FA132R	N/A				
30		OSX6032EORG	BRK015ORG		SMX6032EORG	BRK016ORG	FA067TT		FA067R	N/A				
31			N/A			N/A	FA067TT		FA067R	N/A				
32							FA213	FA213V	FA213HH	MD850				
33							FA213		FA213HH	MD850				
34							FA208TT	MXS208	FA208R	MD6035D	MD6035C			
35		OSX6032ORG	BRK011ORG		SMX6032ORG	BRK012ORG	FA208TT	MXS208	FA208R	MD6035D	MD6035C		MD6035CX	
36		OSX6032EORG	BRK015ORG		SMX6032EORG	BRK016ORG	FA208TT	MXS208	FA208R	MD6035D	MD6035C		MD6035CX	
37		OSX6032ORG	BRK011ORG		SMX6032ORG	BRK012ORG	FA368TT	MXS368	FA368R	MD6035D	MD6035C		MD6035CX	
38		OSX6932ORG	BRK013ORG		SMX6932ORG	BRK014ORG	FA368TT	MXS368	FA368R	MD6035D	MD6035C		MD6035CX	
39		OSX6932ORG	BRK013ORG		SMX6932ORG	BRK014ORG	FA368TT	MXS368	FA368R	MD6035D	MD6035C		MD6035CX	
40		OSX6032ORG	BRK011ORG		SMX6032ORG	BRK012ORG	FA368TT	MXS368	FA368R	MD6035D	MD6035C		MD6035CX	
41		OSX6032ORG	BRK011ORG		SMX6032ORG	BRK012ORG	FA368TT	MXS368	FA368R	MD6035D	MD6035C		MD6035CX	
42		OSX6932ORG	BRK013ORG		SMX6932ORG	BRK014ORG	FA368TT	MXS368	FA368R	MD6035D	MD6035C		MD6035CX	
43		OSX6932ORG	BRK013ORG		SMX6932ORG	BRK014ORG	FA368TT	MXS368	FA368R	MD6035D	MD6035C		MD6035CX	
44		OSX6932ORG	BRK013ORG		SMX6932ORG	BRK014ORG	FA368TT	MXS368	FA368R	MD6035D	MD6035C		MD6035CX	
45							FA213	FA213V	FA213HH	MD850				
46							FA213	FA213V	FA213HH	MD850				
47							FA213		FA213HH	MD850				
48		OSX6032EORG	BRK015ORG		SMX6032EORG	BRK016ORG	FA208TT	MXS208	FA208R	MD6035D	MD6035C		MD6035CX	
49		OSX6032ORG	BRK011ORG		SMX6032ORG	BRK012ORG	FA208TT	MXS208	FA208R	MD6035D	MD6035C		MD6035CX	
50		OSX6032ORG	BRK011ORG		SMX6032ORG	BRK012ORG	FA368TT	MXS368	FA368R	MD6035D	MD6035C		MD6035CX	
51		OSX6932ORG	BRK013ORG		SMX6932ORG	BRK014ORG	FA368TT	MXS368	FA368R	MD6035D	MD6035C		MD6035CX	
52							FA213	FA213V	FA213HH	MD850				
53									813G					
54							FA213		FA213HH					
55							FA213	FA213V	FA213HH	MD850				
56									813G					
57									813G					
58							FA132		FA132R	N/A				
59							FA067		FA067R	N/A				
60														

REAR / ARRIÈRE / HINTEN / POSTERIOR / POSTERIORE

R Suffix = High Durability Sintered Pad. **HH** Suffix = High Performance Sintered Pad. **TT** Suffix = Hard Wearing Off Road Pad. **V** Suffix = Semi Sintered Pad. **G** Suffix = Grooved Shoe.
D Suffix = Drilled Disc. **X** Suffix = Universal Left or Right Disc. **XC** Suffix = Contoured Disc. **LS** Suffix = Left/Steel Disc. **RS** = Right/Steel Disc.

BRAKE APPLICATIONS

*-2 Sets Required. † For Vee disc colours add RED, BLU, GRN, GLD, ORG suffix to part number.
 Ⓢ - Also available as a Vintage Motorcycle Disc.

Non-JAPANESE Built Motorcycles



KTM Contd.



DISC PAD CHOICES - FRONT

BRAKE DISC CHOICES - FRONT

	FA, SFA, TT Pad or Brake Shoe	SFAC Carbon Scooter Pads	Speciality Pads - SXR / Vee / MXS	Sintered/HH Pads/ Grooved Shoes	Left / Gauche / Links Standard Replacement Disc	Right / Droite / Rechts Standard Replacement Disc	Contour Disc Universal left and right fitment	Universal Custom Disc	Vee-Discs Black † See note below	CX Extreme MX Race Disc/ UTVX Disc
D-XC/E-XC/E-GS 250	FA132			FA132R	MD6034D					
D-XC/E-XC/T-XC/E-GS 250 (Grimeca calipers)	FA132			FA132R	MD6032D		MD6032C			MD6032CX
EXC/EGS 250	FA132			FA132R	N/A					
EXC/EGS 250 Brembo Calipers	FA067TT			FA067R	MD6034D					
EXC/EGS 250 Grimeca Calipers	FA132			FA132R	MD6034D					
EXC/EGS 250 (Standard forks)	FA181TT		MXS181	FA181R	MD6032D		MD6032C			MD6032CX
EXC 250 (Standard forks)	FA181TT		MXS181	FA181R	MD6032D		MD6032C			MD6032CX
EXC 250 (Upside down forks)	FA181TT		MXS181	FA181R	MD6032D		MD6032C			MD6032CX
EXC 250 (Upside down forks) (2T)	FA181TT		MXS181	FA181R	MD6032D		MD6032C			MD6032CX
EXC 250 (Upside down forks) (2T) Inc Tpi	FA181TT		MXS181	FA181R	MD6032D		MD6032C			MD6032CX
EXC 250 Six Days (Upside down forks) (2T) Inc Tpi	FA181TT		MXS181	FA181R	MD6032D		MD6032C			MD6032CX
EXC 250 Racing	FA181TT		MXS181	FA181R	MD6032D		MD6032C			MD6032CX
EXC-F 250 (4T)	FA181TT		MXS181	FA181R	MD6032D		MD6032C			MD6032CX
EXC-F 250 (4T)	FA181TT		MXS181	FA181R	MD6032D		MD6032C			MD6032CX
EXC-F 250 Six Days (4T)	FA181TT		MXS181	FA181R	MD6032D		MD6032C			MD6032CX
250 R Freeride (2T)	FA612TT			FA612R			MD6426C			
GS 250	FA047TT				N/A					
GSXC/GS 250	FA047TT			FA047R	N/A					
MX 250	FA132			FA132R	N/A					
MX 250 Grimeca Calipers	FA132			FA132R	N/A					
MX 250 Brembo Calipers	FA067TT			FA067R	N/A					
MX 250 Brembo Calipers	FA067TT			FA067R	N/A					
MX 250 Brembo Calipers	FA067TT			FA067R	N/A					
MX 250 Grimeca Calipers	FA132			FA132R	N/A					
MX 250 Brembo Calipers	FA181TT		MXS181	FA181R	MD6032D		MD6032C			MD6032CX
MX/EXC 250	FA126			FA126R	N/A					
MX/MXC/GS 250				814G						
MX/MXC 250	FA047TT			FA047R	N/A					
MX/MXC 250	FA047TT				N/A					
SX 250 (2T/Standard Forks)	FA181TT		MXS181	FA181R	MD6032D		MD6032C			MD6032CX
SX 250 (2T/Upside down forks)	FA181TT		MXS181	FA181R			MD6032C			MD6032CX
SX 250 (2T/Upside down forks)	FA181TT		MXS181	FA181R			MD6032C			MD6032CX
SX 250 (2T/Upside down forks)	FA181TT		MXS181	FA181R			MD6032C			MD6032CX
SX-F 250 (4T/Upside Down Forks)	FA181TT		MXS181	FA181R			MD6032C			MD6032CX
SX-F 250 (4T/Upside Down Forks)	FA181TT		MXS181	FA181R			MD6032C			MD6032CX
SX-F 250 (4T) Prado	FA181TT		MXS181	FA181R			MD6032C			MD6032CX
SX-F 250 (Ken Roczen Edition)	FA181TT		MXS181	FA181R			MD6032C			MD6032CX
SX 250 (2T/Upside down forks)	FA181TT		MXS181	FA181R			MD6032C			MD6032CX
XC 250 (2T/Upside down forks)	FA181TT		MXS181	FA181R			MD6032C			MD6032CX
XC 250 (2T) Tpi	FA181TT		MXS181	FA181R			MD6032C			MD6032CX
XC-F 250 (4T/Upside Down Forks)	FA181TT		MXS181	FA181R			MD6032C			MD6032CX
EXC 300 (Upside down forks)	FA181TT		MXS181	FA181R	MD6032D		MD6032C			MD6032CX
EXC 300 (Upside down forks)	FA181TT		MXS181	FA181R	MD6032D		MD6032C			MD6032CX
EXC 300 (Upside down forks)	FA181TT		MXS181	FA181R	MD6032D		MD6032C			MD6032CX
EXC 300 Six Days (Upside down forks)	FA181TT		MXS181	FA181R	MD6032D		MD6032C			MD6032CX
EXC 300 Tpi (Inc Six Days and Erzbergroede)	FA181TT		MXS181	FA181R	MD6032D		MD6032C			MD6032CX
EXC-E 300 (2T) (USD/Electric start)	FA181TT		MXS181	FA181R	MD6032D		MD6032C			MD6032CX
♦ Plain undrilled disc for enduro use MD6035CE										
XC 300 (2T) Inc XC-W Tpi	FA181TT		MXS181	FA181R	MD6032D		MD6032C			MD6032CX
GSXC/GS 300	FA047TT			FA047R	N/A					
MX/MXC 300	FA047TT			FA047R	N/A					
MX/MXC/GS 300	FA047TT			FA047R	N/A					
350				812G						
350 Four Stroke	FA047TT			FA047R	N/A					
350 Freeride (4T)	FA612TT			FA612R			MD6426C			
DXC/EXC/EGS 350 Brembo Calipers	FA067TT			FA067R	MD6034D					
DXC/EXC/EGS 350 Grimeca Calipers	FA132			FA132R	MD6034D					
EXC 350 Brembo Calipers	FA067TT			FA067R	MD6034D					
EXC 350 Grimeca Calipers	FA132			FA132R	MD6034D					

Line #
1
2
3
4
5
6
7
8
9
10
11
12
13
14
15
16
17
18
19
20
21
22
23
24
25
26
27
28
29
30
31
32
33
34
35
36
37
38
39
40
41
42
43
44
45
46
47
48
49
50
51
52
53
54
55
56
57
58
59
60

FRONT / AVANT / VORN / FRENTE / ANTERIORE

R Suffix = High Durability Sintered Pad. HH Suffix = High Performance Sintered Pad. TT Suffix = Hard Wearing Off Road Pad. V Suffix = Semi Sintered Pad. G Suffix = Grooved Shoe.
D Suffix = Drilled Disc. X Suffix = Universal Left or Right Disc. XC Suffix = Contoured Disc. LS Suffix = Left/Steel Disc. RS = Right/Steel Disc.

NOTE: Most KTM models changed the caliper bracket design in 2009. O/E BRACKET REF 770 13 14 0 type is used in the OS/SM6932C type disc.

*-2 Sets Required. † For Vee disc colours add RED, BLU, GRN, GLD, ORG suffix to part number.

⊗ - Also available as a Vintage Motorcycle Disc.

Non-JAPANESE Built Motorcycles

Line #	BRAKE DISC CHOICES - FRONT					DISC PAD CHOICES - REAR				BRAKE DISC CHOICES - REAR			
	Oversize 250 /280mm Disc Kit	OSX Oversize 250/280mm Disc Kit	Relocating Bracket for 250/ 280mm Disc	Oversize 320mm Disc Kit	SMX Oversize 320mm Disc Kit	Relocating Bracket for 320mm Disc	FA, SFA, TT Pad or Brake Shoe	SFAC Carbon Scooter Pads	Speciality Pads - SXR / Vee / MXS	Sintered/ HH Pads/ Grooved Shoes	Standard Replacement Disc	Contour Disc Rear fitment	Vee-Discs™ CONTOUR
1							FA132			FA132R	N/A		
2							FA067			FA067R	N/A		
3							FA132			FA132R	MD6227D		
4							FA067			FA067R	MD6227D		
5							FA132			FA132R	MD6227D		
6		OSX6032EORG	BRK0150RG		SMX6032EORG	BRK0160RG	FA208TT		MXS208	FA208R	MD6035D	MD6035C	MD6035CX
7		OSX6032EORG	BRK0150RG		SMX6032EORG	BRK0160RG	FA208TT		MXS208	FA208R	MD6035D	MD6035C♦	MD6035CX
8		OSX6032ORG	BRK0110RG		SMX6032ORG	BRK0120RG	FA208TT		MXS208	FA208R	MD6035D	MD6035C♦	MD6035CX
9		OSX6032ORG	BRK0110RG		SMX6032ORG	BRK0120RG	FA368TT		MXS368	FA368R	MD6035D	MD6035C♦	MD6035CX
10		OSX6932ORG	BRK0130RG		SMX6932ORG	BRK0140RG	FA368TT		MXS368	FA368R	MD6035D	MD6035C♦	MD6035CX
11		OSX6932ORG	BRK0130RG		SMX6932ORG	BRK0140RG	FA368TT		MXS368	FA368R	MD6035D	MD6035C♦	MD6035CX
12		OSX6032ORG	BRK0110RG		SMX6032ORG	BRK0120RG	FA368TT		MXS368	FA368R	MD6035D	MD6035C♦	MD6035CX
13		OSX6032ORG	BRK0110RG		SMX6032ORG	BRK0120RG	FA368TT		MXS368	FA368R	MD6035D	MD6035C	MD6035CX
14		OSX6932ORG	BRK0130RG		SMX6932ORG	BRK0140RG	FA368TT		MXS368	FA368R	MD6035D	MD6035C	MD6035CX
15		OSX6932ORG	BRK0130RG		SMX6932ORG	BRK0140RG	FA368TT		MXS368	FA368R	MD6035D	MD6035C	MD6035CX
16							FA602TT			FA602R		MD6360C	
17							FA047TT			FA047R	MD6227D		
18									814G				
19							FA132			FA132R	MD6227D		
20							FA132			FA132R	MD6227D		
21							FA067TT			FA067R	MD6227D		
22							FA067TT			FA067R	N/A		
23							FA067TT			FA067R	N/A		
24							FA132			FA132R	N/A		
25		OSX6032EORG	BRK0150RG		SMX6032EORG	BRK0160RG	FA067TT			FA067R	N/A		
26							FA126			FA126R	N/A		
27									814G				
28									814G				
29										MD6227D			
30		OSX6032EORG	BRK0150RG		SMX6032EORG	BRK0160RG	FA208TT		MXS208	FA208R	MD6035D	MD6035C	MD6035CX
31		OSX6032ORG	BRK0110RG		SMX6032ORG	BRK0120RG	FA208TT		MXS208	FA208R		MD6035C	MD6035CX
32		OSX6032ORG	BRK0110RG		SMX6032ORG	BRK0120RG	FA368TT		MXS368	FA368R		MD6035C	MD6035CX
33		OSX6932ORG	BRK0130RG		SMX6932ORG	BRK0140RG	FA368TT		MXS368	FA368R		MD6035C	MD6035CX
34		OSX6032ORG	BRK0110RG		SMX6032ORG	BRK0120RG	FA368TT		MXS368	FA368R		MD6035C	MD6035CX
35		OSX6932ORG	BRK0130RG		SMX6932ORG	BRK0140RG	FA368TT		MXS368	FA368R		MD6035C	MD6035CX
36		OSX6932ORG	BRK0130RG		SMX6932ORG	BRK0140RG	FA368TT		MXS368	FA368R		MD6035C	MD6035CX
37		OSX6932ORG	BRK0130RG		SMX6932ORG	BRK0140RG	FA368TT		MXS368	FA368R		MD6035C	MD6035CX
38		OSX6032ORG	BRK0110RG		SMX6032ORG	BRK0120RG	FA368TT		MXS368	FA368R		MD6035C	MD6035CX
39		OSX6932ORG	BRK0130RG		SMX6932ORG	BRK0140RG	FA368TT		MXS368	FA368R		MD6035C♦	MD6035CX
40		OSX6932ORG	BRK0130RG		SMX6932ORG	BRK0140RG	FA368TT		MXS368	FA368R		MD6035C	MD6035CX
41		OSX6932ORG	BRK0130RG		SMX6932ORG	BRK0140RG	FA368TT		MXS368	FA368R		MD6035C♦	MD6035CX
42		OSX6032ORG	BRK0110RG		SMX6032ORG	BRK0120RG	FA208TT		MXS208	FA208R	MD6035D	MD6035C♦	MD6035CX
43		OSX6032ORG	BRK0110RG		SMX6032ORG	BRK0120RG	FA368TT		MXS368	FA368R	MD6035D	MD6035C♦	MD6035CX
44		OSX6932ORG	BRK0130RG		SMX6932ORG	BRK0140RG	FA368TT		MXS368	FA368R	MD6035D	MD6035C♦	MD6035CX
45		OSX6932ORG	BRK0130RG		SMX6932ORG	BRK0140RG	FA368TT		MXS368	FA368R	MD6035D	MD6035C♦	MD6035CX
46		OSX6932ORG	BRK0130RG		SMX6932ORG	BRK0140RG	FA368TT		MXS368	FA368R	MD6035D	MD6035C♦	MD6035CX
47		OSX6032ORG	BRK0110RG		SMX6032ORG	BRK0120RG	FA368TT		MXS368	FA368R	MD6035D	MD6035C♦	MD6035CX
48							FA368TT		MXS368	FA368R		MD6035C	MD6035CX
49		OSX6932ORG	BRK0130RG		SMX6932ORG	BRK0140RG	FA368TT		MXS368	FA368R	MD6035D	MD6035C	MD6035CX
50									814G				
51									814G				
52							FA047TT			FA047R	MD6227D		
53									813G				
54									813G				
55							FA602TT			FA602R		MD6360C	
56							FA067TT			FA067R	N/A		
57							FA132			FA132R	N/A		
58							FA067TT			FA067R	MD6227D		
59							FA132			FA132R	MD6227D		
60													

REAR / ARRIÈRE / HINTEN / POSTERIOR / POSTERIORE

R Suffix = High Durability Sintered Pad. **HH** Suffix = High Performance Sintered Pad. **TT** Suffix = Hard Wearing Off Road Pad. **V** Suffix = Semi Sintered Pad. **G** Suffix = Grooved Shoe.
D Suffix = Drilled Disc. **X** Suffix = Universal Left or Right Disc. **XC** Suffix = Contoured Disc. **LS** Suffix = Left/Steel Disc. **RS** = Right/Steel Disc.

*-2 Sets Required. † For Vee disc colours add RED, BLU, GRN, GLD, ORG suffix to part number.
 Ⓢ - Also available as a Vintage Motorcycle Disc.

Non-JAPANESE Built Motorcycles



KTM Contd.



DISC PAD CHOICES - FRONT

BRAKE DISC CHOICES - FRONT

R Suffix = High Durability Sintered Pad. **HH** Suffix = High Performance Sintered Pad. **TT** Suffix = Hard Wearing Off Road Pad. **V** Suffix = Semi Sintered Pad. **G** Suffix = Grooved Shoe.

D Suffix = Drilled Disc. **X** Suffix = Universal Left or Right Disc. **XC** Suffix = Contoured Disc. **LS** Suffix = Left/Steel Disc. **RS** = Right/Steel Disc.

FRONT / AVANT / VORN / FRENTE / ANTERIORE

		FA, SFA, TT Pad or Brake Shoe	SFAC Carbon Scooter Pads	Speciality Pads - SXR / Vee / MXS	Sintered/HH Pads/ Grooved Shoes	Left / Gauche / Links Standard Replacement Disc	Right / Droite / Rechts Standard Replacement Disc	Contour Disc Universal left and right fitment	Universal Custom Disc	Vee-Discs Black † See note below	CX Extreme MX Race Disc/ UTVX Disc
350 LC4 (Standard forks)	94-95	FA181TT		MXS181	FA181R	MD6032D		MD6032C			MD6032CX
MX/MXC/GS 350	86	FA047TT			FA047R	N/A					
MX/EXC 350	87	FA126TT			FA126R	N/A					
MX/EXC/EGS 350	88	FA132			FA132R	N/A					
MX 350 (Brembo Calipers)	90-91	FA067TT			FA067R	N/A					
MX 350 (Grimeca Calipers)	90-91	FA132			FA132R	N/A					
MX 350 (Brembo Calipers)	89	FA067TT			FA067R	N/A					
MX 350 (Grimeca Calipers)	89	FA132			FA132R	N/A					
EXC 350 (Standard forks)	96-97	FA181TT		MXS181	FA181R	MD6032D		MD6032C			MD6032CX
EXC-F 350 (4T/Upside down forks)	11-22	FA181TT		MXS181	FA181R			MD6032C			MD6032CX
EXC-F 350 (4T/Six Days)	12-22	FA181TT		MXS181	FA181R			MD6032C			MD6032CX
EXC-F 350 WESS Edition 4T	22	FA181TT		MXS181	FA181R						MD6433CX
SX-F 350 (4T/Upside down forks)	11-22	FA181TT		MXS181	FA181R			MD6032C			MD6032CX
SX-F 350 (Tony Cairoli Edition)	12	FA181TT		MXS181	FA181R			MD6032C			MD6032CX
XC-F 350 (4T) Inc XCF-W	12-21	FA181TT		MXS181	FA181R			MD6032C			MD6032CX
EXC 360	96-97	FA181TT		MXS181	FA181R	MD6032D		MD6032C			MD6032CX
SX 360 (Standard forks)	96-97	FA181TT		MXS181	FA181R	MD6032D		MD6032C			MD6032CX
EXC 380 (Standard forks)	98-99	FA181TT		MXS181	FA181R	MD6032D		MD6032C			MD6032CX
EXC 380 (Upside down forks)	00-03	FA181TT		MXS181	FA181R	MD6032D		MD6032C			MD6032CX
SX 380 (Standard forks)	98-99	FA181TT		MXS181	FA181R	MD6032D		MD6032C			MD6032CX
SX 380 (Upside down forks)	00-03	FA181TT		MXS181	FA181R	MD6032D		MD6032C			MD6032CX
390 Adventure	19-20	FA606			FA606HH						
390 Duke (300mm F/Disc)	13-17	FA606			FA606HH	MD864		MD864XC			
390 Duke (320mm F/Disc)	18-20	FA606			FA606HH	MD8010					
390 Duke (4T)	15	FA606			FA606HH						
RC 390	14-16	FA606			FA606HH						
RC 390	17-20	FA606			FA606HH	MD864		MD864XC			
Duke 400 LC4	94-98	FA095			FA095HH	MD6199D		MD6199C			
EGS 400/EGS-E/LSE (LC4 Enduro)	96-99	FA181TT		MXS181	FA181R	MD6130D					
EXC/EGS 400 (USD)	00-03	FA181TT		MXS181	FA181R	MD6032D		MD6032C			MD6032CX
EXC 400 Racing (USD)	00	FA181TT		MXS181	FA181R	MD6032D		MD6032C			MD6032CX
EXC 400 Racing	04-07	FA181TT		MXS181	FA181R	MD6032D		MD6032C			MD6032CX
LC4-E 400 Enduro	00-01	FA181TT		MXS181	FA181R	MD6130D					
SC 400 (Supercompetition LC4)	96-99	FA181TT		MXS181	FA181R	MD6032D		MD6032C			MD6032CX
SX 400 (Upside down forks)	00-02	FA181TT		MXS181	FA181R	MD6032D		MD6032C			MD6032CX
420 GS	85				812G						
EXC 440	94-95	FA181TT		MXS181	FA181R	MD6032D		MD6032C			MD6032CX
EXC 450 (4T)	03	FA181TT		MXS181	FA181R	MD6032D		MD6032C			MD6032CX
EXC 450 (4T)	04-08	FA181TT		MXS181	FA181R	MD6032D		MD6032C			MD6032CX
EXC 450 (4T)	09-22	FA181TT		MXS181	FA181R	MD6032D		MD6032C			MD6032CX
EXC 450 Six Days (4T)	11-22	FA181TT		MXS181	FA181R	MD6032D		MD6032C			MD6032CX
EXC 450 Racing	06-07	FA181TT		MXS181	FA181R	MD6032D		MD6032C			MD6032CX
EXC-R 450 (4T)	08	FA181TT		MXS181	FA181R	MD6032D		MD6032C			MD6032CX
450 Rally	17-20				FA209/2HH	MD6130D					MD6130CX
SMR 450 (6 piston caliper)	04				MXS406	MD6270D					
SMR 450 (4 piston caliper)	05-06				MXS405	MD6270D		MD6270C			
SMR 450 (Magura caliper)	07-13	FA433/4			FA433/4HH			MD6313C			
SMR 450 (Brembo caliper)	14				FA447HH			MD6270C			
SX 440	94-95	FA181TT		MXS181	FA181R	MD6032D		MD6032C			MD6032CX
SX 450 (4T)	03-06	FA181TT		MXS181	FA181R			MD6032C			MD6032CX
SX-F 450 (4T)	07-08	FA181TT		MXS181	FA181R			MD6032C			MD6032CX
SX-F 450 (4T) Inc Cairoli	09-22	FA181TT		MXS181	FA181R			MD6032C			MD6032CX
450 SX-F (Quad)	09				FA462R*			MD6336C*			
XC 450 (Quad)	08-10				FA462R*			MD6336C*			
495	-82				812G						
495 MX Leleu	82				811G						
EXC-F 500 (4T)	12-22	FA181TT		MXS181	FA181R	MD6032D		MD6032C			MD6032CX
EXC 500 Six Days (4T)	12-22	FA181TT		MXS181	FA181R	MD6032D		MD6032C			MD6032CX
♦ Plain undrilled disc for enduro use MD6035CE											

Line #

NOTE: Most KTM models changed the caliper bracket design in 2009. O/E BRACKET REF 770 13 14 0 type is used in the OS/SM6932C type disc.

*-2 Sets Required. † For Vee disc colours add RED, BLU, GRN, GLD, ORG suffix to part number.

⊗ - Also available as a Vintage Motorcycle Disc.

Non-JAPANESE Built Motorcycles

Line #	BRAKE DISC CHOICES - FRONT					DISC PAD CHOICES - REAR				BRAKE DISC CHOICES - REAR				
	Oversize 250 /280mm Disc Kit	OSX Oversize 250/280mm Disc Kit	Relocating Bracket for 250/ 280mm Disc	Oversize 320mm Disc Kit	SMX Oversize 320mm Disc Kit	Relocating Bracket for 320mm Disc	FA, SFA, TT Pad or Brake Shoe	SFAC Carbon Scooter Pads	Speciality Pads - SXR / Vee / MXS	Sintered/ HH Pads/ Grooved Shoes	Standard Replacement Disc	Contour Disc Rear fitment	Vee-Discs™ CONTOUR	CX Extreme MX Race Disc/ UTVX Disc
1		OSX6032EORG	BRK0150RG		SMX6032EORG	BRK0160RG	FA208TT		MXS208	FA208R	MD6371D	MD6371C		
2							FA047TT			FA047R	MD6227D			
3							FA126TT			FA126R	N/A			
4							FA132			FA132R	MD6227D			
5							FA067TT			FA067R	N/A			
6							FA132			FA132R	N/A			
7							FA067TT			FA067R	MD6227D			
8							FA132			FA132R	MD6227D			
9		OSX6032EORG	BRK0150RG		SMX6032EORG	BRK0160RG	FA208TT		MXS208	FA208R	MD6035D	MD6035C♦		MD6035CX
10		OSX6932ORG	BRK0130RG		SMX6932ORG	BRK0140RG	FA368TT		MXS368	FA368R		MD6035C		MD6035CX
11		OSX6932ORG	BRK0130RG		SMX6932ORG	BRK0140RG	FA368TT		MXS368	FA368R		MD6035C		MD6035CX
12		OSX6932ORG	BRK0130RG		SMX6932ORG	BRK0140RG	FA368TT		MXS368	FA368R		MD6035C		MD6035CX
13		OSX6932ORG	BRK0130RG		SMX6932ORG	BRK0140RG	FA368TT		MXS368	FA368R		MD6035C		MD6035CX
14		OSX6932ORG	BRK0130RG		SMX6932ORG	BRK0140RG	FA368TT		MXS368	FA368R		MD6035C		MD6035CX
15		OSX6932ORG	BRK0130RG		SMX6932ORG	BRK0140RG	FA368TT		MXS368	FA368R		MD6035C		MD6035CX
16		OSX6032EORG	BRK0150RG		SMX6032EORG	BRK0160RG	FA208TT		MXS208	FA208R	MD6035D	MD6035C		MD6035CX
17		OSX6032EORG	BRK0150RG		SMX6032EORG	BRK0160RG	FA208TT		MXS208	FA208R	MD6035D	MD6035C		MD6035CX
18		OSX6032EORG	BRK0150RG		SMX6032EORG	BRK0160RG	FA208TT		MXS208	FA208R	MD6035D	MD6035C♦		MD6035C
19		OSX6032ORG	BRK0110RG		SMX6032ORG	BRK0120RG	FA208TT		MXS208	FA208R	MD6035D	MD6035C♦		MD6035CX
20		OSX6032EORG	BRK0150RG		SMX6032EORG	BRK0160RG	FA208TT		MXS208	FA208R	MD6035D	MD6035C		MD6035CX
21		OSX6032ORG	BRK0110RG		SMX6032ORG	BRK0120RG	FA208TT		MXS208	FA208R	MD6035D	MD6035C		MD6035CX
22							FA213			FA213HH				
23							FA213			FA213HH	MD850			
24							FA213			FA213HH	MD850			
25							FA213			FA213HH	MD850			
26							FA213			FA213HH	MD850			
27							FA213			FA213HH	MD850			
28			N/A			N/A	FA208TT		MXS208	FA208R	MD6371D	MD6371C		
29			N/A			N/A	FA208TT		MXS208	FA208R	MD6371D			
30		OSX6032ORG	BRK0110RG		SMX6032ORG	BRK0120RG	FA208TT		MXS208	FA208R	MD6371D	MD6371C		
31		OSX6032ORG	BRK0110RG		SMX6032ORG	BRK0120RG	FA208TT		MXS208	FA208R	MD6035D	MD6035C♦		MD6035CX
32		OSX6032ORG	BRK0110RG		SMX6032ORG	BRK0120RG	FA368TT		MXS368	FA368R	MD6035D	MD6035C		MD6035CX
33			N/A			N/A	FA208TT		MXS208	FA208R	MD6035D	MD6035C		MD6035CX
34		OSX6032EORG	BRK0150RG		SMX6032EORG	BRK0160RG	FA208TT		MXS208	FA208R	MD6371D	MD6371C		
35		OSX6032ORG	BRK0110RG		SMX6032ORG	BRK0120RG	FA208TT		MXS208	FA208R	MD6035D	MD6035C		MD6035CX
36										812G				
37		OSX6032ORG	BRK0110RG		SMX6032ORG	BRK0120RG	FA208TT		MXS208	FA208R	MD6371D	MD6371C		
38		OSX6032ORG	BRK0110RG		SMX6032ORG	BRK0120RG	FA208TT		MXS208	FA208R	MD6035D	MD6035C♦		MD6035CX
39		OSX6032ORG	BRK0110RG		SMX6032ORG	BRK0120RG	FA368TT		MXS368	FA368R	MD6035D	MD6035C♦		MD6035CX
40		OSX6932ORG	BRK0130RG		SMX6932ORG	BRK0140RG	FA368TT		MXS368	FA368R	MD6035D	MD6035C♦		MD6035CX
41		OSX6932ORG	BRK0130RG		SMX6932ORG	BRK0140RG	FA368TT		MXS368	FA368R	MD6035D	MD6035C♦		MD6035CX
42		OSX6032ORG	BRK0110RG		SMX6032ORG	BRK0120RG	FA368TT		MXS368	FA368R	MD6035D	MD6035C♦		MD6035CX
43		OSX6032ORG	BRK0110RG		SMX6032ORG	BRK0120RG	FA368TT		MXS368	FA368R	MD6035D	MD6035C♦		MD6035CX
44		TBC	TBC				FA368TT		MXS368	FA368R	MD6269D	MD6269C		
45							FA368TT		MXS368	FA368R	MD6035D	MD6035C		
46							FA368TT		MXS368	FA368R	MD6035D	MD6035C		
47							FA368TT		MXS368	FA368R		MD6035C		
48							FA368TT		MXS368	FA368R		MD6035C		
49		OSX6032EORG	BRK0150RG		SMX6032EORG	BRK0160RG	FA208TT		MXS208	FA208R	MD6371D	MD6371C		
50		OSX6032ORG	BRK0110RG		SMX6032ORG	BRK0120RG	FA368TT		MXS368	FA368R		MD6035C		MD6035CX
51		OSX6032ORG	BRK0110RG		SMX6032ORG	BRK0120RG	FA368TT		MXS368	FA368R		MD6035C		MD6035CX
52		OSX6932ORG	BRK0130RG		SMX6932ORG	BRK0140RG	FA368TT		MXS368	FA368R		MD6035C		MD6035CX
53										FA463R	MD6337D			
54										FA463R	MD6337D			
55										813G				
56										813G				
57		OSX6932ORG	BRK0130RG		SMX6932ORG	BRK0140RG	FA368TT		MXS368	FA368R	MD6035D	MD6035C♦		MD6035CX
58		OSX6932ORG	BRK0130RG		SMX6932ORG	BRK0140RG	FA368TT		MXS368	FA368R	MD6035D	MD6035C♦		MD6035CX
59														
60														

REAR / ARRIERE / HINTEN / POSTERIORE

R Suffix = High Durability Sintered Pad. HH Suffix = High Performance Sintered Pad. TT Suffix = Hard Wearing Off Road Pad. V Suffix = Semi Sintered Pad. G Suffix = Grooved Shoe.

D Suffix = Drilled Disc. X Suffix = Universal Left or Right Disc. XC Suffix = Contoured Disc. LS Suffix = Left/Steel Disc. RS = Right/Steel Disc.

BRAKE APPLICATIONS

*-2 Sets Required. † For Vee disc colours add RED, BLU, GRN, GLD, ORG suffix to part number.
 ♦ - Also available as a Vintage Motorcycle Disc.

Non-JAPANESE Built Motorcycles



KTM Contd.



DISC PAD CHOICES - FRONT

BRAKE DISC CHOICES - FRONT

R Suffix = High Durability Sintered Pad. **HH** Suffix = High Performance Sintered Pad. **TT** Suffix = Hard Wearing Off Road Pad. **V** Suffix = Semi Sintered Pad. **G** Suffix = Grooved Shoe.

D Suffix = Drilled Disc. **X** Suffix = Universal Left or Right Disc. **XC** Suffix = Contoured Disc. **LS** Suffix = Left/Steel Disc. **RS** = Right/Steel Disc.

FRONT / AVANT / VORN / FRENTE / ANTERIORE

		FA, SFA, TT Pad or Brake Shoe	SFAC Carbon Scooter Pads	Semi-Sintered V-Pads™	Sintered/HH Pads/ Grooved Shoes	Left / Gauche / Links Standard Replacement Disc	Right / Droite / Rechts Standard Replacement Disc	Contour Disc Universal left and right fitment	Universal Custom Disc	Vee-Discs Black † See note below	CX Extreme MX Race Disc	Line #
500 XCF-W 4T	21	FA181TT		MXS181	FA181R	MD6032D		MD6032C				1
LC-4 MX/EXC 500	89	FA132			FA132R	MD6034D						2
LC-4 MX 500 Brembo Calipers	90-91	FA067TT			FA067R	N/A						3
LC-4 EXC 500 Brembo Calipers	90-91	FA067TT			FA067R	MD6034D						4
LC-4 MX 500 Grimeca Calipers	90-91	FA132			FA132R	N/A						5
LC-4 EXC 500 Grimeca Calipers	90-91	FA132			FA132R	MD6034D						6
MX/MXC/XC-GS 500	85	FA047TT				N/A						7
MX 500	92-94	FA181TT		MXS181	FA181R	N/A						8
MX 500	95	FA181TT		MXS181	FA181R	N/A						9
SX-F 505	07-08	FA181TT		MXS181	FA181R	MD6032D		MD6032C			MD6032CX	10
SX-F 505	09	FA181TT		MXS181	FA181R	MD6032D		MD6032C			MD6032CX	11
505 SX-F (Quad)	09-12				FA462R*			MD6336C*				12
EXC 520	01-03	FA181TT		MXS181	FA181R	MD6032D		MD6032C			MD6032CX	13
SX 520	01-03	FA181TT		MXS181	FA181R	MD6032D		MD6032C			MD6032CX	14
EXC 525	03	FA181TT		MXS181	FA181R	MD6032D		MD6032C			MD6032CX	15
EXC 525	04-05	FA181TT		MXS181	FA181R	MD6032D		MD6032C			MD6032CX	16
EXC 525 Racing	06	FA181TT		MXS181	FA181R	MD6032D		MD6032C			MD6032CX	17
MXC 525 (Desert Racing)	03	FA181TT		MXS181	FA181R	MD6032D		MD6032C			MD6032CX	18
MXC 525 (Desert Racing)	04	FA181TT		MXS181	FA181R	MD6032D		MD6032C			MD6032CX	19
SMR 525 (6 piston caliper)	04				MXS406	MD6270D		MD6270C				20
SMR 525 (4 piston caliper)	05				MXS405	MD6270D		MD6270C				21
SX 525	03-06	FA181TT		MXS181	FA181R	MD6032D		MD6032C			MD6032CX	22
XC 525 Racing	06-07	FA181TT		MXS181	FA181R	MD6032D		MD6032C			MD6032CX	23
XC 525 (Quad)	08-12				FA462R*			MD6336C*				24
EXC 530 (4T)	09-10	FA181TT		MXS181	FA181R			MD6032C			MD6032CX	25
EXC 530 Six Days (4T)	11	FA181TT		MXS181	FA181R			MD6032C			MD6032CX	26
EXC-R 530 (4T)	08	FA181TT		MXS181	FA181R	MD6032D		MD6032C			MD6032CX	27
MXC 550	96	FA181TT		MXS181	FA181R	MD6032D		MD6032C			MD6032CX	28
SMR 560 Supermoto	06				MXS405	N/A						29
SMR 560	07	FA433/4			FA433/4HH	TBA						30
LC4 MX/EXC 600	89	FA132			FA132R	MD6034D						31
LC4 MX 600 Brembo Calipers	90-91	FA067TT			FA067R	N/A						32
LC4 EXC 600 Brembo Calipers	90-91	FA067TT			FA067R	MD6034D						33
LC4 MX 600 Grimeca Calipers	90-91	FA132			FA132R	N/A						34
LC4 EXC 600 Grimeca Calipers	90-91	FA132			FA132R	MD6034D						35
LC4 EXC 600	92-93	FA132			FA132R	MD6034D						36
EGS-E 620 Adventure/Rallye	99	FA181TT		MXS181	FA181R	MD6032D		MD6032C			MD6032CX	37
EGS 620 Enduro/EGS-E/LSE	96-99	FA181TT		MXS181	FA181R	MD6130D						38
LC4 620 SC Supermoto	00	FA181TT		MXS181	FA181R	MD6199D		MD6199C				39
SC 620 Supercompetition	96-00	FA181TT		MXS181	FA181R	MD6032D		MD6032C			MD6032CX	40
SX 620/EXC/EGS	94	FA181TT		MXS181	FA181R	MD6032D		MD6032C			MD6032CX	41
SX EXC/EGS 620	95	FA181TT		MXS181	FA181R	MD6032D		MD6032C			MD6032CX	42
SX 620	96-99	FA181TT		MXS181	FA181R	MD6032D		MD6032C			MD6032CX	43
LC4 625 SC Supermoto	02	FA181TT		MXS181	FA181R	MD6199D		MD6199C				44
LC4 625 SC Supercompetition	02	FA181TT		MXS181	FA181R	MD6032D		MD6032C			MD6032CX	45
SMC 625	04-06	FA244			FA244HH			MD6199C				46
SXC 625	03-06	FA181TT		MXS181	FA181R	MD6032D		MD6032C			MD6032CX	47
Duke-E 640 (Single pin pad fixing/zero offset disc)	98	FA095			FA095HH	MD6199D		MD6199C				48
Duke II 640 (2 pin pad fixing disc/zero offset)	99-02	FA244			FA244HH	MD6199D		MD6199C				49
Duke II 640 (2 pin pad fixing disc/zero offset)	03-07	FA244			FA244HH	MD633X		MD633XC		VR633ORG		50
LC4-E 640 Enduro	00-04	FA181TT		MXS181	FA181R	MD6130D						51
LC4-E 640 Supermoto												52
(Single Pin Pad Fixing At End Of Pad)	99-02	FA181TT		MXS181	FA181R	MD6199D		MD6199C				53
LC4-E 640 Supermoto (Central Single Pin Fixing)	03	FA095			FA095HH	MD6199D		MD6199C				54
LC4-E 640 Supermoto (2 Pin Fixing)	04-06	FA244			FA244HH	MD6199D		MD6199C				55
LC-4 640 Adventure	01-02	FA181TT		MXS181	FA181R	MD6199D		MD6199C				56
LC-4 640 Adventure R	99-02	FA181TT		MXS181	FA181R	MD6199D		MD6199C				57
LC-4 640 Adventure	03	FA181TT*		MXS181	FA181R*	MD6199D	MD6199D	MD6199C*				58
◆ Plain undrilled disc for enduro use MD6035CE												59

NOTE: Most KTM models changed the caliper bracket design in 2009. O/E BRACKET REF 770 13 14 0 type is used in the OS/SM6932C type disc.

*-2 Sets Required. † For Vee disc colours add RED, BLU, GRN, GLD, ORG suffix to part number. ■ - Also available in MX-S race compound.

⊗ - Also available as a Vintage Motorcycle Disc.

Non-JAPANESE Built Motorcycles

Line #	BRAKE DISC CHOICES - FRONT						DISC PAD CHOICES - REAR				BRAKE DISC CHOICES - REAR			
	Oversize 250 /280mm Disc Kit	OSX Oversize 250/280mm Disc Kit	Relocating Bracket for 250/ 280mm Disc	Oversize 320mm Disc Kit	SMX Oversize 320mm Disc Kit	Relocating Bracket for 320mm Disc	FA, SFA, TT Pad or Brake Shoe	SFAC Carbon Scooter Pads	Speciality Pads - SXR / Vee / MXS	Sintered/ HH Pads/ Grooved Shoes	Standard Replacement Disc	Contour Disc Rear fitment	Vee-Discs™ CONTOUR	CX Extreme MX Race Disc/ UTVX Disc
1							FA368TT		MD6035D	FA368R		MD6035C		MD6035CX
2							FA132			FA132R	N/A			
3							FA067TT			FA067R	MD6035D	MD6035C		
4							FA067TT			FA067R	MD6035D	MD6035C		
5							FA132			FA132R	MD6035D	MD6035C		
6							FA132			FA132R	MD6035D	MD6035C		
7										814G				
8							FA067TT			FA067R	N/A			
9							FA208TT		MXS208	FA208R	N/A			
10		OSX6032ORG	BRK011ORG		SMX6032ORG	BRK012ORG	FA368TT		MXS368	FA368R	MD6035D	MD6035C		MD6035CX
11		OSX6932ORG	BRK013ORG		SMX6932ORG	BRK014ORG	FA368TT		MXS368	FA368R	MD6035D	MD6035C		MD6035CX
12										FA463R	MD637D			
13		OSX6032ORG	BRK011ORG		SMX6032ORG	BRK012ORG	FA208TT		MXS208	FA208R	MD6035D	MD6035C		MD6035CX
14		OSX6032ORG	BRK011ORG		SMX6032ORG	BRK012ORG	FA208TT		MXS208	FA208R	MD6035D	MD6035C		MD6035CX
15		OSX6032ORG	BRK011ORG		SMX6032ORG	BRK012ORG	FA208TT		MXS208	FA208R	MD6035D	MD6035C		MD6035CX
16		OSX6032ORG	BRK011ORG		SMX6032ORG	BRK012ORG	FA368TT		MXS368	FA368R	MD6035D	MD6035C		MD6035CX
17		OSX6032ORG	BRK011ORG		SMX6032ORG	BRK012ORG	FA368TT		MXS368	FA368R	MD6035D	MD6035C		MD6035CX
18		OSX6032ORG	BRK011ORG		SMX6032ORG	BRK012ORG	FA208TT		MXS208	FA208R	MD6035D	MD6035C		MD6035CX
19		OSX6032ORG	BRK011ORG		SMX6032ORG	BRK012ORG	FA208TT		MXS208	FA208R	MD6035D	MD6035C		MD6035CX
20														
21							FA368TT		MXS368	FA368R	MD6035D	MD6035C		
22		OSX6032ORG	BRK011ORG		SMX6032ORG	BRK012ORG	FA368TT		MXS368	FA368R	MD6035D	MD6035C		MD6035CX
23		OSX6032ORG	BRK011ORG		SMX6032ORG	BRK012ORG	FA368TT		MXS368	FA368R	MD6035D	MD6035C		MD6035CX
24										FA463R	MD637D			
25		OSX6032ORG	BRK011ORG		SMX6032ORG	BRK012ORG	FA368TT		MXS368	FA368R		MD6035C		MD6035CX
26		OSX6932ORG	BRK013ORG		SMX6932ORG	BRK014ORG	FA368TT		MXS368	FA368R		MD6035C		MD6035CX
27		OSX6032ORG	BRK011ORG		SMX6032ORG	BRK012ORG	FA368TT		MXS368	FA368R	MD6035D	MD6035C		MD6035CX
28		OSX6032EORG	BRK015ORG		SMX6032EORG	BRK016ORG	FA208TT		MXS208	FA208R	MD6035D	MD6035C		MD6035CX
29							FA368TT		MXS368	FA368R	MD6035D	MD6035C		
30							FA368TT		MXS368	FA368R	MD6035D	MD6035C		
31							FA132			FA132R	N/A			
32							FA067TT			FA067R	MD6371D			
33							FA067TT			FA067R	MD6371D			
34							FA132			FA132R	MD6371D			
35							FA132			FA132R	MD6371D			
36							FA067TT			FA067R	MD6371D			
37		OSX6032EORG	BRK015ORG		SMX6032EORG	BRK016ORG	FA208TT		MXS208	FA208R	MD6371D	MD6371C		
38							FA208TT		MXS208	FA208R	MD6371D			
39			N/A			N/A	FA208TT		MXS208	FA208R	MD6371D	MD6371C		
40		OSX6032EORG	BRK015ORG		SMX6032EORG	BRK016ORG	FA208TT		MXS208	FA208R	MD6371D	MD6371C		
41		OSX6032EORG	BRK015ORG		SMX6032EORG	BRK016ORG	FA067TT			FA067R	MD6371D	MD6371C		
42		OSX6032EORG	BRK015ORG		SMX6032EORG	BRK016ORG	FA208TT		MXS208	FA208R	MD6371D	MD6371C		
43		OSX6032EORG	BRK015ORG		SMX6032EORG	BRK016ORG	FA208TT		MXS208	FA208R	MD6371D	MD6371C		
44			N/A			N/A	FA208TT		MXS208	FA208R	MD6371D	MD6371C		
45		OSX6032ORG	BRK011ORG		SMX6032ORG	BRK012ORG	FA208TT		MXS208	FA208R	MD6371D	MD6371C		
46			N/A			N/A	FA208TT		MXS208	FA208R	MD6371D	MD6371C		
47		OSX6032ORG	BRK011ORG		SMX6032ORG	BRK012ORG	FA208TT		MXS208	FA208R	MD6371D	MD6371C		
48			N/A			N/A	FA213		FA213V	FA213HH	MD6371D	MD6371C		
49			N/A			N/A	FA213		FA213V	FA213HH	MD6371D	MD6371C		
50			N/A			N/A	FA213		FA213V	FA213HH	MD6371D	MD6371C		
51			N/A			N/A	FA208TT		MXS208	FA208R	MD6371D			
52														
53			N/A			N/A	FA208TT		MXS208	FA208R	MD6371D	MD6371C		
54			N/A			N/A	FA208TT		MXS208	FA208R	MD6371D	MD6371C		
55			N/A			N/A	FA208TT		MXS208	FA208R	MD6371D	MD6371C		
56			N/A			N/A	FA208TT		MXS208	FA208R	MD6371D	MD6371C		
57			N/A			N/A	FA208TT		MXS208	FA208R	MD6371D	MD6371C		
58							FA208TT		MXS208	FA208R	MD6371D	MD6371C		
59														
60														

HH Suffix = High Durability Sintered Pad. TT Suffix = Hard Wearing Off Road Pad. V Suffix = Semi Sintered Pad. G Suffix = Grooved Shoe.

D Suffix = Drilled Disc. X Suffix = Universal Left or Right Disc. XC Suffix = Contoured Disc. LS Suffix = Left/Steel Disc. RS = Right/Steel Disc.

*-2 Sets Required. † For Vee disc colours add RED, BLU, GRN, GLD, ORG suffix to part number.
 Ⓢ - Also available as a Vintage Motorcycle Disc.

BRAKE APPLICATIONS

Non-JAPANESE Built Motorcycles



KTM Contd.



DISC PAD CHOICES - FRONT

BRAKE DISC CHOICES - FRONT

FA, SFA, TT Pad or Brake Shoe	SFAC Carbon Scooter Pads	Semi-Sintered V-Pads™	Sintered/HH Pads/ Grooved Shoes	Left / Gauche / Links Standard Replacement Disc	Right / Droite / Rechts Standard Replacement Disc	Contour Disc Universal left and right fitment	Universal Custom Disc	Vee-Discs Black † See note below	CX Extreme MX Race Disc
LC4 640 Adventure R			FA209/2*	MD6266D*					
LC4 640 Adventure			FA209/2*	MD6266D*					
SMC 640 LC4			FA244	FA244HH	TBA				
SMC 660 Supermoto			FA095	FA095HH	TBA				
SMC 660 Supermoto			FA244	FA244HH	TBA				
690 Duke				FA322/4HH	MD614X	MD614XC		VR614BLK†	
690 Duke (2 Pin Pad Fixing/5 Spoke Cast Wheels)			FA244	FA244HH	MD614X	MD614XC		VR614BLK†	
690 Duke (2 Pin Pad Fixing/Multi Spoke Cast Wheels)			FA244	FA244HH	MD856X	MD856XC		VR856ORG	
690 Duke R (5 Spoke Cast Wheels)				FA322/4HH	MD614X	MD614XC		VR614BLK†	
690 Duke R (Multi Spoke Cast Wheels)				FA447HH	MD856X	MD856XC		VR856ORG	
690 Enduro			FA209/2	FA209/2HH	MD844X	MD6299C			
690 R Enduro			FA209/2	FA209/2HH	MD844X	MD6299C			
690 R Enduro (ABS)			FA209/2	FA209/2HH		MD6299C			
690 Rally Factory Replica			FA209/2	FA209/2HH	MD6299D	MD6299C			
690 SM (2 pin pad fixing/spoke wheel)			FA244	FA244HH	MD862X				
690 SM - LE (Limited Edition)			FA244	FA244HH	MD6199D	MD6199C			
690 SMC (4 pad type caliper/spoke wheel)				FA322/4HH	MD862X				
690 SMC R				FA322/4HH	MD6199D	MD6199C			
690 SMC R (ABS)				FA322/4HH	MD6414D	MD6414C			
790 Duke			FA244*	FA244V*	FA244HH*	TBC	TBC		
790 Adventure					FA244HH*	TBC	TBC		
790 Adventure R			FA244*	FA244V*	FA244HH*	TBC	TBC		
790 Adventure R Rally					FA244HH*	TBC	TBC		
890 Duke					FA244HH*	TBC	TBC		
890 Duke R					FA447HH*	MD856X	MD856X		
890 Adventure Inc L					FA244HH*	TBC	TBC		
890 Adventure R					FA244HH*	TBC	TBC		
890 Adventure R Rally					FA244HH*	TBC	TBC		
950 Adventure			FA209/2*	FA209/2V*	FA209/2HH*	MD6266D	MD6266D		
950 Adventure S			FA209/2*	FA209/2V*	FA209/2HH*	MD6266D	MD6266D		
950 R Superenduro			FA209/2	FA209/2V	FA209/2HH	MD6299D			
950 Supermoto					FA322/4HH*	MD680	MD680	MD680C*	
990 Adventure S (Non ABS)			FA209/2*	FA209/2V*	FA209/2HH*	MD6299D	MD6299D		
990 Adventure R (Non ABS)			FA209/2*	FA209/2V*	FA209/2HH*	MD6299D	MD6299D		
990 Adventure (ABS Model) Left			FA209/2	FA209/2V	FA209/2HH	MD844X		MD844XC	
990 Adventure (ABS Model) Right			FA209/2	FA209/2V	FA209/2HH	MD844X	MD848X	MD848XC	
990 Adventure Dakar Edition (ABS Model) Left			FA209/2	FA209/2V	FA209/2HH	MD844X	MD848X	MD848XC	
990 Adventure Dakar Edition (ABS Model) Right			FA209/2	FA209/2V	FA209/2HH	MD844X	MD848X	MD848XC	
990 Superduke					FA322/4HH*	MD633X	MD633X	MD633XC*	VR6330RG*
990 Superduke R					FA322/4HH*	MD633X	MD633X	MD633XC*	VR6330RG*
990 Supermoto T (SM-T)					FA322/4HH*	MD680	MD680	MD680C*	
990 Supermoto T (SM-T ABS Model)					FA322/4HH*	MD8003X	MD8003X	MD680C*	
990 Supermoto R (SM-R)					FA322/4HH*	MD680	MD680	MD680C*	
990 Supermoto R (SM-R)					FA447HH*	MD680	MD680	MD680C*	
990 Supermoto R (SM-R ABS Model)					FA447HH*	MD8003X	MD8003X	MD680C*	
1050 Adventure			FA244*	FA244V*	FA244HH*	MD896X	MD896X		
1090 Adventure			FA244*	FA244V*	FA244HH*	MD896X	MD896X		
1090 Adventure R			FA244*	FA244V*	FA244HH*	MD896X	MD896X		
RC8 (1190cc)					FA447HH*	MD633X	MD633X	MD633XC*	VR6330RG*
RC8R/Track (1190cc)					FA447HH*	MD633X	MD633X	MD633XC*	VR6330RG*
1190 Adventure			FA244*		FA244HH*	MD896X	MD896X		
1190 Adventure R			FA244*		FA244HH*	MD896X	MD896X		
1290 Super Duke R					FA447HH*	MD2112X	MD2112X		
1290 Super Duke RR					FA447HH*	TBC	TBC		
1290 Super Duke R SE					FA447HH*	MD2112X	MD2112X		
1290 Super Duke GT					FA447HH*	MD2112X	MD2112X		
1290 Super Adventure			FA244*		FA244HH*	MD896X	MD896X		

FRONT / AVANT / VORN / FRENTE / ANTERIORE

Line #

R Suffix = High Durability Sintered Pad. HH Suffix = High Performance Sintered Pad. TT Suffix = Hard Wearing Off Road Pad. V Suffix = Semi Sintered Pad. G Suffix = Grooved Shoe. D Suffix = Drilled Disc. X Suffix = Universal Left or Right Disc. XC Suffix = Contoured Disc. LS Suffix = Left/Steel Disc. RS = Right/Steel Disc.

† Plain undrilled disc for enduro use MD6035CE

‡ - Choice of MD6130D = Solid. MD6130DF = Pro-lite. MD6130CF = Contour Profile.

NOTE: Most KTM models changed the caliper bracket design in 2009. O/E BRACKET REF 770 13 14 0 type is used in the OS/SM6932C type disc.

*-2 Sets Required. † For Vee disc colours add RED, BLU, GRN, GLD, ORG suffix to part number.

⊗ - Also available as a Vintage Motorcycle Disc.

Non-JAPANESE Built Motorcycles

Line #	BRAKE DISC CHOICES - FRONT						DISC PAD CHOICES - REAR				BRAKE DISC CHOICES - REAR			
	OverSize 250 /280mm Disc Kit	OSX OverSize 250/280mm Disc Kit	Relocating Bracket for 250/ 280mm Disc	OverSize 320mm Disc Kit	SMX OverSize 320mm Disc Kit	Relocating Bracket for 320mm Disc	FA, SFA, TT Pad or Brake Shoe	SFAC Carbon Scooter Pads	Speciality Pads - SXR / Vee / MXS	Sintered/ HH Pads/ Grooved Shoes	Standard Replacement Disc	Contour Disc Rear fitment	Vee-Discs™ CONTOUR	CX Extreme MX Race Disc/ UTVX Disc
1							FA208TT		MXS208	FA208R	MD6371D	MD6371C		
2							FA208TT		MXS208	FA208R	MD6371D	MD6371C		
3							FA208TT		MXS208	FA208R	MD6371D			
4							FA208TT		MXS208	FA208R	MD6371D			
5							FA208TT		MXS208	FA208R	MD6371D			
6							FA213		FA213V	FA213HH	MD681	MD681C	VR681	
7							FA213		FA213V	FA213HH	MD681	MD681C	VR681	
8							FA213			FA213HH	MD857	MD857C		
9							FA213		FA213V	FA213HH	MD681	MD681C	VR681	
10							FA213			FA213HH	MD857	MD857C		
11							FA208TT		MXS208	FA208R	MD6269D	MD6269C		
12							FA208TT		MXS208	FA208R	MD6269D	MD6269C		
13							FA208TT		MXS208	FA208R	MD6415D		MD6415C	
14							FA213		FA213V	FA213HH	MD6269D	MD6269C		
15							FA213		FA213V	FA213HH	MD6269D			
16							FA213		FA213V	FA213HH	MD6269D			
17							FA213		FA213V	FA213HH	MD6298D			
18							FA213		FA213V	FA213HH	MD6298D			
19							FA208TT		MXS208	FA208R	MD6415D		MD6415C	
20							FA213		FA213V	FA213HH	MD681	MD681	VR681	
21							FA181TT		MXS181	FA181R	TBC			
22							FA181TT		MXS181	FA181R	TBC			
23							FA181TT		MXS181	FA181R	TBC			
24									FA213HH	TBC				
25									FA213HH	TBC				
26							FA181TT		MXS181	FA181R	TBC			
27							FA181TT		MXS181	FA181R	TBC			
28							FA181TT		MXS181	FA181R	TBC			
29							FA181TT			FA181HH	MD6269D			
30							FA181TT			FA181HH	MD6269D			
31							FA181TT			FA181HH	MD6298D			
32							FA181TT			FA181HH	MD681	MD681C	VR681	
33							FA181TT			FA181HH	MD6298D			
34							FA181TT			FA181HH	MD6298D			
35							FA181TT			FA181HH	MD6298D			
36														
37							FA181TT			FA181HH	MD6298D			
38														
39							FA213			FA213HH	MD681	MD681C	VR681	
40							FA213			FA213HH	MD681	MD681C	VR681	
41							FA181TT			FA181HH	MD681	MD681C	VR681	
42							FA181TT			FA181HH	MD681	MD681C	VR681	
43							FA181TT			FA181HH	MD681	MD681C	VR681	
44							FA181TT			FA181HH	MD681	MD681C	VR681	
45							FA181TT			FA181HH	MD681	MD681C	VR681	
46							FA181TT			FA181HH	MD6424D			
47							FA181TT			FA181HH	MD6424D			
48							FA181TT			FA181HH				
49							FA266			FA266HH	MD812			
50							FA266			FA266HH	MD812			
51							FA181TT			FA181HH	MD6424D			
52							FA181TT			FA181HH	MD6424D			
53							FA266			FA266HH	MD6423D			
54										FA266HH	MD6423D			
55							FA266			FA266HH	MD6423D			
56							FA266			FA266HH	MD6423D			
57							FA181TT			FA181HH	MD6424D			
58														
59														
60														

REAR / ARRIÈRE / HINTEN / POSTERIORE / POSTERIORE

R Suffix = High Durability Sintered Pad. **HH** Suffix = High Performance Sintered Pad. **TT** Suffix = Hard Wearing Off Road Pad. **V** Suffix = Semi Sintered Pad. **G** Suffix = Grooved Shoe.
D Suffix = Drilled Disc. **X** Suffix = Universal Left or Right Disc. **XC** Suffix = Contoured Disc. **LS** Suffix = Left/Steel Disc. **RS** = Right/Steel Disc.

BRAKE APPLICATIONS

*-2 Sets Required. † For Vee disc colours add RED, BLU, GRN, GLD, ORG suffix to part number.
 Ⓢ - Also available as a Vintage Motorcycle Disc.

Non-JAPANESE Built Motorcycles



KTM Contd.



DISC PAD CHOICES - FRONT

BRAKE DISC CHOICES - FRONT

		FA, SFA, TT Pad or Brake Shoe	SFAC Carbon Scooter Pads	Semi-Sintered V-Pads™ or SXR Race Pads	Sintered/HH Pads/ Grooved Shoes	Left / Gauche / Links Standard Replacement Disc	Right / Droite / Rechts Standard Replacement Disc	Contour Disc Universal left and right fitment	Universal Custom Disc	Vee-Discs Black † See note below	CX Extreme MX Race Disc/ UTVX Disc	Line #
1290 Super Adventure R	17-20	FA244*		FA244V*	FA244HH*	MD896X	MD896X					1
1290 Super Adventure S	17-20	FA244*		FA244V*	FA244HH*	MD896X	MD896X					2
1290 Super Adventure T	17	FA244*		FA244V*	FA244HH*	MD896X	MD896X					3

NOTE: Most KTM models changed the caliper bracket design in 2009. O/E BRACKET REF 770 13 14 0 type is used in the OS/SM6932C type disc.

KYMC0

		FRONT / AVANT / VORN / FRENTE / ANTERIORE										
Activ 50	05-06	SFA197	SFAC197		SFA197HH		N/A					7
Active SR 50cc	08-11	SFA086	SFAC086		SFA086HH		N/A					8
Agility 50 (KG10SA)	05-08	SFA228	SFAC228		SFA228HH	MD971D		MD971C		VR971		9
Agility 50 Basic	07	H303										10
Agility 50 Carry (4T)	11-18	SFA305	SFAC305		SFA305HH			TBA				11
Agility City+ 50 (4T)	18-20	SFA228	SFAC228		SFA228HH	MD971D		MD971C		VR971		12
Agility 50 R10 (4T) (CV 50 QT S) 10" wheels	06-14	SFA228	SFAC228		SFA228HH	MD971D		MD971C		VR971		13
Agility 50 R12 (4T) (CK 50 QT S) 12" wheels	06-21	SFA228	SFAC228		SFA228HH	MD971D		MD971C		VR971		14
Agility 50 R16 (2T/16" wheels)	08-15	SFA305	SFAC305		SFA305HH	MD9100D				VR9100		15
Agility 50 R16 (4T/16" wheels)	08-15	SFA305	SFAC305		SFA305HH	MD9100D				VR9100		16
Agility RS 50 (2T/12" Wheels) Naked	10-15	SFA228	SFAC228		SFA228HH			MD971C		VR971		17
Agility 50 RS 4T	09-17	SFA228	SFAC228		SFA228HH	MD972D						18
Bet & Win 50/Dink Sports 50	02-06	SFA197	SFAC197		SFA197HH		MD973D			VR973		19
Calypso 50/125	99	SFA235	SFAC235			TBA						20
Cobra 50 Cross	00-06	SFA233				MD971D		MD971C		VR971		21
Cobra Racer (SF10AG)	00-06	SFA233				MD971D		MD971C		VR971		22
CX 50 (PR50AE)	93	H303										23
CX 50 Super (PR50AC)	94-97	SFA233				MD933D				VR933		24
Dink 50/Spacer 50/Yager 50 (SH10)	98-10	SFA197	SFAC197		SFA197HH		MD971D	MD971C		VR971		25
Dink 50 (4T)	07-14	SFA197	SFAC197		SFA197HH		TBA					26
Dink Classic Euro 2 50 (T8000)	03	SFA197	SFAC197		SFA197HH		MD973D			VR973		27
DJ 50 S	12-15	SFA305	SFAC305		SFA305HH	TBA						28
DJW 50 World (PR50AD)	95-97	SFA235	SFAC235			MD933D				VR933		29
DJX 50 (KA50A)	91-92	H303										30
DJY 50 Refined (PR50A)	93-06	H303										31
Filly 50 (SD10AC)	98-00	H303										32
Filly LX 50 (S210)	00-06	SFA228	SFAC228		SFA228HH	TBA						33
Grand Dink 50 (2T)	04-15	SFA197	SFAC197		SFA197HH		MD973D			VR973		34
Heroism 50 (SE10BA)	95-97	SFA235	SFAC235			MD933D				VR933		35
K-Pipe 50	12-13	FA197			FA197HH			N/A				36
KB 50 (SE10CA)	95-00	SFA233				MD933D				VR933		37
K12 Sport 50 (SE10CA)	95-00	SFA233				MD933D				VR933		38
KXR 50 Mongoose	04-06	H346*			H346G*							39
Kymcosento 50 i	13	SFA197	SFAC197		SFA197HH	TBA						40
Like 50 (2T)	09	SFA305	SFAC305		SFA305HH	MD6268D						41
Like 50 (2T)	10-20	SFA228	SFAC228		SFA228HH	MD6268D						42
Like 50 (4T)	09	SFA305	SFAC305		SFA305HH	MD6268D						43
Like 50 LX (4T)	10-15	SFA228	SFAC228		SFA228HH	MD6268D						44
Looker 50 (BA10AD) (JP)	07-08	SFA305	SFAC305		SFA305HH	MD989D						45
Looping 50	98	SFA233				TBA						46
Jetix 50	10-15	SFA086	SFAC086		SFA086HH			N/A				47
Newsento 50 i	13	SFA197	SFAC197		SFA197HH	TBA						48
Maxxer 50 (2T)	05-14	H346*			H346G*							49
MXer 50 (Quad)	00-07	H303*			H303G*							50
MXU 50 (2T)	05-13	H303*			H303G*							51
Nexxon 50	08-09	SFA086	SFAC086		SFA086HH		N/A					52
People S 50 2T (5 bolt fixing)	05-15	SFA305	SFAC305		SFA305HH	MD9100D				VR9100		53
People S 50 (4T) (B91000) 5 Bolt fixing disc	06-20	SFA305	SFAC305		SFA305HH	MD9100D				VR9100		54
People 50 (2T) (3 bolt fixing disc - BA10AD)	99-11	SFA305	SFAC305		SFA305HH	MD989D						55
Sento 50	08-15	SFA228	SFAC228		SFA228HH	TBA						56
Sniper 50 (PR50B)	93	SFA233				MD933D				VR933		57
Sniper 50 DD (PR50BB)	94-96	SFA233				MD933D				VR933		58
Super 8 (50cc) 2T	07-15	SFA305	SFAC305		SFA305HH			TBA				59
Super 8 (50cc) 4T	07-20	SFA305	SFAC305		SFA305HH			TBA				60

*-2 Sets Required. † For Vee disc colours add RED, BLU, GRN, GLD, ORG suffix to part number.

⊗ - Also available as a Vintage Motorcycle Disc.

Non-JAPANESE Built Motorcycles

Line #	BRAKE DISC CHOICES - FRONT						DISC PAD CHOICES - REAR				BRAKE DISC CHOICES - REAR			
	Oversize 250 /280mm Disc Kit	OSX Oversize 250/280mm Disc Kit	Relocating Bracket for 250/ 280mm Disc	Oversize 320mm Disc Kit	SMX Oversize 320mm Disc Kit	Relocating Bracket for 320mm Disc	FA, SFA, TT Pad or Brake Shoe	SFAC Carbon Scooter Pads	Speciality Pads - SXR / Vee / MXS	Sintered/ HH Pads/ Grooved Shoes	Standard Replacement Disc	Contour Disc Rear fitment	Vee-Discs™ CONTOUR	CX Extreme MX Race Disc/ UTVX Disc
1							FA181TT			FA181HH	TBA			
2							FA181TT			FA181HH	TBA			
3							FA181TT			FA181HH	TBA			
4														
5														
6														
7							H303							
8							H303							
9							H303							
10							H303							
11							H303							
12							H303							
13							H303							
14							H303							
15							818							
16							818							
17							H303							
18							H303							
19							H303							
20							H303							
21							H303							
22							H303							
23							H333							
24							H333							
25							H303							
26							H303							
27							H303							
28							H303							
29							H303							
30							H333							
31							H333							
32							H303							
33							H303							
34							H303							
35							H303							
36							H340							
37							H303							
38							H303							
39							H307		H307G					
40							H303							
41							H303							
42							H303							
43							H303							
44							H303							
45							818							
46							H303							
47							SFA197		SFA197HH		N/A			
48							H303							
49							H307		H307G					
50							FA305TT		FA305R	MD6267D				
51							FA305TT		FA305R	MD6267D				
52							SFA086		SFA086HH	N/A				
53							818							
54							818							
55							818							
56							H303							
57							H303							
58							SFA234			MD926D				
59							818							
60							818							

REAR / ARRIÈRE / HINTEN / POSTERIOR / POSTERIORE

R Suffix = High Durability Sintered Pad. **HH** Suffix = High Performance Sintered Pad. **TT** Suffix = Hard Wearing Off Road Pad. **V** Suffix = Semi Sintered Pad. **G** Suffix = Grooved Shoe.
D Suffix = Drilled Disc. **X** Suffix = Universal Left or Right Disc. **XC** Suffix = Contoured Disc. **LS** Suffix = Left/Steel Disc. **RS** = Right/Steel Disc.

*-2 Sets Required. † For Vee disc colours add RED, BLU, GRN, GLD, ORG suffix to part number.
 Ⓢ - Also available as a Vintage Motorcycle Disc.

Part numbers, prefixes, suffixes, photos and illustrations shown in this catalogue are trademarks and/or copyrights of EBC Brakes or the trademark owner A C Freeman Investments Ltd and use without express written permission of the owners is punishable by law.

Non-JAPANESE Built Motorcycles



KYMCO Contd.



DISC PAD CHOICES - FRONT

BRAKE DISC CHOICES - FRONT

R Suffix = High Durability Sintered Pad. **HH** Suffix = High Performance Sintered Pad. **TT** Suffix = Hard Wearing Off Road Pad. **V** Suffix = Semi Sintered Pad. **G** Suffix = Grooved Shoe.

D Suffix = Drilled Disc. **X** Suffix = Universal Left or Right Disc. **XC** Suffix = Contoured Disc. **LS** Suffix = Left/Steel Disc. **RS** = Right/Steel Disc.

FRONT / AVANT / VORN / FRENTE / ANTERIORE

		FA, SFA, TT Pad or Brake Shoe	SFAC Carbon Scooter Pads	Speciality Pads - SXR / Vee / MXS	Sintered/HH Pads/ Grooved Shoes	Left / Gauche / Links Standard Replacement Disc	Right / Droite / Rechts Standard Replacement Disc	Contour Disc Universal left and right fitment	Universal Custom Disc	Vee-Disks Black † See note below	CX Extreme MX Race Disc/ UTVX Disc	Line #
Super 9 50 (LC) (SH10DA)	00-07	SFA197	SFAC197		SFA197HH		MD981D			VR981		1
Super 9 (A/C)	00-07	SFA197	SFAC197		SFA197HH		MD981D			VR981		2
Visa R 50	11-15	SFA067	SFAC067		SFA067HH		N/A					3
Vitality 50 (4T) (U31000)	04-09	SFA228	SFAC228		SFA228HH	MD971D		MD971C		VR971		4
Vitality 50 (2T) (SF10FA)	04-09	SFA228	SFAC228		SFA228HH	MD971D		MD971C		VR971		5
Yup 50	02-09	SFA228	SFAC228		SFA228HH	MD971D		MD971C		VR971		6
ZX 50 Super Fever/Scout (SC10AS) (ZX12)	99-06	SFA233				MD971D		MD971C		VR971		7
Top Boy 50 (On road & off road models) (SF10GG)	97-06	SFA233				MD971D		MD971C		VR971		8
Yager 50	07	SFA197	SFAC197		SFA197HH		MD971D	MD971C		VR971		9
KXR 90/S Mongoose Quad	04-20	H346*			H346G*							10
Maxxer 90	05-06	H346*			H346G*							11
Cobra 100 Racer	99-03	SFA228	SFAC228		SFA228HH	TBA						12
KB 100 Manboy	97-00	SFA233				MD933D				VR933		13
Spike 100/125	00-06	SFA086	SFAC086		SFA086HH		N/A					14
Top Boy 100 (On road & off road models)	97	SFA233				TBA						15
Activ 110/125	04-06	SFA197	SFAC197		SFA197HH		N/A					16
Visa - R 110	11-15	SFA067	SFAC067		SFA067HH		N/A					17
Agility 125 Carry (4T)	11-15	SFA305	SFAC305		SFA305HH			TBA				18
Agility 125 4T (U62000/1 - 12" Wheels/3 Spoke)	06-14	SFA228	SFAC228		SFA228HH	MD971D		MD971C		VR971		19
Agility 125 (C20000 - 16" Wheels)	08-15	SFA305	SFAC305		SFA305HH	MD9100D				VR9100		20
Agility City 125	18-21	SFA305	SFAC305		SFA305HH	MD9100D				VR9100		21
Agility City+ 125	18-21	SFA305	SFAC305		SFA305HH	MD9100D				VR9100		22
Agility RS 125 (2T-12" wheels/5 Spoke)	09-13	SFA305	SFAC305		SFA305HH		TBA					23
Agility RS 125 (4T-12" wheels/5 Spoke)	10-15	SFA228	SFAC228		SFA228HH			N/A				24
Bet & Win 125/150 (SH25CA/30C)	00-06	SFA197	SFAC197		SFA197HH		MD973D			VR973		25
CK1 125 (4T/KT25AA)	14-15	FA197			FA197HH		N/A					26
CK 125 Pulsar	99-00	FA486					N/A					27
CK 125 Pulsar (KJ25CB)	01-07	FA197			FA197HH		N/A					28
CK 125 Pulsar 11 (KE25RF)	08-10	FA197			FA197HH		N/A					29
CK 125 Pulsar S	11-15	FA197			FA197HH		N/A					30
Cruiser 125	99	FA197			FA197HH		TBA					31
Dink Classic 125/150 (SH25BB/30B)	02	SFA197	SFAC197		SFA197HH		MD973D			VR973		32
Dink/Spacer 125/150 (SH25/30)	97-04	SFA197	SFAC197		SFA197HH		MD971D	MD971C		VR971		33
Dink LX 125/150 (SH25BA/30B)	98-00	SFA197	SFAC197		SFA197HH	MD971D		MD971C		VR971		34
Dink 125i (T90000)	06-15	SFA197	SFAC197		SFA197HH		TBA					35
Downtown 125 i/Super Dink (V21000)	09-15	SFA142	SFAC142		SFA142HH			N/A		VR9128		36
New Downtown 125i	15-19	SFA324	SFAC324		SFA324HH			N/A		VR9128		37
DJ 125 S	12-13	SFA305	SFAC305		SFA305HH	TBA						38
Grand Dink/Miler 125/150 (S40000-00)	01-07	SFA197	SFAC197		SFA197HH		MD973D			VR973		39
Grand Dink 125	12-15	SFA142	SFAC142		SFA142HH		TBA					40
Heroism 125 (SE25BA)	95-97	SFA235	SFAC235			MD933D				VR933		41
Heroism 150 (SE30AD)	95-97	SFA235	SFAC235			MD933D				VR933		42
Hipster 125/150	99-06	FA197			FA197HH		N/A					43
K-Pipe 125	12-21	FA197			FA197HH		TBA					44
K-XCT 125 i	12-15	SFA142	SFAC142		SFA142HH			N/A		VR9128		45
KR 125 Quannon Naked	10-15	FA197			FA197HH		N/A					46
KR 125 Quannon Sport	07-13	FA197			FA197HH		N/A					47
Like 125	09	SFA305	SFAC305		SFA305HH	TBA	MD6268D					48
Like 125 LX	10-20	SFA228	SFAC228		SFA228HH	TBA						49
Looker 125 S (BA25BA (JP))	07-08	SFA305	SFAC305		SFA305HH	MD989D						50
Jetix 125	10-15	SFA086	SFAC086		SFA086HH			N/A				51
Movie 125 (SL25AA)	99-00	SFA228	SFAC228		FA228HH	MD972D						52
Movie XL 125/150 (S510/500)	01-09	SFA197	SFAC197		SFA197HH		MD973D			VR973		53
Movie 125 i	12-13	SFA197	SFAC197		SFA197HH		TBA					54
MXer 125/150 Quad (LA35AD/LA30AD)	02-07	H303*				H303G*						55
Nexxon 125	07-08	SFA086	SFAC086		SFA086HH		N/A					56
People GT 125 i	10-20	SFA324	SFAC324		SFA324HH		TBA					57
People S 125 (BA25BA) (5 bolt disc fixing)	05-06	SFA305	SFAC305		SFA305HH	MD9100D				VR9100		58
People S 125 DD (D1000 rear disc model) (5 bolt fixing)	07-20	SFA305	SFAC305		SFA305HH	MD9100D				VR9100		59
People 125 (B20000/10/11) (3 bolt disc fixing)	99-14	SFA305	SFAC305		SFA305HH	MD989D						60

*-2 Sets Required. † For Vee disc colours add RED, BLU, GRN, GLD, ORG suffix to part number.

⊗ - Also available as a Vintage Motorcycle Disc.

Non-JAPANESE Built Motorcycles

Line #	BRAKE DISC CHOICES - FRONT						DISC PAD CHOICES - REAR				BRAKE DISC CHOICES - REAR			
	Oversize 250 /280mm Disc Kit	OSX Oversize 250/280mm Disc Kit	Relocating Bracket for 250/ 280mm Disc	Oversize 320mm Disc Kit	SMX Oversize 320mm Disc Kit	Relocating Bracket for 320mm Disc	FA, SFA, TT Pad or Brake Shoe	SFAC Carbon Scooter Pads	Speciality Pads - SXR / Vee / MXS	Sintered/ HH Pads/ Grooved Shoes	Standard Replacement Disc	Contour Disc Rear fitment	Vee-Discs™ CONTOUR	CX Extreme MX Race Disc/ UTVX Disc
1							SFA305	SFAC305		SFA305HH	MD971D		VR971	
2							H303							
3							H303							
4							H303							
5							H303							
6							H303							
7							H303							
8							H303							
9							H303							
10							FA305TT			FA305R	MD6267D			
11							FA305TT			FA305R	MD6267D			
12							H303							
13							H303							
14							TBA				N/A			
15							H303							
16							H303							
17							H303							
18							H303							
19							818							
20							SFA067	SFAC067		SFA067HH	MD9129D			
21							SFA067	SFAC067		SFA067HH				
22							SFA067	SFAC067		SFA067HH				
23							818							
24							818							
25							SFA197	SFAC197		SFA197HH	MD974D		VR974	
26							H307							
27							H310							
28							H340							
29							H307							
30							H307							
31							TBA							
32							SFA197	SFAC197		SFA197HH	MD971D		VR971	
33							SFA197	SFAC197		SFA197HH	MD971D	MD971C	VR971	
34							SFA197	SFAC197		SFA197HH	MD971D	MD971C	VR971	
35							SFA197	SFAC197		SFA197HH	MD974D		VR974	
36							SFA498	SFAC498		SFA498HH	MD9129D		VR9129	
37							SFA607			SFA607HH	MD9129D		VR9129	
38							H303							
39							SFA197	SFAC197		SFA197HH	MD974D		VR974	
40							SFA197	SFAC197		SFA197HH	TBA			
41							H303							
42							SFA234				MD926D			
43							H340							
44							H340							
45							SFA607			SFA607HH		N/A		
46							FA197			FA197HH	N/A			
47							FA197			FA197HH	N/A			
48							SFA197	SFAC197		SFA197HH	TBA			
49							SFA197	SFAC197		SFA197HH	TBA			
50							818							
51							SFA197	SFAC197		SFA197HH		N/A		
52							818							
53							818							
54							TBA							
55								FA305TT			FA305R	MD6267D		
56							SFA086	SFAC086		SFA086HH	N/A			
57							SFA607			SFA607HH	SFA607HH			
58							818							
59							SFA607			SFA607HH	MD9100D			
60							818							

REAR / ARRIÈRE / HINTEN / POSTERIOR / POSTERIORE

R Suffix = High Durability Sintered Pad. HH Suffix = High Performance Sintered Pad. TT Suffix = Hard Wearing Off Road Pad. V Suffix = Semi Sintered Pad. G Suffix = Grooved Shoe.
D Suffix = Drilled Disc. X Suffix = Universal Left or Right Disc. XC Suffix = Contoured Disc. LS Suffix = Left/Steel Disc. RS = Right/Steel Disc.

*-2 Sets Required. † For Vee disc colours add RED, BLU, GRN, GLD, ORG suffix to part number.
⊗ - Also available as a Vintage Motorcycle Disc.

Part numbers, prefixes, suffixes, photos and illustrations shown in this catalogue are trademarks and/or copyrights of EBC Brakes or the trademark owner A C Freeman Investments Ltd and use without express written permission of the owners is punishable by law.

Non-JAPANESE Built Motorcycles



KYMCO Contd.



DISC PAD CHOICES - FRONT

BRAKE DISC CHOICES - FRONT

R Suffix = High Durability Sintered Pad. **HH** Suffix = High Performance Sintered Pad. **TT** Suffix = Hard Wearing Off Road Pad. **V** Suffix = Semi Sintered Pad. **G** Suffix = Grooved Shoe.

D Suffix = Drilled Disc. **X** Suffix = Universal Left or Right Disc. **XC** Suffix = Contoured Disc. **LS** Suffix = Left/Steel Disc. **RS** = Right/Steel Disc.

FRONT / AVANT / VORN / FRENTE / ANTERIORE

Model	Year	DISC PAD CHOICES - FRONT				BRAKE DISC CHOICES - FRONT					Line #	
		FA, SFA, TT Pad or Brake Shoe	SFAC Carbon Scooter Pads	Speciality Pads - SXR / Vee / MXS	Sintered/HH Pads/ Grooved Shoes	Left / Gauche / Links Standard Replacement Disc	Right / Droite / Rechts Standard Replacement Disc	Contour Disc Universal left and right fitment	Universal Custom Disc	Vee-Discs Black † See note below		CX Extreme MX Race Disc/ UTVX Disc
People One 125i	13-15	SFA305	SFAC305		SFA305HH	N/A						1
People One 125i	16-19	SFA603										2
Sector 125	98-01	FA197			FA197HH		N/A					3
Spike 125 R	04-06	SFA197	SFAC197		SFA197HH	N/A						4
Straight 125	05-06	FA197			FA197HH	N/A						5
Stryker 125 (DA25BB) On Road/Off Road	01-06	FA228			FA228HH	N/A						6
Super 8 4T (125cc)	08-15	SFA305	SFAC305		SFA305HH			TBA		VR9128		7
X Town 125i ABS	16-20	SFA324	SFAC324		SFA324HH					VR9128		8
Yager 125	00	SFA197	SFAC197		SFA197HH		MD971D	MD971C		VR971		9
Yager GT 125	07-13	SFA197	SFAC197		SFA197HH		TBA					10
MXU 150	05-20	H303*			H303G*							11
Stryker 150 (Off road)	00-06	FA228			FA228HH	N/A						12
Visar - R 125	11-15	SFA067	SFAC067		SFA067HH		N/A					13
Vivio 125/150 (SL25BA/30AC)	00-03	SFA228	SFAC228		SFA228HH		MD972D					14
Zing 125/150 Custom Style (RF25/30)	97-13	FA197			FA197HH		N/A					15
Agility 150 R16 (C30000)	08-12	SFA305	SFAC305		SFA305HH	MD9100D				VR9100		16
Jetix 150	10	SFA086	SFAC086		SFA086HH			N/A				17
Like 150 i ABS	20-21	SFA305	SFAC305		SFA305HH	TBA	MD6268D					18
Like 150 i Noodoe ABS	20-21	SFA305	SFAC305		SFA305HH	TBA	MD6268D					19
MXU 150	05-20	H303			H303G							20
People 150 (B200001/20) (3 bolt disc fixing)	99-04	SFA305	SFAC305		SFA305HH		MD989D					21
Spade 150 I	20-21	FA197			FA197HH							22
Stryker 150 Off Road	00-06	FA228			FA228HH							23
Super 8 150 X	19-21	SFA228	SFAC228		SFA228HH		MD972D					24
Agility 200 i R16	10-15	SFA305	SFAC305		SFA305HH	MD9100D				VR9100		25
Dink 200i (T91000)	06-15	SFA197	SFAC197		SFA197HH		TBA					26
Downtown 200 i	10-15	SFA142	SFAC142		SFA142HH			N/A		VR9128		27
People GT 200 i	10-15	SFA324	SFAC324		SFA324HH		TBA					28
Like 200i	09	SFA305	SFAC305		SFA305HH	MD6268D						29
Like 200i LX	10-15	SFA228	SFAC228		SFA228HH	TBA						30
People S 200 (D11000) (5 bolt fixing disc)	05-06	SFA305	SFAC305		SFA305HH	MD9100D				VR9100		31
People S 200i DD (D12000) (5 bolt fixing disc F/Disc - Rear Disc Model)	07-15	SFA305	SFAC305		SFA305HH	MD9100D				VR9100		32
Yager 200i	07-13	SFA197	SFAC197		SFA197HH		TBA					34
Bet & Win 250 (S7000)	00-06	SFA197	SFAC197		SFA197HH		MD973D			VR973		35
Grand Dink 250 (S400)	01-06	SFA355*	SFAC355*		SFA355HH*		MD973D			VR973		36
KXR 250 Mongoose Quad	04-07	FA377TT*			FA377R*	MD6267D	MD6267D					37
Maxxer 250	12-13	FA377TT*			FA377R*	MD6267D	MD6267D					38
MXU 250	04-13	FA377TT*			FA377R*	MD6267D	MD6267D					39
MXU 250 R	12-13	FA377TT*			FA377R*	MD6267D	MD6267D					40
People 250 (BC50AA)	03-06	SFA197	SFAC197		SFA197HH		MD9100D			VR9100		41
People 250 Si DD Left	07-08	SFA228	SFAC228		SFA228HH	MD9100D	MD9100D			VR9100		42
People 250 Si DD Right		SFA197	SFAC197		SFA197HH					VR9100		43
Urban Quad 250	06	FA377TT*			FA377R*	TBA	TBA					44
Xciting 250 (T71000)	05	SFA142*	SFAC142*		SFA142HH*	TBA	TBA					45
Xciting 250 i (T71010)	06-08	SFA142*	SFAC142*		SFA142HH*	TBA	TBA					46
Venox 250 (R20010/RA50AA/Carb Model)	00-03	FA196			FA196HH	MD1101						47
Venox 250 (RFBR20011/RA500AD/Carb Model)	04-06	FA196			FA196HH	MD1101						48
Venox 250 (R20012/EFI Model)	00-14	FA196			FA196HH	MD1101						49
Yup 250 (W2000)	03-06	SFA197	SFAC197		SFA197HH		MD973D			VR973		50
Mongoose 270cc inc Euro	20-21	FA377TT			FA377R							51
MXU 270cc I Euro	20-21	FA377TT			FA377R							52
Agility Maxi 300i ABS	15	SFA324	SFAC324		SFA324HH			TBA				53
AK 300i ABS	19-20	FA630*		FA630V*	FA630HH*							54
Downtown 300 i/Super Dink (V20000)	09-12	SFA142	SFAC142		SFA142HH			N/A		VR9128		55
Downtown 300i/ABS	10-15	SFA142	SFAC142		SFA142HH			N/A		VR9128		56
Grand Dink 300 i	12-20	SFA142	SFAC142		SFA142HH		MD973D			VR973		57
K-XCT 300 i	12-15	SFA324	SFAC324		SFA324HH			N/A		VR9128		58
Maxxer 300	06-13	FA377TT*			FA377R*	MD6267D	MD6267D					59
MXU 300	06-21	FA377TT*			FA377R*	MD6267D	MD6267D					60

*-2 Sets Required. † For Vee disc colours add RED, BLU, GRN, GLD, ORG suffix to part number.

⊗ - Also available as a Vintage Motorcycle Disc.

Non-JAPANESE Built Motorcycles

Line #	BRAKE DISC CHOICES - FRONT						DISC PAD CHOICES - REAR				BRAKE DISC CHOICES - REAR			
	Oversize 250 /280mm Disc Kit	OSX Oversize 250/280mm Disc Kit	Relocating Bracket for 250/ 280mm Disc	Oversize 320mm Disc Kit	SMX Oversize 320mm Disc Kit	Relocating Bracket for 320mm Disc	FA, SFA, TT Pad or Brake Shoe	SFAC Carbon Scooter Pads	Speciality Pads - SXR / Vee / MXS	Sintered/ HH Pads/ Grooved Shoes	Standard Replacement Disc	Contour Disc Rear fitment	Vee-Discs™ CONTOUR	CX Extreme MX Race Disc/ UTVX Disc
1							818							
2														
3							TBA							
4							SFA197	SFAC197		SFA197HH	MD971D			
5							N/A							
6							H340							
7							818							
8							SFA607			SFA607HH	MD9129D		VR9129	
9							SFA197	SFAC197		SFA197HH	MD971D	MD971C	VR971	
10							SFA197	SFAC197		SFA197HH	MD974D			
11							FA305TT			FA305R	MD6267D			
12							H340							
13							H303							
14							818							
15							H340							
16							SFA197	SFAC197		SFA197HH	MD9129D		VR9129	
17							SFA197	SFAC197		SFA197HH		N/A		
18							SFA197	SFAC197		SFA197HH		TBA		
19							SFA197	SFAC197		SFA197HH		TBA		
20							FA305TT			FA305R	MD6267D			
21							818							
22							H340							
23							H340							
24							818							
25							SFA197	SFAC197		SFA197HH	MD9129D		VR9129	
26							SFA197	SFAC197		SFA197HH	MD974D			
27							SFA498	SFAC498		SFA498HH	MD9129D		VR9129	
28							SFA607			SFA607HH	TBA			
29							SFA197	SFAC197		SFA197HH	TBA			
30							SFA197	SFAC197		SFA197HH	TBA			
31							818							
32														
33							SFA607			SFA607HH	MD9100D			
34							SFA197	SFAC197		SFA197HH	MD974D			
35							SFA197	SFAC197		SFA197HH	MD974D		VR974	
36							SFA356			SFA356HH	MD974D		VR974	
37							FA355/4TT			FA355/4R	MD6268D			
38							FA377TT			FA377R	MD6267D			
39							FA355/4TT			FA355/4R	MD6268D			
40							FA377TT			FA377R	MD6267D			
41							SFA142	SFAC142		SFA142HH	MD9100D			
42							SFA607			SFA607HH	MD9100D			
43														
44							FA355/4TT			FA355/4R	TBA			
45							SFA607			SFA607HH	TBA			
46							SFA607			SFA607HH	TBA			
47							H321							
48							H321							
49							H321							
50							SFA197	SFAC197		SFA197HH	MD974D		VR974	
51							FA377TT			FA377R				
52							FA377TT			FA377R				
53							SFA607			SFA607HH		TBA		
54							SFA719			SFA719HH				
55							SFA498	SFAC498		SFA498HH	MD9129D		VR9129	
56							SFA498	SFAC498		SFA498HH	MD9129D		VR9129	
57							SFA607			SFA607HH	MD9129D	N/A	VR9129	
58							SFA607			SFA607HH		N/A		
59							FA355/4TT			FA355/4R	MD6268D			
60							FA377TT*			FA377R*	MD6267D			

REAR / ARRIÈRE / HINTEN / POSTERIOR / POSTERIORE

R Suffix = High Durability Sintered Pad. **HH** Suffix = High Performance Sintered Pad. **TT** Suffix = Hard Wearing Off Road Pad. **V** Suffix = Semi Sintered Pad. **G** Suffix = Grooved Shoe.
D Suffix = Drilled Disc. **X** Suffix = Universal Left or Right Disc. **XC** Suffix = Contoured Disc. **LS** Suffix = Left/Steel Disc. **RS** = Right/Steel Disc.

*-2 Sets Required. † For Vee disc colours add RED, BLU, GRN, GLD, ORG suffix to part number.
 Ⓞ - Also available as a Vintage Motorcycle Disc.

Non-JAPANESE Built Motorcycles



KYMCO Contd.

DISC PAD CHOICES - FRONT

BRAKE DISC CHOICES - FRONT

R Suffix = High Durability Sintered Pad. HH Suffix = High Performance Sintered Pad. TT Suffix = Hard Wearing Off Road Pad. V Suffix = Semi Sintered Pad. G Suffix = Grooved Shoe.
 D Suffix = Drilled Disc. X Suffix = Universal Left or Right Disc. LS Suffix = Left/Steel Disc. RS Suffix = Right/Steel Disc.

AK Suffix = Contoured Disc. XC Suffix = Contoured Disc. Suffix = Left/Steel Disc. Suffix = Right/Steel Disc.

Model	Left	Right	DISC PAD CHOICES - FRONT				BRAKE DISC CHOICES - FRONT					Line #
			FA, SFA, TT Pad or Brake Shoe	SFAC Carbon Scooter Pads	Speciality Pads - SXR / Vee / MXS	Sintered/HH Pads/ Grooved Shoes	Left / Gauche / Links Standard Replacement Disc	Right / Droite / Rechts Standard Replacement Disc	Contour Disc Universal left and right fitment	Universal Custom Disc	Vee-Discs Black † See note below	
MXU 300 R			FA377TT*			FA377R*	MD6267D	MD6267D				1
People GT 300 i			SFA324	SFAC324		SFA324HH		TBA				2
People GT 300i ABS Euro 4			SFA324	SFAC324		SFA324HH						3
People S 300i	Left	08-10	SFA228	SFAC228		SFA228HH	MD9100D	MD9100D		VR9100		4
	Right		SFA197	SFAC197		SFA197HH				VR9100		5
People S 300i ABS Euro 4		19	SFA324	SFAC324		SFA324HH		MD9100D				6
Xciting 300i (T72000 - EFI Model)		08	SFA142*	SFAC142*		SFA142HH*	TBA	TBA				7
Xciting 300i R (T72001/T72011)		09-14	SFA142*	SFAC142*		SFA142HH*			TBA*			8
X Town 300i ABS		17-20	SFA324	SFAC324		SFA324HH						9
Downtown 350i		15-20	SFA324	SFAC324		SFA324HH			N/A	VR9128		10
Maxxer 400		09-10	FA395TT*			FA395R*	MD6173D	MD6173D				11
Maxxer 400 - Parking brake		09-10	SFA257/2									12
MXU 400 (A40000)		08-11	FA395TT*			FA395R*	MD6173D	MD6173D				13
MXU 400 (A40000) - Parking brake		08-11	SFA257/2									14
UXV 450i (Side X Side)		15-21	FA377TT*			FA377R*	N/A	N/A				15
Xciting 400i		12-20	SFA432*			SFA432HH*	MD9174D	MD9174D	TBA*			16
Xciting S 400i		17-20	SFA432*			SFA432HH*	MD9174D	MD9174D	TBA*			17
Maxxer 450 i (4T/On & Off Road Models)		10-18	FA395TT*			FA395R*	MD6173D	MD6173D				18
Maxxer 450 i (4T/On & Off Road Models) - Parking brake		10-18	SFA257/2									19
MXU 450 i IRS		11-12	FA395TT*			FA395R*	MD6173D	MD6173D				20
MXU 450 i		13-21	FA395TT*			FA395R*	TBA	TBA				21
MXU 450 i - Parking brake		13-21	SFA257/2									22
MXU 450i LE		20-21	FA395TT*			FA395R*						23
MXU 450 LE - Parking brake		20-21	SFA257/2									24
MXU 450 LE Prime		20-21	FA395TT*			FA395R*						25
MXU 450 LE Prime - Parking brake		20-21	SFA257/2									26
MXU 500 (L70000/Carb Model/4x4)		05-09	FA377TT*			FA377R*	MD6195D	MD6195D				27
MXU 500 i DX		12-13	FA600TT*			FA600R*	MD6173D	MD6173D				28
MXU 500 i DX - Parking brake		12-13	FA377									29
MXU 500 i IRS (4x4 - IRS) (LAAOCD/CM)		09-14	FA600TT*			FA600R*	MD6173D	MD6173D				30
MXU 500 i IRS (4x4 - IRS) (LAAOCD/CM) - Parking brake		09-14	FA377TT									31
UXV 500 (Side x Side/4x4/U10000)		08-21	FA377TT*			FA377R*	TBA	TBA				32
UXV 500 i (Side x Side/4x4/U10100)		13-21	FA377TT*			FA377R*	TBA	TBA				33
Xciting 500 (T70000 - Carb Model)		05	SFA142*	SFAC142*		SFA142HH*	TBA	TBA				34
Xciting 500 i (T70020 - EFI Model)		06-08	SFA142*	SFAC142*		SFA142HH*	TBA	TBA				35
Xciting 500i R (T70030 - EFI Model)		07-09	SFA142*	SFAC142*		SFA142HH*	TBA	TBA				36
Xciting 500i R (T70021 - EFI Model)		07-15	SFA142*	SFAC142*		SFA142HH*			TBA*			37
Xciting Evo 500i ABS		13	SFA142*	SFAC142*		SFA142HH*			N/A*			38
AK 550		17-20	FA630*		FA630V*	FA630HH*	MD9174D	MD9174D				39
MXU 550 i		12-15	FA600TT*			FA600R*	MD6173D	MD6173D				40
MXU 550 i - Parking brake		12-15	FA377TT									41
MXU 550 I (4x4 LoF)		13-15	FA600TT*			FA600R*	MD6173D	MD6173D				42
MXU 550 I (4x4 LoF) - Parking brake		13-15	FA377TT									43
My Road 700 i		11-15	SFA142*	SFAC142*		SFA142HH*	N/A	N/A				44
MXU 700 i (4x4 LoF)		13-18	FA600TT*			FA600R*	N/A	N/A				45
MXU 700 i (4x4 LoF) - Parking brake		13-15	FA377TT									46
UXV 700 i (Turf)		14-21	FA600TT*			FA600R*	MD6173D	MD6173D				47
UXV 700 i (Turf) - Parking brake		14-15	FA377TT									48
												49
												50
LAMBRETTA												51
LJ 50		12-13	SFA264	SFAC264		SFA264HH	TBA					52
LT 50		12-13	SFA264	SFAC264		SFA264HH	TBA					53
50 N Pato		08-10	SFA086	SFAC086		SFA086HH	TBA					54
125 N Pato		08-10	SFA086	SFAC086		SFA086HH	TBA					55
125/150/175 L1			958									56
125/150/200 DL			959									57
LN 125 (4T)		11-13	SFA264	SFAC264		SFA264HH	TBA					58
LN 151 (4T)		11-13	SFA264	SFAC264		SFA264HH	TBA					59
151 N Pato		08-10	SFA086	SFAC086		SFA086HH	TBA					60
175 TV II			FA100				N/A					60

*-2 Sets Required. † For Vee disc colours add RED, BLU, GRN, GLD, ORG suffix to part number.

⊗ - Also available as a Vintage Motorcycle Disc.

Non-JAPANESE Built Motorcycles

Line #	BRAKE DISC CHOICES - FRONT						DISC PAD CHOICES - REAR				BRAKE DISC CHOICES - REAR			
	OverSize 250 /280mm Disc Kit	OSX OverSize 250/280mm Disc Kit	Relocating Bracket for 250/ 280mm Disc	OverSize 320mm Disc Kit	SMX OverSize 320mm Disc Kit	Relocating Bracket for 320mm Disc	FA, SFA, TT Pad or Brake Shoe	SFAC Carbon Scooter Pads	Speciality Pads - SXR / Vee / MXS	Sintered/ HH Pads/ Grooved Shoes	Standard Replacement Disc	Contour Disc Rear fitment	Vee-Discs™ CONTOUR	CX Extreme MX Race Disc/ UTVX Disc
1							FA377TT			FA377R	MD6267D			
2							SFA607			SFA607HH	TBA			
3							SFA607			SFA607HH				
4							SFA607			SFA607HH	MD9100D			
5														
6														
7							SFA607			SFA607HH	TBA			
8							SFA607			SFA607HH		N/A		
9							SFA607			SFA607HH	MD9129D		VR9129	
10							SFA607			SFA607HH	MD9129D		VR9129	
11							FA395TT			FA395R	MD6173D			
12														
13							FA395TT			FA395R	MD6173D			
14														
15							FA377TT*			FA377R*	N/A			
16							SFA608			SFA608HH		N/A		
17							SFA608			SFA608HH		N/A		
18							FA395TT			FA395R	MD6173D			
19														
20							FA395TT			FA395R	MD6173D			
21							FA395TT			FA395R	TBA			
22														
23							FA395TT			FA395R				
24														
25							FA395TT			FA395R				
26														
27							FA377TT*			FA377R*	TBA			
28							FA600/2TT			FA600/2R	TBA			
29														
30							FA600/2TT			FA600/2R	TBA			
31														
32							FA377TT			FA377R	MD6376D		UTVX6376	
33							FA377TT			FA377R	MD6376D		UTVX6376	
34							SFA608			SFA608HH	TBA			
35							SFA608			SFA608HH	TBA			
36							SFA608			SFA608HH	TBA			
37							SFA608			SFA608HH		TBA		
38							SFA608			SFA608HH		N/A		
39							SFA719			SFA719HH	MD9173D			
40							FA600/2TT			FA600/2R	TBA			
41														
42							FA600/2TT			FA600/2R	TBA			
43														
44							SFA608			SFA608HH		N/A		
45							FA600/2TT*			FA600/2R*	N/A			
46														
47							FA600/2TT			FA600/2R	TBA			
48														
49														
50														
51							TBA							
52							TBA							
53							SFA086	SFAC086		SFA086HH	TBA			
54							SFA086	SFAC086		SFA086HH	TBA			
55							958							
56							959							
57							TBA							
58							TBA							
59							SFA086	SFAC086		SFA086HH	TBA			
60							958							

REAR / ARRIÈRE / HINTEN / POSTERIOR / POSTERIORE

R Suffix = High Durability Sintered Pad. HH Suffix = High Performance Sintered Pad. TT Suffix = Hard Wearing Off Road Pad. V Suffix = Semi Sintered Pad. G Suffix = Grooved Shoe.
D Suffix = Drilled Disc. X Suffix = Universal Left or Right Disc. XC Suffix = Contoured Disc. LS Suffix = Left/Steel Disc. RS = Right/Steel Disc.

*-2 Sets Required. † For Vee disc colours add RED, BLU, GRN, GLD, ORG suffix to part number.
⊗ - Also available as a Vintage Motorcycle Disc.

Part numbers, prefixes, suffixes, photos and illustrations shown in this catalogue are trademarks and/or copyrights of EBC Brakes or the trademark owner A C Freeman Investments Ltd and use without express written permission of the owners is punishable by law.

Non-JAPANESE Built Motorcycles



LAVERDA



DISC PAD CHOICES - FRONT

BRAKE DISC CHOICES - FRONT

FA, SFA, TT Pad or Brake Shoe	SFAC Carbon Scooter Pads	Semi-Sintered V-Pads™	Sintered/HH Pads/ Grooved Shoes	Left / Gauche / Links Standard Replacement Disc	Right / Droite / Rechts Standard Replacement Disc	Contour Disc Universal left and right fitment	Universal Custom Disc	Vee-Discs Black † See note below	CX Extreme MX Race Disc
CR 50 Atlas			FA047HH	N/A					
Quasar 50			H338*	H338G*					
Quasar 100			H338*	H338G*					
GS 125 Lesmo			FA047*	FA047HH*	N/A	N/A			
LB 125 Custom/Sabbia Strada/Sport			FA060		N/A				
LZ 125 Sport Brembo Caliper			FA047	FA047HH	N/A				
LZ 125 Sport Grimeca Caliper			FA076	FA076HH	N/A				
Phoenix 125/150/200		SFAC306	SFA306		N/A				
Quasar 125 HP Grip			H338*	H338G*					
Quasar 125 HP			H338*	H338G*					
Quasar 180 HP Grip			H338*	H338G*					
Quasar 180 HP			H338*	H338G*					
Quasar 4x4 400			FA271TT*	FA271R*	MD6173D	MD6173D			
Montjuic			FA047*	FA047HH*	N/A	N/A			
Alpino 500			FA047*	FA047HH*	N/A	N/A			
Quasar 4x4 500C			FA271TT*	FA271R*	MD6173D	MD6173D			
Quasar 4x4 500			FA271TT*	FA271R*	MD6173D	MD6173D			
650 All models			FA095*	FA095V*	MD2003X	MD2003X	MD2003XC*	MD2003CC*	VR2003BLK*
668 All models			FA095*	FA095V*	MD2003X	MD2003X	MD2003XC*	MD2003CC*	VR2003BLK*
750 SF2			FA018*	FA018V*	MD609LS	MD609RS			
750 SFC			FA018*	FA018V*	MD609LS	MD609RS			
750 SF3			FA018*	FA018V*	MD609LS	MD609RS			
750 All models			FA095*	FA095V*	MD2003X	MD2003X	MD2003XC*	MD2003CC*	VR2003BLK*
1000 3C			FA018*	FA018V*	MD609LS	MD609RS			
1000 3CL			FA018*	FA018V*	MD609LS	MD609RS			
1000 3CL Jarama/Jota			FA018*	FA018V*	MD609LS	MD609RS			
1000 RGS			FA018*	FA018V*	MD609LS	MD609RS			
1000 RGA/RGS Exec			FA018*	FA018V*	MD609LS	MD609RS			
1000 RGS Corsa			FA077*	FA077V*	MD609ALS	MD609ARS			
1000 SFC			FA018*	FA018V*	FA018HH*	MD668LS	MD668RS		
SFC 1000			FA018*	FA018V*	FA322/4HH*	MD621X	MD621X	MD621XC*	VR621BLK*
1200			FA018*	FA018V*	FA018HH*	MD609LS	MD609RS		
1200 TS/Mirage			FA018*	FA018V*	FA018HH*	MD609LS	MD609RS		
Disc ring only for early 280mm disc, 9 bolt fixing - 6.5mm thickness					MD670	MD670			
LEM									
R2/R3 (Hydraulic System)				FA325R	N/A				
Four X Pro			SFA169	SFAC169	SFA169HH	N/A			
RX 65			FA325TT		FA325R	N/A			
RX3 9873			FA325TT		FA325R	N/A			
CX3 9873			FA325TT		FA325R	N/A			
LEONART									
Bobber 125			FA086*		FA086HH*		N/A*		
Bobber 350			FA086*		FA086HH*		N/A*		
Daytona 125			FA086*		FA086HH*		N/A*		
Daytona 350			FA086*		FA086HH*		N/A*		
Raptor 125			FA086*		FA086HH*		N/A*		
Raptor 350			FA086*		FA086HH*		N/A*		
Spyder 125			FA086*		FA086HH*		N/A*		
Spyder 350			FA086*		FA086HH*		N/A*		
LEXMOTO									
FMR 50 (WY50QT-58R)			FA086			MD925D	MD25C	VR925	
LSM 50 (STR50)			SFA086	SFAC086	SFA086HH	MD6124D	MD6124C		MD6124CX
Milano 50 (FT50QT-27)			SFA086	SFAC086	SFA086HH				
Molly 50 (DFE50QT-3)			SFA169	SFAC169	SFA169HH	MD904D		VR904	
Adrenaline 125 XFLM125GY-2B			FA135TT		FA135R	MD6124D	MD6124C		MD6124CX
Adrenaline 125 EFI (XFLM125GY-2B-E4)			SFA603	SFAC603	SFA603HH				
Aspire 125 TD125-43			SFA086	SFAC086	SFA086HH	MD2104			

Line #

FRONT / AVANT / VORN / FRENTE / ANTERIORE

R Suffix = High Durability Sintered Pad. HH Suffix = High Performance Sintered Pad. TT Suffix = Hard Wearing Off Road Pad. V Suffix = Semi Sintered Pad. G Suffix = Grooved Shoe. D Suffix = Drilled Disc. X Suffix = Universal Left or Right Disc. XC Suffix = Contoured Disc. LS Suffix = Left/Steel Disc. RS = Right/Steel Disc.

*-2 Sets Required. † For Vee disc colours add RED, BLU, GRN, GLD, ORG suffix to part number.

⊗ - Also available as a Vintage Motorcycle Disc.

Non-JAPANESE Built Motorcycles

Line #	BRAKE DISC CHOICES - FRONT						DISC PAD CHOICES - REAR				BRAKE DISC CHOICES - REAR			
	Oversize 250 /280mm Disc Kit	OSX Oversize 250/280mm Disc Kit	Relocating Bracket for 250/ 280mm Disc	Oversize 320mm Disc Kit	SMX Oversize 320mm Disc Kit	Relocating Bracket for 320mm Disc	FA, SFA, TT Pad or Brake Shoe	SFAC Carbon Scooter Pads	Speciality Pads - SXR / Vee / MXS	Sintered/ HH Pads/ Grooved Shoes	Standard Replacement Disc	Contour Disc Rear fitment	Vee-Discs™ CONTOUR	CX Extreme MX Race Disc/ UTVX Disc
1							FA047			FA047HH	N/A			
2							H330			H330G				
3							H330			H330G				
4														
5							921							
6							921							
7							921							
8							SFA305	SFAC305			TBA			
9							H330			H330G				
10							H330			H330G				
11							H330			H330G				
12							H330			H330G				
13							FA271TT			FA271R	MD6173D			
14							FA047			FA047HH	N/A			
15							FA047			FA047HH	N/A			
16							FA271TT			FA271R	MD6173D			
17							FA271TT			FA271R	MD6173D			
18							FA047			FA047HH	MD2002	MD2002C		
19							FA047			FA047HH	MD2002	MD2002C		
20							N/A							
21							FA018	FA018V	FA018H	FA018HH	MD609LS			
22							FA018	FA018V	FA018H	FA018HH	MD609LS			
23							FA047			FA047HH	MD2002	MD2002C		
24							FA018	FA018V	FA018H	FA018HH	MD609LS			
25							FA018	FA018V	FA018H	FA018HH	MD609LS			
26							FA018	FA018V	FA018H	FA018HH	MD609LS			
27							FA018	FA018V	FA018H	FA018HH	MD609LS			
28							FA018	FA018V	FA018H	FA018HH	MD609LS			
29							FA018	FA018V	FA018H	FA018HH	MD609LS			
30							FA018	FA018V	FA018H	FA018HH	MD609LS			
31							FA266	FA266V	FA266H	FA266HH	MD613	MD613C		
32							FA018	FA018V	FA018H	FA018HH	MD609LS			
33							FA018	FA018V	FA018H	FA018HH	MD609LS			
34										MD670				
35														
36														
37									FA325R		N/A			
38							FA115		FA115H	FA115HH	N/A			
39							FA325TT		FA325R	FA325R	N/A			
40							FA325TT		FA325R	FA325R	N/A			
41							FA325TT		FA325R	FA325R	N/A			
42														
43														
44							FA197		FA197H	FA197HH	N/A			
45							FA197		FA197H	FA197HH	N/A			
46							FA197		FA197H	FA197HH	N/A			
47							FA197		FA197H	FA197HH	N/A			
48							FA197		FA197H	FA197HH	N/A			
49							FA197		FA197H	FA197HH	N/A			
50							FA197		FA197H	FA197HH	N/A			
51							FA197		FA197H	FA197HH	N/A			
52														
53														
54							H303		H303G					
55							SFA054	SFAC054	SFA054H	SFA054HH				
56							H303		H303G					
57							H303		H303G					
58							SFA054	SFAC054	SFA054H	SFA054HH				
59							SFA054	SFAC054	SFA054H	SFA054HH				
60							SFA464	SFAC464						

REAR / ARRIÈRE / HINTEN / POSTERIOR / POSTERIORE

R Suffix = High Durability Sintered Pad. HH Suffix = High Performance Sintered Pad. TT Suffix = Hard Wearing Off Road Pad. V Suffix = Semi Sintered Pad. G Suffix = Grooved Shoe.
D Suffix = Drilled Disc. X Suffix = Universal Left or Right Disc. XC Suffix = Contoured Disc. LS Suffix = Left/Steel Disc. RS = Right/Steel Disc.

*-2 Sets Required. † For Vee disc colours add RED, BLU, GRN, GLD, ORG suffix to part number.
⊗ - Also available as a Vintage Motorcycle Disc.

Part numbers, prefixes, suffixes, photos and illustrations shown in this catalogue are trademarks and/or copyrights of EBC Brakes or the trademark owner A C Freeman Investments Ltd and use without express written permission of the owners is punishable by law.

Non-JAPANESE Built Motorcycles



LEXMOTO Contd.



DISC PAD CHOICES - FRONT

BRAKE DISC CHOICES - FRONT

FA, SFA, TT Pad or Brake Shoe	SFAC Carbon Scooter Pads	Speciality Pads - SXR / Vee / MXS	Sintered/HH Pads/ Grooved Shoes	Left / Gauche / Links Standard Replacement Disc	Right / Droite / Rechts Standard Replacement Disc	Contour Disc Universal left and right fitment	Universal Custom Disc	Vee-Discs Black † See note below	CX Extreme MX Race Disc/ UTVX Disc
Assault 125 Efi HJ125-J-E4 19-21	FA196	FA196V	FA196HH						
FMR 125 (WY125T-74R)	SFA086	SFAC086	SFA086HH	MD925D		MD925C		VR925	
FMR 125 Efi (WY125T-74R-E4)	SFA086	SFAC086	SFA086HH	MD925D		MD925C		VR925	
FMS 125 (ZN125T-7H)	SFA086	SFAC086	SFA086HH						
MX 125 (WY125T-108)	SFA197	SFAC197	SFA197HH						
Gladiator 125 (SB125T-23B)	SFA054	SFAC054	SFA054HH						
LXR SE 125 SY125-10-SE 19-21	FA095*	FA095V*	FA095HH*						
Matador 125 (ZS125T-40)	SFA086	SFAC086	SFA086HH	MD925D		MD925C		VR925	
Matador 125 Efi (ZS125T-40-E4)	SFA603	SFAC603	SFA603HH						
Michigan 125 (ZS125-79)	FA135TT		FA135R						
Michigan 125 Efi (ZS125-79-E4)	SFA603	SFAC603	SFA603HH						
Milano 125 (FT125T-27)	SFA086	SFAC086	SFA086HH						
Milano 125 Efi (FT125T-27-E4) 16-20	SFA086	SFAC086	SFA086HH						
LSM 125 (STR125YB)	SFA086	SFAC086	SFA086HH	MD6124D		MD6124C			MD6124CX
Tommy 125 (ZN125T-E)	SFA086	SFAC086	SFA086HH						
Viper 125 SK125-22A 21		FA722							
Venom SK125-22-E4 21		FA197	FA197HH						
XTR-S 125	SFA197	SFAC197	SFA197HH						
ZSX-F 125 ZS125-48E-E4 16-20	FA731TT		FA731R						
ZSX-R 125 ZS125-48F-E4 16-20	FA731TT		FA731R						
Enigma ZS 125 T-48 Euro 4 Scooter 18-20	SFA603	SFAC603	SFA603HH						
Vendetta 250 LJ250-3V 19-21	FA244	FA244V	FA244HH						
LXR 380 TR380-GP1 19-21	FA095	FA095V	FA095HH						
LIFAN									
Lifan Electric LF 1200 DT E3	SFA708	SFAC708							
Lifan Electric LF 1200 DT E3 Deluxe	SFA708	SFAC708							
LF 50 QGY	SFA169	SFAC169	SFA169HH	N/A					
LF 50 QGY 39844	H303/H304								
Smart 50/125	FA375		FA375V	FA375HH	N/A				
LF 100 5	S603								
LF 100 A	FA086		FA086HH	N/A					
LF 125 Off Road	FA448			N/A					
LT 125 3A	FA056				N/A				
LINHAI									
LH 50 Prince (Scooter)	SFA101	SFAC101	SFA101HH	N/A					
ATV 80	N/A*								
Eggy 125cc (Scooter)	SFA101	SFAC101	SFA101HH	N/A					
Monarch 125/150 T	SFA199	SFAC199	SFA199HH		TBA				
ATV 150	N/A*								
Goon 260cc (ATV) 2x4/4x4	FA453TT*		FA453R*	N/A	N/A				
Goon 260 (ATV) (2x4/4x4)	FA453TT*		FA453R*	N/A	N/A				
Goon 260 (ATV) (2x4/4x4) - Parking brake	FA270TT								
CUV Carry 300 (ATV)	FA453TT*		FA453R*	N/A	N/A				
Main Street 300cc (Scooter)	SFA199	SFAC199	SFA199HH		TBA				
Muddy 300 4x4 (ATV)	FA453TT*		FA453R*	N/A	N/A				
Muddy 300 4x4 (ATV) - Parking brake	FA270TT		FA270R	N/A					
Muddy 300 4x4 (ATV)	FA453TT*		FA453R*	N/A	N/A				
Muddy 300 4x4 (ATV) - Parking brake	FA270TT								
ATV 310 (4 X 2)	FA453TT*		FA453R*	N/A	N/A				
ATV 320 (4 X 4/Carrier)	FA453TT*		FA453R*	N/A	N/A				
ATV 420 (4 X 2/LoF)	FA453TT*		FA453R*	N/A	N/A				
ATV 420 (4 X 4/LoF)	FA453TT*		FA453R*	N/A	N/A				
ATV 420 (4 X 4/Carrier LoF)	FA453TT*		FA453R*	N/A	N/A				
CUV Jobber 4 x 4	FA482TT*		FA482R*	N/A	N/A				
ATV 600 Efi 4 X 4/LoF	TBA*			N/A	N/A				

FRONT / AVANT / VORN / FRENTE / ANTERIORE

Line # 1
2
3
4
5
6
7
8
9
10
11
12
13
14
15
16
17
18
19
20
21
22
23
24
25
26
27
28
29
30
31
32
33
34
35
36
37
38
39
40
41
42
43
44
45
46
47
48
49
50
51
52
53
54
55
56
57
58
59
60

*-2 Sets Required. † For Vee disc colours add RED, BLU, GRN, GLD, ORG suffix to part number.
 † - Also available as a Vintage Motorcycle Disc.

R Suffix = High Durability Sintered Pad. HH Suffix = High Performance Sintered Pad. TT Suffix = Hard Wearing Off Road Pad. V Suffix = Semi Sintered Pad. G Suffix = Grooved Shoe. D Suffix = Drilled Disc. X Suffix = Universal Left or Right Disc. LC Suffix = Contoured Disc. LS Suffix = Left/Steel Disc. RS = Right/Steel Disc.

Non-JAPANESE Built Motorcycles

Line #	BRAKE DISC CHOICES - FRONT						DISC PAD CHOICES - REAR				BRAKE DISC CHOICES - REAR			
	Oversize 250 /280mm Disc Kit	OSX Oversize 250/280mm Disc Kit	Relocating Bracket for 250/ 280mm Disc	Oversize 320mm Disc Kit	SMX Oversize 320mm Disc Kit	Relocating Bracket for 320mm Disc	FA, SFA, TT Pad or Brake Shoe	SFAC Carbon Scooter Pads	Speciality Pads - SXR / Vee / MXS	Sintered/ HH Pads/ Grooved Shoes	Standard Replacement Disc	Contour Disc Rear fitment	Vee-Discs™ CONTOUR	CX Extreme MX Race Disc/ UTVX Disc
1							FA140		FA140V	FA140HH				
2							H303			H303G				
3							H303			H303G				
4							SFA197	SFAC197		SFAC197HH				
5							SFA054	SFAC054		SFA054HH				
6							Y527			Y527G				
7							FA140	FA140V		FA140HH				
8							S602			S602G				
9							SFA197	SFAC197		SFAC197HH				
10														
11							SFA197	SFAC197		SFAC197HH				
12							H303			H303G				
13							FA165TT			FA165R				
14							SFA054	SFAC054		SFA054HH				
15							H303			H303G				
16														
17							TBC							
18							SFA086	SFAC086		SFA086HH				
19							FA140							
20							FA140							
21							TBC							
22							SFA415	SFAC415		SFA415HH				
23							FA140	FA140V		FA140HH				
24														
25														
26														
27														
28							H303/H304							
29							H303/H304							
30							H304							
31							S603							
32							H304							
33							FA480			N/A				
34							S602							
35														
36														
37							TBA							
38							FA067TT			FA067R	N/A			
39							TBA							
40							SFA275	SFAC275		SFA275HH	N/A			
41							FA067TT			FA067R	N/A			
42							FA270TT			FA270R	N/A			
43							FA453TT			FA453R	N/A			
44														
45							FA453TT*			FA453R*	N/A			
46							SFA275	SFAC275		SFA275HH	TBA			
47							FA453TT			FA453R	N/A			
48														
49							FA453TT			FA453R	N/A			
50														
51							FA453TT			FA453R	N/A			
52							FA453TT			FA453R	N/A			
53							FA453TT			FA453R	N/A			
54							FA453TT			FA453R	N/A			
55							FA453TT			FA453R	N/A			
56							FA453TT*			FA453R*	N/A			
57							FA453TT*			FA453R*	N/A			
58														
59														
60														

REAR / ARRIÈRE / HINTEN / POSTERIOR / POSTERIORE

R Suffix = High Durability Sintered Pad. **HH** Suffix = High Performance Sintered Pad. **TT** Suffix = Hard Wearing Off Road Pad. **V** Suffix = Semi Sintered Pad. **G** Suffix = Grooved Shoe.
D Suffix = Drilled Disc. **X** Suffix = Universal Left or Right Disc. **XC** Suffix = Contoured Disc. **LS** Suffix = Left/Steel Disc. **RS** = Right/Steel Disc.

*-2 Sets Required. † For Vee disc colours add RED, BLU, GRN, GLD, ORG suffix to part number.
 Ⓢ - Also available as a Vintage Motorcycle Disc.

Part numbers, prefixes, suffixes, photos and illustrations shown in this catalogue are trademarks and/or copyrights of EBC Brakes or the trademark owner A C Freeman Investments Ltd and use without express written permission of the owners is punishable by law.

Non-JAPANESE Built Motorcycles



LML

Star Deluxe 125 (2T/Drum model)	01-03
Star Deluxe 125 (2T/Disc model)	01-03
Star Deluxe 150 (2T/Drum model)	01-03
Star Deluxe 150 (2T/Disc model)	01-03
Star 125 (2T) All Models	10-14
Star 125i (4T) All Models	10-15
Star 150 (2T) All Models	10-14
Star 150 (4T) All Models	10-14
Star 151i (4T) All Models	10-15
Star 200i (4T) All Models	10-15

MAGNI

Sport 1200 S	01
--------------	----

MAHINDRA

Mojo XT 300	20
All models	-84
All models	85
All models	86-88
All models	89-93
250 MX	94-98
500 MX	94-98
500 MX/Enduro	99

MALAGUTI

Chopper 25/40	-82
50 LX Sport	-82
50 Ronco RCW	-82
50 Fifty HF	-82
VA Olympique	-82
50 Watercooled	-82
50 Enduro RCX-W/Sahib	83-
50 Fifty Full/CX	83-
50 RGT Strada	83-
50 Enduro Dune	87-
50 MDX Gold Enduro	87-
50 Enduro MEX	85-86
50 Enduro MEX	87-
50 Enduro MGX	87-
50 Enduro MLX	87-
50 Enduro MSX	85-
50 Fifty Top	85-
50 RGT Sport	85-
50 Custom Fox	87-
50 Dribbling	87-
50 Fifty HF/NL 4 gears	87-
50 Fifty RV	90-00
50 Grizzly RCX 10 (Round pad with tag)	90-00
50 Grizzly RCX 12	90-00
Grizzly RCW4	01-07
Grizzly 10 50 (Round pad with tag)	01-07
Grizzly 10 CE 50 (Round pad with tag)	08-09
Grizzly 12	08-09
Grizzly 12 CE	
Grizzly Quad	87-
50 Ranocchio 3 Wheels	87-
50 RST Sport	87-
50 MXR	89-
50 America	91-

DISC PAD CHOICES - FRONT					BRAKE DISC CHOICES - FRONT						Line #
FA, SFA, TT Pad or Brake Shoe	SFAC Carbon Scooter Pads	Speciality Pads - SXR / Vee / MXS	Sintered/HH Pads/ Grooved Shoes	Left / Gauche / Links Standard Replacement Disc	Right / Droite / Rechts Standard Replacement Disc	Contour Disc Universal left and right fitment	Universal Custom Disc	Vee-Discs Black † See note below	CX Extreme MX Race Disc/ UTVX Disc		
V903										1	
SFA186	SFAC186									2	
V903										3	
SFA186	SFAC186									4	
SFA186	SFAC186									5	
SFA186	SFAC186									6	
SFA186	SFAC186									7	
SFA186	SFAC186									8	
SFA186	SFAC186									9	
SFA186	SFAC186									10	
										11	
FA244*			FA244HH*	N/A	N/A					12	
										13	
FA095										14	
										15	
										16	
										17	
			821G							18	
FA047			FA047R	N/A						19	
FA106TT			FA106R	N/A						20	
FA132			FA132R	N/A						21	
FA132			FA132R	N/A						22	
FA132			FA132R	N/A						23	
FA181TT		MXS181	FA181R		N/A					24	
										25	
										26	
FA050				N/A						27	
FA050				N/A						28	
FA050				N/A						29	
FA050				N/A						30	
FA050				N/A						31	
FA050				N/A						32	
FA099				N/A						33	
FA099				N/A						34	
FA099				N/A						35	
FA099				N/A						36	
FA067/2				N/A						37	
FA047			FA047R	N/A						38	
FA067/2				N/A						39	
										40	
			922G							41	
FA116				N/A						42	
FA067/2				N/A						43	
FA099				N/A						44	
FA099				N/A						45	
931			931G							46	
931			931G							47	
931			931G							48	
N/A				N/A						49	
931			931G							50	
N/A				N/A						51	
N/A				N/A						52	
N/A										53	
931			931G							54	
931			931G							55	
FA050				N/A						56	
931			931G							57	
FA099				N/A						58	
FA060				N/A						59	
SFA173				N/A						60	

FRONT / AVANT / VORN / FRENTE / ANTERIORE

R Suffix = High Durability Sintered Pad. HH Suffix = High Performance Sintered Pad. TT Suffix = Hard Wearing Off Road Pad. V Suffix = Semi Sintered Pad. G Suffix = Grooved Shoe.
D Suffix = Drilled Disc. X Suffix = Universal Left or Right Disc. XC Suffix = Contoured Disc. LS Suffix = Left/Steel Disc. RS = Right/Steel Disc.

*-2 Sets Required. † For Vee disc colours add RED, BLU, GRN, GLD, ORG suffix to part number.
⊗ - Also available as a Vintage Motorcycle Disc.

Non-JAPANESE Built Motorcycles

Line #	BRAKE DISC CHOICES - FRONT						DISC PAD CHOICES - REAR				BRAKE DISC CHOICES - REAR			
	Oversize 250 /280mm Disc Kit	OSX Oversize 250/280mm Disc Kit	Relocating Bracket for 250/ 280mm Disc	Oversize 320mm Disc Kit	SMX Oversize 320mm Disc Kit	Relocating Bracket for 320mm Disc	FA, SFA, TT Pad or Brake Shoe	SFAC Carbon Scooter Pads	Speciality Pads - SXR / Vee / MXS	Sintered/ HH Pads/ Grooved Shoes	Standard Replacement Disc	Contour Disc Rear fitment	Vee-Discs™ CONTOUR	CX Extreme MX Race Disc/ UTVX Disc
1							V903							
2							V903							
3							V903							
4							V903							
5							V903							
6							V903							
7							V903							
8							V903							
9							V903							
10							V903							
11														
12														
13							FA063		FA063HH	N/A				
14														
15														
16							FA197							
17														
18									822G					
19									822G					
20							FA106TT		FA106R	N/A				
21							FA132		FA132R	N/A				
22							FA132		FA132R	N/A				
23							FA067		FA067R	N/A				
24							FA208TT	MXS208	FA208R	N/A				
25														
26														
27							908							
28							908							
29							908							
30									926G					
31							908							
32									926G					
33									930G					
34									926G					
35							931		931G					
36							FA099			N/A				
37									922G					
38									922G					
39									922G					
40									922G					
41									922G					
42									922G					
43							926							
44									922G					
45							931		931G					
46							931		931G					
47									922G					
48							931		931G					
49							931		931G					
50							931		931G					
51							931		931G					
52							931		931G					
53							931		931G					
54							931		931G					
55							931		931G					
56							931		931G					
57							931		931G					
58							FA099			N/A				
59														
60							893							

REAR / ARRIÈRE / HINTEN / POSTERIOR / POSTERIORE

R Suffix = High Durability Sintered Pad. **HH** Suffix = High Performance Sintered Pad. **TT** Suffix = Hard Wearing Off Road Pad. **V** Suffix = Semi Sintered Pad. **G** Suffix = Grooved Shoe.
D Suffix = Drilled Disc. **X** Suffix = Universal Left or Right Disc. **XC** Suffix = Contoured Disc. **LS** Suffix = Left/Steel Disc. **RS** = Right/Steel Disc.

*-2 Sets Required. † For Vee disc colours add RED, BLU, GRN, GLD, ORG suffix to part number.
 ☉ - Also available as a Vintage Motorcycle Disc.

Part numbers, prefixes, suffixes, photos and illustrations shown in this catalogue are trademarks and/or copyrights of EBC Brakes or the trademark owner A C Freeman Investments Ltd and use without express written permission of the owners is punishable by law.

Non-JAPANESE Built Motorcycles



MALAGUTI Contd.



		DISC PAD CHOICES - FRONT				BRAKE DISC CHOICES - FRONT					Line #	
		FA, SFA, TT Pad or Brake Shoe	SFAC Carbon Scooter Pads	Speciality Pads - SXR / Vee / MXS	Sintered/HH Pads/ Grooved Shoes	Left / Gauche / Links Standard Replacement Disc	Right / Droite / Rechts Standard Replacement Disc	Contour Disc Universal left and right fitment	Universal Custom Disc	Vee-Discs Black † See note below		CX Extreme MX Race Disc/ UTVX Disc
50 Evolution	91-	FA099				N/A						1
50 Raid	91-	FA099				N/A						2
Centro SL/SL Cat 50	94-00	SFA116					MD902D			VR902		3
Centro Base 50 (Drum front model)	93-94				926G							4
Centro Base (Front disc model)		SFA116					MD902D			VR902		5
Centro 50/SL (4T)	08-11	SFA083	SFAC083		SFA083HH	TBA						6
Ciak 50	00-04	SFA193	SFAC193		SFA193HH		MD955D					7
Ciak 50 Twin Disc	00-03	SFA193	SFAC193		SFA193HH	MD955D						8
Ciak 50 (4T) Master	04-08	SFA193	SFAC193		SFA193HH	MD955D						9
Drakon S	06	FA266			FA266HH			N/A				10
F10 Jetline 50	91-93	SFA173					MD915D			VR915		11
F10 Jetline 50	94-07	SFA193	SFAC193		SFA193HH	MD915D				VR915		12
F10 Tribal	08-10	SFA193	SFAC193		SFA193HH	MD915D				VR915		13
F10 Jetline WAP	06-10	SFA193	SFAC193		SFA193HH	MD915D				VR915		14
F10 WAP	10-11	SFA083	SFAC083		SFA083HH	TBA						15
<i>Phantom F12 (Front brake pad with two pin holes)</i>	<i>94-98</i>	<i>SFA099</i>				<i>MD901D</i>				<i>VR901</i>		16
F12 Phantom 50 (Front brake pad with one pin hole)	94-03	SFA116										17
<i>F12 50 Phantom</i>	<i>98</i>	<i>SFA116</i>				<i>MD901D</i>				<i>VR901</i>		18
F12 50 Phantom	99-03	SFA116				MD946D						19
F12 Phantom (Air cooled) all models	02-08	SFA193	SFAC193		SFA193HH	MD946D						20
F12 Phantom All liquid cooled models	00-08	SFA193	SFAC193		SFA193HH	MD946D						21
Phantom F12R 50 A/C (All air cooled models)	07-11	SFA193	SFAC193		SFA193HH	TBA			TBA			22
Phantom F12R 50 L/C (All liquid cooled models)	07-11	SFA193	SFAC193		SFA193HH	TBA			TBA			23
Malbo Line - DVD	10-11	SFA169	SFAC169		SFA169HH	MD904D				VR904		24
NKD 50 Drakon	05-09	FA266			FA266HH			N/A				25
XSM 50 Super Motard	03-11	FA194			FA194HH	MD6279D						26
XTM 50	03-11	FA115			FA115HH	N/A						27
Chopper 80	-82	FA050										28
Enduro MDX 80	84-	FA047			FA047R							29
Ciak 100	99-03	SFA193	SFAC193		SFA193HH	MD955D						30
Phantom 100 F12	99-03	SFA193	SFAC193		SFA193HH	MD946D						31
<i>Firefox F15 50</i>	<i>96-98</i>	<i>SFA116</i>				<i>MD901D</i>				<i>VR901</i>		32
<i>F15 50 Firefox</i>	<i>98-00</i>	<i>SFA116</i>				<i>MD901D</i>				<i>VR901</i>		33
F15 Firefox (All liquid cooled models)	01-08	SFA193	SFAC193		SFA193HH	MD946D						34
Firebox F15 (Air cooled models)	99-08	SFA193	SFAC193		SFA193HH	MD946D						35
F69 Phantom 70cc	98	SFA193	SFAC193		SFA193HH	MD936D				VR936		36
<i>Crosser CR1 (Front brake pad with two pin holes)</i>	<i>95-98</i>	<i>SFA099</i>				<i>MD901D</i>				<i>VR901</i>		37
<i>Crosser CR1</i>	<i>95-98</i>	<i>SFA116</i>				<i>MD901D</i>				<i>VR901</i>		38
Yesterday	98-03	SFA116				MD915D				VR915		39
Blog 125 ie	09-11	SFA228	SFAC228		SFA228HH	TBA						40
Ciak 125/150	01-08	SFA047			SFA047HH	MD955D						41
Centro 125 ie/SL	07-11	SFA228	SFAC228		SFA228HH	TBA						42
Madison T 125/150/180	99-03	SFA194	SFAC194		SFA194HH	MD966D				VR966		43
Madison 125-3	06-09	SFA194	SFAC194		SFA194HH	TBA						44
Phantom Max 125/200	04-08	SFA194	SFAC194		SFA194HH	MD966D				VR966		45
R 125 Madison	03-07	SFA194	SFAC194		SFA194HH	MD966D				VR966		46
X3M Enduro (Spoke wheel) 125	08-10	FA350			FA350HH	N/A						47
X3M Motard (Cast wheels) 125	08-10	FA194			FA194HH	N/A						48
Blog 160 ie	09-11	SFA228	SFAC228		SFA228HH	TBA						49
Centro 160 ie/SL	07-11	SFA228	SFAC228		SFA228HH	TBA						50
Ciak 200	06-08	SFA047			SFA047HH	MD955D						51
Madison S 200	04	SFA194	SFAC194		SFA194HH	MD966D				VR966		52
Madison S 250	99-03	SFA324	SFAC324		SFA324HH	MD967D						53
Madison 250ie 3	06-10	SFA194	SFAC194		SFA194HH	TBA						54
Password 250	05-11	SFA194	SFAC194		SFA194HH	TBA						55
RS 250 Madison	04-07	SFA194	SFAC194		SFA194HH	MD966D				VR966		56
Phantom Max 250	04-08	SFA194	SFAC194		SFA194HH	MD966D				VR966		57
F18 Warrior 125/150	00-03	SFA047			SFA047HH	TBA						58
Madison K 400	02-06	SFA324	SFAC324		SFA324HH	MD969D						59
<i>Spider Max GT 500</i>	<i>04-10</i>	<i>SFA256*</i>	<i>SFAC256*</i>		<i>SFA256HH*</i>	<i>MD969D</i>		<i>TBA</i>				60

FRONT / AVANT / VORN / FRENTE / ANTERIORE

*-2 Sets Required. † For Vee disc colours add RED, BLU, GRN, GLD, ORG suffix to part number.

☼ - Also available as a Vintage Motorcycle Disc.

Non-JAPANESE Built Motorcycles

Line #	BRAKE DISC CHOICES - FRONT						DISC PAD CHOICES - REAR				BRAKE DISC CHOICES - REAR			
	Oversize 250 /280mm Disc Kit	OSX Oversize 250/280mm Disc Kit	Relocating Bracket for 250/ 280mm Disc	Oversize 320mm Disc Kit	SMX Oversize 320mm Disc Kit	Relocating Bracket for 320mm Disc	FA, SFA, TT Pad or Brake Shoe	SFAC Carbon Scooter Pads	Speciality Pads - SXR / Vee / MXS	Sintered/ HH Pads/ Grooved Shoes	Standard Replacement Disc	Contour Disc Rear fitment	Vee-Discs™ CONTOUR	CX Extreme MX Race Disc/ UTVX Disc
1							N/A							
2							893							
3							893							
4							893							
5							893							
6							816							
7							893							
8							SFA193	SFAC193		SFA193HH	MD901D			
9							816							
10							FA115			FA115HH	N/A			
11							893							
12							893							
13							893							
14							893							
15							893							
16							893							
17							893							
18							SFA193				MD901D			
19							SFA193				MD901D			
20							893							
21							SFA193	SFAC193		SFA193HH	MD901D			
22							893							
23							SFA193	SFAC193		SFA193HH	TBA			
24							Y503							
25							FA115			FA115HH	N/A			
26							FA115			FA115HH	N/A			
27							FA115			FA115HH	N/A			
28							908							
29														
30							SFA193	SFAC193		SFA193HH	MD901D			
31							SFA193	SFAC193		SFA193HH	MD901D			
32							893							
33							SFA193				MD901D			
34							SFA193	SFAC193		SFA193HH	MD901D			
35							893			SFA193HH				
36							893							
37							807							
38							807							
39							893							
40							SFA101	SFAC101		SFA101HH	TBA			
41							818							
42							SFA101	SFAC101		SFA101HH	TBA			
43							SFA298	SFAC298		SFA298HH	MD966D	VR966		
44							SFA266	SFAC266		SFA266HH	TBA			
45							SFA298	SFAC298		SFA298HH	MD966D	VR966		
46							SFA298	SFAC298		SFA298HH	MD966D	VR966		
47							FA115			FA115HH	N/A			
48							FA115			FA115HH	N/A			
49							SFA101	SFAC101		SFA101HH	TBA			
50							SFA101	SFAC101		SFA101HH	TBA			
51							818							
52							SFA298	SFAC298		SFA298HH	MD966D	VR966		
53							SFA298	SFAC298		SFA298HH	MD966D			
54							SFA266	SFAC266		SFA266HH	TBA			
55							SFA298	SFAC298		SFA298HH	TBA			
56							SFA298	SFAC298		SFA298HH	MD966D	VR966		
57							SFA298	SFAC298		SFA298HH	MD966D	VR966		
58							SFA298	SFAC298		SFA298HH	MD946D			
59							SFA298	SFAC298		SFA298HH	MD967D			
60							SFA266	SFAC266		SFA266HH	MD6125D			

REAR / ARRIÈRE / HINTEN / POSTERIOR / POSTERIORE

R Suffix = High Durability Sintered Pad. **HH** Suffix = High Performance Sintered Pad. **TT** Suffix = Hard Wearing Off Road Pad. **V** Suffix = Semi Sintered Pad. **G** Suffix = Grooved Shoe.
D Suffix = Drilled Disc. **X** Suffix = Universal Left or Right Disc. **XC** Suffix = Contoured Disc. **LS** Suffix = Left/Steel Disc. **RS** = Right/Steel Disc.

*-2 Sets Required. † For Vee disc colours add RED, BLU, GRN, GLD, ORG suffix to part number.
 ☉ - Also available as a Vintage Motorcycle Disc.

Part numbers, prefixes, suffixes, photos and illustrations shown in this catalogue are trademarks and/or copyrights of EBC Brakes or the trademark owner A C Freeman Investments Ltd and use without express written permission of the owners is punishable by law.

Non-JAPANESE Built Motorcycles



MALAGUTI Contd.



DISC PAD CHOICES - FRONT

BRAKE DISC CHOICES - FRONT

FA, SFA, TT Pad or Brake Shoe	SFAC Carbon Scooter Pads	Speciality Pads - SXR / Vee / MXS	Sintered/HH Pads/ Grooved Shoes	Left / Gauche / Links Standard Replacement Disc	Right / Droite / Rechts Standard Replacement Disc	Contour Disc Universal left and right fitment	Universal Custom Disc	Vee-Discs Black † See note below	CX Extreme MX Race Disc/ UTVX Disc
Spider Max RS 500 04-11	SFA256*	SFAC256*	SFA256HH*	MD969D	TBA				
Ciak (Electric Power) 00-05	SFA193	SFAC193	SFA193HH	MD946D					
MALANCA									
E2C 80/CS	FA047*		FA047R*	N/A	N/A				
125 GTI	FA047*		FA047R*	N/A	N/A				
125 Mark Enduro -84	FA047		FA047R	N/A					
125/ST54/GT5	FA050			N/A					
125 ob one M6 85-	FA060			N/A					
125 ob one M6 Racing 85-	FA060*			N/A					
125 Mark Enduro 85-	FA060			N/A					
MASAI									
K50 05-07	TBA*								
L50 05-07	TBA*								
L100 05-07	TBA*								
L150 05-07	TBA*								
A300 Quad 05-07	FA083TT*		FA083R*	N/A	N/A				
A450 Quad 05-07	FA083TT*		FA083R*	N/A	N/A				
MASH									
Bibop 50 14-16	SFA235	SFAC235		MD923D				VR923	
Bibop Racing 50 14-16	SFA235	SFAC235		MD923D				VR923	
City 50cc 18	SFA086	SFAC086	SFA086HH						
Dirt Track 50cc 18-20	FA093								
Fifty 50cc (Roadstar 50) 18-20	FA093								
Black Seven 125cc 17-20	FA722								
Brown Edition 125cc 18-20									
Café Racer 125 14-16	FA228		FA228HH	N/A					
Café Racer 125 17-20									
City 125cc 18-20	SFA086	SFAC086	SFA086HH						
Dirt Track 125cc 18-20									
Sixty Five 125 13-15	SFA086	SFAC086	SFA086HH	MD923D				VR923	
Seventy 125 14-20	FA093			N/A					
Scrambler 125 14-16	FA093			N/A					
Seventy Five 125 14-16	FA228		FA228HH	N/A					
Seventy Five 125 (Classic) 17-20									
Black Seven 250cc 17-20	FA086								
Café Racer 250cc 17-18	FA086		FA086HH						
Dirt Track 250cc 19-20	FA086		FA086HH						
Two Fifty 250 14-16	FA086		FA086HH			N/A			
Two Fifty 250 17-20	FA086		FA086HH						
Family Side 400cc Side Car Outfit 18-20	FA142		FA142V FA142HH						
Roadstar 400 (Five Hundred) 13-20	FA142		FA142V FA142HH	MD2067					
Scrambler 400cc (Dirtstar 400) 17-20	FA142		FA142V FA142HH						
T140 400cc (Trackstar) 17-20	FA095		FA095V FA095HH						
MASSEY-FERGUSON (ATV)									
MF 250 (2WD/4WD) 04	FA271TT*		FA271R*	MD6173D	MD6173D				
MF 300 (2WD/4WD) 04	FA271TT*		FA271R*	MD6173D	MD6173D				
MF 400 (4WD) 04	FA271TT*		FA271R*	MD6173D	MD6173D				
MF 400 (Auto 4WD) 04	FA271TT*		FA271R*	MD6173D	MD6173D				
MF 400/4WD Auto (376cc) 05-09	FA395TT*		FA395R*	MD6173D	MD6173D				
MF 500 (4WD) 04	FA271TT*		FA271R*	MD6173D	MD6173D				
MF 500 (Auto) 04	FA271TT*		FA271R*	MD6173D	MD6173D				
MF 500 (Auto TBX 4WD) 04	FA271TT*		FA271R*	MD6173D	MD6173D				
MF 500/4WD Auto (493cc) 05-09	FA395TT*		FA395R*	MD6173D	MD6173D				
MF 650 2 cyl/4WD Auto (633cc) 05-09	FA395TT*		FA395R*	MD6173D	MD6173D				
MF 650/4WD Auto (641cc) 05-09	FA395TT*		FA395R*	MD6173D	MD6173D				
MF 700 2 D/4WD Auto (686cc Diesel) 05-08	FA395TT*		FA395R*	MD6173D	MD6173D				

Line #
1
2
3
4
5
6
7
8
9
10
11
12
13
14
15
16
17
18
19
20
21
22
23
24
25
26
27
28
29
30
31
32
33
34
35
36
37
38
39
40
41
42
43
44
45
46
47
48
49
50
51
52
53
54
55
56
57
58
59
60

FRONT / AVANT / VORN / FRENTE / ANTERIORE

R Suffix = High Durability Sintered Pad. HH Suffix = High Performance Sintered Pad. TT Suffix = Hard Wearing Off Road Pad. V Suffix = Semi Sintered Pad. G Suffix = Grooved Shoe.
D Suffix = Drilled Disc. X Suffix = Universal Left or Right Disc. XC Suffix = Contoured Disc. LS Suffix = Left/Steel Disc. RS = Right/Steel Disc.

*-2 Sets Required. † For Vee disc colours add RED, BLU, GRN, GLD, ORG suffix to part number.

⊗ - Also available as a Vintage Motorcycle Disc.

Non-JAPANESE Built Motorcycles

Line #	BRAKE DISC CHOICES - FRONT						DISC PAD CHOICES - REAR				BRAKE DISC CHOICES - REAR			
	Oversize 250 /280mm Disc Kit	OSX Oversize 250/280mm Disc Kit	Relocating Bracket for 250/ 280mm Disc	Oversize 320mm Disc Kit	SMX Oversize 320mm Disc Kit	Relocating Bracket for 320mm Disc	FA, SFA, TT Pad or Brake Shoe	SFAC Carbon Scooter Pads	Speciality Pads - SXR / Vee / MXS	Sintered/ HH Pads/ Grooved Shoes	Standard Replacement Disc	Contour Disc Rear fitment	Vee-Discs™ CONTOUR	CX Extreme MX Race Disc/ UTVX Disc
1							SFA266	SFAC266		SFA266HH	MD6125D			
2							TBA							
3														
4														
5							FA047			FA047R	N/A			
6							FA047			FA047R	N/A			
7							N/A							
8							N/A							
9							FA060				N/A			
10							FA060				N/A			
11										841G				
12														
13														
14							FA232TT			FA232R	N/A			
15							FA232TT			FA232R	N/A			
16							FA083TT				FA083R			
17							FA083TT			FA083R	N/A			
18							FA355/4TT			FA355/4R	N/A			
19							FA355/4TT			FA355/4R	N/A			
20														
21														
22							806							
23							806							
24							FA086	SFAC086		SFA086HH				
25														
26														
27							FA054TT							
28							FA054TT							
29							FA054TT			FA054HH	N/A			
30							FA054TT							
31							FA086	SFAC086		SFAC086HH				
32							FA054TT							
33							TBA							
34							H303							
35							H303							
36							FA054TT			FA054HH	N/A			
37							FA054TT							
38							FA054TT							
39							FA054TT			FA054HH				
40														
41							FA350				N/A			
42							FA054TT			FA054HH				
43							FA086			FA086HH				
44							H351							
45														
46														
47														
48														
49							FA271TT			FA271R	MD6173D			
50							FA271TT			FA271R	MD6173D			
51							FA271TT			FA271R	MD6173D			
52							FA271TT			FA271R	MD6173D			
53							FA395TT			FA395R	MD6173D			
54							FA271TT			FA271R	MD6173D			
55							FA271TT			FA271R	MD6173D			
56							FA271TT			FA271R	MD6173D			
57							FA395TT			FA395R	MD6173D			
58							FA395TT			FA395R	MD6173D			
59							FA395TT			FA395R	MD6173D			
60							FA395TT			FA395R	MD6173D			

REAR / ARRIÈRE / HINTEN / POSTERIOR / POSTERIORE

R Suffix = High Durability Sintered Pad. HH Suffix = High Performance Sintered Pad. TT Suffix = Hard Wearing Off Road Pad. V Suffix = Semi Sintered Pad. G Suffix = Grooved Shoe.
D Suffix = Drilled Disc. X Suffix = Universal Left or Right Disc. XC Suffix = Contoured Disc. LS Suffix = Left/Steel Disc. RS = Right/Steel Disc.

*-2 Sets Required. † For Vee disc colours add RED, BLU, GRN, GLD, ORG suffix to part number.
⊗ - Also available as a Vintage Motorcycle Disc.

Non-JAPANESE Built Motorcycles



MBK



		DISC PAD CHOICES - FRONT				BRAKE DISC CHOICES - FRONT					Line #	
		FA, SFA, TT Pad or Brake Shoe	SFAC Carbon Scooter Pads	Speciality Pads - SXR / Vee / MXS	Sintered/HH Pads/ Grooved Shoes	Left / Gauche / Links Standard Replacement Disc	Right / Droite / Rechts Standard Replacement Disc	Contour Disc Universal left and right filament	Universal Custom Disc	Vee-Discs Black † See note below		CX Extreme MX Race Disc/ UTVX Disc
CR 50 Z Target	91-95	SFA169	SFAC169		SFA169HH	MD904D				VR904		1
CS 50 Mach G AC (Air cooled)	02-05	SFA193	SFAC193		SFA193HH	MD943D		MD943C		VR943		2
CS 50 Mach G AC (Air cooled)	06-10	SFA193	SFAC193		SFA193HH	MD943D		MD943C		VR943		3
CS 50 Mach G LC (Liquid cooled)	03-05	SFA193	SFAC193		SFA193HH	MD943D		MD943C		VR943		4
CS 50 Mach G LC (Liquid cooled)	06-10	SFA193	SFAC193		SFA193HH	MD943D		MD943C		VR943		5
CT 50 S Sorriso	91-92	Y503										6
CT 50 SS Sorriso	93-95	Y503										7
CV 50 Evolis	97	SFA193	SFAC193		SFA193HH	MD904D				VR904		8
CW 50 Fizz 50	93-97	SFA193	SFAC193		SFA193HH	MD916D						9
CW 50 Booster	90-91	Y503										10
CW 50 Booster	92-94	Y503										11
CW 50 Booster (10" Wheels)	09-10	SFA193	SFAC193		SFA193HH	MD916D						12
CW 50 R Booster Road	94-95	SFA193	SFAC193		SFA193HH	MD904D				VR904		13
CW 50 RS Booster NG	95-98	SFA193	SFAC193		SFA193HH	MD916D						14
CW 50 RSX Booster Track	96-98	SFA193	SFAC193		SFA193HH	MD916D						15
CW 50 Booster Spirit	96-98	SFA193	SFAC193		SFA193HH	MD916D						16
CW 50 RS Booster Spirit	99-06	SFA193	SFAC193		SFA193HH	MD916D						17
CW 50 RSP Rocket	97-98	SFA193	SFAC193		SFA193HH	MD916D						18
CW 50 RS Booster NG	01-06	SFA193	SFAC193		SFA193HH	MD923D				VR923		19
CW 50 RS Booster Naked	05-06	SFA193	SFAC193		SFA193HH	MD916D						20
CW 50 Booster Naked (10" Wheels)	06-10	SFA193	SFAC193		SFA193HH	MD916D						21
CW 50 Power Rocket	06	SFA193	SFAC193		SFA193HH	MD916D						22
CW 50 Booster (12" wheels)	06-10	SFA193	SFAC193		SFA193HH	MD916D						23
CW 50 Booster Spirit	09	SFA193	SFAC193		SFA193HH	MD916D						24
CW 50 Naked Booster (12" Wheels)	09	SFA193	SFAC193		SFA193HH	MD916D						25
CY 50 Forte/Forte Mufa	96-97	SFA169	SFAC169		SFA169HH	MD904D				VR904		26
EW 50 Stunt	00-06	SFA268	SFAC268		SFA268HH	MD923D				VR923		27
EW 50 Stunt Naked	05-10	SFA268	SFAC268		SFA268HH	MD923D				VR923		28
TZR 50 X-Power	00	FA165TT			FA165HH			MD2067				29
TZR 50 X Power	03-10	FA194			FA194HH	MD672LS						30
X Limit Enduro 50cc	03-10	FA350			FA350HH	MD6297D						31
X Limit Supermoto 50cc	03-10	FA194			FA194HH	MD6297D						32
XF 50 Booster X	07-10	Y530										33
YA 50 R Forte	94-95	SFA193	SFAC193		SFA193HH	MD904D				VR904		34
YA 50 TA Sorriso	95-96	Y503										35
YE 50 Evolis	92-95	SFA193	SFAC193		SFA193HH	MD904D				VR904		36
YH 50 Flipper	98-10	SFA193	SFAC193		SFA193HH	MD928D						37
YM 50 Fizz	94-95	SFA193	SFAC193		SFA193HH	MD904D				VR904		38
YN 50 R Ovetto (2T)	98-10	SFA193	SFAC193		SFA193HH	MD943D		MD943C		VR943		39
YN 50 Ovetto (4T)	09-10	SFA193	SFAC193		SFA193HH	MD943D		MD943C		VR943		40
YQ 50 Nitro	97-10	SFA193	SFAC193		SFA193HH	MD923D				VR923		41
YQ 50 Nitro Naked	06-10	SFA193	SFAC193		SFA193HH	MD923D				VR923		42
CV 80 Evolis	97	SFA193	SFAC193		SFA193HH	MD904D				VR904		43
YN 100 Oveto	99-02	SFA193	SFAC193		SFA193HH	MD943D		MD943C		VR943		44
YQ 100 Nitro	01-03	SFA193	SFAC193		SFA193HH	MD923D				VR923		45
YW 100 Booster 100	99-02	SFA169	SFAC169		SFA169HH	N/A						46
XC 125 T Flame	95-96	Y527										47
XC 125 Flame 125	96-03	SFA101	SFAC101		SFA101HH	N/A						48
XC 125 WAAP	08-10	SFA464	SFAC464					MD9127D		VR9127		49
XN 125/150 Doo Do	00-05	SFA193	SFAC193		SFA193HH	MD907D				VR907		50
XQ 125/150 Thunder	01-03	SFA181	SFAC181		SFA181HH	MD957D				VR957		51
YP 125 D Skyliner	98-00	SFA181	SFAC181		SFA181HH	MD907D				VR907		52
YP 125 D Skyliner	01-10	SFA181	SFAC181		SFA181HH	MD907D				VR907		53
YP 125 Skycruiser	06-10	SFA430	SFAC430		SFA430HH			MD9102D				54
VP 125 Cityliner	08-10	SFA196	SFAC196		SFA196HH	MD9130D						55
YW 125 Z X-Over	10	SFA492	SFAC492			MD986D				VR986		56
NXC 125 Flame X (220mm Front Disc)	04-06	SFA393	SFAC393					MD986D		VR986		57
NXC 125 Flame X (240mm Front Disc)	07-12	SFA393	SFAC393					MD9133D		VR9133		58
XC 150 Vertex	97	SFA181	SFAC181		SFA181HH			N/A				59
YP 250 Skyliner	96-98	SFA199	SFAC199		SFA199HH			MD903D	N/A	VR903		60

FRONT / AVANT / VORN / FRENTE / ANTERIORE

R Suffix = High Durability Sintered Pad. HH Suffix = High Performance Sintered Pad. TT Suffix = Hard Wearing Off Road Pad. V Suffix = Semi Sintered Pad. G Suffix = Grooved Shoe.
D Suffix = Drilled Disc. X Suffix = Universal Left or Right Disc. XC Suffix = Contoured Disc. LS Suffix = Left/Steel Disc. RS = Right/Steel Disc.

*-2 Sets Required. † For Vee disc colours add RED, BLU, GRN, GLD, ORG suffix to part number.

⊗ - Also available as a Vintage Motorcycle Disc.

Non-JAPANESE Built Motorcycles

Line #	BRAKE DISC CHOICES - FRONT						DISC PAD CHOICES - REAR				BRAKE DISC CHOICES - REAR			
	Oversize 250 /280mm Disc Kit	OSX Oversize 250/280mm Disc Kit	Relocating Bracket for 250/ 280mm Disc	Oversize 320mm Disc Kit	SMX Oversize 320mm Disc Kit	Relocating Bracket for 320mm Disc	FA, SFA, TT Pad or Brake Shoe	SFAC Carbon Scooter Pads	Speciality Pads - SXR / Vee / MXS	Sintered/ HH Pads/ Grooved Shoes	Standard Replacement Disc	Contour Disc Rear fitment	Vee-Discs™ CONTOUR	CX Extreme MX Race Disc/ UTVX Disc
1							Y503							
2							Y503							
3							Y530							
4							Y503							
5							Y530							
6							Y503							
7							Y503							
8							Y503							
9							Y503							
10							Y503							
11							Y503							
12							Y503							
13							Y503							
14							Y503							
15							Y503							
16							Y503							
17							Y503							
18							Y503							
19							Y503							
20							Y503							
21							Y503							
22							Y503							
23							Y503							
24							Y503							
25							Y503							
26							Y503							
27							Y503							
28							Y503							
29							FA101TT			MD2077				
30							FA115		FA115HH	MD2113				
31							FA350		FA350HH	MD6280D				
32							FA350		FA350HH	MD6280D				
33							Y530							
34							Y503							
35							Y503							
36							Y503							
37							Y503							
38							Y503							
39							Y503							
40							Y503							
41							SFA268	SFAC268	SFA268HH	MD923D		VR923		
42							SFA268	SFAC268	SFA268HH	MD923D		VR923		
43							Y503							
44							Y527							
45							Y527							
46							Y527							
47							Y503							
48							Y503							
49							Y530							
50							Y527							
51							SFA266	SFAC266	SFA266HH	MD958D		VR958		
52							Y527							
53							SFA266	SFAC266	SFA266HH	MD962D		VR962		
54							SFA266	SFAC266	SFA266HH	MD9104D		VR9104		
55							SFA275	SFAC275	SFA275HH	MD9104D		VR9104		
56							Y533							
57							Y533							
58							Y533							
59							Y527							
60							Y516							

REAR / ARRIÈRE / HINTEN / POSTERIOR / POSTERIORE

R Suffix = High Durability Sintered Pad. **HH** Suffix = High Performance Sintered Pad. **TT** Suffix = Hard Wearing Off Road Pad. **V** Suffix = Semi Sintered Pad. **G** Suffix = Grooved Shoe.
D Suffix = Drilled Disc. **X** Suffix = Universal Left or Right Disc. **XC** Suffix = Contoured Disc. **LS** Suffix = Left/Steel Disc. **RS** = Right/Steel Disc.

*-2 Sets Required. † For Vee disc colours add RED, BLU, GRN, GLD, ORG suffix to part number.
 Ⓢ - Also available as a Vintage Motorcycle Disc.

Part numbers, prefixes, suffixes, photos and illustrations shown in this catalogue are trademarks and/or copyrights of EBC Brakes or the trademark owner A C Freeman Investments Ltd and use without express written permission of the owners is punishable by law.

Non-JAPANESE Built Motorcycles



MBK Contd.



DISC PAD CHOICES - FRONT

BRAKE DISC CHOICES - FRONT

FA, SFA, TT Pad or Brake Shoe	SFAC Carbon Scooter Pads	Speciality Pads - SXR / Vee / MXS	Sintered/HH Pads/ Grooved Shoes	Left / Gauche / Links Standard Replacement Disc	Right / Droite / Rechts Standard Replacement Disc	Contour Disc Universal left and right filament	Universal Custom Disc	Vee-Discs Black † See note below	CX Extreme MX Race Disc/ UTVX Disc
YP 250 Skyliner	SFA199	SFAC199	SFA199HH		MD903D	N/A		VR903	
YP 250 Skyliner 250	SFA199	SFAC199	SFA199HH		MD903D	N/A		VR903	
VP 300 R Kilibre	SFA181	SFAC181	SFA181HH		MD995D			VR995	
YP 400 Skyliner	SFA199	SFAC199	SFA199HH	MD9102D				VR9102	
MECHRON- See KIOTI									
MEGELLI									
125 M (Supermoto)	FA086		FA086HH	TBA					
125 R (Sportbike)	FA086		FA086HH	TBA					
125 S (Naked Sport Bike)	FA086		FA086HH	TBA					
METRAKIT									
XL 80 Mini GP	TBA			N/A			MD6427C		
Pre GP 125	FA399			N/A					
Kn 250 (50cc)	FA399					N/A			
MH 10 50 Enduro	FA416TT					N/A			
MH 10 50 Pro Enduro	FA416TT					N/A			
MH 10 50 Eco Urban 50	FA416TT					N/A			
MH 10 50 Pro Urban 50	FA416TT					N/A			
MH 10 50 SM	FA416TT					N/A			
MH 10 50 Pro SM	FA416TT					N/A			
RX 50 Super Racing	FA167		FA167HH	MD6318D					
RX 50 R	FA399					N/A			
Furia Max Supermoto	FA115		FA115HH	N/A					
Furia Max Enduro 50	FA115		FA115HH	N/A					
RYZ 50 Enduro	FA115		FA115HH	N/A					
RYZ 50 Enduro	FA416TT					N/A			
RYZ 50 Supermotard	FA194		FA194HH	N/A					
RYZ SM 50	FA416TT					N/A			
RYZ 50 Pro Racing Enduro	FA194		FA194HH	N/A		TBA			
RYZ 50 Pro Racing Supermotard	FA194		FA194HH	N/A		TBA			
RYZ Pro SM 50	FA416TT					N/A			
RYZ 50 Urban Bike	FA167		FA167HH	MD6318D					
RYZ 50 Pro Racing Urban Bike	FA194		FA194HH	N/A		TBA			
RYZ 50 Pro Racing Enduro	FA167		FA167HH	N/A		TBA			
Custom 125	FA093					N/A			
Duna 125 Hard Road Enduro									
(21" front wheel/18" rear wheel)	FA093					N/A			
Duna 125 Dual Plus Trail (19" wheels)	FA194		FA194HH	N/A					
Duna 125 Sports City Supermotard (17" wheels)	FA194		FA194HH	N/A					
Duna 125	FA416TT					N/A			
Duna Plus 125	FA194		FA194HH			N/A			
Duna 125 Pro	FA416TT					N/A			
Duna Supermotard 125	FA465TT		MXS465			N/A			
Kn1 125 (125cc) AC/LC	FA399					N/A			
Kn2 125 (125cc)	FA399					N/A			
Ranger 125 Enduro	FA465TT		MXS465			N/A			
RX 125 R	FA399					N/A			
MH7 Naked (125cc/Air cooled)	FA399					N/A			
MH7 Naked (125cc/Liquid cooled)	FA399					N/A			
MH 10 125 Pro Enduro	FA416TT					N/A			
MH 10 125 SM	FA416TT					N/A			
125 LC Hard Road SM	FA399					N/A			
MINIMOTO									
Polini/Pasini//GRC Calipers (Round Type)	FA293			N/A					
Polini/Pasini/GRC Calipers (Square Two Pin Type)	FA352			N/A					

FRONT / AVANT / VORN / FRENTE / ANTERIORE

Line #
1
2
3
4
5
6
7
8
9
10
11
12
13
14
15
16
17
18
19
20
21
22
23
24
25
26
27
28
29
30
31
32
33
34
35
36
37
38
39
40
41
42
43
44
45
46
47
48
49
50
51
52
53
54
55
56
57
58
59
60

R Suffix = High Durability Sintered Pad. HH Suffix = High Performance Sintered Pad. TT Suffix = Hard Wearing Off Road Pad. V Suffix = Semi Sintered Pad. G Suffix = Grooved Shoe.
D Suffix = Drilled Disc. X Suffix = Universal Left or Right Disc. XC Suffix = Contoured Disc. LS Suffix = Left/Steel Disc. RS = Right/Steel Disc.

*-2 Sets Required. † For Vee disc colours add RED, BLU, GRN, GLD, ORG suffix to part number.

⊗ - Also available as a Vintage Motorcycle Disc.

Non-JAPANESE Built Motorcycles

Line #	BRAKE DISC CHOICES - FRONT						DISC PAD CHOICES - REAR				BRAKE DISC CHOICES - REAR			
	Oversize 250 /280mm Disc Kit	OSX Oversize 250/280mm Disc Kit	Relocating Bracket for 250/ 280mm Disc	Oversize 320mm Disc Kit	SMX Oversize 320mm Disc Kit	Relocating Bracket for 320mm Disc	FA, SFA, TT Pad or Brake Shoe	SFAC Carbon Scooter Pads	Speciality Pads - SXR / Vee / MXS	Sintered/ HH Pads/ Grooved Shoes	Standard Replacement Disc	Contour Disc Rear fitment	Vee-Discs™ CONTOUR	CX Extreme MX Race Disc/ UTVX Disc
1							SFA275	SFAC275		SFA275HH	MD927D		VR927	
2							SFA275	SFAC275		SFA275HH	MD953D	MD953C	VR953	
3							SFA181	SFAC181		SFA181HH	MD9104D		VR9104	
4							SFA408	SFAC408		SFA408HH	MD9103D		VR9103	
5														
6														
7														
8														
9							FA346TT			FA346R	TBA			
10							FA346TT			FA346R	TBA			
11							FA346TT			FA346R	TBA			
12														
13														
14							FA351TT				N/A	MD6428C		
15							FA351TT				N/A			
16							FA416TT					N/A		
17							FA083TT					N/A		
18							FA083TT					N/A		
19							FA083TT					N/A		
20							FA083TT					N/A		
21							FA083TT					N/A		
22							FA083TT					N/A		
23							FA115			FA115HH	N/A			
24							FA093					N/A		
25							FA115			FA115HH	N/A			
26							FA115			FA115HH	N/A			
27							FA115			FA115HH	N/A			
28							FA083TT					N/A		
29							FA115			FA115HH	N/A			
30							FA083TT					N/A		
31							FA115			FA115HH	N/A	TBA		
32							FA115			FA115HH	N/A	TBA		
33							FA083TT					N/A		
34							FA115			FA115HH	N/A			
35							FA115			FA115HH	N/A	TBA		
36							FA115			FA115HH	N/A	TBA		
37							TBA							
38														
39							FA115			FA115HH	N/A			
40							FA115			FA115HH	N/A			
41							FA093					N/A		
42							FA083TT					N/A		
43														
44							FA083TT					N/A		
45							FA093					N/A		
46							FA093					N/A		
47							FA416TT					N/A		
48							TBA					N/A		
49							FA093					N/A		
50							FA093					N/A		
51							FA093					N/A		
52							FA083TT					N/A		
53							FA083TT					N/A		
54							FA416TT					N/A		
55														
56														
57							FA293					N/A		
58							FA352					N/A		
59														
60														

REAR / ARRIÈRE / HINTEN / POSTERIOR / POSTERIORE

R Suffix = High Durability Sintered Pad. **HH** Suffix = High Performance Sintered Pad. **TT** Suffix = Hard Wearing Off Road Pad. **V** Suffix = Semi Sintered Pad. **G** Suffix = Grooved Shoe.
D Suffix = Drilled Disc. **X** Suffix = Universal Left or Right Disc. **XC** Suffix = Contoured Disc. **LS** Suffix = Left/Steel Disc. **RS** = Right/Steel Disc.

*-2 Sets Required. † For Vee disc colours add RED, BLU, GRN, GLD, ORG suffix to part number.
 Ⓢ - Also available as a Vintage Motorcycle Disc.

Part numbers, prefixes, suffixes, photos and illustrations shown in this catalogue are trademarks and/or copyrights of EBC Brakes or the trademark owner A C Freeman Investments Ltd and use without express written permission of the owners is punishable by law.

Non-JAPANESE Built Motorcycles



MODENAS



Kriss 110 00-02

Kriss 115

MONDIAL

Piega 1000 02

Piega 1000 03-04

Evo 04

MONTESA/HONDA

Old Models N/A

Cota 123/290/349 -83

Cota 123/200/242/349 84

250 4RT Cota 05-10

260 4RT Cota (STD Version ED/3E) 14-21

260 4RT Cota (Repsol Edition 2E/4E) 14-18

4 Ride Enduro (260cc/4T) 16-18

Cota 300 RR (4T) 16-21

Cota 307/335 88

348 Trial Enduro

Honda 311 260cc 92-93

Honda 314 R 94-96

Honda 315 R 97-00

Honda 315 R 01-04

MOTOBECANE

50 all mod. Atom hub 88-

50 all mod. Leleu hub 88-

51 SUE

51 VLM

Rock/Rock A

Magnum/A/Racing

MOTO GUZZI

350 V 35 (12 Spoke Cast Wheels/Electronic Ignition) 77-79

350 V 35 II (12 Spoke Cast Wheels) 80-85

350 V 35 III (10 Spoke Cast Wheels) 85-87

350 V 35 C Custom (10 Spoke Cast Wheel/Points Ignition) 82-86

350 V 35 Florida 86-90

350 NTX 350 87-90

350 Nevada 92-97

350 Nevada Club 98-99

500 V 50 (12 Spoke Cast Wheels/Electronic Ignition) 77-79

500 V 50 III (12 Spoke Cast Wheels) 85-87

500 V 50 C Custom (10 Spoke Cast Wheel/Points Ignition) 82-86

650 65 GT 88-89

650 NTX 650 87-90

650 V 65 C Custom (10 Spoke Cast Wheel) 83-86

650 V 65 Florida (Spoke & Cast Wheel Models) 85-92

750 Brevia ie (3 Spoke Cast Wheel) 03-11

750 SP (10 Spoke Cast Wheels) 90-92

750 Targa 90-93

750 Nevada 750 91-01

750 Nevada 750 02-11

750 Nevada Club (Up To LK112433) 98-01

750 Nevada Club (From LK112434) 98-01

750 Nevada Classic 750 ie (Spoke Wheels) 04-11

750 Nevada Classic 750 ie (Spoke Wheels) 12-15

750 Strada/T Roadster 93-95

750 V 75 (10 Spoke Cast Wheels/Solid front discs) 92-96

750 V 75 (10 Spoke Cast Wheels/Solid floating discs) 96-01

	DISC PAD CHOICES - FRONT				BRAKE DISC CHOICES - FRONT						Line #
	FA, SFA, TT Pad or Brake Shoe	SFAC Carbon Scooter Pads	Speciality Pads - SXR / Vee / MXS	Sintered/HH Pads/ Grooved Shoes	Left / Gauche / Links Standard Replacement Disc	Right / Droite / Rechts Standard Replacement Disc	Contour Disc Universal left and right filament	Universal Custom Disc	Vee-Discs Black † See note below	CX Extreme MX Race Disc/ UTVX Disc	
	S603										1
	FA165TT				N/A						2
											3
											4
	FA424*			FA424HH*	N/A	N/A					5
				FA322/4HH*	MD621X	MD621X	MD621XC*		VR621BLK*		6
				FA322/4HH*	MD621X	MD621X	MD621XC*		VR621BLK*		7
											8
											9
	N/A										10
				933G							11
				937G							12
	FA303TT				N/A						13
	FA303TT				N/A						14
	FA644TT				N/A						15
	FA644TT						N/A				16
	FA644TT						N/A				17
	FA115TT			FA115R	N/A						18
				933G							19
	FA115TT			FA115R	N/A						20
	FA115TT			FA115R	N/A						21
	FA115TT			FA115R	N/A						22
	FA303TT				N/A						23
											24
											25
											26
											27
											28
											29
											30
											31
											32
											33
											34
	FA047*		FA047V*	FA047HH*	N/A	N/A					35
	FA047*		FA047V*	FA047HH*	N/A	N/A					36
	FA047*		FA047V*	FA047HH*	N/A	N/A					37
	FA047*		FA047V*	FA047HH*	N/A	N/A					38
	FA047*		FA047V*	FA047HH*	N/A	N/A					39
	FA047*		FA047V*	FA047HH*	N/A	N/A					40
	FA047*		FA047V*	FA047HH*	N/A	N/A					41
	FA047*		FA047V*	FA047HH*	N/A	N/A					42
	FA047*		FA047V*	FA047HH*	N/A	N/A					43
	FA047*		FA047V*	FA047HH*	N/A	N/A					44
	FA047*		FA047V*	FA047HH*	N/A	N/A					45
	FA047*		FA047V*	FA047HH*	N/A	N/A					46
	FA047*		FA047V*	FA047HH*	N/A	N/A					47
	FA047*		FA047V*	FA047HH*	N/A	N/A					48
	FA244		FA244V	FA244HH	MD614X		MD614XC		VR614BLK		49
	FA047*		FA047V*	FA047HH*	MD693LS	MD693RS					50
	FA047*		FA047V*	FA047HH*	N/A	N/A					51
	FA047		FA047V	FA047HH	MD693LS						52
	FA047		FA047V	FA047HH	MD693LS						53
	FA047*		FA047V*	FA047HH*	N/A	N/A					54
	FA047*		FA047V*	FA047HH*	N/A	N/A					55
	FA244		FA244V	FA244HH	MD614X		MD614XC		VR614BLK		56
	FA244		FA244V	FA244HH	MD614X		MD614XC		VR614BLK		57
	FA047*		FA047V*	FA047HH*	N/A	N/A					58
	FA047*		FA047V*	FA047HH*	N/A	N/A					59
	FA047*		FA047V*	FA047HH*	N/A	N/A					60

FRONT / AVANT / VORN / FRENTE / ANTERIORE

R Suffix = High Durability Sintered Pad. **HH** Suffix = High Performance Sintered Pad. **TT** Suffix = Hard Wearing Off Road Pad. **V** Suffix = Semi Sintered Pad. **G** Suffix = Grooved Shoe.
D Suffix = Drilled Disc. **X** Suffix = Universal Left or Right Disc. **XS** Suffix = Left/Steel Disc. **RS** = Right/Steel Disc.

*-2 Sets Required. † For Vee disc colours add RED, BLU, GRN, GLD, ORG suffix to part number.

⊗ - Also available as a Vintage Motorcycle Disc.

346 Part numbers, prefixes, suffixes, photos and illustrations shown in this catalogue are trademarks and/or copyrights of EBC Brakes or the trademark owner A C Freeman Investments Ltd and use without express written permission of the owners is punishable by law.

Non-JAPANESE Built Motorcycles

Line #	BRAKE DISC CHOICES - FRONT						DISC PAD CHOICES - REAR				BRAKE DISC CHOICES - REAR			
	Oversize 250 /280mm Disc Kit	OSX Oversize 250/280mm Disc Kit	Relocating Bracket for 250/ 280mm Disc	Oversize 320mm Disc Kit	SMX Oversize 320mm Disc Kit	Relocating Bracket for 320mm Disc	FA, SFA, TT Pad or Brake Shoe	SFAC Carbon Scooter Pads	Speciality Pads - SXR / Vee / MXS	Sintered/ HH Pads/ Grooved Shoes	Standard Replacement Disc	Contour Disc Rear fitment	Vee-Discs™ CONTOUR	CX Extreme MX Race Disc/ UTVX Disc
1							S603							
2							S603							
3														
4														
5							FA095		FA095V	FA095HH	N/A			
6							FA266		FA266V	FA266HH	TBA			
7							FA266		FA266V	FA266HH	TBA			
8														
9														
10							889							
11														
12									933G					
13							FA351TT				N/A			
14							FA351TT				N/A			
15							FA351TT				N/A			
16							FA351TT				N/A			
17							FA351TT				N/A			
18							FA115TT			FA115R	N/A			
19														
20							FA047TT			FA047R	N/A			
21							FA047TT			FA047R	N/A			
22							FA047TT			FA047R	N/A			
23							FA351TT				N/A			
24														
25														
26							873							
27							873							
28							877							
29							H322							
30							877							
31							877							
32														
33														
34							FA047		FA047V	FA047HH	N/A			
35							FA047		FA047V	FA047HH	N/A			
36							FA047		FA047V	FA047HH	N/A			
37							FA047		FA047V	FA047HH	N/A			
38							FA047		FA047V	FA047HH	N/A			
39							FA047		FA047V	FA047HH	N/A			
40							FA047		FA047V	FA047HH	N/A			
41							FA047		FA047V	FA047HH	N/A			
42							FA047		FA047V	FA047HH	N/A			
43							FA047		FA047V	FA047HH	N/A			
44							FA047		FA047V	FA047HH	N/A			
45							FA047		FA047V	FA047HH	N/A			
46							FA047		FA047V	FA047HH	N/A			
47							FA047		FA047V	FA047HH	N/A			
48							FA047		FA047V	FA047HH	N/A			
49							FA266		FA266V	FA266HH	MD871			
50							FA047		FA047V	FA047HH	N/A			
51							FA047		FA047V	FA047HH	N/A			
52							FA047		FA047V	FA047HH	N/A			
53							FA266		FA266V	FA266HH	MD871			
54							FA047		FA047V	FA047HH	N/A			
55							FA266		FA266V	FA266HH	MD871			
56							FA266		FA266V	FA266HH	MD871			
57							FA266		FA266V	FA266HH	N/A			
58							FA047		FA047V	FA047HH	N/A			
59							FA047		FA047V	FA047HH	N/A			
60							FA047		FA047V	FA047HH	N/A			

REAR / ARRIÈRE / HINTEN / POSTERIORE

R Suffix = High Durability Sintered Pad. HH Suffix = High Performance Sintered Pad. TT Suffix = Hard Wearing Off Road Pad. V Suffix = Semi Sintered Pad. G Suffix = Grooved Shoe.
D Suffix = Drilled Disc. X Suffix = Universal Left or Right Disc. XC Suffix = Contoured Disc. LS Suffix = Left/Steel Disc. RS = Right/Steel Disc.

*-2 Sets Required. † For Vee disc colours add RED, BLU, GRN, GLD, ORG suffix to part number.
⊗ - Also available as a Vintage Motorcycle Disc.

Part numbers, prefixes, suffixes, photos and illustrations shown in this catalogue are trademarks and/or copyrights of EBC Brakes or the trademark owner A C Freeman Investments Ltd and use without express written permission of the owners is punishable by law.

Non-JAPANESE Built Motorcycles



MOTO GUZZI Contd.



DISC PAD CHOICES - FRONT

BRAKE DISC CHOICES - FRONT

FRONT / AVANT / VORN / FRENTE / ANTERIORE

	FA, SFA, TT Pad or Brake Shoe	SFAC Carbon Scooter Pads	Speciality Pads - SXR / Vee / MXS	Sintered/HH Pads/ Grooved Shoes	Left / Gauche / Links Standard Replacement Disc	Right / Droite / Rechts Standard Replacement Disc	Contour Disc Universal left and right fitment	Universal Custom Disc	Vee-Discs Black † See note below	CX Extreme MX Race Disc/ UTVX Disc
750 V7 Classic	FA244		FA244V	FA244HH	MD614X		MD614XC		VR614BLK	
750 V7 Cafe Classic	FA244		FA244V	FA244HH	MD614X		MD614XC		VR614BLK	
V7 III Carbon	FA244		FA244V	FA244HH	MD614X					
V7 III Limited	FA244		FA244V	FA244HH	MD614X					
750 V7 Racer	FA244		FA244V	FA244HH	MD614X		MD614XC		VR614BLK	
750 V7 Racer	FA244		FA244V	FA244HH	MD614X		MD614XC		VR614BLK	
750 V7 Racer II (ABS/Spoke Wheel)	FA244		FA244V	FA244HH	TBA					
V7 III Racer ABS/Spoke Wheel	FA244		FA244V	FA244HH	MD614X					
V7 III Rough ABS/Spoke Wheel	FA244		FA244V	FA244HH	MD614X					
750 V7 Special	FA244		FA244V	FA244HH	MD614X		MD614XC		VR614BLK	
750 V7 Special II (ABS/Spoke Wheel)	FA244		FA244V	FA244HH	TBA					
750 V7 Special III (ABS/Spoke Wheel)	FA244		FA244V	FA244HH	TBA					
750 V7 Special III (ABS/Spoke Wheel)	FA244		FA244V	FA244HH	MD614X					
750 V7 Stone	FA244		FA244V	FA244HH	MD614X		MD614XC		VR614BLK	
750 V7 Stone II (ABS/Cast Wheel)	FA244		FA244V	FA244HH	TBA					
750 V7 Stone III (ABS/Cast Wheel)	FA244		FA244V	FA244HH	TBA					
750 V7 II Stornello	FA244		FA244V	FA244HH	TBA		TBA		TBA	
850 Le Mans I	FA018*		FA018V*	FA018HH*	N/A	N/A				
850 Le Mans II	FA018*		FA018V*	FA018HH*	N/A	N/A				
850 Le Mans III	FA018*		FA018V*	FA018HH*	N/A	N/A				
850 T	FA018		FA018V	FA018HH	N/A					
850 T3	FA018*		FA018V*	FA018HH*	N/A	N/A				
850 T3 California (With Screen/Panniers)	FA018*		FA018V*	FA018HH*	N/A	N/A				
850 T4	FA018*		FA018V*	FA018HH*	N/A	N/A				
850 T5	FA018*		FA018V*	FA018HH*	N/A	N/A				
850 T5 California (With Screen/Panniers)	FA018*		FA018V*	FA018HH*	N/A	N/A				
850 Brevia ie (Non ABS Models)	FA244*		FA244V*	FA244HH*	MD859	MD859				
850 Griso	FA244*		FA244V*	FA244HH*	MD621X	MD621X	MD621XC*		VR621BLK*†	
850 Norge (Non ABS Models)	FA244*		FA244V*	FA244HH*	MD859	MD859				
V85TT	FA244*		FA244V*	FA244HH*						
V9 Bobber	FA244*		FA244V*	FA244HH*	MD859	MD859				
V9 Bobber Sport	FA244*		FA244V*	FA244HH*						
V9 Roamer	FA244*		FA244V*	FA244HH*	MD859	MD859				
940 Bellagio	FA209/2*		FA209/2V*	FA209/2HH*	MD614X	MD614X	MD614XC*		VR614BLK*†	
1000 Daytona 1000	FA095*			FA095HH*	MD667	MD667				
1000 Daytona 1000 RS	FA095*			FA095HH*	N/A	N/A				
1000 MGS-01 Corsa				FA322/4HH*	MD621X	MD621X	MD621XC*		VR621BLK*†	
1000 GT (1st Series Cast & Spoke Wheels)	FA018*		FA018V*	FA018HH*	N/A	N/A				
1000 GT (2nd Series Cast & Spoke Wheels)	FA018*		FA018V*	FA018HH*	N/A	N/A				
1000 S (Cast & Spoke Wheel Models)	FA018*		FA018V*	FA018HH*	MD693LS	MD693RS				
1000 SP (12 Spoke Cast Wheels/Dished Front Discs)	FA018*		FA018V*	FA018HH*	N/A	N/A				
1000 SP II (10 Spoke Cast Wheels/Flat Solid Front Discs)	FA018*		FA018V*	FA018HH*	N/A	N/A				
1000 SP III (10 Spoke Cast Wheels/Flat Floating Front Discs)	FA018*		FA018V*	FA018HH*	N/A	N/A				
California 1000 II (12 Spoke Cast Wheels/Screen + Luggage)	FA018*		FA018V*	FA018HH*	N/A	N/A				
California 1000 III - Carbs (VY Chassis Code /Full Faring/Cast & Spoke Wheels)	FA018*		FA018V*	FA018HH*	MD835	MD835				
California 1000 III - Carbs (VW Chassis Code/Screen Only)	FA018*		FA018V*	FA018HH*	MD835	MD835				
California 1000 III - EFI (VY Chassis Code /Full Faring/Cast & Spoke Wheels)	FA018*		FA018V*	FA018HH*	MD835	MD835				
1000 Le-Mans IV/V (10 Spoke Cast Wheels, 10.5mm bolts)	FA018*		FA018V*	FA018HH*	MD693LS	MD693RS				
1000 Le-Mans IV/V (8.5mm bolts)	FA018*		FA018V*	FA018HH*	MD876	MD876				
1000 Strada	FA018*		FA018V*	FA018HH*	N/A	N/A				
G5 V1000	FA018*		FA018V*	FA018HH*	MD891	MD891				
Quota 1000 Efi	FA126*			FA126HH*	MD846X	MD846X				
1000 V10 Centauro GT	FA095*			FA095HH*	MD614X	MD614X	MD614XC*		VR614BLK*	
1000 V10 Centauro Sport	FA095*			FA095HH*	MD614X	MD614X	MD614XC*		VR614BLK*	
Brevia 1100 (Non ABS Models)	FA244*			FA244HH*	MD859	MD859				
Brevia 1100 (ABS Models)	FA244*			FA244HH*	MD624	MD624			VR624BLK*	
1100 California Carbs (KC/KD Chassis Codes)	FA018*			FA018HH*	MD835	MD835				
California 1100 Aluminium	FA244*		FA244V*	FA244HH*	MD614X	MD614X	MD614XC*		VR614BLK*	

Line #

R Suffix = High Durability Sintered Pad. HH Suffix = High Performance Sintered Pad. TT Suffix = Hard Wearing Off Road Pad. V Suffix = Semi Sintered Pad. G Suffix = Grooved Shoe. D Suffix = Drilled Disc. X Suffix = Universal Left or Right Disc. LS Suffix = Left/Steel Disc. RS Suffix = Right/Steel Disc.

*-2 Sets Required. † For Vee disc colours add RED, BLU, GRN, GLD, ORG suffix to part number.

⊗ - Also available as a Vintage Motorcycle Disc.

Non-JAPANESE Built Motorcycles

Line #	BRAKE DISC CHOICES - FRONT						DISC PAD CHOICES - REAR				BRAKE DISC CHOICES - REAR			
	OverSize 250 /280mm Disc Kit	OSX OverSize 250/280mm Disc Kit	Relocating Bracket for 250/ 280mm Disc	OverSize 320mm Disc Kit	SMX OverSize 320mm Disc Kit	Relocating Bracket for 320mm Disc	FA, SFA, TT Pad or Brake Shoe	SFAC Carbon Scooter Pads	Speciality Pads - SXR / Vee / MXS	Sintered/ HH Pads/ Grooved Shoes	Standard Replacement Disc	Contour Disc Rear fitment	Vee-Discs™ CONTOUR	CX Extreme MX Race Disc/ UTVX Disc
1							FA266		FA266V	FA266HH	MD871			
2							FA266		FA266V	FA266HH	MD871			
3							FA256			FA256HH				
4							FA256			FA256HH				
5							FA266		FA266V	FA266HH	MD871			
6							FA256			FA256HH	N/A			
7							FA256			FA256HH	N/A			
8							FA256			FA256HH				
9							FA256			FA256HH				
10							FA256			FA256HH	N/A			
11							FA256			FA256HH	N/A			
12							FA256			FA256HH	N/A			
13							FA256			FA256HH				
14							FA256			FA256HH	N/A			
15							FA256			FA256HH	N/A			
16							FA256			FA256HH	N/A			
17							FA256			FA256HH	N/A			
18							FA018		FA018V	FA018HH	N/A			
19							FA018		FA018V	FA018HH	N/A			
20							FA077		FA077V		N/A			
21							N/A							
22							FA018		FA018V	FA018HH	N/A			
23							FA018		FA018V	FA018HH	N/A			
24							FA018		FA018V	FA018HH	N/A			
25							FA018		FA018V	FA018HH	N/A			
26							FA018		FA018V	FA018HH	N/A			
27							FA181TT			FA181HH	MD840			
28							FA181TT			FA181HH	MD840	MD840C		
29							FA181TT			FA181HH	MD840			
30							FA256			FA256HH				
31							FA256			FA256HH	MD871			
32							FA256			FA256HH				
33							FA256			FA256HH	MD871			
34							FA181TT			FA181HH	MD840	MD840C		
35							FA047		FA047V	FA047HH	N/A			
36							FA047		FA047V	FA047HH	MD692			
37							FA266			FA266HH	N/A			
38							FA018		FA018V	FA018HH	N/A			
39							FA018		FA018V	FA018HH	N/A			
40							FA018		FA018V	FA018HH	MD693LS			
41							FA077		FA077V		N/A			
42							FA077		FA077V		N/A			
43							FA077		FA077V		MD693LS			
44							FA018		FA018V	FA018HH	N/A			
45														
46							FA018		FA018V	FA018HH	MD693LS			
47							FA018		FA018V	FA018HH	MD693LS			
48														
49							FA018		FA018V	FA018HH	MD693LS			
50							FA018		FA018V	FA018HH	MD693LS			
51							FA018		FA018V	FA018HH	MD693LS			
52							FA018		FA018V	FA018HH	MD693LS			
53							FA018		FA018V	FA018HH				
54							FA163				N/A			
55							FA047		FA047V	FA047HH	MD692	MD692C		
56							FA047		FA047V	FA047HH	MD692	MD692C		
57							FA181TT			FA181HH	MD840			
58							FA181TT			FA181HH	MD840			
59							FA018			FA018HH	MD693LS			
60							FA209/2		FA209/2V	FA209/2HH	MD692	MD692C		

REAR / ARRIÈRE / HINTEN / POSTERIOR / POSTERIORE

R Suffix = High Durability Sintered Pad. HH Suffix = High Performance Sintered Pad. TT Suffix = Hard Wearing Off Road Pad. V Suffix = Semi Sintered Pad. G Suffix = Grooved Shoe.
D Suffix = Drilled Disc. X Suffix = Universal Left or Right Disc. XC Suffix = Contoured Disc. LS Suffix = Left/Steel Disc. RS = Right/Steel Disc.

*-2 Sets Required. † For Vee disc colours add RED, BLU, GRN, GLD, ORG suffix to part number.
⊗ - Also available as a Vintage Motorcycle Disc.

Part numbers, prefixes, suffixes, photos and illustrations shown in this catalogue are trademarks and/or copyrights of EBC Brakes or the trademark owner A C Freeman Investments Ltd and use without express written permission of the owners is punishable by law.

Non-JAPANESE Built Motorcycles



MOTO GUZZI Contd.



DISC PAD CHOICES - FRONT

BRAKE DISC CHOICES - FRONT

	FA, SFA, TT Pad or Brake Shoe	SFAC Carbon Scooter Pads	Speciality Pads - SXR / Vee / MXS	Sintered/HH Pads/ Grooved Shoes	Left / Gauche / Links Standard Replacement Disc	Right / Droite / Rechts Standard Replacement Disc	Contour Disc Universal left and right fitment	Universal Custom Disc	Vee-Discs Black † See note below	CX Extreme MX Race Disc/ UTVX Disc	Line #
California 1100 Aquila Nera	FA244*		FA244V*	FA244HH*	MD614X	MD614X	MD614XC*		VR614BLK*		1
California 1100 Classic Touring	FA244*		FA244V*	FA244HH*	MD614X	MD614X	MD614XC*		VR614BLK*		2
California 1100 EV (Single pin pad fixing/Up To KD115426)	FA095*		FA095V*	FA095HH*	MD614X	MD614X	MD614XC*		VR614BLK*		3
California 1100 EV (2 pad pin fixing/From KD115427)	FA244*		FA244V*	FA244HH*	MD614X	MD614X	MD614XC*		VR614BLK*		4
California 1100 EV Touring	FA244*		FA244V*	FA244HH*	MD614X	MD614X	MD614XC*		VR614BLK*		5
California 1100 Jackal (Single pin pad fixing / Up To KD152328)	FA095*		FA095V*	FA095HH*	MD614X	MD614X	MD614XC*		VR614BLK*		7
California 1100 Jackal (2 pad pin fixing/From KD152329)	FA244*		FA244V*	FA244HH*	MD614X	MD614X	MD614XC*		VR614BLK*		8
California 1100 Special											9
(Single pin pad fixing/Up To KD131644)	FA095*		FA095V*	FA095HH*	MD614X	MD614X	MD614XC*		VR614BLK*		10
California 1100 Special (2 pad pin fixing/From KD1131645)	FA244*		FA244V*	FA244HH*	MD614X	MD614X	MD614XC*		VR614BLK*		11
California 1100 Sport	FA244*		FA244V*	FA244HH*	MD614X	MD614X	MD614XC*		VR614BLK*		12
California 1100 Stone	FA244		FA244V	FA244HH	MD614X		MD614XC		VR614BLK		13
California 1100 Stone Metal	FA244		FA244V	FA244HH	MD614X		MD614XC		VR614BLK		14
California 1100 Titanium (With Top Fairing)	FA244*		FA244V*	FA244HH*	MD614X	MD614X	MD614XC*		VR614BLK*		15
California 1100 Vintage	FA244*		FA244V*	FA244HH*	MD614X	MD614X	MD614XC*		VR614BLK*		16
California 1100 90	FA244*		FA244V*	FA244HH*	MD621X	MD621X	MD621XC*		VR621BLK*		17
Griso 1100	FA244*			FA244HH*	MD621X	MD621X	MD621XC*		VR621BLK*		18
1100 Sport Carbs	FA095*			FA095HH*	MD614X	MD614X	MD614XC*		VR614BLK*		19
1100 Sport EFI	FA095*			FA095HH*	MD614X	MD614X	MD614XC*		VR614BLK*		20
1100 Sport Corsa	FA095*			FA095HH*	N/A	N/A					21
1100 Quota ES	FA209/2*		FA209/2V*	FA209/2HH*	N/A	N/A					22
1100 V11 Ballabio	FA244*			FA244HH*	MD614X	MD614X	MD614XC*		VR614BLK*		23
1100 V11 Le Mans	FA244*			FA244HH*	MD614X	MD614X	MD614XC*		VR614BLK*		24
1100 V11 Naked	FA244*			FA244HH*	MD614X	MD614X	MD614XC*		VR614BLK*		25
1100 V11 Scuro	FA244*			FA244HH*	MD614X	MD614X	MD614XC*		VR614BLK*		26
1100 V11 Sport	FA244*			FA244HH*	MD614X	MD614X	MD614XC*		VR614BLK*		27
1200 Brevia	FA244*			FA244HH*	MD624	MD624			VR624BLK*		28
1200 Griso 8V (Standard/Cast Wheel/Radial Caliper)	FA244*			FA244HH*			MD614XC*		VR614BLK*		29
1200 Griso 8V (Special Edition/Spoke Wheel/Radial Caliper)	FA244*			FA244HH*	MD614X	MD614X	MD614XC*		VR614BLK*		30
Norge 1200	FA244*			FA244HH*	MD624	MD624			VR624BLK*		31
1200 Norge GT 8V (ABS)	FA244*			FA244HH*	MD624	MD624			VR624BLK*		32
1200 Sport (4V)	FA244*			FA244HH*	MD624	MD624			VR624BLK*		33
1200 Sport (8V)	FA244*			FA244HH*	TBA	TBA			VR624BLK*		34
1200 Stelvio	FA244*			FA244HH*	MD624	MD624			VR624BLK*		35
1200 Stelvio 8V (ABS)	FA244*			FA244HH*	TBA	TBA					36
1200 Stelvio NTX ABS	FA244*			FA244HH*	MD624	MD624			VR624BLK*		37
1200 Stelvio 8V NTX (ABS)	FA244*			FA244HH*	TBA	TBA			VR624BLK*		38
1400 California Custom	FA244*			FA244HH*	TBA	TBA					39
1400 California Touring	FA244*			FA244HH*	TBA	TBA					40
1400 California Touring SE	FA244*			FA244HH*	TBA	TBA					41
1400 Audace	FA244*			FA244HH*	TBA	TBA					42
1400 Audace Carbon	FA244*			FA244HH*	TBA	TBA					43
1400 Eldorado	FA244*			FA244HH*	TBA	TBA					44
MGX 21 1400	FA244*			FA244HH*	TBA	TBA					45
											46
											47
MOTOM											48
Ana 50	SFA086	SFAC086		SFA086HH		N/A					48
Gypsy 50	SFA235	SFAC235			TBA						49
Spasso 50	FA448				TBA						50
Dolcevita 125/151	SFA235	SFAC235			TBA						51
Transcity 125/250	SFA179	SFAC179		SFA179HH	N/A						52
Ana 151	SFA086	SFAC086		SFA086HH		N/A					53
											54
											55
MOTO MORINI											56
125 Monocilindro	FA076			FA076HH	N/A						56
125 KJ/T/KT/Kanguro	N/A				N/A						57
250 All Models	FA076			FA076HH	N/A						58
350 Coguaro	FA134			FA134R	N/A						59
350 Sport	FA076*			FA076HH*	N/A						60

FRONT / AVANT / VORN / FRENTE / ANTERIORE

R Suffix = High Durability Sintered Pad. HH Suffix = High Performance Sintered Pad. TT Suffix = Hard Wearing Off Road Pad. V Suffix = Semi Sintered Pad. G Suffix = Grooved Shoe. D Suffix = Drilled Disc. X Suffix = Universal Left or Right Disc. XC Suffix = Contoured Disc. LS Suffix = Left/Steel Disc. RS = Right/Steel Disc.

*-2 Sets Required. † For Vee disc colours add RED, BLU, GRN, GLD, ORG suffix to part number.

⊗ - Also available as a Vintage Motorcycle Disc.

Non-JAPANESE Built Motorcycles

Line #	BRAKE DISC CHOICES - FRONT						DISC PAD CHOICES - REAR				BRAKE DISC CHOICES - REAR			
	Oversize 250 /280mm Disc Kit	OSX Oversize 250/280mm Disc Kit	Relocating Bracket for 250/ 280mm Disc	Oversize 320mm Disc Kit	SMX Oversize 320mm Disc Kit	Relocating Bracket for 320mm Disc	FA, SFA, TT Pad or Brake Shoe	SFAC Carbon Scooter Pads	Speciality Pads - SXR / Vee / MXS	Sintered/ HH Pads/ Grooved Shoes	Standard Replacement Disc	Contour Disc Rear fitment	Vee-Discs™ CONTOUR	CX Extreme MX Race Disc/ UTVX Disc
1							FA209/2		FA209/2V	FA209/2HH	MD692	MD692C		
2							FA209/2		FA209/2V	FA209/2HH	MD692	MD692C		
3							FA209/2		FA209/2V	FA209/2HH	MD692	MD692C		
4							FA209/2		FA209/2V	FA209/2HH	MD692	MD692C		
5							FA209/2		FA209/2V	FA209/2HH	MD692	MD692C		
6														
7							FA209/2		FA209/2V	FA209/2HH	MD692	MD692C		
8							FA209/2		FA209/2V	FA209/2HH	MD692	MD692C		
9														
10							FA209/2		FA209/2V	FA209/2HH	MD692	MD692C		
11							FA209/2		FA209/2V	FA209/2HH	MD692	MD692C		
12							FA209/2		FA209/2V	FA209/2HH	MD692	MD692C		
13							FA209/2		FA209/2V	FA209/2HH	MD692	MD692C		
14							FA209/2		FA209/2V	FA209/2HH	MD692	MD692C		
15							FA209/2		FA209/2V	FA209/2HH	MD692	MD692C		
16							FA209/2		FA209/2V	FA209/2HH	MD692	MD692C		
17							FA209/2		FA209/2V	FA209/2HH	MD692	MD692C		
18							FA181TT			FA181HH	MD840	MD840C		
19							FA047		FA047V	FA047HH	N/A			
20							FA047		FA047V	FA047HH	N/A			
21							FA047		FA047V	FA047HH	N/A			
22							FA181TT			FA181HH	N/A			
23							FA047		FA047V	FA047HH	MD692	MD692C		
24							FA047		FA047V	FA047HH	MD692	MD692C		
25							FA047		FA047V	FA047HH	MD692	MD692C		
26							FA047		FA047V	FA047HH	MD692	MD692C		
27							FA047		FA047V	FA047HH	MD692	MD692C		
28							FA181TT			FA181HH	MD840			
29							FA181TT			FA181HH	MD840	MD840C		
30							FA181TT			FA181HH	MD840	MD840C		
31							FA181TT			FA181HH	MD840			
32							FA181TT			FA181HH	MD840			
33							FA181TT			FA181HH	MD840			
34							FA181TT			FA181HH	MD840			
35							FA181TT			FA181HH	MD840			
36							FA181TT			FA181HH	MD840			
37							FA181TT			FA181HH	MD840			
38							FA181TT			FA181HH	MD840			
39							FA209/2		FA209/2V	FA209/2HH	MD840			
40							FA209/2		FA209/2V	FA209/2HH	MD840			
41							FA209/2		FA209/2V	FA209/2HH	MD840			
42							FA209/2		FA209/2V	FA209/2HH	MD840			
43							FA209/2		FA209/2V	FA209/2HH	MD840			
44							FA209/2		FA209/2V	FA209/2HH	MD840			
45							FA209/2		FA209/2V	FA209/2HH	MD840			
46														
47														
48							SFA197	SFAC197		FA197HH	N/A			
49							TBA							
50							TBA							
51							SFA086	SFAC086			N/A			
52							SFA086	SFAC086		SFA086HH	N/A			
53							SFA197	SFAC197		SFA197HH	N/A			
54														
55														
56										821G				
57										821G				
58							921							
59							FA047			FA047HH	N/A			
60							FA076				N/A			

REAR / ARRIÈRE / HINTEN / POSTERIORE / POSTERIORE

*-2 Sets Required. † For Vee disc colours add RED, BLU, GRN, GLD, ORG suffix to part number.
 Ⓢ - Also available as a Vintage Motorcycle Disc.

BRAKE APPLICATIONS
R Suffix = High Durability Sintered Pad. **HH** Suffix = High Performance Sintered Pad. **TT** Suffix = Hard Wearing Off Road Pad. **V** Suffix = Semi Sintered Pad. **G** Suffix = Grooved Shoe.
D Suffix = Drilled Disc. **X** Suffix = Universal Left or Right Disc. **XC** Suffix = Contoured Disc. **LS** Suffix = Left/Steel Disc. **RS** = Right/Steel Disc.

Non-JAPANESE Built Motorcycles



MOTO MORINI Contd.



DISC PAD CHOICES - FRONT

BRAKE DISC CHOICES - FRONT

FA, SFA, TT Pad or Brake Shoe	SFAC Carbon Scooter Pads	Speciality Pads - SXR / Vee / MXS	Sintered/HH Pads/ Grooved Shoes	Left / Gauche / Links Standard Replacement Disc	Right / Droite / Rechts Standard Replacement Disc	Contour Disc Universal left and right fitment	Universal Custom Disc	Vee-Discs Black † See note below	CX Extreme MX Race Disc/ UTVX Disc
350 Sport	80		FA076HH	N/A					
350 Sport	81		FA076HH	N/A					
350 FT/Turismo	80-		FA076HH	N/A					
350 Kanguro	-83		927G						
350 Kanguro	84-86	N/A		N/A					
350 Kanguro	87	FA256	FA256HH	N/A					
Excalibur 350/501 RLX	93	FA134		N/A					
Dart 350	87	FA134		N/A					
350 K2		N/A*		N/A	N/A				
9 1/2 (1200cc)	06-10	FA244*	FA244HH*	MD633X	MD633X	MD633XC*			
Corsaro 1200	05-10	FA244*	FA244HH*	MD633X	MD633X	MD633XC*			
Corsaro 1200 Veloce	07-09	FA244*	FA244HH*	MD633X	MD633X	MD633XC*			
Granpasso 1200	08-10	FA209/2*	FA209/2V*	FA209/2HH*	N/A				
Corsaro Avio	08-09	FA244	FA244HH	MD633X	MD633X	MD633XC*			
1200 Sport	08-10	FA244*	FA244HH*	MD633X	MD633X	MD633XC*			
Scrambler 1200	08-09	FA244*	FA244HH*	N/A	N/A				
Scrambler 1200	10-13	FA209/2*	FA209/2V*	FA209/2HH*	N/A	N/A			
Rebello 1200 Giubileo	12-13		FA322/4HH*	N/A	N/A				
MOTOROMA									
Bee 50	04-05	SFA169	SFAC169	SFA169HH	TA				
Blazer 50/100/110 Quad	99-04	H338*		H338G*					
Wasp 50	99-05	TBA			TBA				
G10 (50cc/2T)	11-12	SFA235	SFAC235			N/A			
Go-Go 50	97-05	SFA169	SFAC169	SFA169HH	MD904D			VR904	
Stinger 50	99-05	SFA169	SFAC169	SFA169HH	MD904D			VR904	
Scrambler 50	01	SFA169	SFAC169	SFA169HH	MD904D			VR904	
Road Runner 50/100	01-02	SFA169	SFAC169	SFA169HH	MD904D			VR904	
Grand Prix 50/100	99-03	SFA083*	SFAC083*	SFA083HH*	MD923D	MD923D		VR923*	
Sport 90 Quad	01-03	H338*		H338G*					
Quad Roadrunner 100	04	H338*		H338G*					
Go-Go 110	01-02	SFA169	SFAC169	SFA169HH		N/A			
Grand Prix 125	01	SFA169	SFAC169	SFA169HH	TBA				
Grand Prix 125	02	SFA083	SFAC083	SFA083HH	MD923D			VR923	
Lazer 125 Buggie	03-07	H346*		H346G*					
Lambros 125 (4T)	11-12	SFA235	SFAC235		N/A				
MXR 125	03	FA056			N/A				
Road Runner 125	02-04	FA135TT			TBA				
SK 125 (Cast Wheel)	10-12	FA093				N/A			
SMX 125	04-06	FA167		FA167HH	N/A				
Virage 125	01	FA093			N/A				
Geko 300 Quad	04-06	FA083TT*		FA083R*	N/A	N/A			
MOTRON									
50 Sting	98	SFA193	SFAC193	SFA193HH	TBA				
50 Syncro	98	SFA193	SFAC193	SFA193HH	TBA				
50 Thunder	98	SFA193	SFAC193	SFA193HH	TBA				
MV									
675 Brutale	12-17	FA244*		FA244HH*	MD884X	MD884X	MD884XC		
675 F3	12-21	FA244*		FA244HH*	N/A	N/A			
675 F3 Serie Oro	12-13			FA447HH*	MD884X	MD884X	MD884XC		
675 F3 RC	15-18			FA447HH*	MD884X	MD884X	MD884XC		
750 Brutale S F4	03-05			FA424HH*	N/A	N/A			
750 Brutale Oro F4	03-05			FA322/4HH*	N/A	N/A			
750 F4 S (Mono Posto)	99-04			FA424HH*	MD675	MD675			
750 F4 S 1+1 (Bi Posto)	01-04			FA424HH*	N/A	N/A			
750 F4 SPR	01-04			FA424HH*	N/A	N/A			
750 F4 SPR Senna	01-03			FA424HH*	N/A	N/A			
800 Brutale	12-18	FA244*		FA244HH*	MD884X	MD884X	MD884XC*		

Line #

1

2

3

4

5

6

7

8

9

10

11

12

13

14

15

16

17

18

19

20

21

22

23

24

25

26

27

28

29

30

31

32

33

34

35

36

37

38

39

40

41

42

43

44

45

46

47

48

49

50

51

52

53

54

55

56

57

58

59

60

FRONT / AVANT / VORN / FRENTE / ANTERIORE

R Suffix = High Durability Sintered Pad. HH Suffix = High Performance Sintered Pad. TT Suffix = Hard Wearing Off Road Pad. V Suffix = Semi Sintered Pad. G Suffix = Grooved Shoe.

D Suffix = Drilled Disc. X Suffix = Universal Left or Right Disc. XC Suffix = Contoured Disc. LS Suffix = Left/Steel Disc. RS = Right/Steel Disc.

*-2 Sets Required. † For Vee disc colours add RED, BLU, GRN, GLD, ORG suffix to part number.

⊗ - Also available as a Vintage Motorcycle Disc.

Non-JAPANESE Built Motorcycles

Line #	BRAKE DISC CHOICES - FRONT						DISC PAD CHOICES - REAR				BRAKE DISC CHOICES - REAR			
	OverSize 250 /280mm Disc Kit	OSX OverSize 250/280mm Disc Kit	Relocating Bracket for 250/ 280mm Disc	OverSize 320mm Disc Kit	SMX OverSize 320mm Disc Kit	Relocating Bracket for 320mm Disc	FA, SFA, TT Pad or Brake Shoe	SFAC Carbon Scooter Pads	Speciality Pads - SXR / Vee / MXS	Sintered/ HH Pads/ Grooved Shoes	Standard Replacement Disc	Contour Disc Rear fitment	Vee-Discs™ CONTOUR	CX Extreme MX Race Disc/ UTVX Disc
1							921							
2							N/A							
3							921							
4														
5											927G			
6											927G			
7							FA047				N/A			
8							FA047				N/A			
9							FA047				N/A			
10							FA047				N/A			
11							FA266		FA266V	FA266HH	N/A			
12							FA266		FA266V	FA266HH	N/A			
13							FA266		FA266V	FA266HH	N/A			
14							FA181TT			FA181HH	N/A			
15							FA266		FA266V	FA266HH	N/A			
16							FA266		FA266V	FA266HH	N/A			
17							FA266		FA266V	FA266HH	N/A			
18							FA181TT		FA181V	FA181HH	N/A			
19							FA266			FA266HH	N/A			
20														
21							TBA							
22							H330			H330G				
23							Y503							
24							Y503							
25							Y503							
26							Y503							
27							Y503							
28							Y503							
29							Y503							
30							H330			H330G				
31							H330			H330G				
32							S603							
33							TBA							
34							SFA083	SFAC083		SFA083HH	MD982D			
35							FA083TT			FA083R	MD6354D			
36							Y503							
37							S602							
38							TBA							
39							S602							
40							FA115			FA115HH	N/A			
41							S602							
42							FA165TT			FA165R	N/A			
43														
44							TBA							
45							TBA							
46							TBA							
47														
48														
49														
50							FA266		FA266V	FA266HH	MD885	MD885C		
51							FA266		FA266V	FA266HH	MD885	MD885C		
52							FA266		FA266V	FA266HH	MD885	MD885C		
53							FA266		FA266V	FA266HH	MD885	MD885C		
54										FA320HH	MD696			
55										FA320HH	MD696			
56										FA320HH	MD696			
57										FA320HH	MD696			
58										FA320HH	MD696			
59										FA320HH	MD696			
60							FA266		FA266V	FA266HH	MD885	MD885C		

REAR / ARRIÈRE / HINTEN / POSTERIOR / POSTERIORE

R Suffix = High Durability Sintered Pad. **HH** Suffix = High Performance Sintered Pad. **TT** Suffix = Hard Wearing Off Road Pad. **V** Suffix = Semi Sintered Pad. **G** Suffix = Grooved Shoe.
D Suffix = Drilled Disc. **X** Suffix = Universal Left or Right Disc. **XC** Suffix = Contoured Disc. **LS** Suffix = Left/Steel Disc. **RS** = Right/Steel Disc.

*-2 Sets Required. † For Vee disc colours add RED, BLU, GRN, GLD, ORG suffix to part number.
 Ⓢ - Also available as a Vintage Motorcycle Disc.

Part numbers, prefixes, suffixes, photos and illustrations shown in this catalogue are trademarks and/or copyrights of EBC Brakes or the trademark owner A C Freeman Investments Ltd and use without express written permission of the owners is punishable by law.

Non-JAPANESE Built Motorcycles



MV Contd.



DISC PAD CHOICES - FRONT

BRAKE DISC CHOICES - FRONT

R Suffix = High Durability Sintered Pad. **HH** Suffix = High Performance Sintered Pad. **TT** Suffix = Hard Wearing Off Road Pad. **V** Suffix = Semi Sintered Pad. **G** Suffix = Grooved Shoe.
D Suffix = Drilled Disc. **X** Suffix = Universal Left or Right Disc. **XS** Suffix = Left/Steel Disc. **RS** = Right/Steel Disc.

L Suffix = Contoured Disc. **LS** Suffix = Left/Steel Disc. **RS** = Right/Steel Disc.

FRONT / AVANT / VORN / FRENTE / ANTERIORE

MZ/MUZ

Model	Year	FA, SFA, TT Pad or Brake Shoe	SFAC Carbon Scooter Pads	Speciality Pads - SXR / Vee / MXS	Sintered/HH Pads/ Grooved Shoes	Left / Gauche / Links Standard Replacement Disc	Right / Droite / Rechts Standard Replacement Disc	Contour Disc Universal left and right fitment	Universal Custom Disc	Vee-Discs Black † See note below	CX Extreme MX Race Disc/ UTVX Disc	Line #
Simpson	80-94	980										46
Moskito 50	02	SFA083	SFAC083		SFA083HH	N/A						47
Moskito FB 50	97-03	SFA169	SFAC169		SFA169HH	MD904D				VR904		48
Moskito SX JP50	00-03	SFA169	SFAC169		SFA169HH	MD904D				VR904		49
VRS 50	05	TBA*										50
VRS 100	05	TBA*										51
Saxon 125	93-97	FA018			FA018HH		MD623RS					52
ETZ 125/150	85-92	FA018			FA018HH		N/A					53
Mantizz 125 S	05-07	SFA323	SFAC323		SFA323HH		TBA					54
Moskito 125	02	SFA083	SFAC083		SFA083HH	MD9181						55
RT 125 (All models)	02-07	FA197			FA197HH	N/A						56
SM 125 (All models)	02-07	FA228			FA228HH	N/A						57
SX 125 (All models)	02-07	FA228			FA228HH	N/A						58
TS 125/150		978										59
VRT 125 Quad	05	TBA*										60

*-2 Sets Required. † For Vee disc colours add RED, BLU, GRN, GLD, ORG suffix to part number.

⊗ - Also available as a Vintage Motorcycle Disc.

Non-JAPANESE Built Motorcycles

Line #	BRAKE DISC CHOICES - FRONT						DISC PAD CHOICES - REAR				BRAKE DISC CHOICES - REAR			
	Oversize 250 /280mm Disc Kit	OSX Oversize 250/280mm Disc Kit	Relocating Bracket for 250/ 280mm Disc	Oversize 320mm Disc Kit	SMX Oversize 320mm Disc Kit	Relocating Bracket for 320mm Disc	FA, SFA, TT Pad or Brake Shoe	SFAC Carbon Scooter Pads	Speciality Pads - SXR / Vee / MXS	Sintered/ HH Pads/ Grooved Shoes	Standard Replacement Disc	Contour Disc Rear fitment	Vee-Discs™ CONTOUR	CX Extreme MX Race Disc/ UTVX Disc
1							FA266		FA266V	FA266HH	MD885	MD885C		
2							FA266		FA266V	FA266HH	MD885	MD885C		
3							FA266		FA266V	FA266HH	MD885	MD885C		
4							FA266		FA266V	FA266HH	MD885	MD885C		
5							FA266		FA266V	FA266HH	MD885	MD885C		
6							FA266		FA266V	FA266HH	MD885	MD885C		
7							FA266		FA266V	FA266HH	MD885	MD885C		
8							FA266		FA266V	FA266HH	MD885	MD885C		
9							FA266		FA266V	FA266HH	MD885	MD885C		
10							FA266		FA266V	FA266HH	MD885	MD885C		
11							FA266		FA266V	FA266HH	MD885	MD885C		
12							FA266		FA266V	FA266HH	MD885	MD885C		
13							FA266		FA266V	FA266HH	MD885	MD885C		
14							FA266		FA266V	FA266HH	MD885	MD885C		
15							FA266		FA266V	FA266HH	MD885	MD885C		
16							FA266		FA266V	FA266HH	MD885	MD885C		
17							FA266		FA266V	FA266HH	MD885	MD885C		
18							FA266		FA266V	FA266HH	MD885	MD885C		
19										FA320HH	MD696			
20										FA320HH	MD696			
21										FA320HH	MD696			
22										FA320HH	MD696			
23										FA320HH	MD696			
24										FA320HH	MD696			
25										FA320HH	MD696			
26										FA320HH	MD696			
27										FA320HH	MD696			
28										FA320HH	MD696			
29										FA320HH	MD696			
30										FA320HH	MD696			
31										FA320HH	MD696			
32										FA320HH	MD696			
33										FA320HH	MD696			
34										FA320HH	MD696			
35										FA320HH	MD696			
36										FA320HH	MD696			
37										FA320HH	MD696			
38										FA320HH	MD696			
39										FA320HH	MD696			
40										FA320HH	MD696			
41										FA320HH	MD696			
42										FA320HH	MD696			
43										FA320HH	MD696			
44														
45														
46							980							
47							TBA							
48							Y503							
49							Y503							
50							FA083TT			FA083R				
51							FA083TT			FA083R				
52							979							
53							979							
54							TBA							
55							TBA							
56							FA197			FA197HH	N/A			
57							FA197			FA197HH	N/A			
58							FA197			FA197HH	N/A			
59							979							
60							FA165/2TT			FA165/2R	N/A			

REAR / ARRIÈRE / HINTEN / POSTERIOR / POSTERIORE

R Suffix = High Durability Sintered Pad. HH Suffix = High Performance Sintered Pad. TT Suffix = Hard Wearing Off Road Pad. V Suffix = Semi Sintered Pad. G Suffix = Grooved Shoe.
D Suffix = Drilled Disc. X Suffix = Universal Left or Right Disc. XC Suffix = Contoured Disc. LS Suffix = Left/Steel Disc. RS = Right/Steel Disc.

*-2 Sets Required. † For Vee disc colours add RED, BLU, GRN, GLD, ORG suffix to part number.
⊗ - Also available as a Vintage Motorcycle Disc.

Part numbers, prefixes, suffixes, photos and illustrations shown in this catalogue are trademarks and/or copyrights of EBC Brakes or the trademark owner A C Freeman Investments Ltd and use without express written permission of the owners is punishable by law.

Non-JAPANESE Built Motorcycles



MZ/MUZ



Saxon 150	95
VRS 150 Quad	05
VRT 175 Quad	05
TS 250	
251 Fun	95-96
ETZ 250/300	85-92
Saxon Tour 251/301	93-98
Saxon 500 All models	93-98
Skorpion Tour/Traveller	95-02
Skorpion Sport/Cup	95-01
Skorpion Replica	95-01
Baghira Black Panther - 17" Front wheel/Spoke wheel	96-03
Baghira Forest/Forest HR - 21" Front wheel/Spoke wheel	96-05
Baghira Street Moto 17" Front wheel/Spoke wheel	96-05
Baghira 21" Front wheel/Spoke wheel	99-05
Mastiff 21" Front wheel/Spoke wheel	96-05
Mastiff 17" Front wheel/Cast wheel	99-05
1000 S	03-07
1000 SF	05-07
1000 SFX	07
1000 ST	07

NEWFORCE QUADS

Most models

NIPPONIA

Brio 50 (4T)	12-13
Ezio 50 (4T)	12-14
Neon 50 (2T)	12-15
Miro 100 (4T)	12-13
Arte 125 (4T)	12-13
Brio 125 (4T)	12-15
Dion 125 (4T)	13-15
Duel 125 (4T)	12-13
Eclipse 125 (4T)	12-13
Ezio 125 (4T)	12-13
Inter 125 (4T)	12-13
Miro 125 (4T)	12-14
U2L 125 (4T)	12-13
Vorrei 125 (4T)	12-13
Arte 150 (4T)	12-13
Inter 150 (4T)	12-13
Vorrei 150 (4T)	12-13
Eclipse 180 (4T)	12-13

NORTON

Commando (Drum Brake Models)	68-70
750 MK V Commando Roadster/Interstate	73
850 MK 1 Commando Hi Rider/Interstate	73
850 MK 1A Commando Roadster/Interstate	73
850 MK 11/11A Commando Roadster/Hi Rider/Interstate	74
850 MK 111 Commando Roadster/Hi Rider/Interstate	75
Classic (Rotary)	89
Interpol 2 (Rotary)	89
Commander (Rotary)	90
F1 (Rotary) P55 Model	90
F1 (Rotary) P55 B Model	90-91
961 Commando Sport	10-20
961 Commando Cafe Racer	10-14
961 Commando Cafe Racer	15-20

	DISC PAD CHOICES - FRONT				BRAKE DISC CHOICES - FRONT					Line #	
	FA, SFA, TT Pad or Brake Shoe	SFAC Carbon Scooter Pads	Speciality Pads - SXR / Vee / MXS	Sintered/HH Pads/ Grooved Shoes	Left / Gauche / Links Standard Replacement Disc	Right / Droite / Rechts Standard Replacement Disc	Contour Disc Universal left and right fitment	Universal Custom Disc	Vee-Discs Black † See note below		CX Extreme MX Race Disc/ UTVX Disc
	FA018			FA018HH			MD623RS				1
	TBA*										2
	TBA*										3
	978										4
	FA018			FA018HH			MD623RS				5
	FA018			FA018HH			N/A				6
	FA018			FA018HH			MD623RS				7
	FA018			FA018HH			MD623RS				8
	FA095			FA095HH			MD619RS				9
	FA095			FA095HH			MD619RS				10
	FA095*			FA095HH*	TBA	TBA					11
	FA177				TBA						12
	FA177				N/A						13
	FA177				TBA						14
	FA177				N/A						15
	FA177				TBA						16
	FA095			FA095HH	TBA						17
	FA145*			FA145HH*	MD855X	MD855X	MD855XC*				18
	FA145*			FA145HH*	MD855X	MD855X	MD855XC*				19
	FA145*			FA145HH*	MD855X	MD855X	MD855XC*				20
	FA145*			FA145HH*	MD855X	MD855X	MD855XC*				21
											22
											23
	FA453TT*			FA453R*	N/A	N/A					24
											25
											26
	SFA086	SFAC086		SFA086HH			N/A				27
	SFA086	SFAC086		SFA086HH		N/A					28
	SFA086	SFAC086		SFA086HH	N/A						29
	SFA101	SFA101		SFA101HH		N/A					30
	SFA197	SFAC197		SFA197HH	N/A						31
	SFA086	SFAC086		SFA086HH			N/A				32
	SFA086	SFAC086		SFA086HH	N/A						33
	FA228			FA228HH	N/A						34
	SFA086	SFAC086		SFA086HH		N/A					35
	SFA086	SFAC086		SFA086HH		N/A					36
	SFA086	SFAC086		SFA086HH		TBA					37
	SFA101	SFAC101		SFA101HH		N/A					38
	SFA086	SFAC086		SFA086HH		N/A					39
	SFA086	SFAC086		SFA086HH	N/A						40
	SFA197	SFAC197		SFA197HH	N/A						41
	TBA					TBA					42
	TBA				N/A						43
	SFA086	SFAC086		SFA086HH		N/A					44
											45
											46
	852										47
	FA027				N/A						48
	FA027				N/A						49
	FA027				N/A						50
	FA027				N/A						51
	FA027				N/A						52
	FA018*			FA018HH*	N/A	N/A					53
	FA018*			FA018HH*	N/A	N/A					54
	FA088*			FA088HH*	MD2011	MD2011	MD2011C*		VR2011*		55
	FA095*			FA095HH*	MD684	MD684					56
	FA095*			FA095HH*	MD684	MD684					57
	FA244*			FA244HH*	MD614X	MD614X	MD614XC*		VR614BLK*		58
				FA322/4HH*	MD614X	MD614X	MD614XC*		VR614BLK*		59
				FA630HH*	MD614X	MD614X	MD614XC*		VR614BLK*		60

FRONT / AVANT / VORN / FRENTE / ANTERIORE

R Suffix = High Durability Sintered Pad. HH Suffix = High Performance Sintered Pad. TT Suffix = Hard Wearing Off Road Pad. V Suffix = Semi Sintered Pad. G Suffix = Grooved Shoe. D Suffix = Drilled Disc. X Suffix = Universal Left or Right Disc. XC Suffix = Contoured Disc. LS Suffix = Left/Steel Disc. RS = Right/Steel Disc.

*-2 Sets Required. † For Vee disc colours add RED, BLU, GRN, GLD, ORG suffix to part number.
 Ⓢ - Also available as a Vintage Motorcycle Disc.

Non-JAPANESE Built Motorcycles

Line #	BRAKE DISC CHOICES - FRONT						DISC PAD CHOICES - REAR				BRAKE DISC CHOICES - REAR			
	Oversize 250 /280mm Disc Kit	OSX Oversize 250/280mm Disc Kit	Relocating Bracket for 250/ 280mm Disc	Oversize 320mm Disc Kit	SMX Oversize 320mm Disc Kit	Relocating Bracket for 320mm Disc	FA, SFA, TT Pad or Brake Shoe	SFAC Carbon Scooter Pads	Speciality Pads - SXR / Vee / MXS	Sintered/ HH Pads/ Grooved Shoes	Standard Replacement Disc	Contour Disc Rear fitment	Vee-Discs™ CONTOUR	CX Extreme MX Race Disc/ UTVX Disc
1							979							
2							FA083TT			FA083R	N/A			
3							FA165/2TT			FA165/2R	N/A			
4							978							
5							978							
6							978							
7							978							
8							978							
9							FA047			FA047HH	MD637			
10							FA047			FA047HH	MD637			
11							FA047			FA047HH	MD637			
12							FA173				MD6284D			
13							FA173				MD6284D			
14							FA173				MD6284D			
15							FA173				MD6284D			
16							FA173				MD6284D			
17							FA047			FA047HH	TBA			
18							FA254		FA254V	FA254HH	N/A			
19							FA254		FA254V	FA254HH	TBA			
20							FA254		FA254V	FA254HH	TBA			
21							FA254		FA254V	FA254HH	TBA			
22														
23														
24									FA453R	N/A				
25														
26														
27							TBA							
28							TBA							
29							TBA							
30							TBA							
31							SFA197	SFAC197		SFA197HH	N/A			
32							SFA197	SFAC197		SFA197HH	N/A			
33							SFA197	SFAC197		SFA197HH	N/A			
34							TBA							
35							TBA							
36							TBA							
37							TBA							
38							Y527							
39							TBA							
40							TBA							
41							SFA197	SFAC197		SFA197HH	N/A			
42							TBA							
43							TBA							
44							TBA							
45														
46														
47							851							
48							FA027				N/A			
49							FA027				N/A			
50							FA027				N/A			
51							FA027				N/A			
52							FA027				N/A			
53							FA018		FA018V	FA018HH	N/A			
54							FA018		FA018V	FA018HH	N/A			
55							FA088			FA088HH	MD2069			
56							FA047			FA047HH	MD816			
57							FA095			FA095HH	MD816			
58							FA266		FA266V	FA266HH	N/A			
59							FA266		FA266V	FA266HH	N/A			
60							FA266		FA266V	FA266HH	N/A			

REAR / ARRIÈRE / HINTEN / POSTERIOR / POSTERIORE

R Suffix = High Durability Sintered Pad. **HH** Suffix = High Performance Sintered Pad. **TT** Suffix = Hard Wearing Off Road Pad. **V** Suffix = Semi Sintered Pad. **G** Suffix = Grooved Shoe.
D Suffix = Drilled Disc. **X** Suffix = Universal Left or Right Disc. **XC** Suffix = Contoured Disc. **LS** Suffix = Left/Steel Disc. **RS** = Right/Steel Disc.

*-2 Sets Required. † For Vee disc colours add RED, BLU, GRN, GLD, ORG suffix to part number.
 Ⓢ - Also available as a Vintage Motorcycle Disc.

Part numbers, prefixes, suffixes, photos and illustrations shown in this catalogue are trademarks and/or copyrights of EBC Brakes or the trademark owner A C Freeman Investments Ltd and use without express written permission of the owners is punishable by law.

Non-JAPANESE Built Motorcycles



NORTON Contd.

961 Commando Dominator SS	15-20
961 Commando SE	10-11
961 Commando SF	13-14
961 Commando SF	15

NVT

Easy Rider	908
125/175 Rambler	FA076

OHVALE

GP-0 110A,1104S,160 4S	19-20
------------------------	-------

OSSA

125 Cross	74-
TR 125i	13-15
250 Cross/Fuego/Super Pioneer	74-
Enduro 250i	12
Explorer 250i	14-15
TR 250i	14-15
Explorer 280i	12-15
TR 280i	10-15
Enduro 300i	12
TR 300i	14-15
350 Tu-Yo	
pre 1980 models	
81 onwards	
500	92
560	92

PEUGEOT

Most Mofas/Mopeds	
E-Powered by GenZe	18
Fox/Fox L 50	94-98
103 Pro, SP 3	
Buxy M/Buxy RM (50cc) (Counterbored disc - Leleu Wheels) - Grimeca Caliper	94-97
Buxy M/Buxy RM (50cc) (Counterbored disc - Leleu Wheels - Hengtong caliper - check pad shape before ordering)	94-97
Buxy M/Buxy RM (50cc) (Counterbored disc - Leleu Wheels - AJP Caliper - check pad shape before ordering)	94-97
Buxy M/Buxy RM (50cc) (Countersunk disc - Grimeca Wheels) - Grimeca Caliper	94-97
Buxy M/Buxy RM (50cc) (Countersunk disc - Grimeca Wheels - Hengtong caliper - check pad shape before ordering)	94-97
Buxy M/Buxy RM (50cc) (Countersunk disc - Grimeca Wheels - AJP Caliper - check pad shape before ordering)	94-97
Blaster RS 12 50 (2T)	10-11
Blaster Iceblade 50 (2T/12" Wheels)	10-12
Django 50 Allure (2T)	14-18
Django 50 Allure (4T)	14-18
Django 50 Evasion (2T)	14-21
Django 50 Evasion (4T)	14-18
Django 50 Heritage (2T)	14-18
Django 50 Heritage (4T)	14-18
Django 50 S (2T)	14-18
Django 50 S (4T)	14-18

FA, SFA, TT Pad or Brake Shoe	SFAC Carbon Scooter Pads	Speciality Pads - SXR / Vee / MXS	Sintered/HH Pads/ Grooved Shoes	DISC PAD CHOICES - FRONT				BRAKE DISC CHOICES - FRONT				Line #
				Left / Gauche / Links Standard Replacement Disc	Right / Droite / Rechts Standard Replacement Disc	Contour Disc Universal left and right fitment	Universal Custom Disc	Vee-Disks Black † See note below	CX Extreme MX Race Disc/ UTVX Disc			
			FA630HH*	MD614X	MD614X	MD614XC*			VR614BLK*			1
			FA322/4HH*	MD614X	MD614X	MD614XC*			VR614BLK*			2
			FA322/4HH*	MD614X	MD614X	MD614XC*			VR614BLK*			3
			FA630HH*	MD614X	MD614X	MD614XC*			VR614BLK*			4
												5
												6
	908											7
	FA076		FA076HH	N/A								8
												9
												10
			FA612R	MD9183								11
												12
												13
			934G									14
	FA303TT			N/A								15
			934G									16
	FA181TT	MXS181	FA181R			N/A						17
	FA303TT					N/A						18
	FA303TT			N/A								19
	FA303TT					N/A						20
	FA303TT			N/A								21
	FA181TT	MXS181	FA181R			N/A						22
	FA303TT			N/A								23
	FA050			N/A								24
			934G									25
			935G									26
	FA132		FA132R	N/A								27
	FA067		FA067R	N/A								28
												29
												30
	H322											31
	SFA083	SFAC083										32
	H322											33
	H322											34
	SFA193	SFAC193	SFA193HH	MD909D								35
												36
	SFA083	SFAC083	SFA083HH	MD909D								37
												38
	SFA115	SFAC115	SFA115HH	MD909D								39
												40
	SFA193	SFAC193	SFA193HH	MD901D					VR901			41
												42
	SFA083	SFAC083	SFA083HH	MD901D					VR901			43
												44
	SFA115	SFAC115	SFA115HH	MD901D					VR901			45
												46
	SFA115	SFAC115	SFA115HH						VR9105			47
	SFA115	SFAC115	SFA115HH						VR9105			48
	SFA603	SFAC603	SFA603HH	MD9141D								49
	SFA603	SFAC603	SFA603HH	MD9141D								50
	SFA603	SFAC603	SFA603HH	MD9141D								51
	SFA603	SFAC603	SFA603HH	MD9141D								52
	SFA228	SFAC228	SFA228HH	MD9141D								53
	SFA228	SFAC228	SFA228HH	MD9141D								54
	SFA603	SFAC603	SFA603HH	MD9141D								55
	SFA603	SFAC603	SFA603HH	MD9141D								56
	SFA603	SFAC603	SFA603HH	MD9141D								57
	SFA603	SFAC603	SFA603HH	MD9141D								58
	SFA603	SFAC603	SFA603HH	MD9141D								59
	SFA603	SFAC603	SFA603HH	MD9141D								60

FRONT / AVANT / VORN / FRENTE / ANTERIORE

R Suffix = High Durability Sintered Pad. HH Suffix = High Performance Sintered Pad. TT Suffix = Hard Wearing Off Road Pad. V Suffix = Semi Sintered Pad. G Suffix = Grooved Shoe.
D Suffix = Drilled Disc. X Suffix = Universal Left or Right Disc. XC Suffix = Contoured Disc. LS Suffix = Left/Steel Disc. RS = Right/Steel Disc.

*-2 Sets Required. † For Vee disc colours add RED, BLU, GRN, GLD, ORG suffix to part number.

⊗ - Also available as a Vintage Motorcycle Disc.

Non-JAPANESE Built Motorcycles

Line #	BRAKE DISC CHOICES - FRONT						DISC PAD CHOICES - REAR				BRAKE DISC CHOICES - REAR			
	Oversize 250 /280mm Disc Kit	OSX Oversize 250/280mm Disc Kit	Relocating Bracket for 250/ 280mm Disc	Oversize 320mm Disc Kit	SMX Oversize 320mm Disc Kit	Relocating Bracket for 320mm Disc	FA, SFA, TT Pad or Brake Shoe	SFAC Carbon Scooter Pads	Speciality Pads - SXR / Vee / MXS	Sintered/ HH Pads/ Grooved Shoes	Standard Replacement Disc	Contour Disc Rear fitment	Vee-Discs™ CONTOUR	CX Extreme MX Race Disc/ UTVX Disc
1							FA266		FA266V	FA266HH	N/A			
2							FA266		FA266V	FA266HH	N/A			
3							FA266		FA266V	FA266HH	N/A			
4							FA266		FA266V	FA266HH	N/A			
5														
6														
7							908							
8									821G					
9														
10														
11									FA602R	MD904D				
12														
13														
14									990G					
15							FA351TT			N/A				
16									990G					
17							FA368TT		MXS368	FA368R		N/A		
18							FA351TT					N/A		
19							FA351TT				N/A			
20							FA351TT				N/A			
21							FA351TT				N/A			
22							FA368TT		MXS368	FA368R		N/A		
23							FA351TT				N/A			
24							FA050				N/A			
25									934G					
26									936G					
27							FA067			FA067R	N/A			
28							FA067			FA067R	N/A			
29														
30														
31							H322							
32							SFA083	SFAC083						
33							H303							
34							H322							
35														
36							H303							
37														
38														
39							H303							
40														
41														
42							H303							
43														
44							H303							
45														
46														
47							H303							
48														
49														
50							H303							
51							SFA115	SFAC115		SFA115HH		N/A		
52							SFA115	SFAC115		SFA115HH		N/A		
53							H303							
54							H303							
55							893							
56							893							
57							H303							
58							H303							
59							H303							
60							H303							

REAR / ARRIÈRE / HINTEN / POSTERIOR / POSTERIORE

R Suffix = High Durability Sintered Pad. **HH** Suffix = High Performance Sintered Pad. **TT** Suffix = Hard Wearing Off Road Pad. **V** Suffix = Semi Sintered Pad. **G** Suffix = Grooved Shoe.
D Suffix = Drilled Disc. **X** Suffix = Universal Left or Right Disc. **XC** Suffix = Contoured Disc. **LS** Suffix = Left/Steel Disc. **RS** = Right/Steel Disc.

*-2 Sets Required. † For Vee disc colours add RED, BLU, GRN, GLD, ORG suffix to part number.
 Ⓢ - Also available as a Vintage Motorcycle Disc.

Part numbers, prefixes, suffixes, photos and illustrations shown in this catalogue are trademarks and/or copyrights of EBC Brakes or the trademark owner A C Freeman Investments Ltd and use without express written permission of the owners is punishable by law.

Non-JAPANESE Built Motorcycles



PEUGEOT Contd.



DISC PAD CHOICES - FRONT

BRAKE DISC CHOICES - FRONT

R Suffix = High Durability Sintered Pad. HH Suffix = High Performance Sintered Pad. TT Suffix = Hard Wearing Off Road Pad. V Suffix = Semi Sintered Pad. G Suffix = Grooved Shoe.
D Suffix = Drilled Disc. X Suffix = Universal Left or Right Disc. XC Suffix = Contoured Disc. LS Suffix = Left/Steel Disc. RS = Right/Steel Disc.

FRONT / AVANT / VORN / FRENTE / ANTERIORE

		FA, SFA, TT Pad or Brake Shoe	SFAC Carbon Scooter Pads	Speciality Pads - SXR / Vee / MXS	Sintered/HH Pads/ Grooved Shoes	Left / Gauche / Links Standard Replacement Disc	Right / Droite / Rechts Standard Replacement Disc	Contour Disc Universal left and right fitment	Universal Custom Disc	Vee-Disks Black † See note below	CX Extreme MX Race Disc/ UTVX Disc	Line #
Django 50 Sport (2T)	14-21	SFA603	SFAC603		SFA603HH	MD9141D						1
Django 50 Sport (4T)	14-18	SFA603	SFAC603		SFA603HH	MD9141D						2
Elyseo 50	98-02	SFA193	SFAC193		SFA193HH	MD901D				VR901		3
Elyseo 50 (Hengtong caliper - check pad shape before ordering)	98-02	SFA083	SFAC083		SFA083HH	MD901D				VR901		4
Elyseo 50 (AJP Caliper - check pad shape before ordering)	98-02	SFA115	SFAC115		SFA115HH	MD901D				VR901		5
Elyseo 50	03	SFA115	SFAC115		SFA115HH	MD901D				VR901		6
Elystar 50 TSDI	02-07	SFA115	SFAC115		SFA115HH	MD947D				VR947		7
Elystar 50 Advantage	02-07	SFA115	SFAC115		SFA115HH	MD947D				VR947		8
Jet Force 50/Jet-C (All models)	03-10	SFA115	SFAC115		SFA115HH	MD985D				VR985		9
Jet C Tech 50	11-12	SFA115	SFAC115		SFA115HH	MD985D				VR985		10
Jet Darkside 50 (2T)	11-13	SFA115	SFAC115		SFA115HH	MD985D				VR985		11
Jet Iceblade 50 (2T)	11-13	SFA115	SFAC115		SFA115HH	MD985D				VR985		12
Jet H2i 50 (2T - Air Cooled)	11-12	SFA115	SFAC115		SFA115HH			N/A				13
Jet H2i 50 (2T-L/C)	11-12	SFA115	SFAC115		SFA115HH			N/A				14
Kisbee 50 (2T)	10-18	SFA083	SFAC083		SFA083HH	TBA						15
Kisbee 50 (4T)	10-21	SFA083	SFAC083		SFA083HH	TBA						16
Kisbee RS 50 (2T)	10-18	SFA083	SFAC083		SFA083HH	TBA						17
Kisbee RS 50 (4T)	10-21	SFA083	SFAC083		SFA083HH	TBA						18
LooXoR 50 (AJP Caliper/Rear Drum)	01-06	SFA115	SFAC115		SFA115HH	MD954D				VR954		19
LooXoR 50 (Heng Tong Caliper/Rear Drum)	01-06	SFA083	SFAC083		SFA083HH	MD954D				VR954		20
LooXoR 50 TSDI (Rear disc)	06	SFA115	SFAC115		SFA115HH	MD954D				VR954		21
Ludix One (10" wheels) 50cc	04-12	H303										22
Ludix Snake (10" wheels) 50cc	04-09	SFA115	SFAC115		SFA115HH	MD992D				VR992		23
Ludix Bullet (10" wheels) 50cc	04	SFA115	SFAC115		SFA115HH	MD992D				VR992		24
Ludix Trend (10" wheels) 50cc	04-07	SFA115	SFAC115		SFA115HH	MD992D				VR992		25
Ludix Elegance (14" wheels) 50cc	04-09	SFA115	SFAC115		SFA115HH	MD993D						26
Ludix Classic (14" wheels)	04-05	H303										27
Ludix Urban Track	06-07	SFA115	SFAC115		SFA115HH	MD992D				VR992		28
Ludix Red Zone	06	SFA115	SFAC115		SFA115HH	MD992D				VR992		29
Ludix Acid	06	SFA115	SFAC115		SFA115HH	MD992D				VR992		30
Ludix Blaster (10" Wheels)	05-09	SFA115	SFAC115		SFA115HH					VR9105		31
Ludix 2 Trend 50cc (2T/12" wheels)	07-12	SFA115	SFAC115		SFA115HH					VR9105		32
Ludix Pro (4T/14" Wheels/AJP Caliper)	11-13	SFA115	SFAC115		SFA115HH					VR901		33
Ludix Pro (4T/14" Wheels/J.Juan Caliper)	11-13	SFA193	SFAC193		SFA193HH					VR901		34
Ludix 2 Bipoosto 50cc (2T/10" wheels)	07-09	H303										35
Ludix 2 One Bipoosto (2T/10" Wheels)	10-12	H303										36
Ludix 2 One Monoposoto (2T/12" Wheels)	10-11	H303										37
Metal-X 50 (All models)	04-06	SFA115	SFAC115		SFA115HH	MD984D				VR984		38
Vivacity 50 (AJP Caliper/12" Wheels/190mm Disc)	92-07	SFA115	SFAC115		SFA115HH	MD901D				VR901		39
Vivacity 50 (Heng Tong Caliper/12" Wheels/190mm Disc)	92-07	SFA083	SFAC083		SFA083HH	MD901D				VR901		40
Vivacity 2 50 (AJP Caliper/10" Wheels/190mm Disc)	08-11	SFA115	SFAC115		SFA115HH	MD901D				VR901		41
Vivacity 2 50 (Heng Tong Caliper/10" Wheels/190mm Disc)	08-11	SFA083	SFAC083		SFA083HH	MD901D				VR901		42
E-Vivacity (Electric)	10	SFA235	SFAC235			TBA						43
E-Vivacity (Electric)	11-15	SFA228	SFAC228		SFA228HH	MD9141D				VR9141		44
New Vivacity (50cc/2T/12" Wheels/200mm Disc)	08-14	SFA054	SFAC054		SFA054HH	MD9141D				VR9141		45
New Vivacity (50cc/4T/12" Wheels/200mm Disc)	08-14	SFA054	SFAC054		SFA054HH	MD9141D				VR9141		46
New Vivacity Sixties (50cc/4T/12" Wheels/200mm Disc)	10-13	SFA054	SFAC054		SFA054HH	MD9141D				VR9141		47
Speedake 50cc (Counterbored disc - Leleu Wheels - Hengtong caliper - check pad shape before ordering)	95-01	SFA083	SFAC083		SFA083HH	MD909D						48
Speedake 50cc (Counterbored disc - Leleu Wheels - AJP Caliper - check pad shape before ordering)	95-01	SFA115	SFAC115		SFA115HH	MD909D						49
Speedake 50cc (Countersunk disc - Grimeca Wheels - Hengtong caliper - check pad shape before ordering)	95-01	SFA083	SFAC083		SFA083HH	MD901D				VR901		50

*-2 Sets Required. † For Vee disc colours add RED, BLU, GRN, GLD, ORG suffix to part number.

⊗ - Also available as a Vintage Motorcycle Disc.

Non-JAPANESE Built Motorcycles

Line #	BRAKE DISC CHOICES - FRONT						DISC PAD CHOICES - REAR				BRAKE DISC CHOICES - REAR			
	Oversize 250 /280mm Disc Kit	OSX Oversize 250/280mm Disc Kit	Relocating Bracket for 250/ 280mm Disc	Oversize 320mm Disc Kit	SMX Oversize 320mm Disc Kit	Relocating Bracket for 320mm Disc	FA, SFA, TT Pad or Brake Shoe	SFAC Carbon Scooter Pads	Speciality Pads - SXR / Vee / MXS	Sintered/ HH Pads/ Grooved Shoes	Standard Replacement Disc	Contour Disc Rear fitment	Vee-Discs™ CONTOUR	CX Extreme MX Race Disc/ UTVX Disc
1							893							
2							893							
3							H303							
4														
5							H303							
6														
7							H303							
8							SFA115	SFAC115		SFA115HH	MD925D	MD925C	VR925	
9							SFA350	SFAC350		SFA350HH	MD978D	MD978C	VR978	
10							SFA115	SFAC115		SFA115HH	MD925D		VR925	
11							SFA115	SFAC115		SFA115HH	MD984D		VR984	
12							SFA115	SFAC115		SFA115HH	MD984D		VR984	
13							SFA115	SFAC115		SFA115HH	MD984D		VR984	
14							SFA115	SFAC115		SFA115HH	MD984D		VR984	
15							H303							
16							SFA115	SFAC115		SFA115HH		N/A		
17							H353							
18							H353							
19							H353							
20							H353							
21							H303							
22							H303							
23							SFA115	SFAC115		SFA115HH	MD901D		VR901	
24							H303							
25							H303							
26							H303							
27							H303							
28							H303							
29							H303							
30							H303							
31							H303							
32							H303							
33							H303							
34							H303							
35							H303							
36							H303							
37							H303							
38							H303							
39							H303							
40							H303							
41							H303							
42							H303							
43							H303							
44							H303							
45							H303							
46							H353							
47							H353							
48							H353							
49							H353							
50														
51														
52							H303							
53														
54														
55							H303							
56														
57														
58							H303							
59														
60														

REAR / ARRIÈRE / HINTEN / POSTERIOR / POSTERIORE

R Suffix = High Durability Sintered Pad. **HH** Suffix = High Performance Sintered Pad. **TT** Suffix = Hard Wearing Off Road Pad. **V** Suffix = Semi Sintered Pad. **G** Suffix = Grooved Shoe.
D Suffix = Drilled Disc. **X** Suffix = Universal Left or Right Disc. **XC** Suffix = Contoured Disc. **LS** Suffix = Left/Steel Disc. **RS** = Right/Steel Disc.

*-2 Sets Required. † For Vee disc colours add RED, BLU, GRN, GLD, ORG suffix to part number.
 Ⓢ - Also available as a Vintage Motorcycle Disc.

Part numbers, prefixes, suffixes, photos and illustrations shown in this catalogue are trademarks and/or copyrights of EBC Brakes or the trademark owner A C Freeman Investments Ltd and use without express written permission of the owners is punishable by law.

Non-JAPANESE Built Motorcycles



PEUGEOT Contd.



DISC PAD CHOICES - FRONT

BRAKE DISC CHOICES - FRONT

R Suffix = High Durability Sintered Pad. HH Suffix = High Performance Sintered Pad. TT Suffix = Hard Wearing Off Road Pad. V Suffix = Semi Sintered Pad. G Suffix = Grooved Shoe.

D Suffix = Drilled Disc. X Suffix = Universal Left or Right Disc. XC Suffix = Contoured Disc. LS Suffix = Left/Steel Disc. RS = Right/Steel Disc.

FRONT / AVANT / VORN / FRENTE / ANTERIORE

		FA, SFA, TT Pad or Brake Shoe	SFAC Carbon Scooter Pads	Speciality Pads - SXR / Vee / MXS	Sintered/HH Pads/ Grooved Shoes	Left / Gauche / Links Standard Replacement Disc	Right / Droite / Rechts Standard Replacement Disc	Contour Disc Universal left and right fitment	Universal Custom Disc	Vee-Discs Black † See note below	CX Extreme MX Race Disc/ UTVX Disc	Line #
Speedake 50cc (Countersunk disc)												1
- Grimeca Wheels - AJP Caliper												2
- check pad shape before ordering	95-01	SFA115	SFAC115		SFA115HH	MD901D				VR901		3
Speedfight 50 1/2 (Air Cooled) Rear Drum Models												4
- AJP Calipers	97-08	SFA115	SFAC115		SFA115HH	MD925D		MD925C		VR925		5
Speedfight 50 1/2 (Air Cooled) Rear Drum Models												6
- Heng Tong Calipers	97-08	SFA083	SFAC083		SFA083HH	MD925D		MD925C		VR925		7
Speedfight 50 1/2 (LC) Front & Rear Disc Models												8
- AJP Calipers	97-08	SFA115	SFAC115		SFA115HH	MD925D		MD925C		VR925		9
Speedfight 50 1/2 (LC) Front & Rear Disc Models												10
- Heng Tong Calipers	97-08	SFA083	SFAC083		SFA083HH	MD925D		MD925C		VR925		11
Speedfight 3 (50cc A/C - 2T)	09-15	SFA086	SFAC086		SFA086HH			N/A				12
Speedfight 3 (50cc L/C - 2T)	09-15	SFA086	SFAC086		SFA086HH			N/A				13
Speedfight 3 RS (50cc A/C - 2T)	10-12	SFA086	SFAC086		SFA086HH			N/A				14
Speedfight 3 RS (50cc L/C - 2T)	09-12	SFA086	SFAC086		SFA086HH			N/A				15
Speedfight 3 Darkside (50cc A/C - 2T)	13-15	SFA086	SFAC086		SFA086HH			N/A				16
Speedfight 3 Darkside (50cc L/C - 2T)	13-15	SFA086	SFAC086		SFA086HH			N/A				17
Speedfight Furious 3 (50cc L/C - 2T)	13	SFA086	SFAC086		SFA086HH			N/A				18
Speedfight 3 Iceblade (50cc A/C - 2T)	13-15	SFA086	SFAC086		SFA086HH			VR9180C				19
Speedfight 3 Iceblade (50cc L/C - 2T)	13-15	SFA086	SFAC086		SFA086HH			VR9180C				20
Speedfight 4 Classic (50cc/AC/2T & 4T)	15-20	SFA086	SFAC086		SFA086HH			VR9180C				21
Speedfight 4 Classic (50cc/LC/2T & 4T)	15-20	SFA086	SFAC086		SFA086HH			VR9180C				22
Speedfight 4 Darkside (50cc/AC/2T & 4T)	15-18	SFA086	SFAC086		SFA086HH			VR9180C				23
Speedfight 4 Darkside (50cc/LC/2T & 4T)	15-18	SFA086	SFAC086		SFA086HH			VR9180C				24
Speedfight 4 Iceblade (50cc/AC/2T & 4T)	15-18	SFA086	SFAC086		SFA086HH			VR9180C				25
Speedfight 4 Iceblade (50cc/LC/2T & 4T)	15-18	SFA086	SFAC086		SFA086HH			VR9180C				26
Speedfight 4 Pure (50cc/AC/2T & 4T)	15-18	SFA086	SFAC086		SFA086HH			VR9180C				27
Speedfight 4 Pure (50cc/LC/2T & 4T)	15-18	SFA086	SFAC086		SFA086HH			VR9180C				28
Speedfight 4 R-Cup (50cc/LC/2T)	18-20	SFA086	SFAC086		SFA086HH			VR9180C				29
Speedfight 4 20 Ans Edition (50cc/AC/2T)	18	SFA086	SFAC086		SFA086HH			VR9180C				30
Speedfight Air (13-inch Wheels)	20-21	SFA086	SFAC086		SFA086HH			VR9180C				31
Speedfight Air Darkside (13" Wheels)	20-21	SFA086	SFAC086		SFA086HH			VR9180C				32
Speedfight Air R-Cup (13" Wheels)	20-21	SFA086	SFAC086		SFA086HH			VR9180C				33
Speedfight Air Sportline (13" Wheels)	20-21	SFA086	SFAC086		SFA086HH			VR9180C				34
Squab 50cc (Counterbored disc)												35
- Leleu Wheels - Hengtong caliper												36
- check pad shape before ordering	95-01	SFA083	SFAC083		SFA083HH	MD909D						37
Squab 50cc (Counterbored disc)												38
- Leleu Wheels - AJP Caliper												39
- check pad shape before ordering	95-01	SFA115	SFAC115		SFA115HH	MD909D						40
Squab 50cc (Countersunk disc)												41
- Grimeca Wheels - Hengtong caliper												42
- check pad shape before ordering	95-01	SFA083	SFAC083		SFA083HH	MD901D				VR901		43
Squab 50cc (Countersunk disc)												44
- Grimeca Wheels - AJP Caliper												45
- check pad shape before ordering	95-01	SFA115	SFAC115		SFA115HH	MD901D				VR901		46
Streetzone 12 (50cc/2T)	14-18	SFA115	SFAC115		SFA115HH			TBA				47
SV 50/80/125 (Geo) (Counterbored disc)												48
- Leleu Wheels - Nissin Caliper												49
- check pad shape before ordering	91-92	SFA131/2			SFA131/2HH	MD909D						50
SV 50/80/125 (Geo) (Counterbored disc)												51
- Leleu Wheels - Hengtong Caliper												52
- check pad shape before ordering	91-92	SFA083			SFA083HH	MD909D						53
SV 50/80/125 (Geo) (Countersunk disc)												54
- Grimeca Wheels - Nissin Caliper												55
- check pad shape before ordering	93-	SFA131/3			SFA131/3HH	MD901D				VR901		56
SV 50/80/125 (Geo) (Countersunk disc)												57
- Grimeca Wheels - Hengtong Caliper												58
- check pad shape before ordering	93-	SFA083			SFA083HH	MD901D				VR901		59
SV 50 J (Front drum model) (Geo)	91-95	H303										60

*-2 Sets Required. † For Vee disc colours add RED, BLU, GRN, GLD, ORG suffix to part number.

⊗ - Also available as a Vintage Motorcycle Disc.

Non-JAPANESE Built Motorcycles

Line #	BRAKE DISC CHOICES - FRONT						DISC PAD CHOICES - REAR				BRAKE DISC CHOICES - REAR			
	Oversize 250 /280mm Disc Kit	OSX Oversize 250/280mm Disc Kit	Relocating Bracket for 250/ 280mm Disc	Oversize 320mm Disc Kit	SMX Oversize 320mm Disc Kit	Relocating Bracket for 320mm Disc	FA, SFA, TT Pad or Brake Shoe	SFAC Carbon Scooter Pads	Speciality Pads - SXR / Vee / MXS	Sintered/ HH Pads/ Grooved Shoes	Standard Replacement Disc	Contour Disc Rear fitment	Vee-Discs™ CONTOUR	CX Extreme MX Race Disc/ UTVX Disc
1														
2														
3							H303							
4														
5							H303							
6														
7							SFA260	SFAC260		SFA260HH	MD925D	MD925C	VR925	
8														
9							SFA115	SFAC115		SFA115HH	MD925D	MD925C	VR925	
10														
11							SFA260	SFAC260		SFA260HH	MD925D	MD925C	VR925	
12							H353							
13							SFA266	SFAC266		SFA266HH		N/A		
14							SFA266	SFAC266		SFA266HH		N/A		
15							SFA266	SFAC266		SFA266HH		N/A		
16							H353							
17							SFA266	SFAC266		SFA266HH		N/A		
18							SFA266	SFAC266		SFA266HH		N/A		
19							H353							
20							SFA266	SFAC266		SFA266HH		N/A		
21							H353							
22							SFA266	SFAC266		SFA266HH		N/A		
23							H353							
24							SFA266	SFAC266		SFA266HH		N/A		
25							H353							
26							SFA266	SFAC266		SFA266HH		N/A		
27							H353							
28							SFA266	SFAC266		SFA266HH		N/A		
29							SFA266	SFAC266		SFA266HH		N/A		
30							H353							
31							SFA266	SFAC266		SFA266HH				
32							SFA266	SFAC266		SFA266HH				
33							SFA266	SFAC266		SFA266HH				
34							SFA266	SFAC266		SFA266HH				
35														
36														
37							H303							
38														
39														
40							H303							
41														
42														
43							H303							
44														
45														
46							H303							
47							H353							
48														
49														
50							H303							
51														
52														
53							H303							
54														
55														
56							H303							
57														
58														
59							H303							
60							H303							

REAR / ARRIÈRE / HINTEN / POSTERIOR / POSTERIORE

R Suffix = High Durability Sintered Pad. **HH** Suffix = High Performance Sintered Pad. **TT** Suffix = Hard Wearing Off Road Pad. **V** Suffix = Semi Sintered Pad. **G** Suffix = Grooved Shoe.
D Suffix = Drilled Disc. **X** Suffix = Universal Left or Right Disc. **XC** Suffix = Contoured Disc. **LS** Suffix = Left/Steel Disc. **RS** = Right/Steel Disc.

*-2 Sets Required. † For Vee disc colours add RED, BLU, GRN, GLD, ORG suffix to part number.
 Ⓢ - Also available as a Vintage Motorcycle Disc.

Part numbers, prefixes, suffixes, photos and illustrations shown in this catalogue are trademarks and/or copyrights of EBC Brakes or the trademark owner A C Freeman Investments Ltd and use without express written permission of the owners is punishable by law.

Non-JAPANESE Built Motorcycles



PEUGEOT Contd.



DISC PAD CHOICES - FRONT

BRAKE DISC CHOICES - FRONT

R Suffix = High Durability Sintered Pad. HH Suffix = High Performance Sintered Pad. TT Suffix = Hard Wearing Off Road Pad. V Suffix = Semi Sintered Pad. G Suffix = Grooved Shoe.

D Suffix = Drilled Disc. X Suffix = Universal Left or Right Disc. XC Suffix = Contoured Disc. LS Suffix = Left/Steel Disc. RS = Right/Steel Disc.

FRONT / AVANT / VORN / FRENTE / ANTERIORE

		FA, SFA, TT Pad or Brake Shoe	SFAC Carbon Scooter Pads	Speciality Pads - SXR / Vee / MXS	Sintered/HH Pads/ Grooved Shoes	Left / Gauche / Links Standard Replacement Disc	Right / Droite / Rechts Standard Replacement Disc	Contour Disc Universal left and right fitment	Universal Custom Disc	Vee-Discs Black † See note below	CX Extreme MX Race Disc/ UTVX Disc	Line #
Trekker (2T) AJP Caliper	98-00	SFA115	SFAC115		SFA115HH	MD901D				VR901		1
Trekker (2T) Heng Tong Caliper	98-00	SFA083	SFAC083		SFA083HH	MD901D				VR901		2
TRK 2WRC 50 (2T) (AJP Caliper)												3
- check pad shape before ordering	99-08	SFA115	SFAC115		SFA115HH	MD901D				VR901		4
TRK 2WRC 50 (2T) (Hengtong Caliper)												5
- check pad shape before ordering	99-08	SFA083	SFAC083		SFA083HH	MD901D				VR901		6
TRK 50 (2T/10" Wheels)	09-12	SFA115	SFAC115		SFA115HH	MD901D				VR901		7
TRK 50 12 (2T/12" Wheels)	09-12	SFA115	SFAC115		SFA115HH	MD901D				VR901		8
Tweet 50 (4T/Rear Drum Model)	10-13	SFA264	SFAC264		SFA264HH	MD9148D				VR9148		9
Tweet 50 RS (4T/Rear Disc Model)	10-13	SFA264	SFAC264		SFA264HH			N/A				10
New Tweet Evo 50 (4T/Rear Drum Model)	14-20	SFA264	SFAC264		SFA264HH	MD9148D						11
New Tweet Evo 50 RS (4T/Rear Disc Model)	14-15	SFA264	SFAC264		SFA264HH			N/A				12
V-Clic 50 (4T) (155mm F/disc)	08-13	SFA169	SFAC169		SFA169HH	MD904D				VR904		13
V-Clic 50 (4T) (160mm F/disc)	08-11	SFA169	SFAC169		SFA169HH	TBA						14
Vogue 50 (2T)	08-09	H303										15
XP6 Enduro/Top Road 21" front wheel	03-10	FA115			FA115HH	N/A						16
XP6 Supermoto (17" front wheel/240mm disc)	03-09	FA115			FA115HH	N/A						17
XR6 (2T) 50	03-07	FA167			FA167HH	MD6318D						18
XPS 50 SM	09	FA093				N/A						19
XPS Enduro	03-09	FA115			FA115HH	N/A						20
XPS Supermoto (17" front wheel/260mm disc)	03-10	FA194			FA194HH	N/A						21
XPS Street (17" front wheel/280mm disc)	03-09	FA194			FA194HH	N/A						22
XPS 50 Track (21" F/Wheel)	11-12	FA093				N/A						23
XPS 50 Top Road (17" F/Wheel)	10-12	FA093				N/A						24
NK7 (50cc) Naked	09-12	FA399				N/A						25
XR7 (50cc) Full Fairing	08-12	FA399				N/A						26
Zenith LS 50cc (Counterbored disc)												27
- Leleu Wheels - AJP Caliper												28
- check pad shape before ordering	96-99	SFA115	SFAC115		SFA115HH					VR904		29
Zenith LS 50cc (Counterbored disc)												30
- Leleu Wheels - Hengtong Caliper												31
- check pad shape before ordering	96-99	SFA083	SFAC083		SFA083HH					VR904		32
Zenith LS 50cc (Countersunk disc)												33
- Grimeca Wheels - AJP Caliper												34
- check pad shape before ordering	96-99	SFA115	SFAC115		SFA115HH	MD914D						35
Zenith LS 50cc (Countersunk disc)												36
- Grimeca Wheels - Hengtong Caliper												37
- check pad shape before ordering	96-99	SFA083	SFAC083		SFA083HH	MD914D						38
Zenith M/N 50cc	96-00	H303										39
Elyseo 100	98-02	SFA115	SFAC115		SFA115HH	MD947D				VR947		40
Elyseo 100	03	SFA115	SFAC115		SFA115HH	MD947D				VR947		41
LooXoR 100 (All models)	01-04	SFA115	SFAC115		SFA115HH	MD954D				VR954		42
Kissbee 100 (4T)	12-14	SFA083	SFAC083		SFA083H	TBA						43
Speedfight 100 39844 (AJP Calipers Front & Rear All models)	97-07	SFA115	SFAC115		SFA115HH	MD925D		MD925C		VR925		44
Streetzone 100 (4T)	14-15	SFA115	SFAC115		SFA115HH			TBA				45
SV 100 L		SFA116				MD901D				VR901		46
Trekker 100 (2T) AJP Caliper	98-00	SFA115	SFAC115		SFA115HH	MD901D				VR901		47
VOX 110 (4T)	12-13	SFA635						N/A				48
Belville 125 Allure	18-21	SFA264	SFAC264		SFA164HH							49
Belville 125 RS	18-21	SFA264	SFAC264		SFA164HH							50
City Star 125 (AC/Carb)	11-15	SFA228	SFAC228		SFA228HH	TBA						51
City Star 125 I Active (LC)	13-14	SFA228	SFAC228		SFA228HH	TBA						52
City Star 125 I Active (LC)	14-19	SFA228	SFAC228		SFA228HH	TBA						53
City Star 125 Blue Line (AC/Carb)	15	SFA228	SFAC228		SFA228HH	TBA						54
Django 125 Allure (4T/190mm Rear Disc)	14-21	SFA603	SFAC603		SFA603HH	MD9141D						55
Django 125 Allure SBC (4T/190mm Rear Disc)	14-21	SFA603	SFAC603		SFA603HH	MD9141D						56
Django 125 Evasion (4T/190mm Rear Disc)	14-21	SFA603	SFAC603		SFA603HH	MD9141D						57
Django 125 Evasion SBC (4T/190mm Rear Disc)	14-21	SFA603	SFAC603		SFA603HH	MD9141D						58
Django 125 Heritage (4T/190mm Rear Disc)	14-21	SFA603	SFAC603		SFA603HH	MD9141D						59
Django 125 Heritage SBC (4T/190mm Rear Disc)	14-21	SFA603	SFAC603		SFA603HH	MD9141D						60

*-2 Sets Required. † For Vee disc colours add RED, BLU, GRN, GLD, ORG suffix to part number.

⊗ - Also available as a Vintage Motorcycle Disc.

Non-JAPANESE Built Motorcycles

Line #	BRAKE DISC CHOICES - FRONT						DISC PAD CHOICES - REAR				BRAKE DISC CHOICES - REAR			
	Oversize 250 /280mm Disc Kit	OSX Oversize 250/280mm Disc Kit	Relocating Bracket for 250/ 280mm Disc	Oversize 320mm Disc Kit	SMX Oversize 320mm Disc Kit	Relocating Bracket for 320mm Disc	FA, SFA, TT Pad or Brake Shoe	SFAC Carbon Scooter Pads	Speciality Pads - SXR / Vee / MXS	Sintered/ HH Pads/ Grooved Shoes	Standard Replacement Disc	Contour Disc Rear fitment	Vee-Discs™ CONTOUR	CX Extreme MX Race Disc/ UTVX Disc
1							H303							
2							H303							
3														
4							H303							
5														
6							H303							
7							H303							
8							H303							
9							H307							
10							SFA260	SFAC260		SFA260HH		N/A		
11							H307							
12							SFA260	SFAC260		SFA260HH		N/A		
13							H303							
14							H303							
15							H303							
16							FA115			FA115HH	N/A			
17							FA115			FA115HH	N/A			
18							FA115			FA115HH	N/A			
19							FA093				N/A			
20							FA115			FA115HH	N/A			
21							FA115			FA115HH	N/A			
22							FA115			FA115HH	N/A			
23							FA115				N/A			
24							FA115				N/A			
25							FA093				N/A			
26							FA093				N/A			
27														
28														
29							H303							
30														
31														
32							H303							
33														
34														
35							H303							
36														
37														
38							H303							
39							H303							
40							H303							
41							SFA115	SFAC115		SFA115HH	MD925D		VR925	
42							SFA115	SFAC115		SFA115HH	MD901D		VR901	
43							H307							
44							SFA115	SFAC115		SFA115HH	MD925D	MD925C	VR925	
45							H307							
46							H303							
47							H303							
48							H303							
49							SFA266	SFAC266		SFA266HH	TBA			
50							SFA260	SFAC260		SFA260HH	TBA			
51							SFA260	SFAC260		SFA260HH	TBA			
52							SFA260	SFAC260		SFA260HH	TBA			
53							SFA260	SFAC260		SFA260HH	TBA			
54							SFA067	SFAC067		SFA067HH	TBA			
55							SFA067	SFAC067		SFA067HH	MD9167D			
56							SFA067	SFAC067		SFA067HH	MD9167D			
57							SFA067	SFAC067		SFA067HH	MD9167D			
58							SFA067	SFAC067		SFA067HH	MD9167D			
59							SFA266	SFAC266		SFA266HH	MD9170D			
60							SFA067	SFAC067		SFA067HH	MD9167D			

REAR / ARRIÈRE / HINTEN / POSTERIOR / POSTERIORE

R Suffix = High Durability Sintered Pad. HH Suffix = High Performance Sintered Pad. TT Suffix = Hard Wearing Off Road Pad. V Suffix = Semi Sintered Pad. G Suffix = Grooved Shoe.
D Suffix = Drilled Disc. X Suffix = Universal Left or Right Disc. XC Suffix = Contoured Disc. LS Suffix = Left/Steel Disc. RS = Right/Steel Disc.

*-2 Sets Required. † For Vee disc colours add RED, BLU, GRN, GLD, ORG suffix to part number.
⊗ - Also available as a Vintage Motorcycle Disc.

Part numbers, prefixes, suffixes, photos and illustrations shown in this catalogue are trademarks and/or copyrights of EBC Brakes or the trademark owner A C Freeman Investments Ltd and use without express written permission of the owners is punishable by law.

Non-JAPANESE Built Motorcycles



PEUGEOT Contd.



DISC PAD CHOICES - FRONT

BRAKE DISC CHOICES - FRONT

R Suffix = High Durability Sintered Pad. **HH** Suffix = High Performance Sintered Pad. **TT** Suffix = Hard Wearing Off Road Pad. **V** Suffix = Semi Sintered Pad. **G** Suffix = Grooved Shoe.

D Suffix = Drilled Disc. **X** Suffix = Universal Left or Right Disc. **XC** Suffix = Contoured Disc. **LS** Suffix = Left/Steel Disc. **RS** = Right/Steel Disc.

FRONT / AVANT / VORN / FRENTE / ANTERIORE

Line #

		FA, SFA, TT Pad or Brake Shoe	SFAC Carbon Scooter Pads	Speciality Pads - SXR / Vee / MXS	Sintered/HH Pads/ Grooved Shoes	Left / Gauche / Links Standard Replacement Disc	Right / Droite / Rechts Standard Replacement Disc	Contour Disc Universal left and right fitment	Universal Custom Disc	Vee-Discs Black † See note below	CX Extreme MX Race Disc/ UTVX Disc
Django 125 S (4T/190mm Rear Disc)	14-21	SFA603	SFAC603		SFA603HH	MD9141D					
Django 125 Sport (4T/190mm Rear Disc)	14-21	SFA603	SFAC603		SFA603HH	MD9141D					
Django 125 Sport SBC (4T/190mm Rear Disc)	14-21	SFA603	SFAC603		SFA603HH	MD9141D					
E-Metropolis Electric	19										
Elyseo 125/150 (Drum Rear model)											
(AJP Caliper - check pad shape before ordering)	98-01	SFA115	SFAC115		SFA115HH	MD947D				VR947	
Elyseo 125/150 (Drum Rear model) (Hengtong Caliper - check pad shape before ordering)	98-01	SFA083	SFAC083		SFA083HH	MD947D				VR947	
Elyseo 125/150 Rear Disc Model	03	SFA194	SFAC194		SFA194HH	MD977D					
Elystar 125/150 (3 bolt fixing front disc)	02-05	SFA194	SFAC194		SFA194HH	MD977D					
Elystar 125/150 (5 bolt fixing front disc)	06-07	SFA194	SFAC194		SFA194HH	MD980D					
Geo RS 125 (Nissin Calipers)	07-12	SFA228	SFAC228		SFA228HH	MD9111D				VR9111	
Geopolis 125 Executive (AJP Caliper/Non ABS)	07-12	SFA194	SFAC194		SFA194HH	MD9111D				VR9111	
Geopolis 125 Premium (Nissin Caliper/Non ABS)	07-12	SFA228	SFAC228		SFA228HH	MD9111D				VR9111	
Geopolis 125 Urban (AJP Caliper/ABS)	07-12	SFA194	SFAC194		SFA194HH	TBA					
Geopolis 125 (AJP Caliper/ABS)	07-12	SFA194	SFAC194		SFA194HH	MD9111D				VR9111	
Jet Force 125 (All models)	03-07	SFA194	SFAC194		SFA194HH	MD980D					
LooXoR 125/150	03-06	SFA324	SFAC324		SFA324HH	MD954D				VR954	
Ludix Ambition (14" wheels) 125cc (Counterbored disc - Leleu Wheels)	04	SFA115	SFAC115		SFA115HH	MD909D					
Ludix Ambition (14" wheels) 125cc (Countersunk disc - Grimeca Wheels)	04	SFA115	SFAC115		SFA115HH	MD901D				VR901	
LXR 125 (4T)	10-13	SFA264	SFAC264		SFA264HH	TBA					
Pulsion Active 125	19										
Pulsion Allure 125	19										
Pulsion RS 125	19										
E-Vivacity (Electric)	10	SFA235	SFAC235			TBA					
e-Satelis	11-13	SFA228	SFAC228		SFA228HH	TBA					
Satelis 125 4V Executive/Premium/City (4 stroke/4 valve)	06-09	SFA194	SFAC194		SFA194HH	MD9111D				VR9111	
Satelis 125 Blacksat (AJP Calipers)	10-11	SFA194	SFAC194		SFA194HH	N/A					
Satelis 125 Compressor (4T)	06-11	SFA194	SFAC194		SFA194HH	MD9111D				VR9111	
Satelis 125 Urban (AJP Caliper/ABS)	07-11	SFA194	SFAC194		SFA194HH	N/A					
Satelis 125 RS (AJP Caliper)	07-13	SFA194	SFAC194		SFA194HH	N/A					
Satelis 125 Whitesat (AJP Calipers)	10-11	SFA194	SFAC194		SFA194HH	N/A					
Satelis 125 Avenue (Nissin Calipers)	08-09	SFA228	SFAC228		SFA228HH	TBA					
Satelis 125	13	SFA603	SFAC603		SFA603HH	N/A					
Satelis 125 RS (4T)	13	SFA228	SFAC228		SFA228HH	TBA					
Satelis 125 Blue Line	15	SFA228	SFAC228		SFA228HH	N/A					
Speedfight 125 (4T)	14-15	SFA086	SFAC086		SFA086HH	N/A					
Speedfight 125 Darkside (4T)	14-15	SFA086	SFAC086		SFA086HH			N/A			
Speedfight 125 Iceblade (4T)	14-15	SFA086	SFAC086		SFA086HH			N/A			
Speedfight 125 Team (4T)	14-15	SFA086	SFAC086		SFA086HH			N/A			
Speedfight 4 125 (4T)	17-21	SFA603	SFAC603		SFA603HH					VR9180C	
Speedfight 125 4 I R-Cup SBC 13" Wheels	18-21	SFA603	SFAC603		SFA603HH					VR9180C	
Speedfight 4 SBC 13" Wheels	18-21	SFA603	SFAC603		SFA603HH					VR9180C	
Sum-Up (125cc)	08-11	SFA054	SFAC054		SFA054HH		N/A				
Tweet 125 (4T/Rear Drum Model)	10-12	SFA264	SFAC264		SFA264HH	MD9137D				VR9137	
Tweet 125 (4T/Rear Disc Model)	12-13	SFA264	SFAC264		SFA264HH	MD9148D		TBA		VR9148	
Tweet 125 RS (4T/Rear Disc Model)	10-13	SFA264	SFAC264		SFA264HH			TBA			
New Tweet Evo 125 (4T)	14-20	SFA264	SFAC264		SFA264HH	MD9148D				VR9148	
New Tweet Evo RS 125 (4T)	14-20	SFA264	SFAC264		SFA264HH			N/A			
WTR 125	08	FA197			FA197HH		TBA				
XPS 125 CT	05-07	FA115			FA115HH	N/A					
XP 125 Street Evo 2	05	FA167			FA167HH	N/A					
Vivacity 125 (4T)	10-15	SFA228	SFAC228		SFA228HH	MD9141D				VR9141	
Vivacity Sixties 125 (4T)	11-12	SFA228	SFAC228		SFA228HH	MD9141D				VR9141	
City Star One 150	13-14	SFA228	SFAC228		SFA228HH	TBA					
Django 150 Allure (4T/190mm Rear Disc)	14-21	SFA603	SFAC603		SFA603HH	MD9141D					
Django 150 Evasion (4T/190mm Rear Disc)	14-21	SFA603	SFAC603		SFA603HH	MD9141D					
Django 150 Heritage (4T/196mm Rear Disc)	14-21	SFA228	SFAC228		SFA228HH	MD9141D					

*-2 Sets Required. † For Vee disc colours add RED, BLU, GRN, GLD, ORG suffix to part number.

⊗ - Also available as a Vintage Motorcycle Disc.

Non-JAPANESE Built Motorcycles

Line #	BRAKE DISC CHOICES - FRONT						DISC PAD CHOICES - REAR				BRAKE DISC CHOICES - REAR			
	Oversize 250 /280mm Disc Kit	OSX Oversize 250/280mm Disc Kit	Relocating Bracket for 250/ 280mm Disc	Oversize 320mm Disc Kit	SMX Oversize 320mm Disc Kit	Relocating Bracket for 320mm Disc	FA, SFA, TT Pad or Brake Shoe	SFAC Carbon Scooter Pads	Speciality Pads - SXR / Vee / MXS	Sintered/ HH Pads/ Grooved Shoes	Standard Replacement Disc	Contour Disc Rear fitment	Vee-Discs™ CONTOUR	CX Extreme MX Race Disc/ UTVX Disc
1							SFA067	SFAC067		SFA067HH	MD9167D			
2							SFA067	SFAC067		SFA067HH	MD9167D			
3							SFA067	SFAC067		SFA067HH	MD9167D			
4														
5														
6							857							
7														
8							857							
9							SFA350	SFAC350		SFA350HH	MD978D	MD978C		
10							SFA350	SFAC350		SFA350HH	MD978D	MD978C		
11							SFA350	SFAC350		SFA350HH	MD978D	MD978C		
12							SFA228	SFAC228		SFA228HH	N/A			
13							SFA350	SFAC350		SFA350HH	TBA			
14							SFA228	SFAC228		SFA228HH	TBA			
15							SFA350	SFAC350		SFA350HH	TBA			
16							SFA350	SFAC350		SFA350HH	TBA			
17							SFA350	SFAC350		SFA350HH	MD978D	MD978C		
18							SFA115	SFAC115		SFA115HH	MD9121D			
19														
20							H303							
21														
22							H303							
23							SFA427	SFAC427		SFA427HH	TBA			
24														
25														
26														
27							H303							
28							SFA228	SFAC228		SFA228HH	TBA			
29							SFA350	SFAC350		SFA350HH	MD978D	MD978C	VR978	
30							SFA350	SFAC350		SFA350HH	MD978D	MD978C		
31							SFA350	SFAC350		SFA350HH	MD978D	MD978C	VR978	
32							SFA350	SFAC350		SFA350HH	MD978D	MD978C		
33							SFA350	SFAC350		SFA350HH	MD978D	MD978C		
34							SFA350	SFAC350		SFA350HH	MD978D	MD978C		
35							SFA228	SFAC228		SFA228HH	MD978D	MD978C		
36							SFA260			SFA260HH	N/A			
37							SFA260			SFA260HH	N/A			
38							SFA260			SFA260HH	N/A			
39							SFA266	SFAC266		SFA266HH	N/A			
40							SFA266	SFAC266		SFA266HH	MD9170D	N/A	VR9167	
41							SFA266	SFAC266		SFA266HH	MD9170D	N/A		
42							SFA266	SFAC266		SFA266HH		N/A		
43							SFA083			SFA083HH				
44							SFA083			SFA083HH				
45							SFA083			SFA083HH				
46							Y506							
47							Y506							
48							SFA260	SFAC260		SFA260HH	MD9149D	TBA		
49							SFA260	SFAC260		SFA260HH	TBA	TBA		
50							SFA260	SFAC260		SFA260HH	MD9149D			
51							SFA260	SFAC260		SFA260HH		N/A		
52							TBA							
53							FA115			FA115HH	N/A			
54							FA115			FA115HH	N/A			
55							Y506							
56							Y506							
57							SFA260	SFAC260		SFA260HH	TBA			
58							SFA067	SFAC067		SFA067HH	MD9167D		VR9167	
59							SFA067	SFAC067		SFA067HH	MD9167D		VR9167	
60							SFA266	SFAC266		SFA266HH	MD9170D		VR9170	

REAR / ARRIÈRE / HINTEN / POSTERIOR / POSTERIORE

R Suffix = High Durability Sintered Pad. **HH** Suffix = High Performance Sintered Pad. **TT** Suffix = Hard Wearing Off Road Pad. **V** Suffix = Semi Sintered Pad. **G** Suffix = Grooved Shoe.
D Suffix = Drilled Disc. **X** Suffix = Universal Left or Right Disc. **XC** Suffix = Contoured Disc. **LS** Suffix = Left/Steel Disc. **RS** = Right/Steel Disc.

*-2 Sets Required. † For Vee disc colours add RED, BLU, GRN, GLD, ORG suffix to part number.
 ☉ - Also available as a Vintage Motorcycle Disc.

Part numbers, prefixes, suffixes, photos and illustrations shown in this catalogue are trademarks and/or copyrights of EBC Brakes or the trademark owner A C Freeman Investments Ltd and use without express written permission of the owners is punishable by law.

Non-JAPANESE Built Motorcycles



PEUGEOT Contd.



		DISC PAD CHOICES - FRONT				BRAKE DISC CHOICES - FRONT						Line #
		FA, SFA, TT Pad or Brake Shoe	SFAC Carbon Scooter Pads	Speciality Pads - SXR / Vee / MXS	Sintered/HH Pads/ Grooved Shoes	Left / Gauche / Links Standard Replacement Disc	Right / Droite / Rechts Standard Replacement Disc	Contour Disc Universal left and right filament	Universal Custom Disc	Vee-Discs Black † See note below	CX Extreme MX Race Disc/ UTVX Disc	
Django 150 S (4T) (4T/190mm Rear Disc)	14-21	SFA603	SFAC603		SFA603HH	MD9141D						1
Django 150 Sport (4T/190mm Rear Disc)	14-21	SFA603	SFAC603		SFA603HH	MD9141D						2
Tweet 150 (4T/Rear Drum Model)	10-12	SFA264	SFAC264		SFA264HH	MD9137D				VR9137		3
Tweet 150 RS (4T/Rear Disc Model)	10-12	SFA264	SFAC264		SFA264HH				TBA			4
City Star 150 (AC/Carb)	11-15	SFA228	SFAC228		SFA228HH		TBA					5
City Star 150 i (LC)	13-15	SFA228	SFAC228		SFA228HH		TBA					6
New Tweet Evo 150 (4T)	14-19	SFA264	SFAC264		SFA264HH	MD9148D				VR9148		7
New Tweet Evo RS 150 (4T)	14-19	SFA264	SFAC264		SFA264HH				N/A			8
Belville 200 Allure	18-21	SFA264	SFAC264		SFA264HH				N/A			9
Belville 200 RS	18-21	SFA264	SFAC264		SFA264HH				N/A			10
City Star 200 i	12-18	SFA228	SFAC228		SFA228HH		TBA					11
LXR 200i (4T)	10-11	SFA264	SFAC264		SFA264HH		TBA					12
Geo 250 (Nissin Caliper)	07-11	SFA228	SFAC228		SFA228HH	MD9111D				VR9111		13
Geopolis 250 Executive (AJP caliper/Non ABS)	07-11	SFA194	SFAC194		SFA194HH	MD9111D				VR9111		14
Geopolis 250 Premium (Nissin caliper/Non ABS)	07-11	SFA228	SFAC228		SFA228HH	MD9111D				VR9111		15
Geopolis 250 Urban (AJP caliper/ABS)	07-11	SFA194	SFAC194		SFA194HH	MD9111D				VR9111		16
Satelis 250 Premium (Nissin Calipers)	07-12	SFA228	SFAC228		SFA228HH		TBA					17
Satelis 250 Urban (AJP Caliper/ABS)	07-12	SFA194	SFAC194		SFA194HH		N/A					18
Satelis 250 RS (Nissin Calipers)	07-12	SFA228	SFAC228		SFA228HH		TBA					19
SV 250	01-02	SFA281	SFAC281		SFA281HH	MD922D				VR922		20
SV 250 - Parking brake	01-02	H351										21
Geo RS 300 (Nissin Calipers)	10-12	SFA228	SFAC228		SFA228HH	MD9111D				VR9111		22
Geopolis 300	10-15	SFA228	SFAC228		SFA228HH	MD9111D				VR9111		23
Geostyle 300 (Nissin Calipers)	10-12	SFA228	SFAC228		SFA228HH	MD9111D				VR9111		24
Geopolis 300 GT	14	SFA142*	SFAC142*		SFA142HH*		TBA	TBA				25
Satelis 300 (4T)	13	SFA228	SFAC228		SFA228HH		N/A					26
Satelis 2 300 (4T)	14-15	SFA228	SFAC228		SFA228HH		N/A					27
Geo RS 400 (Nissin Calipers)	08-12	SFA228	SFAC228		SFA228HH	MD9111D				VR9111		28
Geopolis 400 Premium (Nissin Caliper/Non ABS)	07-12	SFA228	SFAC228		SFA228HH	MD9111D				VR9111		29
Geopolis 400 Urban (AJP Caliper/ABS)	07-12	SFA194	SFAC194		SFA194HH	MD9111D				VR9111		30
Metropolis 400T (3 Wheel Model)	14-16	SFA650*	SFAC650*		SFA650HH*		N/A	N/A				31
- Parking brake		SFA083										32
Metropolis 400T-RS (3 Wheel Model)	14-16	SFA650*	SFAC650*		SFA650HH*		N/A	N/A				33
- Parking brake		SFA083										34
Metropolis 400 Blue Line (3 Wheel Model)	15-16	SFA650*	SFAC650*		SFA650HH*		N/A	N/A				35
- Parking brake		SFA083										36
Metropolis 400 RS (3 Wheel Model/Nissin Caliper)	17-21	FA410TT*			FA410R*							37
- Parking Brake		SFA083										38
Metropolis 400 RX-R (3 Wheel Model/Nissin Caliper)	17-21	SFA415*	SFAC415*		SFA415HH*		N/A					39
- Parking Brake		SFA083										40
Metropolis 400 Allure (3 Wheel Model/Nissin Caliper)	17-21	SFA415*	SFAC415*		SFA415HH*		N/A					41
- Parking Brake		SFA083										42
Satelis 400 Premium (Nissin Calipers)	08-11	SFA142*	SFAC142*		SFA142HH*		N/A	N/A				43
Satelis 400 Urban (Nissin Calipers)	08-12	SFA142*	SFAC142*		SFA142HH*		N/A	N/A				44
Satelis 400 RS (Nissin Calipers)	08-12	SFA142*	SFAC142*		SFA142HH*		N/A	N/A				45
Satelis 2 400 (4T)	14-15	SFA142*	SFAC142*		SFA142HH*		N/A	N/A				46
Satelis 2 400 RS	14-15	SFA142*	SFAC142*		SFA142HH*		N/A	N/A				47
Geopolis 500	08-11	SFA142*	SFAC142*		SFA142HH*	MD9111D	MD9111D			VR9111*		48
Satelis 500	07-12	SFA142*	SFAC142*		SFA142HH*		TBA	TBA				49
Satelis 500 RS (Nissin Calipers)	08-12	SFA142*	SFAC142*		SFA142HH*		TBA	TBA				50
												51
												52
PETRONAS												53
FP1	05				FA322/4HH*		TBA	TBA				54
												55
PGO												56
idep Electric Scooter	09	SFA264	SFAC264		SFA264HH		N/A					57
Big Max 50	94-06	SFA169	SFAC169		SFA169HH	MD904D				VR904		58
Big Max 50 S	03-04	SFA264	SFAC264		SFA264HH		TBA					59
Big Max 50 (Front wave disc)	07-09	SFA264	SFAC264		SFA264HH				N/A			60
Big Max 50 Naked (Round disc/No Cover on handlebars)	07-09	SFA264	SFAC264		SFA264HH		N/A					60

FRONT / AVANT / VORN / FRENTE / ANTERIORE

R Suffix = High Durability Sintered Pad. HH Suffix = High Performance Sintered Pad. TT Suffix = Hard Wearing Off Road Pad. V Suffix = Semi Sintered Pad. G Suffix = Grooved Shoe.
D Suffix = Drilled Disc. X Suffix = Universal Left or Right Disc. XC Suffix = Contoured Disc. LS Suffix = Left/Steel Disc. RS = Right/Steel Disc.

*-2 Sets Required. † For Vee disc colours add RED, BLU, GRN, GLD, ORG suffix to part number.

⊗ - Also available as a Vintage Motorcycle Disc.

Non-JAPANESE Built Motorcycles

Line #	BRAKE DISC CHOICES - FRONT						DISC PAD CHOICES - REAR				BRAKE DISC CHOICES - REAR			
	Oversize 250 /280mm Disc Kit	OSX Oversize 250/280mm Disc Kit	Relocating Bracket for 250/ 280mm Disc	Oversize 320mm Disc Kit	SMX Oversize 320mm Disc Kit	Relocating Bracket for 320mm Disc	FA, SFA, TT Pad or Brake Shoe	SFAC Carbon Scooter Pads	Speciality Pads - SXR / Vee / MXS	Sintered/ HH Pads/ Grooved Shoes	Standard Replacement Disc	Contour Disc Rear fitment	Vee-Discs™ CONTOUR	CX Extreme MX Race Disc/ UTVX Disc
1							SFA067	SFAC067		SFA067HH	MD9167D		VR9167	
2							SFA067	SFAC067		SFA067HH	MD9167D		VR9167	
3							Y506							
4							SFA260	SFAC260		SFA260HH	TBA	TBA		
5							SFA260	SFAC260		SFA260HH	TBA			
6							SFA260	SFAC260		SFA260HH	TBA			
7							SFA260	SFAC260		SFA260HH	MD9149D			
8							SFA260	SFAC260		SFA260HH		N/A		
9							SFA260	SFAC260		SFA260HH		N/A		
10							SFA260	SFAC260		SFA260HH		N/A		
11							SFA260	SFAC260		SFA260HH	TBA			
12							SFA427	SFAC427		SFA427HH	TBA			
13							SFA228	SFAC228		SFA228HH	N/A			
14							SFA350	SFAC350		SFA350HH	N/A			
15							SFA228	SFAC228		SFA228HH	N/A			
16							SFA350	SFAC350		SFA350HH	N/A			
17							SFA228	SFAC228		SFA228HH	N/A			
18							SFA350	SFAC350		SFA350HH	N/A			
19							SFA228	SFAC228		SFA228HH	N/A			
20							SFA140			SFA140HH	MD1004		VR1004	
21														
22							SFA228	SFAC228		SFA228HH	N/A			
23							SFA228	SFAC228		SFA228HH	N/A			
24							SFA228	SFAC228		SFA228HH	N/A			
25							SFA228	SFAC228		SFA228HH	TBA			
26							SFA228	SFAC228		SFA228HH	N/A			
27							SFA228	SFAC228		SFA228HH	N/A			
28							SFA228	SFAC228		SFA228HH	N/A			
29							SFA228	SFAC228		SFA228HH	N/A			
30							SFA350	SFAC350		SFA350HH	N/A			
31							SFA650	SFAC650		SFA650HH	N/A			
32														
33							SFA650	SFAC650		SFA650HH	N/A			
34														
35							SFA650	SFAC650		SFA650HH	N/A			
36														
37							SFA228	SFAC228		SFA228HH	MD1156			
38														
39							SFA228	SFAC228		SFA228HH	MD1156			
40														
41							SFA228	SFAC228		SFA228HH	MD1156			
42														
43							SFA228	SFAC228		SFA228HH	N/A			
44							SFA228	SFAC228		SFA228HH	N/A			
45							SFA228	SFAC228		SFA228HH	N/A			
46							SFA228	SFAC228		SFA228HH	N/A			
47							SFA228	SFAC228		SFA228HH	N/A			
48							SFA228	SFAC228		SFA228HH	TBA			
49							SFA228	SFAC228		SFA228HH	TBA			
50							SFA228	SFAC228		SFA228HH	TBA			
51														
52														
53							FA266		FA266V	FA266HH	TBA			
54														
55														
56							SFA264	SFAC264			N/A			
57							897							
58							897							
59							897							
60							897							

REAR / ARRIÈRE / HINTEN / POSTERIOR / POSTERIORE

*-2 Sets Required. † For Vee disc colours add RED, BLU, GRN, GLD, ORG suffix to part number.
 ☉ - Also available as a Vintage Motorcycle Disc.

R Suffix = High Durability Sintered Pad. **HH** Suffix = High Performance Sintered Pad. **TT** Suffix = Hard Wearing Off Road Pad. **V** Suffix = Semi Sintered Pad. **G** Suffix = Grooved Shoe.
D Suffix = Drilled Disc. **X** Suffix = Universal Left or Right Disc. **XC** Suffix = Contoured Disc. **LS** Suffix = Left/Steel Disc. **RS** = Right/Steel Disc.

BRAKE APPLICATIONS

Non-JAPANESE Built Motorcycles



PGO Contd.



DISC PAD CHOICES - FRONT

BRAKE DISC CHOICES - FRONT

R Suffix = High Durability Sintered Pad. **HH** Suffix = High Performance Sintered Pad. **TT** Suffix = Hard Wearing Off Road Pad. **V** Suffix = Semi Sintered Pad. **G** Suffix = Grooved Shoe.

D Suffix = Drilled Disc. **X** Suffix = Universal Left or Right Disc. **XS** Suffix = Contoured Disc. **LS** Suffix = Left/Steel Disc. **RS** = Right/Steel Disc.

FRONT / AVANT / VORN / FRENTE / ANTERIORE

		FA, SFA, TT Pad or Brake Shoe	SFAC Carbon Scooter Pads	Speciality Pads - SXR / Vee / MXS	Sintered/HH Pads/ Grooved Shoes	Left / Gauche / Links Standard Replacement Disc	Right / Droite / Rechts Standard Replacement Disc	Contour Disc Universal left and right fitment	Universal Custom Disc	Vee-Discs Black † See note below	CX Extreme MX Race Disc/ UTVX Disc	Line #
Bugrider 50 (Buggie)	06	FA416TT*			FA416R*	N/A	N/A					1
EPS	97	SFA169	SFAC169		SFA169HH	MD904D				VR904		2
Galaxy 50	94-	SFA083	SFAC083		SFA083HH	MD939D						3
G-Max 50	05-07	SFA264	SFAC264		SFA264HH	N/A						4
G-Max 50 Naked (Wave disc)	09	SFA264	SFAC264		SFA264HH			N/A				5
G-Max 50 (Wave disc)	08-12	SFA264	SFAC264		SFA264HH			N/A				6
Libra 50 (2T)	09	SFA264	SFAC264		SFA264HH	N/A						7
Ligero 50 (2T)	08-12	SFA264	SFAC264		SFA264HH	N/A						8
Mega 50	94-	SFA083	SFAC083		SFA083HH	TBA						9
My Bubu 50	03	SFA193	SFAC193		SFA193HH	MD904D				VR904		10
PMX 50	00-07	SFA264	SFAC264		SFA264HH	MD923D				VR923		11
PMX 50 Naked		SFA264	SFAC264		SFA264HH	TBA						12
Rodo Show 50	00-09	SFA193	SFAC193		SFA193HH	TBA						13
T-Rex 50	99-12	SFA264	SFAC264		SFA264HH	MD923D				VR923		14
T-Rex 3 (50cc) (3 wheeler)	03-04	SFA264	SFAC264		SFA264HH	TBA						15
Tornado 50/125	97	SFA169	SFAC169		SFA169HH	MD904D				VR904		16
X Rider 50/90/110	04-05	TBA*										17
XL-Rider 50	07-08	TBA*										18
XL-Rider	07-08	TBA*										19
Bubu 100/125	03-08	SFA264	SFAC264		SFA264HH	MD923D				VR923		20
My Bubu 100/125	03-05	SFA264	SFAC264		SFA264HH	N/A						21
PMX 110	00-07	SFA264	SFAC264		SFA264HH	MD923D				VR923		22
T-Rex 110	99-06	SFA264	SFAC264		SFA264HH	MD923D				VR923		23
Charge 125 A/B	01-02	SFA264	SFAC264		SFA264HH	MD923D				VR923		24
G-Max 125	06-08	FA095			FA095HH	N/A						25
G-Max 125 (Wave disc)	09-12	FA095			FA095HH			N/A				26
i-Charge 125	03-05	SFA264	SFAC264		SFA264HH	N/A						27
Libra 125 EFI (4T)	09-12	SFA264	SFAC264		SFA264HH	N/A						28
Ligero 125	06-08	SFA264	SFAC264		SFA264HH	MD923D				VR923		29
Ligero 125 (4T)	08-12	SFA264	SFAC264		SFA264HH	N/A						30
Tigra 125 (4T/4V)	12	SFA264	SFAC264		SFA264HH			N/A				31
T/Rex 125	99-07	SFA264	SFAC264		SFA264HH	MD923D				VR923		32
T-Rex 125 (Wave disc)	08-12	SFA264	SFAC264		SFA264HH			N/A				33
Bugrider 150		FA416TT*			FA416R*	N/A	N/A					34
Bugxter BR 150 A	05-07	FA416TT*			FA416R*	N/A	N/A					35
Libra 150 (4T)	09	SFA264	SFAC264		SFA264HH	N/A						36
TR-3 150cc (3 wheeler)	03-09	SFA264	SFAC264		SFA264HH	N/A						37
X Rider 150	04-05	H338*			H338G*							38
BR-200 Bug Rider	07-12	FA416TT*			FA416R*	TBA	TBA					39
250 Bug		FA416TT*			FA416R*	N/A	N/A					40
BR 250 Bugrider E	05-12	FA416TT*			FA416R*	TBA	TBA					41
Bugrider 250 SS (Single seat)		FA416TT			FA416R	N/A	N/A					42
Bugrider 250		FA416TT			FA416R	N/A	N/A					43
G-Max 250	06-08	FA095			FA095HH	N/A						44
500 Bug	08-09	FA484TT*			FA484R*	N/A	N/A					45
500 Bug - Parking brake	08-09	FA232TT			FA232R							46
BR 500i Racer	07-09	FA484TT*			FA484R*	TBA	TBA					47
BR 600i Racer	12	FA484TT*			FA484R*	TBA	TBA					48
												49
												50
PHB												51
500	92	FA132			FA132R	N/A						52
560	92	FA067			FA067R	N/A						53
												54
PIAGGIO												55
Bravo 50 Alloy Wheels	73-81	909										56
Bravo 50 Spoke Wheels	73-81	N/A										57
Bravo 3	87-90	909										58
Ciao All models	71-99	909										59
Ciao Mix Teen 50	96-01	808										60
Ciao 50 Catalitico	99-05	909										61

*-2 Sets Required. † For Vee disc colours add RED, BLU, GRN, GLD, ORG suffix to part number.

⊗ - Also available as a Vintage Motorcycle Disc.

Non-JAPANESE Built Motorcycles

Line #	BRAKE DISC CHOICES - FRONT						DISC PAD CHOICES - REAR				BRAKE DISC CHOICES - REAR			
	Oversize 250 /280mm Disc Kit	OSX Oversize 250/280mm Disc Kit	Relocating Bracket for 250/ 280mm Disc	Oversize 320mm Disc Kit	SMX Oversize 320mm Disc Kit	Relocating Bracket for 320mm Disc	FA, SFA, TT Pad or Brake Shoe	SFAC Carbon Scooter Pads	Speciality Pads - SXR / Vee / MXS	Sintered/ HH Pads/ Grooved Shoes	Standard Replacement Disc	Contour Disc Rear fitment	Vee-Discs™ CONTOUR	CX Extreme MX Race Disc/ UTVX Disc
1							FA054TT			FA054R	N/A			
2							897							
3							897							
4							897							
5							897							
6							897							
7							TBA							
8							897							
9							897							
10							Y503							
11							897							
12							897							
13							897							
14							897							
15							TBA*							
16							897							
17							FA083TT			FA083R	N/A			
18							FA083TT			FA083R	N/A			
19							FA083TT			FA083R	N/A			
20							S602							
21							S602							
22							897							
23							897							
24							S624							
25							FA197			FA197HH	N/A			
26							FA197			FA197HH	N/A			
27							S602							
28							TBA							
29							S624							
30							S624							
31							SFA260			SFA260HH		N/A		
32							S602							
33							S602							
34							FA054TT			FA054R	N/A			
35							FA054TT			FA054R	N/A			
36							TBA							
37							TBA*							
38							FA083TT			FA083R	N/A			
39							FA431TT			FA431R	TBA			
40							FA431TT			FA431R	N/A			
41							FA431TT			FA431R	TBA			
42							FA054TT			FA054R	N/A			
43							FA054TT			FA054R	N/A			
44							SFA197			FA197HH	N/A			
45							FA377TT							
46														
47							FA377TT*			FA377R*	TBA*			
48							FA377TT*			FA377R*	TBA*			
49														
50														
51							FA067			FA067R	N/A			
52							FA067			FA067R	N/Boss 50	88-89	909	
53			V907											
54														
55							V907							
56							V907							
57							N/A							
58							V907							
59							V907							
60							V907							

REAR / ARRIÈRE / HINTEN / POSTERIOR / POSTERIORE

R Suffix = High Durability Sintered Pad. **HH** Suffix = High Performance Sintered Pad. **TT** Suffix = Hard Wearing Off Road Pad. **V** Suffix = Semi Sintered Pad. **G** Suffix = Grooved Shoe.
D Suffix = Drilled Disc. **X** Suffix = Universal Left or Right Disc. **XC** Suffix = Contoured Disc. **LS** Suffix = Left/Steel Disc. **RS** = Right/Steel Disc.

*-2 Sets Required. † For Vee disc colours add RED, BLU, GRN, GLD, ORG suffix to part number.

⊗ - Also available as a Vintage Motorcycle Disc.

Part numbers, prefixes, suffixes, photos and illustrations shown in this catalogue are trademarks and/or copyrights of EBC Brakes or the trademark owner A C Freeman Investments Ltd and use without express written permission of the owners is punishable by law.

Non-JAPANESE Built Motorcycles



PIAGGIO Contd.



DISC PAD CHOICES - FRONT

BRAKE DISC CHOICES - FRONT

FRONT / AVANT / VORN / FRENTE / ANTERIORE

	FA, SFA, TT Pad or Brake Shoe	SFAC Carbon Scooter Pads	Speciality Pads - SXR / Vee / MXS	Sintered/HH Pads/ Grooved Shoes	Left / Gauche / Links Standard Replacement Disc	Right / Droite / Rechts Standard Replacement Disc	Contour Disc Universal left and right fitment	Universal Custom Disc	Vee-Discs Black † See note below	CX Extreme MX Race Disc/ UTVX Disc
Diesis 50	SFA115	SFAC115		SFA115HH	MD943D		MD943C		VR943	
FL 250 HP	V903									
Fly 50 (2T)	SFA353	SFAC353		SFA353HH	MD910D		MD910C		VR910	
Fly 50 (4T)	SFA353	SFAC353		SFA353HH	MD910D		MD910C		VR910	
Free 50	908									
Free 50 (Disc model)	SFA116					MD910D	MD910C		VR910	
Free Delivery 50	SFA116				MD910D		MD910C		VR910	
Free 50	SFA193	SFAC193		SFA193HH	MD910D		MD910C		VR910	
Grillo 50	909									
Liberty 50 (Grimeca Caliper) (2T/5 Spoke Wheels)	SFA260	SFAC260		SFA260HH	MD956D				VR956	
Liberty 50 (Heng Tong Caliper) (2T/5 Spoke Wheels)	SFA260	SFAC260		SFA260HH	MD956D				VR956	
Liberty 50 4T (Grimeca Caliper) (5 Spoke Wheels)	SFA260	SFAC260		SFA260HH	MD956D				VR956	
Liberty 50 4T (Heng Tong Caliper/5 Spoke Wheels)	SFA260	SFAC260		SFA260HH	MD956D				VR956	
Liberty 50 (2T/10 Spoke Cast Wheels)	SFA353	SFAC353		SFA353HH	MD959D				VR959	
Liberty 50 (4T/10 Spoke Cast Wheels)	SFA353	SFAC353		SFA353HH	MD959D				VR959	
Liberty i-get 50 (3V/4T)	SFA693	SFAC693		SFA693HH	MD9165D					
Liberty S 50 (2T)	SFA260	SFAC260		SFA260HH	MD956D				VR956	
Liberty S 50 (4T)	SFA260	SFAC260		SFA260HH	MD956D				VR956	
Liberty Elettrico	SFA260	SFAC260		SFA260HH	MD956D				VR956	
New Fly 50 (4T/4V)	SFA353	SFAC353		SFA353HH	MD9151D				VR9151	
NRG 50	SFA193	SFAC193		SFA193HH	MD943D		MD943C		VR943	
NRG 50 RST (DT/DD) MC2 (Rear drum)	SFA193	SFAC193		SFA193HH	MD943D		MD943C		VR943	
NRG 50 RST (DT/DD) MC2 (Rear drum)	SFA193	SFAC193		SFA193HH	MD943D		MD943C		VR943	
NRG 50 RST (DD/DT) MC2 (Rear disc)	SFA193	SFAC193		SFA193HH	MD943D		MD943C		VR943	
NRG 50 Extreme (Rear Drum Model)	SFA193	SFAC193		SFA193HH	MD924D				VR924	
NRG 50 Extreme (Rear Disc Model)	SFA193	SFAC193		SFA193HH	MD924D				VR924	
NRG 50 DT MC3 (Rear Drum Model)	SFA193	SFAC193		SFA193HH	MD924D				VR924	
NRG 50 MC3 DD (Rear Disc Model)	SFA193	SFAC193		SFA193HH	MD924D				VR924	
NRG 50 Power DD	SFA083/2			SFA083/2HH	MD956D				VR956	
NRG 50 Power Pure Jet	SFA083/2			SFA083/2HH	MD956D				VR956	
NRG 50 Power DT	SFA083/2			SFA083/2HH	MD956D				VR956	
NRG 50 Silver Bullet	SFA083/2			SFA083/2HH	MD956D				VR956	
NTT 50	SFA193	SFAC193		SFA193HH	MD943D		MD943C		VR943	
Quartz 50	SFA186	SFAC186			MD902D				VR902	
S 150 Alloy Wheels	909									
S 150 Spoke Wheels	N/A									
S 150 FL2	909									
S1 Mix 50	808									
Scatto 50	890									
Sfera Base 50	885									
Sfera 50 Maquillage 2	885									
Sfera 50 RST	SFA255				MD910D		MD910C		VR910	
Superbravo 50	896									
Typhoon	SFA193	SFAC193		SFA193HH	MD9126D					
Typhoon 50 X	SFA193	SFAC193		SFA193HH	MD9126D					
Typhoon 50 XR	SFA193	SFAC193		SFA193HH	MD9126D					
Typhoon 50 (2T) (Heng Tong Caliper/10" Wheels)	SFA193	SFAC193		SFA193HH	MD9126D					
Typhoon 50 (2T) (Grimeca Caliper/10" wheels)	SFA193	SFAC193		SFA193HH	MD9126D					
Typhoon 50 (2T/12" Wheels)	SFA353	SFAC353		SFA353HH	MD9151D				VR9151	
Typhoon 50 (2T/12 Inch Wheels) Euro 4	SFA732	SFAC732								
Velofax 50	899									
Zip 50 Base (Drum Model)	909									
Zip Fast Rider	SFA193	SFAC193		SFA193HH	MD904D				VR904	
Zip & Zip 50 Bimodale	896									
Zip 50 Base (Disc model)	SFA193	SFAC193		SFA193HH	MD904D				VR904	
Zip 50 RST	808									
Zip 50 RST	SFA260	SFAC260		SFA260HH	MD904D				VR904	
Zip 50 (Grimeca Caliper) (Heng Tong Caliper) (A/C) 4T	SFA260	SFAC260		SFA260HH	MD932D				VR932	
Zip 50 Elettrico	SFA193	SFAC193		SFA193HH	MD904D				VR904	
Zip 50 (2T)	SFA260	SFAC260		SFA260HH	MD932D				VR932	

Line #

R Suffix = High Durability Sintered Pad. HH Suffix = High Performance Sintered Pad. TT Suffix = Hard Wearing Off Road Pad. V Suffix = Semi Sintered Pad. G Suffix = Grooved Shoe.
D Suffix = Drilled Disc. X Suffix = Universal Left or Right Disc. XC Suffix = Contoured Disc. LS Suffix = Left/Steel Disc. RS = Right/Steel Disc.

*-2 Sets Required. † For Vee disc colours add RED, BLU, GRN, GLD, ORG suffix to part number.

⊗ - Also available as a Vintage Motorcycle Disc.

Non-JAPANESE Built Motorcycles

Line #	BRAKE DISC CHOICES - FRONT						DISC PAD CHOICES - REAR				BRAKE DISC CHOICES - REAR			
	Oversize 250 /280mm Disc Kit	OSX Oversize 250/280mm Disc Kit	Relocating Bracket for 250/ 280mm Disc	Oversize 320mm Disc Kit	SMX Oversize 320mm Disc Kit	Relocating Bracket for 320mm Disc	FA, SFA, TT Pad or Brake Shoe	SFAC Carbon Scooter Pads	Speciality Pads - SXR / Vee / MXS	Sintered/ HH Pads/ Grooved Shoes	Standard Replacement Disc	Contour Disc Rear fitment	Vee-Discs™ CONTOUR	CX Extreme MX Race Disc/ UTVX Disc
1							899							
2							V903							
3							816							
4							816							
5							806							
6							806							
7							899							
8							899							
9							V907							
10							816							
11							816							
12							816							
13							816							
14							816							
15							816							
16							816							
17							816							
18							816							
19							816							
20							816							
21							806							
22							806							
23							899							
24							SFA260	SFAC260		SFA260HH	MD932D	MD932C	VR932	
25							899							
26							SFA260	SFAC260		SFA260HH	MD932D		VR932	
27							899							
28							SFA260	SFAC260		SFA260HH	MD932D		VR932	
29							SFA260			SFA260HH	MD932D		VR932	
30							SFA260			SFA260HH	MD932D		VR932	
31							899							
32							SFA260			SFA260HH	MD932D		VR932	
33							806							
34							886							
35							V907							
36							V907							
37							V907							
38							V907							
39							890							
40							806							
41							806							
42							806							
43							V907							
44							806							
45							806							
46							899							
47							899							
48							899							
49							816							
50														
51							809							
52							806							
53							806							
54							806							
55							806							
56							899							
57							899							
58							899							
59							806							
60							899							

REAR / ARRIÈRE / HINTEN / POSTERIOR / POSTERIORE

R Suffix = High Durability Sintered Pad. **HH** Suffix = High Performance Sintered Pad. **TT** Suffix = Hard Wearing Off Road Pad. **V** Suffix = Semi Sintered Pad. **G** Suffix = Grooved Shoe.
D Suffix = Drilled Disc. **X** Suffix = Universal Left or Right Disc. **XC** Suffix = Contoured Disc. **LS** Suffix = Left/Steel Disc. **RS** = Right/Steel Disc.

*-2 Sets Required. † For Vee disc colours add RED, BLU, GRN, GLD, ORG suffix to part number.
 Ⓢ - Also available as a Vintage Motorcycle Disc.

Part numbers, prefixes, suffixes, photos and illustrations shown in this catalogue are trademarks and/or copyrights of EBC Brakes or the trademark owner A C Freeman Investments Ltd and use without express written permission of the owners is punishable by law.

Non-JAPANESE Built Motorcycles



PIAGGIO Contd.



DISC PAD CHOICES - FRONT

BRAKE DISC CHOICES - FRONT

R Suffix = High Durability Sintered Pad. HH Suffix = High Performance Sintered Pad. TT Suffix = Hard Wearing Off Road Pad. V Suffix = Semi Sintered Pad. G Suffix = Grooved Shoe.

D Suffix = Drilled Disc. X Suffix = Universal Left or Right Disc. XC Suffix = Contoured Disc. LS Suffix = Left/Steel Disc. RS = Right/Steel Disc.

FRONT / AVANT / VORN / FRENTE / ANTERIORE

		FA, SFA, TT Pad or Brake Shoe	SFAC Carbon Scooter Pads	Speciality Pads - SXR / Vee / MXS	Sintered/HH Pads/ Grooved Shoes	Left / Gauche / Links Standard Replacement Disc	Right / Droite / Rechts Standard Replacement Disc	Contour Disc Universal left and right fitment	Universal Custom Disc	Vee-Discs Black † See note below	CX Extreme MX Race Disc/ UTVX Disc	Line #
Zip 50 (4T)	00-20	SFA260	SFAC260		SFA260HH	MD932D				VR932		1
Zip 50 SP (Liquid Cooled)	96-12	SFA260	SFAC260		SFA260HH	MD910D		MD910C		VR910		2
Zip 50 SP (2T)	13-15	SFA260	SFAC260		SFA260HH	MD932D				VR932		3
SKR 80 City	99	885										4
Diesis 100	01-03	SFA115	SFAC115		SFA115HH	MD943D		MD943C		VR943		5
Fly 100 (4T)	07-15	SFA353	SFAC353		SFA353HH	MD910D		MD910C		VR910		6
Free 100	02	SFA193	SFAC193		SFA193HH	MD910D		MD910C		VR910		7
Zip 100	06-10	SFA260	SFAC260		SFA260HH	MD932D				VR932		8
125 GTR (VNL2)	74	V901										9
Beverly B 125/200 (Heng Tong Caliper)		02-06	SFA353	SFAC353		SFA353HH	MD961D				VR961	10
Beverly B 125/200 (Grimeca Caliper)	02-06	SFA194	SFAC194		SFA194HH	MD961D				VR961		11
Beverly 125	07	SFA353	SFAC353		SFA353HH	MD961D				VR961		12
Beverly Tourer 125	08-09	SFA353	SFAC353		SFA353HH	MD961D				VR961		13
Beverly 125 (Multi Spoke cast Type Wheels/4T)	11-14	SFA353	SFAC353		SFA353HH	MD9172D				VR9172		14
Beverly S 125	07	SFA353	SFAC353		SFA353HH	MD961D				VR961		15
Beverly 125 ie S	14-15	SFA353	SFAC353		SFA353HH	MD9172D				VR9172		16
Carnaby 125	07-09	SFA353	SFAC353		SFA353HH	MD961D				VR961		17
Cosa CL/CLX 125/200	88-91	882										18
Cosa 2 125	91-97	882										19
Fly 125 (2V/4T)	05-11	SFA353	SFAC353		SFA353HH	MD910D		MD910C		VR910		20
Fly 125i (3V/4T)	12-15	SFA353	SFAC353		SFA353HH	MD9151D				VR9151		21
Hexagon 125/150	94-97	SFA193	SFAC193		SFA193HH	MD905D						22
Hexagon LX4 125	98-99	SFA194	SFAC194		SFA194HH	MD910D		MD910C		VR910		23
Liberty 125 (5 Spoke Wheels)	98-08	SFA260	SFAC260		SFA260HH	MD956D				VR956		24
Liberty 125 (4T/2V/10 Spoke Cast Wheels)	09-12	SFA260	SFAC260		SFA260HH	TBA						25
Liberty 125 (3V/4T/10 Spoke Cast Wheels)	13-15	SFA260	SFAC260		SFA260HH	TBA						26
Liberty 125 (Full Optional/4T/10 Spoke Cast Wheels)	13-15	SFA260	SFAC260		SFA260HH	TBA						27
Liberty i-get 125 (3V/4T)	15-21	SFA693	SFAC693		SFA693HH	MD9165D						28
Liberty S 125	07-08	SFA260	SFAC260		SFA260HH	MD956D				VR956		29
Liberty 125 MyMoover 125 E5 3 Wheeler	21	SFA353	SFAC353		SFA353HH					VR956		30
- with parking brake		SFA257/2										31
Medley 125 (ABS)	16-19	SFA693	SFAC693		SFA693HH							32
Medley S 125 (ABS)	16-21	SFA693	SFAC693		SFA693HH							33
Medley 125	20	SFA693	SFAC693		SFA693HH	MD9179D						34
MP3 125 (Carb models) (12" rear wheel)	06-08	SFA260*	SFAC260*		SFA260HH*	MD9112D	MD9112D			VR9112*		35
MP3 125 (Carb models) (12" rear wheel) - Parking brake	06-08	SFA257/2										36
MP3 125 ie (EFI models) (14" rear wheel)	08-11	SFA260*	SFAC260*		SFA260HH*	MD9112D	MD9112D			VR9112*		37
MP3 125 ie (EFI models) (14" rear wheel) - Parking brake	08-11	SFA257/2										38
MP3 125 (Hybrid/125cc) (14" rear wheel)	09-12	SFA260*	SFAC260*		SFA260HH*	MD9112D	MD9112D			VR9112*		39
MP3 125 (Hybrid/125cc) (14" rear wheel) - Parking brake	09-12	SFA257/2										40
125 ie MP3 Yourban	11-12	SFA260*	SFAC260*		SFA260HH*	MD9112D	MD9112D			VR9112*		41
125 ie MP3 Yourban - Parking brake	11-12	SFA257/2										42
New Fly 125 ie (3V)	12-13	SFA353	SFAC353		SFA353HH	MD9151D				VR9151		43
Fly 125 (4T/3V) Rear Disc Model	12-15	SFA353	SFAC353		SFA353HH	MD9151D				VR9151		44
Skipper LX 125/150	98-99	SFA194	SFAC194		SFA194HH	MD924D				VR924		45
Skipper 125/150	94-97	SFA186	SFAC186			MD902D				VR902		46
Skipper ST 125/150 4T (Grimeca Caliper)	00-04	SFA194	SFAC194		SFA194HH	MD924D				VR924		47
Skipper ST 125/150 4T (Heng Tong Caliper)	00-04	SFA353	SFAC353		SFA353HH	MD924D				VR924		48
Sfera 125	95-97	SFA255				MD910D		MD910C		VR910		49
Super Hexagon GTX 125/180 (11" wheels) (Grimeca calipers)	00	SFA194	SFAC194		SFA194HH	MD910D		MD910C		VR910		50
Super Hexagon GTX 125/180 (11" wheels) (Heng Tong Calipers)	00	SFA353	SFAC353		SFA353HH	MD910D		MD910C		VR910		51
Super Hexagon GTX 125/180 (12" wheels)	01-03	SFA353	SFAC353		SFA353HH	MD960D				VR960		52
★ See SFA681 if rear pad SFA321 is incorrect shape - ONLY AVAILABLE AS SFA ORGANIC VERSION.												53
Typhoon 125	99-03	SFA193	SFAC193		SFA193HH	MD9126D						54
Typhoon 125 (4T/12" Wheels)	10-15	SFA353	SFAC353		SFA353HH	MD9151D				VR9151		55
Xevo 125	07-16	SFA353	SFAC353		SFA353HH	MD983D				VR983		56
X7 125cc	08-09	SFA353	SFAC353		SFA353HH	MD983D				VR983		57

*-2 Sets Required. † For Vee disc colours add RED, BLU, GRN, GLD, ORG suffix to part number.

⊗ - Also available as a Vintage Motorcycle Disc.

Non-JAPANESE Built Motorcycles

Line #	BRAKE DISC CHOICES - FRONT						DISC PAD CHOICES - REAR				BRAKE DISC CHOICES - REAR			
	Oversize 250 /280mm Disc Kit	OSX Oversize 250/280mm Disc Kit	Relocating Bracket for 250/ 280mm Disc	Oversize 320mm Disc Kit	SMX Oversize 320mm Disc Kit	Relocating Bracket for 320mm Disc	FA, SFA, TT Pad or Brake Shoe	SFAC Carbon Scooter Pads	Speciality Pads - SXR / Vee / MXS	Sintered/ HH Pads/ Grooved Shoes	Standard Replacement Disc	Contour Disc Rear fitment	Vee-Discs™ CONTOUR	CX Extreme MX Race Disc/ UTVX Disc
1							899							
2							899							
3							899							
4							806							
5							S624							
6							816							
7							816							
8							899							
9							V903							
10								SFA353	SFAC353		SFA353HH	MD961D	VR961	
11							SFA194	SFAC194		SFA194HH	MD961D		VR961	
12										MD961D		VR961		
13							SFA353	SFAC353		SFA353HH	MD961D		VR961	
14							SFA418	SFAC418		SFA418HH	MD9155D		VR9155	
15							SFA353	SFAC353		SFA353HH	MD961D		VR961	
16							SFA418	SFAC418		SFA418HH	MD9155D		VR9155	
17							SFA353	SFAC353		SFA353HH	MD961D		VR961	
18							881							
19							881							
20							816							
21							816							
22							899							
23							816							
24							816							
25							816							
26							816							
27							816							
28							816							
29							816							
30							SFA321	SFAC321		SFA321HH				
31														
32							SFA418	SFAC418		SFA418HH	MD9164D		VR9164	
33							SFA418	SFAC418		SFA418HH	MD9164D		VR9164	
34							SFA418	SFAC418		SFA418HH	MD9178D		VR9164	
35							SFA425	SFAC425		SFA425HH	MD960D		VR960	
36														
37							SFA418	SFAC418		SFA418HH	MD960D		VR960	
38							SFA418	SFAC418		SFA418HH	MD960D		VR960	
39							SFA418	SFAC418		SFA418HH	MD960D		VR960	
40							SFA418	SFAC418		SFA418HH	MD960D		VR960	
41							SFA418	SFAC418		SFA418HH	MD960D		VR960	
42														
43							SFA321 ★	SFAC321		SFA321HH	MD956D		VR956	
44							SFA321 ★	SFAC321		SFA321HH	MD956D		VR956	
45							816							
46							899							
47							816							
48							816							
49							899							
50														
51							SFA321 ★	SFAC321		SFA321HH	MD910D	MD910C	VR910	
52														
53							SFA321 ★	SFAC321		SFA321HH	MD910D	MD910C	VR910	
54							SFA321 ★	SFAC321		SFA321HH	MD956D		VR956	
55														
56														
57							899							
58							816							
59							SFA418	SFAC418		SFA418HH	MD960D		VR960	
60							SFA418	SFAC418		SFA418HH	MD960D		VR960	

REAR / ARRIÈRE / HINTEN / POSTERIOR / POSTERIORE

R Suffix = High Durability Sintered Pad. **HH** Suffix = High Performance Sintered Pad. **TT** Suffix = Hard Wearing Off Road Pad. **V** Suffix = Semi Sintered Pad. **G** Suffix = Grooved Shoe.
D Suffix = Drilled Disc. **X** Suffix = Universal Left or Right Disc. **XC** Suffix = Contoured Disc. **LS** Suffix = Left/Steel Disc. **RS** = Right/Steel Disc.

*-2 Sets Required. † For Vee disc colours add RED, BLU, GRN, GLD, ORG suffix to part number.
 ☉ - Also available as a Vintage Motorcycle Disc.

Part numbers, prefixes, suffixes, photos and illustrations shown in this catalogue are trademarks and/or copyrights of EBC Brakes or the trademark owner A C Freeman Investments Ltd and use without express written permission of the owners is punishable by law.

Non-JAPANESE Built Motorcycles



PIAGGIO Contd.



DISC PAD CHOICES - FRONT

BRAKE DISC CHOICES - FRONT

Model	Year	DISC PAD CHOICES - FRONT				BRAKE DISC CHOICES - FRONT					Line #	
		FA, SFA, TT Pad or Brake Shoe	SFAC Carbon Scooter Pads	Speciality Pads - SXR / Vee / MXS	Sintered/HH Pads/ Grooved Shoes	Left / Gauche / Links Standard Replacement Disc	Right / Droite / Rechts Standard Replacement Disc	Contour Disc Universal left and right fitment	Universal Custom Disc	Vee-Discs Black † See note below		CX Extreme MX Race Disc/ UTVX Disc
X7 Evo 125 ie (EFI)	09-12	SFA353	SFAC353		SFA353HH	MD983D				VR983		1
X8 125 (Brembo Rear Caliper)	04-05	SFA353	SFAC353		SFA353HH	MD983D				VR983		2
X8 125 (Heng Tong Rear Caliper)	05-06	SFA353	SFAC353		SFA353HH	MD983D				VR983		3
X8 125 ie (Heng Tong Rear Caliper)	07	SFA353	SFAC353		SFA353HH	MD961D				VR961		4
X8 125/Street	06-07	SFA353	SFAC353		SFA353HH	MD961D				VR961		5
X9 125	00-02	SFA266*	SFAC266*		SFA266HH*	MD959D	MD959D			VR959*		6
X9 125 Evolution (Brembo/Single pin fixing)	03-04	SFA266*	SFAC266*		SFA266HH*	MD959D	MD959D			VR959*		7
X9 125 Evolution (Heng Tong/2 Pin Fixing)	Left	SFA353	SFAC353		SFA353HH	MD959D				VR959*		8
	Right	SFA418	SFAC418		SFA418HH		MD959D					9
X10 125 (4V/4T/EFI/All Models)	Left	SFA353	SFAC353		SFA353HH	TBA						10
	Right	SFA418	SFAC418		SFA418HH		TBA					11
Zip 125 (4T - 200mm F/Disc)	00-01	SFA260	SFAC260		SFA260HH	MD910D		MD910C		VR910		12
Zip 125 (4T - 175mm F/Disc)	02-04	SFA260	SFAC260		SFA260HH	MD932D				VR932		13
Fly 150 (4T)	05-12	SFA353	SFAC353		SFA353HH	MD910D		MD910C		VR910		14
150 Sprint Veloce (VLB1)	74	V901										15
Cosa CL/CLX 150	88-91	882										16
Cosa 2 150	91-97	882										17
150 Super (VBC1)	74	V905										18
Liberty 150 (5 Spoke Wheels)	08	SFA260	SFAC260		SFA260HH	MD956D						19
Liberty 150 (4T/2V/10 Spoke Cast Wheels)	09-12	SFA260	SFAC260		SFA260HH	TBA						20
Liberty 150 (3V/4T/10 Spoke Cast Wheels)	13-15	SFA260	SFAC260		SFA260HH	TBA						21
Liberty 150 (Full Optional/4T/3V/10 Spoke Cast Wheels)	13-15	SFA260	SFAC260		SFA260HH	TBA				TBA		22
Liberty i-get 150 (3V/4T)	15-21	SFA693	SFAC693		SFA693HH	MD9165D						23
Medley 150 (ABS)	16-19	SFA693	SFAC693		SFA693HH							24
Medley S 150 (ABS)	16-19	SFA693	SFAC693		SFA693HH							25
Medley S 150 (ABS)	20-21	SFA693	SFAC693		SFA693HH	MD9179D						26
X8 150 Street	06-08	SFA353	SFAC353		SFA353HH	MD961D				VR961		27
Hexagon LX 180	98-99	SFA194	SFAC194		SFA194HH	MD910D		MD910C		VR910		28
Hexagon LXT 180	98-99	SFA194	SFAC194		SFA194HH	MD910D		MD910C		VR910		29
X9 180 Amalfi	00-03	SFA266*	SFAC266*		SFA266HH*	MD959D	MD959D			VR959*		30
Carnaby 200	07-09	SFA353	SFAC353		SFA353HH	MD961D				VR961		31
Cosa CL/CLX 200	88-91	882										32
Cosa 2 200	91-97	882										33
Liberty 200	98-07	SFA260	SFAC260		SFA260HH	MD956D				VR956		34
Liberty S 200	07-08	SFA260	SFAC260		SFA260HH	MD956D				VR956		35
Rally 200 (VSE1)	74	V901										36
X8 200 (Brembo Rear Caliper)	04-05	SFA353	SFAC353		SFA353HH	MD983D				VR983		37
X8 200 (Heng Tong Rear Caliper)	04-05	SFA353	SFAC353		SFA353HH	MD983D				VR983		38
X9 200	02-03	SFA266*	SFAC266*		SFA266HH*	MD959D	MD959D			VR959*		39
X9 200 Evolution	03-04	SFA266*	SFAC266*		SFA266HH*	MD959D	MD959D			VR959*		40
Beverly 250 (Carb Model)	04-07	SFA353	SFAC353		SFA353HH	MD961D				VR961		41
Beverly 250 ie	06-07	SFA353	SFAC353		SFA353HH	MD961D				VR961		42
Beverly S 250 ie	07	SFA353	SFAC353		SFA353HH	MD961D				VR961		43
Beverly Cruiser 250 ie	07-08	SFA353	SFAC353		SFA353HH	MD961D				VR961		44
Beverly Tourer 250 ie	08-09	SFA353	SFAC353		SFA353HH	MD961D				VR961		45
Carnaby 250 ie	08-09	SFA353	SFAC353		SFA353HH	MD961D				VR961		46
Hexagon GT 250	98-99	SFA194	SFAC194		SFA194HH	MD910D		MD910C		VR910		47
MP3 250 EFI (12" rear wheel)	06-08	SFA260*	SFAC260*		SFA260HH*	MD9112D	MD9112D			VR9112*		48
MP3 250 EFI (12" rear wheel) - Parking brake	06-08	SFA257/2										49
MP3 250 MIC/EFI (14" rear wheel)	08-09	SFA260*	SFAC260*		SFA260HH*	MD9112D	MD9112D			VR9112*		50
MP3 250 MIC/EFI (14" rear wheel) - Parking brake	08-09	SFA257/2										51
MP3 LT 250 ie (14" rear wheel)	09	SFA260*	SFAC260*		SFA260HH*	MD9112D	MD9112D			VR9112*		52
MP3 LT 250 ie (14" rear wheel) - Parking brake	09	SFA257/2										53
Super Hexagon GTX 250	00-02	SFA194	SFAC194		SFA194HH	MD910D		MD910C		VR910		54
Xevo 250 ie	07-10	SFA353	SFAC353		SFA353HH	MD983D				VR983		55
* See SFA681 if rear pad SFA321 is incorrect shape - ONLY AVAILABLE AS SFA ORGANIC VERSION.												56
X7 250 ie	08-09	SFA353	SFAC353		SFA353HH	MD983D				VR983		58
X8 250 ie	05-06	SFA353	SFAC353		SFA353HH	MD983D				VR983		59
X8 250 ie	07	SFA353	SFAC353		SFA353HH	MD961D						60

FRONT / AVANT / VORN / FRENTE / ANTERIORE

*-2 Sets Required. † For Vee disc colours add RED, BLU, GRN, GLD, ORG suffix to part number.

⊗ - Also available as a Vintage Motorcycle Disc.

R Suffix = High Durability Sintered Pad. HH Suffix = High Performance Sintered Pad. TT Suffix = Hard Wearing Off Road Pad. V Suffix = Semi Sintered Pad. G Suffix = Grooved Shoe. D Suffix = Drilled Disc. X Suffix = Universal Left or Right Disc. XC Suffix = Contoured Disc. LS Suffix = Left/Steel Disc. RS = Right/Steel Disc.

Non-JAPANESE Built Motorcycles

Line #	BRAKE DISC CHOICES - FRONT						DISC PAD CHOICES - REAR				BRAKE DISC CHOICES - REAR			
	Oversize 250 /280mm Disc Kit	OSX Oversize 250/280mm Disc Kit	Relocating Bracket for 250/ 280mm Disc	Oversize 320mm Disc Kit	SMX Oversize 320mm Disc Kit	Relocating Bracket for 320mm Disc	FA, SFA, TT Pad or Brake Shoe	SFAC Carbon Scooter Pads	Speciality Pads - SXR / Vee / MXS	Sintered/ HH Pads/ Grooved Shoes	Standard Replacement Disc	Contour Disc Rear fitment	Vee-Discs™ CONTOUR	CX Extreme MX Race Disc/ UTVX Disc
1							SFA418	SFAC418		SFA418HH	MD960D		VR960	
2							SFA266	SFAC266		SFA266HH	MD960D		VR960	
3							SFA425	SFAC425		SFA425HH	MD960D		VR960	
4							SFA425	SFAC425		SFA425HH	MD960D		VR960	
5							816							
6							SFA266	SFAC266		SFA266HH	MD959D		VR959	
7							SFA266	SFAC266		SFA266HH	MD959D		VR959	
8							SFA266	SFAC266		SFA266HH	MD959D		VR959	
9														
10							SFA418	SFAC418		SFA418HH	TBA			
11														
12							899							
13							899							
14							816							
15							V903							
16							881							
17							881							
18							V902							
19							816							
20							816							
21							816							
22							816							
23							816							
24							SFA418	SFAC418		SFA418HH	MD9164D		VR9164	
25							SFA418	SFAC418		SFA418HH	MD9164D		VR9164	
26							SFA418	SFAC418		SFA418HH	MD9178D		VR9164	
27							816							
28							816							
29							816							
30							SFA266	SFAC266		SFA266HH	MD959D		VR959	
31							SFA353	SFAC353		SFA353HH	MD961D		VR961	
32							881							
33							881							
34							816							
35							816							
36							V903							
37							SFA266	SFAC266		SFA266HH	MD960D		VR960	
38							SFA425	SFAC425		SFA425HH	MD960D		VR960	
39							SFA266	SFAC266		SFA266HH	MD959D		VR959	
40							SFA266	SFAC266		SFA266HH	MD959D		VR959	
41							SFA353	SFAC353		SFA353HH	MD961D		VR961	
42							SFA353	SFAC353		SFA353HH	MD961D		VR961	
43							SFA353	SFAC353		SFA353HH	MD961D		VR961	
44							SFA353	SFAC353		SFA353HH	MD961D		VR961	
45							SFA353	SFAC353		SFA353HH	MD961D		VR961	
46							SFA353	SFAC353		SFA353HH	MD961D		VR961	
47							H350							
48							SFA425	SFAC425		SFA425HH	MD960D		VR960	
49														
50							SFA418	SFAC418		SFA418HH	MD960D		VR960	
51														
52							SFA418	SFAC418		SFA418HH	MD960D		VR960	
53														
54							SFA321★	SFAC321		SFA321HH	MD910D	MD910C	VR910	
55							SFA418	SFAC418		SFA418HH	MD960D		VR960	
56														
57														
58							SFA418	SFAC418		SFA418HH	MD960D		VR960	
59							SFA425	SFAC425		SFA425HH	MD960D		VR960	
60							SFA425	SFAC425		SFA425HH	MD960D		VR960	

REAR / ARRIÈRE / HINTEN / POSTERIOR / POSTERIORE

R Suffix = High Durability Sintered Pad. **HH** Suffix = High Performance Sintered Pad. **TT** Suffix = Hard Wearing Off Road Pad. **V** Suffix = Semi Sintered Pad. **G** Suffix = Grooved Shoe.
D Suffix = Drilled Disc. **X** Suffix = Universal Left or Right Disc. **XC** Suffix = Contoured Disc. **LS** Suffix = Left/Steel Disc. **RS** = Right/Steel Disc.

*-2 Sets Required. † For Vee disc colours add RED, BLU, GRN, GLD, ORG suffix to part number.
 Ⓢ - Also available as a Vintage Motorcycle Disc.

Part numbers, prefixes, suffixes, photos and illustrations shown in this catalogue are trademarks and/or copyrights of EBC Brakes or the trademark owner A C Freeman Investments Ltd and use without express written permission of the owners is punishable by law.

Non-JAPANESE Built Motorcycles



PIAGGIO Contd.



DISC PAD CHOICES - FRONT

BRAKE DISC CHOICES - FRONT

Line #

		FA, SFA, TT Pad or Brake Shoe	SFAC Carbon Scooter Pads	Speciality Pads - SXR / Vee / MXS	Sintered/HH Pads/ Grooved Shoes	Left / Gauche / Links Standard Replacement Disc	Right / Droite / Rechts Standard Replacement Disc	Contour Disc Universal left and right fitment	Universal Custom Disc	Vee-Discs Black † See note below	CX Extreme MX Race Disc/ UTVX Disc	
X9 250 (13" rear wheel)	00-04	SFA266*	SFAC266*		SFA266HH*	MD959D	MD959D			VR959*		1
X9 250 (Linked brake F & R wheel 14" dia)	04	SFA181*	SFAC181*		SFA181HH*	MD983D	MD983D			VR983*		2
X9 250	05-06	SFA353	SFAC353		SFA353HH	MD959D				VR959		3
	Left	SFA418	SFAC418		SFA418HH		MD959D			VR959		4
	Right	SFA353	SFAC353		SFA353HH	MD9172D				VR9172		5
Beverly 300 (278cc/4T/Multi Spoke Wheel)	10-18	SFA353	SFAC353		SFA353HH	MD9172D				VR9172		6
Beverly 300 ie S 4T/4V HPE E5	14-21	SFA353	SFAC353		SFA353HH	MD9172D				VR9172		7
Beverly Police 300 ABS ASR (278cc)	16-18	SFA353	SFAC353		SFA353HH	TBA						8
Carnaby Cruiser 300	08-11	SFA353	SFAC353		SFA353HH	MD961D				VR961		9
Carnaby 300 ie	12	SFA353	SFAC353		SFA353HH	MD961D				VR961		10
MP3 LT 300 ie	10	SFA260*	SFAC260*		SFA260HH*	MD9112D	MD9112D			VR9112*		11
MP3 LT 300 ie - Parking brake	10	SFA257/2										12
MP3 Business LT 300 ie	13	SFA260*	SFAC260*		SFA260HH*	MD9112D	MD9112D			VR9112*		13
MP3 Business LT 300 ie - Parking brake	13	SFA257/2										14
MP3 Business LT 300 ie ABS												15
(13" Front Wheel/14" Rear Wheel)	14-18	SFA681*	SFAC681*		SFA681HH*	MD9158D	MD9158D			TBA		16
MP3 Business LT 300 ie ABS												17
(13" Front Wheel/14" Rear Wheel) - Parking brake	14-18	SFA257/2										18
MP3 Hybrid 300 ie	11-15	SFA260*	SFAC260*		SFA260HH*	MD9112D	MD9112D			VR9112*		19
MP3 Hybrid 300 ie - Parking brake	11-15	SFA257/2										20
MP3 Hybrid LT 300 ie	11-12	SFA260*	SFAC260*		SFA260HH*	MD9112D	MD9112D			VR9112*		21
MP3 Hybrid LT 300 ie - Parking brake	11-12	SFA257/2										22
MP3 Touring 300 ie	11-12	SFA260*	SFAC260*		SFA260HH*	MD9112D	MD9112D			VR9112*		23
MP3 Touring 300 ie - Parking brake	11-12	SFA257/2										24
MP3 Touring LT 300 ie	11-12	SFA260*	SFAC260*		SFA260HH*	MD9112D	MD9112D			VR9112*		25
MP3 Touring LT 300 ie - Parking brake	11-12	SFA257/2										26
MP3 Sport LT 300 ie	13	SFA260*	SFAC260*		SFA260HH*	MD9112D	MD9112D			VR9112*		27
MP3 Sport LT 300 ie - Parking brake	13	SFA257/2										28
MP3 Sport LT 300 ie ABS												29
(13" Front Wheel/14" Rear Wheel)	14-18	SFA681*	SFAC681*		SFA681HH*	MD9158D	MD9158D			TBA*		30
MP3 Sport LT 300 ie ABS												31
(13" Front Wheel/14" Rear Wheel) - Parking brake	14-18	SFA257/2										32
300 ie MP3 Yourban	11-16	SFA260*	SFAC260*		SFA260HH*	MD9112D	MD9112D			VR9112*		33
300 ie MP3 Yourban - Parking brake	11-16	SFA257/2										34
MP3 Yourban LT RL 300	17-18	SFA260*	SFAC260*		SFA260HH*	MD9112D	MD9112D			VR9112*		35
MP3 Yourban LT RL 300 - Parking brake	17-18	SFA257/2										36
X7 EVO 300 ie	10-12	SFA353	SFAC353		SFA353HH	MD983D				VR983		37
Beverly 350 ie Sport Touring Non (330cc/4T)	11-15	SFA324	SFAC324		SFA324HH	MD9172D				VR9172		38
Beverly 350 ie Sport Touring ABS (330cc/4T)	11-15	SFA324	SFAC324		SFA324HH	MD9172D				VR9172		39
Beverly 350 ie Sport Touring ABS (330cc/4T)	16-21	SFA353	SFAC353		SFA353HH	MD9172D				VR9172		40
MP3 Maxi Sport-Business E4 ABS (350cc)	18-19	SFA681*	SFAC681*		SFA681HH*	MD9158D	MD9158D					41
MP3 Maxi Sport-Business E4 ABS (350cc) - Parking Brake		SFA257/2										42
X10 350 (4V/4T/Efi/All Models)	Left 12-15	SFA353	SFAC353		SFA353HH	TBA						43
	Right	SFA418	SFAC418		SFA418HH		TBA					44
X10 350 (4V/4T/Efi/All Models) - Parking brake	12-15	SFA257/2										45
Beverly 400 ie	07	SFA181	SFAC181		SFA181HH	MD961D	MD961D			VR961*		46
Beverly Tourer 400 ie	08-09	SFA266	SFAC266		SFA266HH	MD961D	MD961D			VR961*		47
Trackmaster 400 Quad	06	FA395TT*			FA395R*	MD6173D	MD6173D					48
Trackmaster 400 Quad - Parking brake		06	FA271TT									49
MP3 400 ie	07-10	SFA260*	SFAC260*		SFA260HH*	MD9112D	MD9112D			VR9112*		50
MP3 400 ie - Parking brake	07-10	SFA257/2										51
MP3-LT 400 ie	09-10	SFA260*	SFAC260*		SFA260HH*	MD9112D	MD9112D			VR9112*		52
MP3-LT 400 ie - Parking brake	09-10	SFA257/2										53
MP3 Touring 400 ie	11-12	SFA260*	SFAC260*		SFA260HH*	MD9112D	MD9112D			VR9112*		54
MP3 Touring 400 ie - Parking brake	11-12	SFA257/2										55
MP3 Touring LT 400 ie	11-12	SFA260*	SFAC260*		SFA260HH*	MD9112D	MD9112D			VR9112*		56
MP3 Touring LT 400 ie - Parking brake		SFA257/2										57
Xevo 400 ie	Left 07-10	SFA353	SFAC353		SFA353HH	MD959D	MD959D			VR959*		58
	Right	SFA418	SFAC418		SFA418HH							59
X8 400 ie	Left 06-08	SFA353	SFAC353		SFA353HH	MD961D	MD961D			VR961*		60
	Right	SFA418	SFAC418		SFA418HH							60

FRONT / AVANT / VORN / FRENTE / ANTERIORE

R Suffix = High Durability Sintered Pad. HH Suffix = High Performance Sintered Pad. TT Suffix = Hard Wearing Off Road Pad. V Suffix = Semi Sintered Pad. G Suffix = Grooved Shoe.
D Suffix = Drilled Disc. X Suffix = Universal Left or Right Disc. XC Suffix = Contoured Disc. LS Suffix = Left/Steel Disc. RS = Right/Steel Disc.

*-2 Sets Required. † For Vee disc colours add RED, BLU, GRN, GLD, ORG suffix to part number.

⊗ - Also available as a Vintage Motorcycle Disc.

Non-JAPANESE Built Motorcycles

Line #	BRAKE DISC CHOICES - FRONT						DISC PAD CHOICES - REAR				BRAKE DISC CHOICES - REAR			
	Oversize 250 /280mm Disc Kit	OSX Oversize 250/280mm Disc Kit	Relocating Bracket for 250/ 280mm Disc	Oversize 320mm Disc Kit	SMX Oversize 320mm Disc Kit	Relocating Bracket for 320mm Disc	FA, SFA, TT Pad or Brake Shoe	SFAC Carbon Scooter Pads	Speciality Pads - SXR / Vee / MXS	Sintered/ HH Pads/ Grooved Shoes	Standard Replacement Disc	Contour Disc Rear fitment	Vee-Discs™ CONTOUR	CX Extreme MX Race Disc/ UTVX Disc
1							SFA266	SFAC266		SFA266HH	MD959D		VR959	
2							SFA266	SFAC266		SFA266HH	MD960D		VR960	
3							SFA425	SFAC425		SFA425HH	MD959D		VR959	
4														
5							SFA418	SFAC418		SFA418HH	MD9155D		VR9155	
6							SFA418	SFAC418		SFA418HH	MD9155D		VR9155	
7							SFA418	SFAC418		SFA418HH	TBA			
8							SFA353	SFAC353		SFA353HH	MD961D		VR961	
9							SFA353	SFAC353		SFA353HH	MD961D		VR961	
10							SFA418	SFAC418		SFA418HH	MD960D		VR960	
11														
12							SFA418	SFAC418		SFA418HH	MD960D		VR960	
13														
14														
15							SFA418	SFAC418		SFA418HH	MD960D			
16														
17														
18							SFA418	SFAC418		SFA418HH	MD960D		VR960	
19														
20							SFA418	SFAC418		SFA418HH	MD960D		VR960	
21														
22							SFA418	SFAC418		SFA418HH	MD960D		VR960	
23														
24							SFA418	SFAC418		SFA418HH	MD960D		VR960	
25														
26							SFA418	SFAC418		SFA418HH	MD960D		VR960	
27														
28														
29							SFA418	SFAC418		SFA418HH	MD960D			
30														
31														
32							SFA418	SFAC418		SFA418HH	MD960D		VR960	
33														
34							SFA418	SFAC418		SFA418HH	MD960D		VR960	
35														
36							SFA418	SFAC418		SFA418HH	MD960D		VR960	
37							SFA418	SFAC418		SFA418HH	MD9164D			
38							SFA418	SFAC418		SFA418HH	MD9164D			
39							SFA418	SFAC418		SFA418HH	MD9164D			
40							SFA418	SFAC418		SFA418HH	MD960D			
41														
42							SFA418	SFAC418		SFA418HH	TBA			
43														
44														
45							SFA353	SFAC353		SFA353HH	MD960D		VR960	
46							SFA266	SFAC266		SFA266HH	MD959D		VR959	
47							FA395TT			FA395R	MD6173D			
48														
49							SFA353	SFAC353		SFA353HH	MD960D		VR960	
50														
51							SFA353	SFAC353		SFA353HH	MD960D		VR960	
52														
53							SFA353	SFAC353		SFA353HH	MD960D		VR960	
54														
55							SFA353	SFAC353		SFA353HH	MD960D		VR960	
56														
57							SFA353	SFAC353		SFA353HH	MD960D		VR960	
58														
59							SFA353	SFAC353		SFA353HH	MD960D		VR960	
60														

REAR / ARRIÈRE / HINTEN / POSTERIOR / POSTERIORE

R Suffix = High Durability Sintered Pad. **HH** Suffix = High Performance Sintered Pad. **TT** Suffix = Hard Wearing Off Road Pad. **V** Suffix = Semi Sintered Pad. **G** Suffix = Grooved Shoe.
D Suffix = Drilled Disc. **X** Suffix = Universal Left or Right Disc. **XC** Suffix = Contoured Disc. **LS** Suffix = Left/Steel Disc. **RS** = Right/Steel Disc.

*-2 Sets Required. † For Vee disc colours add RED, BLU, GRN, GLD, ORG suffix to part number.
 ☉ - Also available as a Vintage Motorcycle Disc.

Part numbers, prefixes, suffixes, photos and illustrations shown in this catalogue are trademarks and/or copyrights of EBC Brakes or the trademark owner A C Freeman Investments Ltd and use without express written permission of the owners is punishable by law.

Non-JAPANESE Built Motorcycles



PIAGGIO Contd.



DISC PAD CHOICES - FRONT

BRAKE DISC CHOICES - FRONT

		FA, SFA, TT Pad or Brake Shoe	SFAC Carbon Scooter Pads	Speciality Pads - SXR / Vee / MXS	Sintered/HH Pads/ Grooved Shoes	Left / Gauche / Links Standard Replacement Disc	Right / Droite / Rechts Standard Replacement Disc	Contour Disc Universal left and right fitment	Universal Custom Disc	Vee-Discs Black † See note below	CX Extreme MX Race Disc/ UTVX Disc	Line #
Beverly B 500	02-05	SFA266*	SFAC266*		SFA266HH*	MD961D	MD961D			VR961*		1
Beverly 500	06	SFA266*	SFAC266*		SFA266HH*	MD961D	MD961D			VR961*		2
Beverly Cruiser 500 ie	07-11	SFA266*	SFAC266*		SFA266HH*	MD961D	MD961D			VR961*		3
Beverly 500 ie	12	SFA266*	SFAC266*		SFA266HH*	MD961D	MD961D			VR961*		4
MP3 500 EFI	09-10	SFA260*	SFAC260*		SFA260HH*	MD9112D	MD9112D			VR9112*		5
MP3 500 EFI - Parking brake		SFA257/2										6
MP3 Touring Business 500 ie	11-12	SFA260*	SFAC260*		SFA260HH*	MD9112D	MD9112D			VR9112*		7
MP3 Touring Business 500 ie - Parking brake		SFA257/2										8
MP3 500 LT Business	11-15	SFA260*	SFAC260*		SFA260HH*	MD9112D	MD9112D			VR9112*		9
MP3 500 LT Business - Parking brake	11-15	SFA257/2										10
MP3 500 LT Business ABS (13 Inch Front Wheel /14 Inch Rear Wheel)	14-20	SFA681*	SFAC681*		SFA681HH*	MD9158D	MD9158D			TBA*		11
MP3 500 LT Business ABS (13 Inch Front Wheel /14 Inch Rear Wheel) - Parking brake	14-18	SFA257/2										12
MP3 Touring Sport 500 ie	11-12	SFA260*	SFAC260*		SFA260HH*	MD9112D	MD9112D			VR9112*		13
MP3 Touring Sport 500 ie - Parking brake		SFA257/2										14
MP3 500 LT Sport	11-15	SFA260*	SFAC260*		SFA260HH*	MD9112D	MD9112D			VR9112*		15
MP3 500 LT Sport - Parking brake	11-15	SFA257/2										16
MP3 500 LT Sport ABS (13 Inch Front Wheel /14 Inch Rear Wheel)	14-18	SFA681*	SFAC681*		SFA681HH*	MD9158D	MD9158D			TBA*		17
MP3 500 LT Sport ABS (13 Inch Front Wheel /14 Inch Rear Wheel) - Parking Brake	14-18	SFA257/2										18
MP3 500 LT Sport Advanced E5 ABS (13 Inch Front Wheel /14 Inch Rear Wheel)	21	SFA681*	SFAC681*		SFA681HH*	MD9158D	MD9158D			TBA*		19
MP3 500 LT Sport Advanced E5 ABS (13 Inch Front Wheel /14 Inch Rear Wheel) - Parking Brake	21	SFA257/2										20
X9 500/500 SL	00-02	SFA266*	SFAC266*		SFA266HH*	MD961D	MD961D			VR961*		21
X9 500 cc Evolution (inc ABS)	03-06	SFA181*	SFAC181*		SFA181HH*	MD983D	MD983D			VR983*		22
X9 500 ie	07	SFA181*	SFAC181*		SFA181HH*	MD961D	MD961D			VR961*		23
X10 - 500 i (4V/4T/Efi/All Models) Left	12-15	SFA353	SFAC353		SFA353HH	TBA	TBA					24
X10 - 500 i (4V/4T/Efi/All Models) Right		SFA418	SFAC418		SFA418HH							25
X10 - 500 i (4V/4T/Efi/All Models) - Parking brake	12-15	SFA257/2										26
												27
												28
												29
												30
												31
												32
												33
												34
												35
												36
												37
												38
												39
												40
												41
												42
												43
												44
												45
												46
												47
												48
												49
												50
												51
												52
												53
												54
												55
												56
												57
												58
												59
												60

FRONT / AVANT / VORN / FRENTE / ANTERIORE

R Suffix = High Durability Sintered Pad. HH Suffix = High Performance Sintered Pad. TT Suffix = Hard Wearing Off Road Pad. V Suffix = Semi Sintered Pad. G Suffix = Grooved Shoe. D Suffix = Drilled Disc. X Suffix = Universal Left or Right Disc. XC Suffix = Contoured Disc. LS Suffix = Left/Steel Disc. RS = Right/Steel Disc.

*-2 Sets Required. † For Vee disc colours add RED, BLU, GRN, GLD, ORG suffix to part number.

⊗ - Also available as a Vintage Motorcycle Disc.

Non-JAPANESE Built Motorcycles

Line #	BRAKE DISC CHOICES - FRONT						DISC PAD CHOICES - REAR				BRAKE DISC CHOICES - REAR			
	Oversize 250 /280mm Disc Kit	OSX Oversize 250/280mm Disc Kit	Relocating Bracket for 250/ 280mm Disc	Oversize 320mm Disc Kit	SMX Oversize 320mm Disc Kit	Relocating Bracket for 320mm Disc	FA, SFA, TT Pad or Brake Shoe	SFAC Carbon Scooter Pads	Speciality Pads - SXR / Vee / MXS	Sintered/ HH Pads/ Grooved Shoes	Standard Replacement Disc	Contour Disc Rear fitment	Vee-Discs™ CONTOUR	CX Extreme MX Race Disc/ UTVX Disc
1							SFA266	SFAC266		SFA266HH	MD960D		VR960	
2							SFA425	SFAC425		SFA425HH	MD960D		VR960	
3							SFA266	SFAC266		SFA266HH	MD960D		VR960	
4							SFA266	SFAC266		SFA266HH	MD960D		VR960	
5							SFA418	SFAC418		SFA418HH	MD960D		VR960	
6														
7							SFA353	SFAC353		SFA353HH	MD960D		VR960	
8														
9							SFA353	SFAC353		SFA353HH	MD960D		VR960	
10														
11														
12							SFA353	SFAC353		SFA353HH	MD960D			
13														
14														
15							SFA353	SFAC353		SFA353HH	MD960D		VR960	
16														
17							SFA353	SFAC353		SFA353HH	MD960D		VR960	
18														
19							SFA353	SFAC353		SFA353HH	MD960D			
20														
21														
22														
23														
24							SFA353	SFAC353		SFA353HH	MD960D			
25														
26														
27							SFA266	SFAC266		SFA266HH	MD960D		VR960	
28							SFA266	SFAC266		SFA266HH	MD960D		VR960	
29							SFA266	SFAC266		SFA266HH	MD960D		VR960	
30							SFA418	SFAC418		SFA418HH	TBA			
31														
32														
33														
34														
35							820							
36														
37														
38							FA352				N/A			
39														
40							FA293/293S				N/A			
41							FA325TT		FA325R		N/A			
42							FA351TT				N/A			
43							FA351TT				N/A			
44							FA352				N/A			
45							FA352				N/A			
46							FA351TT				N/A			
47							FA351TT				N/A			
48														
49														
50							FA208TT		MXS208	FA208R	N/A			
51							FA208TT		MXS208	FA208R	N/A			
52							FA208TT				N/A			
53														
54														
55							931		931G					
56														
57							H322							
58														
59							H322							
60														

REAR / ARRIÈRE / HINTEN / POSTERIOR / POSTERIORE

R Suffix = High Durability Sintered Pad. **HH** Suffix = High Performance Sintered Pad. **TT** Suffix = Hard Wearing Off Road Pad. **V** Suffix = Semi Sintered Pad. **G** Suffix = Grooved Shoe.
D Suffix = Drilled Disc. **X** Suffix = Universal Left or Right Disc. **XC** Suffix = Contoured Disc. **LS** Suffix = Left/Steel Disc. **RS** = Right/Steel Disc.

*-2 Sets Required. † For Vee disc colours add RED, BLU, GRN, GLD, ORG suffix to part number.
 ☉ - Also available as a Vintage Motorcycle Disc.

Part numbers, prefixes, suffixes, photos and illustrations shown in this catalogue are trademarks and/or copyrights of EBC Brakes or the trademark owner A C Freeman Investments Ltd and use without express written permission of the owners is punishable by law.

Non-JAPANESE Built Motorcycles



PUCH Contd.



DISC PAD CHOICES - FRONT

BRAKE DISC CHOICES - FRONT

R Suffix = High Durability Sintered Pad. **HH** Suffix = High Performance Sintered Pad. **TT** Suffix = Hard Wearing Off Road Pad. **V** Suffix = Semi Sintered Pad. **G** Suffix = Grooved Shoe.

D Suffix = Drilled Disc. **X** Suffix = Universal Left or Right Disc. **XC** Suffix = Contoured Disc. **LS** Suffix = Left/Steel Disc. **RS** = Right/Steel Disc.

FRONT / AVANT / VORN / FRENTE / ANTERIORE

Model	Year	DISC PAD CHOICES - FRONT				BRAKE DISC CHOICES - FRONT						Line #	
		FA, SFA, TT Pad or Brake Shoe	SFAC Carbon Scooter Pads	Speciality Pads - SXR / Vee / MXS	Sintered/HH Pads/ Grooved Shoes	Left / Gauche / Links Standard Replacement Disc	Right / Droite / Rechts Standard Replacement Disc	Contour Disc Universal left and right fitment	Universal Custom Disc	Vee-Discs Black † See note below	CX Extreme MX Race Disc/ UTVX Disc		
Maxi 50 Spoke Wheels/2 Speed automatic/with rear suspension	73-80	H322											1
Maxi 50 Executive (Cast Wheels/1 Speed automatic)		931		931G									2
Maxi S 50 Sport (Cast Wheels/1 Speed automatic)		931		931G									3
Maxi 50 Super (Cast Wheels/2 Speed automatic)		931		931G									4
Maxi 50 Executive (Cast Wheels with screwed in hub/1 speed automatic)		H322											5
Maxi S 50 Sport (Cast Wheels with screwed in hub/1 speed automatic)		H322											6
Maxi 50 Super (Cast Wheels with screwed in hub/2 Speed automatic)		H322											7
M 250cc Sport	74	856											8
M 350cc Sport	75	856											9
MS 50/50 L		970											10
M 50 Sport	73-74				843G								11
M 50 Grand Prix	74-77	932											12
M 50 SDP Spoke Wheel/Grand Prix Special	75-77	FA050						MD866					13
M 50 SDP Cast Wheel/Grand Prix Supreme	75-77	FA050						MD866					14
VS/DS/DZS/DSK 50		856											15
50 KA/K2/K25/K3T/MSP		972											16
Monza 4 SL/GP		932											17
Imola X/GX		FA050				N/A							18
Cobra 80/80-8/80-6 GT/GTL		FA050				N/A							19
													20
													21
													22
													23
													24
													25
PUZEY													26
MTD 300 (4T/4V)	11-12	FA135TT		MXS135	FA135R	N/A							27
MX 300 (4T/4V)	11-12	FA135TT		MXS135	FA135R	N/A							28
													29
													30
QUADRO													31
350 D	11-15	SFA193*	SFAC193*		SFA193HH*	N/A	N/A						32
350 D - Parking brake	11-15	SFA083											33
350 S	13-15	SFA193*	SFAC193*		SFA193HH*	N/A	N/A						34
350 S - Parking brake	13-15	SFA083											35
350 4	14-15	SFA193*	SFAC193*		SFA193HH*	N/A	N/A						36
350 4 - Parking brake	14-15	SFA083											37
QV3	18-20	SFA083*	SFAC083*		SFA083HH*								38
Qooder	18-20	SFA083*	SFAC083*		SFA083HH*								39
													40
													41
													42
QUADZILLA (inc. White Knuckle Models)													43
Buzz 50	03-07	N/A											44
Micro Buggy MK11/111 (RV 50)	05-09	H346*			H346G*								45
R50 (Rear disc model)	03-06	S614*			S614G*								46
R50 (Rear drum model)		S614*			S614G*								47
WK 50 White Knuckle (Pit Bike)	06-11	S614			S614G								48
X50		H346*			H346G*								49
ZR50	07-09	H346			H346G								50
WK 70 White Knuckle (Pit Bike) (Front drum model)	06-09	S614			S614G								51
WK 70 White Knuckle (Pit Bike) (Front disc model)	06-09	SFA169	SFAC169		SFA169HH	N/A							52
Black Max M100 (S.E.)	06	Y503*			Y503G*								53
Pro Shark 100 (RMX) (Front disc models)		FA067*			FA067R*	N/A	N/A						54
Pro Shark (Double A Arms)		Y503*			Y503G*								55
Pro Shark 100 (Single A Arms)		H346*			H346G*								56
Ram R100	03-05	TBA*											57
Ram R100 E	03-05	TBA*											58
R100 (Rear disc model)	06-09	S614*			S614G*								59
R100 (Rear drum model)		S614*			S614G*								60
Magmax	03-05	TBA*											61
Magmax		H346*			H346G*								62
X100 E (XLC)	06-07	Y503*			Y503G*								63

*-2 Sets Required. † For Vee disc colours add RED, BLU, GRN, GLD, ORG suffix to part number.

⊗ - Also available as a Vintage Motorcycle Disc.

Non-JAPANESE Built Motorcycles

Line #	BRAKE DISC CHOICES - FRONT						DISC PAD CHOICES - REAR				BRAKE DISC CHOICES - REAR			
	OverSize 250 /280mm Disc Kit	OSX OverSize 250/280mm Disc Kit	Relocating Bracket for 250/ 280mm Disc	OverSize 320mm Disc Kit	SMX OverSize 320mm Disc Kit	Relocating Bracket for 320mm Disc	FA, SFA, TT Pad or Brake Shoe	SFAC Carbon Scooter Pads	Speciality Pads - SXR / Vee / MXS	Sintered/ HH Pads/ Grooved Shoes	Standard Replacement Disc	Contour Disc Rear fitment	Vee-Discs™ CONTOUR	CX Extreme MX Race Disc/ UTVX Disc
1														
2							H322							
3							945							
4							945							
5							945							
6														
7							H322							
8														
9							H322							
10														
11							H322							
12							856							
13							856							
14							970							
15										843G				
16							932							
17							932							
18										843G				
19							856							
20							972							
21							932							
22							932							
23							932							
24														
25														
26							FA346TT		MXS346	FA346R	N/A			
27							FA346TT		MXS346	FA346R	N/A			
28														
29														
30							SFA083	SFAC083		SFA083HH	N/A			
31														
32							SFA083	SFAC083		SFA083HH	N/A			
33														
34							SFA083*	SFAC083*		SFA083HH*	N/A*			
35														
36							SFA268*	SFAC268*		SFA268HH				
37							SFA268*	SFAC268*		SFA268HH				
38														
39														
40														
41							H302			H302G				
42							FA485TT				N/A			
43							FA232TT			FA232R	N/A			
44							Y527			Y527G				
45							S614			S614G				
46							FA083TT			FA083R	N/A			
47							FA083TT			FA083R	N/A			
48							S614			S614G				
49							S614			S614G				
50							FA083TT			FA083R	N/A			
51							FA083TT			FA083R	N/A			
52							FA083TT			FA083R	N/A			
53							FA083TT			FA083R	N/A			
54							FA083TT			FA083R	N/A			
55							FA083TT			FA083R	N/A			
56							FA083TT			FA083R	N/A			
57							Y527			Y527G				
58							FA083TT			FA083R	N/A			
59							FA083TT			FA083R	N/A			
60							FA083TT			FA083R	N/A			

REAR / ARRIÈRE / HINTEN / POSTERIOR / POSTERIORE

R Suffix = High Durability Sintered Pad. **HH** Suffix = High Performance Sintered Pad. **TT** Suffix = Hard Wearing Off Road Pad. **V** Suffix = Semi Sintered Pad. **G** Suffix = Grooved Shoe.
D Suffix = Drilled Disc. **X** Suffix = Universal Left or Right Disc. **XC** Suffix = Contoured Disc. **LS** Suffix = Left/Steel Disc. **RS** = Right/Steel Disc.

*-2 Sets Required. † For Vee disc colours add RED, BLU, GRN, GLD, ORG suffix to part number.
 Ⓢ - Also available as a Vintage Motorcycle Disc.

Part numbers, prefixes, suffixes, photos and illustrations shown in this catalogue are trademarks and/or copyrights of EBC Brakes or the trademark owner A C Freeman Investments Ltd and use without express written permission of the owners is punishable by law.

Non-JAPANESE Built Motorcycles



DISC PAD CHOICES - FRONT

BRAKE DISC CHOICES - FRONT

		DISC PAD CHOICES - FRONT			BRAKE DISC CHOICES - FRONT						Line #	
		FA, SFA, TT Pad or Brake Shoe	SFAC Carbon Scooter Pads	Speciality Pads - SXR / Vee / MXS	Sintered/HH Pads/ Grooved Shoes	Left / Gauche / Links Standard Replacement Disc	Right / Droite / Rechts Standard Replacement Disc	Contour Disc Universal left and right filment	Universal Custom Disc	Vee-Discs Black † See note below		CX Extreme MX Race Disc/ UTVX Disc
X100		H346*			H346G*							1
WK 110 White Knuckle (Pit Bike)	06-08	SFA169	SFAC169		SFA169HH							2
RV 125 Midi RV Bug		FA416TT*			FA416R*	N/A	N/A					3
WK 125 White Knuckle (Pit Bike)	06-11	SFA169	SFAC169		SFA169HH	N/A						4
WK 140 White Knuckle (Pit Bike)	06-08	FA448				N/A						5
BR 150 E Bugrider	04-06	FA416TT*			FA416R*	N/A	N/A					6
CVT 150 E	10-11	FA453TT*			FA453R*	N/A	N/A					7
RV 150 Midi RV Buggie		FA416TT*			FA416R*	N/A	N/A					8
Ram R170	03-05	Y503*			Y503G*							9
Ram R170 E Stinger	03-05	Y503*			Y503G*							10
Stinger R170E	06	Y503*			Y503G*							11
4 Cross 200 E SUV	06-07	FA083TT*			FA083R*	N/A	N/A					12
4 Cross 200cc		H307*			H307G*							13
BR 200	07-08	FA416TT*			FA416R*	N/A	N/A					14
QZ 200 (Front disc model)		FA067TT*			FA067R*	N/A	N/A					15
R200 E Stinger	06-07	Y503*			Y503G*	N/A	N/A					16
ST 200 E (Automatic)	06-07	Y503*			Y503G*							17
ST 200 E (5 speed manual)	06-07	FA083TT*			FA083R*	N/A	N/A					18
250e	06-11	FA067TT*			FA067R*	N/A	N/A					19
BR 250 E Bugrider	05-08	FA416TT*			FA416R*	N/A	N/A					20
BR 250		FA416TT*			FA416R*	N/A	N/A					21
QZ 250 (Front disc model)		FA067TT*			FA067R*	N/A	N/A					22
Ram R250	03-05	Y503*			Y503G*							23
Ram R250E Stinger	03-05	Y503*			Y503G*							24
Stinger R250E	06	FA083TT*			FA083R*	N/A	N/A					25
XRV 250 (Off Road)	06	FA416TT*			FA416R*	N/A	N/A					26
XRV 250 E	06-07	FA416TT*			FA416R*	N/A	N/A					27
XRV 250		FA416TT*			FA416R*	N/A	N/A					28
QZ 270		FA067TT*			FA067R*	N/A	N/A					29
300e XLC Stinger	07-08	FA067TT*			FA067R*	N/A						30
300e XLC	07-08	FA067TT*			FA067R*	N/A	N/A					31
300e Stinger	09-11	FA067TT*			FA067R*	N/A	N/A					32
300e SUV (Automatic)	06	FA453TT*			FA453R*	N/A	N/A					33
300e (4x4) (Auto)	06-07	FA453TT*			FA453R*	N/A	N/A					34
300e XLC	06-07	FA083TT*			FA083R*	N/A	N/A					35
300SE 4 Valve	06-07	FA083TT*			FA083R*	N/A	N/A					36
300e SUV (Manual)	06-07	FA453TT*			FA453R*	N/A	N/A					37
CUV 300 (4x4 Super Utility Side x Side)		08	FA482TT*			FA482R*	N/A	N/A				38
CUV 300 E 4x4 Side x Side	08-09	FA482TT*			FA482R*	N/A	N/A					39
CUV 300 E 4x4 Side x Side - Parking brake	08-09	FA481										40
Jow 300	07-08	FA067TT*			FA067R*	N/A	N/A					41
Quadzilla 300	04-05	FA453TT*			FA453R*	N/A	N/A					42
QZ 300 XLC		FA067TT*			FA067R*	N/A	N/A					43
QZ 300 E 4x4		FA483TT*			FA483R*	N/A	N/A					44
QZ 300 E 4x4 - Parking brake		FA431TT										45
RL 300 Buggie	07-08	FA416TT*			FA416R*	N/A	N/A					46
RL 300 Buggie	09-11	FA067TT*			FA067R*	N/A	N/A					47
WK 300 White Knuckle (Pit Bike)	06-08	FA228			FA228HH	N/A						48
XL 300		FA416TT*			FA416R*	N/A	N/A					49
320e 4x4	07-08	FA453TT*			FA453R*	N/A	N/A					50
320e 4x4 - Parking brake	07-08	FA270TT			FA270R							51
320 CUV		FA067TT*			FA067R*	N/A	N/A					52
CVT 320e	07-11	FA453TT*			FA453R*	N/A	N/A					53
CVT 320e - Parking brake	07-11	FA270TT			FA270R							54
QZ 320e 4x4	09	FA483TT*			FA483R*	N/A	N/A					55
QZ 320e 4x4 - Parking brake	09	FA431TT			FA431R							56
325 4 x 4 Quad	10-11	FA483TT*			FA483R*	N/A	N/A					57
QZ 450 RS	06-09	FA067TT*			FA067R*	N/A	N/A					58
QZ 450 Sport	08-09	FA067TT*			FA067R*	N/A	N/A					59
500 4 x 4	06-07	FA453TT*			FA453R*	N/A	N/A					60

FRONT / AVANT / VORN / FRENTE / ANTERIORE

R Suffix = High Durability Sintered Pad. **HH** Suffix = High Performance Sintered Pad. **TT** Suffix = Hard Wearing Off Road Pad. **V** Suffix = Semi Sintered Pad. **G** Suffix = Grooved Shoe.
D Suffix = Drilled Disc. **X** Suffix = Universal Left or Right Disc. **XC** Suffix = Contoured Disc. **LS** Suffix = Left/Steel Disc. **RS** = Right/Steel Disc.

*-2 Sets Required. † For Vee disc colours add RED, BLU, GRN, GLD, ORG suffix to part number.

⊗ - Also available as a Vintage Motorcycle Disc.

Non-JAPANESE Built Motorcycles

Line #	BRAKE DISC CHOICES - FRONT						DISC PAD CHOICES - REAR				BRAKE DISC CHOICES - REAR			
	Oversize 250 /280mm Disc Kit	OSX Oversize 250/280mm Disc Kit	Relocating Bracket for 250/ 280mm Disc	Oversize 320mm Disc Kit	SMX Oversize 320mm Disc Kit	Relocating Bracket for 320mm Disc	FA, SFA, TT Pad or Brake Shoe	SFAC Carbon Scooter Pads	Speciality Pads - SXR / Vee / MXS	Sintered/ HH Pads/ Grooved Shoes	Standard Replacement Disc	Contour Disc Rear fitment	Vee-Discs™ CONTOUR	CX Extreme MX Race Disc/ UTVX Disc
1							FA083TT			FA083R	N/A			
2							FA086			FA086HH	N/A			
3							FA054TT			FA054R	N/A			
4							FA086			FA086HH	N/A			
5							FA480				N/A			
6							FA054TT			FA054R	N/A			
7							FA431TT			FA431R	N/A			
8							FA054TT			FA054R	N/A			
9							FA135TT			FA135R	N/A			
10							FA135TT			FA135R	N/A			
11							FA135TT			FA135R	N/A			
12							FA067TT			FA067R	N/A			
13							FA165TT			FA165R	N/A			
14							FA054TT			FA054R	N/A			
15							FA067TT			FA067R	N/A			
16							FA135TT			FA135R	N/A			
17							FA135TT			FA135R	N/A			
18							FA067TT			FA067R	N/A			
19							FA067TT			FA067R	MD6364D			
20							FA431TT			FA431R	N/A			
21							FA054TT			FA054R	N/A			
22							FA067TT			FA067R	MD6364D			
23							FA135TT			FA135R	N/A			
24							FA135TT			FA135R	N/A			
25							FA067TT			FA067R	MD6364D			
26							FA431TT			FA431R	N/A			
27							FA431TT			FA431R	N/A			
28							FA054TT			FA054R	N/A			
29							FA067TT			FA067R	MD6364D			
30							FA067TT			FA067R	N/A			
31							FA067TT			FA067R	N/A			
32							FA067TT			FA067R	N/A			
33							FA270TT			FA270R	N/A			
34							FA270TT			FA270R	N/A			
35							FA067TT			FA067R	N/A			
36							FA067TT			FA067R	N/A			
37							FA270TT			FA270R	N/A			
38								FA453TT*		FA453R*	N/A*			
39							FA270TT			FA270R	N/A			
40														
41							FA067TT			FA067R	N/A			
42							FA270TT			FA270R	N/A			
43							FA067TT			FA067R	N/A			
44							FA270TT			FA270R	N/A			
45														
46							FA431TT			FA431R	N/A			
47							FA067TT			FA067R	N/A			
48							FA197			FA197HH	N/A			
49							FA054TT			FA054R	N/A			
50							FA431TT			FA431R	N/A			
51														
52							FA067TT			FA067R	N/A			
53							FA431TT			FA431R	N/A			
54														
55							FA270TT			FA270R	N/A			
56														
57							FA482TT			FA482R	N/A			
58							FA067TT			FA067R	MD6348D			
59							FA067TT			FA067R	MD6348D			
60							FA270TT			FA270R	N/A			

REAR / ARRIÈRE / HINTEN / POSTERIOR / POSTERIORE

R Suffix = High Durability Sintered Pad. HH Suffix = High Performance Sintered Pad. TT Suffix = Hard Wearing Off Road Pad. V Suffix = Semi Sintered Pad. G Suffix = Grooved Shoe.
D Suffix = Drilled Disc. X Suffix = Universal Left or Right Disc. XC Suffix = Contoured Disc. LS Suffix = Left/Steel Disc. RS = Right/Steel Disc.

*-2 Sets Required. † For Vee disc colours add RED, BLU, GRN, GLD, ORG suffix to part number.
⊗ - Also available as a Vintage Motorcycle Disc.

Part numbers, prefixes, suffixes, photos and illustrations shown in this catalogue are trademarks and/or copyrights of EBC Brakes or the trademark owner A C Freeman Investments Ltd and use without express written permission of the owners is punishable by law.

Non-JAPANESE Built Motorcycles



DISC PAD CHOICES - FRONT

BRAKE DISC CHOICES - FRONT

R Suffix = High Durability Sintered Pad. **HH** Suffix = High Performance Sintered Pad. **TT** Suffix = Hard Wearing Off Road Pad. **V** Suffix = Semi Sintered Pad. **G** Suffix = Grooved Shoe.

D Suffix = Drilled Disc. **X** Suffix = Universal Left or Right Disc. **XC** Suffix = Contoured Disc. **LS** Suffix = Left/Steel Disc. **RS** = Right/Steel Disc.

FRONT / AVANT / VORN / FRENTE / ANTERIORE

Model	Year	Side	DISC PAD CHOICES - FRONT				BRAKE DISC CHOICES - FRONT					Line #	
			FA, SFA, TT Pad or Brake Shoe	SFAC Carbon Scooter Pads	Speciality Pads - SXR / Vee / MXS	Sintered/HH Pads/ Grooved Shoes	Left / Gauche / Links Standard Replacement Disc	Right / Droite / Rechts Standard Replacement Disc	Contour Disc Universal left and right fitment	Universal Custom Disc	Vee-Discs Black † See note below		CX Extreme MX Race Disc/ UTVX Disc
CUV 500 Side x Side	10-11		FA453TT*			FA453R*	N/A						1
CUV 500 Side x Side - Parking brake	10-11		FA232TT	FA232R									2
QZ 500 E/ES 4x4	09-11		FA453TT*			FA453R*	N/A	N/A					3
QZ 500 E/ES 4x4 - Parking brake	09-11		FA232TT	FA232R									4
RL 500 Buggie	08-09		FA171*			FA171HH*	N/A	N/A					5
RL 500 MK 11 Buggie	10-11		FA453TT*			FA453R*	N/A	N/A					6
RS5 4WD	10-11		FA453TT*			FA453R*	N/A	N/A					7
RS5 4WD - Parking brake	10-11		FA232TT	FA232R									8
XLC 500	10-15		FA067TT*			FA067R*	N/A	N/A					9
RS6 4WD	10-11	Left	FA135TT			FA135R	N/A	N/A					10
		Right	FA165TT			FA165R							11
RS7 4WD	10-11		FA377TT*			FA377R*	N/A	N/A					12
X7R	10-11		FA377TT*			FA377R*	N/A	N/A					13
RS8	10-11		FA377TT*			FA377R*	N/A	N/A					14
Z6 4 x 4	10-13		FA453TT*			FA453R*	N/A	N/A					15
X8 (4 x 4/Efi)	12-15		FA453TT*			FA453R*	N/A	N/A					16
Z8 (4 x 4/Side X Side)	14-15	Left	FA135TT			FA135R	N/A	N/A					17
		Right	FA165TT			FA165R							18
RIEJU													19
MIUS-Electric	12-15		SFA083	SFAC083		SFA083HH		N/A					20
MRT 50 (Single piston caliper)	09-21		FA093				N/A						21
MRT-Pro 50 (Radial/double piston caliper)	09-21		FA266			FA266HH			N/A				22
MRT Supermotard 50 (Cast wheel/single piston caliper)	09-21		FA093				N/A						23
MRT-Pro Supermotard (Radial caliper/cast wheel)	09-21		FA266			FA266HH			N/A				24
MRT 50 Competizione (Spoke Wheel)	11-14		FA465TT		MXS465	FA465R			N/A				25
MRX 50 Castrol	01-02		FA167			FA167HH	N/A						26
MRX 50	03-08		FA115			FA115R	N/A						27
MRX 50 Pro/Top	04-08		FA194			FA194HH	N/A						28
RS2 NKD	05		FA194			FA194HH		N/A					29
NKD 50	07		FA374				N/A						30
NKD 50	08-10		FA375		FA375V	FA375HH			N/A				31
Pacific 50 (4T)	08		SFA235	SFAC235			N/A						32
Urban Blast (50cc)	13-15		SFA083	SFAC083		SFA083HH	N/A						33
RS1 50cc	97-00		FA115			FA115HH	N/A						34
RS1 50cc	01-04		FA167			FA167HH	N/A						35
RR 50cc Thunderfire	97-02		FA115			FA115HH	N/A						36
RR 50 Castrol	00-02		FA167			FA167HH	N/A						37
RR 50 Sport	03-06		FA115			FA115HH	N/A						38
RRX 50 Spike (17" wheel/spoke wheel)	03-08		FA115			FA115HH	N/A						39
RRX 50 Spike (17" cast wheel)	06-09		FA115			FA115HH	N/A						40
RRX 50	06-09		FA115			FA115HH	N/A						41
RS2 50 FR	09-10		FA375		FA375V	FA375HH			N/A				42
RS2 Matrix (50cc) (AJP Caliper)	02-08		FA374					N/A					43
RS2 50cc Matrix (J. Juan Caliper)	07-09		FA375		FA375V	FA375HH			N/A				44
RS2 50cc Pro (J. Juan Caliper)	07-10		FA375		FA375V	FA375HH			N/A				45
RS2 50cc Pro (AJP Caliper)	06-10		FA194			FA194HH			N/A				46
RS3 50cc	11-21		FA374					N/A					47
RS3 NKD 50	12-21		FA266		FA266V	FA266HH			N/A				48
RS3 Pro 50cc	11-15		FA086			FA086HH		N/A					49
RS NKD 50 (Scooter)	13-15		SFA083	SFAC083		SFA083HH			N/A				50
RS Sport 50 (Scooter)	12-15		SFA083	SFAC083		SFA083HH			N/A				51
SMX 50	02-06		FA115			FA115R	N/A						52
SMX 50 Pro Supermotard/Top	04-07		FA194			FA194HH	N/A						53
SMX 50 Pro Street (Cast wheel)	06-08		FA194			FA194HH	N/A						54
SMX 50 (Cast Wheel)	07-08		FA115			FA115HH	N/A						55
Spike 50	04-06		FA115			FA115HH	N/A						56
Spike 50 Pro	04		FA167			FA167HH	N/A						57
Spike X50	06-07		FA115			FA115HH	N/A						58
Tango 50 (Spoke Wheel)	11		FA093				N/A						59
Tango 50 Motard	09-10		FA093				N/A						60

*-2 Sets Required. † For Vee disc colours add RED, BLU, GRN, GLD, ORG suffix to part number.

⊗ - Also available as a Vintage Motorcycle Disc.

Non-JAPANESE Built Motorcycles

Line #	BRAKE DISC CHOICES - FRONT						DISC PAD CHOICES - REAR				BRAKE DISC CHOICES - REAR			
	Oversize 250 /280mm Disc Kit	OSX Oversize 250/280mm Disc Kit	Relocating Bracket for 250/ 280mm Disc	Oversize 320mm Disc Kit	SMX Oversize 320mm Disc Kit	Relocating Bracket for 320mm Disc	FA, SFA, TT Pad or Brake Shoe	SFAC Carbon Scooter Pads	Speciality Pads - SXR / Vee / MXS	Sintered/ HH Pads/ Grooved Shoes	Standard Replacement Disc	Contour Disc Rear fitment	Vee-Discs™ CONTOUR	CX Extreme MX Race Disc/ UTVX Disc
1							FA344TT			FA344R	N/A			
2														
3							FA344TT			FA344R	N/A			
4														
5							FA171*			FA171HH*	N/A*			
6							FA344TT			FA344R	N/A			
7							FA344TT			FA344R	N/A			
8														
9							FA067TT			FA067R	N/A			
10							TBA*			TBA*	N/A*			
11														
12							FA067TT			FA067R	N/A			
13							FA067TT			FA067R	N/A			
14							FA067TT			FA067R	N/A			
15							FA344TT			FA344R	N/A			
16							FA344TT			FA344R	N/A			
17							FA651TT			FA651R	N/A*			
18							FA651TT			FA651R				
19														
20							SFA083	SFAC083		SFA083HH	N/A			
21							FA093				N/A			
22							FA093					N/A		
23							FA093				N/A			
24							FA093				N/A			
25							FA367/2TT			FA367/2R		N/A		
26							FA115			FA115HH	N/A			
27							FA115			FA115R	N/A			
28							FA115			FA115HH	N/A			
29							FA115			FA115HH	N/A			
30							FA115			FA115HH	TBA			
31							FA093				N/A			
32							TBA							
33							Y530							
34							FA115			FA115HH	N/A			
35							FA115			FA115HH	N/A			
36							FA115			FA115HH	N/A			
37							FA115			FA115HH	N/A			
38							FA115			FA115HH	N/A			
39							FA115			FA115HH	N/A			
40							FA115			FA115HH	N/A			
41							FA115			FA115HH	N/A			
42							FA093				N/A			
43							FA350			FA350HH	N/A			
44							FA093				N/A			
45							FA093					N/A		
46							FA350			FA350HH		N/A		
47							FA093				N/A			
48							FA083TT			FA083HH		N/A		
49							FA093				N/A			
50							SFA193	SFAC193		SFA193HH		N/A		
51							SFA193	SFAC193		SFA193HH		N/A		
52							FA115			FA115R	N/A			
53							FA115			FA115HH	N/A			
54							FA115			FA115HH	N/A			
55							FA115			FA115HH	N/A			
56							FA115			FA115HH	N/A			
57							FA115			FA115HH	N/A			
58							FA115			FA115HH	N/A			
59							FA093				N/A			
60							FA350			FA350HH	N/A			

REAR / ARRIÈRE / HINTEN / POSTERIOR / POSTERIORE

R Suffix = High Durability Sintered Pad. **HH** Suffix = High Performance Sintered Pad. **TT** Suffix = Hard Wearing Off Road Pad. **V** Suffix = Semi Sintered Pad. **G** Suffix = Grooved Shoe.
D Suffix = Drilled Disc. **X** Suffix = Universal Left or Right Disc. **XC** Suffix = Contoured Disc. **LS** Suffix = Left/Steel Disc. **RS** = Right/Steel Disc.

*-2 Sets Required. † For Vee disc colours add RED, BLU, GRN, GLD, ORG suffix to part number.
 Ⓢ - Also available as a Vintage Motorcycle Disc.

Part numbers, prefixes, suffixes, photos and illustrations shown in this catalogue are trademarks and/or copyrights of EBC Brakes or the trademark owner A C Freeman Investments Ltd and use without express written permission of the owners is punishable by law.

Non-JAPANESE Built Motorcycles



RIEJU Contd.



DISC PAD CHOICES - FRONT

BRAKE DISC CHOICES - FRONT

FA, SFA, TT Pad or Brake Shoe	SFAC Carbon Scooter Pads	Speciality Pads - SXR / Vee / MXS	Sintered/HH Pads/ Grooved Shoes	Left / Gauche / Links Standard Replacement Disc	Right / Droite / Rechts Standard Replacement Disc	Contour Disc Universal left and right fitment	Universal Custom Disc	Vee-Discs Black † See note below	CX Extreme MX Race Disc/ UTVX Disc
Tango 50 Motard (Cast Wheel)	11	FA093				N/A			
Tango 50 (2T)	07-12	FA266		FA266HH		N/A			
Tango 50 (2T)	13-15	FA465TT		MXS465	FA465R	N/A			
Toreo 50 (4T)	07-08	SFA235	SFAC235			N/A			
Cityline 125 ie	13-15	SFA353	SFAC353		SFA353HH		N/A		
Marathon 125 (Air Cooled)	10-15	FA093					N/A		
Marathon 125 SM (Air Cooled)	10-15	FA093					N/A		
Marathon Pro 125 (Radial/double piston caliper/Spoke Wheel)	09-21	FA266		FA266HH			N/A		
Marathon Pro 125 Competizione (Spoke Wheel)	11-14	FA465TT		MXS465	FA465R		N/A		
Marathon Pro Supermotard 125 (Cast wheel/radial caliper)	09-21	FA266		FA266HH			N/A		
MRX 125	02-08	FA167		FA167HH		N/A			
NKD 125	06-07	FA374					N/A		
NKD 125	08-10	FA375		FA375V	FA375HH		N/A		
Pacific 125 (4T)	08	SFA235	SFAC235			N/A			
Pacific 125 Scooter	09	SFA235	SFAC235			TBA			
RS2 125 (AJP Caliper)	06-10	FA374					N/A		
RS2 125 (J. Juan Caliper)	07-10	FA375		FA375V	FA375HH		N/A		
RS2 125 Pro (J. Juan Caliper)	07-10	FA375		FA375V	FA375HH		N/A		
RS3 NKD 125cc	11-21	FA266		FA266V	FA266HH		N/A		
RS3 125cc (Sport)	11-21	FA374					N/A		
SMX 125	02-07	FA167		FA167HH		N/A			
SMX 125 (Cast wheel)	07-08	FA266		FA266HH		N/A			
Tango 125	06-10	FA266		FA266HH		N/A			
Tango 125 (4T)	11-21	FA465TT		MXS465	FA465R	N/A			
Tango 125 Motard (Cast wheel)	08-09	FA266		FA266HH		N/A			
Tango Pro 125	07-10	FA266		FA266HH			N/A		
Marathon 200 Pro SM	11-15	FA266		FA266HH			N/A		
Marathon 250	09-10	FA181TT		MXS181	FA181R		N/A		
Tango 250	08-11	FA266		FA266HH		N/A			
Tango 250 (4T)	12-15	FA465TT		MXS465	FA465R	N/A			
Cityline 300 ie	14-15	SFA353	SFAC353		SFA353HH		N/A		
Marathon 450	09-10	FA181TT		MXS181	FA181R		N/A		
MR Pro 200/250/300cc 2T	19-21	FA181TT			FA181R				
MR Racing 200/250/300cc 2T	19-21	FA181TT			FA181R				
MR Ranger 200/250/300cc 2T	19-21	FA181TT			FA181R				
ROXON									
Duel 50 SM	06	FA115		FA115HH		N/A			
Duel 50 SM	06	FA115		FA115HH		N/A			
Duel 50 TT	06	FA115		FA115HH		N/A			
Fox 50 (Quad)	04-06	H338*		H338G*					
Go-Kart Enfant X-Cube	06	N/A							
Silver Fox 50 (Quad)	04-06	TBA*							
Fox 100 (Quad)	04-06	TBA*							
RX 150 (Quad)	04-06	TBA*							
Sport Spirit NFS 150 (Quad)	04-06	TBA*							
ROYAL ENFIELD									
Bullet 350 EFI/Dual Seat/2 Pin pad	09-15			FA228HH		MD847			
Bullet 350 EFI/Dual Seat/1 pin pad	09-15	FA228		FA228HH		MD847			
Bullet 500 (Efi/Dual Seat)	09-15	FA228		FA228HH		MD847			
Bullet 500 (Efi/Single Seat)	16-18	FA181TT		FA181HH		MD847			
Bullet Electra X (All disc models/Dual Seat)	05-15	FA228		FA228HH		MD847			
Bullet Classic 500 (Efi/Single Seat)	09-15	FA228		FA228HH		MD847			
Bullet Classic 500 EFI/Single Seat/ 1 Pin Pad	15-21	FA228		FA228HH		MD847			
Bullet Classic Chrome 500 (Efi/Single Seat)	09-15	FA228		FA228HH		MD847			
Bullet Battle Green 500 (Efi/Single Seat)	09-15	FA228		FA228HH		MD847			
Bullet Desert Storm 500 (Efi/Single Seat)	12-15	FA228		FA228HH		MD847			
Classic 500 (Efi/Single Seat)	16-20	FA181TT		FA181HH					
Classic Chrome 500 (Efi/Single Seat)	16-18	FA181TT		FA181HH					

Line #

FRONT / AVANT / VORN / FREITE / ANTERIORE

R Suffix = High Durability Sintered Pad. HH Suffix = High Performance Sintered Pad. TT Suffix = Hard Wearing Off Road Pad. V Suffix = Semi Sintered Pad. G Suffix = Grooved Shoe.
 D Suffix = Drilled Disc. X Suffix = Universal Left or Right Disc. XC Suffix = Contoured Disc. LS Suffix = Left/Steel Disc. RS = Right/Steel Disc.

*-2 Sets Required. † For Vee disc colours add RED, BLU, GRN, GLD, ORG suffix to part number.

⊗ - Also available as a Vintage Motorcycle Disc.

Non-JAPANESE Built Motorcycles

Line #	BRAKE DISC CHOICES - FRONT						DISC PAD CHOICES - REAR				BRAKE DISC CHOICES - REAR			
	Oversize 250 /280mm Disc Kit	OSX Oversize 250/280mm Disc Kit	Relocating Bracket for 250/ 280mm Disc	Oversize 320mm Disc Kit	SMX Oversize 320mm Disc Kit	Relocating Bracket for 320mm Disc	FA, SFA, TT Pad or Brake Shoe	SFAC Carbon Scooter Pads	Speciality Pads - SXR / Vee / MXS	Sintered/ HH Pads/ Grooved Shoes	Standard Replacement Disc	Contour Disc Rear fitment	Vee-Discs™ CONTOUR	CX Extreme MX Race Disc/ UTVX Disc
1							FA350			FA350HH	N/A			
2							FA350			FA350HH	N/A			
3							FA350			FA350HH	N/A			
4							TBA							
5							SFA266	SFAC266		SFA266HH		N/A		
6							FA093				N/A			
7							FA093				N/A			
8							FA093					N/A		
9							FA367/2TT			FA367/2R		N/A		
10							FA093					N/A		
11							FA115			FA115HH	N/A			
12							FA350			FA350HH	N/A			
13							FA093				N/A			
14							TBA							
15							TBA							
16							FA350			FA350HH	N/A			
17							FA093				N/A			
18							FA093					N/A		
19							FA083TT			FA083HH		N/A		
20							FA083TT			FA083HH	N/A			
21							FA350			FA350HH	N/A			
22							FA350			FA350HH	N/A			
23							FA350			FA350HH	N/A			
24							FA350TT				N/A			
25							FA093				N/A			
26							FA350			FA350HH		N/A		
27							FA093				N/A			
28							FA368TT		MXS368	FA368R		N/A		
29							FA350			FA350HH	N/A			
30							FA350TT				N/A			
31							SFA266	SFAC266		SFA266HH		N/A		
32							FA368TT		MXS368	FA368R		N/A		
33							FA368TT		MXS368	FA368R				
34							FA368TT		MXS368	FA368R				
35							FA368TT		MXS368	FA368R				
36														
37														
38							FA115			FA115HH	N/A			
39							FA115			FA115HH	N/A			
40							FA115			FA115HH	N/A			
41							H307			H307G				
42							FA083TT			FA083R	N/A			
43							FA083TT			FA083R				
44							FA083TT			FA083R				
45							FA083TT			FA083R	N/A			
46							FA083TT			FA083R	N/A			
47														
48														
49														
50														
51							N/A							
52							FA213		FA213V	FA213HH				
53							N/A							
54							N/A							
55							FA213			FA213HH				
56							N/A							
57							N/A							
58							N/A							
59							FA213		FA213V	FA213HH				
60							FA213		FA213V	FA213HH				

REAR / ARRIÈRE / HINTEN / POSTERIOR / POSTERIORE

R Suffix = High Durability Sintered Pad. HH Suffix = High Performance Sintered Pad. TT Suffix = Hard Wearing Off Road Pad. V Suffix = Semi Sintered Pad. G Suffix = Grooved Shoe.
D Suffix = Drilled Disc. X Suffix = Universal Left or Right Disc. XC Suffix = Contoured Disc. LS Suffix = Left/Steel Disc. RS = Right/Steel Disc.

*-2 Sets Required. † For Vee disc colours add RED, BLU, GRN, GLD, ORG suffix to part number.

⊗ - Also available as a Vintage Motorcycle Disc.

Part numbers, prefixes, suffixes, photos and illustrations shown in this catalogue are trademarks and/or copyrights of EBC Brakes or the trademark owner A C Freeman Investments Ltd and use without express written permission of the owners is punishable by law.

Non-JAPANESE Built Motorcycles



ROYAL ENFIELD Contd.



Clubman 500 EFI	09-12
Electra 500 EFI	09-14
Fury 500 (Efi)	11-12
Himalayan	16-21
Trials 500 EFI	09-12
Woodsman 500 EFI	09-12
535cc Continental GT (Non ABS)	13-16
535cc Continental GT (ABS)	17-21
Interceptor 650 Twin	18-21
Continental 650 Twin	18-21

SACHS (HERCULES)

Diff. older models with disc brake	
49ER 10	07
50 KX 5	
50 Supra Enduro	
50 Supra 4 GP	
50 Ultra, RS Ultra	
Bee 50	08-10
Madass 50 (2 stroke) (Hydraulic rear brake)	04-05
Madass 50 (4 stroke mechanical rear brake)	04-05
Madass 50 (4T)	06-09
Speedforce 50 (2T)	08
Speedjet 50(2T)	08
49ER 12	08
SX-150 (2T)	08-09
80 CV	
80 Ultra, F Ultra, RS Ultra	
80 Ultra Chopper	
80 Ultra AC	
80 Ultra AC Chopper	
80 XE 9	
Bee 125	08-09
Dirty Devil 125	08
Eagle 125	08
Madass 125	05
Madass 125 (4T)	06-09
Speedjet RS 125	10
Roadster 125 V2	00-04
X Road 125	06-07
XTC 125 Supersport	00-07
XTC 125 N	00-07
ZX 125 Enduro	01-02
ZZ 125 Funbike	02
Eagle 150	08
Quattrocento 400	08
Roadster 650	01-04
Roadster 650	05
Roadster 800	02-05
B805	03-04

SCARABEO

See Aprilia Section For Pre-2010 Models

50 (2T/Street)	10-15
50 Net (4T/4V)	10-11
50 (4T/4V)	10-15
50 YourZ (4T/4V)	10-11
100 (4T)	10-15
125ie	10-15
125 Net	10-11

DISC PAD CHOICES - FRONT

BRAKE DISC CHOICES - FRONT

FA, SFA, TT Pad or Brake Shoe	SFAC Carbon Scooter Pads	Speciality Pads - SXR / Vee / MXS	Sintered/HH Pads/ Grooved Shoes	Left / Gauche / Links Standard Replacement Disc	Right / Droite / Rechts Standard Replacement Disc	Contour Disc Universal left and right fitment	Universal Custom Disc	Vee-Discs Black † See note below	CX Extreme MX Race Disc/ UTVX Disc
FA228			FA228HH	MD847					
FA228			FA228HH	MD847					
FA228			FA228HH	MD847					
FA181TT			FA181HH	MD893					
FA228			FA228HH	MD847					
FA228			FA228HH	MD847					
FA209/2	FA209/2V		FA209/2HH	MD626X					
FA209/2	FA209/2V		FA209/2HH	MD626X					
FA209/2			FA209/2HH	MD898X		MD898XC			
FA209/2	FA209/2V		FA209/2HH	MD898X		MD898XC			
FA050				N/A					
SFA233				TBA					
FA050				N/A					
922									
FA067/2				N/A					
FA050				N/A					
SFA101	SFAC101		SFA101HH		TBA				
FA086			FA086HH	MD806LS					
FA086			FA086HH	MD806LS					
FA086			FA086HH	MD806LS					
SFA235	SFAC235			TBA					
SFA235	SFAC235			TBA					
SFA235	SFAC235			TBA					
SFA235	SFAC235			TBA					
Y503									
FA050				N/A					
FA050				N/A					
FA050				N/A					
FA050				N/A					
FA050				N/A					
SFA101	SFAC101		SFA101HH		TBA				
FA351TT				N/A					
FA086			FA086HH		TBA				
FA086			FA086HH	MD806LS					
FA086			FA086HH	MD806LS					
SFA235	SFAC235					N/A			
FA167			FA167HH	TBA					
FA095					N/A				
FA095			FA095HH		MD619RS				
FA095			FA095HH		MD619RS				
FA194			FA194HH	N/A	N/A				
SFA193	SFAC193		SFA193HH	N/A					
FA086			FA086HH		TBA				
FA142*			FA142HH*	TBA	TBA				
FA095			FA095HH		MD683RS				
FA095			FA095HH		MD683RS				
FA095*			FA095HH*	MD819	MD819				
FA095*			FA095HH*	MD819	MD819				
SFA083/2			SFA083/2HH	MD945D				VR945	
SFA083/2			SFA083/2HH	MD945D				VR945	
SFA083/2			SFA083/2HH	MD945D				VR945	
SFA083/2			SFA083/2HH	MD945D				VR945	
SFA083/2			SFA083/2HH	MD945D				VR945	
SFA324	SFAC324		SFA324HH	MD960D				VR960	
SFA324	SFAC324		SFA324HH	MD960D				VR960	

Line #

R Suffix = High Durability Sintered Pad. HH Suffix = High Performance Sintered Pad. TT Suffix = Hard Wearing Off Road Pad. V Suffix = Semi Sintered Pad. G Suffix = Grooved Shoe.
D Suffix = Drilled Disc. X Suffix = Universal Left or Right Disc. XC Suffix = Contoured Disc. LS Suffix = Left/Steel Disc. RS = Right/Steel Disc.

FRONT / AVANT / VORN / FRENTE / ANTERIORE

*-2 Sets Required. † For Vee disc colours add RED, BLU, GRN, GLD, ORG suffix to part number.

⊗ - Also available as a Vintage Motorcycle Disc.

Non-JAPANESE Built Motorcycles

Line #	BRAKE DISC CHOICES - FRONT						DISC PAD CHOICES - REAR				BRAKE DISC CHOICES - REAR			
	OverSize 250 /280mm Disc Kit	OSX OverSize 250/280mm Disc Kit	Relocating Bracket for 250/ 280mm Disc	OverSize 320mm Disc Kit	SMX OverSize 320mm Disc Kit	Relocating Bracket for 320mm Disc	FA, SFA, TT Pad or Brake Shoe	SFAC Carbon Scooter Pads	Speciality Pads - SXR / Vee / MXS	Sintered/ HH Pads/ Grooved Shoes	Standard Replacement Disc	Contour Disc Rear fitment	Vee-Discs™ CONTOUR	CX Extreme MX Race Disc/ UTVX Disc
1							N/A							
2							N/A							
3							N/A							
4							FA213		FA213HH	MD894	MD894C			
5							N/A							
6							N/A							
7							FA213	FA213V	FA213HH	MD651				
8							FA213	FA213V	FA213HH	MD877				
9							FA213	FA213V	FA213HH	MD894	MD894C			
10							FA213	FA213V	FA213HH	MD894	MD894C			
11														
12														
13							N/A							
14							TBA							
15							N/A							
16							922							
17							N/A							
18							921							
19							TBA							
20							FA115		FA115HH	N/A				
21							N/A			N/A				
22							FA054TT		FA054HH	N/A				
23							TBA							
24							TBA							
25							TBA							
26							TBA							
27							Y503							
28							921							
29							921							
30							922							
31							922							
32														
33							Y506							
34							FA351TT			N/A				
35							TBA							
36							FA086		FA086HH	N/A				
37							FA054TT		FA054HH	N/A				
38							SFA260	SFAC260			N/A			
39							Y506							
40							FA382			MD860				
41							FA382			MD815				
42							FA382			MD815				
43							FA382			N/A				
44							FA382			N/A				
45							TBA							
46							SFA260		SFA260HH	TBA				
47							FA382			MD659				
48							FA101			MD659				
49							S626							
50							S626							
51														
52														
53														
54							816							
55							816							
56							816							
57							816							
58							816							
59							SFA298	SFAC298	SFA298HH	TBA				
60							SFA298	SFAC298	SFA298HH	TBA				

REAR / ARRIÈRE / HINTEN / POSTERIOR / POSTERIORE

R Suffix = High Durability Sintered Pad. HH Suffix = High Performance Sintered Pad. TT Suffix = Hard Wearing Off Road Pad. V Suffix = Semi Sintered Pad. G Suffix = Grooved Shoe.
D Suffix = Drilled Disc. X Suffix = Universal Left or Right Disc. XC Suffix = Contoured Disc. LS Suffix = Left/Steel Disc. RS = Right/Steel Disc.

*-2 Sets Required. † For Vee disc colours add RED, BLU, GRN, GLD, ORG suffix to part number.

⊗ - Also available as a Vintage Motorcycle Disc.

Part numbers, prefixes, suffixes, photos and illustrations shown in this catalogue are trademarks and/or copyrights of EBC Brakes or the trademark owner A C Freeman Investments Ltd and use without express written permission of the owners is punishable by law.

Non-JAPANESE Built Motorcycles



SCARABEO Contd.



200ie	10-15
200 Net	10-11
300S ie	09-12
500ie	10-12

SCOMADI

TL 50 Air Cooled	15-18
TL 125 Air Cooled	15-18
TL200 Liquid Cooled	15-18

SCORPA

SR 125 (2T) (Rear pad with large friction area)	10-13
SR 125 (2T) (Rear pad with small friction area)	10-13
SR 125 Long Ride (2T) (Rear pad with large friction area)	10-11
SR 125 Long Ride (2T) (Rear pad with small friction area)	10-11
SY 125 F (4T) (Rear pad with large friction area)	03-10
SY 125 F (4T) (Rear pad with small friction area)	03-10
SY 125 FR (4T) (Rear pad with large friction area)	03-11
SY 125 FR (4T) (Rear pad with small friction area)	03-11
SY 125 (4T) Long Ride (Rear pad with large friction area)	09-10
SY 125 (4T) Long Ride (Rear pad with small friction area)	09-10
T-Ride 125 F (Enduro)	10
T-Ride 125 (2T/Enduro)	12-15
TY 125 (4T) (Rear pad with large friction area)	11-15
TY-S 125 F Enduro	03-05
TY-S 125 F (Rear pad with large friction area)	06-07
TY-S 125 F (Rear pad with small friction area)	06-07
TY-S 125 F Long Ride (Rear pad with large friction area)	06-08
TY-S 125 F Long Ride (Rear pad with small friction area)	06-08
Twenty 125 (2T)	15
SY 175 F (Rear pad with large friction area)	06
SY 175 F (Rear pad with small friction area)	06
TY-S 175 F (Rear pad with large friction area)	06
TY-S 175 F (Rear pad with small friction area)	06
SY 200 F (4T) (163cc) (Rear pad with large friction area)	08
SY 200 F (4T) (163cc) (Rear pad with small friction area)	08
250 Easy	96-99
SY 250 (2T) (Rear pad with large friction area)	00-05
SY 250 (2T) (Rear pad with small friction area)	00-05
SY 250 R (2T) (Rear pad with large friction area)	00-05
SY 250 R (2T) (Rear pad with small friction area)	00-05
SY 250 (2T) (Rear pad with large friction area)	06-09
SY 250 (2T) (Rear pad with small friction area)	06-09
SY 250 R (2T) (Rear pad with large friction area)	06-09
SY 250 R (2T) (Rear pad with small friction area)	06-09
SY 250 Long Ride (2T) (Rear pad with large friction area)	04-06
SY 250 Long Ride (2T) (Rear pad with small friction area)	04-06
SY 250 F (4T) (Rear pad with large friction area)	06-10
SY 250 F (4T) (Rear pad with small friction area)	06-10
SY 250 FR (4T) (Rear pad with large friction area)	06-10
SY 250 FR (4T) (Rear pad with small friction area)	06-10
SY 250 F (4T) Long Ride (Rear pad with large friction area)	07-08
SY 250 F (4T) Long Ride (Rear pad with small friction area)	07-08
SY 250 FR (4T) Long Ride (Rear pad with large friction area)	10
SY 250 FR (4T) Long Ride (Rear pad with small friction area)	10
Twenty 250 (2T)	15
SR 280 (2T) (Rear pad with large friction area)	09-14
SR 280 (2T) (Rear pad with small friction area)	09-14
SR 280 (2T) Long Ride (Rear pad with large friction area)	09-11
SR 280 (2T) Long Ride (Rear pad with small friction area)	09-11

FRONT / AVANT / VORN / FRENTE / ANTERIORE

DISC PAD CHOICES - FRONT				BRAKE DISC CHOICES - FRONT						Line #
FA, SFA, TT Pad or Brake Shoe	SFAC Carbon Scooter Pads	Speciality Pads - SXR / Vee / MXS	Sintered/HH Pads/ Grooved Shoes	Left / Gauche / Links Standard Replacement Disc	Right / Droite / Rechts Standard Replacement Disc	Contour Disc Universal left and right fitment	Universal Custom Disc	Vee-Discs Black † See note below	CX Extreme MX Race Disc/ UTVX Disc	Line #
SFA324	SFAC324		SFA324HH	MD960D				VR960		1
SFA324	SFAC324		SFA324HH	MD960D				VR960		2
SFA324	SFAC324		SFA324HH	MD952D				VR952		3
SFA256*	SFAC256*		SFA256HH*	MD952D	MD952D			VR952*		4
										5
										6
SFA086										7
SFA086										8
SFA086										9
										10
										11
FA303TT				N/A						12
FA303TT				N/A						13
FA303TT				N/A						14
FA303TT				N/A						15
FA303TT				N/A						16
FA303TT				N/A						17
FA303TT				N/A						18
FA303TT				N/A						19
FA303TT				N/A						20
FA303TT				N/A						21
FA465TT		MXS465	FA465R	N/A						22
FA083TT			FA083R			N/A				23
FA303TT				N/A						24
FA115TT		MXS115	FA115R	N/A						25
FA115TT		MXS115	FA115R	N/A						26
FA115TT		MXS115	FA115R	N/A						27
FA115TT		MXS115	FA115R	N/A						28
FA115TT		MXS115	FA115R	N/A						29
FA303TT				N/A						30
FA303TT				N/A						31
FA303TT				N/A						32
FA115TT		MXS115	FA115R	N/A						33
FA115TT		MXS115	FA115R	N/A						34
FA303TT				N/A						35
FA303TT				N/A						36
FA115TT		MXS115	FA115R	N/A						37
FA303TT				N/A						38
FA303TT				N/A						39
FA303TT				N/A						40
FA303TT				N/A						41
FA303TT				N/A						42
FA303TT				N/A						43
FA303TT				N/A						44
FA303TT				N/A						45
FA303TT				N/A						46
FA303TT				N/A						47
FA303TT				N/A						48
FA303TT				N/A						49
FA303TT				N/A						50
FA303TT				N/A						51
FA303TT				N/A						52
FA303TT				N/A						53
FA303TT				N/A						54
FA303TT				N/A						55
FA303TT				N/A						56
FA303TT				N/A						57
FA303TT				N/A						58
FA303TT				N/A						59
FA303TT				N/A						60

*-2 Sets Required. † For Vee disc colours add RED, BLU, GRN, GLD, ORG suffix to part number.

⊗ - Also available as a Vintage Motorcycle Disc.

Non-JAPANESE Built Motorcycles

Line #	BRAKE DISC CHOICES - FRONT						DISC PAD CHOICES - REAR				BRAKE DISC CHOICES - REAR			
	Oversize 250 /280mm Disc Kit	OSX Oversize 250/280mm Disc Kit	Relocating Bracket for 250/ 280mm Disc	Oversize 320mm Disc Kit	SMX Oversize 320mm Disc Kit	Relocating Bracket for 320mm Disc	FA, SFA, TT Pad or Brake Shoe	SFAC Carbon Scooter Pads	Speciality Pads - SXR / Vee / MXS	Sintered/ HH Pads/ Grooved Shoes	Standard Replacement Disc	Contour Disc Rear fitment	Vee-Discs™ CONTOUR	CX Extreme MX Race Disc/ UTVX Disc
1							SFA298	SFAC298		SFA298HH	TBA			
2							SFA298	SFAC298		SFA298HH	TBA			
3							SFA298	SFAC298		SFA298HH	TBA			
4							SFA298	SFAC298		SFA298HH	TBA			
5														
6														
7							TBA							
8							TBA							
9							SFA264							
10														
11														
12							FA351TT				N/A			
13							FA471				N/A			
14							FA351TT				N/A			
15							FA471				N/A			
16							FA351TT				N/A			
17							FA471				N/A			
18							FA351TT				N/A			
19							FA471				N/A			
20							FA351TT				N/A			
21							FA471				N/A			
22							FA350TT				N/A			
23							FA083TT		FA083R		N/A			
24							FA351TT				N/A			
25							FA115TT	MXS115	FA115R		N/A			
26							FA351TT				N/A			
27							FA471				N/A			
28							FA351TT				N/A			
29							FA471				N/A			
30							FA351TT				N/A			
31							FA351TT				N/A			
32							FA471				N/A			
33							FA351TT				N/A			
34							FA471				N/A			
35							FA351TT				N/A			
36							FA471				N/A			
37							FA115TT	MXS115	FA115R		N/A			
38							FA351TT				N/A			
39							FA471				N/A			
40							FA351TT				N/A			
41							FA471				N/A			
42							FA351TT				N/A			
43							FA471				N/A			
44							FA351TT				N/A			
45							FA471				N/A			
46							FA351TT				N/A			
47							FA471				N/A			
48							FA351TT				N/A			
49							FA471				N/A			
50							FA351TT				N/A			
51							FA471				N/A			
52							FA351TT				N/A			
53							FA471				N/A			
54							FA351TT				N/A			
55							FA471				N/A			
56							FA351TT				N/A			
57							FA351TT				N/A			
58							FA471				N/A			
59							FA351TT				N/A			
60							FA471				N/A			

REAR / ARRIÈRE / HINTEN / POSTERIOR / POSTERIORE

R Suffix = High Durability Sintered Pad. HH Suffix = High Performance Sintered Pad. TT Suffix = Hard Wearing Off Road Pad. V Suffix = Semi Sintered Pad. G Suffix = Grooved Shoe.
D Suffix = Drilled Disc. X Suffix = Universal Left or Right Disc. XC Suffix = Contoured Disc. LS Suffix = Left/Steel Disc. RS = Right/Steel Disc.

*-2 Sets Required. † For Vee disc colours add RED, BLU, GRN, GLD, ORG suffix to part number.
⊗ - Also available as a Vintage Motorcycle Disc.

Non-JAPANESE Built Motorcycles



SCORPA Contd.



DISC PAD CHOICES - FRONT

BRAKE DISC CHOICES - FRONT

R Suffix = High Durability Sintered Pad. HH Suffix = High Performance Sintered Pad. TT Suffix = Hard Wearing Off Road Pad. V Suffix = Semi Sintered Pad. G Suffix = Grooved Shoe.
 D Suffix = Drilled Disc. X Suffix = Universal Left or Right Disc. XC Suffix = Contoured Disc. LS Suffix = Left/Steel Disc. RS = Right/Steel Disc.

50cc Americas SM-RS 19-21
 50cc Americas SM-R 19-21
 50cc Factory SE-RS 19-21
 50cc Factory SE-R 19-21
 50cc Factory SM-RS 19-21
 50cc Factory SM-R 19-21

FRONT / AVANT / VORN / FRENTE / ANTERIORE

	FA, SFA, TT Pad or Brake Shoe	SFAC Carbon Scooter Pads	Speciality Pads - SXR / Vee / MXS	Sintered/HH Pads/ Grooved Shoes	Left / Gauche / Links Standard Replacement Disc	Right / Droite / Rechts Standard Replacement Disc	Contour Disc Universal left and right fitment	Universal Custom Disc	Vee-Disks Black † See note below	CX Extreme MX Race Disc/ UTVX Disc
T-Ride 250 F (Enduro)	08-11	FA465TT		MXS465	FA465R	N/A				
T-Ride 280 (2T/Enduro)	12-15	FA083TT			FA083R		N/A			
Twenty 300 (2T)	15	FA303TT				N/A				
Raidster 660 (Rear pad with large friction area)	07	FA244			FA244HH	TBA				
Raidster 660 (Rear pad with small friction area)	07	FA244			FA244HH	TBA				
SFM										
Bee 50 (2T)	14-15	SFA101	SFAC101		SFA101HH	N/A	N/A			
Speedjet 50 (2T)	14-15	SFA235	SFAC235				N/A			
Speedjet RS3 50 (2T)	14-15	SFA235	SFAC235				N/A			
Speedjet R 50 (2T)	14-15	SFA235	SFAC235				N/A			
Bee 125 (4T)	14-15	SFA101	SFAC101		SFA101HH	N/A	N/A			
SFM 125 8A Roadster	13-15	FA228			FA228HH	N/A				
ZX 125 Enduro (Spoke Wheels/Matching Pads)	13-15	FA086			FA086HH		N/A			
ZX 125 Enduro (Spoke Wheels/Hooked Pad)	13-15	FA228			FA228HH					
ZZ 125 SM (Cast Wheel/Matching Pads)		13-15	FA086			FA086HH				
ZZ 125 SM (Cast Wheel/Hooked Pad)	13-15	FA228			FA228HH					
SHERCO										
Enduro 50cc (2T)	02-07	FA167			FA167HH	N/A				
Enduro 50c (2T) (Urban/SU - Spoke wheel models)	08-13	FA194			FA194HH	N/A				
50 SE-R	14-15	FA083TT			FA083R		N/A			
Supermotard 50cc (2T)	02-07	FA167			FA167HH	N/A				
Supermotard 50cc (2T)	08-13	FA194			FA194HH	N/A				
SU 50 (2T) (Urban Base - Cast wheel model)	10	FA093					N/A			
SM 0.5cc Black Panther	08-10	FA194			FA194HH		N/A			
50 SM-R	14-15	FA083TT			FA083R		N/A			
50cc Americas SM-RS	19-21	FA083TT			FA083R					
50cc Americas SM-R	19-21	FA083TT			FA083R					
50cc Factory SE-RS	19-21	FA083TT			FA083R					
50cc Factory SE-R	19-21	FA083TT			FA083R					
50cc Factory SM-RS	19-21	FA083TT			FA083R					
50cc Factory SM-R	19-21	FA083TT			FA083R					
Trials 0.8 (2T)	01-04	FA115TT	MXS115		FA115R	N/A				
Trials 0.8 (2T)	05-10	FA303TT				N/A				
ST 80 (2T/Formula Calipers)	13-14	FA612TT			FA612R	N/A				
ST 80 (2T/Braktec Calipers)	14-15	FA303TT				N/A				
City Corp 125 (All models)	03-07	FA167			FA167HH	N/A				
City Corp 125 (All models)	08	FA194			FA194HH	N/A				
FST 125	18-19	FA303TT								
Trials 1.25cc (2T)	99-05	FA115TT	MXS115		FA115R	N/A				
Trials 1.25cc (2T/AJP Calipers)	06-12	FA303TT				N/A				
SE 1.25 F Enduro (4T)	10-12	FA194			FA194HH	N/A				
SM 1.25 i F Black Panther (4T)	10-12	FA194			FA194HH	N/A				
ST 125 (2T/Formula Calipers)	13-14	FA612TT			FA612R	N/A				
ST 125 (2T/Braktec Calipers)	14-15	FA303TT				N/A				
125 ST-R	18-19	FA303TT								
125 TY Classic	18-19	FA303TT								
125 SC-Factory	19-21	FA181TT	MXS181		FA181R					
125 SE-R	19-21	FA181TT	MXS181		FA181R					
125 X-Ride	19-21	FA083TT			FA083R					
X-Ride 125	12-15	FA083TT			FA083R		N/A			
XY 125 (4T)	14-15	FA303TT				N/A				
Trials 2.0cc (2T)	99-05	FA115TT	MXS115		FA115R	N/A				
Trials 2.5 (2T)	99-05	FA115TT	MXS115		FA115R	N/A				
Trials 2.5 (2T/AJP Calipers)	06-12	FA303TT				N/A				
Enduro 2.5i (4T) Inc. SE Models	08-11	FA181TT	MXS181		FA181R	N/A	N/A			
SE 250 i (2T/Brembo Rear Caliper)	12-15	FA181TT	MXS181		FA181R		N/A			
SE-R 250 (2T)	12-15	FA181TT	MXS181		FA181R		N/A			
SEF 250 (4T)	13-15	FA181TT	MXS181		FA181R		N/A			

Line #
1
2
3
4
5
6
7
8
9
10
11
12
13
14
15
16
17
18
19
20
21
22
23
24
25
26
27
28
29
30
31
32
33
34
35
36
37
38
39
40
41
42
43
44
45
46
47
48
49
50
51
52
53
54
55
56
57
58
59
60

*-2 Sets Required. † For Vee disc colours add RED, BLU, GRN, GLD, ORG suffix to part number.

⊗ - Also available as a Vintage Motorcycle Disc.

Non-JAPANESE Built Motorcycles

Line #	BRAKE DISC CHOICES - FRONT						DISC PAD CHOICES - REAR				BRAKE DISC CHOICES - REAR			
	Oversize 250 /280mm Disc Kit	OSX Oversize 250/280mm Disc Kit	Relocating Bracket for 250/ 280mm Disc	Oversize 320mm Disc Kit	SMX Oversize 320mm Disc Kit	Relocating Bracket for 320mm Disc	FA, SFA, TT Pad or Brake Shoe	SFAC Carbon Scooter Pads	Speciality Pads - SXR / Vee / MXS	Sintered/ HH Pads/ Grooved Shoes	Standard Replacement Disc	Contour Disc Rear fitment	Vee-Discs™ CONTOUR	CX Extreme MX Race Disc/ UTVX Disc
1							FA350TT				N/A			
2							FA083TT			FA083R		N/A		
3							FA351TT				N/A			
4							FA351TT				TBA			
5							FA471				TBA			
6														
7														
8							TBA							
9							TBA							
10							SFA260	SFAC260		SFA260HH		N/A		
11							TBA							
12							TBA							
13							Y527							
14							FA197			FA197HH		N/A		
15							FA197			FA197HH				
16								FA197			FA197HH			
17							FA197			FA197HH				
18														
19														
20							FA115			FA115HH	N/A			
21							FA350			FA350HH	N/A			
22							FA083TT			FA083R		N/A		
23							FA115			FA115HH	N/A			
24							FA350			FA350HH	N/A			
25							FA350					N/A		
26							FA350			FA350HH		N/A		
27							FA083TT			FA083R		N/A		
28							FA083TT			FA083R				
29							FA083TT			FA083R				
30							FA083TT			FA083R				
31							FA083TT			FA083R				
32							FA083TT			FA083R				
33							FA083TT			FA083R				
34							FA351TT				N/A			
35							FA351TT				N/A			
36							FA351TT				N/A			
37							FA351TT				N/A			
38							FA115			FA115HH	N/A			
39							FA350			FA350HH	N/A			
40							FA351TT							
41							FA115TT	MXS115	FA115R		N/A			
42							FA351TT				N/A			
43							FA350			FA350HH	N/A			
44							FA350			FA350HH	N/A			
45							FA351TT				N/A			
46							FA351TT				N/A			
47							FA351TT							
48							FA351TT							
49							FA368TT	MXS368	FA368R					
50							FA368TT	MXS368	FA368R					
51							FA083TT		FA083R					
52							FA083TT		FA083R		N/A			
53							FA351TT				N/A			
54							FA115TT	MXS115	FA115R		N/A			
55							FA115TT	MXS115	FA115R		N/A			
56							FA351TT				N/A			
57							FA367TT	MXS367	FA367R		N/A			
58							FA368TT	MXS368	FA368R		N/A			
59							FA368TT	MXS368	FA368R		N/A			
60							FA368TT	MXS368	FA368R		N/A			

REAR / ARRIÈRE / HINTEN / POSTERIOR / POSTERIORE

R Suffix = High Durability Sintered Pad. **HH** Suffix = High Performance Sintered Pad. **TT** Suffix = Hard Wearing Off Road Pad. **V** Suffix = Semi Sintered Pad. **G** Suffix = Grooved Shoe.
D Suffix = Drilled Disc. **X** Suffix = Universal Left or Right Disc. **XC** Suffix = Contoured Disc. **LS** Suffix = Left/Steel Disc. **RS** = Right/Steel Disc.

*-2 Sets Required. † For Vee disc colours add RED, BLU, GRN, GLD, ORG suffix to part number.
 Ⓢ - Also available as a Vintage Motorcycle Disc.

Part numbers, prefixes, suffixes, photos and illustrations shown in this catalogue are trademarks and/or copyrights of EBC Brakes or the trademark owner A C Freeman Investments Ltd and use without express written permission of the owners is punishable by law.

Non-JAPANESE Built Motorcycles



SHERCO Contd.



DISC PAD CHOICES - FRONT

BRAKE DISC CHOICES - FRONT

R Suffix = High Durability Sintered Pad. **HH** Suffix = High Performance Sintered Pad. **TT** Suffix = Hard Wearing Off Road Pad. **V** Suffix = Semi Sintered Pad. **G** Suffix = Grooved Shoe.

D Suffix = Drilled Disc. **X** Suffix = Universal Left or Right Disc. **XC** Suffix = Contoured Disc. **LS** Suffix = Left/Steel Disc. **RS** = Right/Steel Disc.

FRONT / AVANT / VORN / FRENTE / ANTERIORE

		FA, SFA, TT Pad or Brake Shoe	SFAC Carbon Scooter Pads	Speciality Pads - SXR / Vee / MXS	Sintered/HH Pads/ Grooved Shoes	Left / Gauche / Links Standard Replacement Disc	Right / Droite / Rechts Standard Replacement Disc	Contour Disc Universal left and right fitment	Universal Custom Disc	Vee-Discs Black † See note below	CX Extreme MX Race Disc/ UTVX Disc	Line #	
SEF-R 250 (4T)	13-15	FA181TT		MXS181	FA181R			N/A				1	
250 SC-Factory	19-21	FA181TT		MXS181	FA181R							2	
250 SCF-Factory	19-21	FA181TT		MXS181	FA181R	MD6429		MD6429C				3	
250 SE-R	19-21	FA181TT		MXS181	FA181R							4	
250 SE-Factory	19-21	FA181TT		MXS181	FA181R							5	
250 SEF-R	19-21	FA181TT		MXS181	FA181R	MD6429		MD6429C				6	
250 SEF-Factory	19-21	FA181TT		MXS181	FA181R	MD6429		MD6429C				7	
SM 2.5i Supermotard (4T)	08	FA181TT		MXS181	FA181R	N/A						8	
ST 250 (2T/Formula Calipers)	13-14	FA612TT			FA612R	N/A						9	
ST 250 (2T/Braktec Calipers)	14-15	FA303TT				N/A						10	
250 ST Factory	18-19	FA303TT										11	
250 ST-R	18-19	FA303TT										12	
SX 2.5 i F Moto Cross	10	FA181TT		MXS181	FA181R			N/A				13	
ST 290 (2T) Cabestany - Formula Calipers	12	FA612TT			FA612R	N/A						14	
ST 290 (2T/Formula Calipers)	13-14	FA612TT			FA612R	N/A						15	
ST 290 (2T/Braktec Calipers)	14-15	FA303TT				N/A						16	
Trials 2.9 (2T)	99-05	FA115TT		MXS115	FA115R	N/A						17	
Trials 2.9 (2T/AJP Calipers)	06-12	FA303TT				N/A						18	
X-Ride 290	12-15	FA083TT			FA083R			N/A				19	
Enduro SE 3.0i (4T)	10-11	FA181TT		MXS181	FA181R			N/A				20	
300 FST	18-19	FA303TT			FA303R							21	
300 ST-R	18-19	FA303TT			FA303R							22	
300 SC-Factory	19-21	FA181TT		MXS181	FA181R							23	
300 SCF-Factory	19-21	FA181TT		MXS181	FA181R			MD6429C				24	
300 SE-R	19-21	FA181TT		MXS181	FA181R							25	
300 SE-Factory	19-21	FA181TT		MXS181	FA181R							26	
300 SEF-R	19-21	FA181TT		MXS181	FA181R			MD6429C				27	
300 SEF-Factory	19-21	FA181TT		MXS181	FA181R			MD6429C				28	
SE 300 i (2T/Brembo Rear Caliper)	12-15	FA181TT		MXS181	FA181R			N/A				29	
SE-R 300 (2T)	12-15	FA181TT		MXS181	FA181R			N/A				30	
SEF 300 (4T)	13-15	FA181TT		MXS181	FA181R			N/A				31	
SEF-R 300 (4T)	13-15	FA181TT		MXS181	FA181R			N/A				32	
ST 305 (2T/Formula Calipers)	13-15	FA612TT			FA612R	N/A						33	
ST 305 (2T/Braktec Calipers)	14-15	FA303TT				N/A						34	
Trials 3.2cc (4T/AJP Calipers)	05-12	FA303TT				N/A						35	
Enduro 4.5 i (4T) Inc SE Models	04-11	FA181TT		MXS181	FA181R	N/A		N/A				36	
SE 450 i R (Nissin Rear Caliper)	12-13	FA181TT		MXS181	FA181R			N/A				37	
SEF 450 (4T)	14-15	FA181TT		MXS181	FA181R			N/A				38	
SEF-R 450 (4T)	14-15	FA181TT		MXS181	FA181R			N/A				39	
SM 4.5 i F (Supermotard)	04-10	FA181TT		MXS181	FA181R	N/A						40	
SM 4.5 i F (Black Panther)	08-12				FA322/4HH			N/A				41	
450 SCF-Factory	19-21	FA181TT		MXS181	FA181R			MD6429C				42	
450 SE-R	19-21	FA181TT		MXS181	FA181R							43	
450 SEF-Factory	19-21	FA181TT		MXS181	FA181R			MD6429C				44	
500 SCF-Factory	19-21	FA181TT		MXS181	FA181R			MD6429C				45	
500 SEF-R	19-21	FA181TT		MXS181	FA181R			MD6429C				46	
500 SEF-Factory	19-21	FA181TT		MXS181	FA181R			MD6429C				47	
Enduro 5.1 i F Inc SE Models	07-11	FA181TT		MXS181	FA181R			N/A				48	
SE 510 i R (Nissin Rear Caliper)	12-13	FA181TT		MXS181	FA181R			N/A				49	
SM 5.1 i F Supermotard	07	FA181TT		MXS181	FA181R			N/A				50	
SM 5.1 i F Black Panther	08-12				FA322/4HH			N/A				51	
												52	
												53	
SIAMOTO													
Birdie 50	02-04	SFA169	SFAC169		SFA169HH	TBA						54	
Mat 50	97-01	FA083TT			FA083R	TBA						55	
Scross 50	97-01	SFA193			SFA193HH	TBA						56	
Mat 100	97-01	FA083TT				TBA						57	
KD 125	00-04	FA101TT				TBA						58	
Favorite 125	02-04	SFA169	SFAC169		SFA169HH	TBA						59	
SX1 125	04	FA194			FA194HH	N/A						60	

*-2 Sets Required. † For Vee disc colours add RED, BLU, GRN, GLD, ORG suffix to part number.

⊗ - Also available as a Vintage Motorcycle Disc.

Non-JAPANESE Built Motorcycles

Line #	BRAKE DISC CHOICES - FRONT						DISC PAD CHOICES - REAR				BRAKE DISC CHOICES - REAR			
	Oversize 250 /280mm Disc Kit	OSX Oversize 250/280mm Disc Kit	Relocating Bracket for 250/ 280mm Disc	Oversize 320mm Disc Kit	SMX Oversize 320mm Disc Kit	Relocating Bracket for 320mm Disc	FA, SFA, TT Pad or Brake Shoe	SFAC Carbon Scooter Pads	Speciality Pads - SXR / Vee / MXS	Sintered/ HH Pads/ Grooved Shoes	Standard Replacement Disc	Contour Disc Rear fitment	Vee-Discs™ CONTOUR	CX Extreme MX Race Disc/ UTVX Disc
1							FA368TT		MXS368	FA368R		N/A		
2							FA368TT		MXS368	FA368R				
3							FA368TT		MXS368	FA368R		MD6430C		
4							FA368TT		MXS368	FA368R				
5							FA368TT		MXS368	FA368R				
6							FA368TT		MXS368	FA368R		MD6430C		
7							FA368TT		MXS368	FA368R		MD6430C		
8							FA367TT		MXS367	FA367R	N/A			
9							FA351TT				N/A			
10							FA351TT				N/A			
11							FA351TT							
12							FA351TT							
13							FA367TT		MXS367	FA367R		N/A		
14							FA351TT				N/A			
15							FA351TT				N/A			
16							FA351TT				N/A			
17							FA115TT		MXS115	FA115R	N/A			
18							FA351TT				N/A			
19							FA083TT			FA083R		N/A		
20							FA367TT		MXS367	FA367R		N/A		
21							FA351TT			FA351R				
22							FA351TT			FA351R				
23							FA368TT		MXS368	FA368R				
24							FA368TT		MXS368	FA368R		MD6430C		
25							FA368TT		MXS368	FA368R				
26							FA368TT		MXS368	FA368R				
27							FA368TT		MXS368	FA368R		MD6429C		
28							FA368TT		MXS368	FA368R		MD6429C		
29							FA368TT		MXS368	FA368R		N/A		
30							FA368TT		MXS368	FA368R		N/A		
31							FA368TT		MXS368	FA368R		N/A		
32							FA368TT		MXS368	FA368R		N/A		
33							FA351TT				N/A			
34							FA351TT				N/A			
35							FA351TT				N/A			
36							FA367TT		MXS367	FA367R	N/A	N/A		
37							FA367TT		MXS367	FA367R		N/A		
38							FA368TT		MXS368	FA368R		N/A		
39							FA368TT		MXS368	FA368R		N/A		
40							FA367TT		MXS367	FA367R	N/A			
41							FA367TT		MXS367	FA367R		N/A		
42							FA368TT		MXS368	FA368R			MD6430C	
43							FA368TT		MXS368	FA368R				
44							FA368TT		MXS368	FA368R			MD6430C	
45							FA368TT		MXS368	FA368R			MD6430C	
46							FA368TT		MXS368	FA368R			MD6430C	
47							FA368TT		MXS368	FA368R			MD6430C	
48							FA367TT		MXS367	FA367R		N/A		
49							FA367TT		MXS367	FA367R		N/A		
50							FA367TT		MXS367	FA367R		N/A		
51							FA367TT		MXS367	FA367R		N/A		
52														
53														
54							TBA							
55							TBA							
56							TBA							
57							TBA							
58							TBA							
59							TBA							
60							FA115			FA115HH	N/A			

REAR / ARRIÈRE / HINTEN / POSTERIOR / POSTERIORE

R Suffix = High Durability Sintered Pad. HH Suffix = High Performance Sintered Pad. TT Suffix = Hard Wearing Off Road Pad. V Suffix = Semi Sintered Pad. G Suffix = Grooved Shoe.
D Suffix = Drilled Disc. X Suffix = Universal Left or Right Disc. XC Suffix = Contoured Disc. LS Suffix = Left/Steel Disc. RS = Right/Steel Disc.

BRAKE APPLICATIONS

*-2 Sets Required. † For Vee disc colours add RED, BLU, GRN, GLD, ORG suffix to part number.
⊗ - Also available as a Vintage Motorcycle Disc.

Non-JAPANESE Built Motorcycles



SIAMOTO Contd.



DISC PAD CHOICES - FRONT

BRAKE DISC CHOICES - FRONT

		FA, SFA, TT Pad or Brake Shoe	SFAC Carbon Scooter Pads	Speciality Pads - SXR / Vee / MXS	Sintered/HH Pads/ Grooved Shoes	Left / Gauche / Links Standard Replacement Disc	Right / Droite / Rechts Standard Replacement Disc	Contour Disc Universal left and right filament	Universal Custom Disc	Vee-Discs Black † See note below	CX Extreme MX Race Disc/ UTVX Disc	Line #
Geco 250	04	FA106TT		FA106V		N/A						1
SILENCE (Electric)												2
SILENCE Electric S01	21	SFA709*			SFA709HH							3
SILENCE Electric S02	21	SFA709	SFAC709		SFA709HH							4
SILENCE Electric S02 LS	21	SFA709	SFAC709		SFA709HH							5
												6
												7
SINNIS												8
LJ 50 QT-H (Rear Drum Model)	12-14	SFA235	SFAC235			MD923D				VR923		9
LJ 50 QT-H (Rear Disc Model)	12-14	SFA235	SFAC235			MD923D				VR923		10
QM 50 T-10R Eagle 50	10-12	SFA228	SFAC228		SFA228HH		TBA					11
QM 50 QT-2T Falcon	08-14	SFA169	SFAC169		SFA169HH	MD904D				VR904		12
QM 50 QT-6A Jet 50	08-10	SFA169	SFAC169		SFA169HH	MD904D				VR904		13
QM 50 10A (B) Hawk	08-10	SFA228	SFAC228		SFA228HH	MD9131D						14
WY 50 QT-39A Ghost	06-10	SFA235	SFAC235			MD923D				VR923		15
ZN 50 QT-30A Strada 50	12-14	SFA228	SFAC228		SFA228HH	N/A						16
Apache SM 125	15-20	FA135TT			FA135R			MD6357C				17
Apache SMR 125	17-20	FA135TT			FA135R			MD6357C				18
Blade X 125	15-20	FA135TT			FA135R			MD6357C				19
Hoodlum 125 ZS125-79	17-20	FA731TT			FA731R							20
JS 125 - 6C - SC 125	12-14	FA199		FA199V	FA199HH	N/A						21
JS 125 - 6H - ST 125	13-14	FA054TT			FA054HH	N/A						22
QM 125 - GY-2X - Café 125	12-14	FA093						N/A				23
QM 125 T - 8G Ecocity 125	07-14	SFA054	SFAC054		SFA054HH		N/A					24
QM 125 - 2 C Vista 125	08-14	FA093				MD828						25
QM 125 - 2 D Stealth 125	Left 08-14	FA228			FA228HH	N/A	N/A					26
	Right	FA197			FA197HH							27
QM 125 T-Matrix	10	SFA054	SFAC054		SFA054HH		N/A					28
QM 125 T-10H Matrix II	10-14	SFA054	SFAC054		SFA054HH		N/A					29
QM 125 T-10R Eagle 125	10-14	SFA054	SFAC054		SFA054HH		N/A					30
QM 125 - 2 V Max 125	08-10	FA199			FA199HH		MD829					31
QM 125 - 2V2 Max 11 125	12-14	FA093					MD829					32
QM 125 GY Apache 125 (Rear drum model)	09-14	FA135TT			FA135R			N/A				33
QM 125 GY-2B (A) Apache 125 (Rear disc model)	09-14	FA135TT			FA135R			MD6357C				34
QM 125 GY-2B Blade 125	09-14	FA135TT			FA135R			N/A				35
QM 125 GY-2XR Retrostar 125	12-14	FA093						N/A				36
RSX 125 ZS125-80	19-20	SFA709		SFAC709	SFA709HH							37
Shuttle 125 ZN125T-7S	16-21	SFA197		SFAC197								38
Terrain 125 ZS125-86	17-20	FA731TT			FA731R							39
ZN 125 T-22 Harrier 125	12-14	SFA235	SFAC235			N/A						40
ZN 125 T-ES Spirit 125	12-14	FA228			FA228HH	N/A						41
ZN 125 TT-30A Strada 125	12-14	SFA228	SFAC228		SFA228HH	N/A						42
WY 125 T-56A Nitro 125	09-10	SFA086	SFAC086		SFA086HH			MD971C		VR971		43
QM 125 GY-2D Trackstar 125 (4T)	10-14	FA093				N/A						44
QM 250 GY-D Apache 250	13-14	FA135TT			FA135R			N/A				45
												46
												47
SMC												48
YB 125	09	FA086			FA086HH	N/A						49
YB 150	09	FA086			FA086HH	N/A						50
YB 250	09	FA086			FA086HH	N/A						51
												52
STOMP-MINI MOTO												53
125 Elite	07-09	FA448				N/A						54
												55
SUPERBYKE												56
CQ 50 Road Classic		FA375		FA375V	FA375HH		N/A					57
M-Ped 50 Road Classic		SFA169	SFAC169		SFA169HH	MD904D				VR904		58
RFX 50 Road Trail		FA093				N/A						59
CU 125 Road Classic		FA375		FA375V	FA375HH		N/A					60
M-Ped 125 Road Classic		FA086			FA086HH		MD904D			VR904		61

FRONT / AVANT / VORN / FRENTE / ANTERIORE

R Suffix = High Durability Sintered Pad. HH Suffix = High Performance Sintered Pad. TT Suffix = Hard Wearing Off Road Pad. V Suffix = Semi Sintered Pad. G Suffix = Grooved Shoe.
D Suffix = Drilled Disc. X Suffix = Universal Left or Right Disc. XC Suffix = Contoured Disc. LS Suffix = Left/Steel Disc. RS = Right/Steel Disc.

*-2 Sets Required. † For Vee disc colours add RED, BLU, GRN, GLD, ORG suffix to part number.
⊗ - Also available as a Vintage Motorcycle Disc.

Non-JAPANESE Built Motorcycles

Line #	BRAKE DISC CHOICES - FRONT						DISC PAD CHOICES - REAR				BRAKE DISC CHOICES - REAR			
	Oversize 250 /280mm Disc Kit	OSX Oversize 250/280mm Disc Kit	Relocating Bracket for 250/ 280mm Disc	Oversize 320mm Disc Kit	SMX Oversize 320mm Disc Kit	Relocating Bracket for 320mm Disc	FA, SFA, TT Pad or Brake Shoe	SFAC Carbon Scooter Pads	Speciality Pads - SXR / Vee / MXS	Sintered/ HH Pads/ Grooved Shoes	Standard Replacement Disc	Contour Disc Rear fitment	Vee-Discs™ CONTOUR	CX Extreme MX Race Disc/ UTVX Disc
1							S602							
2														
3														
4							SFA197	SFAC197		SFA197HH				
5							SFA197	SFAC197		SFA197HH				
6							SFA197	SFAC197		SFA197HH				
7														
8														
9							H303							
10							SFA054	SFAC054			MD923D	VR923		
11							897							
12							H303							
13							H303							
14							897							
15							H303							
16							H303							
17							FA054TT			FA054R		MD6358C		
18							FA054TT			FA054R		MD6358C		
19							FA054TT			FA054R				
20														
21							Y506							
22							Y506							
23							H310			H310G				
24							SFA266	SFAC266		SFA266HH	MD9132D			
25							Y516							
26							FA140			FA140HH	MD827			
27														
28							Y506							
29							Y506							
30							Y506							
31							Y506							
32							Y506							
33							S602							
34							FA054TT			FA054R		MD6358C		
35							FA054TT			FA054R		N/A		
36							H310			H310G				
37							FA496		FA496V	FA496HH				
38							SFA086							
39							FA496			FA496HH				
40							Y506							
41							TBA							
42							Y506							
43							Y506							
44							H310			H310G				
45							FA165TT			FA165R		N/A		
46														
47														
48							FA086			FA086HH	N/A			
49							FA086			FA086HH	N/A			
50							FA086			FA086HH	N/A			
51														
52														
53							FA480				N/A			
54														
55														
56							FA086			FA086HH	N/A			
57							TBA							
58							TBA							
59							FA086			FA086HH	N/A			
60							FA086			FA086				

REAR / ARRIÈRE / HINTEN / POSTERIOR / POSTERIORE

R Suffix = High Durability Sintered Pad. **HH** Suffix = High Performance Sintered Pad. **TT** Suffix = Hard Wearing Off Road Pad. **V** Suffix = Semi Sintered Pad. **G** Suffix = Grooved Shoe.
D Suffix = Drilled Disc. **X** Suffix = Universal Left or Right Disc. **XC** Suffix = Contoured Disc. **LS** Suffix = Left/Steel Disc. **RS** = Right/Steel Disc.

*-2 Sets Required. † For Vee disc colours add RED, BLU, GRN, GLD, ORG suffix to part number.
 Ⓢ - Also available as a Vintage Motorcycle Disc.

Part numbers, prefixes, suffixes, photos and illustrations shown in this catalogue are trademarks and/or copyrights of EBC Brakes or the trademark owner A C Freeman Investments Ltd and use without express written permission of the owners is punishable by law.

Non-JAPANESE Built Motorcycles



SUPERBYKE Contd.



DISC PAD CHOICES - FRONT

BRAKE DISC CHOICES - FRONT

FA, SFA, TT Pad or Brake Shoe	SFAC Carbon Scooter Pads	Speciality Pads - SXR / Vee / MXS	Sintered/HH Pads/ Grooved Shoes	Left / Gauche / Links Standard Replacement Disc	Right / Droite / Rechts Standard Replacement Disc	Contour Disc Universal left and right fitment	Universal Custom Disc	Vee-Discs Black † See note below	CX Extreme MX Race Disc/ UTVX Disc
RFX 125 Road Trail									
RMR 125									
RMX 125									
R-SR 125 4V									
SB 125-4									
RFX 200									
RMR 200 SM									
R-SR 250									
SVM									
50/80 TR/TL Trial									
50/80 MK/GS/RBS Enduro									
50/80 MK/MC Cross									
125/175/250/347/440 Enduro									
125/250/440 Cross									
125/240/320/350 HM/MW/TL Trial									
125/250 S1/S2									
323 Trial									
323 Trial									
350 XP Sahara									
XN 506 Enduro									
S.W.M.									
MC 125 R									
RS 125 R									
RS 125 R									
SM 125 R									
SM 125 R									
MC 250 S									
FT 300 R (RS 300 R Flat Track)									
RS 300 R (4T)									
RS 340 S									
Ace of Spades 500									
Gran Milano (4T)									
Gran Milano (4T)									
Gran Milano Boggi SE									
Gran Milano Outlaw 500									
Gran Milano Special (4T)									
Gran Turismo 440 (4T)									
Gran Turismo 440 (4T)									
Silver Vase 440 (4T)									
Silver Vase 440 (4T)									
Six Days									
SM 450 R (4T)									
RS 500 R (4T)									
SM 500 R (4T)									
Super Dual T 600									
Super Dual X 600									
MC 650 R									
RS 650 R									
SM 650 R									
Super Dual 650 (4T)									
SYM									
Allo 50 (4T)									
Allo GT 50 (4T)									
Cinderella 50/100									
City Hopper 50									
Crox 50 (4T)									
DD 50 (2T)									

FRONT / AVANT / VORN / FRENTE / ANTERIORE

Line #

R Suffix = High Durability Sintered Pad. HH Suffix = High Performance Sintered Pad. TT Suffix = Hard Wearing Off Road Pad. V Suffix = Semi Sintered Pad. G Suffix = Grooved Shoe.
D Suffix = Drilled Disc. X Suffix = Universal Left or Right Disc. XC Suffix = Contoured Disc. LS Suffix = Left/Steel Disc. RS = Right/Steel Disc.

*-2 Sets Required. † For Vee disc colours add RED, BLU, GRN, GLD, ORG suffix to part number.
⊗ - Also available as a Vintage Motorcycle Disc.

Non-JAPANESE Built Motorcycles

Line #	BRAKE DISC CHOICES - FRONT						DISC PAD CHOICES - REAR				BRAKE DISC CHOICES - REAR			
	Oversize 250 /280mm Disc Kit	OSX Oversize 250/280mm Disc Kit	Relocating Bracket for 250/ 280mm Disc	Oversize 320mm Disc Kit	SMX Oversize 320mm Disc Kit	Relocating Bracket for 320mm Disc	FA, SFA, TT Pad or Brake Shoe	SFAC Carbon Scooter Pads	Speciality Pads - SXR / Vee / MXS	Sintered/ HH Pads/ Grooved Shoes	Standard Replacement Disc	Contour Disc Rear fitment	Vee-Discs™ CONTOUR	CX Extreme MX Race Disc/ UTVX Disc
1							TBA							
2							FA054TT			FA054R	N/A			
3							TBA							
4							TBA							
5							H303							
6							TBA				N/A			
7							TBA							
8							FA086			FA086HH	MD689	MD689C		
9														
10														
11									926G					
12									841G					
13									841G					
14									843G					
15									843G					
16									841G					
17									841G					
18									841G					
19									841G					
20									841G					
21									843G					
22														
23														
24							FA368TT			FA368R				
25							FA213			FA213HH				
26							FA697							
27							FA213			FA213HH				
28							FA697							
29							FA368TT			FA368R				
30							FA368TT	MXS368		FA368R				
31							FA368TT	MXS368		FA368R	N/A			
32							FA368TT			FA368R				
33							FA697			FA697HH				
34							TBA							
35							FA697							
36							FA697							
37							FA697			FA697HH				
38							FA368TT	MXS368		FA368R	N/A			
39							TBA							
40							FA697							
41							TBA							
42							FA697							
43							FA697							
44							FA368TT	MXS368		FA368R	N/A			
45							FA368TT	MXS368		FA368R	N/A			
46							FA368TT			FA368R				
47							FA208TT			FA208R				
48							FA208TT			FA208R				
49							FA602TT			FA602R				
50							FA208TT			FA208R				
51							FA208TT			FA208R				
52							FA208TT	MXS208		FA208R	N/A			
53														
54														
55							820							
56							820							
57							H303							
58							H303							
59							820							
60							H333							

REAR / ARRIÈRE / HINTEN / POSTERIOR / POSTERIORE

R Suffix = High Durability Sintered Pad. **HH** Suffix = High Performance Sintered Pad. **TT** Suffix = Hard Wearing Off Road Pad. **V** Suffix = Semi Sintered Pad. **G** Suffix = Grooved Shoe.
D Suffix = Drilled Disc. **X** Suffix = Universal Left or Right Disc. **XC** Suffix = Contoured Disc. **LS** Suffix = Left/Steel Disc. **RS** = Right/Steel Disc.

*-2 Sets Required. † For Vee disc colours add RED, BLU, GRN, GLD, ORG suffix to part number.
 Ⓢ - Also available as a Vintage Motorcycle Disc.

Non-JAPANESE Built Motorcycles



SYM Contd.



DISC PAD CHOICES - FRONT

BRAKE DISC CHOICES - FRONT

R Suffix = High Durability Sintered Pad. HH Suffix = High Performance Sintered Pad. TT Suffix = Hard Wearing Off Road Pad. V Suffix = Semi Sintered Pad. G Suffix = Grooved Shoe.

D Suffix = Drilled Disc. X Suffix = Universal Left or Right Disc. XC Suffix = Contoured Disc. LS Suffix = Left/Steel Disc. RS = Right/Steel Disc.

FRONT / AVANT / VORN / FRENTE / ANTERIORE

		FA, SFA, TT Pad or Brake Shoe	SFAC Carbon Scooter Pads	Speciality Pads - SXR / Vee / MXS	Sintered/HH Pads/ Grooved Shoes	Left / Gauche / Links Standard Replacement Disc	Right / Droite / Rechts Standard Replacement Disc	Contour Disc Universal left and right fitment	Universal Custom Disc	Vee-Discs Black † See note below	CX Extreme MX Race Disc/ UTVX Disc	Line #
Evie (Electric Scooter)	10	H303										1
E-Woo Electric	11	SFA151	SFAC151			MD933D				VR933		2
Symmetry Electric	11	H303										3
E-Symmetry (Electric)	12-13	SFA151	SFAC151			MD933D						4
E-Virid (Electric)	12-15	H303										5
E-Virid Deluxe (Electric)	12-15	SFA151	SFAC151			MD933D						6
Fiddle 50	99-05	H303										7
Fiddle II 50	08-15	SFA264	SFAC264		SFA264HH	MD923D				VR923		8
Fiddle III 50 (4T)	14-21	SFA264	SFAC264		SFA264HH	MD923D						9
Jet Basix 50	06-09	SFA264	SFAC264		SFA264HH	MD9116D				VR9116		10
Jet 50/Euro X S	99-05	SFA264	SFAC264		SFA264HH	MD9116D				VR9116		11
Jet Euro X 50	06-14	SFA264	SFAC264		SFA264HH	MD9116D				VR9116		12
Jet Evo 50 (2T)	13-15	SFA264	SFAC264		SFA264HH	N/A						13
Jet Sport 50	14-15	SFA264	SFAC264		SFA264HH			N/A				14
Jet Sport 50 S	14-15	SFA264	SFAC264		SFA264HH			N/A				15
Jet Sport X 50 SR	06-15	SFA264	SFAC264		SFA264HH			TBA				16
Jet 4 (50cc/4T)	10-15	SFA264	SFAC264		SFA264HH	TBA						17
Jet 4 Naked (50cc/4T)	13-15	SFA264	SFAC264		SFA264HH	N/A						18
Jet 4 R (50cc/2T)	11-15	SFA264	SFAC264		SFA264HH			MD9137C		VR9137		19
Jungle 50/100	99-02	SFA264	SFAC264		SFA264HH	MD9116D				VR9116		20
Mask 50	00-05	SFA264	SFAC264		SFA264HH	MD9116D				VR9116		21
Mio 50	15-20	SFA151	SFAC151			MD933D				VR933		22
Orbit 50	08-09	SFA257	SFAC257			MD923D				VR923		23
Orbit 11 50 (4T)	12-15	SFA264	SFAC264		SFA264HH	N/A						24
Orbit 11 50 Naked (4T)	12-15	SFA264	SFAC264		SFA264HH	N/A						25
Orbit 11 50 TS (4T)	12-15	SFA264	SFAC264		SFA264HH	N/A						26
Red Devil 50	99-09	SFA264	SFAC264		SFA264HH	MD9116D				VR9116		27
RS 50	04-09	SFA306	SFAC306			N/A						28
Shark 50	99-03	SFA306	SFAC306			N/A						29
Super Fancy 50	96-06	SFA257	SFAC257			MD933D				VR933		30
Symphony 50 (4T/Rear drum model)	09	SFA264	SFAC264		SFA264HH	MD9137D		MD9137C		VR9137		31
Symphony S 50 (4T/Rear disc model)	10-21	SFA264	SFAC264		SFA264HH	MD9137D		MD9137C		VR9137		32
Symphony 50 SR (4T/Rear disc model)	10-15	SFA264	SFAC264		SFA264HH					VR9149		33
Symply 50	07-08	SFA264	SFAC264		SFA264HH	MD923D				VR923		34
Symply 11 50	09-14	SFA264	SFAC264		SFA264HH	MD923D				VR923		35
Tonik 50 (4T)	11-15	SFA151	SFAC151			TBA						36
X'Pro 50	13-15	SFA264	SFAC264		SFA264HH	N/A						37
Jet 100 (G100P-6)	99-00	SFA264	SFAC264		SFA264HH	MD9116D				VR9116		38
Mio 100	05-15	SFA151	SFAC151			MD933D				VR933		39
SR 100 Sunrise	97	SFA131/2			SFA131/2HH	N/A						40
Symba 100	11-12	H303										41
Tonik 110 (4T)	11-13	SFA151	SFAC151			N/A						42
Allo 125 (4T)	11-15	SFA264	SFAC264		SFA264HH	N/A				VR923		43
Attila 125	99-00	SFA264	SFAC264		SFA264HH	MD933D				VR933		44
Cevalo B9A (125cc -4T)	10	FA196			FA196HH		N/A					45
City Com 125	08-13	SFA264	SFAC264		SFA264HH	N/A						46
Com Biz 125	11-15	SFA305	SFAC305		SFA305HH	N/A						47
Crox 125 (4T)	15-21	SFA264	SFAC264		SFA264HH	N/A						48
CT 125	03-04	FA297					N/A					49
Euro MX 125 (HF12-W6 Euro 1) (Rear drum model)	02-07	SFA306	SFAC306			N/A						50
Euro MX 125 (HF12W3-6 Euro 2) (Rear disc model)	06-09	SFA306	SFAC306			N/A						51
Fiddle II 125	08-15	SFA264	SFAC264		SFA264HH	MD923D		MD923C		VR923		52
Fiddle III 125 (4T)	08-21	SFA264	SFAC264		SFA264HH	N/A						53
GTS 125 Joymax/Voyager	06-09	SFA427	SFAC427		SFA427HH	N/A						54
GTS 125 i Joymax (All Models)	10-15	SFA355	SFAC355		SFA355HH	TBA						55
GTS 125 i Sport(All Models)	14-15	SFA355	SFAC355		SFA355HH	TBA						56
HD 125/200	04-07	SFA305	SFAC305		SFA305HH	N/A						57
HD 125 S Evo	07	SFA264	SFAC264		SFA264HH	N/A						58
HD Evo 125 (Carb & EFI Models/4T/Single Headlight)	03-13	SFA264	SFAC264		SFA264HH	TBA						59
HD2-125i (Twin H/Lights/4T)	10-15	SFA264	SFAC264		SFA264HH	N/A						60

*-2 Sets Required. † For Vee disc colours add RED, BLU, GRN, GLD, ORG suffix to part number.

⊗ - Also available as a Vintage Motorcycle Disc.

Non-JAPANESE Built Motorcycles

Line #	BRAKE DISC CHOICES - FRONT						DISC PAD CHOICES - REAR				BRAKE DISC CHOICES - REAR			
	Oversize 250 /280mm Disc Kit	OSX Oversize 250/280mm Disc Kit	Relocating Bracket for 250/ 280mm Disc	Oversize 320mm Disc Kit	SMX Oversize 320mm Disc Kit	Relocating Bracket for 320mm Disc	FA, SFA, TT Pad or Brake Shoe	SFAC Carbon Scooter Pads	Speciality Pads - SXR / Vee / MXS	Sintered/ HH Pads/ Grooved Shoes	Standard Replacement Disc	Contour Disc Rear fitment	Vee-Discs™ CONTOUR	CX Extreme MX Race Disc/ UTVX Disc
1							H303							
2							H303							
3							H303							
4							H303							
5							H303							
6							H303							
7							H302							
8							H303							
9							H303							
10							H303							
11							H303							
12							H303							
13							H303							
14							H303							
15							H303							
16							SFA234				TBA			
17							H303							
18							H303							
19							H303							
20							H303							
21							H303							
22							H303							
23							H303							
24							H303							
25							H303							
26							H303							
27							H303							
28							H303							
29							820							
30							H303							
31							H307							
32							SFA260	SFAC260		SFA260HH	TBA			
33							SFA260	SFAC260		SFA260HH		VR9149		
34							H303							
35							H303							
36							H303							
37							H307							
38							H303							
39							H303							
40														
41							H303							
42							H307							
43							820							
44							H307							
45							TBA							
46							SFA427	SFAC427		SFA427HH	N/A			
47							820							
48							820							
49							819							
50							820							
51							SFA197	SFAC197			TBA			
52							H307							
53							H307							
54							SFA427	SFAC427		SFA427HH	N/A			
55							SFA427	SFAC427		SFA427HH	TBA			
56							SFA427	SFAC427		SFA427HH	TBA			
57							820							
58							820							
59							SFA427	SFAC427		SFA427HH	TBA			
60							SFA427	SFAC427		SFA427HH	TBA			

REAR / ARRIÈRE / HINTEN / POSTERIOR / POSTERIORE

R Suffix = High Durability Sintered Pad. **HH** Suffix = High Performance Sintered Pad. **TT** Suffix = Hard Wearing Off Road Pad. **V** Suffix = Semi Sintered Pad. **G** Suffix = Grooved Shoe.
D Suffix = Drilled Disc. **X** Suffix = Universal Left or Right Disc. **XC** Suffix = Contoured Disc. **LS** Suffix = Left/Steel Disc. **RS** = Right/Steel Disc.

*-2 Sets Required. † For Vee disc colours add RED, BLU, GRN, GLD, ORG suffix to part number.
 Ⓢ - Also available as a Vintage Motorcycle Disc.

Part numbers, prefixes, suffixes, photos and illustrations shown in this catalogue are trademarks and/or copyrights of EBC Brakes or the trademark owner A C Freeman Investments Ltd and use without express written permission of the owners is punishable by law.

Non-JAPANESE Built Motorcycles



SYM Contd.



DISC PAD CHOICES - FRONT

BRAKE DISC CHOICES - FRONT

Line #

		FA, SFA, TT Pad or Brake Shoe	SFAC Carbon Scooter Pads	Speciality Pads - SXR / Vee / MXS	Sintered/HH Pads/ Grooved Shoes	Left / Gauche / Links Standard Replacement Disc	Right / Droite / Rechts Standard Replacement Disc	Contour Disc Universal left and right fitment	Universal Custom Disc	Vee-Discs Black † See note below	CX Extreme MX Race Disc/ UTVX Disc
Huskey 125/150	99-05	FA297				N/A					
JET 4 (125cc/4T)	10-15	SFA264	SFAC264		SFA264HH	MD9137D		MD9137C		VR9137	
JET V (125cc/4T)	12-13	SFA067	SFAC067		SFA067HH			MD9137C		VR9137	
Joyride 125	01-06	SFA306	SFAC306			N/A					
Joyride 125 i	07-09	SFA306	SFAC306			N/A					
Joyride EVO 125 i (Twin Headlights)	09-21	SFA306	SFAC306			N/A					
Megalo 125	00-07	SFA264	SFAC264		SFA264HH	MD933D				VR933	
Orbit 125	08-09	SFA257	SFAC257			TBA					
Orbit 11/Sympley 125 (4T)	09-15	SFA264	SFAC264		SFA264HH	MD923D				VR923	
RS 125	04-06	SFA306	SFAC306			N/A					
SB 125 N - Wolf (Carb Model/Drum Rear Brake)	11-15	FA179			FA179HH		TBA				
SB 125 Ni - Wolf (EFI Model)	11-15	SFA427			SFA427HH		TBA				
Shark 125/150 (Drum rear model)	99-02	SFA306	SFAC306			N/A					
Shark 4VR 125/150 R (Rear disc model)	00-02	SFA306	SFAC306			N/A					
SK 125	03-04	SFA306	SFAC306			N/A					
Super Duke 125/150	99-02	SFA264	SFAC264		SFA264HH	MD933D				VR933	
Symphony 125 (4T/Rear drum)	09	SFA264	SFAC264		SFA264HH	MD9137D		MD9137C		VR9137	
Symphony S 125 (4T/Rear disc model)	10-21	SFA264	SFAC264		SFA264HH	MD9137D		MD9137C		VR9137	
Symphony 125 SR (4T/Rear disc model)	10-15	SFA264	SFAC264		SFA264HH	MD9149D				VR9149	
Symphony 125 ST	17-21	SFA264	SFAC264		SFA264HH	MD9149D				VR9166	
Sympley 125	07-08	SFA264	SFAC264		SFA264HH	MD923D				VR923	
Sympley 11 125	09-14	SFA264	SFAC264		SFA264HH	MD923D				VR923	
Tonik 125 (4T)	11-15	SFA151	SFAC151			TBA					
VS 125	06-15	SFA306	SFAC306			N/A					
Wolf Legend	04-05	FA086			FA086HH		N/A				
Wolf 125/150 Scooter (Type 125M/P125M/P150M)	00	H306									
XS 125 K	07-15	FA197			FA197HH		N/A				
X'Pro 125	13-15	SFA264	SFAC264		SFA264HH	N/A					
Allo 150 (4T)	11-15	SFA264	SFAC264		SFA264HH		N/A				
Crox 150 (4T)	15	SFA264	SFAC264		SFA264HH	N/A					
Jet 4 (150cc/4T)	13-15	SFA264	SFAC264		SFA264HH			N/A			
Joyride 150	01-06	SFA306	SFAC306			N/A					
RS 150	06	SFA306	SFAC306			N/A					
Fiddle II 151	08-15	SFA264	SFAC264		SFA264HH	TBA					
Symphony S 151 (4T/Rear disc model)	10-15	SFA264	SFAC264		SFA264HH	MD9137D		MD9137C		VR9137	
Symphony 151 SR (4T/Rear disc model)	10-15	SFA264	SFAC264		SFA264HH	MD9149D				VR9149	
VS 150	06-15	SFA306	SFAC306			N/A					
Neo VF185		TBA	TBA								
Fiddle III 200i (4T)	14-21	SFA264	SFAC264		SFA264HH	N/A					
H 200 SE	06	SFA264	SFAC264		SFA264HH	TBA					
HD 200 S Evo	07	SFA264	SFAC264		SFA264HH	TBA					
HD Evo 200 (Carb & EFI Models/4T/Single Headlight)	03-13	SFA264	SFAC264		SFA264HH	TBA					
HD 2-200i (Twin H/Lights/4T)	10-15	SFA264	SFAC264		SFA264HH	N/A					
Joyride 200	03-07	SFA306	SFAC306			N/A					
Joyride 200 i	07-09	SFA306	SFAC306			N/A					
Joyride EVO 200 i	09-21	SFA306	SFAC306			N/A					
Symphony 200 ST	18-21	SFA264	SFAC264		SFA264HH						
Trackrunner 200 Quad	05-09	FA377TT*			FA377R*	N/A	N/A				
Quadlander 200	12-13	FA377TT*			FA377R*	N/A	N/A				
GTS 250	07-08	SFA355/4*	SFAC355/4*		SFA355/4HH*	N/A					
GTS 250i/Joymax (All Models)	09-14	SFA355/4*	SFAC355/4*		SFA355/4HH*			N/A			
Joymax 250	06	SFA355/4*	SFAC355/4*		SFA355/4HH*	N/A					
Joymax 250 i	07-08	SFA355/4*	SFAC355/4*		SFA355/4HH*	TBA					
Quadlander 250	05-09	FA377TT*			FA377R*	N/A	N/A				
SB 250 Ni (Wolf SB)	12-15	SFA627			SFA627HH			N/A			
Voyager 250	05	SFA355/4*	SFAC355*		SFA355HH*	N/A					
GTS 300/Joymax (All Models)	08-14	SFA355/4*	SFAC355*		SFA355HH*	N/A					
GTS 300 Sport (All Models)	14-15	SFA355/4*	SFAC355*		SFA355HH*	N/A					
City Com 300 i	08-14	SFA264	SFAC264		SFA264HH	N/A					
City Com S 300 I CBS	15	SFA264	SFAC264		SFA264HH	N/A					

FRONT / AVANT / VORN / FRENTE / ANTERIORE

R Suffix = High Durability Sintered Pad. HH Suffix = High Performance Sintered Pad. TT Suffix = Hard Wearing Off Road Pad. V Suffix = Semi Sintered Pad. G Suffix = Grooved Shoe. D Suffix = Drilled Disc. X Suffix = Universal Left or Right Disc. XC Suffix = Contoured Disc. LS Suffix = Left/Steel Disc. RS = Right/Steel Disc.

*-2 Sets Required. † For Vee disc colours add RED, BLU, GRN, GLD, ORG suffix to part number.

⊗ - Also available as a Vintage Motorcycle Disc.

Non-JAPANESE Built Motorcycles

Line #	BRAKE DISC CHOICES - FRONT						DISC PAD CHOICES - REAR				BRAKE DISC CHOICES - REAR			
	Over-size 250 /280mm Disc Kit	OSX Over-size 250/280mm Disc Kit	Relocating Bracket for 250/ 280mm Disc	Over-size 320mm Disc Kit	SMX Over-size 320mm Disc Kit	Relocating Bracket for 320mm Disc	FA, SFA, TT Pad or Brake Shoe	SFAC Carbon Scooter Pads	Speciality Pads - SXR / Vee / MXS	Sintered/ HH Pads/ Grooved Shoes	Standard Replacement Disc	Contour Disc Rear fitment	Vee- Discs™ CONTOUR	CX Extreme MX Race Disc/ UTVX Disc
1							819							
2							H307							
3							H307							
4							SFA305	SFAC305			N/A			
5							SFA427	SFAC427			TBA			
6							SFA427	SFAC427			TBA			
7							820							
8							820							
9							H303							
10							TBA							
11							TBA							
12							FA377		FA377V	FA377HH	TBA			
13							820							
14							SFA197	SFAC197			N/A			
15							SFA305	SFAC305			N/A			
16							H303							
17							H307							
18							SFA260	SFAC260		SFA260HH	TBA			
19							SFA260	SFAC260		SFA260HH		TBA		
20														
21							H307							
22							H307							
23							820							
24							820							
25							819							
26							H307							
27							H310							
28							H307							
29							820							
30							820							
31							820							
32							SFA305	SFAC305			N/A			
33							SFA228	SFAC228			N/A			
34							H307							
35							SFA260	SFAC260		SFA260HH	TBA			
36							SFA260	SFAC260		SFA260HH		TBA		
37							820							
38							FA377	TBA						
39							SFA264	SFAC264		SFA264HH	N/A			
40							SFA427	SFAC427		SFA427HH	TBA			
41							SFA427	SFAC427		SFA427HH	TBA			
42							SFA427	SFAC427		SFA427HH	TBA			
43							SFA427	SFAC427		SFA427HH	TBA			
44							SFA305	SFAC305			N/A			
45							SFA427	SFAC427			TBA			
46							SFA427	SFAC427			TBA			
47							SFA260		SFAC260					
48							FA427TT			FA427R	N/A			
49							FA427TT			FA427R	N/A			
50							SFA427	SFAC427		SFA427HH	N/A			
51							SFA427	SFAC427		SFA427HH	N/A			
52							SFA427	SFAC427		SFA427HH	N/A			
53							SFA427	SFAC427		SFA427HH	TBA			
54							FA427TT			FA427R	N/A			
55							FA377		FA377V	FA377HH		N/A		
56							SFA319			SFA319HH	N/A			
57							SFA427	SFAC427		SFA427HH	N/A			
58							SFA427	SFAC427		SFA427HH	N/A			
59							SFA264	SFAC264		SFA264HH	N/A			
60							SFA264	SFAC264		SFA264HH	N/A			

REAR / ARRIÈRE / HINTEN / POSTERIOR / POSTERIORE

R Suffix = High Durability Sintered Pad. HH Suffix = High Performance Sintered Pad. TT Suffix = Hard Wearing Off Road Pad. V Suffix = Semi Sintered Pad. G Suffix = Grooved Shoe.
D Suffix = Drilled Disc. X Suffix = Universal Left or Right Disc. XC Suffix = Contoured Disc. LS Suffix = Left/Steel Disc. RS = Right/Steel Disc.

*-2 Sets Required. † For Vee disc colours add RED, BLU, GRN, GLD, ORG suffix to part number.
⊗ - Also available as a Vintage Motorcycle Disc.

Part numbers, prefixes, suffixes, photos and illustrations shown in this catalogue are trademarks and/or copyrights of EBC Brakes or the trademark owner A C Freeman Investments Ltd and use without express written permission of the owners is punishable by law.

Non-JAPANESE Built Motorcycles



SYM Contd.



DISC PAD CHOICES - FRONT

BRAKE DISC CHOICES - FRONT

		FA, SFA, TT Pad or Brake Shoe	SFAC Carbon Scooter Pads	Speciality Pads - SXR / Vee / MXS	Sintered/HH Pads/ Grooved Shoes	Left / Gauche / Links Standard Replacement Disc	Right / Droite / Rechts Standard Replacement Disc	Contour Disc Universal left and right filament	Universal Custom Disc	Vee-Disks Black † See note below	CX Extreme MX Race Disc/ UTVX Disc	Line #
Citymax 300 Quad	06	FA377*			FA377R*	TBA	TBA					1
Cruisym 300 ABS	17-21	SFA355/4	SFAC355/4		SFA355/4HH							2
Joymax Z 300 ABS	17-21	SFA355/4	SFAC355/4		SFA355/4HH							3
Quadlander 300	08-10	FA377TT*			FA377R*	TBA	TBA					4
Quadlander 300 S	07-15	FA377TT*			FA377R*	TBA	TBA					5
Max Sym 400i	11-21	SFA627*			SFA627HH*	TBA	TBA	N/A*				6
GT 500	04	SFA283/4	SFAC283/4		SFA283/4HH	N/A						7
Quadraider 600	06-07	FA054TT*		MXS054	FA054R*	TBA	TBA					8
Quadraider 600	08-15	FA377TT*			FA377R*	N/A	N/A					9
Quadraider 600 LE	10-15	FA377TT*			FA377R*	N/A	N/A					10
Max Sym 600i (ABS)	14-15	SFA627*			SFA627HH*	TBA		N/A*				11
TAISHAN (Project Quads)												
Commuter 50	03-05	S632										12
XT 50	03-04	FA054TT			FA054HH	N/A						13
Sport 50 (Drum front)	03-05	S632				N/A						14
Panther 50 Quad	03-04	FA054TT			FA054HH	N/A						15
Hurricane 125 Quad	04-05	TBA*										16
XT 125 Sport	04-05	FA054TT			FA054HH	N/A						17
Explorer 150 Quad	04-05	TBA*										18
Tornado 200 Quad	04	TBA*										19
TAMORETTI												
Retro 50		SFA086	SFAC086		SFA086HH	MD901D				VR901		20
Retro 125		SFA086	SFAC086		SFA086HH	MD901D				VR901		21
Stealth 125		SFA235	SFAC235			MD901D				VR901		22
TERRAMOTO												
TDX 125 F	07	SFA169	SFAC169		SFA169HH	N/A						23
TDX 125 F Krusha	07	SFA169	SFAC169		SFA169HH	N/A						24
TDX 125 F Street Ripa	07	SFA169	SFAC169		SFA169HH	N/A						25
TGB												
Bullet 2 50 (2T)	11-12	SFA083	SFAC083		SFA083HH			N/A				26
Bull& T 50 RS (2T)	11-12	SFA083	SFAC083		SFA083HH			N/A				27
Bull& T 50 RR (2T)	11-12	SFA083	SFAC083		SFA083HH			N/A				28
City 50cc (2T)	07-08	SFA083	SFAC083		SFA083HH	MD923D				VR923		29
City 50cc (4T)	07-11	SFA083	SFAC083		SFA083HH	MD923D				VR923		30
Delivery 50 Scooter (Up to E/F no 609099)	04-06	SFA264	SFAC264		SFA264HH	MD923D				VR923		31
Delivery/Express 50 (From F/E No 609100)	06-12	SFA083	SFAC083		SFA083HH	MD923D				VR923		32
Akros Tec -50	03-04	SFA264	SFAC264		SFA264HH	MD923D				VR923		33
High Wheel 50	02-03	SFA083	SFAC083		SFA083HH	MD923D				VR923		34
Hornet 50/90 Quad	04-05	H338*			H338G*							35
R50 X Bullet	06-10	SFA093				MD9115D						36
R50 X Bullet	10-14	SFA093						N/A				37
Tapo RS 50 (2T)	10-12	SFA083	SFAC083		SFA083HH			N/A				38
Tapo RR 50 (2T)	10-12	SFA083	SFAC083		SFA083HH			N/A				39
Trigger 50	02-03	SFA083	SFAC083		SFA083HH	MD923D				VR923		40
X Race 50 (2T)	11-12	SFA083	SFAC083		SFA083HH							41
101R (50cc)	04-09	SFA264	SFAC264		SFA264HH	MD923D				VR923		42
Bellavita 125 i (4T)	12-14	SFA264	SFAC264		SFA264HH		N/A					43
Delivery/Express (125cc)	04-14	SFA093				MD9115D						44
X-Motion 125	08-14	SFA484				N/A						45
X-Motion 125 R i	11-12	SFA484				N/A						46
R125 X Bullet	08-09	SFA093				MD9115D						47
R125 X Bullet	10-14	SFA093						N/A				48
202 Classic (50cc)	03-14	SFA083	SFAC083		SFA083HH	MD923D				VR923		49
204 Classic (125cc)	03-04	SFA083	SFAC083		SFA083HH	TBA						50
250 Blade/Congo ATV	06-07	FA067TT*			FA067R*	N/A	N/A					51
X-Motion 250i	08-10	SFA484				N/A						52

FRONT / AVANT / VORN / FRENTE / ANTERIORE

R Suffix = High Durability Sintered Pad. HH Suffix = High Performance Sintered Pad. TT Suffix = Hard Wearing Off Road Pad. V Suffix = Semi Sintered Pad. G Suffix = Grooved Shoe.
D Suffix = Drilled Disc. X Suffix = Universal Left or Right Disc. XG Suffix = Contoured Disc. LS Suffix = Left/Steel Disc. RS = Right/Steel Disc.

*-2 Sets Required. † For Vee disc colours add RED, BLU, GRN, GLD, ORG suffix to part number.

⊗ - Also available as a Vintage Motorcycle Disc.

Non-JAPANESE Built Motorcycles

Line #	BRAKE DISC CHOICES - FRONT						DISC PAD CHOICES - REAR				BRAKE DISC CHOICES - REAR			
	Oversize 250 /280mm Disc Kit	OSX Oversize 250/280mm Disc Kit	Relocating Bracket for 250/ 280mm Disc	Oversize 320mm Disc Kit	SMX Oversize 320mm Disc Kit	Relocating Bracket for 320mm Disc	FA, SFA, TT Pad or Brake Shoe	SFAC Carbon Scooter Pads	Speciality Pads - SXR / Vee / MXS	Sintered/ HH Pads/ Grooved Shoes	Standard Replacement Disc	Contour Disc Rear fitment	Vee-Discs™ CONTOUR	CX Extreme MX Race Disc/ UTVX Disc
1							FA427TT			FA427R	TBA			
2							SFA427	SFAC427		SFA427HH				
3							SFA427	SFAC427		SFA427HH				
4							FA377TT			FA377R	TBA			
5							FA377TT			FA377R	TBA			
6							SFA628			SFA628HH		N/A		
7							SFA305	SFAC305		SFA305HH	N/A			
8							FA377TT			FA377R	TBA			
9							FA377TT			FA377R	N/A			
10							FA377TT			FA377R	N/A			
11							SFA628			SFA628HH		N/A		
12														
13														
14							H303							
15							TBA							
16							H303							
17							TBA							
18							FA165TT			FA165R	N/A			
19							TBA							
20							FA165TT			FA165R	N/A			
21							FA165TT			FA165R	N/A			
22														
23														
24							H303							
25							H303							
26							H307							
27														
28														
29							SFA169	SFAC169		SFA169HH	N/A			
30							SFA169	SFAC169		SFA169HH	N/A			
31							SFA169	SFAC169		SFA169HH	N/A			
32														
33														
34							897							
35							SFA083	SFAC083		SFA083HH		N/A		
36							SFA083	SFAC083		SFA083HH		N/A		
37							897							
38							897							
39							897							
40							897							
41							897							
42							897							
43							FA083TT			FA083R	N/A			
44							SFA083			MD9115D				
45							SFA083				N/A			
46							897							
47							897							
48							897							
49							897							
50							897							
51							SFA298	SFAC298		SFA298HH	N/A			
52							820							
53							SFA427				N/A			
54							SFA427				N/A			
55							SFA083			MD9115D				
56							SFA083				N/A			
57							897							
58							TBA							
59							FA083TT			FA083R	N/A			
60							SFA427				N/A			

REAR / ARRIÈRE / HINTEN / POSTERIOR / POSTERIORE

R Suffix = High Durability Sintered Pad. **HH** Suffix = High Performance Sintered Pad. **TT** Suffix = Hard Wearing Off Road Pad. **V** Suffix = Semi Sintered Pad. **G** Suffix = Grooved Shoe.
D Suffix = Drilled Disc. **X** Suffix = Universal Left or Right Disc. **XC** Suffix = Contoured Disc. **LS** Suffix = Left/Steel Disc. **RS** = Right/Steel Disc.

*-2 Sets Required. † For Vee disc colours add RED, BLU, GRN, GLD, ORG suffix to part number.
 Ⓢ - Also available as a Vintage Motorcycle Disc.

BRAKE APPLICATIONS

Non-JAPANESE Built Motorcycles



TGB



DISC PAD CHOICES - FRONT

BRAKE DISC CHOICES - FRONT

R Suffix = High Durability Sintered Pad. **HH** Suffix = High Performance Sintered Pad. **TT** Suffix = Hard Wearing Off Road Pad. **V** Suffix = Semi Sintered Pad. **G** Suffix = Grooved Shoe.

D Suffix = Drilled Disc. **X** Suffix = Universal Left or Right Disc. **LS** Suffix = Left/Steel Disc. **RS** = Right/Steel Disc.

FRONT / AVANT / VORN / FRENTE / ANTERIORE

		FA, SFA, TT Pad or Brake Shoe	SFAC Carbon Scooter Pads	Speciality Pads - SXR / Vee / MXS	Sintered/HH Pads/ Grooved Shoes	Left / Gauche / Links Standard Replacement Disc	Right / Droite / Rechts Standard Replacement Disc	Contour Disc Universal left and right fitment	Universal Custom Disc	Vee-Discs Black † See note below	CX Extreme MX Race Disc/ UTVX Disc	Line #
302 Sport (50cc)	03-09	SFA093				MD9115D						1
303R Hawk/Laser (50cc)	04-14	SFA083	SFAC083		SFA083HH	MD923D				VR923		2
303R Hawk/Laser (125/150cc)	04-08	SFA093				MD9115D						3
303R Hawk/Laser (125/150cc)	09-14	SFA093						N/A				4
303 Revolution (50/125cc)	02-03	SFA083			SFA083HH	MD923D				VR923		5
304 Sport (125cc)	03-09	SFA093				MD9115D						6
F409 Cruise 50/125	02-05	SFA083	SFAC083		SFA083HH	MD923D				VR923		7
309RS 50	02-03	SFA093				MD923D				VR923		8
Bellavita 300 i (4T)	12-14	SFA264	SFAC264		SFA264HH		N/A					9
X-Motion 300 Efi	10-12	SFA484				N/A						10
Blade 325 Quad (4x2)	07-11	FA083TT*			FA083R*	TBA	TBA					11
Blade 325 LE Quad (4x2)	08-10	FA083TT*			FA083R*	TBA	TBA					12
Blade 325 SL Quad (4x2)	11-12	FA083TT*			FA083R*	TBA	TBA					13
Target 325 (4x2)	09-12	FA083TT*			FA083R*	N/A	N/A					14
Avenger 400 Quad (4x2)	07-09	FA377TT*			FA377R*	TBA	TBA					15
Avenger 400 LE Quad (4x2)	09-10	FA377TT*			FA377R*	TBA	TBA					16
Target 400 (4x2)	09-10	FA083TT*			FA083R*	N/A	N/A					17
404 Executive	03-04	SFA093				TBA						18
Blade (4x4) 425 Quad	07-09	FA377TT*			FA377R*	N/A	N/A					19
Blade SE (4x4) 425 Quad	09-10	FA377TT*			FA377R*	N/A	N/A					20
Target 425 (4X4)	09-11	FA083TT*			FA083R*	N/A	N/A					21
Blade 450 SE (4x4)	10-11	FA377TT*			FA377R*	N/A	N/A					22
Blade 460 R Target	12	FA083TT*			FA083R*	N/A	N/A					23
Blade 460 IRS Target	12	FA083TT*			FA083R*	N/A	N/A					24
Blade 460 SL IRS 4x4	12	FA377TT*			FA377R*	N/A	N/A					25
Avenger 500 R Quad (4x2)	09-10	FA377TT*			FA377R*	TBA	TBA					26
Target 500 (4x2)	09-10	FA083TT*			FA083R*	N/A	N/A					27
Blade 510 LE	11-12	FA377TT*			FA377R*	N/A	N/A					28
Blade 525 SE 4x4	09-10	FA377TT*			FA377R*	N/A	N/A					29
Blade 525 SL 4x4	09-10	FA377TT*			FA377R*	N/A	N/A					30
525 SE 4x4	09	FA377TT*			FA377R*	N/A	N/A					31
Target 525 (4x4)	09-11	FA083TT*			FA083R*	N/A	N/A					32
Blade 550 LT 4x4	10-11	FA377TT*			FA377R*	N/A	N/A					33
Blade 550 SE 4x4	09-11	FA377TT*			FA377R*	N/A	N/A					34
Blade 550 SL 4x4	09-10	FA377TT*			FA377R*	N/A	N/A					35
Gunner 550 4x4 Target	10-12	FA377TT*			FA377R*	N/A	N/A					36
Blade 550 IRS Target	11-12	FA377TT*			FA377R*	N/A	N/A					37
550 IRS Blade LT	10-12	FA377TT*			FA377R*	N/A	N/A					38
												39
												40
THUMPSTAR												
Thumpstar Junior 90cc	04-06	SFA169	SFAC169		SFA169HH	N/A						41
Thumpstar Supa 110cc	04-06	SFA169	SFAC169		SFA169HH	N/A						42
Thumpstar Expert 125	06	SFA169	SFAC169		SFA169HH	N/A						43
Thumpstar Pro 125	05-06	SFA169	SFAC169		SFA169HH	N/A						44
Thumpstar 125 Road Ripper	06	SFA169	SFAC169		SFA169HH	N/A						45
												46
												47
T.M.												
Junior 80/85/100 Cross (Small wheel)	02-04	FA181TT		MXS181	FA181R	N/A						48
Junior 80/85/100	05-07	FA181TT		MXS181	FA181R	N/A						49
80/85/100 (Big wheel)	02-04	FA181TT		MXS181	FA181R	N/A						50
80 Enduro	96-00	FA181TT		MXS181	FA181R	N/A						51
80/85 Minicross/Junior	96-00	FA083TT			FA083R	N/A						52
80/85 Cross	96-01	FA181TT		MXS181	FA181R	N/A						53
MX 85 JR (Small Wheel)	02-04	FA181TT		MXS181	FA181R			MD6349C				54
MX 85 JR (Small Wheel)	05-09	FA181TT		MXS181	FA181R			MD6349C				55
MX 85 JR (Small Wheel)	10-21	FA367TT		MXS367	FA367R			N/A				56
MX 85 (Big Wheel)	02-04	FA181TT		MXS181	FA181R			MD6349C				57
MX 85 (Big Wheel)	05-09	FA181TT		MXS181	FA181R			MD6349C				58
MX 85 (Big Wheel)	10-21	FA367TT		MXS367	FA367R			N/A				59
SMX 85 2S	10-21			MXS367	FA367R							60

*-2 Sets Required. † For Vee disc colours add RED, BLU, GRN, GLD, ORG suffix to part number.

⊗ - Also available as a Vintage Motorcycle Disc.

Non-JAPANESE Built Motorcycles

Line #	BRAKE DISC CHOICES - FRONT						DISC PAD CHOICES - REAR				BRAKE DISC CHOICES - REAR			
	Oversize 250 /280mm Disc Kit	OSX Oversize 250/280mm Disc Kit	Relocating Bracket for 250/ 280mm Disc	Oversize 320mm Disc Kit	SMX Oversize 320mm Disc Kit	Relocating Bracket for 320mm Disc	FA, SFA, TT Pad or Brake Shoe	SFAC Carbon Scooter Pads	Speciality Pads - SXR / Vee / MXS	Sintered/ HH Pads/ Grooved Shoes	Standard Replacement Disc	Contour Disc Rear fitment	Vee-Discs™ CONTOUR	CX Extreme MX Race Disc/ UTVX Disc
1							897							
2							897							
3							820							
4							820							
5							897							
6							897							
7							897							
8							897							
9							SFA298	SFAC298		SFA298HH	N/A			
10							SFA427				N/A			
11							FA067TT			FA067R	TBA			
12							FA067TT			FA067R	TBA			
13							FA067TT			FA067R	TBA			
14							FA067TT			FA067R	N/A			
15							FA377TT*			FA377R*	TBA*			
16							FA377TT*			FA377R*	TBA*			
17							FA067TT			FA067R	N/A			
18							TBA							
19							FA377TT*			FA377R*	N/A*			
20							FA377TT*			FA377R*	N/A*			
21							FA067TT			FA067R	N/A			
22							FA067TT			FA067R	N/A			
23							FA067TT			FA067R	N/A			
24							FA067TT			FA067R	N/A			
25							FA067TT			FA067R	N/A			
26							FA377TT*			FA377R*	TBA*			
27							FA067TT			FA067R	N/A			
28							FA067TT			FA067R	N/A			
29							FA377TT*			FA377R*	N/A*			
30							FA067TT			FA067R	N/A			
31							FA067TT			FA067R	N/A			
32							FA067TT			FA067R	N/A			
33							FA067TT			FA067R	N/A			
34							FA067TT			FA067R	N/A			
35							FA067TT			FA067R	N/A			
36							FA377TT*			FA377R*	N/A*			
37							FA067TT			FA067R	N/A			
38							FA067TT			FA067R	N/A			
39														
40														
41							SFA169	SFAC169		SFA169HH	N/A			
42							SFA169	SFAC169		SFA169HH	N/A			
43							SFA169	SFAC169		SFA169HH	N/A			
44							SFA169	SFAC169		SFA169HH	N/A			
45							SFA169	SFAC169		SFA169HH	N/A			
46														
47														
48							FA208TT		MXS208	FA208R	N/A			
49							FA367TT		MXS367	FA367R	N/A			
50							FA208TT		MXS208	FA208R	N/A			
51							FA208TT		MXS208	FA208R	N/A			
52							FA084/3TT		MXS084/3	FA084/3R	N/A			
53							FA208TT		MXS208	FA208R	N/A			
54							FA131TT		MXS131	FA131R		MD6350C		
55							FA367TT		MXS367	FA367R		MD6350C		
56							FA367TT		MXS367	FA367R		N/A		
57							FA131TT		MXS131	FA131R		MD6350C		
58							FA367TT		MXS367	FA367R		MD6350C		
59							FA367TT		MXS367	FA367R		N/A		
60							FA367TT		MXS367	FA367R				

REAR / ARRIÈRE / HINTEN / POSTERIOR / POSTERIORE

R Suffix = High Durability Sintered Pad. HH Suffix = High Performance Sintered Pad. TT Suffix = Hard Wearing Off Road Pad. V Suffix = Semi Sintered Pad. G Suffix = Grooved Shoe.
D Suffix = Drilled Disc. X Suffix = Universal Left or Right Disc. XC Suffix = Contoured Disc. LS Suffix = Left/Steel Disc. RS = Right/Steel Disc.

*-2 Sets Required. † For Vee disc colours add RED, BLU, GRN, GLD, ORG suffix to part number.
⊗ - Also available as a Vintage Motorcycle Disc.

Part numbers, prefixes, suffixes, photos and illustrations shown in this catalogue are trademarks and/or copyrights of EBC Brakes or the trademark owner A C Freeman Investments Ltd and use without express written permission of the owners is punishable by law.

Non-JAPANESE Built Motorcycles



T.M. Contd.



DISC PAD CHOICES - FRONT

BRAKE DISC CHOICES - FRONT

FA, SFA, TT Pad or Brake Shoe	SFAC Carbon Scooter Pads	Speciality Pads - SXR / Vee / MXS	Sintered/HH Pads/ Grooved Shoes	Left / Gauche / Links Standard Replacement Disc	Right / Droite / Rechts Standard Replacement Disc	Contour Disc Universal left and right fitment	Universal Custom Disc	Vee-Discs Black † See note below	CX Extreme MX Race Disc/ UTVX Disc
MX 100 JNR (Small Wheel)	19-21	FA367TT	MXS367	FA367R					
MX 100 JNR (Big Wheel)	19-21	FA367TT	MXS367	FA367R					
125 Cross	95-00	FA181TT	MXS181	FA181R	N/A				
MX 125 (2T)	01-04	FA181TT	MXS181	FA181R		MD6349C			
MX 125 (2T)	05-09	FA181TT	MXS181	FA181R		MD6349C			
MX 125 (2T) 270mm O/D Front Disc	10-21	FA181TT	MXS181	FA181R		N/A			MD6437CX
125 Enduro	95-00	FA181TT	MXS181	FA181R	N/A				
Enduro EN 125 (2T)	01-04	FA181TT	MXS181	FA181R		MD6349C			
Enduro EN 125 (2T)	05-09	FA181TT	MXS181	FA181R		MD6349C			
Enduro EN 125 (2T) 270mm O/D Front disc	10-21	FA181TT	MXS181	FA181R		N/A			MD6437CX
SMM 125 Black Dream (Rim brake)	04-07	N/A			N/A				
SMM 125 (2T) Black Dream (320mm front disc)	08-15			FA322/4HH	N/A				
SMR 125 (2T)	05-14	FA095		FA095HH	N/A				
SMR 125 (2T)	15			FA322/4HH		N/A			
SMR 125 (2T) Tsi 306mm O/D F/disc	19-21			FA447HH		N/A			
SMX 125 (2T)	15			FA322/4HH		N/A			
EN 144 (2T)	08-09	FA181TT	MXS181	FA181R		MD6349C			
EN 144 (2T)	10-21	FA181TT	MXS181	FA181R		N/A			MD6437CX
MX 144 (2T)	08-09	FA181TT	MXS181	FA181R		MD6349C			
MX 144 (2T)	10-21	FA181TT	MXS181	FA181R		N/A			MD6437CX
250 Enduro	95-00	FA181TT	MXS181	FA181R	N/A				
EN 250 F (4T) Enduro	04	FA181TT	MXS181	FA181R		MD6349C			
EN 250 F (4T) Enduro	05-09	FA181TT	MXS181	FA181R		MD6349C			
EN 250 F (4T) Enduro	10-21	FA181TT	MXS181	FA181R		N/A			MD6437CX
Enduro EN 250 (2T)	01-04	FA181TT	MXS181	FA181R		MD6349C			
Enduro EN 250 (2T)	05-09	FA181TT	MXS181	FA181R		MD6349C			
Enduro EN 250 (2T) Tsi	10-21	FA181TT	MXS181	FA181R		N/A			MD6437CX
SME 250 (4T)	04	FA095	MXS181	FA095HH	N/A				
250 Cross	95-00	FA181TT	MXS181	FA181R	N/A				
MX 250 (2T)	01-04	FA181TT	MXS181	FA181R		MD6349C			
MX 250 (2T)	05-09	FA181TT	MXS181	FA181R		MD6349C			
MX 250 (2T) 270mm O/D Front disc	10-21	FA181TT	MXS181	FA181R		N/A			MD6437CX
MX 250 (4T) Cross	02-04	FA181TT	MXS181	FA181R		MD6349C			
MX 250 (4T) Cross	05-09	FA181TT	MXS181	FA181R		MD6349C			
MX 250 Fi (4T)	10-15	FA181TT	MXS181	FA181R		N/A			MD6437CX
SM 250	02	FA095		FA095HH	N/A				
SMM 250 (2T)	05-14	FA095		FA095HH	N/A				
SMM 250 (2T)	15			FA322/4HH		N/A			
SMM 250 F (4T)	10-15			FA322/4HH	N/A				
SMR 250 (2T)	05-14	FA095		FA095HH	N/A				
SMR 250 (2T)	15			FA322/4HH		N/A			
SMR 250 F (4T)	10-15			FA322/4HH	N/A				
SMX 250 (2T)	15			FA322/4HH		N/A			
SMX 250 F (4T)	12-15			FA322/4HH	N/A				
300 Enduro (2T)	95-00	FA181TT	MXS181	FA181R	N/A				
Enduro EN 300 (2T)	01-04	FA181TT	MXS181	FA181R		MD6349C			
Enduro EN 300 (2T)	05-09	FA181TT	MXS181	FA181R		MD6349C			
Enduro EN 300 (2T) 270mm O/D F/disc	10-21	FA181TT	MXS181	FA181R		N/A			MD6437CX
EN 300 (4T)	10-21	FA181TT	MXS181	FA181R					MD6437CX
FT 300 (2T)	19-21	FA181TT	MXS181	FA181R					
300 Cross	95-00	FA181TT	MXS181	FA181R	N/A				
MX 300 (2T)	01-04	FA181TT	MXS181	FA181R		MD6349C			
MX 300 (2T)	05-09	FA181TT	MXS181	FA181R		MD6349C			
MX 300 (2T)	10-21	FA181TT	MXS181	FA181R		N/A			MD6437CX
MX 300 (4T)	10-21	FA181TT	MXS181	FA181R					MD6437CX
SMM 300 (2T)	05-14	FA095		FA095HH	N/A				
SMM 300 (2T)	15			FA322/4HH		N/A			
SMR 300 (2T)	05-14	FA095		FA095HH	N/A				
SMR 300 (2T)	15			FA322/4HH		N/A			
SMR 300 (2T) Tsi	19-21			FA447HH		N/A			

Line #
1
2
3
4
5
6
7
8
9
10
11
12
13
14
15
16
17
18
19
20
21
22
23
24
25
26
27
28
29
30
31
32
33
34
35
36
37
38
39
40
41
42
43
44
45
46
47
48
49
50
51
52
53
54
55
56
57
58
59
60

FRONT / AVANT / VORN / FRENTE / ANTERIORE

R Suffix = High Durability Sintered Pad. HH Suffix = High Performance Sintered Pad. TT Suffix = Hard Wearing Off Road Pad. V Suffix = Semi Sintered Pad. G Suffix = Grooved Shoe.
D Suffix = Drilled Disc. X Suffix = Universal Left or Right Disc. XC Suffix = Contoured Disc. LS Suffix = Left/Steel Disc. RS = Right/Steel Disc.

*-2 Sets Required. † For Vee disc colours add RED, BLU, GRN, GLD, ORG suffix to part number.

⊗ - Also available as a Vintage Motorcycle Disc.

Non-JAPANESE Built Motorcycles

Line #	BRAKE DISC CHOICES - FRONT						DISC PAD CHOICES - REAR				BRAKE DISC CHOICES - REAR			
	Oversize 250 /280mm Disc Kit	OSX Oversize 250/280mm Disc Kit	Relocating Bracket for 250/ 280mm Disc	Oversize 320mm Disc Kit	SMX Oversize 320mm Disc Kit	Relocating Bracket for 320mm Disc	FA, SFA, TT Pad or Brake Shoe	SFAC Carbon Scooter Pads	Speciality Pads - SXR / Vee / MXS	Sintered/ HH Pads/ Grooved Shoes	Standard Replacement Disc	Contour Disc Rear fitment	Vee-Discs™ CONTOUR	CX Extreme MX Race Disc/ UTVX Disc
1							FA367TT		MXS367	FA367R				
2							FA367TT		MXS367	FA367R				
3							FA208TT		MXS208	FA208R	N/A			
4							FA131TT		MXS131	FA131R		MD6350C		
5							FA367TT		MXS367	FA367R		MD6350C		
6							FA367TT		MXS367	FA367R		N/A		MD6436CX
7							FA208TT		MXS208	FA208R	N/A			
8							FA131TT		MXS131	FA131R		MD6350C		
9							FA367TT		MXS367	FA367R		MD6350C		
10							FA367TT		MXS367	FA367R		N/A		MD6436CX
11							FA047			FA047HH	N/A			
12							FA047			FA047HH	N/A			
13							FA367TT		MXS367	FA367R	N/A			
14							FA367TT		MXS367	FA367R		N/A		
15							FA367TT		MXS367	FA367R		N/A		
16							FA367TT		MXS367	FA367R		N/A		
17							FA367TT		MXS367	FA367R		MD6350C		
18							FA367TT		MXS367	FA367R		N/A		MD6436CX
19							FA367TT		MXS367	FA367R		MD6350C		
20							FA367TT		MXS367	FA367R		N/A		MD6436CX
21							FA208TT		MXS208	FA208R	N/A			
22							FA131TT		MXS131	FA131R		MD6350C		
23							FA367TT		MXS367	FA367R		MD6350C		
24							FA367TT		MXS367	FA367R		N/A		MD6436CX
25							FA131TT		MXS131	FA131R		MD6350C		
26							FA367TT		MXS367	FA367R		MD6350C		
27							FA367TT		MXS367	FA367R		N/A		MD6436CX
28							FA131TT		MXS131	FA131R	N/A			
29							FA208TT		MXS208	FA208R	N/A			
30							FA131TT		MXS131	FA131R		MD6350C		
31							FA367TT		MXS367	FA367R		MD6350C		
32							FA367TT		MXS367	FA367R		N/A		MD6436CX
33							FA131TT		MXS131	FA131R		MD6350C		
34							FA367TT		MXS367	FA367R		MD6350C		
35							FA367TT		MXS367	FA367R		N/A		MD6436CX
36							FA131TT		MXS131	FA131R	N/A			
37							FA047			FA047HH	N/A			
38							FA047			FA047HH		N/A		
39							FA367TT		MXS367	FA367R	N/A			
40							FA367TT		MXS367	FA367R	N/A			
41							FA367TT		MXS367	FA367R	N/A			
42							FA367TT		MXS367	FA367R	N/A			
43							FA367TT		MXS367	FA367R		N/A		
44							FA367TT		MXS367	FA367R	N/A			
45							FA208TT		MXS208	FA208R	N/A			
46							FA131TT		MXS131	FA131R		MD6350C		
47							FA367TT		MXS367	FA367R		MD6350C		
48							FA367TT		MXS367	FA367R		N/A		MD6436CX
49														
50							FA367TT		MXS367	FA367R				MD6436CX
51							FA208TT		MXS208	FA208R	N/A			
52							FA131TT		MXS131	FA131R		MD6350C		
53							FA367TT		MXS367	FA367R		MD6350C		
54							FA367TT		MXS367	FA367R		N/A		MD6436CX
55							FA367TT		MXS367	FA367R				MD6436CX
56							FA047			FA047HH	N/A			
57							FA047			FA047HH		N/A		
58							FA367TT		MXS367	FA367R	N/A			
59							FA367TT		MXS367	FA367R		N/A		
60							FA367TT		MXS367	FA367R		N/A		

REAR / ARRIÈRE / HINTEN / POSTERIOR / POSTERIORE

R Suffix = High Durability Sintered Pad. HH Suffix = High Performance Sintered Pad. TT Suffix = Hard Wearing Off Road Pad. V Suffix = Semi Sintered Pad. G Suffix = Grooved Shoe.
D Suffix = Drilled Disc. X Suffix = Universal Left or Right Disc. XC Suffix = Contoured Disc. LS Suffix = Left/Steel Disc. RS = Right/Steel Disc.

BRAKE APPLICATIONS

*-2 Sets Required. † For Vee disc colours add RED, BLU, GRN, GLD, ORG suffix to part number.
⊗ - Also available as a Vintage Motorcycle Disc.

Non-JAPANESE Built Motorcycles



T.M. Contd.



DISC PAD CHOICES - FRONT

BRAKE DISC CHOICES - FRONT

FA, SFA, TT Pad or Brake Shoe	SFAC Carbon Scooter Pads	Speciality Pads - SXR / Vee / MXS	Sintered/HH Pads/ Grooved Shoes	Left / Gauche / Links Standard Replacement Disc	Right / Droite / Rechts Standard Replacement Disc	Contour Disc Universal left and right fitment	Universal Custom Disc	Vee-Discs Black † See note below	CX Extreme MX Race Disc/ UTVX Disc
SMX 300 (2T) 15			FA322/4HH						
SMX 300 (2T) 2S ES 19-21			FA447HH						
400 (4T) MX Cross 02-03	FA181TT	MXS181	FA181R	N/A					
400 Cross (4T) 95-00	FA181TT	MXS181	FA181R	N/A					
SME 400 (4T) 04	FA095		FA095HH	N/A					
SMM 400 (4T) (Rim brake) 04	N/A			N/A					
SM 400 02-03	FA095		FA095HH	N/A					
EN 450 F (4T) 04	FA181TT	MXS181	FA181R			MD6349C			
EN 450 Fi (4T) 05-09	FA181TT	MXS181	FA181R			MD6349C			
EN 450 Fi (4T) 10-21	FA181TT	MXS181	FA181R			N/A			MD6437CX
FT 450 Fi ES (4T) 20-21	FA181TT	MXS181	FA181R						MD6437CX
MX 450 F (4T) 04	FA181TT	MXS181	FA181R			MD6349C			
MX 450 Fi (4T) 05-09	FA181TT	MXS181	FA181R			MD6349C			
MX 450 Fi ES (4T) 10-21	FA181TT	MXS181	FA181R			N/A			MD6437CX
SMM 450 F Black Dream ES (320mm front disc) 08-10			FA322/4HH	N/A					
SMM 450 F 11-15			FA322/4HH	N/A					
SMR 450 F ES 05-09	FA095		FA095HH	N/A					
SMR 450 Fi ES (4T) 10-21			FA447HH	N/A					
SMX 450 Fi 05-15			FA322/4HH	N/A					
530 Cross (4T) 98-00	FA181TT	MXS181	FA181R	N/A					
EN 530 F (4T) 04	FA181TT	MXS181	FA181R			MD6349C			
EN 530 F (4T) 05-09	FA181TT	MXS181	FA181R			MD6349C			
EN 530 F (4T) 10-21	FA181TT	MXS181	FA181R			N/A			MD6437CX
FT 530 Fi ES (4T) 19-21	FA181TT	MXS181	FA181R						
530 (4T) Cross 02-03	FA095		FA095HH	N/A					
MX 530 F 05-09	FA181TT	MXS181	FA181R			MD6349C			
MX 530 F 10-15	FA181TT	MXS181	FA181R			N/A			
SMM 530 F Black Dream (Rim brake) 04-07	N/A			N/A					
SM 530 02-03	FA095		FA095HH	N/A					
SME 530 (4T) 04	FA095		FA095HH	N/A					
SMM 530 F Black Dream ES (320mm front disc) 08-10			FA322/4HH	N/A					
SMR 530 F ES 05-09	FA095		FA095HH	N/A					
SMR 530 Fi ES 10-15			FA322/4HH	N/A					
SMR 530 Fi ES (4T) 19-21			FA447HH	N/A					MD6437CX
SMX 530 F 05-14			FA322/4HH	N/A					
SMX 660 F 04	FA095		FA095HH	N/A					
SMX 660 F 05-10			FA322/4HH	N/A					
FRONT / AVANT / VORN / FRENTE / ANTERIORE									
TOMOS									
Moped with spoke wheels	908								
Moped with cast wheels	931		931G						
Alpino 45 (Drum Brakes)	909								
Alpino 45 (Front Disc Brake)	SFA115	SFAC115	SFA115HH	N/A					
APN 6	SFA115	SFAC115	SFA115HH	N/A					
Classic XL	909								
Flexer EX 25	909								
Flexer XL	909								
Funsport R 25	909								
Funtastic 25	SFA115	SFAC115	SFA115HH	N/A					
Hip Hop	SFA115	SFAC115	SFA115HH	N/A					
Luxe	909								
Luxe EX 25	909								
Revival TS 03-04	SFA116			N/A					
Revival TS	SFA115	SFAC115	SFA115HH	N/A					
Standard	909								
Standard XL	909								
Streetmate	SFA116			N/A					
Streetmate R	SFA116			N/A					
Twister 50	SFA264	SFAC264	SFA264HH	N/A					
MC 50 Senior 05-07	FA325TT		FA325R	N/A					

Line #
1
2
3
4
5
6
7
8
9
10
11
12
13
14
15
16
17
18
19
20
21
22
23
24
25
26
27
28
29
30
31
32
33
34
35
36
37
38
39
40
41
42
43
44
45
46
47
48
49
50
51
52
53
54
55
56
57
58
59
60

R Suffix = High Durability Sintered Pad. **HH** Suffix = High Performance Sintered Pad. **TT** Suffix = Hard Wearing Off Road Pad. **V** Suffix = Semi Sintered Pad. **G** Suffix = Grooved Shoe.
D Suffix = Drilled Disc. **X** Suffix = Universal Left or Right Disc. **XC** Suffix = Contoured Disc. **LS** Suffix = Left/Steel Disc. **RS** = Right/Steel Disc.

*-2 Sets Required. † For Vee disc colours add RED, BLU, GRN, GLD, ORG suffix to part number.

⊗ - Also available as a Vintage Motorcycle Disc.

Non-JAPANESE Built Motorcycles

Line #	BRAKE DISC CHOICES - FRONT						DISC PAD CHOICES - REAR				BRAKE DISC CHOICES - REAR			
	OverSize 250 /280mm Disc Kit	OSX OverSize 250/280mm Disc Kit	Relocating Bracket for 250/ 280mm Disc	OverSize 320mm Disc Kit	SMX OverSize 320mm Disc Kit	Relocating Bracket for 320mm Disc	FA, SFA, TT Pad or Brake Shoe	SFAC Carbon Scooter Pads	Speciality Pads - SXR / Vee / MXS	Sintered/ HH Pads/ Grooved Shoes	Standard Replacement Disc	Contour Disc Rear fitment	Vee-Discs™ CONTOUR	CX Extreme MX Race Disc/ UTVX Disc
1							FA367TT		MXS367	FA367R				
2							FA367TT		MXS367	FA367R				
3							FA131TT		MXS131	FA131R	N/A			
4							FA208TT		MXS208	FA208R	N/A			
5							FA131TT		MXS131	FA131R	N/A			
6							FA047			FA047HH	N/A			
7							FA131TT		MXS131	FA131R	N/A			
8							FA131TT		MXS131	FA131R		MD6350C		
9							FA367TT		MXS367	FA367R		MD6350C		
10							FA367TT		MXS367	FA367R		N/A		
11							FA367TT		MXS367	FA367R				MD6436CX
12							FA131TT		MXS131	FA131R		MD6350C		
13							FA367TT		MXS367	FA367R		MD6350C		
14							FA367TT		MXS367	FA367R		N/A		MD6436CX
15							FA047			FA047HH	N/A			
16							FA047			FA047HH	N/A			
17							FA367TT		MXS367	FA367R	N/A			
18							FA367TT		MXS367	FA367R	N/A			
19							FA367TT		MXS367	FA367R	N/A			
20							FA208TT		MXS208	FA208R	N/A			
21							FA131TT		MXS131	FA131R		MD6350C		
22							FA367TT		MXS367	FA367R		MD6350C		
23							FA367TT		MXS367	FA367R		N/A		MD6436CX
24							FA367TT		MXS367	FA367R				MD6436CX
25							FA131TT		MXS131	FA131R	N/A			
26							FA367TT		MXS367	FA367R		MD6350C		
27							FA367TT		MXS367	FA367R		N/A		
28							FA047			FA047HH	N/A			
29							FA131TT		MXS131	FA131R	N/A			
30							FA131TT		MXS131	FA131R	N/A			
31							FA047			FA047HH	N/A			
32							FA367TT		MXS367	FA367R	N/A	N/A		
33							FA367TT		MXS367	FA367R		N/A		
34							FA367TT		MXS367	FA367R		N/A		MD6436CX
35							FA367TT		MXS367	FA367R	N/A			
36							FA131TT		MXS131	FA131R	N/A			
37							FA367TT		MXS367	FA367R	N/A			
38														
39														
40							908							
41							931		931G					
42							909							
43							909							
44							909							
45							909							
46							909							
47							909							
48							909							
49							909							
50							909							
51							909							
52							909							
53							TBA							
54							909							
55							909							
56							909							
57							TBA							
58							909							
59							H307							
60							FA325TT			FA325R	N/A			

REAR / ARRIÈRE / HINTEN / POSTERIOR / POSTERIORE

R Suffix = High Durability Sintered Pad. **HH** Suffix = High Performance Sintered Pad. **TT** Suffix = Hard Wearing Off Road Pad. **V** Suffix = Semi Sintered Pad. **G** Suffix = Grooved Shoe.
D Suffix = Drilled Disc. **X** Suffix = Universal Left or Right Disc. **XC** Suffix = Contoured Disc. **LS** Suffix = Left/Steel Disc. **RS** = Right/Steel Disc.

BRAKE APPLICATIONS

*-2 Sets Required. † For Vee disc colours add RED, BLU, GRN, GLD, ORG suffix to part number.
 Ⓢ - Also available as a Vintage Motorcycle Disc.

Non-JAPANESE Built Motorcycles



TOMOS Contd.



MC 50 Senior Pro	05-07
Pack'R EX	
Quadro	
Quadro EX	
Racing	
Youngst'R 50	
MC 80	05-07
SE 125 F	05-08
SM 125 F	05-08
Twister 125	

TRIUMPH (MERIDEN PRODUCED MACHINES)

Cub 500	
T120 (650cc/Twin Leading Shoe)	66-70
T140 V Bonneville (Drum rear brake/5 Speed G/Box)	73-74
T140 V Bonneville (Discs all round/5 Speed G/Box)	75-78
T140 Silver Jubilee Bonneville	77
T140 E Bonneville	78-83
T140 D Bonneville (Lester Alloy Wheels/6 Bolt Disc)	79-81
T140 ES (Electric Start)	80-81
T140 E/ES (Executive/Morris Alloy Wheels/5 Bolt Disc)	81-83
TSS 750 (8 Valve)	83
TSX 750 (8 Valve)	83
T140 Bonneville (L.F. Harris Production Bike /Brembo Calipers)	85-88

TRIUMPH (HINCKLEY PRODUCED MACHINES)

Adventurer	96-01
Adventurer - Floating Disc Conversion Option	96-01
America (6 Spoke Cast Wheel)	07-09
America (6 Spoke Cast Wheel) - Floating Disc Conversion Option	07-09
America (12 Spoke Cast Wheel-865cc)	10-17
America (12 Spoke Cast Wheel-865cc) - Floating Disc Conversion Option	10-17
America LT (12 Spoke Cast Wheel-865cc)	14-17
America LT (12 Spoke Cast Wheel-865cc) - Floating Disc Conversion Option	14-16
Bonneville America (Spoke wheel)	02-06
Bonneville America (Spoke wheel) - Floating Disc Conversion Option	02-06
Bonneville 800 (790cc)	01-06
Bonneville 800 (790cc) - Floating Disc Conversion Option	01-06
Bonneville (865cc/Cast Wheels)	09-15
Bonneville (865cc/Cast Wheels) - Floating Disc Conversion Option	09-15
Bonneville New Church (865cc/Cast Wheels)	15
Bonneville New Church (865cc/Cast Wheels) - Floating Disc Conversion Option	15
Bonneville SE (865cc/Cast Wheels)	09-11
Bonneville SE (865cc/Cast Wheels) - Floating Disc Conversion Option	09-11
Bonneville Spirit (865cc/Spoke Wheel)	15
Bonneville Spirit (865cc/Spoke Wheel) - Floating Disc Conversion Option	15
Bonneville/Bonneville Black (865cc)	07-08
Bonneville/Bonneville Black (865cc) - Floating Disc Conversion Option	07-08
Bonneville T100 (790cc)	02-04
Bonneville T100 (790cc) - Floating Disc Conversion Option	02-04

	DISC PAD CHOICES - FRONT				BRAKE DISC CHOICES - FRONT						Line #
	FA, SFA, TT Pad or Brake Shoe	SFAC Carbon Scooter Pads	Speciality Pads - SXR / Vee / MXS	Sintered/HH Pads/ Grooved Shoes	Left / Gauche / Links Standard Replacement Disc	Right / Droite / Rechts Standard Replacement Disc	Contour Disc Universal left and right fitment	Universal Custom Disc	Vee-Discs Black † See note below	CX Extreme MX Race Disc/ UTVX Disc	
	FA351TT				N/A						1
	909										2
	909										3
	909										4
	SFA115	SFAC115		SFA115HH	N/A						5
	SFA115	SFAC115		SFA115HH	N/A						6
	FA325TT			FA325R							7
	FA167			FA167HH	N/A						8
	FA266			FA266HH	N/A						9
	SFA264	SFAC264		SFA264HH	N/A						10
											11
											12
	858										13
	854										14
	FA016			FA016HH	MD656						15
	FA016			FA016HH	MD656						16
	FA016			FA016HH	MD656						17
	FA016			FA016HH	MD656						18
	FA016			FA016HH	MD838	MD838					19
	FA016			FA016HH	MD656						20
	FA016			FA016HH	N/A						21
	FA016*			FA016HH*	MD656	MD656					22
	FA016			FA016HH	MD656						23
											24
	FA018*		FA018V*	FA018HH*	N/A	N/A					25
											26
											27
	FA196		FA196V	FA196HH	MD642LS						28
	FA196		FA196V	FA196HH	MD629						29
	FA142		FA142V	FA142HH	MD822					MD649CX	30
											31
	FA142		FA142V	FA142HH	MD822X					MD649CX	32
											33
	FA142		FA142V	FA142HH	MD822						34
											35
	FA142		FA142V	FA142HH	MD822X		MD822XC				36
											37
	FA142		FA142V	FA142HH	MD822X		MD822XC				38
											39
	FA142		FA142V	FA142HH	MD822					MD649CX	40
											41
	FA142		FA142V	FA142HH	MD822X					MD649CX	42
											43
	FA142		FA142V	FA142HH	MD822					MD649CX	44
											45
	FA196		FA196V	FA196HH	MD821X		MD821XC				46
											47
	FA196		FA196V	FA196HH	MD821						48
											49
	FA196		FA196V	FA196HH	MD821X		MD821XC				50
											51
	FA196		FA196V	FA196HH	MD821X		MD821XC				52
											53
	FA142		FA142V	FA142HH	MD822						54
											55
	FA142		FA142V	FA142HH	MD822X		MD822XC				56
											57
	FA142		FA142V	FA142HH	MD822X					MD649CX	58
											59
	FA142		FA142V	FA142HH	MD822					MD649CX	60

FRONT / AVANT / VORN / FRENTE / ANTERIORE

R Suffix = High Durability Sintered Pad. HH Suffix = High Performance Sintered Pad. TT Suffix = Hard Wearing Off Road Pad. V Suffix = Semi Sintered Pad. G Suffix = Grooved Shoe. D Suffix = Drilled Disc. X Suffix = Universal Left or Right Disc. LS Suffix = Left/Steel Disc. RS = Right/Steel Disc.

*-2 Sets Required. † For Vee disc colours add RED, BLU, GRN, GLD, ORG suffix to part number.
 ☉ - Also available as a Vintage Motorcycle Disc.

Non-JAPANESE Built Motorcycles

Line #	BRAKE DISC CHOICES - FRONT						DISC PAD CHOICES - REAR				BRAKE DISC CHOICES - REAR			
	Oversize 250 /280mm Disc Kit	OSX Oversize 250/280mm Disc Kit	Relocating Bracket for 250/ 280mm Disc	Oversize 320mm Disc Kit	SMX Oversize 320mm Disc Kit	Relocating Bracket for 320mm Disc	FA, SFA, TT Pad or Brake Shoe	SFAC Carbon Scooter Pads	Speciality Pads - SXR / Vee / MXS	Sintered/ HH Pads/ Grooved Shoes	Standard Replacement Disc	Contour Disc Rear fitment	Vee-Discs™ CONTOUR	CX Extreme MX Race Disc/ UTVX Disc
1							FA351TT				N/A			
2							909							
3							909							
4							909							
5							909							
6							909							
7							FA325TT			FA325R				
8							FA115			FA115HH	N/A			
9							FA115			FA115HH	N/A			
10							H307							
11														
12														
13							858							
14							853							
15							N/A							
16							FA016			FA016HH	MD656 Ⓞ			
17							FA016			FA016HH	MD656 Ⓞ			
18							FA016			FA016HH	MD656 Ⓞ			
19							FA016			FA016HH	MD838			
20							FA016			FA016HH	MD656 Ⓞ			
21							FA016			FA016HH	N/A			
22							FA016			FA016HH	MD656 Ⓞ			
23							FA016			FA016HH	MD656 Ⓞ			
24														
25							FA018		FA018V	FA018HH	N/A			
26														
27														
28							FA196		FA196V	FA196HH	MD643			
29							FA196		FA196V	FA196HH	MD643			
30							FA214/2		FA214/2V	FA214/2HH	MD643		VR643	
31														
32							FA214/2		FA214/2V	FA214/2HH	MD643		VR643	
33							FA214/2		FA214/2V	FA214/2HH	MD643			
34														
35							FA214/2		FA214/2V	FA214/2HH	MD643			
36							FA214/2		FA214/2V	FA214/2HH	MD643			
37														
38							FA214/2		FA214/2V	FA214/2HH	MD643			
39							FA214/2		FA214/2V	FA214/2HH	MD643		VR643	
40														
41							FA214/2		FA214/2V	FA214/2HH	MD643		VR643	
42							FA214/2		FA214/2V	FA214/2HH	MD663		VR663	
43							FA214/2		FA214/2V	FA214/2HH	MD663		VR663	
44							FA214/2		FA214/2V	FA214/2HH	MD663	MD663C		
45														
46							FA214/2		FA214/2V	FA214/2HH	MD663	MD663C		
47							FA214/2		FA214/2V	FA214/2HH	MD663	MD663C		
48														
49							FA214/2		FA214/2V	FA214/2HH	MD663	MD663C		
50							FA214/2		FA214/2V	FA214/2HH	MD663	MD663C		
51														
52							FA214/2		FA214/2V	FA214/2HH	MD663	MD663C		
53							FA214/2		FA214/2V	FA214/2HH	MD663			
54														
55							FA214/2		FA214/2V	FA214/2HH	MD663			
56							FA214/2		FA214/2V	FA214/2HH	MD663		VR663	
57														
58							FA214/2		FA214/2V	FA214/2HH	MD663		VR663	
59							FA214/2		FA214/2V	FA214/2HH	MD663		VR663	
60							FA214/2		FA214/2V	FA214/2HH	MD663		VR663	

REAR / ARRIÈRE / HINTEN / POSTERIOR / POSTERIORE

R Suffix = High Durability Sintered Pad. **HH** Suffix = High Performance Sintered Pad. **TT** Suffix = Hard Wearing Off Road Pad. **V** Suffix = Semi Sintered Pad. **G** Suffix = Grooved Shoe.
D Suffix = Drilled Disc. **X** Suffix = Universal Left or Right Disc. **XC** Suffix = Contoured Disc. **LS** Suffix = Left/Steel Disc. **RS** = Right/Steel Disc.

*-2 Sets Required. † For Vee disc colours add RED, BLU, GRN, GLD, ORG suffix to part number.
 Ⓞ - Also available as a Vintage Motorcycle Disc.

Part numbers, prefixes, suffixes, photos and illustrations shown in this catalogue are trademarks and/or copyrights of EBC Brakes or the trademark owner A C Freeman Investments Ltd and use without express written permission of the owners is punishable by law.

Non-JAPANESE Built Motorcycles



TRIUMPH Contd.
(HINCKLEY PRODUCED MACHINES)



DISC PAD CHOICES - FRONT

BRAKE DISC CHOICES - FRONT

Line #

Bonneville T100 (865cc)	05-09
Bonneville T100 (865cc) - Floating Disc Conversion Option	05-09
Bonneville T100 (865cc/Air Cooled/Spoke Wheel)	10-16
Bonneville T100 (865cc/Air Cooled/Spoke Wheel)	
- Floating Disc Conversion Option	10-16
Bonneville T100 Black (865cc/Air Cooled/Spoke Wheel)	14-16
Bonneville T100 Black (865cc/Air Cooled/Spoke Wheel)	
- Floating Disc Conversion Option	14-16
Bonneville T100 (900cc/Liquid Cooled/Spoke Wheel)	16-21
Bonneville T100 Black (900cc/Liquid Cooled/Spoke Wheel)	16-21
Bonneville T214 (865cc/Spoke Wheel)	15
Bonneville T214 (865cc/Spoke Wheel)	
- Floating Disc Conversion Option	15
Bonneville Steve McQueen SE (865cc/Spoke Wheel)	12
Bonneville Steve McQueen SE (865cc/Spoke Wheel)	
- Floating Disc Conversion Option	12
Bonneville T120 (1200cc Liquid Cooled)	16-21
Bonneville T120 (1200cc Liquid Cooled)	
- Floating Disc Conversion Option	16-21
Bonneville T120 Black (1200cc Liquid Cooled)	16-21
Bonneville T120 Black (1200cc Liquid Cooled)	
- Floating Disc Conversion Option	16-21
Bonneville Bobber (1200cc Liquid Cooled)	17-21
Bonneville Bobber (1200cc Liquid Cooled)	
- Floating Disc Conversion Option	17-21
Bonneville Bobber Black (1200cc Liquid Cooled)	18-21
Bonneville Bobber Black (1200cc Liquid Cooled)	
- Floating Disc Conversion Option	18-21
Bonneville Speedmaster (1200cc Liquid Cooled)	18-21
Bonneville Speedmaster (1200cc Liquid Cooled)	
- Floating Disc Conversion Option	18-21
Bonneville Speed Twin (1200cc Liquid Cooled)	19-21
Scrambler XC 1200 Twin Liquid Cooled	19-21
Scrambler XE 1200 Twin Liquid Cooled	19-21
Daytona 600	03-04
TT 600	00-03
Daytona 650	05
Daytona 675	06-08
Daytona 675 Black Monobloc radial caliper	
- flat look to outer body	09-12
Daytona 675 (Nissin F/Brembo R Calipers)	13-17
Daytona 675 R (Brembo F/Nissin R Caliper)	11-12
Daytona 675 R (Brembo Calipers F&R)	13-17
Street Triple S 765 ABS (Nissin 2 piston front calipers, Brembo single piston rear caliper)	18-20
Street Triple R 765 ABS (Brembo 4 piston radial front calipers, Brembo single piston rear caliper)	18-20
Street Triple RS 765 ABS (Brembo 4 piston radial monobloc front calipers, Brembo single piston rear caliper)	18-20
Daytona 765 Moto2	20
T595 Daytona (6 bolt) Front disc	97
Daytona 955i (6 bolt) Front disc (single sided swinging arm)	98-00
Daytona 955i (from VIN132513)	
(5 bolt Front disc) (Single sided s/arm)	01-04
Daytona 955i (from VIN132513)	
(5 bolt Front disc) (Double sided s/arm)	01-04
Daytona 955i	05-06
Daytona 750 (3 cyl)	92
Daytona 1000 (4 cyl)	92
Daytona 900 (3 cyl)	93-96

FRONT / AVANT / VORN / FRENTE / ANTERIORE

FA, SFA, TT Pad or Brake Shoe	SFAC Carbon Scooter Pads	Speciality Pads - SXR / Vee / MXS	Sintered/HH Pads/ Grooved Shoes	Left / Gauche / Links Standard Replacement Disc	Right / Droite / Rechts Standard Replacement Disc	Contour Disc Universal left and right fitment	Universal Custom Disc	Vee-Discs Black † See note below	CX Extreme MX Race Disc/ UTVX Disc
FA142		FA142V	FA142HH	MD822					MD649CX
FA142		FA142V	FA142HH	MD822X					MD649CX
FA142		FA142V	FA142HH	MD822					
FA142		FA142V	FA142HH	MD822X		MD822XC			
FA142		FA142V	FA142HH	MD822					
FA142		FA142V	FA142HH	MD822X		MD822XC			
FA181TT			FA181HH	MD886X					
FA181TT			FA181HH	MD886X					
FA142		FA142V	FA142HH	MD822					
FA142		FA142V	FA142HH	MD822X		MD822XC			
FA142		FA142V	FA142HH	MD822					
FA142		FA142V	FA142HH	MD822X		MD822XC			
FA196*			FA196HH*	MD873	MD873				
FA196TT*			FA196HH*	MD873X	MD873X				
FA196TT*			FA196HH*	MD873	MD873				
FA196TT*			FA196HH*	MD873X	MD873X				
FA181TT			FA181HH	MD873					
FA196TT*		FA196V*	FA196HH*	MD873	MD873				
FA196TT*		FA196V*	FA196HH*	MD873X	MD873X				
FA196*		FA196V*	FA196HH*	MD873	MD873				
FA196*		FA196V*	FA196HH*	MD873X	MD873X				
FA447HH*						MD8008XC			
FA447HH*						MD8008XC			
FA236*			FA236HH*	MD662X	MD662X	MD662XC*		VR662BLK*	
FA236*			FA236HH*	MD662X	MD662X	MD662XC*		VR662BLK*	
FA236*			FA236HH*	MD662X	MD662X	MD662XC*		VR662BLK*	
			FA347HH*	MD800X	MD800X	MD800XC*		VR800BLK*	
				FA491HH*	MD800X	MD800X	MD800XC*	VR800BLK*	
				FA491HH*	MD800X	MD800X	MD800XC*	VR800BLK*†	
			FA447HH*	TBA	TBA				
			FA447HH*	MD800X	MD800X	MD800XC*		VR800BLK*†	
FA266*			FA266HH*	MD852X	MD852X	MD852XC*			
			FA630HH*	MD852X	MD852X	MD852XC*			
			FA630HH*	MD852X	MD852X	MD852XC*			
			FA604/4HH*	TBA	TBA				
FA236*			FA236HH*	MD647X	MD647X	MD647XC*		VR647BLK*	
FA236*			FA236HH*	MD647X	MD647X	MD647XC*		VR647BLK*	
FA236*			FA236HH*	MD669X	MD669X	MD669XC*		VR669BLK*	
FA236*			FA236HH*	MD669X	MD669X	MD669XC*		VR669BLK*	
FA236*			FA236HH*	MD669X	MD669X	MD669XC*		VR669BLK*	
FA236*			FA236HH*	MD640	MD640			VR640BLK*	
FA236*			FA236HH*	MD640	MD640			VR640BLK*	
FA236*			FA236HH*	MD640	MD640			VR640BLK*	

1
2
3
4
5
6
7
8
9
10
11
12
13
14
15
16
17
18
19
20
21
22
23
24
25
26
27
28
29
30
31
32
33
34
35
36
37
38
39
40
41
42
43
44
45
46
47
48
49
50
51
52
53
54
55
56
57
58
59
60

R Suffix = High Durability Sintered Pad. HH Suffix = High Performance Sintered Pad. TT Suffix = Hard Wearing Off Road Pad. V Suffix = Semi Sintered Pad. G Suffix = Grooved Shoe.
D Suffix = Drilled Disc. X Suffix = Universal Left or Right Disc. XC Suffix = Contoured Disc. LS Suffix = Left/Steel Disc. RS = Right/Steel Disc.

*-2 Sets Required. † For Vee disc colours add RED, BLU, GRN, GLD, ORG suffix to part number.

⊗ - Also available as a Vintage Motorcycle Disc.

Non-JAPANESE Built Motorcycles

Line #	BRAKE DISC CHOICES - FRONT						DISC PAD CHOICES - REAR				BRAKE DISC CHOICES - REAR			
	Oversize 250 /280mm Disc Kit	OSX Oversize 250/280mm Disc Kit	Relocating Bracket for 250/ 280mm Disc	Oversize 320mm Disc Kit	SMX Oversize 320mm Disc Kit	Relocating Bracket for 320mm Disc	FA, SFA, TT Pad or Brake Shoe	SFAC Carbon Scooter Pads	Speciality Pads - SXR / Vee / MXS	Sintered/ HH Pads/ Grooved Shoes	Standard Replacement Disc	Contour Disc Rear fitment	Vee-Discs™ CONTOUR	CX Extreme MX Race Disc/ UTVX Disc
1							FA214/2		FA214/2V	FA214/2HH	MD663		VR663	
2							FA214/2		FA214/2V	FA214/2HH	MD663		VR663	
3							FA214/2		FA214/2V	FA214/2HH	MD663			
4														
5							FA214/2		FA214/2V	FA214/2HH	MD663			
6							FA214/2		FA214/2V	FA214/2HH	MD663			
7														
8							FA214/2		FA214/2V	FA214/2HH	MD663			
9							FA214/2		FA214/2V	FA214/2HH	MD874			
10							FA214/2		FA214/2V	FA214/2HH	MD874			
11							FA214/2		FA214/2V	FA214/2HH	MD663			
12														
13							FA214/2		FA214/2V	FA214/2HH	MD663			
14							FA214/2		FA214/2V	FA214/2HH	MD663			
15														
16							FA214/2		FA214/2V	FA214/2HH	MD663			
17							FA214/2		FA214/2V	FA214/2HH	MD874			
18														
19							FA214/2		FA214/2V	FA214/2HH	MD874			
20							FA214/2		FA214/2V	FA214/2HH	MD874			
21														
22							FA214/2		FA214/2V	FA214/2HH	MD874			
23							FA140		FA140V	FA140HH	MD874			
24														
25							FA140		FA140V	FA140HH	MD874			
26							FA140		FA140V	FA140HH	MD874			
27														
28							FA140		FA140V	FA140HH	MD874			
29							FA140		FA140V	FA140HH	MD874			
30														
31							FA140		FA140V	FA140HH	MD874			
32							FA215/2			FA215/2HH				
33							FA209/2			FA209/2HH	MD874			
34							FA209/2			FA209/2HH	MD874			
35							FA140		FA140V	FA140HH	MD648	MD648C	VR648	
36							FA140		FA140V	FA140HH	MD648	MD648C	VR648	
37							FA140		FA140V	FA140HH	MD648	MD648C	VR648	
38							FA140		FA140V	FA140HH	MD648	MD648C	VR648	
39														
40							FA140		FA140V	FA140HH	MD648	MD648C	VR648	
41							FA213			FA213HH	MD851	MD851C		
42							FA140		FA140V	FA140HH	MD648	MD648C	VR648	
43							FA213			FA213HH	MD851	MD851C		
44														
45							FA213			FA213HH				
46														
47							FA213			FA213HH				
48														
49							FA213			FA213HH				
50							FA213			FA213HH				
51							FA214/2		FA214/2V	FA214/2HH	MD648	MD648C	VR648	
52							FA214/2		FA214/2V	FA214/2HH	MD648	MD648C	VR648	
53														
54							FA214/2		FA214/2V	FA214/2HH	MD648	MD648C	VR648	
55														
56							FA140		FA140V	FA140HH	MD648	MD648C	VR648	
57							FA214/2		FA214/2V	FA214/2HH	MD648	MD648C	VR648	
58							FA215/2		FA215/2V	FA215/2HH	MD641		VR641	
59							FA215/2		FA215/2V	FA215/2HH	MD641		VR641	
60							FA215/2		FA215/2V	FA215/2HH	MD641		VR641	

REAR / ARRIÈRE / HINTEN / POSTERIOR / POSTERIORE

R Suffix = High Durability Sintered Pad. **HH** Suffix = High Performance Sintered Pad. **TT** Suffix = Hard Wearing Off Road Pad. **V** Suffix = Semi Sintered Pad. **G** Suffix = Grooved Shoe.
D Suffix = Drilled Disc. **X** Suffix = Universal Left or Right Disc. **XC** Suffix = Contoured Disc. **LS** Suffix = Left/Steel Disc. **RS** = Right/Steel Disc.

*-2 Sets Required. † For Vee disc colours add RED, BLU, GRN, GLD, ORG suffix to part number.
 Ⓢ - Also available as a Vintage Motorcycle Disc.

Part numbers, prefixes, suffixes, photos and illustrations shown in this catalogue are trademarks and/or copyrights of EBC Brakes or the trademark owner A C Freeman Investments Ltd and use without express written permission of the owners is punishable by law.

Non-JAPANESE Built Motorcycles



TRIUMPH Contd.
(HINCKLEY PRODUCED MACHINES)



DISC PAD CHOICES - FRONT

BRAKE DISC CHOICES - FRONT

	FA, SFA, TT Pad or Brake Shoe	SFAC Carbon Scooter Pads	Speciality Pads - SXR / Vee / MXS	Sintered/HH Pads/ Grooved Shoes	Left / Gauche / Links Standard Replacement Disc	Right / Droite / Rechts Standard Replacement Disc	Contour Disc Universal left and right fitment	Universal Custom Disc	Vee-Discs Black † See note below	CX Extreme MX Race Disc/ UTVX Disc
Daytona Super III (3 cyl)	FA190*			FA190HH*	MD640	MD640			VR640BLK*	
Daytona 1200 (4 cyl)	FA236*			FA236HH*	MD640	MD640			VR640BLK*	
Legend TT	FA196		FA196V	FA196HH	MD642LS					
Legend TT - Floating Disc Conversion Option	FA196		FA196V	FA196HH	MD629					
Rocket III 2300cc				FA236HH*	MD669X	MD669X	MD669XC*		VR669BLK*	
Rocket III Classic				FA236HH*	MD669X	MD669X	MD669XC*		VR669BLK*	
Rocket III Roadster ABS				FA236HH*	MD669X	MD669X	MD669XC*		VR669BLK*	
Rocket III Touring				FA236HH*	TBA	TBA				
Rocket X				FA236HH*	MD669X	MD669X	MD669XC*		VR669BLK*	
Rocket III R	19-20			FA477HH*			MD8008XC*			
Rocket III GT	19-20			FA477HH*			MD8008XC*			
Scrambler (865cc)	FA142		FA142V	FA142HH	MD822					MD649CX
Scrambler (865cc) - Floating Disc Conversion Option	FA142		FA142V	FA142HH	MD822X					MD649CX
Scrambler (865cc)	FA142		FA142V	FA142HH	MD822					
Scrambler (865cc) - Floating Disc Conversion Option	FA142		FA142V	FA142HH	MD822X		MD822XC			
Speed Triple 750/900 (Carb Models)	FA236*			FA236HH*	MD640	MD640				
Speed Triple T509 - (EFI 885cc - 6 Bolt Front Disc)	FA236*			FA236HH*	MD647X	MD647X	MD647XC*		VR647BLK*	
Speed Triple (EFI 955cc - 6 Bolt Front Disc)	FA236*			FA236HH*	MD647X	MD647X	MD647XC*		VR647BLK*	
Speed Triple (1050cc - Nissin Radial F/Caliper/220mm R/Disc)				FA347HH*	MD679X	MD679X	MD679XC*		VR679BLK*	
Speed Triple (1050cc - 4 Pad Brembo F/Caliper /220mm R/Disc/Non ABS Model- To VIN 461331)				FA322/4HH*	MD817X	MD817X	MD817XC*		VR817BLK*	
Speed Triple (1050cc - 4 Pad Brembo F/Caliper /220mm R/Disc/ABS Model- To VIN 461331)				FA322/4HH*	MD817X	MD817X	MD817XC*		VR817BLK*	
Speed Triple (1050cc - 4 Pad Brembo F/Caliper /255mm R/Disc/Non ABS Model- From VIN461332)				FA604/4HH*	MD817X	MD817X	MD817XC*		VR817BLK*	
Speed Triple (1050cc - 4 Pad Brembo F/Caliper /255mm R/Disc/ABS Model- To VIN 461331)				FA604/4HH*	MD817X	MD817X	MD817XC*		VR817BLK*	
Speed Triple S (1050cc/ABS Model)				FA447HH*	MD817X	MD817X	MD817XC*		VR817BLK*	
Speed Triple R (1050cc - 2 Pad Brembo F/Caliper /255mm R/Disc/Non ABS /5 Spoke wheels)				FA447HH*	MD679X	MD679X	MD679XC*		VR679BLK*	
Speed Triple R (1050cc - 2 Pad Brembo F/Caliper /255mm R/Disc ABS /5 Spoke wheels)				FA447HH*	MD679X	MD679X	MD679XC*		VR679BLK*	
Speed Triple R (1050cc - 2Pad Brembo F/Caliper /Non ABS Model/ 10 Spoke wheels)				FA447HH*	MD817X	MD817X	MD817XC*		VR817BLK*	
Speed Triple R (1050cc - 2Pad Brembo F/Caliper /ABS Model/ 10 Spoke wheels)				FA447HH*	MD817X	MD817X	MD817XC*		VR817BLK*	
Speed Triple R (1050cc/ABS)	17-21			FA447HH*		MD817X	MD8008XC*			
Speed Triple RS (1050cc/ABS)	18-21			FA447HH*		MD679X	MD8008XC*			
Speed Triple RS (1200cc/ABS)	21			FA447HH*						
Speedfour 600	FA236*			FA236HH*	MD662X	MD662X	MD662XC*		VR662BLK*	
Speedmaster (790cc/Carbs)	FA196		FA196V*	FA196HH*	MD649	MD649				MD649CX*
Speedmaster (790cc/Carbs) - Floating Disc Conversion Option	FA196*		FA196V*	FA196HH*	MD649	MD649				MD649CX*
Speedmaster (865cc/Carbs)	FA196*		FA196V*	FA196HH*	MD649	MD649				MD649CX*
Speedmaster (865cc/Carbs) - Floating Disc Conversion Option	FA196*		FA196V*	FA196HH*	MD601LS	MD601RS				MD649CX*
Speedmaster (865cc/EFI)	FA142*		FA142V*	FA142HH*	MD822	MD822				MD649CX*
Speedmaster (865cc/EFI) - Floating Disc Conversion Option	FA142*		FA142V*	FA142HH*	MD822X	MD822X				MD649CX*
Speedmaster (865cc/EFI)	FA196*		FA196V*	FA196HH*	MD821					
Speedmaster (865cc/EFI) - Floating Disc Conversion Option	FA196*		FA196V*	FA196HH*	MD821X		MD821XC			
Sprint (All carb models) Left	FA214		FA214V	FA214HH	MD646LS	MD646RS			VR646BLK*	
Sprint (All carb models from VIN 9082) Right	FA215		FA215V	FA215HH						
Sprint (All carb models from VIN 9083)	FA236*			FA236HH*	MD640	MD640			VR640BLK*	
Sprint RS (up to VIN 139276) (6 bolt front disc) (double sided swing arm)	FA236*			FA236HH*	MD647X	MD647X	MD647XC*		VR647BLK*	
Sprint RS (from VIN 139277) (6 bolt front disc) Note: up to VIN 161317 double sided swing arm	FA236*			FA236HH*	MD647X	MD647X	MD647XC*		VR647BLK*	

FRONT / AVANT / VORN / FRENTE / ANTERIORE

Line #

R Suffix = High Durability Sintered Pad. HH Suffix = High Performance Sintered Pad. TT Suffix = Hard Wearing Off Road Pad. V Suffix = Semi Sintered Pad. G Suffix = Grooved Shoe. D Suffix = Drilled Disc. X Suffix = Universal Left or Right Disc. XC Suffix = Contoured Disc. LS Suffix = Left/Steel Disc. RS = Right/Steel Disc.

*-2 Sets Required. † For Vee disc colours add RED, BLU, GRN, GLD, ORG suffix to part number.

⊗ - Also available as a Vintage Motorcycle Disc.

Non-JAPANESE Built Motorcycles

Line #	BRAKE DISC CHOICES - FRONT						DISC PAD CHOICES - REAR				BRAKE DISC CHOICES - REAR			
	Oversize 250 /280mm Disc Kit	OSX Oversize 250/280mm Disc Kit	Relocating Bracket for 250/ 280mm Disc	Oversize 320mm Disc Kit	SMX Oversize 320mm Disc Kit	Relocating Bracket for 320mm Disc	FA, SFA, TT Pad or Brake Shoe	SFAC Carbon Scooter Pads	Speciality Pads - SXR / Vee / MXS	Sintered/ HH Pads/ Grooved Shoes	Standard Replacement Disc	Contour Disc Rear fitment	Vee-Discs™ CONTOUR	CX Extreme MX Race Disc/ UTVX Disc
1							FA215/2		FA215/2V	FA215/2HH	MD641		VR641	
2							FA215/2		FA215/2V	FA215/2HH	MD641		VR641	
3							FA196		FA196V	FA196HH	MD643			
4							FA196		FA196V	FA196HH	MD643			
5									FA209/2V	FA209/2HH	MD699			
6									FA209/2V	FA209/2HH	MD699			
7									FA209/2V	FA209/2HH	MD699			
8									FA209/2V	FA209/2HH	MD699			
9									FA209/2V	FA209/2HH	MD699			
10														
11									FA630HH					
12									FA630HH					
13							FA214/2		FA214/2V	FA214/2HH	MD663		VR663	
14							FA214/2		FA214/2V	FA214/2HH	MD663		VR663	
15							FA214/2		FA214/2V	FA214/2HH	MD663			
16							FA214/2		FA214/2V	FA214/2HH	MD663			
17							FA215/2		FA215/2V	FA215/2HH	MD641		VR641	
18							FA214/2		FA214/2V	FA214/2HH	MD648	MD648C	VR648	
19							FA214/2		FA214/2V	FA214/2HH	MD648	MD648C	VR648	
20									FA214/2V	FA214/2HH	MD648	MD648C	VR648	
21									FA214/2V	FA214/2HH	MD648	MD648C	VR648	
22									FA214/2V	FA214/2HH	MD648	MD648C	VR648	
23									FA214/2V	FA214/2HH	MD648	MD648C	VR648	
24									FA214/2V	FA214/2HH	MD648	MD648C	VR648	
25									FA214/2V	FA214/2HH	MD663	MD663C	VR663	
26									FA214/2V	FA214/2HH	MD663	MD663C	VR663	
27									FA214/2V	FA214/2HH	MD820	MD820C	VR820	
28									FA214/2V	FA214/2HH	MD874			
29									FA214/2V	FA214/2HH	MD874			
30									FA214/2V	FA214/2HH	MD663	MD663C	VR663	
31									FA214/2V	FA214/2HH	MD663	MD663C	VR663	
32									FA214/2V	FA214/2HH	MD820	MD820C	VR820	
33									FA214/2V	FA214/2HH	MD820	MD820C	VR820	
34									FA214/2V	FA214/2HH	MD663	MD663C	VR663	
35									FA214/2V	FA214/2HH	MD663	MD663C	VR663	
36									FA214/2V	FA214/2HH	MD820	MD820C	VR820	
37									FA214/2V	FA214/2HH	MD820	MD820C	VR820	
38									FA214/2V	FA214/2HH	MD874			
39									FA214/2V	FA214/2HH	MD874			
40									FA213	FA213HH				
41							FA140		FA140V	FA140HH	MD648	MD648C	VR648	
42							FA214/2		FA214/2V	FA214/2HH	MD643		VR643	
43									FA214/2V	FA214/2HH	MD643		VR643	
44									FA214/2V	FA214/2HH	MD643		VR643	
45									FA214/2V	FA214/2HH	MD643		VR643	
46									FA214/2V	FA214/2HH	MD643		VR643	
47									FA214/2V	FA214/2HH	MD643		VR643	
48									FA214/2V	FA214/2HH	MD643		VR643	
49									FA214/2V	FA214/2HH	MD643		VR643	
50									FA214/2V	FA214/2HH	MD643		VR643	
51									FA214/2V	FA214/2HH	MD643		VR643	
52									FA214/2V	FA214/2HH	MD643		VR643	
53									FA214/2V	FA214/2HH	MD643		VR643	
54							FA215/2		FA215/2V	FA215/2HH	MD641		VR641	
55									FA215/2V	FA215/2HH	MD641		VR641	
56									FA215/2V	FA215/2HH	MD641		VR641	
57									FA215/2V	FA215/2HH	MD641		VR641	
58									FA215/2V	FA215/2HH	MD663	MD663C	VR663	
59									FA215/2V	FA215/2HH	MD663	MD663C	VR663	
60									FA215/2V	FA215/2HH	MD663	MD663C	VR663	

REAR / ARRIÈRE / HINTEN / POSTERIORE

R Suffix = High Durability Sintered Pad. **HH** Suffix = High Performance Sintered Pad. **TT** Suffix = Hard Wearing Off Road Pad. **V** Suffix = Semi Sintered Pad. **G** Suffix = Grooved Shoe.
D Suffix = Drilled Disc. **X** Suffix = Universal Left or Right Disc. **XC** Suffix = Contoured Disc. **LS** Suffix = Left/Steel Disc. **RS** = Right/Steel Disc.

BRAKE APPLICATIONS

*-2 Sets Required. † For Vee disc colours add RED, BLU, GRN, GLD, ORG suffix to part number.
 Ⓢ - Also available as a Vintage Motorcycle Disc.

Non-JAPANESE Built Motorcycles



TRIUMPH Contd.
(HINCKLEY PRODUCED MACHINES)



DISC PAD CHOICES - FRONT

BRAKE DISC CHOICES - FRONT

FRONT / AVANT / VORN / FRENTE / ANTERIORE

	FA, SFA, TT Pad or Brake Shoe	SFAC Carbon Scooter Pads	Speciality Pads - SXR / Vee / MXS	Sintered/HH Pads/ Grooved Shoes	Left / Gauche / Links Standard Replacement Disc	Right / Droite / Rechts Standard Replacement Disc	Contour Disc Universal left and right fitment	Universal Custom Disc	Vee-Discs Black † See note below	CX Extreme MX Race Disc/ UTVX Disc
Sprint RS (from VIN 139277) (Single sided swing arm up to VIN 161317) (6 bolt front disc)										
Note: from VIN 161318 double sided swing arm 03-04	FA236*			FA236HH*	MD647X	MD647X	MD647XC*		VR647BLK*	
Sprint ST 955i (Front Disc With Offset/6 Bolt Fixing) 99-04	FA236*			FA236HH*	MD647X	MD647X	MD647XC*		VR647BLK*	
Sprint ST 1050 (5 Spoke wheel/Non ABS/F Disc With Offset/5 Bolt Fixing) Vin 208167> 05-10	FA236*			FA236HH*	MD669X	MD669X	MD669XC*		VR669BLK*	
Sprint ST 1050 (5 Spoke wheel/ABS/F Disc With Offset/5 Bolt Fixing) 05-10	FA236*			FA236HH*	MD669X	MD669X	MD669XC*		VR669BLK*	
Sprint ST 1050i (Non ABS/Front Disc With Zero Offset/5 Bolt Fixing) 11-12	FA236*			FA236HH*	MD817X	MD817X	MD817XC*		VR817BLK*	
Sprint ST 1050i (ABS/Front Disc With Zero Offset/5 Bolt Fixing) 11-12	FA236*			FA236HH*	MD817X	MD817X	MD817XC*		VR817BLK*	
Sprint GT 1050/SE (ABS) 10-20	FA236*			FA236HH*	MD817X	MD817X	MD817XC*		VR817BLK*	
Street Cup (900cc Liquid Cooled) 16-20	FA181TT			FA181HH	MD886X					
Street Scrambler (900cc Liquid Cooled) 16-20	FA181TT			FA181HH	MD873		MD873X			
Street Triple S 660 (Nissin F/Brembo R Calipers) 17-20	FA226*			FA226HH*	TBA	TBA				
Street Triple 675 (Naked) 07-12	FA226*			FA226HH*	MD800X	MD800X	MD800XC*		VR800BLK*	
Street Triple 675 (Nissin F/Brembo R Calipers) 13-16	FA226*			FA226HH*	MD852X	MD852X	MD852XC*			
Street Triple S 765 (Nissin F/Brembo R Calipers) 17-20	FA226*			FA226HH*	TBA	TBA				
Street Triple R 675 09-12				FA347HH*	MD800X	MD800X	MD800XC		VR800BLK*	
Street Triple R 675 (Nissin F/Brembo R Calipers) 13-16				FA347HH*	MD852X	MD852X	MD852XC*			
R 675 Brembo Front & Rear Calipers 17-20				FA447HH*	MD852X	MD852X				
Street Triple RX 675 (Nissin F/Brembo R Calipers) 15-16				FA347HH*	MD852X	MD852X	MD852XC*			
Street Triple R 765 (Brembo F&R Calipers) 18-19				FA630HH*	MD852X	MD852X	MD852XC*			
Street Triple R 765 (Brembo F&R Calipers) 20-22				FA447HH*	MD852X	MD852X	MD852XC*			
Street Triple RS 765 (Brembo F&R Calipers) 18-20				FA447HH*	MD852X	MD852X	MD852XC*			
Street Twin (900cc Liquid Cooled) 16-18	FA181TT			FA181HH	MD873X					
Street Twin (900cc Liquid Cooled) - Floating Disc Conversion Option 19-21				FA604/4HH	MD873X					
Trident 660cc 21	FA226*			FA226HH						
Thunderbird 95-03	FA196		FA196V	FA196HH	MD642LS					
Thunderbird - Floating Disc Conversion Option 95-03	FA196		FA196V	FA196HH	MD629					
Thunderbird Sport 98-04	FA196*		FA196V*	FA196HH*	MD649	MD649				MD649CX*
Thunderbird Sport - Floating Disc Conversion Option 98-04	FA196*		FA196V*	FA196HH*	MD601LS	MD601RS				MD649CX*
Thunderbird (1597cc) 09-18	FA236*			FA236HH*	MD825	MD825				
Thunderbird Commander (1699cc) 14-18	FA236*			FA236HH*	MD825	MD825				
Thunderbird LT (1699cc) 14-18	FA236*			FA236HH*	MD825	MD825				
Thunderbird Storm (1699cc) 11-18	FA236*			FA236HH*	MD825	MD825				
Thunderbird Nightstorm (1699cc) 15-18	FA236*			FA236HH*	MD825	MD825				
Thruxton 900 04-16	FA181TT			FA181HH	MD629X		MD629XC		VR629BLK	
Thruxton Ace 900 15-16	FA142			FA142HH	MD629X		MD629XC		VR629BLK	
Tiger 800 (Non ABS) 11-14	FA226*			FA226HH*	MD842X	MD842X	MD842XC*		VR842BLK*	
Tiger 800 (With ABS) 11-14	FA226*			FA226HH*	MD842X	MD842X	MD842XC*		VR842BLK*	
Tiger 800 XC (Non ABS) 11-14	FA226*			FA226HH*	MD842X	MD842X	MD842XC*		VR842BLK*	
Tiger 800 XC (With ABS) 11-20	FA226*			FA226HH*	MD842X	MD842X	MD842XC*		VR842BLK*	
Tiger 800 XCa (ABS) up to VIN 855531 15-18	FA226*			FA226HH*	MD842X	MD842X	MD842XC*		VR842BLK*	
Tiger 800 XCa (ABS) from VIN 855532 18-20	FA181TT*		FA181V*	FA181HH*	MD842X	MD842X	MD842XC*		VR842BLK	
Tiger 800 XCx (ABS) up to VIN 855531 15-18	FA226*			FA226HH*	MD842X	MD842X	MD842XC*		VR842BLK*	
Tiger 800 XCx (ABS) from VIN 855532 18-20	FA181TT*		FA181V*	FA181HH*	MD842X	MD842X	MD842XC*		VR842BLK	
Tiger 800 XR (ABS) 15-18	FA226*			FA226HH*	MD842X	MD842X	MD842XC*		VR842BLK*	
Tiger 800 XRT (ABS) up to VIN 855531 15-18	FA226*			FA226HH*	MD842X	MD842X	MD842XC*		VR842BLK*	
Tiger 800 XRT (ABS) from VIN 855532 18-20	FA181TT*		FA181V*	FA181HH*	MD842X	MD842X	MD842XC*		VR842BLK	
Tiger 800 XRx (ABS) up to VIN 855531 15-18	FA226*			FA226HH*	MD842X	MD842X	MD842XC*		VR842BLK*	
Tiger 800 XRx (ABS) from VIN 855532 18-20	FA181TT*		FA181V*	FA181HH*	MD842X	MD842X	MD842XC*		VR842BLK	
Tiger 850 Sport (ABS) 21				FA447HH*			MD8008XC*			
Tiger 885cc (Carbs) (Up to VIN 71698) Left 92-97	FA214		FA214V	FA214HH	MD644					
Right 92-97	FA215		FA215V	FA215HH		MD644				
Tiger 885i (From VIN 71699) 98-99	FA196*			FA196HH*	MD649	MD649				MD649CX*
Tiger 885i (From VIN 71699) - Floating Disc Conversion 98-99	FA196*			FA196HH*	MD601LS	MD601RS				MD649CX*
Tiger 900 21				FA447HH*	MD842X	MD842X	MD8008XC*			

Line #
1
2
3
4
5
6
7
8
9
10
11
12
13
14
15
16
17
18
19
20
21
22
23
24
25
26
27
28
29
30
31
32
33
34
35
36
37
38
39
40
41
42
43
44
45
46
47
48
49
50
51
52
53
54
55
56
57
58
59
60

R Suffix = High Durability Sintered Pad. HH Suffix = High Performance Sintered Pad. TT Suffix = Hard Wearing Off Road Pad. V Suffix = Semi Sintered Pad. G Suffix = Grooved Shoe.
D Suffix = Drilled Disc. X Suffix = Universal Left or Right Disc. XC Suffix = Contoured Disc. LS Suffix = Left/Steel Disc. RS = Right/Steel Disc.

*-2 Sets Required. † For Vee disc colours add RED, BLU, GRN, GLD, ORG suffix to part number.

⊗ - Also available as a Vintage Motorcycle Disc.

Non-JAPANESE Built Motorcycles

Line #	BRAKE DISC CHOICES - FRONT						DISC PAD CHOICES - REAR				BRAKE DISC CHOICES - REAR			
	Oversize 250 /280mm Disc Kit	OSX Oversize 250/280mm Disc Kit	Relocating Bracket for 250/ 280mm Disc	Oversize 320mm Disc Kit	SMX Oversize 320mm Disc Kit	Relocating Bracket for 320mm Disc	FA, SFA, TT Pad or Brake Shoe	SFAC Carbon Scooter Pads	Speciality Pads - SXR / Vee / MXS	Sintered/ HH Pads/ Grooved Shoes	Standard Replacement Disc	Contour Disc Rear fitment	Vee-Discs™ CONTOUR	CX Extreme MX Race Disc/ UTVX Disc
1														
2														
3							FA214/2		FA214/2V	FA214/2HH	MD663	MD663C	VR663	
4							FA214/2		FA214/2V	FA214/2HH	MD663	MD663C	VR663	
5														
6							FA214/2		FA214/2V	FA214/2HH	MD663	MD663C	VR663	
7														
8							FA214/2		FA214/2V	FA214/2HH	MD820	MD820C		
9														
10							FA214/2		FA214/2V	FA214/2HH	MD663	MD663C	VR663	
11														
12							FA214/2		FA214/2V	FA214/2HH	MD820	MD820C		
13							FA214/2		FA214/2V	FA214/2HH	MD820	MD820C		
14							FA214/2		FA214/2V	FA214/2HH	MD874			
15							FA214/2		FA214/2V	FA214/2HH	MD874			
16							FA213		FA213V	FA213HH	MD851	MD851C		
17							FA140		FA140V	FA140HH	MD648	MD648C	VR648	
18							FA213		FA213V	FA213HH	MD851	MD851C		
19							FA213		FA213V	FA213HH	MD851	MD851C		
20							FA140		FA140V	FA140HH	MD648	MD648C	VR648	
21							FA213		FA213V	FA213HH	MD851	MD851C		
22							FA213		FA213V	FA213HH	MD851	MD851C		
23							FA213		FA213V	FA213HH	MD851	MD851C		
24							FA213		FA213V	FA213HH	MD851	MD851C		
25							FA213		FA213V	FA213HH	MD851	MD851C		
26							FA213		FA213V	FA213HH	MD851	MD851C		
27							FA214/2		FA214/2V	FA214/2HH	MD874			
28														
29							FA214/2		FA214/2V	FA214/2HH	MD874			
30							FA140		FA140V	FA140HH				
31							FA196		FA196V	FA196HH	MD643			
32							FA196		FA196V	FA196HH	MD643			
33							FA196		FA196V	FA196HH	MD643		VR643	
34							FA196		FA196V	FA196HH	MD643		VR643	
35							FA209/2		FA209/2V	FA209/2HH	MD831			
36							FA209/2		FA209/2V	FA209/2HH	MD831			
37							FA209/2		FA209/2V	FA209/2HH	MD831			
38							FA209/2		FA209/2V	FA209/2HH	MD831			
39							FA209/2		FA209/2V	FA209/2HH	MD831			
40							FA214/2		FA214/2V	FA214/2HH	MD663	MD663C	VR663	
41							FA214/2		FA214/2V	FA214/2HH	MD663	MD663C	VR663	
42							FA140		FA140V	FA140HH	MD663	MD663C	VR663	
43							FA140		FA140V	FA140HH	MD820	MD820C		
44							FA140		FA140V	FA140HH	MD663	MD663C	VR663	
45							FA140		FA140V	FA140HH	MD820	MD820C		
46							FA140		FA140V	FA140HH	MD820	MD820C		
47							FA140		FA140V	FA140HH	MD820	MD820C		
48							FA140		FA140V	FA140HH	MD820	MD820C		
49							FA140		FA140V	FA140HH	MD820	MD820C		
50							FA140		FA140V	FA140HH	MD820	MD820C		
51							FA140		FA140V	FA140HH	MD820	MD820C		
52							FA140		FA140V	FA140HH	MD820	MD820C		
53							FA140		FA140V	FA140HH	MD820	MD820C		
54							FA140		FA140V	FA140HH	MD820	MD820C		
55							FA140		FA140V	FA140HH	MD820	MD820C		
56							FA215/2		FA215/2V	FA215/2HH	MD645			
57														
58							FA196		FA196V	FA196HH	MD643		VR643	
59							FA196		FA196V	FA196HH	MD643		VR643	
60							FA140		FA140V	FA140HH	MD820	MD820C		

REAR / ARRIÈRE / HINTEN / POSTERIOR / POSTERIORE

R Suffix = High Durability Sintered Pad. HH Suffix = High Performance Sintered Pad. TT Suffix = Hard Wearing Off Road Pad. V Suffix = Semi Sintered Pad. G Suffix = Grooved Shoe.
D Suffix = Drilled Disc. X Suffix = Universal Left or Right Disc. XC Suffix = Contoured Disc. LS Suffix = Left/Steel Disc. RS = Right/Steel Disc.

*-2 Sets Required. † For Vee disc colours add RED, BLU, GRN, GLD, ORG suffix to part number.
⊗ - Also available as a Vintage Motorcycle Disc.

Part numbers, prefixes, suffixes, photos and illustrations shown in this catalogue are trademarks and/or copyrights of EBC Brakes or the trademark owner A C Freeman Investments Ltd and use without express written permission of the owners is punishable by law.

Non-JAPANESE Built Motorcycles



TRIUMPH Contd. (HINCKLEY PRODUCED MACHINES)



DISC PAD CHOICES - FRONT

BRAKE DISC CHOICES - FRONT

FA, SFA, TT Pad or Brake Shoe	SFAC Carbon Scooter Pads	Speciality Pads - SXR / Vee / MXS	Sintered/HH Pads/ Grooved Shoes	Left / Gauche / Links Standard Replacement Disc	Right / Droite / Rechts Standard Replacement Disc	Contour Disc Universal left and right fitment	Universal Custom Disc	Vee-Discs Black † See note below	CX Extreme MX Race Disc/ UTVX Disc
Tiger 900 GT			FA447HH*	MD842X	MD842X	MD8008XC*			
Tiger 900 GT Low			FA447HH*	MD842X	MD842X	MD8008XC*			
Tiger 900 GT Pro			FA447HH*	MD842X	MD842X	MD8008XC*			
Tiger 900 Rally			FA447HH*	MD842X	MD842X	MD8008XC*			
Tiger 900 Rally Pro			FA447HH*	MD842X	MD842X	MD8008XC*			
Tiger 955cc (Spoke wheel) up to VIN 198874	00-04	FA196*	FA196HH*	MD649	MD649				MD649CX*
Tiger 955cc (Spoke wheel) up to VIN 198874 - Floating Disc Conversion	00-04	FA196*	FA196HH*	MD601LS	MD601RS				MD649CX*
Tiger 955 (Cast wheel) from VIN 198875	04-06	FA196*	FA196V*	FA196HH*	MD676	MD676			
Tiger 1050 (Radial caliper)	07-11		FA347HH*	MD679X	MD679X	MD679XC*		VR679BLK*	
Tiger Sport (ABS) 1050cc	13-21		FA347HH*	MD679X	MD679X	MD679XC*		VR679BLK*	
Tiger Sport (ABS) 1050cc	16-18		FA347HH*	MD679X	MD679X	MD679XC*		VR679BLK*	
Tiger SE (ABS) 1050cc	10-13		FA347HH*	MD679X	MD679X	MD679XC*		VR679BLK*	
Tiger 1200 XR	18-20		FA630V*	FA630HH*	MD842X	MD842X	MD842XC*	VR842BLK*	
Tiger 1200 XRx	18-20		FA630V*	FA630HH*	MD842X	MD842X	MD842XC*	VR842BLK*	
Tiger 1200 XRx Low	18-20		FA630V*	FA630HH*	MD842X	MD842X	MD842XC*	VR842BLK*	
Tiger 1200 XRt	18-20		FA630V*	FA630HH*	MD842X	MD842X	MD842XC*	VR842BLK*	
Tiger 1200 Xca	18-20		FA630V*	FA630HH*	MD842X	MD842X	MD842XC*	VR842BLK*	
Tiger 1200 Xcx	18-20		FA630V*	FA630HH*	MD842X	MD842X	MD842XC*	VR842BLK*	
Tiger Explorer 1200	12-15	FA236*	FA236HH*	MD842X	MD842X	MD842XC*		VR842BLK*	
Tiger Explorer XC 1200	13-15	FA236*	FA236HH*	MD842X	MD842X	MD842XC*		VR842BLK*	
Tiger Explorer XC (1215cc)	16-21		FA630V*	FA630HH*	MD842X	MD842X	MD842XC*	VR842BLK*	
Tiger Explorer XCx/XCx Low (1215cc)	16-21		FA630V*	FA630HH*	MD842X	MD842X	MD842XC*	VR842BLK*	
Tiger Explorer XCa (1215cc)	16-21		FA630V*	FA630HH*	MD842X	MD842X	MD842XC*	VR842BLK*	
Tiger Explorer XR(1215cc)	16-21		FA630V*	FA630HH*	MD842X	MD842X	MD842XC*	VR842BLK*	
Tiger Explorer XRx/XRx Low (1215cc)	16-21		FA630V*	FA630HH*	MD842X	MD842X	MD842XC*	VR842BLK*	
Tiger Explorer XRt (1215cc)	16-21		FA630V*	FA630HH*	MD842X	MD842X	MD842XC*	VR842BLK*	
Trident 660cc	21	FA226	FA226HH*						
Trident 750	Left 92-98	FA214	FA214V	FA214HH	MD646LS			VR646BLK*	
	Right	FA215	FA215V	FA215HH		MD646RS			
Trident 900	Left 92-98	FA214	FA214V	FA214HH	MD646LS			VR646BLK*	
	Right	FA215	FA215V	FA215HH		MD646RS			
Trophy 900 (3 cyl) (up to VIN 9082)	Left 92-93	FA214	FA214V	FA214HH	MD646LS			VR646BLK*	
	Right	FA215	FA215V	FA215HH		MD646RS			
Trophy 900 (3 cyl) (From VIN 9083)	94-01	FA236*	FA236HH*	MD640	MD640			VR640BLK*	
Trophy 1200 (4 cyl) (up to VIN 4901)	Left 92-93	FA214	FA214V	FA214HH	MD646LS			VR646BLK*	
	Right	FA215	FA215V	FA215HH		MD646RS			
Trophy 1200 (4 cyl) (From VIN 4902)	94-01	FA236*	FA236HH*	MD640	MD640			VR640BLK*	
Thruxton R 1200 (Liquid Cooled)	16-20		FA447HH*	MD883X	MD883X	MD883XC*			
Thruxton 1200 (Liquid Cooled)	16-20	FA142*	FA142HH*	MD873	MD873				
Thruxton 1200 (Liquid Cooled) - Floating Disc Conversion	16-20	FA142*	FA142HH*	MD873X	MD873X				
Thruxton TFC 1200 (Liquid Cooled)	19-20		FA447HH*	MD883X	MD883X	MD883XC*			
Trophy 1215	12-16		FA423/4HH*	MD817X	MD817X	MD817XC*		VR817BLK*	
Trophy SE 1215	12-17		FA423/4HH*	MD817X	MD817X	MD817XC*		VR817BLK*	
URAL									
Cross With Sidecar (Brembo 2 Pin Pad Fixing)	11-12	FA244	FA244HH		N/A				
Ranger With Sidecar (Brembo 2 Pin Pad Fixing)	11-19	FA244	FA244HH		N/A				
Retro With Sidecar (Brembo 2 Pin Pad Fixing)	11-12	FA244	FA244HH		N/A				
Sportsman With Sidecar (Brembo 2 Pin Pad Fixing)	11-12	FA244	FA244HH		N/A				
Tourist With Sidecar (Brembo 2 Pin Pad Fixing)	11-12	FA244	FA244HH		N/A				
Ural T With Sidecar (Brembo 2 Pin Pad Fixing)	11-12	FA244	FA244HH		N/A				
All Sidecar Models With Drum Brakes	All Years								
Retro Solo (Brembo 2 Pin Pad Fixing)	11-12	FA244	FA244HH		N/A				
Solo ST (Brembo 2 Pin Pad Fixing)	11-12	FA244	FA244HH		N/A				
Wolf Solo (Brembo 2 Pin Pad Fixing)	11-12	FA244	FA244HH		N/A				

Line #

FRONT / AVANT / VORN / FRENTE / ANTERIORE

R Suffix = High Durability Sintered Pad. HH Suffix = High Performance Sintered Pad. TT Suffix = Hard Wearing Off Road Pad. V Suffix = Semi Sintered Pad. G Suffix = Grooved Shoe. D Suffix = Drilled Disc. X Suffix = Universal Left or Right Disc. XC Suffix = Contoured Disc. LS Suffix = Left/Steel Disc. RS Suffix = Right/Steel Disc.

*-2 Sets Required. † For Vee disc colours add RED, BLU, GRN, GLD, ORG suffix to part number.

⊗ - Also available as a Vintage Motorcycle Disc.

Non-JAPANESE Built Motorcycles

Line #	BRAKE DISC CHOICES - FRONT						DISC PAD CHOICES - REAR				BRAKE DISC CHOICES - REAR			
	Oversize 250 /280mm Disc Kit	OSX Oversize 250/280mm Disc Kit	Relocating Bracket for 250/ 280mm Disc	Oversize 320mm Disc Kit	SMX Oversize 320mm Disc Kit	Relocating Bracket for 320mm Disc	FA, SFA, TT Pad or Brake Shoe	SFAC Carbon Scooter Pads	Speciality Pads - SXR / Vee / MXS	Sintered/ HH Pads/ Grooved Shoes	Standard Replacement Disc	Contour Disc Rear fitment	Vee-Discs™ CONTOUR	CX Extreme MX Race Disc/ UTVX Disc
1							FA140		FA140V	FA140HH	MD820	MD820C		
2							FA140		FA140V	FA140HH	MD820	MD820C		
3							FA140		FA140V	FA140HH	MD820	MD820C		
4							FA140		FA140V	FA140HH	MD820	MD820C		
5							FA140		FA140V	FA140HH	MD820	MD820C		
6							FA196		FA196V	FA196HH	MD643		VR643	
7														
8							FA196		FA196V	FA196HH	MD643		VR643	
9							FA215/2		FA215/2V	FA215/2HH	MD677			
10							FA215/2		FA215/2V	FA215/2HH	MD663	MD663C	VR663	
11							FA214/2		FA214/2V	FA214/2HH	MD820	MD820C		
12							FA214/2		FA214/2V	FA214/2HH	MD820	MD820C		
13							FA215/2		FA215/2V	FA215/2HH	MD663	MD663C	VR663	
14							FA228			FA228HH	MD863			
15							FA228			FA228HH	MD863			
16							FA228			FA228HH	MD863			
17							FA228			FA228HH	MD863			
18							FA228			FA228HH	MD863			
19							FA228			FA228HH	MD863			
20							FA214/2		FA214/2V	FA214/2HH	MD863			
21							FA214/2		FA214/2V	FA214/2HH	MD863			
22							FA228			FA228HH	MD863			
23							FA228			FA228HH	MD863			
24							FA228			FA228HH	MD863			
25							FA228			FA228HH	MD863			
26							FA228			FA228HH	MD863			
27							FA228			FA228HH	MD863			
28							FA140		FA140V	FA140HH				
29							FA215/2		FA215/2V	FA215/2HH	MD641		VR641	
30														
31							FA215/2		FA215/2V	FA215/2HH	MD641		VR641	
32														
33							FA215/2		FA215/2V	FA215/2HH	MD641		VR641	
34														
35							FA215/2		FA215/2V	FA215/2HH	MD641		VR641	
36							FA215/2		FA215/2V	FA215/2HH	MD641		VR641	
37														
38							FA215/2		FA215/2V	FA215/2HH	MD641		VR641	
39							FA214/2		FA214/2V	FA214/2HH	MD851	MD851C		
40							FA214/2		FA214/2V	FA214/2HH	MD851			
41														
42							FA214/2		FA214/2V	FA214/2HH	MD851			
43							FA214/2		FA214/2V	FA214/2HH	MD851			
44							FA228			FA228HH	MD863			
45							FA228			FA228HH	MD863			
46														
47														
48							N/A							
49							FA473		FA473V					
50							N/A							
51							N/A							
52							N/A							
53							N/A							
54							N/A							
55							N/A							
56							N/A							
57							N/A							
58														
59														
60														

REAR / ARRIÈRE / HINTEN / POSTERIOR / POSTERIORE

R Suffix = High Durability Sintered Pad. **HH** Suffix = High Performance Sintered Pad. **TT** Suffix = Hard Wearing Off Road Pad. **V** Suffix = Semi Sintered Pad. **G** Suffix = Grooved Shoe.
D Suffix = Drilled Disc. **X** Suffix = Universal Left or Right Disc. **XC** Suffix = Contoured Disc. **LS** Suffix = Left/Steel Disc. **RS** = Right/Steel Disc.

BRAKE APPLICATIONS

*-2 Sets Required. † For Vee disc colours add RED, BLU, GRN, GLD, ORG suffix to part number.
 Ⓢ - Also available as a Vintage Motorcycle Disc.

Non-JAPANESE Built Motorcycles



VECTRIX



VT-1	14
VX-1 (Li/NiMh)	07-14
VX-2	12-14
VX-3 (3 Wheel Model)	12-13
VX-3 (3 Wheel Model) - Parking brake	12-13

VERTEMATI

All models with 2 piston Brembo calipers	99-04
All models with 4 piston Beringher/Ergal calipers	99-04

VESPA

S50 (2T)	07-13
S50 (4T/4V)	08-13
S50 Sport (2T)	11-13
S50 Sport (4T/4V)	11-13
50 R	70-83
50 S	75-83
50 Special Edition	91
50 S	68
LX 50 (2T)	05-13
LX 50 (4T/4V)	05-13
LXV 50	07-09
PK 50	82-85
PK 50 S	82-85
PK 50 SS	83-85
PK 50 S Automatica	84-89
PK 50 XL	85-88
PK 50 XL	88-89
Primavera 50 (2T)	13-21
Primavera 50 Touring (2T)	15
Primavera 50 (4T/4V)	13-15
Primavera 50 Touring (4T/4V)	15
50 N	89-90
FL 50	90
FL2 Automatica	90-91
ET 2 (50cc)	97-05
ET 4 (50cc) (Grimeca Caliper)	00-04
ET 4 (50cc) (Heng Tong Caliper)	00-04
Sprint 50 (2T)	14-15
Sprint 50 (4T/3V)	14-20
Sprint S 50 (2T)	15
GT 60 (Special Anniversary Model) (GTV 250)	06
LX 60 (Special Anniversary Model)	06
PK 100 XL	78-83
FL 125	89-00
GT 125 Granturismo (Grimeca caliper)	03-06
GT 125 Granturismo (Heng Tong caliper)	03-06
GTS 125	07-11
GTS 125 Super ie (inc ABS Models)	10-21
GTS 125 Supersport ie (inc ABS Models)	13-21
GTS 4V ABS/Super Sport/Touring	18-21
GTS 4V ABS	18-20
GTV 125	07-09
LXV 125	07-12
S 125 (4T/3V)	07-13
S 125 Sport (4T/3V)	11-13
ET4 125	96-99
ET4 125/150	99-05
125 Primavera	67-83
125 ET3	76-83

DISC PAD CHOICES - FRONT				BRAKE DISC CHOICES - FRONT						Line #
FA, SFA, TT Pad or Brake Shoe	SFAC Carbon Scooter Pads	Speciality Pads - SXR / Vee / MXS	Sintered/HH Pads/ Grooved Shoes	Left / Gauche / Links Standard Replacement Disc	Right / Droite / Rechts Standard Replacement Disc	Contour Disc Universal left and right filament	Universal Custom Disc	Vee-Discs Black † See note below	CX Extreme MX Race Disc/ UTVX Disc	
SFA228	SFAC228		SFA228HH							1
SFA181	SFAC181		SFA181HH		MD995D			VR995		2
SFA086	SFAC086		SFA086HH		N/A					3
SFA266*	SFAC266*		SFA266HH*	N/A	N/A					4
SFA257/2										5
										6
										7
FA181TT		MXS181	FA181R	N/A						8
FA158			FA158HH	N/A						9
										10
										11
SFA260	SFAC260		SFA260HH	MD910D		MD910C		VR910		12
SFA260	SFAC260		SFA260HH	MD910D		MD910C		VR910		13
SFA260	SFAC260		SFA260HH	MD910D		MD910C		VR910		14
SFA260	SFAC260		SFA260HH	MD910D		MD910C		VR910		15
V905										16
V905										17
V905										18
V905										19
SFA260	SFAC260		SFA260HH	MD910D		MD910C		VR910		20
SFA260	SFAC260		SFA260HH	MD910D		MD910C		VR910		21
SFA260	SFAC260		SFA260HH	MD956D				VR956		22
V905										23
V905										24
V905										25
V905										26
V905										27
V903										28
SFA353	SFAC353		SFA353HH	MD910D		MD910C		VR910		29
SFA353	SFAC353		SFA353HH	MD910D		MD910C		VR910		30
SFA353	SFAC353		SFA353HH	MD910D		MD910C		VR910		31
SFA353	SFAC353		SFA353HH	MD910D		MD910C		VR910		32
V903										33
V903										34
V903										35
SFA260	SFAC260		SFA260HH	MD910D		MD910C		VR910		36
SFA260	SFAC260		SFA260HH	MD910D		MD910C		VR910		37
SFA260	SFAC260		SFA260HH	MD910D		MD910C		VR910		38
SFA353	SFAC353		SFA353HH	MD910D				VR910		39
SFA353	SFAC353		SFA353HH	MD910D				VR910		40
SFA353	SFAC353		SFA353HH	MD910D				VR910		41
SFA353	SFAC353		SFA353HH	MD956D				VR956		42
SFA186	SFAC186			MD910D		MD910C		VR910		43
V905										44
V903										45
SFA194	SFAC194		SFA194HH	MD956D				VR956		46
SFA353	SFAC353		SFA353HH	MD956D				VR956		47
SFA353	SFAC353		SFA353HH	MD956D				VR956		48
SFA353	SFAC353		SFA353HH	MD956D				VR956		49
SFA353	SFAC353		SFA353HH	MD956D				VR956		50
SFA353			SFA353HH							51
SFA353			SFA353HH							52
SFA353	SFAC353		SFA353HH	MD956D				VR956		53
SFA260	SFAC260		SFA260HH	MD956D				VR956		54
SFA260	SFAC260		SFA260HH	MD910D		MD910C		VR910		55
SFA260	SFAC260		SFA260HH	MD910D		MD910C		VR910		56
SFA260	SFAC260		SFA260HH	MD910D		MD910C		VR910		57
SFA260	SFAC260		SFA260HH	MD910D		MD910C		VR910		58
V905										59
V905										60

FRONT / AVANT / VORN / FRENTE / ANTERIORE

R Suffix = High Durability Sintered Pad. HH Suffix = High Performance Sintered Pad. TT Suffix = Hard Wearing Off Road Pad. V Suffix = Semi Sintered Pad. G Suffix = Grooved Shoe.

D Suffix = Drilled Disc. X Suffix = Universal Left or Right Disc. LS Suffix = Left/Steel Disc. RS = Right/Steel Disc.

*-2 Sets Required. † For Vee disc colours add RED, BLU, GRN, GLD, ORG suffix to part number.

⊗ - Also available as a Vintage Motorcycle Disc.

Non-JAPANESE Built Motorcycles

Line #	BRAKE DISC CHOICES - FRONT						DISC PAD CHOICES - REAR				BRAKE DISC CHOICES - REAR			
	Oversize 250 /280mm Disc Kit	OSX Oversize 250/280mm Disc Kit	Relocating Bracket for 250/ 280mm Disc	Oversize 320mm Disc Kit	SMX Oversize 320mm Disc Kit	Relocating Bracket for 320mm Disc	FA, SFA, TT Pad or Brake Shoe	SFAC Carbon Scooter Pads	Speciality Pads - SXR / Vee / MXS	Sintered/ HH Pads/ Grooved Shoes	Standard Replacement Disc	Contour Disc Rear fitment	Vee-Discs™ CONTOUR	CX Extreme MX Race Disc/ UTVX Disc
1							SFA067	SFAC067		SFA067HH	N/A			
2							SFA181	SFAC181		SFA181HH	MD9139D		VR9139	
3							SFA083	SFAC083		SFA083HH	N/A			
4							SFA181	SFAC181		SFA181HH	N/A			
5														
6														
7														
8							FA208TT		MXS208	FA208R	N/A			
9							FA208TT		MXS208	FA208R	N/A			
10														
11														
12							899							
13							899							
14							899							
15							899							
16							V906							
17							V904							
18							V906							
19							V906							
20							899							
21							899							
22							899							
23							V903							
24							V903							
25							V903							
26							V942							
27							V903							
28							V903							
29							816							
30							816							
31							816							
32							816							
33							V903							
34							V903							
35							V942							
36							899							
37							899							
38							899							
39							816							
40							816							
41							816							
42							SFA321 ★	SFAC321		SFA321HH	MD956D		VR956	
43							V903							
44							V906							
45							V903							
46							SFA321 ★	SFAC321		SFA321HH	MD956D		VR956	
47							SFA321 ★	SFAC321		SFA321HH	MD956D		VR956	
48							SFA321 ★	SFAC321		SFA321HH	MD956D		VR956	
49							SFA321 ★	SFAC321		SFA321HH	MD956D		VR956	
50							SFA321 ★	SFAC321		SFA321HH	MD956D		VR956	
51							SFA321 ★	SFAC321		SFA321HH			VR956	
52							SFA321 ★	SFAC321		SFA321HH		SFA321HH		
53							SFA321 ★	SFAC321		SFA321HH	MD956D		VR956	
54							899							
55							899							
56							899							
57							899							
58							899							
59							V904							
60							V904							

REAR / ARRIÈRE / HINTEN / POSTERIOR / POSTERIORE

R Suffix = High Durability Sintered Pad. **HH** Suffix = High Performance Sintered Pad. **TT** Suffix = Hard Wearing Off Road Pad. **V** Suffix = Semi Sintered Pad. **G** Suffix = Grooved Shoe.
D Suffix = Drilled Disc. **X** Suffix = Universal Left or Right Disc. **XC** Suffix = Contoured Disc. **LS** Suffix = Left/Steel Disc. **RS** = Right/Steel Disc.

*-2 Sets Required. † For Vee disc colours add RED, BLU, GRN, GLD, ORG suffix to part number.
 ☉ - Also available as a Vintage Motorcycle Disc.

Part numbers, prefixes, suffixes, photos and illustrations shown in this catalogue are trademarks and/or copyrights of EBC Brakes or the trademark owner A C Freeman Investments Ltd and use without express written permission of the owners is punishable by law.

Non-JAPANESE Built Motorcycles



VESPA Contd.



DISC PAD CHOICES - FRONT

BRAKE DISC CHOICES - FRONT

R Suffix = High Durability Sintered Pad. **HH** Suffix = High Performance Sintered Pad. **TT** Suffix = Hard Wearing Off Road Pad. **V** Suffix = Semi Sintered Pad. **G** Suffix = Grooved Shoe.

D Suffix = Drilled Disc. **X** Suffix = Universal Left or Right Disc. **XC** Suffix = Contoured Disc. **LS** Suffix = Left/Steel Disc. **RS** = Right/Steel Disc.

Model	Year	FA, SFA, TT Pad or Brake Shoe	SFAC Carbon Scooter Pads	Speciality Pads - SXR / Vee / MXS	Sintered/HH Pads/ Grooved Shoes	Left / Gauche / Links Standard Replacement Disc	Right / Droite / Rechts Standard Replacement Disc	Contour Disc Universal left and right fitment	Universal Custom Disc	Vee-Discs Black † See note below	CX Extreme MX Race Disc/ UTVX Disc	Line #
LX 125 (4T/3V)	05-13	SFA260	SFAC260		SFA260HH	MD910D		MD910C		VR910		1
LX 125 (Serie Speciali/4T)	12	SFA260	SFAC260		SFA260HH	MD910D		MD910C		VR910		2
Primavera 125 (4T/3V/ABS)	13-20	SFA353	SFAC353		SFA353HH	TBA						3
Primavera 125 (4T/3V/Non ABS)	13-21	SFA353	SFAC353		SFA353HH	MD910D		MD910C		VR910		4
Primavera 125 Touring (4T/3V/Non ABS)	15	SFA353	SFAC353		SFA353HH	MD910D		MD910C		VR910		5
Primavera 125 Touring (4T/3V/ABS)	15-21	SFA353	SFAC353		SFA353HH	MD910D		MD910C		VR910		6
PX 125 E/EFL	81-97	V903										7
PK 125	82-85	V903										8
PK 125 S	82-85	V903										9
PK 125 S Automatica	84-89	V903										10
PX 125 T5	85-00	V903										11
PX 125 (Disc Brake Model/2T)	98-30/04/11	SFA186	SFAC186				MD910D			VR910		12
PX 125 (Disc Brake Model/2T)	01/05/11-16	SFA260	SFAC260		SFA260HH		MD910D			VR910		13
PX 125 Touring	15	SFA186	SFAC186				MD910D	MD910C		VR910		14
946 Special - (125cc/4T/3V)	13-15	SFA353	SFAC353		SFA353HH	TBA						15
Sprint 125 (4T/3V/ABS)	15-21	SFA353	SFAC353		SFA353HH	TBA						16
Sprint S 125 (4T/3V/ABS)	15-20	SFA353	SFAC353		SFA353HH	MD910D				VR910		17
Sprint S 125 (4T/3V/Non ABS)	15-20	SFA353	SFAC353		SFA353HH	MD910D				VR910		18
★ See SFA681 if rear pad SFA321 is incorrect shape -												
ONLY AVAILABLE AS SFA ORGANIC VERSION.												
LX 150 (4T/3V)	05-13	SFA260	SFAC260		SFA260HH	MD910D		MD910C		VR910		20
LX 150 (Serie Speciali/4T)	12	SFA260	SFAC260		SFA260HH	MD910D		MD910C		VR910		21
Primavera 150 (4T/3V/ABS)	13-20	SFA353	SFAC353		SFA353HH	TBA						22
Primavera 150 (4T/3V/Non ABS)	13-15	SFA353	SFAC353		SFA353HH	MD910D		MD910C		VR910		23
Primavera 150 Touring (4T/3V/Non ABS)	15	SFA353	SFAC353		SFA353HH	MD910D		MD910C		VR910		24
Primavera 150 Touring (4T/3V/ABS)	15	SFA353	SFAC353		SFA353HH	MD910D		MD910C		VR910		25
PX 150 E/EFL	81-97	V903										26
PX 150 (Disc Brake Model)	98-15	SFA186	SFAC186				MD910D	MD910C		VR910		27
PX 150 Touring	15	SFA186	SFAC186				MD910D	MD910C		VR910		28
S 150 (4T)	07-12	SFA260	SFAC260		SFA260HH	MD910D		MD910C		VR910		29
S 150 Sport (4T)	11-12	SFA260	SFAC260		SFA260HH	MD910D		MD910C		VR910		30
Sprint S 150 (4T/3V/ABS)	15-20	SFA353	SFAC353		SFA353HH	MD910D				VR910		31
GT 200 L Granturismo (Grimeca Caliper)	03-06	SFA194	SFAC194		SFA194HH	MD956D				VR956		32
GT 200 L Granturismo (Heng Tong Caliper)	03-06	SFA353	SFAC353		SFA353HH	MD956D				VR956		33
PX 200 E/EFL	81-97	V903										34
PX 200 (Disc Brake Model)	98-07	SFA186	SFAC186				MD910D	MD910C		VR910		35
GTS 250 ie/ABS	05-11	SFA353	SFAC353		SFA353HH	MD956D				VR956		36
GTV 250 ie	07-09	SFA353	SFAC353		SFA353HH	MD956D				VR956		37
GTS 300 ie (Non ABS Models)	08-15	SFA353	SFAC353		SFA353HH	MD956D				VR956		38
GTS 300 ie (ABS Models)	08-20	SFA353	SFAC353		SFA353HH	MD956D				VR956		39
GTS 300 ie Super (Non ABS Models)	08-15	SFA353	SFAC353		SFA353HH	MD956D				VR956		40
GTS 300 ie Super (ABS Models)	08-21	SFA418	SFAC418		SFA418HH	MD956D				VR956		41
GTS 300 ie Super Sport (ABS Models)	10-15	SFA353	SFAC353		SFA353HH	MD956D				VR956		42
GTS 300 ie Super Sport (ABS Models)	08-18	SFA418	SFAC418		SFA418HH	MD956D				VR956		43
GTS 300 ie Touring (Non ABS)	11-16	SFA353	SFAC353		SFA353HH	MD956D				VR956		44
GTS 300 ie Touring (ABS Models)	11-21	SFA353	SFAC353		SFA353HH	MD956D				VR956		45
GTV 300 (4T/4V)	10-13	SFA353	SFAC353		SFA353HH	MD956D				VR956		46
Elettrica 25KM/H	19-20	SFA260	SFAC260									47
Elettrica Motociclo 70KM/H	19-20	SFA260	SFAC260									48
GTS 300 HPE IE 4T/4V ABS E5	20-21	SFA418	SFAC418		SFA418HH	MD956D				VR956		49
GTV 300 Sei Giorni IE E4 ABS Models (MA3602)	20-21	SFA418	SFAC418		SFA418HH	MD956D				VR956		50
★ See SFA681 if rear pad SFA321 is incorrect shape -												
ONLY AVAILABLE AS SFA ORGANIC VERSION.												
VIALLI												
Cargo 50	06	SFA169	SFAC169		SFA169HH	TBA						54
DXB 50	06	SFA228	SFAC228		SFA228HH	TBA						55
Fireforce 50	06	SFA228	SFAC228		SFA228HH	TBA						56
FXR Sport 50	06	SFA169	SFAC169		SFA169HH	TBA						57
Jupiter 50	06	SFA169	SFAC169		SFA169HH	TBA						58
RX Sport 50	06	SFA083	SFAC083		SFA083HH	TBA						59
Truro 50	06	SFA086	SFAC086		SFA086HH		TBA					60

FRONT / AVANT / VORN / FRENTE / ANTERIORE

*-2 Sets Required. † For Vee disc colours add RED, BLU, GRN, GLD, ORG suffix to part number.

⊗ - Also available as a Vintage Motorcycle Disc.

Non-JAPANESE Built Motorcycles

Line #	BRAKE DISC CHOICES - FRONT						DISC PAD CHOICES - REAR				BRAKE DISC CHOICES - REAR			
	OverSize 250 /280mm Disc Kit	OSX OverSize 250/280mm Disc Kit	Relocating Bracket for 250/ 280mm Disc	OverSize 320mm Disc Kit	SMX OverSize 320mm Disc Kit	Relocating Bracket for 320mm Disc	FA, SFA, TT Pad or Brake Shoe	SFAC Carbon Scooter Pads	Speciality Pads - SXR / Vee / MXS	Sintered/ HH Pads/ Grooved Shoes	Standard Replacement Disc	Contour Disc Rear fitment	Vee-Discs™ CONTOUR	CX Extreme MX Race Disc/ UTVX Disc
1							899							
2							899							
3							816							
4							816							
5							816							
6							816							
7							V903							
8							V903							
9							V903							
10							V942							
11							V903							
12							V903							
13							V903							
14							V903							
15							SFA321 ★	SFAC321		SFA321HH	TBA			
16							816							
17							816							
18							816							
19														
20							899							
21							899							
22							816							
23							816							
24							816							
25							816							
26							V903							
27							V903							
28							V903							
29							899							
30							899							
31							816							
32							SFA321 ★	SFAC321		SFA321HH	MD956D	VR956		
33							SFA321 ★	SFAC321		SFA321HH	MD956D	VR956		
34							V903							
35							V903							
36							SFA321 ★	SFAC321		SFA321HH	MD956D	VR956		
37							SFA321 ★	SFAC321		SFA321HH	MD956D	VR956		
38							SFA321 ★	SFAC321		SFA321HH	MD956D	VR956		
39							SFA321 ★	SFAC321		SFA321HH	MD956D	VR956		
40							SFA321 ★	SFAC321		SFA321HH	MD956D	VR956		
41							SFA321 ★	SFAC321		SFA321HH	MD956D	VR956		
42							SFA321 ★	SFAC321		SFA321HH	MD956D	VR956		
43							SFA321 ★	SFAC321		SFA321HH	MD956D	VR956		
44							SFA321 ★	SFAC321		SFA321HH	MD956D	VR956		
45							SFA321 ★	SFAC321		SFA321HH	MD956D	VR956		
46							SFA321 ★	SFAC321		SFA321HH	MD956D	VR956		
47														
48														
49							SFA321 ★	SFA681	SFAC321	SFA321HH				
50							SFA321 ★	SFA681	SFAC321	SFA321HH				
51														
52														
53														
54							TBA							
55							TBA							
56							TBA							
57							TBA							
58							TBA							
59							TBA							
60							TBA							

REAR / ARRIÈRE / HINTEN / POSTERIOR / POSTERIORE

R Suffix = High Durability Sintered Pad. HH Suffix = High Performance Sintered Pad. TT Suffix = Hard Wearing Off Road Pad. V Suffix = Semi Sintered Pad. G Suffix = Grooved Shoe.
D Suffix = Drilled Disc. X Suffix = Universal Left or Right Disc. XC Suffix = Contoured Disc. LS Suffix = Left/Steel Disc. RS = Right/Steel Disc.

*-2 Sets Required. † For Vee disc colours add RED, BLU, GRN, GLD, ORG suffix to part number.
⊗ - Also available as a Vintage Motorcycle Disc.

Part numbers, prefixes, suffixes, photos and illustrations shown in this catalogue are trademarks and/or copyrights of EBC Brakes or the trademark owner A C Freeman Investments Ltd and use without express written permission of the owners is punishable by law.

Non-JAPANESE Built Motorcycles



VOR



All models with 2 piston Brembo calipers	99-02
All models with 4 piston Ergal calipers	02
EN 450/530 Enduro	03-04
EN-E 450/530 Enduro	03-04
SM-E 450/530	03-04
MX 450/530	03-04

VOXAN

Black Magic	04-08
Street Scrambler	03-05
Street Scrambler	07-08
VB1 Evo	03-04
Cyclope 1000	02
Scrambler 1000	06
Café Racer 1000	02-05
Café Racer	06-08
Roadster 1000	02-05
Roadster	06-08
Charade Racing	06
Charade Racing (Beringer Caliper)	07-08
GTV 1200	08

WK BIKES

Bellissima 50 (4T)	13-15
Mii 50 (4T)	13-15
SM 50	11-12
SP 50 (4T)	13
WK Go 50 (4T)	11-15
WK One 50 (2T)	10-12
WK GP 2 (2T/50cc)	10-14
WK GTR 50 (2T)	10-14
VS 50 (4T/Scooter)	13-15
Wasp R 50 (2T)	13-15
Bellissima 125 (4T)	13-15
Trail 125	11-15
VS 125 (4T/Scooter)	13-15
Wasp 125 (4T)	13-15
WK 125 Cruiser	15
WK 125 C (4T/16" Wheels)	10-15
WK 125 SC (4T/14" Wheels)	10-14
WK 125 R (4T)	10-15
WK 125 Sport (4T)	11-15
125 RR	12-13
RT 125	15
SP 125 N (4T)	13-15
Tomcat 125 (4T)	15
150 NK	15
SP 250 N (4T)	15
WK Jetmax 250 (4T)	Left 10-14 Right
GTR 300 (Scooter)	13-15
WK 400 Trail	15-17
450 RX Enduro	14
450 RX Supermoto	14
650i (Naked)	Left 13-15 Right
650 TR (Touring)	Left 13-15 Right

DISC PAD CHOICES - FRONT				BRAKE DISC CHOICES - FRONT						Line #
FA, SFA, TT Pad or Brake Shoe	SFAC Carbon Scooter Pads	Speciality Pads - SXR / Vee / MXS	Sintered/HH Pads/ Grooved Shoes	Left / Gauche / Links Standard Replacement Disc	Right / Droite / Rechts Standard Replacement Disc	Contour Disc Universal left and right filament	Universal Custom Disc	Vee-Discs Black † See note below	CX Extreme MX Race Disc/ UTVX Disc	Line #
FA181TT		MXS181	FA181R	N/A						1
TBA			TBA	N/A						2
FA181TT		MXS181	FA181R	N/A						3
FA181TT		MXS181	FA181R	N/A						4
FA095			FA095HH	N/A						5
FA181TT		MXS181	FA181R	N/A						6
										7
										8
FA244*			FA244HH*	MD614X	MD614X	MD614XC*		VR614BLK*		9
FA095*			FA095HH*	MD614X	MD614X	MD614XC*		VR614BLK*		10
FA244			FA244HH	MD614X	MD614X	MD614XC*		VR614BLK*		11
FA244*			FA244HH*	MD614X	MD614X	MD614XC*		VR614BLK*		12
FA095*			FA095HH*	N/A	N/A					13
FA142*			FA142HH*	N/A	N/A					14
FA095*			FA095HH*	MD614X	MD614X	MD614XC*		VR614BLK*		15
FA244*			FA244HH*	MD614X	MD614X	MD614XC*		VR614BLK*		16
FA095*			FA095HH*	MD614X	MD614X	MD614XC*		VR614BLK*		17
FA244*			FA244HH*	MD614X	MD614X	MD614XC*		VR614BLK*		18
			FA322/4HH*	N/A	N/A					19
TBA*			MXS405*	N/A	N/A					20
			FA322/4HH*	TBA	TBA					21
										22
										23
SFA086	SFAC086		SFA086HH	N/A						24
SFA235	SFAC235					N/A				25
FA115			FA115HH			N/A				26
FA095			FA095HH			N/A				27
SFA086	SFAC086		SFA086HH			N/A				28
SFA235	SFA235					N/A				29
SFA235	SFA235					N/A				30
SFA266	SFAC266		SFA266HH	N/A						31
SFA086	SFAC086		SFA086HH	N/A						32
SFA086	SFAC086		SFA086HH			N/A				33
SFA086	SFAC086		SFA086HH	N/A						34
FA197			FA197HH			N/A				35
SFA086	SFAC086		SFA086HH	N/A						36
SFA086	SFAC086		SFA086HH	N/A						37
FA086*		FA086V*	FA086HH*	N/A	N/A					38
SFA228	SFAC228		SFA228HH	N/A						39
SFA228	SFAC228		SFA228HH	N/A						40
FA196			FA196HH	N/A						41
FA196			FA196HH	N/A						42
TBA*						N/A*				43
FA093				N/A						44
FA095		FA095V	FA095HH			N/A				45
FA086		FA086V	FA086HH	N/A						46
FA658		FA658V	FA658HH	N/A						47
FA095*		FA095V*	FA095HH*			N/A*				48
SFA228	SFAC228		SFA228HH	N/A	N/A					49
SFA197	SFAC197		SFA197HH							50
SFA086	SFAC086		SFA086HH	N/A						51
FA664						N/A				52
FA185TT		MXS185	FA185R			N/A				53
FA185TT		MXS185	FA185R			N/A				54
FA229			FA229HH			N/A*				55
FA231			FA231HH							56
FA229			FA229HH			N/A*				57
FA231			FA231HH							58
										59
										60

FRONT / AVANT / VORN / FRENTE / ANTERIORE

R Suffix = High Durability Sintered Pad. HH Suffix = High Performance Sintered Pad. TT Suffix = Hard Wearing Off Road Pad. V Suffix = Semi Sintered Pad. G Suffix = Grooved Shoe.
D Suffix = Drilled Disc. X Suffix = Universal Left or Right Disc. XC Suffix = Contoured Disc. LS Suffix = Left/Steel Disc. RS = Right/Steel Disc.

*-2 Sets Required. † For Vee disc colours add RED, BLU, GRN, GLD, ORG suffix to part number.

⊗ - Also available as a Vintage Motorcycle Disc.

Non-JAPANESE Built Motorcycles

Line #	BRAKE DISC CHOICES - FRONT						DISC PAD CHOICES - REAR				BRAKE DISC CHOICES - REAR			
	Oversize 250 /280mm Disc Kit	OSX Oversize 250/280mm Disc Kit	Relocating Bracket for 250/ 280mm Disc	Oversize 320mm Disc Kit	SMX Oversize 320mm Disc Kit	Relocating Bracket for 320mm Disc	FA, SFA, TT Pad or Brake Shoe	SFAC Carbon Scooter Pads	Speciality Pads - SXR / Vee / MXS	Sintered/ HH Pads/ Grooved Shoes	Standard Replacement Disc	Contour Disc Rear fitment	Vee-Discs™ CONTOUR	CX Extreme MX Race Disc/ UTVX Disc
1							FA208TT		MXS208	FA208R	N/A			
2							FA208TT		MXS208	FA208R	N/A			
3							FA208TT		MXS208	FA208R	N/A			
4							FA208TT		MXS208	FA208R	N/A			
5							FA208TT		MXS208	FA208R	N/A			
6							FA208TT		MXS208	FA208R	N/A			
7														
8														
9							FA266		FA266V	FA266HH	MD2002	MD2002C	VR2002	
10							FA266		FA266V	FA266HH	MD2002	MD2002C	VR2002	
11							FA266		FA266V	FA266HH	MD2002	MD2002C	VR2002	
12							FA266		FA266V	FA266HH	MD2002	MD2002C	VR2002	
13							FA266		FA266V	FA266HH	N/A			
14							FA165/2TT				N/A			
15							FA266		FA266V	FA266HH	MD2002	MD2002C	VR2002	
16							FA266		FA266V	FA266HH	MD2002	MD2002C	VR2002	
17							FA266		FA266V	FA266HH	MD2002	MD2002C	VR2002	
18							FA266		FA266V	FA266HH	MD2002	MD2002C	VR2002	
19							FA047			FA047HH	N/A			
20							FA047				FA047HH			
21							FA266		FA266V	FA266HH	TBA			
22														
23														
24							Y503							
25							Y503							
26							FA115			FA115HH		N/A		
27							TBA					N/A		
28							Y503							
29							Y503							
30							Y503							
31							SFA260	SFAC260		SFA260HH	N/A			
32							TBA							
33							SFA115	SFAC115		SFA115HH				
34							Y503							
35							TBA			FA367R		N/A		
36							TBA							
37							SFA197	SFAC197		SFA197HH				
38							FA086		FA086V	FA086HH		N/A		
39							SFA101	SFAC101		SFA101HH	N/A			
40							SFA266	SFAC266		SFA266HH	N/A			
41							FA197			FA197HH	N/A			
42							FA197			FA197HH	N/A			
43							FA256			FA256HH		N/A		
44							TBA					N/A		
45							TBA					N/A		
46							TBA							
47							TBA				N/A			
48							TBA					N/A		
49							SFA266	SFAC266		SFA266HH	N/A			
50														
51							SFA197	SFAC197		SFA197HH	N/A			
52							FA697					N/A		
53							FA368TT		MXS368	FA368R		N/A		
54							FA368TT		MXS368	FA368R		N/A		
55							FA192		FA192V	FA192HH		N/A		
56														
57							FA192		FA192V	FA192HH		N/A		
58														
59														
60														

REAR / ARRIÈRE / HINTEN / POSTERIOR / POSTERIORE

R Suffix = High Durability Sintered Pad. HH Suffix = High Performance Sintered Pad. TT Suffix = Hard Wearing Off Road Pad. V Suffix = Semi Sintered Pad. G Suffix = Grooved Shoe.
D Suffix = Drilled Disc. X Suffix = Universal Left or Right Disc. XC Suffix = Contoured Disc. LS Suffix = Left/Steel Disc. RS = Right/Steel Disc.

*-2 Sets Required. † For Vee disc colours add RED, BLU, GRN, GLD, ORG suffix to part number.
⊗ - Also available as a Vintage Motorcycle Disc.

Part numbers, prefixes, suffixes, photos and illustrations shown in this catalogue are trademarks and/or copyrights of EBC Brakes or the trademark owner A C Freeman Investments Ltd and use without express written permission of the owners is punishable by law.

Non-JAPANESE Built Motorcycles



W.T. MOTORS



Bilbao 50 (4T)	08-09
WT 500 Alaska Quad	08-09

WUYANG

WY 50 QT	06-07
WY 125-12	06-07
WY 125-16C	06-07
WY 125-24B	06-07

XISPA

X 125 R	08-09
X 250 R	08-09
X 280 R	08-09

XOR

XO 2 (4.0KW)	13-14
XO 2 (8.0KW)	13-14
Vogue 150 (3 wheeler)	08-09

ZONTES

Tiger 50 (4T)	14-15
ZT 125-3A Tiger	09-15
ZT 125-5A Monster	09-15
ZT 125-8A Panther	09-15
ZT 125 Firefly	17-19
ZT 125 Mantis	17-19
ZT 125 Scorpion	17-19
R 310	20
X 310	20
T 310	20
V 310	20

ZUNDAPP

CS 25 Mofa Bj (Type 448-140)	80-82
CS 25 Mofa Bj (Type 448-141)	82
CX 25 Mofa Bj (Type 448-151)	82
CX 25 Mofa Bj	83-84
CB 50 Mokick Bj (Type 448-011)	80
CS 50 Mokick Bj (Type 448-010)	79-80
CS 50 Mokick Bj (Type 448-013)	80-82
Hai 25 Mofa Bj (Type 448-150)	80-82
Hai 50 Mokick-Enduro Bj (Type 448-010)	80
Hai 50 Mokick-Enduro Bj (Type 448-111)	80-82
KS 50 Sport/Supersport	
KS 80/Touring	80-
KS 80 Super	83
KS 80 Super	84-
KS 100	
KS 125	-81
KS 125/KS 175	82-

DISC PAD CHOICES - FRONT				BRAKE DISC CHOICES - FRONT						Line #
FA, SFA, TT Pad or Brake Shoe	SFAC Carbon Scooter Pads	Speciality Pads - SXR / Vee / MXS	Sintered/HH Pads/ Grooved Shoes	Left / Gauche / Links Standard Replacement Disc	Right / Droite / Rechts Standard Replacement Disc	Contour Disc Universal left and right fitment	Universal Custom Disc	Vee-Discs Black † See note below	CX Extreme MX Race Disc/ UTVX Disc	Line #
FAA086	SFAC086		SFA086HH	N/A						1
FA453TT*			FA453R*	N/A	N/A					2
										3
										4
SFA169	SFAC169		SFA169HH	N/A						5
SFA093				N/A						6
SFA093				N/A						7
SFA197	SFAC197		SFA197HH	N/A						8
										9
										10
FA303TT				N/A						11
FA303TT				N/A						12
FA303TT				N/A						13
										14
SFA197	SFAC197		SFA197HH	N/A						15
SFA197	SFAC197		SFA197HH	N/A						16
FA486										17
										18
										19
										20
FA093				N/A						21
FA093				N/A						22
FA197			FA197HH		N/A	N/A				23
FA093				N/A						24
SFA727	SFAC727									25
SFA727	SFAC727									26
SFA727	SFAC727									27
FA142										28
FA142										29
FA142										30
FA142										31
										32
										33
976										34
976										35
976										36
976										37
976										38
976										39
976										40
976										41
976										42
976										43
FA050				N/A						44
FA050				N/A						45
FA060				N/A						46
FA099				N/A						47
FA050				N/A						48
FA076			FA076HH	N/A						49
FA018			FA018HH	N/A						50
										51
										52
										53
										54
										55
										56
										57
										58
										59
										60

FRONT / AVANT / VORN / FRENTE / ANTERIORE

R Suffix = High Durability Sintered Pad. HH Suffix = High Performance Sintered Pad. TT Suffix = Hard Wearing Off Road Pad. V Suffix = Semi Sintered Pad. G Suffix = Grooved Shoe.
D Suffix = Drilled Disc. X Suffix = Universal Left or Right Disc. XC Suffix = Contoured Disc. LS Suffix = Left/Steel Disc. RS = Right/Steel Disc.

*-2 Sets Required. † For Vee disc colours add RED, BLU, GRN, GLD, ORG suffix to part number.
⊗ - Also available as a Vintage Motorcycle Disc.

Non-JAPANESE Built Motorcycles

Line #	BRAKE DISC CHOICES - FRONT						DISC PAD CHOICES - REAR				BRAKE DISC CHOICES - REAR			
	Oversize 250 /280mm Disc Kit	OSX Oversize 250/280mm Disc Kit	Relocating Bracket for 250/ 280mm Disc	Oversize 320mm Disc Kit	SMX Oversize 320mm Disc Kit	Relocating Bracket for 320mm Disc	FA, SFA, TT Pad or Brake Shoe	SFAC Carbon Scooter Pads	Speciality Pads - SXR / Vee / MXS	Sintered/ HH Pads/ Grooved Shoes	Standard Replacement Disc	Contour Disc Rear fitment	Vee-Discs™ CONTOUR	CX Extreme MX Race Disc/ UTVX Disc
1							TBA							
2							FA344TT			FA344R	N/A			
3														
4														
5							TBA							
6							TBA							
7							TBA							
8							TBA							
9														
10														
11							FA351TT				N/A			
12							FA351TT				N/A			
13							FA351TT				N/A			
14														
15														
16							SFA197	SFAC197		SFA197HH	N/A			
17							SFA197	SFAC197		SFA197HH	N/A			
18														
19														
20														
21														
22														
23							FA197				N/A			
24							FA197				N/A			
25														
26														
27														
28							FA140							
29							FA140							
30							FA140							
31							FA140							
32														
33														
34							976							
35							976							
36							976							
37							976							
38							976							
39							976							
40							976							
41							976							
42							976							
43							976							
44							975							
45							N/A							
46							N/A							
47							N/A							
48							975							
49							N/A							
50							N/A							
51														
52														
53														
54														
55														
56														
57														
58														
59														
60														

REAR / ARRIÈRE / HINTEN / POSTERIOR / POSTERIORE

R Suffix = High Durability Sintered Pad. **HH** Suffix = High Performance Sintered Pad. **TT** Suffix = Hard Wearing Off Road Pad. **V** Suffix = Semi Sintered Pad. **G** Suffix = Grooved Shoe.
D Suffix = Drilled Disc. **X** Suffix = Universal Left or Right Disc. **XC** Suffix = Contoured Disc. **LS** Suffix = Left/Steel Disc. **RS** = Right/Steel Disc.

*-2 Sets Required. † For Vee disc colours add RED, BLU, GRN, GLD, ORG suffix to part number.
 Ⓢ - Also available as a Vintage Motorcycle Disc.

Part numbers, prefixes, suffixes, photos and illustrations shown in this catalogue are trademarks and/or copyrights of EBC Brakes or the trademark owner A C Freeman Investments Ltd and use without express written permission of the owners is punishable by law.

EBC BRAKE PAD BUYERS GUIDE

NOTE:- Size identification is shown as follows

Dimension 1=Width or Diameter, Dimension 2=Height or Diameter, Dimension 3=Thickness (Material and backplate)

FA011 48 x 9mm



MATERIAL AVAILABILITY												
FA	TT	V	R	HH	MXS	SXR	EPFA	GPFAX	SFA	SFAC	SFAHH	
✓												

ISR AFTERMARKET CALIPER						RD 350/A/B		73-75	F
22-023-0A (2 Piston)						XS 360 B		75	F
22-026-0A (Sprocket Caliper)						RD 400 C/D		76-77	F&R
YAMAHA						TX/XS 500 B		75-77	F
RD 250 B/C				75-76	F	XS 650		75	F
RD 250 D				77	F&R				

FA012 50 x 13/20mm

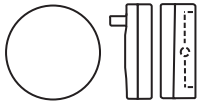

MATERIAL AVAILABILITY												
FA	TT	V	R	HH	MXS	SXR	EPFA	GPFAX	SFA	SFAC	SFAHH	
✓		✓										

HONDA												
CB 750 K0-K6				69-77	F							

FA013 52 x 13/20mm

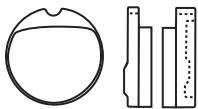

MATERIAL AVAILABILITY												
FA	TT	V	R	HH	MXS	SXR	EPFA	GPFAX	SFA	SFAC	SFAHH	
✓		✓										

HONDA												
CB 250 G5				75	F	CB 500 T			75-77	F		
CJ 250 T				77	F	CB 500 K1/K2/F			75-77	F		
CB 360 G5				75	F	CB 550 F/F1/F2/F3			78-80	F		
CJ 360 T				78	F	CB 750 F/F1			76-77	F		
CB 400 F/F1/F2				75-79	F	CB 750 K7			78	F		

FA016 60 x 51.5 x 10mm

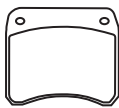

MATERIAL AVAILABILITY												
FA	TT	V	R	HH	MXS	SXR	EPFA	GPFAX	SFA	SFAC	SFAHH	
✓				✓			✓	✓				

AP/LOCKHEED AFTERMARKET CALIPER												
2 Piston / 2 Pin (CP2195/CP2696 - 38EO)						5 Speed Gearbox		75-78	F&R			
220-30 (2 Piston Rear)						T 140 Silver Jubilee Bonneville		77	F&R			
22-033 (2 Piston HD)						T 140 E Bonneville		78-83	F&R			
DUCATI						T 140 D Bonneville						
750 Sport				74	F	(Lester Alloy wheels)		79-81	F&R			
22-030 (2 Piston Rear)						T 140 ES (750cc) (Electric Start)		80-81	F&R			
22-033 (2 Piston HD)						T 140 E/ES (750cc)						
						(Executive/Alloy Wheels)		81-83	F&R			
TRIUMPH (Meriden Produced Models)						T 150V (Trident 3 cyl)		73-74	F&R			
T 140 V Bonneville 5 Speed Gearbox/						T 160V (Trident 3 cyl)		75	F&R			
Drum Rear Brake				73-74	F	TSS 750 (8 valve)		83	F&R			
T 140 V Bonneville Disc All Round/						TSX 750		83	F&R			

FA018 56 x 55 x 9mm

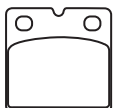

MATERIAL AVAILABILITY												
FA	TT	V	R	HH	MXS	SXR	EPFA	GPFAX	SFA	SFAC	SFAHH	
✓		✓		✓								

AMERICAN SUSPENSION CALIPER												
B17 Phantom 2 piston brake caliper						K 100 LT		86-08/88	F&R			
B17 Mach 8 Standard mount 2 Piston caliper						K 100 LT		09/88-91	R			
P26 2 Piston Caliper						K 100 RS		83-09/88	F&R			
						K 100 RS		10/88-89	R			
BENELLI						K 100 RT		83-09/88	F&R			
354				-82	R	K 100 RT		10/88-89	R			
750 SEi (6 cyl)				75-	F	K 100 RS		89-92	R			
900 SEi (6 cyl)				83	F	K1		88-93	R			
BIMOTA						KL 1100 LT		89-07/93	R			
All early models						-83	F&R	KL 1100 LT	08/93-99	R		
BMW						K 1100 RS		92-96	R			
K 75/75-S				84-90	F	K 1200 RS		96-04	R			
K 75/75-S				08/90-96	R	K 1200 GT		03-06	R			
K 75 C				85-08/88	F	R 45/45N		78-85	F			
K 75 RT				89-96	R	R 65		07/88-92	F			
K 75 S				85-09/88	F&R	R 65 T (Brembo Caliper)		80-85	F			
K 75 S				09/88-95	R	R 65 LS (Brembo Caliper)		81-85	F			
K 1000				82-09/88	F&R	R 65 GS		87-92	F			
K 100/2				87-08/88	F&R	R 65 RT		85-88	F			
K 100/2				09/88-90	R	R 80 RT		82-84	F			

FA018 56 x 55 x 9mm

Contd.

R 80/R 80 RT	84-08/88	F	750 SF3	76-77	F&R	1000 California II (12 spoke cast wheels/screen & luggage)	81-87	F&R	
R 80 GS	80-87	F	1000 3C	74-75	F&R				
R 80 ST	82-84	F	1000 3CL	76-78	F&R	1000 California III Carbs (VY Chassis code/full fairing/cast & spoke wheels)	88-90	F&R	
R 80 TIC	09/80-85	F	1000 3CL Jarama/Jota	79-81	F&R				
R 100/7T	09/80-84	F	1000 RGS	82	F&R	1000 California III Carbs			
R 100 RS	10/80-84	F&R	1000 RGA/RGS Exec	83	F&R	(VW Chassis code/screen only)	87-93	F&R	
R 100 RS	86-08/88	F	1000 RGS Corsa	84	R	1000 California III - EFi			
R 100 RT	10/80-84	F&R	1000 SFC	85-86	F&R	(VY Chassis Code/Full fairing/cast & spoke wheels)	90-93	F&R	
R 100 RT	87-08/88	F	1200	78-79	F&R				
R 100 RS	92-01	R	1200 TS/Mirage	81	F&R	1000 Le Mans 1V/V (10 spoke cast wheel)			
DUCATI			MOTO GUZZI						
250/350/450 Desmo	-76	F	850 Le Mans I	76-77	F&R	1000 Strada	84-93	F&R	
600 Pantah	81	F&R	850 Le Mans II	78-80	F&R	1100 California - Carbs (KC/KD Chassis codes)	93-94	F&R	
650 Pantah	-84	F&R	850 Le Mans III (12 spoke cast wheel)	81-84	F		94-97	F&R	
751 F1	98	F&R	850 T	74	F	G5 V1000	78-83	F&R	
750 Paso	87-90	F	850 T3	75-79	F&R	MZ			
750 Sport	88-90	F&R	850 T3 California (with screen/panniers)	75-79	F&R	ETZ 125/150/250/300	85-92	F	
860 GT/GTS	75-76	F&R	850 T4	80-82	F&R	Saxon 125/251/301/500	93-97	F	
900 GTS	75-76	F&R	850 T5	83-85	F&R	Saxon 150	95	F	
900 Hailwood Replica	79	F&R	850 T5 California (with screen/panniers)	83-85	F&R	Saxon Tour 251/301	93-98	F	
900 SD Darmah (4 bolt front & rear disc fixing)	77	F&R	1000 GT 1st Series Alloy Wheels & Cast	87-91	F&R	251 Fun	95-96	F	
900 SD Darmah (6 bolt front disc fixing /4 bolt rear disc fixing)	78	F&R	1000 GT 2nd Series Alloy Wheels & Cast	87-91	F&R	Saxon 500 All models	93-98	F	
906 Paso	88-89	F&R	1000 - 1000 S	89-94	F&R	NORTON			
1000 R1 Hailwood Replica	84	F&R	1000 - 1000 SP (12 spoke cast wheels/dished front discs)	79-83	F	Classic (Rotary)	89	F&R	
HOREX			TRIUMPH (Meriden Produced Models)						
HRD 600	85	F&R	1000 - 1000 SP II (10 spoke cast wheels/solid front discs)	84-87	F&R	Interpol 2 (Rotary)	89	F&R	
500/600 Columbus	88-	F&R	1000 - 1000 SP III (No spoke cast wheels/flat floating front discs)	89-94	F&R	T 140 Bonneville	85-88	F&R	
LAVERDA									
750 SF2	74	F							
750 SFC	74	F&R							

FA021 47 x 16.2mm



MATERIAL AVAILABILITY											
FA	TT	V	R	HH	MXS	SXR	EPFA	GPFA	SFA	SFAC	SFAHH
✓			✓								

YAMAHA											
YFM 200 N/DXW/DX/DXA	85-90	R	YFM 250 W/A/B	90-92	R						
YTM 200 EL/DX	89	R	YFM 350 FWT/FWU/FWW/FWA/FWB/FWD								
YTM 225 DRN	85	R	/FWE/FWF/FWG "Big Bear"	87-95	R						
YFM 225 S/T/U	86-89	R	YFM 350 ERD/ERE/ERF/ERG	92-95	R						

FA022 72 x 35mm

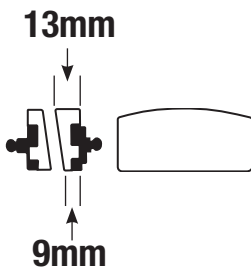

MATERIAL AVAILABILITY											
FA	TT	V	R	HH	MXS	SXR	EPFA	GPFA	SFA	SFAC	SFAHH
✓		✓									

BMW											
R 60/7	76-80	F	R 90/6	73-76	F						
R 60 TIC	78-82	F	R 100	76-77	F						
R 75/6/75/7	73-79	F	R 100/7T	77-09/80	F						
R 80	77-84	F	R 100 S	76-80	F						
R 80 TIC	78-08/80	F	R 100 RS	76-09/80	F						
R 90 S	73-76	F	R 100 RT	78-09/80	F						

FA024/2 114 x 67 x 7mm



MATERIAL AVAILABILITY											
FA	TT	V	R	HH	MXS	SXR	EPFA	GPFA	SFA	SFAC	SFAHH
✓		✓									

HARLEY DAVIDSON											
FX/FXE/FXEF/FXWG/FXS	73-83	R	FL/FLH	72-80	R						
FL/FLH	72-84	F	(BANANA CALIPER)								

FA026 78 x 52.5 x 6mm



MATERIAL AVAILABILITY											
FA	TT	V	R	HH	MXS	SXR	EPFA	GPFA	SFA	SFAC	SFAHH
✓											

HARLEY DAVIDSON											
XLH/XLCH	73-77	F	FX/FXE	73-77	F						

FA027 44.5 x 55.5 x 9.5mm



MATERIAL AVAILABILITY												
FA	TT	V	R	HH	MXS	SXR	EPFA	GPFAX	SFA	SFAC	SFAHH	
✓												

NORTON

750 Mk V Commando / Roadster / Interstate	73	F&R	850 Mk II / II A Commando Roadster / Hi Rider / Interstate	74	F&R
850 Mk I Commando / Hi Rider / Interstate	73	F&R	850 Mk III Commando Roadster / Hi Rider / Interstate	75	F&R
850 Mk I A Commando Roadster / Interstate	73	F&R			

FA028 45.5 x 12/15.5mm

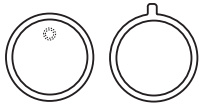

MATERIAL AVAILABILITY												
FA	TT	V	R	HH	MXS	SXR	EPFA	GPFAX	SFA	SFAC	SFAHH	
✓												

YAMAHA

FSIE DX	77-79	F	RS 100 DX (IY8 Europe)	79	F
RD 50 M	78	F	RD 125 DX	75-77	F
RS 100 DX	77-80	F	RS 125 DX	76-80	F
RS 100 (IY8 Europe)	77-78	F	RD 200 DX	75-78	F

FA029 67 x 49 x 11mm

FA030 67 x 49 x 10mm

FA031 67 x 49 x 9mm



MATERIAL AVAILABILITY												
FA	TT	V	R	HH	MXS	SXR	EPFA	GPFAX	SFA	SFAC	SFAHH	
✓		✓										

FA29 - HONDA

CX 500 CA/CB/Z/A/B	79-81	F	GL 1000 K/K1/K2/KZ 'Goldwing'	75-77	
GL 1000 K3/KZ "Goldwing"	78-79	F	GL 1100 A/DA/B/DB (SC02)	80-81	
FA30 - HONDA			FA31 - HONDA		
CB 400 N/NA/NB	78-81		CB 750 F2	79	F
CB 750 F2	79		CB 750 FZ/FA/FB	78-82	F&R
CBX 1000 Z	79-80		CB 900 FZ/FA	80-81	F&R
			CBX 1000 Z	79-80	F&R

FA032 58 x 65.5 x 11mm

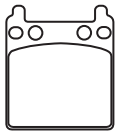

MATERIAL AVAILABILITY												
FA	TT	V	R	HH	MXS	SXR	EPFA	GPFAX	SFA	SFAC	SFAHH	
✓		✓										

HONDA

CB 750 F/F1	76-77	R	PERFORMANCE MACHINE AFTERMARKET		
GL 1000 K/K1/K2/K3/KZ 'Goldwing'	75-79	R	CALIPER	162 X 2	

FA033 A. 51.5 x 12.5mm

B. 50 x 12.5mm

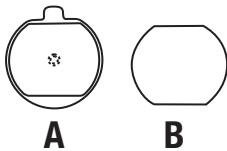

MATERIAL AVAILABILITY												
FA	TT	V	R	HH	MXS	SXR	EPFA	GPFAX	SFA	SFAC	SFAHH	
✓												

KAWASAKI

KH 250 B1-B5	77-82	F	KH 500 A8	76	F
S2-A (350cc)	72-73	F	Z 650 B1/B2/B3	79-81	F
KH 400 A3/A4/A5	76-78	F	Z 650 C1/C2	76-78	F
S3/S3-A (400cc)	74-75	F	Z 750 B1/B2/D1	76-78	F
Z 400 G1	79	F	Z 900 A4	77-78	F
H1 500 Mach III	69-70		Z 1000 A1-A2	74-82	F
H1-A 500 S Mach III	71		Z 1000 D1 (Z1-R)	78-	F
H1-B/C 500 Mach III	72		Z 1000 H1	80	F

FA034 66 x 49.5 x 11mm



MATERIAL AVAILABILITY												
FA	TT	V	R	HH	MXS	SXR	EPFA	GPFAX	SFA	SFAC	SFAHH	
✓		✓										

YAMAHA

XS 250 C	78	F&R	XS 650	77-81	F
XS 250 D/E	79-81	F	XS 650 SE	79-80	F&R
XS 360 C	76	F&R	XS 650 SE	81	F
XS 400 C	78	F&R	XS 750	77-79	F&R
XS 400	79	F	XS 750 SE	79-80	R
SR 500	78-82	F	XS 850	80	F&R
XS 500 C/D	78-79	F&R	XV 1000 TRI	81	F
XJ 650	80-84	F	XS 1100	78-80	F&R
XJ 650 LH Midnight	81	F	XS 1100 S	81	R
XJ 650 RJ 'Seca'	82	F	XS 1100 SG	80	R
			XS 1100 SG	80	R

DO NOT REFIT ANY SHIMS/INSULATORS TO EBC PADS FROM ORIGINAL PADS UNLESS INSTRUCTED ON NOTE ON PAD PACKAGING AND ON FA DRAWING ASSOCIATED WITH THAT PAD.

FA035 A. 50 x 11mm
B. 50.5 x 12.5mm

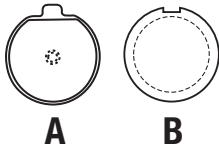

MATERIAL AVAILABILITY											
FA	TT	V	R	HH	MXS	SXR	EPFA	GPFAX	SFA	SFAC	SFAHH
✓											

SUZUKI

GS 400 B/C	77-78	F
GS 425 EN	78-80	F
GS 750 B/DB/DC/EC/EN	77-80	F

FA036 57.5 x 53 x 9mm

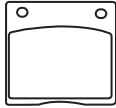

MATERIAL AVAILABILITY											
FA	TT	V	R	HH	MXS	SXR	EPFA	GPFAX	SFA	SFAC	SFAHH
✓		✓									

GMA AFTERMARKET CALIPER

2 Piston Rear (Large) Caliper model A (CCI # 09-997)	GS 650 GTX/GTZ/GTD/GX/GZ	81-83	R
	GS 700 EF/ESF	85	R
	GS 750 B/DB/DC/EC/EN	77-80	R
	GSX 750 ET/EX/ESD/EFE/ESG/ESE		

KAWASAKI

Z 500 B1/B2	79-80	R	/ESH/ESF	82-86	R
Z 650 C3	79	R	GSX 750 SE Katana	85	R
Z 650 D2/D3 (SR)	79-80	R	GSX 750 S/SS		
Z 1000 D1/D3 (Z1R)	78-79	R	(G57SX-106815-) Katana	84	R
Z 1000 A1-A4	77-80	R	GSX 750 S-2/S-2C		
Z 1000 ST (E1-E2 shaft)	79-82	R	(GS75X-114747-) Katana	84	R
Z 1000 H1	80	R	GS 850 GN/GT/GX/GZ/GE/GG	79-85	R
Z 1300 A1-A5	79-83	R	GS 1000 HC/EC/EN/SN	78-80	R
ZG 1300 A1-A3	84-86	R	GS 1000 ET/GT/GX	81-82	R

SUZUKI

GSX 400 FX/FZ/FD	81-83	R	GSX 1100 ET/EX/EZ/ESD	80-83	R
GS 550 EC/EN	78-79	R	GS 1100 GZ	82	R
GS 550 ET/EX/EZ/LT/LX/MX/MZ	80-84	R	GSX 1100 SZ/SD Katana	82-83	R
XN 85 Turbo	83	R	GV 1200 GLF/GLF2/GLG Madura	85-86	R

FA037 51.5 x 13/12mm

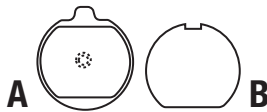

MATERIAL AVAILABILITY											
FA	TT	V	R	HH	MXS	SXR	EPFA	GPFAX	SFA	SFAC	SFAHH
✓											

KAWASAKI

Z 650 C1/C2	77-78	R	Z 750 B1/B2	77-78	R
			Z 750 D1	76	R

FA038 50 x 12mm

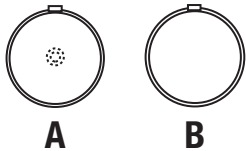

MATERIAL AVAILABILITY											
FA	TT	V	R	HH	MXS	SXR	EPFA	GPFAX	SFA	SFAC	SFAHH
✓		✓									

SUZUKI

GT 125 C/EC/EN	78-79	F	GS 550 DB/DC/EC/EN	77-79	F
GT 200 EN/EX "X5"	79-82	F	GS 850 GN/GT/GX	79-81	F
GT 250 EN/ET/EX "X7"	78-81	F	GS 1000 HC/EC/EN/SN	78-80	F

FA039 43.5 x 10/12mm

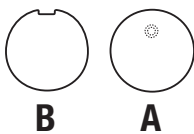

MATERIAL AVAILABILITY											
FA	TT	V	R	HH	MXS	SXR	EPFA	GPFAX	SFA	SFAC	SFAHH
✓											

KAWASAKI

KH 125 A1-A4	77-81	F	GT 50 KB/KEN	77-80	F
Z 200 A1-A5	77-82	F	ZR 50 KEN/KEX "X1"	79-83	F

SUZUKI

FA040 A 41 x 21mm
B 41 x 11mm

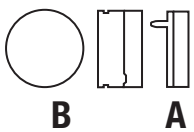

MATERIAL AVAILABILITY											
FA	TT	V	R	HH	MXS	SXR	EPFA	GPFAX	SFA	SFAC	SFAHH
✓											

HONDA

CB 50 J	81	F	Trail Boss 2 x 4	85-87	R
SS 50 ZB2	77-80	F	Scrambler 3 wheeler	85-86	R
CB 125 J/T	78-79	F	Cyclone '250 X'	87	R
FL 250 Odyssey	77-84	R			

POLARIS

FA041 94.5 x 56mm x 20mm

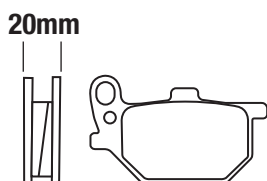

MATERIAL AVAILABILITY											
FA	TT	V	R	HH	MXS	SXR	EPFA	GPFAX	SFA	SFAC	SFAHH
✓		✓									

YAMAHA

RD 250 E/F	78-79	F&R	XS 400 SE	80-81	F
XS 250 SE/SF	79-81	F	XS 750 SE	79-80	F (Right)
RD 400 E/F	78-79	F&R	XS 1100 SG	80	F (Right)

FA042 45 x 45 x 10/16mm

MATERIAL AVAILABILITY											
FA	TT	V	R	HH	MXS	SXR	EPFA	GPFA	SFA	SFAC	SFAHH
✓											

YAMAHA

FS 1 DX				79-80	F	RD 125 DX					78-81	F
RD 50 M				79-80	F	RS 125 DX					81	F
RS 100 (IY8 Europe)				80-82	F	RD 200 DX					78-80	F

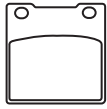
FA045 54 x 53 x 11mm

MATERIAL AVAILABILITY											
FA	TT	V	R	HH	MXS	SXR	EPFA	GPFA	SFA	SFAC	SFAHH
✓		✓									

HONDA

CB 250 T/N/NA/NB/NDB/NDC				78-82	F	CB 400 T					78	F
CB 250 RSA/RSD				81-84	F	CB 650 Z/B					79-81	F
CM 250 TB				81	F	CB 750 KZ					80	F
CB 400 A 'Honda-matic'				79	F							

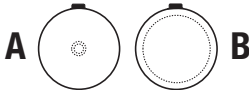
FA046 44 x 11.5/13mm

MATERIAL AVAILABILITY											
FA	TT	V	R	HH	MXS	SXR	EPFA	GPFA	SFA	SFAC	SFAHH
✓											

SUZUKI

GP 100 C/N/X/DED				78-87	F							
------------------	--	--	--	-------	---	--	--	--	--	--	--	--

FA047 40 x 50 x 7mm**FA047/2 40 x 50 x 5.5mm****FA047/3 40 x 50 x 9.3mm**

MATERIAL AVAILABILITY - FA047											
FA	TT	V	R	HH	MXS	SXR	EPFA	GPFA	SFA	SFAC	SFAHH
✓	✓	✓		✓					✓		✓

MATERIAL AVAILABILITY - FA047/2											
FA	TT	V	R	HH	MXS	SXR	EPFA	GPFA	SFA	SFAC	SFAHH
✓											

MATERIAL AVAILABILITY - FA047/3											
FA	TT	V	R	HH	MXS	SXR	EPFA	GPFA	SFA	SFAC	SFAHH
✓											

ACCOSSATO

CE 50/80/KR 80	87-	F	DB5R/S (1078cc)	08-09	R	GPI 250					05	R
Enduro Codice 50	89-	F	DB6 (1078cc)/DB6/R (1078cc)	08-09	R	DUCATI						

AGRALE

Elefantre 30.0		F	DB7 (1099cc)	09	R	Supersport 400					93-97	R
		F	DB8 SP (1078cc)	12-13	R	400 Monster/Dark					95-04	R

ALFER

80 MC	87-	F	DB10 Motard (1078cc)	12-13	R	Monster 400 ie (Japan)					07-08	R
125 MC	87	F	Tesi 2D	04-06	R	Monster Dark ie 400 (Japan)					05-06	R
125 MC	88-	R	Tesi 3D (1078cc)	09-13	R	Monster Darkie 400 (Single disc)					05	R
250 MC	85-86	F	SB8K Gobert (996cc Suzuki engine)	06	R	Monster 400 (Single disc)					00-02	R
250 MC	87	F&R	SB8K Santamonica (992cc Suzuki engine)		R	Monster 400 (Twin disc)					03-04	R

BAOTIAN

250 MC	88-	R	BT 49 QT-9F3 Eagle 50	10-11	F	Supersport 400 (Twin disc)					93-97	R
250 MC	88-	R	BALCON 50	10-11	F	500 GTL					75	F

BREMBO AFTERMARKET CALIPER

250 GR/Enduro	85-87	F	20 5161 43 or 81 - 2 Piston P 2/32 Rear Caliper			500 GTV Pantah					77	F&R
250/300 GR/Enduro	88-	R				500 Sport Desmo					77	F&R

APRILIA

RS 50	93-98	F				500 Pantah					79	F&R
AF1 125	87-89	R				Monster 600 (Twin disc)					93-97	R

CAGIVA

RS 125 (All models)	92-05	R				600 Monster					93-01	R
AF 125	90-91	R				600 Monster Dark					98-99	R

Blues 125

Red Rose 125	87	R				600 Monster City/City Dark					99	R
Tuono 125	03-04	R				600 Supersport					91-97	R

620/IE/SIE Monster

250	86	F				620/IE/SIE Monster					02-04	R
RS 250 (All models)	95-02	R				620 Sport					03	R

BENELLI

124/125 2C/125 2T/2CSE	76-	F				Monster 620 ie (Single disc)					03-04	R
125 T	83	F				Monster 620					05-06	R

BETULA

250 C/TS, 250/4	76-	F				Supercity 125					06	R
BX 250 Motard	12-13	R				Mito 125 (all models)					03-06	R

BIMOTA

Uno C 250 (Single)	13	R				Planet 125 (3 Spoke Wheels)					07-08	R
304	83	F				Planet 125 (6 Spoke Wheels/ST Series)						

BIRINGER AFTERMARKET CALIPER

354	-82	F				Planet 125 (6 Spoke Wheels 2nd Series)					06	R
354 Sport 2	83	F&R				Raptor 125						

BETA

500/4	76-	F				SST 250/350					80-82	F
654 Sport	83	F&R				SX 250					82	F

DERBI

666 Scooter "Born in Hell"	98-99	R				748 S (Biposto/Monoposto)					00-02	R
BIRINGER AFTERMARKET CALIPER						748 SPS					98-99	R

6 Piston (Old Design/2 Piston)

6 Piston (Old Design/2 Piston)						748 Testa Bassa (Mono/Biposto)					07	R
BETA						748 Biposto					95-02	R

Eikon 125/150

Eikon 125/150	00-06	F				748 SP/Monoposto					99-02	R
BIMOTA						748 SP					95-98	R

All models

All models	89-03	R				748 R (2 pad caliper)					00	R
						748 R (4 pad caliper)					01-02	R

Excaltion 501 RX

Excaltion 501 RX						750 Paso					87-90	R
BETA						750 Supersport					91-98	R

River 600

River 600						750 Monster					96-98	R
BIMOTA												

All models

All models	89-03	R										
------------	-------	---	--	--	--	--	--	--	--	--	--	--

FA047 40 x 50 x 7mm

FA047/2 40 x 50 x 5.5mm

FA047/3 40 x 50 x ??mm

750 Monster City/City Dark	99	R	XRT 600	88-	R	/electronic ignition)	77-79	F&R
750 Monster/Monster Dark	99	R	HARRISON AFTERMARKET CALIPER			NTX 350	87-90	F&R
750 Monster	00-01	R	Big 4 Piston (1296033)/Big 6 Piston (1296033)			350 Nevada	92-97	F&R
Monster ie 750	02	R	HRD			350 Nevada Club	98-99	F&R
Supersport 750 (Twin disc)	91-98	R	WH 125 Road/Red Horse	85-	F	500 V50 (12 spoke cast wheels		
Monster 800	03-04	R	HONDA (HM) ITALY			/electronic ignition)	77-79	F&R
800 Supersport	03-05	R	CRE 50 Six/Baja/Derapage	95-02	R	500 V50 C Custom (10 spoke cast		
851 Superbike Biposto	89-92	R	H P POWER			wheels/points ignition)	82-86	F&R
888 SP4/SP5	92-93	R	Iron 50 (2T)	10-11	F	500 V50 III (12 spoke cast wheel)	80-84	F&R
888 Superbike Strada	94-95	R	HYOSUNG			650 65 GT	88-89	F&R
900 Supersport	89-90	R	Grand Prix 125	99-04	F	650 V65 C Custom (10 spoke cast		
900 Supersport/Superlight	91-97	R	Exceed 125 (MS1 125/150)	02-04	F	wheels)	83-86	F&R
900 Supersport CR USA	98	R	Boomer/Exceed 125	02-03	F	650 V65 Florida (Spoke/cast wheel		
900 Supersport FE	98	R	GPS 125 Grand Prix/Hyper			models)	85-91	F&R
900 Monster	93-99	R	Rear drum model	99-04	F	NTX 650	87-90	F&R
900 Monster Cromo/Special	98	R	GPS 125 Grand Prix Plus			750 Nevada Club (Up to LK112433)	98-00	F&R
900 Monster City/City Dark	99	R	Rear disc model	00-04	F	750 Nevada Club (From LK112433)	00-01	F
900 IE Monster	00-01	R	MSI 125/150	05	F	750 SP (10 spoke cast wheels)	90-92	F&R
907 IE	90-93	R	HUSQVARNA			750 Strada/T Roadster	93-95	F&R
916 SPS (996cc)	97-98	R	XC 125/250/500	85-86	F	750 Targa	90-93	F&R
Monster S2R Dark (803cc)	05-06	R	CR 240/250/500	85-86	F	750 Nevada	91-01	F&R
Monster S4 Foggy (916cc)	02	R	TC/TE/TX 510	87-88	F	750 V75 (10 spoke cast wheel		
Monster S4 (916cc)	01-02	R	INDIAN			/solid front disc)	92-96	F&R
916 (Biposto)	94-98	R	See application page for details			R 750 V75 (10 spoke cast wheel		
916 Senna	94-98	R	IRON PEGASUS			/floating front discs)	96-01	F&R
916 SP	94-96	R	Small caliper (Single pin fixing)			1000 Daytona	92-95	R
S4 RS Monster (998cc)			ISR AFTERMARKET CALIPER			1000 Daytona RS	97-98	R
(Radial 4 pad caliper)	06	R	22-025-XX (4 Piston)			1000 V10 Centauro GT/Sport	97-99	R
S4R Monster Testastretta (998cc)			22-027 (2 Piston Rear)			1100 Sport Carbs	94-96	R
(Radial 4 pad caliper)	07-08	R	22-028 (2 Piston)			1100 Sport Efi	96-99	R
S4RS Monster Testastretta (998cc)			22-029 (Rear 2 Piston)			1100 Sport Corsa	98-99	R
(Radial 4 pad caliper)	07	R	KEEWAY			1100 V11 Ballabio	03-05	R
S4RS (Tricolore/Monster Testastretta)			ARN 50 (25/45)	10-11	F	1100 V11 Le Mans	01-05	R
(998cc) Radial 4 pad caliper	08	R	Hacker 50/125/150	08-10	F	1100 V11 Sport	99-01	R
Monster S4R (996cc) (2 pad caliper)	05-06	R	ARN 125	06-12	F	1100 V11 Scura	01-03	R
996 SPS (996cc)	99	R	ARN 150	06-10	F	1100 V11 Naked	02-03	R
996 (996cc) (Monoposto/Biposto)	99-01	R	KTM			MOTO MORINI		
Monster S4R (996cc)	03-06	R	MX/MXC 125/250/300	85	F	Dart 350	87	R
996 R/S	01	R	GSXC/GS 125/250/300	85	F	350 Kanguro	87	R
998 Matrix (998cc)	04	R	MX/MXC/GS 125/350/300/350	86	F&R	Excaliber 350/501 Rlx	93-	R
998 R (998cc)	02	R	350 Four Stroke	83	F	MZ/MUZ		
998 S Baylis/Bostrom	02	R	MX/MXC/XC-GS 500	85	F	Mastiff - 17" front wheel/cast wheel	99-05	R
998 S (998cc) 4 pad caliper	02-04	R	LAVERDA			Tour/Traveller	95-02	R
998 (998cc) (2 pad caliper)			OR 50 Atlas	87-	F&R	Skorpion Sport/Replica/Cup	95-01	R
(Monoposto/biposto)	02-03	R	GS 125 Lesmo	86-89	F&R	PRO ONE		
Monster 1000 Dark	03	R	LZ 125 Sport Brembo caliper	80-82	F	2 Piston		
Monster 1000 ie (92cc)	04-05	R	Montjuic	76	F&R	TM		
Monster 1000 S ie (992cc)	03-05	R	Alpino 500	76	F&R	SMM 125 Black Dream (Rim brake)	04-10	R
Monster S2R 1000 (992cc)	06-08	R	650 All models	94-95	R	SMM 250/300 (2T)	05-15	R
FANTIC			668 All Models	96-98	R	SMM 250 F (4T)	10	R
50/80 Caballero/Caballero RC	91-	F	750 All Models	98-01	R	SMM 400 (4T) Rim brake	04-	R
GILERA			MAICO			SMM 450 F Black Dream E-S	08	R
RV 50 NGR	88-	R	All Models	85	F	SMM 530 F Black Dream Rim brake	04-10/15	R
125 HX LC	83-	F	MALAGUTI			VOXAN		
125 RX	84-	F	50 Enduro MEX	85-86	F	Charade Racing	06	R
RX 125 Arizona	88-	F	Enduro MDX 80	84-	F	YAMAHA		
GFR 125	94	R	Ciak 125/150/200	01-08	F	TDR 125 R Lightburner (3SH2/3XE2)	93-94	R
Nordwest	94	R	F18 125/150 Warrior	00-03	F	TZR 125 RR	96-	R
125 CX	91-	R	MALANCA			TZR 125 R Brembo Caliper (4DL1/4DL2)	91-93	R
125 MX1/MXR	89-	R	E2 C80/CS		F&R	SZR 660	96-97	R
125 SP 01/SP 02	89-	R	125 GTI		F&R	FA047/2 - GARELLI		
125 XR1/XR2	89-	R	125 Mark Enduro	-84	F	Urka 50	91-	F
RX 200/Arizona/Enduro	85-	F	Ciak 200	06	F	125 XR/XRD Tiger	83-	F
200 Fast Bike	87-	R	MONTESA			GILERA		
RV 200	85-86	R	311 (Honda) 260cc	92-93	R	50 Rally	87-	F
RV 200 ES	87-	R	314R (Honda)	94-96	R	R1/50	90-	F
HX 250 LC	83-	F	315R (Honda)	97-00	R	KTM		
NGR 250	85-	R	MOTO GUZZI			80 MX	86-92	F
250 RX Arizona Rally	86-	F	(350) V35 Florida	86-90	F&R	FA047/3 - HONDA		
RC 250 Rally	87-	R	350 V35 II (12 spoke cast wheels)	80-85	F&R	CRM 125 RL/RM/RN/RP/RR/RV/RX	90-99	R
Saturno 350 Bialbero	90-	R	350 V35 III (10 spoke cast wheels)	85-87	F&R	NSR 125 FJ/FK/FL/FM/FN	88-92	R
XRT 350	90-	R	350 V35C Custom (10 spoke cast			NSR 125 RK/RL/RM/RN/RR/RS/RV/		
Nord-West 350	94-	R	wheels/points ignition)	82-86	F&R	RW/RX/RV/R1	89-01	R
Saturno 500 S/Bialbero/Piuma	90-	R	350 V35 (12 spoke cast wheels)					

FA048 46 x 44 x 16/11mm



MATERIAL AVAILABILITY												
FA	TT	V	R	HH	MXS	SXR	EPFA	GPFAX	SFA	SFAC	SFAHH	
✓												

KAWASAKI

KH 100 G2/G3	81-83	F
Z 400 B1/B2	78-80	F

FA050 31.5 x 49 x 5.5mm



MATERIAL AVAILABILITY												
FA	TT	V	R	HH	MXS	SXR	EPFA	GPFAX	SFA	SFAC	SFAHH	
✓												

CASAL

All disc models		F	Rebell 80 T									F
-----------------	--	---	-------------	--	--	--	--	--	--	--	--	---

GIMATTI

Gringo	-85	F	Sport 80 L									F
--------	-----	---	------------	--	--	--	--	--	--	--	--	---

FANTIC

50 Strada Super Six	73-	F	MALAGUTI									
---------------------	-----	---	-----------------	--	--	--	--	--	--	--	--	--

HERCULES (SACHS)

Diff. older models with disc brake		F	Chopper 25/40									-82	F
------------------------------------	--	---	---------------	--	--	--	--	--	--	--	--	-----	---

HOREX

Rebell 80 N		F	50 LX Sport									-82	F
-------------	--	---	-------------	--	--	--	--	--	--	--	--	-----	---

FA051 78 x 50 x 11.5mm



MATERIAL AVAILABILITY												
FA	TT	V	R	HH	MXS	SXR	EPFA	GPFAX	SFA	SFAC	SFAHH	
✓		✓										

SUZUKI

GN 250 F/J/M/R/T	85-97	F	GS 700 EF/ESF									85	F
------------------	-------	---	---------------	--	--	--	--	--	--	--	--	----	---

GS 250 TT/TX	80-81	F	GSX 750 ESD/EFE/ESG/ESE/ESH/EFF	82-86									F
--------------	-------	---	---------------------------------	-------	--	--	--	--	--	--	--	--	---

GSX 250 ET/EX/EZ	80-82	F	GSX 750 ET/EX									80-81	F
------------------	-------	---	---------------	--	--	--	--	--	--	--	--	-------	---

GN 400 TT	80	F	GS 850 GZ/GE/GG									82-85	F
-----------	----	---	-----------------	--	--	--	--	--	--	--	--	-------	---

GSX 400 ET/EX/EZ	81-83	F	GS 1000 GT/GX									81-82	F
------------------	-------	---	---------------	--	--	--	--	--	--	--	--	-------	---

GSX 400 LX/TX	81	F	GS 1100 GZ									82	F
---------------	----	---	------------	--	--	--	--	--	--	--	--	----	---

GS 450 ET/EG/EJ	80-88	F	GV 1200 GLF/GLF2/GLG Madura									85-86	F
-----------------	-------	---	-----------------------------	--	--	--	--	--	--	--	--	-------	---

FA052 41 x 21/11mm

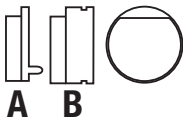

MATERIAL AVAILABILITY												
FA	TT	V	R	HH	MXS	SXR	EPFA	GPFAX	SFA	SFAC	SFAHH	
✓												

HONDA

CB 100 N	78-80	F
----------	-------	---

CB 125 T2	79	F
-----------	----	---

FA054 41.5 x 45 x 7.5mm



MATERIAL AVAILABILITY												
FA	TT	V	R	HH	MXS	SXR	EPFA	GPFAX	SFA	SFAC	SFAHH	
✓	✓		✓	✓	✓				✓	✓	✓	

AJS

JSM 50 Motard	13-15	R	NS 125 DLX/III	03-07	F&R	JIALING							
---------------	-------	---	----------------	-------	-----	----------------	--	--	--	--	--	--	--

JSM 125 Motard	10-15	R	Otello 125 (NS 125 DLX)	00-02	F	JH 125 B Roadstar						98	F
----------------	-------	---	-------------------------	-------	---	-------------------	--	--	--	--	--	----	---

Regal Raptor DD 50 E/E2	04-06	F	S1 125 (SL125)	07-14	R	KAWASAKI							
-------------------------	-------	---	----------------	-------	---	-----------------	--	--	--	--	--	--	--

JS 125-E/E2 (Eco 125)	07-09	F	SL 125 Otello Fi	07-09	R	KX 65						00-22	R
-----------------------	-------	---	------------------	-------	---	--------------	--	--	--	--	--	-------	---

JS 125-E (Eco-2 125)	09-15	F	SQ 125 S2 Freewing	07-09	R	BN 125 A1/A2 'Eliminator'						98-99	F
----------------------	-------	---	--------------------	-------	---	---------------------------	--	--	--	--	--	-------	---

ASPES			GARELLI			KH 125 K1						83	F
--------------	--	--	----------------	--	--	-----------	--	--	--	--	--	----	---

Perseus Hybrid 150	11-14	F	Fashion F150	07	F	KLX 125 CAF/CBF/CCF/CCS/CDS							
--------------------	-------	---	--------------	----	---	-----------------------------	--	--	--	--	--	--	--

CCM			HONDA			/CDF/CEF/CFF/CGF						10-16	R
------------	--	--	--------------	--	--	------------------	--	--	--	--	--	-------	---

C-XR 125 E	08-09	R	MB 5 S	80-82	F	KLX 125 DAF/DBF/DCF/DDF							
------------	-------	---	--------	-------	---	-------------------------	--	--	--	--	--	--	--

C-XR 125 M	07-09	R	MG 50 S/X/1/3 Magna 50	95-03	F	/DEF D-Tracker						10-14	R
------------	-------	---	------------------------	-------	---	----------------	--	--	--	--	--	-------	---

C-XR 125 S	08-09	R	MRX 50	88-	F	Ninja 125 ABS						19-20	R
------------	-------	---	--------	-----	---	---------------	--	--	--	--	--	-------	---

C-XR 230 E	07-09	R	MBX 80 FWDD/FWDF	83-86	F	Z 125 (BR125 GGF/GHF Auto G/Box)						16-20	R
------------	-------	---	------------------	-------	---	----------------------------------	--	--	--	--	--	-------	---

C-XR 230 M	07-09	R	CB 125 RS	83	F	Z 125 PRO (BR125 HGF/JHF Manual G/Box)						16-20	R
------------	-------	---	-----------	----	---	--	--	--	--	--	--	-------	---

C-XR 230 S	07-09	R	CBX 125 TS Custom	82	F	KLX 150 L (KLX 150 EFF)						14-15	R
------------	-------	---	-------------------	----	---	-------------------------	--	--	--	--	--	-------	---

LX 350-4A Quad	08-09	F	CG 125 ES4-ES8	04-08	F	KLX 150 D-Tracker (KLX150 HGF)						16	R
----------------	-------	---	----------------	-------	---	--------------------------------	--	--	--	--	--	----	---

LX 700-4A Quad	08-09	F	CG 150 ESD Titan	04-05	F	KVF 300 A1/A2/A3/A4/B1/B2/B3/B4							
----------------	-------	---	------------------	-------	---	---------------------------------	--	--	--	--	--	--	--

DAELIM			CG 150 KS/ES Titan	04-05	F	(Prairie 4x4/2x4)						99-02	F
---------------	--	--	--------------------	-------	---	-------------------	--	--	--	--	--	-------	---

Tapo Message 50	04	F	CBX 200 Strada	97-01	F	KVF 360 A1-A3/A6F/A7F/A8F/A9F							
-----------------	----	---	----------------	-------	---	-------------------------------	--	--	--	--	--	--	--

Altino 125	01-04	F	ATC 250 RB	81	F	/AAF/ABF/ACF/ADF						03-13	F
------------	-------	---	------------	----	---	------------------	--	--	--	--	--	-------	---

B-Bone 125 (SN125)	09-14	R	HYOSUNG			KVF 360 B1-B3/B6F/B7F/B8F/B9F						03-09	F
--------------------	-------	---	----------------	--	--	-------------------------------	--	--	--	--	--	-------	---

History 125	01-06	F&R	XRX 125 LC Enduro/Supermoto	14-15	F	KVF 360 C1-C3/C6F/C7F/C8F Prairie							
-------------	-------	-----	-----------------------------	-------	---	-----------------------------------	--	--	--	--	--	--	--

			TE 450 Quad Rapier	06-09	F&R	All models						03-08	F
--	--	--	--------------------	-------	-----	------------	--	--	--	--	--	-------	---

DO NOT REFIT ANY SHIMS/INSULATORS TO EBC PADS FROM ORIGINAL PADS UNLESS INSTRUCTED ON NOTE ON PAD PACKAGING AND ON FA DRAWING ASSOCIATED WITH THAT PAD.

FA054 41.5 x 45 x 7.5mm

KVF 400 A1/A2/B1 'Prairie'	97-98	F	QUADZILLA						LT-A 500 FK2-FK4 Vinson 4WD Auto	02-07	F
KVF 400 C1-C4/D1-D4 (Prairie 4x4/2x4)	99-02	F	RV 125 Midi RV Bug						LT-F 500 FK3-FK7 Vinson	03-07	F
KEEWAY			BR 150 E Bugrider	04-06	R	SYM			Quadraider 600	06-07	F
Dragon 250 Quad	07-09	R	RV 150 Midi RV Buggy								
KREIDLER			BR 200	07-08	R	TAISHAN					
125 Enduro/Supermoto (4T)	14-15	R	BR 250						Panther 50 Quad	03-04	F
LEXMOTO			XRV 250						XT 50	03-04	F
LSM 50 (STR50)	12-16	R	XL 300						XT 125 Sport	04-05	F
Adrenaline 125 XFLM125GY-2B	13-18	R	SINNIS						YAMAHA		
Adrenaline 125 EFI (XFLM125GY-2B-E4)	15-18	R	LJ 50 QT-H (Rear disc model)	12-14	R	YFS 200 R/S/T/V Blaster			YFS 200 R/S/T/V Blaster	03-06	F
FMX 125 (WY125T-108)	15-18	R	Apache 125 QM 125 GY-2B(A)			YFM 250 XN/XP/XR/XS			YFM 250 XN/XP/XR/XS	01-04	F
Gladiator 125 (SB125T-23B)	14-18	F	(Rear disc model)	09-14	R	YFM 250 BT/BV Bruin			YFM 250 BT/BV Bruin	05-06	F
LSM 125 (STR125YB)	12-18	R	Apache SM/SMR 125	15-20	R	YFM 250 BW/BX/BY Big Bear			YFM 250 BW/BX/BY Big Bear	07-10	F
MASH			Blade 125 QM 125 GY-2B	09-14	R	YFM 350 XD/XE/XF/XG/XH/XJ/XK/XL			YFM 350 XD/XE/XF/XG/XH/XJ/XK/XL		
Black Seven 125cc	17-20	R	Blade X 125	15-20	R	/XM/XN/XP/XR			/XM/XN/XP/XR	92-04	F
Brown Edition 125cc	18-20	R	Eagle 125 QM 125 T-10R	10-14	F	YFZ 350 A/B/D/E/F/G/H/J/K/L/M/N			YFZ 350 A/B/D/E/F/G/H/J/K/L/M/N		
Café Racer 125	14-20	R	JS 125-6H ST125	13-14	F	/P/R/S/T/V Banshee			/P/R/S/T/V Banshee	90-09	F
Dirt Track 125cc	18-20	R	Matrix II 125 QM 125 T-10H	10-14	F	YFM 350 FXG/FXH/FXJ/FXK/FXL			YFM 350 FXG/FXH/FXJ/FXK/FXL		
Seventy Five 125	14-16	R	Matrix 125	10	F	/FXM/FXN/FXP/FXR/FXS Wolverine			/FXM/FXN/FXP/FXR/FXS Wolverine	95-04	F
Seventy Five 125 (Classic)	17-20	R	Egocity 125 (125T-86)	07-14	F	YFM 350 FWA Grizzly 4WD			YFM 350 FWA Grizzly 4WD	04-14	F
Black Seven 250cc	17-20	R	SUPERBYKE			YFM 350 FGW/FGI/FGY/FGIZ			YFM 350 FGW/FGI/FGY/FGIZ		
Café Racer 250cc	17-18	R	RMR 125	07-09	R	Grizzly 4WD IRS			Grizzly 4WD IRS	07-10	F
Two Fifty 250	17-20	R	SUZUKI			YFM 350 L Big Bear			YFM 350 L Big Bear	99	F
PEUGEOT			RM 65 K3/K4/K5	03-05	R	YFM 350 FAS/FAT/FAV Bruin 4x4			YFM 350 FAS/FAT/FAV Bruin 4x4	04-06	F
New Vivacity (50cc/2T) (12" wheels			DF 125			YFM 350 ANS/ANT/ANV Bruin 2x4			YFM 350 ANS/ANT/ANV Bruin 2x4	04-06	F
/200mm dia disc)	08-14	F	DR 125 SF/SH/SJ	85-94	F	YFM 350 XV/XXV/XXXY 2WD Wolverine			YFM 350 XV/XXV/XXXY 2WD Wolverine	06-09	F
New Vivacity (50cc/4T) (12" wheels			DR 125 SEX/SEY	99-01	F	YFM 350 GW/GX/GY/GZ Grizzly 2WD			YFM 350 GW/GX/GY/GZ Grizzly 2WD	08-10	F
/200mm dia disc)	08-14	F	TS 125 XUF/XUG/XUH/XUJ	86-90	F	YFM 400 AR Kodiak (5VH3/4)			YFM 400 AR Kodiak (5VH3/4)	03	F
New Vivacity Sixties (50cc/4T)			DF 200 EV/EW/EY (SH42A)	98-00	F	YFM 400 FAM/FAN			YFM 400 FAM/FAN	00-01	F
12" wheels/200mm disc)	10-13	F	DR 200 G/H/J	86-89	F	YFM 400 FWT (Big Bear)			YFM 400 FWT (Big Bear)	05	F
Sum-up (125cc)	08-11	F	DR 200 SEP/SER/SES/SEV/SEW			YFM 400 FGW/FGX Grizzly			YFM 400 FGW/FGX Grizzly	07-08	F
PGO			/SEX/SEY Djebel (SH42A)	93-00	F	YFM 450 FAR/FAS			YFM 450 FAR/FAS	03-04	F
Bugrider 50 (Buggy)	06	R	DR 200 SE Trojan	96-13	F	YFM 450 FAT/FAHT/FAV (Kodiak)			YFM 450 FAT/FAHT/FAV (Kodiak)	05-06	F
BR 150 A Bugxter	05-07	R	DR 200 SEK1-SEK9	01-09	F	YFM 450 FXV/FXW/FXX/FXY/FXZ			YFM 450 FXV/FXW/FXX/FXY/FXZ		
Bugrider 150		R	SX 200 R/R2/RJ/RM	90-91	F	Wolverine			Wolverine	06-10	F
Bugrider 250 SS (Single seat)		R	LT-F 250 K2-K9/L2-L4 Ozark	02-14	F	YFM 450 FWAD Grizzly EPS			YFM 450 FWAD Grizzly EPS		
Bugrider 250		R	TS 250 XE/XG/XH/XJ/XK	85-89	F	(Power Steering)			(Power Steering)	11-14	F
PIZZA PEDS			LT-A 400 FK2-FK7 Eiger 4WD	02-07	F	YFM 450 FWA Grizzly IRS			YFM 450 FWA Grizzly IRS	11-16	F
125cc 4T Pizza Delivery Scooter	12-15	F	LT-A 400 K2/K3/K4 Eiger	02-04	F	YFZ 450 B/D			YFZ 450 B/D	13-14	F
POLARIS			LT-F 400 FK2-FK7 (Eiger 4WD)	02-07	F						
Trail Boss 4x4	87	F	LT-F 400 K2-K7	02-07	F						

FA055 50 x 12/9mm

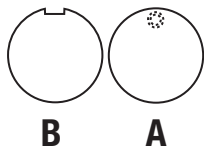

MATERIAL AVAILABILITY											
FA	TT	V	R	HH	MXS	SXR	EPFA	GPFAX	SFA	SFAC	SFAHH
✓											

KAWASAKI											
HI-D/E/F 500				73-75	F	GT 250 L/M/A/B				74-79	F
H2/H20A Mach IV (750cc)				72-73	F	GT 380 L/M/A/B				74-79	F
H2-B/H2-C Mach IV (750cc)				74-75	F	RE5 M/A				75-77	F
Z 900 ZIA/ZIB				74-76	F	GT 500 A/B				75-77	F
SUZUKI											
GT 125 L/M/A/B				74-77	F	GT 550 K/L/M/A/B				73-77	F
GT 185 L/M/A/B				74-79	F	GT 750 K/L/M/A/B				73-77	F

FA056 44 x 8mm

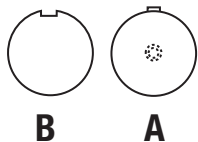

MATERIAL AVAILABILITY											
FA	TT	V	R	HH	MXS	SXR	EPFA	GPFAX	SFA	SFAC	SFAHH
✓											

SUZUKI											
GP 125 C/N/X/D				78-84	F	LT 125-3A					F
HYOSUNG											
GF/A 125 'Speed'				99-06	F	MXR 125				03	F
Cruise II GA 125 F				99-04	F	SUPERBYKE					
KREIDLER											
50 RS-G/RSH-G and GS					F	R-SR125 4V					F
80 E/L Florett					F						
125 RS					F						

FA057 55.5 x 53 x 9mm



MATERIAL AVAILABILITY											
FA	TT	V	R	HH	MXS	SXR	EPFA	GPFAX	SFA	SFAC	SFAHH
✓		✓									

BMW											
R 45/45 N				78-85	F	R 65 LS				81-85	F
R 45 T				80-85	F	R 65 T				80-85	F

BRAKE PAD BUYERS GUIDE

DO NOT REFIT ANY SHIMS/INSULATORS TO EBC PADS FROM ORIGINAL PADS UNLESS INSTRUCTED ON NOTE ON PAD PACKAGING AND ON FA DRAWING ASSOCIATED WITH THAT PAD.

FA060 35.5 x 51.5 x 6mm



MATERIAL AVAILABILITY											
FA	TT	V	R	HH	MXS	SXR	EPFA	GPFA	SFA	SFAC	SFAHH
✓											

APRILIA

Europa 50
AF1 Futura 50
MX 50
RS 50
RX 50 C/CD
Tuorno 50
RX 50 Raing
RX3-5 Marce (M/N/P/R)

KEEWAY

X Ray 50 Supermoto
TX 50
TX 125

MOTO GUZZI

250 (All Models)

CAGIVA

W4 50
Cruiser 125
Elefant 125

WSXT 125 "Aletta Rossa"

90-92 R XSST 125
90-92 R SXT 125
03-05 R Tamanaco 125
93-06 R W8 125
93-04 R **FANTIC**
50 Caballero/Caballero RC
50.1 Oasis
50.1 Oasis E.S.

50 Kaloa
80 Caballero/Caballero RC
80 Kaloa
GARELLI
125 Tiger XLE

GTA 125
GTA 125
GENERIC/KSR

Toxic 50
Trigger X 50 (All Models/TR X 50)

83-84 F Trigger SM 50 (All Models)
81-82 F GRS 125
82- F Trigger 125 SM
88-89 R Trigger 125 X
93-98 R TW 125 SM

GILERA

RV 50 NGR

NGR 250

LAVERDA

LB 125 Custom/Sarbia/Strada Sport

MALAGUTI

50 MXR

MALANCA

125 ob one M6

125 ob one M6 Racing

125 Mark Enduro

06-18 R
14-16 R
08-09 R
08-09 R
13-16 R
88- F
85- F
85-87 F
89- F
85- F&R
85- F&R
85- F

FA061 94.5 x 56 x 20mm

20mm

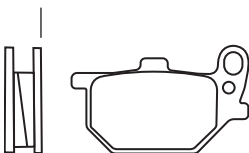

MATERIAL AVAILABILITY											
FA	TT	V	R	HH	MXS	SXR	EPFA	GPFA	SFA	SFAC	SFAHH
✓		✓									

YAMAHA

XJ 650 G/H/J/K Maxim
XJ 650 LH Midnight
XS 750 SE

80-83 F
81 F
79-80 F(left)

XV 750 SE
XS 1100 SG

81 F
80 F(left)

FA062 51 x 11mm



MATERIAL AVAILABILITY											
FA	TT	V	R	HH	MXS	SXR	EPFA	GPFA	SFA	SFAC	SFAHH
✓											

KAWASAKI

Z 1000 ST (E1/E2 shaft)

79-82

Z 1300 A1-A5
ZG 1300 A1-A3

79-83
84-86

FA063 52.5 x 53 x 9mm

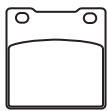

MATERIAL AVAILABILITY											
FA	TT	V	R	HH	MXS	SXR	EPFA	GPFA	SFA	SFAC	SFAHH
✓		✓		✓							

HYOSUNG

Comet 250/600

MAGNI

Sport 1200 'S'

SUZUKI

GSF 250 N/ZM/P/NP/NR
GSF 250 VS/VT/VV/VZ/VW/VX/VY
Bandit (GJ77)
GSX 250 R CH/H (GJ72A)
GSX 250 SSM Katana (GJ76A)
GSX 250 FL/FM/FN/FP/FR/FS/FT
/FV/FW Across
GSXR 250 J (GJ72A)
GSXR 250 CK
GSXR 250 RK (GJ73A)
RG 250 WD 'Gamma'
RG 250 WE/FG/CH/FCH/FH 'Gamma'
RGV 250 J/K/L
TV 250 J/K/AK/L (VJ21A) Wolf
SG 350 N 'Goose'
GSXR 400 H
GSXR 400 J/RR/RAK (GK73A)
GSXR 400 RL/RM/RN/RP/RS (GK76A)
GSF 400 All models (Bandit)
GSX 400 R2/RG (GK71B/F)
GSX 400 X/XA/XS Impulse
GSX 400 FJ/FK/FAK/FL (GK74A)

GSX 400 R/S/T/ZR/ZS/ZT/X Impulse
Type S

GSX 400 FW/FWS/FWS-2
GSX 400 FSV/FSK1 (GK7B) Inazuma
GSX 400 SV (VK53A)

RF 400 RP/RR/VR/RT/RVT/RV-V (GK78A)
RG 400 EWF/EW-2G/EWH
Walter Wolf (Type 1&2)
SV 400 N (VK53A)
SV 400 SV (VK53A)
SV 400 X/Y/K1/K2
SV 400 SX/SY/SK1/SK2
GS 500 EK/EL/EM/EN/EP/ER/ES/ET/
EV/EW/EX/EY/K1-K8/FK4-FK8

RG 500 G/CH
GSX 550 ESD/ESE/EFE/EFF/ESH/ESG
GSF 600 Y/K1/K2-K4 (Naked Bandit)
GSF 600 SY/SK1-SK4 (Faired Bandit)
GSX 600 FJ/FK/FL/FM/FN/FP/FR/FS/FT/FV
GSX 600 FW/FX/FY/FK1-FK6
RF 600 RP/RR/RS/RT/RV
GSXR 600 V/W/X/Y/K1/K2/K3/ZK3
GSF 650 S/T/V/W/X Naked Bandit
GSX 650 ST/SV/SW/SX Faired Bandit
SV 650 A/Y/K1/K2 Naked - Non ABS
SV 650 SX/SY/SK1/SK2
Top Fairing Non ABS

GSX 750 SE "Katana"
GSX 750 FK/FL/FM/FN/FP/FR/FS/FT/FV
GSX 750 RG
GSX 750 FW/FX/FY/FK1-FK6
GSX 750 W/X/Y/K1
GSXR 750 F/G/H/J/K/L/M/WN/WP/
WR/WS/T/V/W/X/Y/K1/K2/K3
GSXR 750 RG
RF 900 RT/RV/RW
TL 1000 SV/SW/SX/RW/RX/SY/SK1/RK1
GSXR 1100 G/H/J/K/L/M/N
GSXR 1100 WP/WR/WS/WT
GSF 1200 T/ST/SV/SW/X/SX/SY
/SK1/K1-K5/SK2-SK5 'Bandit'
GSF 1200 SAV ABS-Bandit
GSF 1200 K1-K5 (Naked Bandit
- 6 piston caliper)
GSF 1200 SK1-SK5 (Faired Bandit
- 6 piston caliper)
GSF 1200 T/V/W/X/Y (Naked Bandit)
4 Piston Caliper
GSF 1200 ST/SV/SW/SX/SY
(Faired Bandit) 4 Piston Caliper
GSX 1200 FSW/FSX 'Inazuma'
GSX 1300 RX/RY/RK1-RK5/RZK3
/K6/K7 'Hayabusa'

85 F
89-97 R
89 R
98-06 R
98-03 R
85-00 R
86 R
96-98 R
97-02 R
86-92 R
93-96 R
96-05 R
97 R
01-05 R
01-05 R
96-00 R
96-00 R
98-99 R
98-99 R
99-07 R

BUYERS GUIDE

DO NOT REFIT ANY SHIMS/INSULATORS TO EBC PADS FROM ORIGINAL PADS UNLESS INSTRUCTED ON NOTE ON PAD PACKAGING AND ON FA DRAWING ASSOCIATED WITH THAT PAD.

FA064 65.5 x 59 x 10mm

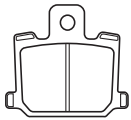

MATERIAL AVAILABILITY											
FA	TT	V	R	HH	MXS	SXR	EPFA	GPFAX	SFA	SFAC	SFAHH
✓											

YAMAHA
RD 250/350 LC 80 F

FA065 71.5 x 45 x 11.5mm



MATERIAL AVAILABILITY											
FA	TT	V	R	HH	MXS	SXR	EPFA	GPFAX	SFA	SFAC	SFAHH
✓		✓									

SUZUKI
GS 550 ET/EX/EZ/LT/LX/MX/MZ 80-84 F XN 85 Turbo 83 F
GR 650 D/XD Tempter 83 F GS 1000 ET 81 F
GS 650 GTX/GTZ/GTD/GX/GZ 81-83 F GSX 1000 SZ 'Katana' 82 F
GSX 750 S/SS (G57SX-106815-) Katana 84 F GSX 1100 ET/EX/EZ/ESD 80-83 F
GSX 750 S-2/S-2C (GS75X-114747-) Katana 84 F GSX 1100 SZ/SD 'Katana' 82-83 F

FA067 A 55.5 x 37 x 10mm B 85 x 43 x 8mm

MATERIAL AVAILABILITY											
FA	TT	V	R	HH	MXS	SXR	EPFA	GPFAX	SFA	SFAC	SFAHH
✓	✓		✓	✓					✓	✓	✓

FA067/3 A 55.5 x 37 x 10mm B 85 x 43 x 7mm

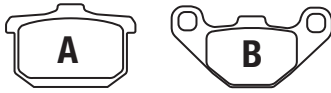

FA067 - AEON

MY 125 12-13 R
Elite 125 (4T) 12-13 R
Urban 125 (4T) 12-13 R
Cobra 220 (Quad) 06-11 R
Cobra S 300 12-15 R
Cube 300 - Side x Side 11 R
Overland 300 (Quad) (AT20) 06-07 R
Cobra 350 (Quad) 10-11 R
Cube 350 - Side x Side 13-15 R
Elite 350i (4T) 12-13 R
Urban 350i (4T) 12-13 R
Cobra 400 (Quad) 10-15 R
Cobra 400 Supermoto Quad 13-15 R
Overland 600 (Quad) 11 R

ALFER

AR 250 93- R

APACHE

F 100 F&R
ZX 100 R
RLX 250 S (MK1) Rear Disc Model F
RLX 250 SX (MK1) Rear Disc Model F
RLX 320 S F&R
RLX 320 Utility F&R
RLX 450 S F&R

APRILIA

RX 125 08-12 R
(Brembo Front & Grimeca Rear caliper) 08-12 R
SX 125 08-13 R
SX 125 18-21 R

BAROSSA

100 Sport/Python 03-05 R
170 Cheetah 03-06 R
250 Cheetah 03-06 R

CAGIVA

WMX 125 89 R
WMX 250 89 R

CECTEK

500 EFI King Cobra 09-10 R
500 EFI Gladiator 09-10 R
500 EFI Quadrift 09-10 R
500i Estoc 10 R

C F MOTO

CF800 UU-A UForce 800 (Side x Side) 14-16 R

DERBI

DXR 200 Quad (Front drum model) 04-05 R
DXR 200/250 Quad (Front disc model) 04-07 R

DINLI

DL 450 RS (DL901) 06-09 F&R

EXPLORER

Trasher 450 08-09 F&R

GOES

G 225 S 12-13 R
G 350 S (Quad) 08-14 R

GOGORO (E SCOOTER)

Smartscooter 15-17 R

HUSABERG

All models (central fixing pin in pad) 89-92 R
All models (fixing pin at end of pad) 93-94 R

KAWASAKI

KSR1 (KMX 50 B1/B2) 90-91 R
KSR II (KMX 80 B1/B2) 90-91 R

KH 100 G4

83 F
KH 100 G5-G8 (EX) 84-87 F

AR 125 A1-A7/B1-B8

82-94 F

KH 125 K2-K10

82-98 F

KH 125 L1 (EX)

84 F

KMX 125 A1-A5/B1-B9

86-98 R

KMX 125 B2-B12 (From E/No MX AE 013437)

87-03 R

KX 125 B2/C1

83-84 F

KX 125 D1

85 F

KX 125 E1

86 F&R

KX 125 E2/F1

87-88 R

KDX 200 C1/C2/C3

86-88 F

KDX 200 E1/E2/E3/E4

89-92 F

KMX 200 A2/A3

88-92 R

Z 200 A6

83 F

BJ 250 B1-B7A Estrella

92-99 F&R

BJ 250 C1-C7 Estrella RS

99-02 F&R

KL 250 J1/J3 Stockman

R

KL 250 G1/G1A Super Sherpa

97 R

KL 250 D2-D22

84-05 F

KLX 250 Super Sherpa

98-09 R

KR 250 A1/A2

84-86 F

KX 250 C1/C2

83-84 F

KX 250 D1

85 F

KX 250 D2

86 F&R

KX 250 E1/F1

87-88 R

KXT 250 A2 Tecate - 3 Wheel Model

85 F&R

KXT 250 B1 Tecate - 3 Wheel Model

86 F&R

KXT 250 B2 Tecate - 3 Wheel Model

87 F

ZR 250 B6 Balius-II

02 R

KLF 300 B1-B17 Bayou

88-09 F

GPZ 305 A1/B1-B10

83-96 F

ZR 400 A1/B1 (Z 400 F)

83-84 F

Z 400 C2/C3 (Z 400 F2) 85-87 F

ZL 400 B Eliminator 400 SE 88 F

FX 400 R (ZX 400 E1-E3) 86-88 F

GPZ 400 R (ZX 400 D/D3/D3A) 85-87 F

GPZ 500 S (EX 500 B1-B5) 88-93 F

GPZ 500 S (EX 500 E1-E10) 94-04 R

KX 500 A1/A2 83-84 F

KX 500 B1 85 F

KX 500 B2 86 F&R

KX 500 C1/D1 87-88 R

GT 550 G1-G9 83-01 F

ZR 550 A1/A2 (Z 550 F) 83-84 F

KLR 600 A1/B2/B1-B4/B6-B9 84-94 F

KL 650 B1-B3 Tengai 89-92 R

KLR 650 C1-C10 95-04 R

KTM

D-XC/E-XC/E-GS 92-93 R

MX 125 92-93 R

D-XC/E-XC/E-GS 125 90-91 F&R

EXC 125 Brembo Calipers 89 F&R

MX 125 Brembo Calipers 89-91 F&R

D-XC/E-XC/E-GS 250 (Brembo Calipers) 91 F&R

D-XC/E-XC/T-XC/E-GS 250 92-93 R

(Grimeca calipers) 92-93 R

EXC/EGS 250 (Brembo Calipers) 89 F&R

MX 250 (Brembo Calipers) 89-91 F&R

MX 250 (Brembo Calipers) 92-93 R

DXC/EXC/EGS 350 (Brembo Calipers) 90-91 F&R

EXC 350 (Brembo Calipers) 89 F&R

MX 350 (Brembo Calipers) 89-91 F&R

LC-4 MX 500 (Brembo Calipers) 90-91 F&R

LC-4 EXC 500 (Brembo Calipers) 90-91 F&R

MX 500 92-94 R

LC4 MX 600 (Brembo Calipers) 90-91 F&R

LC4 EXC 600 92-93 R

LC4 EXC 600 (Brembo Calipers) 90-91 F&R

SX 620/EXC/EGS 94 R

KYMCO

Agility 125 (C20000 - 16" Wheels) 08-15 R

Agility 125 City & City + 18-21 R

Visa R 50 11-15 F

Visa R 110 11-15 F

Visar R 125 11-15 F

LINHAI

ATV 80/150 13 R

MAICO

500 MX 94-98 R

BRAKE PAD BUYERS GUIDE

DO NOT REFIT ANY SHIMS/INSULATORS TO EBC PADS FROM ORIGINAL PADS UNLESS INSTRUCTED ON NOTE ON PAD PACKAGING AND ON FA DRAWING ASSOCIATED WITH THAT PAD.

FA067 A 55.5 x 37 x 10mm**B 85 x 43 x 8mm****FA067/3 A 55.5 x 37 x 10mm****B 85 x 43 x 7mm****Contd.**

OSSA			250e	06-11	F&R	Blade 460 R Target	12	R
500	92	R	Stinger R250E	06	R	Blade 460 IRS Target	12	R
560	92	F&R	QZ 250 (Front disc model)		F&R	Blade 460 SL IRS 4 x 4	12	R
PEUGEOT			QZ 270		F&R	Target 500 (4x2)	09-10	R
City Star 125 Blue Line (AC/Carb)	15	R	300e XLC	06-07	R	Blade 510 LE	11-12	R
PEUGEOT (Contd.)			300e Stinger	09-11	F&R	Blade 525 SL 4 x 4	09-10	R
Django 125 Allure (4T/190mm Rear Disc)	14-19	R	300e XLC	07-08	F&R	525 SE 4 x 4	09	R
Django 125 Allure SBC (4T/190mm Rear Disc)	14-19	R	300e XLC Stinger	07-08	F&R	Target 525 (4 x 4)	09-11	R
Django 125 Evasion (4T/190mm Rear Disc)	14-19	R	300SE 4 Valve	06-07	R	Blade 550 LT 4 x 4	10-11	R
Django 125 Evasion SBC (4T/190mm Rear Disc)	14-19	R	Jow 300	07-08	F&R	Blade 550 SE 4 x 4	09-11	R
Django 125 Heritage SBC (4T/190mm Rear Disc)	14-19	R	QZ 300 XLC		F&R	Blade 550 SL 4 x 4	09-10	R
Django 125 S (4T/190mm Rear Disc)	14-19	R	RL 300 Buggie	09-11	F&R	Blade 550 IRS Target	11-12	R
Django 125 Sport (4T/190mm Rear Disc)	14-19	R	320 CUV		F&R	550 IRS Blade LT	10-12	R
Django 125 Sport SBC (4T/190mm Rear Disc)	14-19	R	RS7 4WD	10-11	R	VECTRIX		
Django 150 Allure (4T/190mm Rear Disc)	14-19	R	RS8	10-11	R	VT-1	14	R
Django 150 Evasion (4T/190mm Rear Disc)	14-19	R	QZ 450 RS	06-09	F&R	YAMAHA		
Django 150 S (4T)	14-19	R	QZ 450 Sport	08-09	F&R	YFM 90 RZ/RA/RB/RD Raptor		
Django 150 Sport (4T/190mm Rear Disc)	14-19	R	X7R	10-11	R	(With Rear Parking Brake)	10-13	R
Django 150 Sport SBC (4T/190mm Rear Disc)	14-19	R	XLC 500	10-15	F&R	YFM 300 B/D Grizzly	12-13	R
SUZUKI								
Django 150 Allure (4T/190mm Rear Disc)	14-19	R	OR 50 ET	80	F	FA067/2 - FANTIC		
Django 150 Evasion (4T/190mm Rear Disc)	14-19	R	RB 50 H GSXR 50	87	F	50 Strada	82	F
Django 150 S (4T)	14-19	R	RG 50 EW		F	50/50.1 Raider	81	F
Django 150 Sport (4T/190mm Rear Disc)	14-19	R	ZR 50 SLKX	81	F	MALAGUTI		
Django 150 Sport SBC (4T/190mm Rear Disc)	14-19	R	ZR 50 SKX/SKE/SKH	83-87	F	50 MDX Gold Enduro	87-	F
Django 150 Sport (4T/190mm Rear Disc)	14-19	R	GN 125 R/V/W/X/Y/K1 (NF41A)	94-01	F	50 Enduro MEX	87-	F
PHB								
500	92	R	GN 125 ER/EV/EW/EX/EY/EK1 (NF41A)	94-01	F	50 Enduro MSX	85-	F
560	92	F&R	GN 125 HS (LC6PCJB1/Chinese production)	00-10	F	SACHS (HERCULES) Also see SFM section		
POLARIS (ATV)								
200 Phoenix Quadricycle Model (EA/EB/Rear disc model)	05	R	GS 125 ESZ	82	F	50 Supra 4 GP		F
200 Phoenix Quadricycle Model (EC/ED Models/Rear disc model)	05-09	R	GS 125 ESR/ESX	95-00	F	FA067/3 - KAWASAKI		
200 Phoenix Quadricycle Model (Rear disc model)	10	R	TU 125 X/TUX/XTX	99	F	KLE 250 A2 Anhelio	95	R
200 Sawtooth Quadricycle (Rear Disc Model)	06	R	GSX 400 FX/FZ/FD	81-83	F	KLE 250 A3	97	R
200 Sawtooth Quadricycle (Rear Disc Model)	08	R	X4 125		F	KLE 250 A5/A6	00-01	R
QUADZILLA (inc. White Knuckle Models)								
Pro Shark 100 (RMX) (Front disc models)		F	GSX 250 FXK2/K3/K4/K5 (ZR 250 C)	02-05	R	ZZR 250 (EX 250 H1-H13)	90-01	R
4 Cross 200 E SUV	06-07	R	SYM			ZXR 250 C1-C3 (ZX 250 C1-C3)	91-95	R
ST 200 E (5 speed manual)	06-07	R	JET V (125cc/4T)	12-13	F	ZXR 250 R (ZX 250 D1)	91	R
QZ 200 (Front disc model)		F&R	TGB			ZR 250 A1-A5 Balius	91-95	R
			250 Blade/Congo ATV	06-07	F	ZR 400 D1/D3/D4 Xanthus	92-95	R
			Blade 325 Quad (4x2)	07-11	R	GPZ 500 S (EX 500 D1-D7)	94-01	R
			Blade 325 LE Quad (4x2)	08-10	R	KLE 500 A1-A12	91-04	R
			Blade 325 SL Quad (4x2)	11-12	R	KLE 500 B1P/B6F/B7F	05-07	R
			Target 325 (4x2)	09-12	R	KLR 650 A1-A3	87-89	R
			Target 400 (4x2)	09-10	R	KRAM-IT (KRAMER)		
			Target 425 (4 x 4)	09-11	R	ER 125/250/300 RV3	88-	R
			Blade 450 SE (4 x 4)	10-11	R	ER 500/600	96-	R

FA068 68 x 41 x 9.5mm

MATERIAL AVAILABILITY											
FA	TT	V	R	HH	MXS	SXR	EPFA	GPFA	SFA	SFAC	SFAHH
✓		✓		✓							

KAWASAKI											
Z 250 A3				81	F	Z 750 H1/H2/LTD			80-81	F&R	
Z 400 J2/J3				81-83	F	Z 750 L1/L2/L3/L4			81-84	F&R	
Z 440 C2				81	F	Z 750 N1/N2 'Spectre'			82-83	F&R	
Z 440 D5/D6 (LTD)				83-84	F	GT 750 P1-P9			82-96	F&R	
Z 440 H1/H2				82-83	F	GPz 750 R1			82	F&R	
GPZ 550 H1/H2				82-83	F&R	Z 750 Y1 (LTD)			82	F	
GPZ 550 D1				82	F&R	Z 1000 R1/R2 (Eddie Lawson Replica)			82-83	F&R	
Z 550 A2/A3/C1/C2/LTD				81-84	F	Z 1000 J1/J2/J3			81-83	F&R	
Z 650 F2/F3/F4				80-83	F	Z 1000 K1/K2 LTD			81-82	F&R	
Z 700 A1 'Ltd'				84	F&R	Z 1100 A1-A3			81-83	F&R	
Z 750 E1				80	F&R	GPz 1100 B1/B2			82-83	F&R	
						Z 1100 D1/D2 'Spectre'			82-83	F&R	

FA069 90 x 49 x 10mm

FA069/2 90 x 49 x 9mm

FA069/3 90 x 49 x 11.5mm



MATERIAL AVAILABILITY											
FA	TT	V	R	HH	MXS	SXR	EPFA	GPFAX	SFA	SFAC	SFAHH
✓		✓		✓							

HONDA

CB 125 TDC/TDE/TDJ	83-89	F
CBX 125 F	84-	F
CBX 250 RSE	84	F
NS 400 RF/RG	85-87	F&R
CMX 450 CH/CJ Rebel	87-88	F
CX 500 CC	82	F
CX 500 EC	82	F&R
CX 500 TCC 'Turbo'	83	F&R
FT 500 C	82	F&R
GL 500 DC	82	F
VF 500 FE/F2E/FF/F2F	84-85	F&R
XBR 500 F/G/H/SJ	85-89	F
XL 600 LMF/RMG/RMH	85-87	F
XL 600 VH/VJ/VK "Transalp"	87-90	F
CX 650 ED	83	R
CB 750 FC/F2C/FD/F2D	83-84	R
CBX 750 FE	84	F
VF 750 C Shadow	83	F
VF 750 FD/FE	83-84	F
VF 750 SC (V45 Sabre)	82	F
XLV 750 R (RD/RF)	83-88	R

HONDA

CB 900 FB/F2B	82-85	R
CB 900 FC/F2C/FD/F2D	84-85	F&R
CBX 1000 B/C	81-82	R
VF 1000 FE/FF/FG/F2F/F2G	84-86	F
VF 1000 RE/RF/RG	84-86	F
CB 1100 RBII/RCII/RDII	80-83	F&R
GL 1100 C/DC/AD 'Goldwing'	82-83	R
FA69/2 HONDA		
CN 250 H/J/L/M/P/R/S/T/N/X SPAZIO/Helix	87-98	F
GB 250 E/H 'Clubman'	84-87	F
NS 250 FE/RE (MC11-100)	84	F
NS 250 RG (MC11-102)	86	F
CB 400 NC	82	F
CX 650 TD 'Turbo'	83	F
CX 650 ED	83	F
GL 650 D2-E	84	F
CB 750 FC/F2C/FD/F2D	83-84	F
CB 900 FB/F2B	82-88	F
CBX 1000 B/C	81-82	F
GL 1100 C/DC/1C Interstate 'Goldwing'	82	F
GL 1100 AC Aspencade 'Goldwing'	82	F
GL 1100 C/DC/AD	82	F

FA69/3 HONDA

NS 250 FE/RE (MC11-100)	84	R
NS 250 RG (MC11-102)	86	R
NSR 250 RG (MC16-100)	86	R
CBR 400 RG/RHYA (NC23)	86-87	R
VFR 400 ZG/ZH/RG-YA (NC21)	85-87	R
CBR 500 FH/FJ/FK/FL	87-90	R
CBR 600 FH/FJ/FK/FL	87-90	R
CBR 750 FH Superaero	87	R
CBX 750 FE	84	R
VF 750 FD/FE	83-84	R
VF 750 CH	87	F
VFR 750 FG/FH	86-87	R
VF 1000 FE/FF/FG/F2F/F2G	84-86	R
CBR 1000 FH/FJ	87-88	R
CB 1100 RB2/RC2/RD2	80-83	R
VT 1100 CH/CJ/CN/CP Shadow	87-93	F
GL 1200 DE/DF/DG/AE/AF/AG	84-86	F&R
GL 1500 J/K/L/SEM/SEN/SEP/SER/SES/SEV/SEW/SEX/SEY "Goldwing"	88-00	R

FA070 66.5 x 59 x 10mm

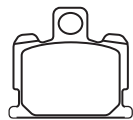

MATERIAL AVAILABILITY											
FA	TT	V	R	HH	MXS	SXR	EPFA	GPFAX	SFA	SFAC	SFAHH
✓		✓									

YAMAHA

RD 50 MX/RD 50	81-87	F	XJ 550	81-84	F
RD 80 (Air Cooled)	82	F	XJ 550 H/J/K Maxim	81-83	F
RD 250	80-83	F	XJ 550 RH/RJ/RK Seca	81-83	F
RZ 250 (4L3)		F	XJ 750	82-84	F
RD 350 LX	81-82	F	XJ 750 RF/RJ/RK Seca	81-83	F
			XS 1100 S	81	F

FA071 69.5 x 54 x 6.5mm

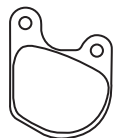

MATERIAL AVAILABILITY											
FA	TT	V	R	HH	MXS	SXR	EPFA	GPFAX	SFA	SFAC	SFAHH
✓		✓									

HARLEY DAVIDSON

FX/FXE/FXEF/FXWG/FXS Late 78-83 F

FA072 89 x 71 x 6.5mm

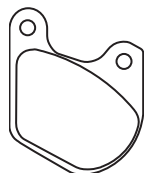

MATERIAL AVAILABILITY											
FA	TT	V	R	HH	MXS	SXR	EPFA	GPFAX	SFA	SFAC	SFAHH
✓		✓									

HARLEY DAVIDSON

XL/XLH/XLCH 73-81 R
FLT/FLHT/FHTCI 80-83 F

FA073 A 51.5 x 9.4mm B 50 x 8mm

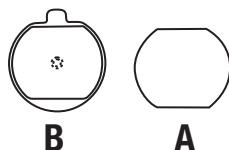

MATERIAL AVAILABILITY											
FA	TT	V	R	HH	MXS	SXR	EPFA	GPFAX	SFA	SFAC	SFAHH
✓											

KAWASAKI

Z 250 A1/A2	78-80	F	Z 650 (D2/D-SR)	79-80	F
Z 400 J1	80	F	Z 650 C3	79	F
Z 440 A2/C1	79-80	F	Z 650 F1	80	F
Z 440 D4 (LTD)	82	F	Z 650 D2/D3 (SR)	79-80	F
Z 500 B1/B2	79-80	F	Z 1000 A3/A4	79-80	F
Z 550 A1	80	F	Z 1000 H1/H2	74-75	F
			Z 1000 D3 (ZIR)	79	F

BRAKE PAD BUYERS GUIDE

DO NOT REFIT ANY SHIMS/INSULATORS TO EBC PADS FROM ORIGINAL PADS UNLESS INSTRUCTED ON NOTE ON PAD PACKAGING AND ON FA DRAWING ASSOCIATED WITH THAT PAD.

FA076 44 x 59 x 7mm

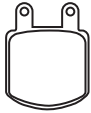

MATERIAL AVAILABILITY												
FA	TT	V	R	HH	MXS	SXR	EPFA	GPFA	SFA	SFAC	SFAHH	
✓		✓		✓								

ASPES

125 Duma

GARELLI

TSR 125

GILERA

80 TG 1/2/3

125 GR 1

125 TG 1/2/3

200 T4/T4 C/T4 S

GMA AFTERMARKET CALIPER

2 Piston (small) caliper model B (CCI # 09-996)

JAYBRAKE AFTERMARKET CALIPER

Early Design 2 Piston

KREIDLER

Mustang 125

LAVERDA

LZ 125 Sport (Grimeca Caliper) 80-82

MOTO MORINI

125 Monocilindro

250 All models

350 Sport

350 Sport

350 FT/Turismo

NVT

125/175 Rambler

FA077 60 x 58 x 9mm

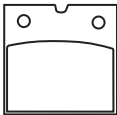

MATERIAL AVAILABILITY												
FA	TT	V	R	HH	MXS	SXR	EPFA	GPFA	SFA	SFAC	SFAHH	
✓		✓										

BENELLI

900 SE1 (6 cyl)

R

BMW

R 65

R 80/R 80 RT

R 80 GS

R 80 PD/CH

R 850 GS

07/88-08/89

84-07/95

87-95

90-95

96

R 100 GS

R 100 PD

LAVERDA

1000 RGS Corsa

MOTO GUZZI

850 Le Mans III (12 spoke cast wheel)

1000 - 1000 SP (12 spoke cast

wheels/dished front discs)

86-94

89-96

84

81-84

79-83

F

F

F

R

R

FA078 74 x 49 x 12mm



MATERIAL AVAILABILITY												
FA	TT	V	R	HH	MXS	SXR	EPFA	GPFA	SFA	SFAC	SFAHH	
✓		✓		✓								

HARLEY DAVIDSON

FX/FXE/FXEF/FXWG/FXS

FXWG/FXSB

XL/XLH/XLCH/XLS/XLX

84-86

83

82-Early 87

FXD, FXDL, FXDWG, FXR, FXRS,

FXRT, FXRD, FXLR

FXST, FXSTB, FXSTC, FXSTS, FLST, FLSTC, FLSTF,

FLSTS, FLSTN

82-early 87

84-Early 87

R

R

R

FA079 174 x 73 x 9.5mm

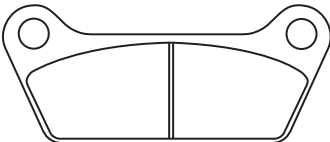

MATERIAL AVAILABILITY												
FA	TT	V	R	HH	MXS	SXR	EPFA	GPFA	SFA	SFAC	SFAHH	
✓		✓										

HARLEY DAVIDSON

FL/FLH

FLT/FLHT/FLHTCI

81-84

80-85

R

R

FA080 92 x 53 x 8mm

FA080/2 92 x 53 x 9.5mm

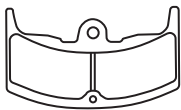

MATERIAL AVAILABILITY												
FA	TT	V	R	HH	MXS	SXR	EPFA	GPFA	SFA	SFAC	SFAHH	
✓												

HONDA - FA80

CBX 550 FC/F2C/FD/F2D

HONDA - FA80/2

MXV 250 F (MC92)

82-84

83-88

VT 250 FD

VF 400 FD

VT 500 ED/EF

CBX 550 FC/F2C/F2D/FD

83

83-85

83-85

82-84

F

F&R

F

R

FA081 68 x 60 x 10.5mm



MATERIAL AVAILABILITY												
FA	TT	V	R	HH	MXS	SXR	EPFA	GPFA	SFA	SFAC	SFAHH	
✓			✓									

YAMAHA

DT 80 LC (37A)

RD 80 LC

RX 115 (5FS3)

RD 125 LC

SR 125 SE

RX 135 (13X)

RZ 250 R (29L)

SR 250 Classic (21L)

81-84

82

99

82-84

92-96

81

96-00

XV 250 Virago

RD 350 YPVS

XS 400

XZ 550

XT 600

XT 600 (Z Tenere)

XJ 650 Turbo

XJ 650 LK 'Seca'

89-94

83-84

82

82-84

84-86

84

82

83

F

F

F

F

F

F

F

F

FA083 A 47.5 x 37 x 9mm
B 85 x 42.5 x 7mm

FA083/2 A 47.5 x 37 x 10mm
B 85 x 42.5 x 8mm

Pixel 50	08-12	F	200 Sawtooth (Rear drum model)	06-08	F	Delivery 50 (From FE no 609100)	06-12	F
Focus 125	06-07	F	200 Sawtooth Quadricycle			Hornet 50/90 Quad	04-05	R
Dragon 250 Quad	07-09	F	(Rear disc model)	06/08	F	Tapo RR 50 2T	10-12	F
350i Index	13-14	R	QUADZILLA			Tapo RS 50 (2T)	10-12	F
KREIDLER			ZR 50	07-09	R	Trigger 50	02-03	F
e-Florett 3.0 (4.0KW)	14-15	R	X 50		R	X Race 50 (2T)	11-12	F
MALAGUTI			R 100 (Rear disc model)	06-09	R	High Wheel 50	02-03	F
Centro 50 (4T)/SL	08-11	F	X 100		R	F409 Cruise 50/125	02-05	F
F10 WAP	10-11	F	Magmax		R	R 125 X Bullet	08-09	R
MASAI			Black Max M100 (SE)	06	R	250 Blade/Congo ATV	06-07	R
L 150	05-07	R	Pro Shark 100 (RMX) (Front disc model)		R	303 Revolution (50/125cc)	02-03	F
A 300/450 Quad	05-07	F	Pro Shark 100 (Single 4 Arms)		R	303 R Hawk/Laser (50cc)	04-14	F
MH			Pro Shark (Double 4 arms)		R	204 Classic (125cc)	03-04	F
MH10 50 Enduro	13-14	R	Stinger R 250 E	06	F	R 50 X Bullet	06-10	F
MH10 50 SM	13	R	300 E XLC	06-07	F	R 50 X Bullet	10-14	R
MH10 Eco Urban	14	R	300 SE 4 Valve	06-07	F	R 125 X Bullet	10-14	R
MH10 Pro 50 Enduro	13-14	R	4 Cross 200 E SUV	06-07	F	Blade 325 Quad (4x2)	07-11	F
MH10 Pro 50 SM	13	R	X 100 E (XLC)	06-07	R	Blade 325 SL 4x2	11-12	F
MH10 Pro Urban 50	14	R	Pro Shark-E	06	R	Target 325 (4x2)	09-11	F
RYZ 50 Enduro	13-14	R	ST 200 E (5 Speed Manual)	06-07	F	Target 400 (4x2)	09-10	F
RYZ SM 50	13	R	QUADRA			Target 425 (4x4)	09-11	F
RYZ Pro SM 50	13	R	350 D	11-15	R	Blade 460 R Target	12	F
Duna 125	13-14	R	350 S	13-15	R	Blade 460 IRS Target	12	F
Duna Pro 125	13-14	R	350 4	14-15	R	Target 500 (4x2)	09-10	F
MH10 125 Enduro	13-14	R	350 D Parking Brake	11-15	PB	Target 525 (4x4)	09-11	F
MH10 125 SM	13	R	350 S Parking Brake	13-15	PB	TM		
MOTO-ROMA			350 4 Parking Brake	14-15	PB	80/85 Minicross/Junior	96-00	F
Grand Prix 50/100	99-03	F	QV3	18-20	F	VECTRIX		
Grand Prix 125	02	F&R	Qooder	18-20	F	VX2	12-14	R
Lazer 125 Buggie	03-07	R	RIEJU			VIALLI		
Geko 300 Quad	04-06	F	MIUS-Electric	12-15	F&R	RX Sport 50	06	F
MZ/MUZ			RS NKD 50 (Scooter)	13-15	F	YAMAHA		
Moskito 50/50 SX	02	F	RS Sport 50 (Scooter)	12-15	F	YFM 90 RY	09	R
Moskito 125	02	F	Urban Blast (50)	13-15	F	YFM 300 B/D Grizzly	12-14	F
VRS 150 Quad	05	R	RS3 NKD 50	12-20	R	ZERO		
PEUGEOT (Heng Tong calipers)			RS3 125 (Sport)	11-20	R	Zero DS ZF6	10-12	R
Various Scooter models			RS3 NKD 125	11-20	R	Zero DS ZF9	10-12	R
(Check pad shape)		F	ROXON			Zero S ZF6	10-12	R
E-Powered by GenZe	18	F&R	RX 150 (Quad)	04-06	R	Zero S ZF9	10-12	R
Kisbee 50 (2T/4T)	10-20	F	Sport Spirit NFS 150 (Quad)	04-06	R	Zero XU	10-12	R
Kisbee 50 RS (2T/4T)	10-20	F	SCARABEO			Zero X	10-12	R
Looxo 50 (Heng Tong Caliper			50 Yourz (4T)	12-14	F	Zero MX	10-12	R
/Drum rear)	01-06	F	SCORPA					
Trekker 50 (2T) Heng Tong Caliper	98-00	F	T-Ride 125 (2T)	12-15	F&R	FA083/2 - HONDA		
Speedfight 50 LC Darkside	13	R	T-Ride 280 (2T)	12-15	F&R	MB 80 (MB8)	80-	F
Speedfight 50 1/2	97-08	F	SHERCO			MCX 80	82-	F
Vivacity 50 (12" wheels/190mm disc)	92-07	F	50 SE-R	14-15	F&R	KAWASAKI		
Vivacity 2 (50cc) (10" wheels			50 SM-R	14-15	F&R	KSR1 (KMX50 B1/B2)	90-91	F
/190mm disc)	08-11	F	X-Ride 125	12-20	F&R	KSR11 (KMX80 B1/B2)	90-91	F
Kisbee 100 (4T)	12-15	F	X-Ride 290	12-15	F&R	SUZUKI		
Speedfight 4 125 (4T)	17-19	F	50cc Americas SM-RS	19-21	F&R	AN 125 HKK5	06-08	F
Metropolis 400 T (3 Wheel Model			50cc Americas SM-R	19-21	F&R	GILERA		
- Parking brake)	14-16		50cc Factory SE-R	19-21	F&R	Stalker 50	03-11	F
Metropolis 400 T- RS (3 Wheel Model			50cc Factory SE-R	19-21	F&R	GOES		
- Parking brake)	14-16		50cc Factory SM-RS	19-21	F&R	G 90 XS	10-13	R
Metropolis 400 Blue Line			50cc Factory SM-R	19-21	F&R	G 225 S	12-13	F
(3 Wheel Mode - Parking brake)	15-16		SUZUKI			PIAGGIO		
Metropolis 400 RS (3 Wheel Model			AD 50 T/Tune/V-Tune	88	F	NRG 50 DD	06-18	F
/Nissin Caliper- Parking Brake)	17-18		AE 50 R		F	NRG 50 Pure Jet	06-09	F
Metropolis 400 RX-R (3 Wheel Model			AJ 50 ZZ/RS Sepia	92-	F	NRG 50 Power DT	05-15	F
/Nissin Caliper- Parking Brake)	17-18		CP 50 C		F	NRG 50 Silver Bullet	10	F
Metropolis 400 Allure (3 Wheel Model			CR 50 DC		F	SCARABEO		
/Nissin Caliper- Parking Brake)	17-18		RM 80 XG/XH/XJ/XK	86-89	F	50 (2T) Street	10-15	F
PGO			RM 80 XL/XM/XN/XP/XR/XS	90-95	F&R	50 Net (4T/4V)	10-11	F
Galaxy 50	93-00	F	RM 80 T/V/W/X/Y/K1	96-01	R	50 (4T/4V)	10-15	F
Mega 50	94-	F	RM 85 K2/LK2/K3/LK3/K4/LK4	02-04	R	100 (4T)	10-14	F
XL Rider 50	07-08	R	AH 100 P Address	95-96	F	ZERO		
XL Rider	07-08	R	UE 125 CTK1	01-03	F	Zero DS (ZF6.0/ZF9.0) (2 Pin fixing f/pad)	10-12	R
Rider 150 50/90/110	04-05	R	UE 150 CTK1	01	F	Zero X (2 Pin fixing f/pad)	10-12	R
PIAGGIO			TGB			Zero XU (2 Pin fixing f/pad)	11-12	R
NRG 50cc Power DD	05-21	F	Bullet 2 50 (2T)	11-12	F	Zero MX (2 pin fixing f caliper)	10-12	R
POLARIS			Bullet 50 RS (2T)	11-12	F&R	Zero S (ZF6.0)(2 Pin fixing f calipers)	10-12	R
200 Phoenix (AC/AD Model and			Bullet 50 RR	11-12	F&R			
following/rear drum model)	06-09	F	City 50cc (2T)	07-08	F			
200 Phoenix Quadricycle Model			City 50cc (4T)	07-11	F			
(EC/ED Models/Rear disc model)	05-09	F	202 Classic (50cc)	03-14	F			

BUYERS GUIDE

DO NOT REFIT ANY SHIMS/INSULATORS TO EBC PADS FROM ORIGINAL PADS UNLESS INSTRUCTED ON NOTE ON PAD PACKAGING AND ON FA DRAWING ASSOCIATED WITH THAT PAD.

FA084 46 x 45 x 8mm

FA084/2 46 x 45 x 6.5/8mm

FA084/3 46 x 45 x 6.5mm



MATERIAL AVAILABILITY - FA084											
FA	TT	V	R	HH	MXS	SXR	EPFA	GPFA	SFA	SFAC	SFAHH
	✓		✓		✓						

MATERIAL AVAILABILITY - FA084/2											
FA	TT	V	R	HH	MXS	SXR	EPFA	GPFA	SFA	SFAC	SFAHH
✓	✓		✓								

MATERIAL AVAILABILITY - FA084/3											
FA	TT	V	R	HH	MXS	SXR	EPFA	GPFA	SFA	SFAC	SFAHH
✓	✓		✓		✓						

FA084

ARCTIC CAT

400 DVX (2x4) Sport 04-08 F
400 DVX TS Sport 06-07 F

HONDA

CR 80 RG/RH/RJ/RK/RL/RM/RN/RR/RS/RT
/RBT/RV/RBW/RX/RBX/RY/RBY
/R1/RB1/RB2/R2 86-02 F
CR 85 R3-R7/RB3-RB6/RS7 03-07 F
CRF 150 R Small wheel (FR 17"/RR 14") 07-21 F
CRF 150 RB Big wheel (FR 19"/RR 16") 07-21 F
ATC 200 XD 83 F&R
ATC 250 RD 83-84 F&R
ATC 250 RC 82 F
TRX 250 EX1/2/3/4/5/6/7/8 01-08 F
TRX 250 X9/XA/XB 09-11 F
TRX 300 EX P/R/S/T/V/W/X/Y/1-8 93-08 F&R
TRX 300 X9 09 F&R
TRX 400 EXX/EXY/EX1/EX8 99-08 F&R
TRX 400 X9 09 F&R
TRX 420 FE7/FE8/FE9/FEA/FEB 07-11 F
TRX 420 FA9/FAA/FAB Fourtrax - Auto 4WD 09-11 F
TRX 420 FM7/FM8/FM9/FMA/FMB 4WD Fourtrax 07-11 F
TRX 420 FPA9/FPAA/FPAB Fourtrax Auto Power Steering 09-11 F
TRX 420 FPM9/FPMA/FPMB Fourtrax 4WW Power Steering 09-11 F
TRX 420 TE7-TE9 Fourtrax ES 2WD 07-09 F
TRX 420 TM7/TM8/TM9/TMA/TMB Fourtrax 2WD 07-10 F
TRX 420 All Models 14-21 F
TRX 500 FEC Fourtrax Foreman ES 2x4 HD 12 F
TRX 500 FMC Fourtrax Foreman S 2/4WD 12 F
TRX 500 FPC Fourtrax Foreman 2/4WD 12 F
TRX 500 FAC Fourtrax Foreman AT 2/4WD 12 F

HONDA HM (Italy)

CR 85 R/R2 03-07 F
CR 150 R/R2 07-09 F

HUSQVARNA

CR 125 92-94 R
WR 125 93-94 R
CR 250 92-94 R
WR 250 92-94 R
TE 350 92-94 R
CR 360 92-94 R
WR 360 92-94 R
TC 610 92-94 R
TE 610 92-94 R

KAWASAKI

KX 80 L1-L3/N2/N3/R1-R7/T1-T6
/W1/W2/W3 88-00 R
KX 85 (17" front wheel/14" rear wheel) 01-21 R
KX 85 (19" front wheel/16" rear wheel) 01-21 R
KX 100 A1/A2/B1-B7/C1/C2/C3 89-21 R
KSF 250 A1-A18 87-04 R
KXT 250 B2 Tecate 3 Wheel Model 87 R
KEF 300 B1/B2/B3 Lakota Sport 01-03 R
KVF 400 A1/A2/A3 (KFX 400) 03-05 F
KFX 450 R Quad (KSF 450 B8F/B9F /BAF/BCS/BDF/BEF) 08-14 R

SUZUKI

RM 100 K3 03 R
RM 125 J 88 R
RM 250 H J 87-88 R
LT-Z 250 K4-K9/L0 QuadSport 04-12 F
LT-Z 400 K3-K9/L0/L1-L3 03-15 F

YAMAHA

YZ80 93-01 R
YZ85 Small wheel 02-22 R
YZ85 Big wheel 02-22 R
YZ125W 1989 R
YZ250W 1989 R
YFS 200 R/S/T/V Blaster 03-06 R
YFM 250 RX/RV Raptor 08-09 R
YFM 250 R (33B) 09-11 R

YFM 250 R (BT) 12-13 R

YFZ 350 T/U/W/A/B/D/E/F/G/H/J/K/L
/M/N/P/R/S/T/V Banshee 87-09 R

YFM 350 XD/XE/XF/XG/XH/XJ/XK/XL
/XM/XN/XP/XR/XS 92-04 R

YFM 350 FXG/FXH/FXJ/FXK/FXL/
FXM/FXN/FXP/FXR/FXS Wolverine 95-04 R

YFM 350 S/T/V/R-WV/RW
/RX/RY/RZ Raptor 04-10 F&R

YFM 400 FWP Big Bear 4x4 02 F
YFZ 450 S/T 04-05 R

YFM 600 FWAK/FWAL/FWAM
/FWAN 'Grizzly' 98-01 F

YFM 600 HM "Grizzly Hunting" 00 F
YFM 660 RN/RP/RR/RS Raptor 01-04 F&R

YFM 660 FWAP/FWAR/FWAS/FWAT
/FWAV/FGW/FGX Grizzly 02-08 F

YFM 660 FR/FS/FT Grizzly 03-05 F

FA084/2

ATC 200 XD 83 F&R

FA084/3

RM 125 J 88 R
RM 250 H/J 87-88 R

SUZUKI

80/85 Minicross/Junior 96-00 R

HONDA

CRF 150 FB (Big Wheel FR 19"/RR16") 07-16 R

YAMAHA

YZ 65 18-21 R
YZ 80 E/F/LWF/LWG/G/LWH/H/LWJ/
J/LWK/K/L/LWL/LWM/M/LWN/N 93-01 R
YZ 85 (2T Small Wheel F17"/R 14") 02-20 R
YZ 85 (2T Big Wheel F19"/R 16") 02-21 R
YZ 125 W 89 R
YZ 250 W/WRW 89 R

FA085 A 111 x 50 x 9.5mm

B 69 x 43.5 x 9mm

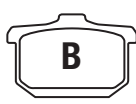

MATERIAL AVAILABILITY											
FA	TT	V	R	HH	MXS	SXR	EPFA	GPFA	SFA	SFAC	SFAHH
✓		✓		✓							

GENERIC
Vertigo 125 (4T) 12-13 F
VN 750 A2-A5/A10 86-94 F
VN 800 A1-A3 95-99 F
GPz 900 R (A1-A6) 84-89 F&R
ZL 900 A1/A2 'Eliminator' 85-86 F&R
GPz 1000 RX (A1-A3) 86-88 F&R
ZL 1000 A1 87 F&R
1000 GTR (ZG 1000 A1-A7) 86-93 F&R
1000 GTR (ZR 1000 A9-A14) 94-99 R
GPz 1100 A1-A3 83-85 F&R
Z 1100 R1 84 F
VN 1500 B2-B6 (VN15SE) 88-92 F&R
VN 1500 A6 (VN15) 92 F&R
VN 1500 C1/C2 (VN15) 94-95 F&R
VN 1500 D1/D2/E1/E2 'Classic' 96-99 R
VN 1500 G1/G2 'Classic Tourer' 98-99 R

KAWASAKI
EL 250 'Eliminator' 87-89 F
EL 250 D1-D5 90-94 F
EL 252 (EL 250 F2/F3/F5/F6) 96-03 F
ER 250 B1-B3 (Z250T Scorpion) 83-88 F
GPZ 250 R (EX 250 E) 86 F&R
KR 250 A1/A2 84-86 R
Z 400 C2/C3 (Z 400 F2) 85-87 R
ZL 400 A 'Eliminator' 86-87 F
FX 400 R (ZX400 E1-E3) 86-88 R
GPX 400 R (ZX 400 D1/D3/D3A) 85-87 R
LTD 454 (EN 450 A1-A5) 86-89 F
EN 500 A1-A3/B1-B2/C1-C9 90-04 F
GPz 550 A1-A4 (ZX 550 A1-A4) 84-87 F&R
GPz 600 R A1-A5A 85-89 F&R
VN 700 A1 'Vulcan' 85 F
ZN 700 A1/A2 'Ltd' 84-85 F&R
GPz 750 A1-A5 83-87 F&R
GPz 750 E1-E2 (Turbo) 84-87 F&R
GPz 750 R G2/G3 85-86 F&R

FA086 77 x 42 x 7mm

FA086/2 77 x 42 x 8.5mm

Speedfight 4 Darkside (50cc/AC/2T & 4T)	15-18	F	SCOMADI			RT 125 D Karion	07-15	F
Speedfight 4 Iceblade (50cc/AC/2T & 4T)	15-18	F	TL 50 Air Cooled	15-19	F	RX 125 D (XRX)	08-11	F
Speedfight 4 Pure (50cc/AC/2T & 4T)	15-18	F	TL 125 Air Cooled	15-19	F	XRX 125 Supermoto	07-11	F
Speedfight 4 Classic (50cc/LC/2T & 4T)	15-19	F	TL200 Liquid Cooled	15-19	F	GT 250 i (Naked)	13-15	F
Speedfight 4 Darkside (50cc/LC/2T & 4T)	15-18	F	SFM			GT 250 R (Carbs)	05-07	F&R
Speedfight 4 Iceblade (50cc/LC/2T & 4T)	15-18	F	ZX 125 Enduro (Spoke Wheels)	13-15	F	GT 250 i R	08-13	F&R
Speedfight 4 Pure (50cc/LC/2T & 4T)	15-18	F	ZZ 125 SM (Cast Wheels)	13-15	F	GT 250 i R	14-15	F
Speedfight 4 R-Cup (50cc/LC/2T)	18-19	F	SINNIS			GT 250 (Naked)	06-12	F&R
Speedfight 4 20 Ans Edition (50cc/AC/2T)	18	F	Nitro 125 (WY 125 T-56A)	09-10	F	GV 250 i Classic	08-15	F
Speedfight 3 125 (4T)	14-15	F	SMC			GT 650 R	07-08	F&R
Speedfight 3 125 Darkside (4T)	14-15	F	YB 125	09	F&R	GT 650 Comet & Naked	07-08	F&R
Speedfight 3 125 Iceblade (4T)	14-15	F	YB 150	09	F&R	GT 650 (Naked)	09-11	R
Speedfight 3 125 Team (4T)	14-15	F	YB 250	09	F&R	GT 650 i R	09-13	R
QUADZILLA			SUPERBYKE			GT 650 i (Naked)	12-15	R
WK 110	06-08	R	CQ 50 Road Classic		R	GV 650 (EFI)	07-12	F&R
WK 125	06-09	R	CU 125 Road Classic		R	GV 650 i Pro	12-15	F&R
SACHS						GT 650 S	2005-08	F&R
Madass 50 (4 stroke)	04-05	F	FA086/2 - HYOSUNG			GT 650 X	2007	F&R
Madass 50 (2 stroke)	04-05	F	GT 125 Naked	07-12	F&R	GV 700 C	06-09	F&R
Mad Ass 50 (4T)	06-09	F	GT 125 i (Naked)	13-15	F&R	ST7 (ST 700 i)	10-15	R
Madass 125	05	F&R	GT 125 R	06-14	F&R	ST7 Deluxe (ST 700 i)	12-15	R
Mad Ass 125 (4T)	06-09	F	GV 125 Classic	07-15	F			

FA088 64 x 55 x 9mm

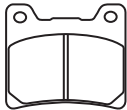

MATERIAL AVAILABILITY											
FA	TT	V	R	HH	MXS	SXR	EPFA	GPFAX	SFA	SFAC	SFAHH
✓		✓		✓			✓				

NORTON											
Commander (Rotary)	90	F&R					XV 750 U/UC/W/WC/A/AC/B/BC/D/DE				
YAMAHA							/E/EC/F/FC/G/GC/H/HC/J/JC Virago	88-97		F	
RZ 350 L/N/NC11	84-85	R					FZR 750 'Genesis' RU/RT	87-88		R	
FZR 400 U/SUC/W/SWC	88-89	F					FZR 750 (OW01)	89-92		R	
XJ 400 S Seca II	93	R					YFZ 750 R/SP	93-96		R	
RZ 500	84-86	F					TDM 850 D/DC/E/EC	92-93		R	
FJ 600 L/LC/N/NC	84-85	F&R					XJ 900 RK 'Seca'	83		F&R	
FZ 600 S/SC/T/TC/U/UC	86-88	F					XV 1000 L/LC/N/NC	84-85		F	
YX 600 S/SC/T/U/W/A/TC/UC/							FZR 1000 'Genesis' T/TC/U/UC	87-88		R	
WC/AC 'Radian'	86-90	F					FZR 1000 W/WC/A/AC/B/BC EX-UP	89-91		R	
FZR 600 W/WC	89	F&R					FZR 1000 D/DC/E/EC/F/FC/G/GC EX-UP	92-96		R	
FZR 600 AC/RAC/RA/RBC/RD/RDC/							GTS 1000 AE/AEC/AF/AFC	93-96		R	
RE/REC/RF/RFC/RG/RGC/RH/RHC/							YZF 1000 R (Rj)	97		R	
RJ/RJC/RK/RKC/RL/RLC	90-00	R					FJ 1100 L/LC/N/NC	84-85		F&R	
YZF 600 RG/RGC/RH/RHC	95-96	R					XV 1100 'All Models'	86-97		F	
YZF 600 RJ/RK/RL/RM/RN/RR/RS							XVS 1100 ATS V-Star Silverado/Custom	04-08		R	
/RT/RV/RW	97-07	R					XVS 1100 AS V-Star Classic	04-08		R	
FZ 700 T/TC Genesis	87	F&R					XVS 1100 V Star Custom/V Star Classic	99-09		R	
FZX 700 S/SC/T/TC 'Fazer'	86-87	F&R					XVS 1100 V-Star Silverado	03-09		R	
XJ 700 N/NC/XN/XNC/XS/XSC/S/SC	85-86	F					XVS 1100 W-M V-Star Custom Midnight	07-09		R	
XV 700 L/LC/N/NC/CS/CT/CTC/CSC/							FJ 1200 S/SC/T/TC	86-87		F&R	
SS /SSC/ST/STC	84-87	F					FJ 1200 W/WC/A/AC/B/BC/D/DC/AD			F&R	
FZ 750 N/S/SC/U/UC	85-88	F&R					/ADC/AE/AEC 85			F&R	
							V-Max VMX 12 N/NC/S/SC/U/UC/W				
							/WC/A/AC/B/BC/D/DC	85-92		F&R	

FA090 91 x 51 x 10mm



MATERIAL AVAILABILITY											
FA	TT	V	R	HH	MXS	SXR	EPFA	GPFAX	SFA	SFAC	SFAHH
✓		✓									

HONDA											
CB 650 SCC "Nighthawk"	82	F									

FA092 81 x 42 x 7.5mm



MATERIAL AVAILABILITY											
FA	TT	V	R	HH	MXS	SXR	EPFA	GPFAX	SFA	SFAC	SFAHH
	✓		✓								

HONDA											
CR 125 RE/RF/RG	84-86	F					XR 250 RE/RF/RG/RH	84-87		F	
MTX 125 RWE/RWF/RWH/RWL	85-95	F					XLR 250 R (MD22)	88-90		F	
XL 125 RF/RH	85-86	F					TRX 250 RG/RH/RJ/RK	86-89		R	
XL 200 R	85	F					XR 350 RE	84		F	
MTX 200 RWF	85	F					CR 500 RE/RF/RG	84-86		F	
FTR 223 (MC34) Y/2/A2	00-02	F					XR 500 RD/RE	84-85		F	
ATC 250 RF/RG	85-86	F&R					XL 600 RD/LD/RE/LE/RF/RG/RH	83-87		F	
CR 250 RE/RF/RG	84-86	F					XR 600 RF-RH	85-87		F	

FA093 A 88 x 48 x 8mm B 56 x 36.5 x 10mm

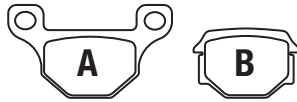

MATERIAL AVAILABILITY											
FA	TT	V	R	HH	MXS	SXR	EPFA	GPFA	SFA	SFAC	SFAHH
✓									✓		

SUZUKI

GN 125 Z/D/K Gold Coloured Cast
Wheels/Aisin Caliper 82-90 F
GS 125 ESD/ESF/ESK/ESM 83-94 F
GX 125 (SJ 125) 03 F

AJP

PR4 125 Enduro 10-12 R
PR4 125 Enduro Pro 10-12 R
PR4 125 Supermoto 10-12 R
PR4 125 Supermoto Pro 10-11 R
PR4 200 Enduro Pro 10-11 R
PR4 200 Supermoto 10-11 R
PR4 200 SM Pro 10-11 R

APRILIA

RS4 50 (4T) (AJP Rear Caliper) 11-14 R
RX 125 (AJP Rear Caliper) 08-12 R
RS4 125 (4T) (AJP Rear Caliper) 11-15 R

BRANSON

BM 125 Retro 08 F
BM 125 08 F
BM 125 Sport 08 F

CF MOTO

CF 150 Leader 10-11 F

DERBI

Atlantis 50 (4T) 07-09 F
Atlantis 50 (2T/AC) 12"/5 spoke wheels/200mm disc/5 bolt

From Ref No 8G253172 07-11 F

GPR 50 (2T) 41mm Forks (218mm rear disc) 09-12 R

Terra 125 Euro (Single pin pad fixing) 07-11 R

Terra 125 Adventure 07-12 R

GPR 125 (4T) 4V 09-14 R

Mulhacen 125 (4T) Up to ref no. 7N001790 Spoke wheel/2 pin pad fixing 07 R

Mulhacen 125 (4T) From Ref no. 7N001791 Spoke wheel/single pin fixing 07-11 R

Mulhacen 125 Cafe Cast wheel /radial caliper 08-11 R

Senda DRD 125 R 10-12 R

Senda DRD 125 SM 10-14 R

EASY RIDER

JC 125/8 Dragon 98 F

GAS GAS

EC Cami 250 F (4T) 14-15 R

HARTFORD

HD 125 L/150 L 00-04 F

KEEWAY

Speed 125/150 07-12 F&R

MASH

Dirt Track 50cc 18-20 F

Fifty 50cc (Roadstar 50) 18-20 F

Scrambler 125 14-16 F

Seventy 125 14-20 F

MH/Motorhispania

RX 50 R 08-14 R

125 Custom 12 F

Duna 125 Supermotard 13-14 R

RX 125 R 08-14 R

MH7 Naked (125cc) 08-14 R

Duna 125 Hard Road Enduro 08-12 F

Duna 125 Sports City Supermotard 08-09 R

KN1 (125cc) 09-10 R

MOTO-ROMA

SK 125 (Cast Wheel) 10-12 F

Virage 125 01 F

PEUGEOT

XR7 (50cc) 08-12 R

NK7 "Naked" 50cc 09-12 R

XPS 50 SM 09 F&R

XPS 50 Track (21" front wheel) 11-12 F

XPS 50 Top Road (17" front wheel) 10-12 F

RIEJU

MRT 50 (Single piston caliper) 09-20 F&R

MRT Pro Supermotard (Radial caliper/cast wheel) 09-20 R

MRT Supermotard 50 (Cast wheel /single piston caliper) 09-20 F&R

MRT-Pro 50 (Radial/double piston caliper) 09-15 R

NKD 50 08-10 R

RS2 50cc Matrix/Pro 07-10 R

RS3 50 11-20 R

RS3 50 Pro 11-15 R

Tango 50 Motard 09-10 F

Tango 50 (Spoke Wheel) 11 F

Tango 50 Motard (Cast Wheel) 11 F

Marathon Pro Supermotard 125 (Cast wheel/radial caliper) 09-20 R

Marathon Pro 125 (Radial /double piston caliper) 09-20 R

Marathon 125 (Air Cooled) 10-15 F&R

Marathon 125 SM (Air Cooled /Cast Wheel) 10-15 F&R

NKD 125 08-10 R

RS2 125/Pro 07-10 R

Tango 125 Motard (Cast wheel) 08-10 R

Marathon 200 Pro SM 11-15 R

SHERCO

SE 0.5 11 F

SM 0.5 11 F

SU 50cc (2T) Urban Base (Cast Wheels) 10 F

SE 1.25 F 11 F

SM 1.25 F Black Panther 11 F

SINNIS

QM 125 2V2 Max II 125 12-14 F

QM 125 GY-2XR Retro Star 125 12-14 F

QM 125 GY-2X Cafe 125 12-14 F

Trackstar 125 (4T) 10-12 F

Vista 125 QM 125 2C 08-10 F

SUPERBYKE

RFX 50 Road Trail F

RFX 125 Road Trail F

TGB

R 50 X Bullet 06-14 F

Delivery/Express 125cc 04-14 F

R 125 X Bullet 08-14 F

302 Sport (50cc) 03-08 F

303R Hawk/Laser (125/150cc) 04-08 F

303R Hawk/Laser (125/150) 09-14 F

304 Sport (125cc) 03-04 F

309 RS 50 02-03 F

404 Executive 03-08 F

WK BIKES

RT125 15 F

WUYANG

WY 125-12 06-07 F

WY 125 16C 06-07 F

ZONTES

Tiger 50 (4T) 14-15 F

ZT125-3A Tiger 09-15 F

ZT125-8A Panther 09-15 F

FA094 60 x 63 x 13mm



MATERIAL AVAILABILITY											
FA	TT	V	R	HH	MXS	SXR	EPFA	GPFA	SFA	SFAC	SFAHH
✓		✓		✓			✓				

HARLEY DAVIDSON

FXD/FXDL/FXDWG/FXR/FXRS/FXRT/ FXSTS/FXSTSi 00-05 F

FXRD/FXLR 84-99 F FLSTS Heritage Springer 00-03 F

FXST/FXSTB/FXSTC/FXSTS/FLST/ FLSTSC/FLSTSCi Springer Classic 05-07 F

FLSTC/FLSTF/FLSTS/FLSTN 84-99 F Classic 06-07 F

FX/FXE/FXEF/FXWG/FXS 84-86 F FLSTSB Softail Cross Bones 08-11 F

FLHR/FLHRCI 94-99 F

BUYERS GUIDE

DO NOT REFIT ANY SHIMS/INSULATORS TO EBC PADS FROM ORIGINAL PADS UNLESS INSTRUCTED ON NOTE ON PAD PACKAGING AND ON FA DRAWING ASSOCIATED WITH THAT PAD.

FA095 69 x 51 x 8mm

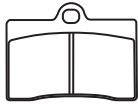

MATERIAL AVAILABILITY											
FA	TT	V	R	HH	MXS	SXR	EPFA	GPFA	SFA	SFAC	SFAHH
✓		✓		✓			✓				

Brand	Model	Year	Type	Part No.	Year	Type	Part No.	Year	Type	Part No.
AJS	R7 125	14-15	F	SM 125/250/400 FSE	02	F	Skorpion/Tour/Sport/Traveller/Cup	95-02	F	
APRILIA	RS4 125 (J. Juan F Caliper)	11-20	F	SM 125/250 (2T)	01-06	F	Mastiff -17" front wheel/cast wheel	99-05	F	
	RS4 125 (J. Juan F Caliper)	11-14	F	SM 125 (2T) Supermotard	03-06	F	OMP			
	RS 250 All models	95-97	F	SM Halley 125cc	09	F	4 Piston		F&R	
	B 500 CR	02	F	SM 400 FSE (2T)	01-04	F	PGO			
	B 500 MT	02	F	SM 450 FSR (4T) Supermotard	07-09	F	G Max 125	06-08	F	
				SM 515 FSR (4T) Supermotard	07-09	F	G Max 125 (Wave disc)	09-12	F	
BENELLI	666 Scooter "Born in Hell"	98-99	F	GILERA			G Max 250	06-08	F	
BETA	Jonathan 125	00-05	F	Saturno 350 Bialbero	90-	F	REVTECH			
	Euro 350	03-06	F	Saturno 500 S/Bialbero/Piuma	90-	F	CCI Polished Caliper (Front/Rear)			
	Jonathan 350	03-06	F	HONDA			TM			
BIMOTA	Various models	89-03	F	CBR 900 'Evolution Blade'	99	F	SMR 125 (2T)	05-14	F	
	Tesi 2D	05-06	F	HUSQVARNA			SM 250	02	F	
BRILE	B 500 CR	02-04	F	SM 400 R	02	F	SME 250 (4T)	04	F	
	B 500 MT	02	F	SM 450 R	03-06	F	SMM 250/300 (2T)	05-14	F	
BREMBO	20 5165 55/68 Goldline 4 Piston P4 30/34			SM 510 R	05	F	SMR 250/300 (2T)	05-14	F	
	@ 40mm Spacing (Single pin pad fixing)			SM 570 R	01-04	F	SM 400	02-03	F	
	20 4756 52/62 - 4 Piston P4 30/34			INDIAN			SME 400 (4T)	04	F	
	@ 40mm Spacing (Single pin pad fixing)			Chief Blackhawk (Brembo calipers)	11	F	SMR 450/530 FES	05-09	F	
CAGIVA	Mito 125/SP525	93-10	F	Chief Blackhawk Dark (Brembo calipers)	11	F	EN 530 F-ES	03-04	F	
	N1 125	97	F	Chief Classic (Brembo calipers)	11-13	F	SM 530	02-03	F	
	Planet 125 (3 Spoke Wheels)	98-03	F	Chief Classic (Brembo calipers)	11-13	F	SME 530 (4T)	04	F	
	Planet 125 (6 Spoke Wheels/ST Series)	98-03	F	Chief Standard (Brembo calipers)	09-11	F	530 (4T) Cross	02-03	F	
	Planet 125 (6 Spoke Wheels 2nd Series)	98-03	F	Chief Deluxe (Brembo calipers)	09	F	SMX 660 F	04	F	
	Raptor 125	03-10	F	Chief Roadmaster (Brembo calipers)	09-11	F	YAMAHA			
	Mito 500	07	F	Chief Vintage (Brembo calipers)	09-13	F	TZR 125 R Brembo Caliper (4DL1/4DL2)	91-93	F	
	River 600	95-99	F	Bomber (Brembo Calipers)	10-11	F	TZR 125 RR	96-	F	
CCM	CR 40 S Cafe Racer (Full Fairing)	07-09	F	Dark Horse (Brembo calipers)	10-13	F	SZR 660	96-97	F	
	CR 40 Cafe Racer (Handlebar Fairing)	07-08	F	KTM			SACHS			
DUCATI	Supersport 400	93-97	F	Sting 125	97-99	F	XTC 125 Supersport	00-07	F	
	400 Monster	95-97	F	Duke 400 LC4	94-98	F	XTC 125 N	00-07	F	
	(549cc) Supermono	93-95	F	Duke 620 LC4	94-98	F	X Road 125	06-07	F	
	600 Monster	93-99	F	Duke-E 640 (Single pin pad fixing			Roadster 650	05	F	
	600 Monster Dark	98-99	F	/zero offset disc)	98	F	Roadster 800	01-05	F	
	600 Monster City/City Dark	99	F	LC4-E 640 (Central single pin fixing)	03	F	B-805	03-04	F	
	600 Supersport	91-97	F	SMC 660 Supermoto	03-04	F	VOR			
	748 SP	95-98	F	LEXMOTO			SM-E 450/530	03-04	F	
	749 Biposto	95-98	F	LXR 125 SE SY125-10-SE	19-21	F	VOXAN			
	750 Supersport	91-98	F	LXR 380 TR380-GP1	19-21	F	Cyclope 1000	02	F	
	Supersport 750 (Twin disc)	91-98	F	LAVERDA			Cafe Racer 1000	02-05	F	
	750 Monster	96-98	F	650 All models	94-95	F	Roadster 1000	02-05	F	
	750 Monster City/City Dark	99	F	668 All models	96-98	F	Street Scrambler	03-05	F	
	750 Monster/Monster Dark	99	F	750 All models	98-01	F	WILWOOD			
	851 Superbike Biposto	89-92	F	MASH			GP300/310 (Part # 150-8733-2)			
	884 SP4/SP5	92-93	F	TT40 400cc (Trackstar)	17-20	F	WK BIKES			
	888 Superbike Strada	94-95	F	MONDIAL			SP125N	13-15	F	
	900 Supersport	89-90	F	Piega 1000	02	F	SP250N	15	F	
	900 Supersport/Superlight	91-97	F	MOTO GUZZI						
	900 Supersport CR USA	98	F	1000 Daytona	92-95	F				
	900 Supersport FE	98	F	1000 Daytona RS	97-98	F				
	900 Monster	93-99	F	1000 V10 Centauro GT	97-99	F				
	900 Monster Cromo/Special	98	F	1000 V10 Centauro Sport	97-99	F				
	900 Monster City/City Dark	99	F	Sport V11	98-99	F				
	907 IE	90-93	F	California 1100 EV						
	916 SPS (996cc)	97-98	F	(Single pad pin fixing)	97-00	F				
	916 Biposto	94-98	F	California 1100 Jackal						
	916 Senna	94-98	F	(Single pin pad fixing)	99-01	F				
	916 SP	94-96	F	California 1100 Special						
FANTIC	TZ 125 SM Caballero Motard (2T)	11-12	F	(Single pin pad fixing)	99-00	F				
	TZ 125 MR (2T) Motard Competizione	13	F	1100 California EV (Up to						
				KD115426/Single pin pad fixing)	97-00	F				
				1100 California Jackal (Up to						
				KD152328 Single pin pad fixing)	94-01	F				
				1100 California Special (Up to						
				KD131644/single pin pad fixing)	99-00	F				
				1100 Sport Carbs	94-96	F				
				1100 Sport EFI	96-99	F				
				1100 Sport Corsa	98-99	F				

BRAKE PAD BUYERS GUIDE

DO NOT REFIT ANY SHIMS/INSULATORS TO EBC PADS FROM ORIGINAL PADS UNLESS INSTRUCTED ON NOTE ON PAD PACKAGING AND ON FA DRAWING ASSOCIATED WITH THAT PAD.

FA099 31.5 x 52 x 5.5mm

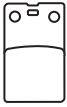

MATERIAL AVAILABILITY												
FA	TT	V	R	HH	MXS	SXR	EPFA	GPFA	SFA	SFAC	SFAHH	
✓									✓			

APRILIA											
TRX 240 M				89	F&R					86-	R
BENELLI											
Devil 50				92-	R					96	F
Spring 50				93-	R					90-	F
Devil 80				92-	R					91-	F&R
BETA											
TR 32/33 125				86-87	F					94-98	F
TR 33 240				86	F					97	F
TR 34 260				89-91	F					83-	F
TR 34				86-88	F					83-	F
CIMATTI											
Gringo				85-	F					87-	F&R
FANTIC											
50.1 Oasis Kick				87-	F					85-	F
50.1 Trial				86-	F					87-	F&R
50.1 Trial H 20				87-	F					91-	F
Trial 125/2					F&R					91-	F
201/301 Monoshock				86	F						
243 Trial				87-	F&R						
303 Monoshock				87	F&R						
GARELLI											
50 Tiger XLE											
GILERA											
Eaglet 50											
Built 50											
503 50cc											
MALAGUTI											
Phantom F12											
Crosser CR1											
50 Enduro RCX-W/Sahib											
50 Fifty Full/CX											
50 RGT Strada											
50 Enduro Dune											
50 Fifty Top											
50 RGT Sport											
50 RST Sport											
50 Evolution											
50 Raid											

FA100 39 x 9mm



MATERIAL AVAILABILITY												
FA	TT	V	R	HH	MXS	SXR	EPFA	GPFA	SFA	SFAC	SFAHH	
✓												

LAMBRETTA											
175 TV II					F						

FA101 71 x 36 x 9mm



MATERIAL AVAILABILITY												
FA	TT	V	R	HH	MXS	SXR	EPFA	GPFA	SFA	SFAC	SFAHH	
✓	✓		✓		✓				✓	✓	✓	

BETA											
Euro 350				03-06	R					88	R
Jonathan 350				03-06	R					96-03	F
CCM											
XTR 250				09	R					86-87	F
CF MOTO											
CF 125 T-21A E-Charm				10-11	R					89-93	F
CF 150 T-Si				10-11	R					93-96	F
CF 250 T-5 V5 Custom				11-12	R					97-06	F
GARELLI											
XO 125i (TM 125 T)				09-12	R					88	R
XO 150i (TM 150 T)				09-12	R					85-86	F&R
XO 200i (TM 200 T)				10-12	R					87-89	F
XO'E Electric				12	R					85-95	F
HERO HONDA											
Quickster 125				06	F					-59X007852	85-88
HONDA HM (Italy)											
CRE 50 Six/Baja/Derapage				95-02	R					87	R
LINHAI											
Eggy 125cc (Scooter)				07-09	F					88-90	R
LH50 Police (Scooter)				07-09	F					92-03	R
MALAGUTI											
Blog 125 ie				09-11	R					91-	R
Centro 125 ie/SL				07-11	R					89-92	R
Blog 160 ie				09-11	R					07	F
Centro 160 ie/SL				07-11	R					89-90	R
MBK											
TZR 50 X-Power				00	R					00-01	F
XC 125 Flame 125				96-03	F					12-13	F
XC 150 Vertex				97	F					12-14	F
MZ											
660 SSR				95	R					08-10	F
YAMAHA											
TZR 50 'Thunderkid' (5DU1/3)				97-00	R					08-09	F
YSR 50 T				87	F					05	R
DT 80 LC-2 (53V)				85-92	F						
DT 125 LC				86-87	F						
DT 125 R				88-03	F&R						
DT 125 RE				04	F&R						
DT 125 RE				05-07	F						
TDR 125 (4GW/GX 1/2/3/4)				93-03	R						
YBR 125 ED (3D91)				05-06	F						
GILERA											
125 Apache											
RC 125 Top Rally											
Oregon 250 Quad											
RC 600											
ITALJET											
Millennium 100/125/150											
NIPPONIA											
Miro 100 (4T)											
Miro 125 (4T)											
SACHS											
Bee 50											
Bee 125											
Roadster 650											
SFM											
Bee 50 (2T)											
Bee 125 (4T)											
SIAMOTO											
KD 125											
W.K. BIKES											
WK 125 C (4T) (16" wheel)											

FA102 58 x 48 x 8.5mm

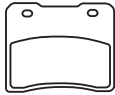

MATERIAL AVAILABILITY											
FA	TT	V	R	HH	MXS	SXR	EPFA	GPFAX	SFA	SFAC	SFAHH
✓											

SUZUKI

RG 250 WE/FG/CH/FCH/FH 'Gamma' 84-88 F
GSX 400 R2 (GK71B) F

FA103 58 x 53.5 x 9mm

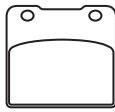

MATERIAL AVAILABILITY											
FA	TT	V	R	HH	MXS	SXR	EPFA	GPFAX	SFA	SFAC	SFAHH
✓		✓		✓							

SUZUKI

GSX 250 R CH/H (GJ72A) 80-82 F VS 700 GLFH/GLPH/GLFG/GLPG 86-87 F
GSXR 250 J (GJ72A) 02-05 F GSXR 750 F/G/H 85-87 F
GSXR 250 CK 17-21 F VS 750 All models 85-91 F
GSXR 400 H 87 F VS 800 GLN/GLP/GLR/GLT/GLS
GSX 400 X/XA/XS "Impulse" F /GLV/GLW/GLX 92-99 F
GSX 400 R3 (GK71F) F GSX 1100 EFE/EFF/ESF 84-86 F&R
RG 400 F GSX 1100 FJ/FK/FL/FM/FN/FP/FR 88-94 F
RG 400 EWF/EW-2G/EWH GSXR 1100 G/H/J 86-88 F
Walter Wolf (Type 1&2) 85-87 F GV 1400 GDG/GTG Cavalcade 86 F&R
VS 400 VR/FR/TR/FTR/V-T/F-T 94- F VS 1400 GLPH/GLFH/GLPJ/GLFJ
RG 500 G/CH 85-87 F /GLPR/GLPT/GLPV/GLPW/GLPX
VS 600 GLS/GLT/GLV 95-97 F /GLPY/GLPK1/GLPK2 Intruder 87-03 F&R
VS 700 GLEFG/GLEPG/GLEFH/GLEPH 86-87 F VL 1500 W/X/Y/K1 98-01 F&R

FA104 68 x 56 x 9mm



MATERIAL AVAILABILITY											
FA	TT	V	R	HH	MXS	SXR	EPFA	GPFAX	SFA	SFAC	SFAHH
✓		✓		✓							

YAMAHA

RD 125 LC (MK 2-3) 85-87 F TZR 250 R (3XV1/3X4/3XV6) V-Twin (Eng Frame # 3XV000101-08600) 91-93 R
RZ 125 (1GV 030101-) 85 F TZR 250 RS (3XV8/3XV9/3XVA) V-Twin
TZR 125 87-89 F (Eng Frame # 3XV080101/08200 088-) 92-94 R
TZR 125 90-92 R TZR 250 SPR (3XVC) V-Twin
TZR 125 R 93- R (Eng Frame # 3XV 107101-) 95 R
TZR 150 R (4AP2) 00 R RD 350 N 85 F&R
SDR 200 (2TV) 87-89 F&R RD 350 F/F2 85-92 F&R
FZR 250 R R RD 350 R 92-95 F&R
FZR 250 87 R FZ 400 (4YR1) 96 R
FZX 250 Zeal (3YX1/2/4) 91-92 R FZ 400 N (IFK 146X 133M) 85 R
RZ 250 R (1AR/1XG) F&R FZR 400 RR (4DX) 92 R
RZ 250 R (29L) R FZR 400 (3TJ1/2/6/7) R
RZ 250 RR (51L) F&R FZR 400 Genesis (1WG) 86 R
R1-Z (250CC/3XC) 90-92 R FZR 400 RSP (2TK EX-UP) 87 R
SRX 250 F FZR 400 (3EN1/2) 88-89 R
TDR 250 (3CK1/3CK2 Europe) SRX 400 (1JL) 85 R
(Eng Frame # 3CK-) 88-92 R SRX 400 (3VN1/3VN2/3VN5) 90-96 R
TZR 250 (2MA/2XW1/2XW2 Europe) XJR 400 (4HM1/4HM2/4HM4/4HM7) 93-96 R
(Eng Frame # 2MA-) 87-92 R XJR 400 (4HM3/4HM5/4HM6/4HM9
/4HMA/4HMB) Brembo caliper 95-99 R
TZR 250 (1KT/2AW Japan) (Eng Frame # 1KT-000/056) 87 R RD 500 LC 84-86 R
TZR 250 (2XT1 Japan) (Eng Frame 1KT-09) 88 R RZV 500 R(SIX) 85 R
TZR 250 (3MA1 - Reverse Cylinders) 88 R FZ 600 87-88 R
(Eng Frame # 3MA-0001) 89 R FZS 600 Fazer 98-03 R
TZR 250 (3MA3/3MA5) (Eng Frame # 3MA-046/058) 90 R SRX 600 86-87 F&R
TZR 250 SP (3MA4) (Eng Frame # 3MA055) 90 R SRX 600 (1JK) 85 F&R
XJ 600 N 95-03 R
XJ 600 S "Diversion" 92-03 R

FA105 91 x 30.5 x 8mm



MATERIAL AVAILABILITY											
FA	TT	V	R	HH	MXS	SXR	EPFA	GPFAX	SFA	SFAC	SFAHH
	✓		✓								

YAMAHA

YZ 125 N/S/T/U 85-88 F TT 350 A (3GJ) 90-95 F
TT 250 90 F YZ 490 N/S/T/U 85-88 F
YZ 250 N/S/T/U 85-88 F TT 600 W (2JT/3SW1) I
TT 350 (ITJ) 85-89 F (Frame # 59X007853-) 89-92 F

FA106 77 x 54 x 8mm
FA106/2 77 x 54 x 9.5mm



MATERIAL AVAILABILITY - FA106											
FA	TT	V	R	HH	MXS	SXR	EPFA	GPFAX	SFA	SFAC	SFAHH
	✓	✓	✓								

MATERIAL AVAILABILITY - FA106/2											
FA	TT	V	R	HH	MXS	SXR	EPFA	GPFAX	SFA	SFAC	SFAHH
	✓		✓								

FA106		SIAMOTO										
SUZUKI		Geco 250 04 F										
GZ 125 W/X/Y/K1-K9 'Marauder'	98-10	F	MAICO								86-88 F&R	
RM 125/250 F/G	85-86	F	All Models									
VL 125 Y/K1-K7 Intruder	00-08	F	FA106/2									
GZ 250 K2-K8 Marauder	02-08	F	SUZUKI									
GZ 250 X/Y/K1	99-01	F	DR 600 RG/RH/RJ (SN41A)									
TU 250 XV/XW	97-00	F	(Rear drum model) 86-88 F									
TU 250 S/T/XS/XT/X-ST/XSV/XT-W			DR 600 RK (SN41A) (Rear disc model) 89 F									
(NJ47A 10001-115972)	92-97	F	DR 600 SF/SG/SH/SJ/SK (SN41A) 85-89 F									
VL 250 Y/K1/K5-K7 Intruder	00-01/05-07	F										
LS 650 "Savage" FG/PK/PM/PR												
/PG/PT/PV/PW/PX	87-99	F										

FA107A 82 x 54 x 8mm
FA107/2A 82 x 54 x 7mm

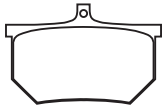

MATERIAL AVAILABILITY											
FA	TT	V	R	HH	MXS	SXR	EPFA	GPFAX	SFA	SFAC	SFAHH
✓											

FA107A - AP/LOCKHEED		FA107/2A - AP/LOCKHEED									
4 Piston Caliper (CP3086/CP3369/CP4484 D27)		4 Piston Caliper (CP4485/CP4679)									
SPONDON		SPONDON									
4 Piston Caliper		4 Piston Caliper									

FA109 50 x 55 x 11mm

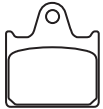

MATERIAL AVAILABILITY											
FA	TT	V	R	HH	MXS	SXR	EPFA	GPFAX	SFA	SFAC	SFAHH
✓											

HONDA											
VF 1000 RE/RF/RG				84-86		R					

FA110 52.5 x 44.5 x 7mm

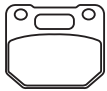

MATERIAL AVAILABILITY											
FA	TT	V	R	HH	MXS	SXR	EPFA	GPFAX	SFA	SFAC	SFAHH
✓											

SUZUKI												
RG 125 CG/CH/J (NF12A) Gamma												
/Rear drum brake model	86-90	F	RG 125 UCG/UCH/UJ/UAJ/BUJ (NF12B) Gamma/Rear drum model								86-90	F

FA111 64 x 57 x 9mm

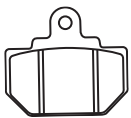

MATERIAL AVAILABILITY											
FA	TT	V	R	HH	MXS	SXR	EPFA	GPFAX	SFA	SFAC	SFAHH
✓			✓								

HONDA											
FL 350 R Odyssey				85-87		R					
FL 400 R/RK/RL "Pilot"				89-93		R					

FA115 36 x 45 x 6mm



MATERIAL AVAILABILITY											
FA	TT	V	R	HH	MXS	SXR	EPFA	GPFAX	SFA	SFAC	SFAHH
✓	✓	✓	✓	✓	✓				✓	✓	✓

AJP			BETA			Evo 80 Junior			09-19 F&R		
PR4 Supermotard 200	04-09	R	RR 50 Supermoto/Enduro	98-05	F&R	REV 80			00-07	F&R	
ALFER			RR Enduro Alu 50/Motard Alu 50	04-08	R	Alp 125 (4T)			98-04	F&R	
80 MC	87-	R	RR Enduro 50	04-07	R	Eurotek/Techno 125/250			96-98	F&R	
APRILIA			Eickon 50	99-06	F&R	125 TR 34				F&R	
RS 50 (Radial Caliper)	06-11	R	50 RR Enduro	97-04	F&R	R 125 4T Mini Cross				R	
RX 50	06-14	R	RR 50 Standard	05-08	R	RE 125 4T Enduro			10-14	F	
SM 50	11-12	F&R	RR Enduro 50 Standard	09-14	F	Synt			92	F	
SX 50	06-13	R	RR 50 Enduro Racing	09-10	R	RK6 50cc Enduro			97-02	R	
SX 50	11-14	F&R	RR 50 Motard Standard	09-14	F	Alp 200 (4T)			00-04	F&R	
SM 125	11-12	F&R	Pro race 50	05	F	BLATA					
SX 125	11-12	F&R	Synt/Gara	93-95	F	Enduro 125			07-08	R	
TX 125/240/311	86-88	F	Zero	92	F	Motard 125			07-08	R	
SM 250	11-12	F	Super Trial ST	94	F	BULTACO					
TX 311	88	F&R	Techno	95	F	Astro SM 50				R	
280 Climber	94-96	F	REV 50	00-08	F&R	CAGIVA					
280 R Climber	92-93	F	Minitrial 70cc 2T	13-14	F&R	Mito 50			99-00	R	

DO NOT REFIT ANY SHIMS/INSULATORS TO EBC PADS FROM ORIGINAL PADS UNLESS INSTRUCTED ON NOTE ON PAD PACKAGING AND ON FA DRAWING ASSOCIATED WITH THAT PAD.

FA115 36 x 45 x 6mm

Progress 50	97-99	F	GPR 125 Racing (Radial caliper)	04-07	R	Husky Boy R	01	F
GH RACING			GPR 125 Nude (Radial caliper)	04-08	R	WRS 50 Scooter	98-00	F
WXE 50/125 Enduro	05	R	DUCATI			WR 50	02	R
WSM 50/125 Motard	05	R	(549cc) Supermono	93-95	R	SM 50	02	R
CONTI			ECO			IRON PEGASUS		
RX 356 V3 (12" wheels)	05-06	R	Bushman 150 (LX 150 GY)		R	Small caliper (2 pin fixing)		
RX 356 V3 (17" wheels)	05-06	R	EXPLORER			ITALJET		
CPI			KBR 200	05	R	Formula 50 LC	96-03	F&R
Supermoto 50 SMX	03-08	F&R	FACTORY			Formula Air 50	99-03	F
Supermoto 50 (Low level exhaust)	06-09	F&R	RP 50	05	R	Torpedo 50	98-03	F
Supercross 50	03-09	F&R	YM 50	05	R	Torpedo 125 4T	99-03	F
SM 50 Black Tiger	08-09	F&R	YR 50 Desert	02-03	F&R	Formula 125 LC (2T/Twin Cyl)	96-03	F&R
SX 50	06-07	R	YR 50 Desert	04-05	R	Dragster 50	98-07	F&R
SM 250	09-12	F	Chrono SM 50	04	R	Dragster 125/180 LC	00-08	F&R
SX 250	09-12	F	YR 125 4T	05	R	Pit Jet 125 (4T)	07-09	R
CZ/JAWA			FANTIC			Dragster 250	07-08	F&R
50 Minarelli	03-04	F	50.5 Trial	89	F&R	JAYBRAKE		
125 Sport	03-04	F&R	50.7 Trial	90	F&R	Dual 7 Quad (300-04) (2 & 4 Piston)		
125 Dandy	03-04	F&R	50.9 Trial	91-	F&R	JCM		
50/100 Robby	03-04	F	50 Clubman	95-	F&R	240 Europa	89	F
DAELIM			80 Clubman	95-	F&R	KTM		
S 125	03	R	125/5/245/305	89	F&R	60 SX	98-00	F
DERBI			Series 7 Models	90	F&R	65 SX	98-01	F
Atlantis 50 (AC/2T)	99-01	F	K-Roo (All Models)	92-95	F&R	LEM		
Atlantis 50 Bullet (AC/2T)	03-05	F	309	92	F&R	Four X Pro		R
Atlantis 50 City (AC/2T)	03-06	F	Section 125/249 R	95-	F&R	MALAGUTI		
Atlantis 50 Red Bullet (AC/2T)	03	F	FB MINARELLI (SPAIN)			NDK 50 Drakon	05-09	R
Atlantis 50 Two Chic (AC/2T)	05	F	MR 80		F	XTM 50	03-11	F&R
Atlantis 50 (AC/2T)	02	F	FYM/X-Sport			XSM 50	03-11	R
Atlantis 50 (4T) (13" 3 spoke wheels)	04-06	F	CR 110/CR 110 ESR	06-07	R	Drakon S	06	R
Atlantis 50 (2T) Up to Ref No. 8G25317112"			CR3 125	06-07	R	X3M Enduro (Cast wheel)	08-10	R
/5 spoke wheels/190mm disc 3 bolt	07	F	CR 125 R	06-07	R	X3M Motard (Cast wheels)	08-10	R
Atlantis 50 LC (2T)	99-01	F	X Sport Typhoon 125 Quad	06-07	R	MBK		
GP1 50 Open	06-11	R	GARELLI			TZR 50 X Power	03-09	R
GP1 50 Euro 2 Chain Driven/ Radial caliper/5 bolt fixing front disc	05	R	GSP 50 (2T)	09-12	R	MH/MOTORHISPANIA		
GP1 50 Race Chain Driven/ Radial caliper/5 bolt fixing front disc	05-07	R	Sahel 50/80	91-	R	Furia Max Supermoto	07-10	F&R
GP1 50 50cc	01-03	F&R	Trial 323	86-	F	Furia Max Enduro 50	06-10	F&R
GPR 50 R	97-01	R	GAS-GAS			RYZ 50 Enduro	06-10	F&R
GPR 50 Replica Racing	99-03	R	EC 50 Boy (Air cooled)	05	F	RYZ 50 Pro Racing Enduro	06-10	R
GPR 50 (2T) 41mm Forks			K 50 Quad	06	R	RYZ 50 Pro Racing Supermotard	06-10	R
/218mm rear disc	09-11	R	TXT 50 (Boy)	04-15	F&R	RYZ 50 Pro Racing Urban Bike	06-10	R
GPR 50 Racing 40mm forks			TXT 50 (Cadet)	06-09	F	RYZ 50 Supermotard	06-10	R
/180mm rear disc/radial caliper	08-10	R	MX 65	05-08	R	RYZ 50 Urban Bike	06-10	R
GPR 50 40mm forks			Contact Models	93-95	F&R	RYZ 50 Pro Racing Enduro	13-14	R
/180mm rear disc/radial caliper	04-07	R	JTX 125/200/270/320	95-98	F&R	RX 50 Super Racing	06-07	R
Paddock 50 (AC/2T)	98-99	F	Pampera 125/250/370	96-97	F&R	Duna 125 Hard Road Enduro	08-12	R
Predator 50 (AC/2T)	98-01	F	TX 200/270/320	98	F&R	Duna 125 Dual Plus Trail	08-10	R
Predator 50 (LC/2T) 5 bolt front disc			Pampera 250/320	98-99	F&R	Duna Plus 125	14	R
/STD Paioli forks	98-03	F&R	Contact JT25 (238cc)	93-94	F&R	MONTESA		
Predator 50 (LC/2T) 3 bolt front disc			250 Pampera	96-97	F&R	Cota 307/335	88	F&R
/USD Showa forks	98-03	F&R	JTR/125/160/250/370	96-97	F&R	311 (Honda)	92-93	F
Red Bullet 50	04-05	F	TX 200/270/320	98	F&R	314 R (Honda)	94-96	F
GPR 50 Nude (Radial caliper)	04-09	R	GILERA			315 R (Honda)	97-00	F
Senda SM DRD Super Motard	04-11	F&R	H@K 50	99-03	F&R	MOTO ROMA		
Senda-R	96-02	F&R	RCR 50 Enduro	01-02	F&R	SMX 125	04-06	R
Senda X Race 50 R (240mm disc)	05-09	F&R	RK 50 Cannibal	03-06	F&R	SUZUKI		
Senda R DRD	02	R	SMT 50 Supermotard	96-98	F&R	RMX 50		F&R
Senda DRD Racing 50 SM			SMT 50	03-06	F&R	AY 50 WRX/WX/WRY/WY/		
(300mm disc/Std mounted caliper)	04-11	R	Zulu 50	07	F&R	WRK1-WRK4 "Katana"	99-04	R
Senda DRD Racing 50 R			SC 125	01-01	F&R	AY 50 WRK1/WRK2/K3/		
(260mm disc/Std mounted caliper)	04-11	R	GMA	06-07	R	WRK3/WRK4/AK5 (AJP Caliper)	01-05	F
Senda SM DRD 50			4 Piston model F			UF 50 Y "Estilete"	00-02	F
(Double disc model) SDR1DB	02-03	R	HONDA DALL-ARA			PERFORMANCE MACHINE		
Senda SM DRD 50			XR 125 SM	04	R	125 X 2		
(Double disc model/SR3A1A)	05	F&R	HONDA HM (Italy)			125 X 4S		
Senda SM DRD Racing Ltd			CRE 50 Baja/Derapage	01-02	R	125 X 4SL		
(Cast Wheels/Double F Disc)	05-07	F&R	H P POWER			PEUGEOT (AJP CALIPER)		
Senda 50 SM DRD Black Edition	05	F&R	Copper 50 (4T)	10-12	R	Blaster RS12 50 (2T)	10-11	F
Senda 50 Black Edition	03	R	HRD			Blaster Ice Blade 50 (2T/12" wheels)	10-12	F&R
Senda X-treme 50 R (240mm disc)	03-11	F&R	Cabriollet 125	01	R	Elyseo 50	98-02	F
Senda X-treme 50 SM (260mm disc)	03-09	F&R	Sonic 2 Trail 50		R	Elyseo 50	03	F&R
Senda X-Race 50 SM (260mm disc)	06-11	F&R	Sonic 2 Supermotard 50		R	Elystar 50 TSDi	02-07	F
Vamos/Vamos FL	96-99	F	Cabriollet Trail 125		R	Elystar 50 Advantage	02-07	F&R
Hunter	96-99	F	Cabriollet Supermotard 125		R	Jet C Tech 50	11-12	F&R
Atlantis 100 (AC/2T)	00-01	F	HUSQVARNA			Jet Darkside 50 (2T)	11-13	F&R
Atlantis 100 (4T) (13" 3 spoke wheels)	04-06	F	Husky Boy J	01-02	F	Jet Force 50 H2i (2T/Air Cooled)	11-12	F
			Husky Boy S	01-02	F	Jet Iceblade 50 (2T)	11-13	F&R
						Jet H2i 50 (L/C)	11-12	F&R

FA115 36 x 45 x 6mm

Looxor 50	01-06	F	XP6 Supermoto (17" front wheel)						SHERCO				
Ludix Blaster (10" wheels)	05-09	F	/240mm disc)	03-09	F&R	All models 0.5-2.0	01-05	F					
Ludix 2 Trend 50cc (2T)	07-11	F	XP6 Supermoto (17" front wheel)			All models 1.2-2.0	01-05	R					
Ludix Snake 50cc	04-09	F	/260mm disc)	03-10	R	SM 50 Supermotard	03-07	R					
Ludix Bullet 50cc	04	F	XP6 Street			SE 0.5	11	R					
Ludix Trend 50cc	04-07	F	(17" front wheel/280mm disc)	03-09	R	SM 0.5	11	R					
Ludix Elegance 50cc	04-09	F	PIAGGIO			Supermotard 50cc (2T)	02-07	R					
Ludix Pro (14" wheels/4T) (AJP caliper)	11-13	F	Diesis 50	01-05	F	Enduro 50 (EN 50)	03-07	R					
Speedfight 50 1/2	97-08	F&R	RIEJU	01-03	F	Enduro 50cc (2T)	02-07	R					
Streetzone 50 (2T)	14-18	F	MRX 50	03-08	F&R	SE 1.25 F	11	R					
TRK 50 (2T) (10" wheels)	09-12	F	NKD 50	07	R	SM 1.25 F Black Panther	11	R					
TRK2 WRC 50 (2T)	04-06	F	RS1 50cc	97-00	F&R	SM 125/125 City Corp	03-06	R					
Trekker 50 (2T) AJP Caliper	98-00	F	RS2 NKD	05	R	City Corp 125 (All models)	03-07	R					
TRK 50 (2T/12" wheels)	09-12	F	RR 50 cc Thunderfire	97-02	F&R	0.8	01-05	F					
Vivacity 50 (12" wheels/190mm disc) (AJP Caliper)	92-07	F	RR 50 Castrol	00-02	R	Trials 0.8 (2T)	01-04	F					
Vivacity 2 (50cc) AJP Caliper (10" wheels/190mm disc)	08-11	F	RR 50 Sport	03-06	F&R	Trials 1.25 (2T)	99-05	F&R					
XP6 Track	03-08	F&R	RRX 50 Spike (17" wheel/spoke wheel)	03-08	F&R	Trials 2.0 (2T)	99-05	F&R					
XR6 (2T) 50	03-07	R	RRX 50 Spike (17" cast wheel)	06-09	F&R	Trials 2.5 (2T)	99-05	F&R					
XPS 50 Track (21" front wheel)	11-12	R	MRX 50 Pro	04-08	R	Trials 2.9 (2T)	99-05	F&R					
XPS 50 Top Road (17" front wheel)	10-12	R	Spike 50	04-06	F&R	SIAMOTO							
Elyseo 100/125/150	98-02	F	Spike 50 Pro	04	R	SX1 125	04	R					
Speedfight 100 1/2	97-09	F&R	SMX 50 Pro Supermotard/Top	04-07	R	TOMOS							
Trekker 100 (2T)	98	F	SMX 50 Pro Street	01-04	R	Alpino (Front Disc)							
Ludix Ambition 125cc	04	F	SMX 50 (Cast wheel)	02-06	F&R	APN6							
Squab		F	MRX 50 Castrol/SMX 50	06-08	R	Fantastic 25							
Vivacity 50/100 (All models)	99-07	F	RRX 50	06-08	R	Hip Hop							
LOOXOR 100	01-04	F&R	RRX 50	07-08	F&R	Racing							
Metal X 50	02-03	F	Spike X50	01-02	R	Revival TS							
Elyseo 100	03	F&R	Tango 50 Motard (Cast wheel)	06-09	F&R	SM 125 F	05-08	R					
Streetzone 100 (4T)	14-15	F	Tango 50 (4T)	06-08	F&R	SE 125 F	05-08	R					
LOOXOR 125/150	03-06	R	MRX 125	06-07	F&R	Youngst'r 50	05-08	F					
Elystar 50 TSDI	02-05	F	ROXON	11	R	WK							
Jet Force 50/Jet-C	03-10	F&R	Duel 50 SM	07-08	R	SM 50	11-12	F&R					
Ludix Urban Track	06-07	F	Duel 50 TT	02-08	R	Wasp R 50 (2T)	13-15	R					
Ludix Red Zone	06	F	SACHS			YAMAHA							
Ludix Acid	06	F	Madass 50 (2 stroke)	06	F&R	TZR 50 Power	03-16	R					
Looxor 50 TSDI (Rear disc)	06	F&R	(Hydraulic rear brake)	06	F&R	TY 250 R	91-92	F					
XPS 125 CT	05-07	F&R	SCORPA	04-05	R	TY 250 R	93-94	F&R					
Ludix Blaster	05-09	F	250 Easy			TYZ 250 R	93-96	F&R					
XP 125 Street Evo 2	05	R	TY-S 125 F Enduro	96	F&R								
XP6 Enduro/Top Road 21" front wheel	03-10	F&R	TY-S 125 F	03-05	F&R								
XPS Enduro	03-09	F&R	TY-S 175 F	06-08	F								

FA116 31.5 x 57 x 5.5mm



MATERIAL AVAILABILITY											
FA	TT	V	R	HH	MXS	SXR	EPFA	GPFAX	SFA	SFAC	SFAHH
✓									✓		

ACCOSSATO				MALAGUTI			
CE 50/80/KR 80		87-	R	50 Enduro MLX		87-	F
Enduro Codice 50		89-	R	Yesterday		98-03	F
APRILIA							
Classic 50		92-01	F	F15 Firefox		96-00	F
AF1 Futura 50		90-92	F	Centro SL/SL Cat		94-00	F
Europa 50		90-92	F	CRI Crosser		95-98	F
BETA							
TR34		86-88	R	Centro Base			
TR34 125		86-	R	F12 Phantom 50		94-03	F
Tempo 16"		94-97	F	OMP			
Tempo		98	F	6 Piston			
RK6		93-96	R	Sprocket Brake			
CAGIVA				PEUGEOT			
W4 50		91-95	F	SV 100 L			F
FANTIC				PIAGGIO			
50.1 Oasis		86-	F	Free 50 (Disc Model)		95-00	F
50.1 Oasis KS/Rally		86-	F	Free Delivery 50		00-01	F
50.1 Oasis E.S.		87-	F	TOMOS			
50 Fast		88-	F	Streetmate		03-04	F
GARELLI				YAMAHA			
Sahel 50		91-	F	Streetmate R			F
Sahel 80		91-	F	Revival/Revival TS		03-04	F
				DT 50 R			
				97-01			
				DR 50 R-L (SM-5VB1/VG55BK)			
				02-03			

BUYERS GUIDE

DO NOT REFIT ANY SHIMS/INSULATORS TO EBC PADS FROM ORIGINAL PADS UNLESS INSTRUCTED ON NOTE ON PAD PACKAGING AND ON FA DRAWING ASSOCIATED WITH THAT PAD.

FA118 71 x 39 x 10mm



MATERIAL AVAILABILITY												
FA	TT	V	R	HH	MXS	SXR	EPFA	GPFAX	SFA	SFAC	SFAHH	
✓												

ALFER

VRE 125 4T
Divertida 250 Super Motard
Diferente Enduro
VR 250

YAMAHA

XT 600 87 F
XT 600 (Z Tenere) 85-90 F
87 F
85-90 F

FA119 82.5 x 22 x 7mm



MATERIAL AVAILABILITY												
FA	TT	V	R	HH	MXS	SXR	EPFA	GPFAX	SFA	SFAC	SFAHH	
✓	✓		✓									

YAMAHA

DT 50 LC 98- F
YZ 65 18-21 F
YZ 80 S/T/U/W/E/F/LWF//LWG/G/LWH/
H/LWJ/J/LWK/K/L/LWL/LWM/M/N/LWN 86-01 F
YZ 85 (2T - Small Wheel F 17" / R 14") 02-22 F
YZ 85 (2T - Big Wheel F 19" / R 16") 02-22 F
TT-R 125 00-22 F

FA121 81 x 42 x 9mm



MATERIAL AVAILABILITY												
FA	TT	V	R	HH	MXS	SXR	EPFA	GPFAX	SFA	SFAC	SFAHH	
✓				✓								

HONDA

CBR 250 FG/FGYA (MC14) 86 F
CBR 250 RH (MC17) 87 F
NSR 250 RG (MC16-100) 86 F
CB 350 SG/SJ 86-90 F
CBR 400 RG (NC23) 86 F
CBR 400 RHYA (NC23) 87 F
CB 450 SG/SJ 86-88 F
CBR 500 FH/FJ/FK/FL 87-90 F
CBR 600 FH/FJ/FK/FL 87-90 F
VFR 400 ZG/ZH/RG/RG-YA (NC21) 85-87 F
VFR 400 RH2/RJ (NC24) 87-88 F
XRV 750 L/M/N 'Africa Twin' 90-93 F

FA122 55 x 52.5 x 9.5mm



MATERIAL AVAILABILITY												
FA	TT	V	R	HH	MXS	SXR	EPFA	GPFAX	SFA	SFAC	SFAHH	
✓												

HONDA

CB 450 DX-K 89-92 F&R

FA123 75 x 54 x 10mm

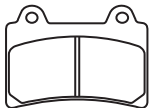

MATERIAL AVAILABILITY												
FA	TT	V	R	HH	MXS	SXR	EPFA	GPFAX	SFA	SFAC	SFAHH	
✓		✓		✓								

YAMAHA

FZR 250 87 F
TDR 250 (3CK1/3CK2 Europe) FZ 750 89-91 F
(Eng Frame # 3CK-) 88-92 F
TZR 250 (2MA/2XW1/2XW2 Europe) FZR 750 'Genesis' 87 F
(Eng Frame # 2MA-) 87-92 F
TZR 250 (1KT/2AW Japan) TDM 850 91-95 F
(Eng Frame # 1KT-000/056) 87 F
TZR 250 (2XT1 Japan) TRX 850 96-99 F
(Eng Frame 1KT-09) FZR 1000 Genesis 87-88 F
FJ 1200 (3CV/3XW type) 88-95 F
FJ 1200 A (ABS model) 91-95 F
XJR 1200 95-98 F
XVZ 13 AH/ATH Royal Star Classic 96-00 F&R
FZR 400 RSP (2TK-EX-UP) 88-89 F
XVZ 1300 TF Venture Star 99-01 R
SRX 400 (3VN1/3VN2/3VN5) 90-96 F
XV 1600 Wildstar 99-04 R

FA124 88 x 41 x 8.5mm

FA124/2 88 x 41 x 10mm



MATERIAL AVAILABILITY - FA124												
FA	TT	V	R	HH	MXS	SXR	EPFA	GPFAX	SFA	SFAC	SFAHH	
✓				✓								

MATERIAL AVAILABILITY - FA124/2												
FA	TT	V	R	HH	MXS	SXR	EPFA	GPFAX	SFA	SFAC	SFAHH	
✓		✓		✓								

FA124

E 900 ie Lucky Explorer (296mm front disc) 90 F
RS 125/250 88-89 F
CBR 750 FH Superaero 87-88 F
VFR 750 FG/FH 86-87 F
CBR 1000 FH/FJ 87-88 F
E 900 ie GT (296mm front disc) 91-92 F
HONDA
Canyon 500 96-00 F
Canyon 600 96-99 F
E 750 Elefant 93-95 F
E 900 Elefant Dakar Rep (300mm front disc) 90 F
E 900 ie Lucky Explorer (296mm front disc) 90 F
E 900 ie GT (296mm front disc) 91-92 F

FA124/2

E 900 Elefant Dakar Rep (300mm front disc) 90 F
E 900 ie Lucky Explorer (296mm front disc) 90 F
E 900 ie GT (296mm front disc) 91-92 F

BRAKE PAD BUYERS GUIDE

DO NOT REFIT ANY SHIMS/INSULATORS TO EBC PADS FROM ORIGINAL PADS UNLESS INSTRUCTED ON NOTE ON PAD PACKAGING AND ON FA DRAWING ASSOCIATED WITH THAT PAD.

FA125 94 x 32 x 7.5mm



MATERIAL AVAILABILITY											
FA	TT	V	R	HH	MXS	SXR	EPFA	GPFA	SFA	SFAC	SFAHH
	✓		✓		✓						

HONDA											
CD 250 UJ				88-92	F	XL 600 VM/VN/VP Trans Alp				91-93	F
GB 250 J/L/P/S/V 'Clubman'				89-97	F	VT 600 C/N "Shadow Custom"				93	F
VTZ 250 H/J/K				86-88	F	NX 650 J/K/L/M/N/P/R/S/T "Dominator"				88-96	F
NV 400 C/J/CK 'Steed'				92-93	F	XRV 650 J Africa Twin				88-89	F
NX 500 J/K/L/M/N/P/R/S/T Dominator				92-96	F	GL1500 J/K/SEM/SEN/SEP/SER/SES/SEV/SEW/SEX/SEY "Goldwing"				88-00	F

FA126 67.5 x 51 x 7mm

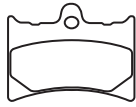

MATERIAL AVAILABILITY											
FA	TT	V	R	HH	MXS	SXR	EPFA	GPFA	SFA	SFAC	SFAHH
✓	✓		✓	✓							

ALFER											
125/250 MC				88-	F	125 CX				91-	F
250/300 GR/Enduro				88-	F	125 MX1/MXR				89-	F
APRILIA											
AF-1 125				88-91	F	125 SP 01/SP 02				89-	F
RS 125 All models				92-05	F	Nord-West 350				94-	F
Tuono 125				03-04	F	KTM					
BENELLI											
Devil 50/80				92-	F	Most Models				87	F&R
Spring 50				93-	F	MALAGUTI					
Tarno 125				89-	F	Madison 125				99	R
GILERA											
GFR 125				94	F	MOTO GUZZI					
Nordwest				94-96	F	Quota 100 D				93-95	F
						1000 Quota				92-97	F
MZ											
						Skorpion replica				95-96	F

FA128 A 37 x 85 x 8mm B 37 x 55 x 10mm



MATERIAL AVAILABILITY											
FA	TT	V	R	HH	MXS	SXR	EPFA	GPFA	SFA	SFAC	SFAHH
	✓		✓								

KAWASAKI						SUZUKI					
KSF 250 A1-A18 'Mojave'				87-03	F	LT 230 SF/SG/SH/SJ				85-88	F
KXF 250 A1/A2 Tecate				87-88	F	LT 230 EH/EJ/EK/EL/EM/EN/EP				86-93	F
KEF 300 A1/A2/A3/A4/A5/A6 Lakota				95-00	F	LT 250 SK/SL				89-90	F
KEF 300 B1/B2/B3 Lakota Sport				01-03	F	LT 250 RF/RG				85-86	F
						LT 250 RH/RJ/RK/RL/RM/RN				87-92	F
						LT 500 RH/RJ/RK/RL				87-90	F

FA129 A 141 x 41.5 x 10mm B 95 x 34.5 x 10mm

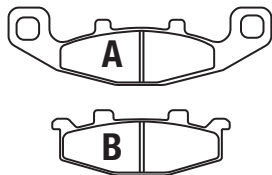

MATERIAL AVAILABILITY											
FA	TT	V	R	HH	MXS	SXR	EPFA	GPFA	SFA	SFAC	SFAHH
✓		✓	✓	✓			✓				

HYOSUNG											
Comet 250/600				02	F	ZR 750 C1-C5 'Zephyr'				91-95	F&R
KAWASAKI											
GPX 250 R (ZX 250 F2-F9)				88-95	F	ZR 750 D1 'Zephyr'				96-	R
GPX 250 R (EX 250 F)				87	F	GPz 900R A7-A8				90-96	R
KLE 250 A2 (Anhelo)				95	F	GPZ 900 R (ZX 900 A11)				98	R
KLE 250 A3/A5/A6				97/00-01	F	GPZ 900 R (ZX 900 A12-15)				99-02	R
ZZR 250 (EX 250 H1-H13)				90-03	F	ZX 100 B1-B3 (ZX-10)				88-90	F&R
ZR 250 A1-A5				91-95	F	ZG 1000 A9-A18 (1000 GTR)				94-03	F
GPX 400 R (ZX 400 F1)				87	R	ZZR 1100 (ZX 1100 C1-C3)				90-92	R
GPZ 400 R 'D4'				88	R	ZR 1100 A1-A4 'Zephyr'				92-95	R
ZL 400 D1/D2				94-95	F	ZR 1100 B1 'Zephyr'				96-97	R
ZRX 400 (ZR 400 E1/E2)				94-95	F	ZR 1100 B5 (Zephyr 1100 RS)				02	R
ZZR 400 (ZX 400 K1/K2/K3)				90-92	R	SUZUKI					
ER-5 (ER500 A1/A2/A3/A4)				97-00	F	RG 125 UN 'Wolf'				92-94	F
GPz 500 S (EX 500 A1-A6/D1-D7)				87-01	F	RG 125 UN "Wolf" (NF13E) Naked				92-94	F
KLE 500 A1-A12				91-04	F	GSF 250 N/ZM/P/NP/ZP/N/NR				92-96	F
KLE 500 B1P/B6F/B7F				05-07	F	GSX 250 SSM Katana (GJ76A)				91	F
ZR 550 B2-B6 "Zephyr"				91-99	F	GSX 250 FL/FM/FN/FP/FR/FS/FT					
GPx 600 R (ZX 600 C1-C7)				88-96	F&R	/FV/FW Across				90-98	F
ZL 600 B1 "Eliminator"				95-97	F	SW-1 250 (NJ45A)				92	F
ZZ-R 600 (ZX 600 D1-D3)				90-93	R	GSF 400 M/N/P Bandit				91-95	F
KL 650 B1-B3 "Tengai"				89-92	F	GS 500 EK/EL/EM/EN/EP/ER/ES				89-95	F
GPX 750 R (ZX 750 F1-F3)				87-89	F&R	DR 800 SM/SN/SP/SR/SS (SR43B)				91-95	F
						VX 800 L/M/N/P/R				90-95	F
						GSX 1100 GM/GN				91-94	F

FA130 A 73.5 x 49.5 x 7mm
B 61 x 63 x 9mm

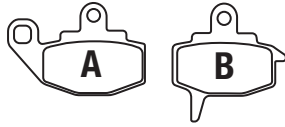

MATERIAL AVAILABILITY											
FA	TT	V	R	HH	MXS	SXR	EPFA	GPFAX	SFA	SFAC	SFAHH
✓	✓	✓	✓								

KAWASAKI

KX 125 E2/F1	87-88	F	KX 500 C1/D1	87-88	F
KX 250 E1/F1	87-88	F	KLR 650 A1-A3	87-89	F

FA131 75 x 36 x 10.5mm

FA131R 75 x 36 x 9mm

SFA131/2 75 x 36 x 7.5mm

SFA131/3 75 x 36 x 9.5mm



MATERIAL AVAILABILITY FA131											
FA	TT	V	R	HH	MXS	SXR	EPFA	GPFAX	SFA	SFAC	SFAHH
	✓		✓		✓		✓				

MATERIAL AVAILABILITY FA131/2 & FA131/3											
FA	TT	V	R	HH	MXS	SXR	EPFA	GPFAX	SFA	SFAC	SFAHH
									✓		✓

FA131 - AJP

PR5 Supermoto 250cc	09	R	XLR 250 RM/R3N/RP/RR/R3R (MD22)	91-	R	MX 300 (2T)					01-04	R
PR5 Enduro 250cc	09	R	XR 250 RL/RM/RN/RP/RR/RS	90-95	R	Enduro EN 300 (2T)					01-04	R
PR5 250cc Extreme	12-15	R	XR 250 RT/RV/RW/RX/R1-R4	96-04	R	400 (4T) MX Cross					02-03	R
CPI			XR 250 Y/3 (MD30)	00-03	R	SM 400					02-03	R
Sauel 125		R	XR 250 3/5 (MD30) Motard	03-05	R	SME 400 (4T)					04	R
FANTIC			XR 250 III Y/3 Baja	00-03	R	EN 450 F (4T)					04-	R
125cc E Competition	21	R	XR 300 R10	10	R	MX 450 F (4T)					04-	R
250cc E Competition	21	R	NX4 Falcon	02-05	R	530 (4T) Cross					02-03	R
GAS-GAS			XR 400 RT/RV/RW/RX/R1-R5	96-05	R	EN 530 F (4T)					04-	R
EC 125/200/250/300	00-08	R	XR 400 M (ND08/NC38E) Supermotard	06-08	R	SM 530					02-03	R
Pampera 125 (2T)	05-08	R	XR 600 RM/RP/RR/RS/RT/RV/RW/RX/RY	91-00	R	SME 530 (4T)					04	R
Enduro EC 200/250/300	99-00	R	XR 650 RY/R1-R6	00-06	R	YAMAHA						
MX 125/250 (MC)	01-08	R	XR 650 L	93-21	R	YZ 125 K/L/M/N/P					98-02	R
MX 200/250/300	99-00	R	HONDA DALL'ARA			YZ 250 K/L/M/N/P/R/S/T/V/W					98-02	R
SM 125/250/400 FSE	02	R	XR 250/650 R	04	R	YZ 250 FN/FP (4T)					01-02	R
SM 125/250 (2T)	01-06	R	HONDA HM (Italy)			WR 250 ZK					98	R
SM 125 (2T) Supermotard	03-06	R	CR 85 R/R2	03-07	R	WR 250 FN/FP (4T)					01-02	R
SM Halley 125cc	09	R	CRE F 250 R	08-09	R	WR 400 FL/FM/FN					99-01	R
Trail Halley 125cc	09	R	HYOSUNG			YZ 400 FL					99	R
Pampera 400	06	R	RX 400	05	R	WR 426 FN/FP					01-02	R
SM 400 FSE (2T)	01-02	R	HUSQVARNA			YZ 426 FM/FN/FP					00-02	R
EC 450 FSR/FSE Enduro (4T)	05-09	R	WXE 125	07	R							
Pampera 450 (4T)	07-08	R	KAWASAKI			SFA131/2 - PEUGEOT						
SM 450 FSR (4T) Supermotard	07-09	R	KX 125 K2-K5/L1-L4/M1-M3/M6F-M8F	95-08	R	SV 50 80/125 Geo					91-92	F
SM Halley 450cc	09	R	KLX 250 J1-J6 D-Tracker	98-03	R	SYM (SANYANG)						
Trail Halley 450cc	09	R	KLX 250 H6F/H7F	06-07	R	SR 100 Sunrise					97-	F
EC 515 FSR/FSE Enduro (4T)	05-09	R	KLX 250 F	09-20	R	HONDA						
SM 515 FSR (4T) Supermotard	07-09	R	KX 250 K2-K5/L1-L4/M1/M2/R1/R6F-R8F	95-08	R	NSR 50 X (AC10-190)					99	R
GOES			KLX 300 A2-A10/A6F/A7F	97-07	R	NS-1 75					92-	R
G 125 XM	08-09	R	KLX 400 R (KLX 400 B1/B2)	03-04	R							
G 250 XM	08-09	R	KX 500 E8-A16	96-04	R	SFA131/3 - HONDA						
HONDA			SUZUKI			NSR 50 RV/RW/RX/RY					97-00	R
CB 50 V/W Dream 50	97-98	R	DR 125 SMK8/SMK9/SML0	08-12	R	NSR 50 V (AC10-180)					97	R
XR 50 M5 (AD14) Motard	05	R	RM 125 T/V/W/X/Y/K1-K9	96-12	R	SRX 50 T/W/X 'Joker/Shadow'					97-99	F
CR 80 RN/RP/RR/RS/RT/RBT/RV/RBV		R	RM 125 XCK8	09	R	NSR 75 N/P/R/X/Y (NS-1/NSR 80)					92-00	R
/RV/RBW/RX/RBX/R1/RBY/R1/RB1		R	RM 250 T/V/W/X/Y/K1-K9	96-12	R	NSR 80 J-2/K/L/N/P/R/S (HC06)					88-93	R
/R2/RB2	92-02	R	RM 250 XCK8	09	R	NSR 80 V (HC06-170)					97	R
CR 85 R3-RR7/RB3-RB7	03-07	R	RMX 250 ST/SV/SW/SX (SJ14A)	96-99	R	NSR 80 X (HC06-180)					99	R
NH 90 M/P/R Yuppy	95-97	F	250 SBK2 (LX 250 L)	02	R	Lead 90					88-	F
XR 100 MS (HD13) Motard	05	R	DR-Z 400 SEY/EY/Y/SEK1-SEK4/EK1			NH 90 M/P/R					91-94	F
CR 125/250/500 RH/RJ/RK/RL/RM/		R	/K2-K7/EK7/SK8/SK9	00-21	R	SRX 90 T/W/X 'Shadow'					97-99	F
RN/RP/RR/RS/RT/RV/RW/RX/R1	87-01	R	DR-Z 400 SMK5-SMK9	05-22	R	PEUGEOT						
CRF 230 L	08-10	R	TM			SV 50 80/125 Geo					93-	F
CRF 230 M Supermoto	09-10	R	MX 85 JR	02-04	R							
SL 230 'Free Landsports'		R	MX 85 (Big Wheel)	02-04	R							
(MD33) V/W/X/1	97-01	R	MX 125 (2T)	01-04	R							
CRM 250 R (RM) MK2/MD24		R	Enduro EN 125 (2T)	01-04	R							
(120001-1211634)	91-92	R	MX 250 (2T)	01-04	R							
CRM 250 R (RP-RP-11) MK2/2		R	Enduro EN 250 (2T)	01-04	R							
(MD 24 1300001-)	93	R	EN 250 F (4T) Enduro	04	R							
CRM 250 'Active Radial' (MD32) ARW/ARW	97-98	R	SM 250	02	R							
XL 250 RL	90	R	SME 250 (4T)	04	R							
		R	MX 250 (4T)	02-04	R							

BRAKE PAD BUYERS GUIDE

DO NOT REFIT ANY SHIMS/INSULATORS TO EBC PADS FROM ORIGINAL PADS UNLESS INSTRUCTED ON NOTE ON PAD PACKAGING AND ON FA DRAWING ASSOCIATED WITH THAT PAD.

FA132 79.5 x 46.5 x 9mm

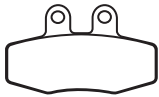

MATERIAL AVAILABILITY											
FA	TT	V	R	HH	MXS	SXR	EPFA	GPFA	SFA	SFAC	SFAHH
✓			✓								

KTM			D-XC/E-XC/E-GS 125	92-93	F	LC-4 EXC 600				92-93	F
Most 1988 Models	88	F&R	MX 250	88-91	F&R	MAICO					
Enduro Models	89-91	F&R	EXC/EGS 250	88-89	F&R	All Models				89-93	F&R
250/300 E/XC/GS	90-91	F	DXC/EXC 5-0	90	F&R	250 MX				94-98	F&R
125/350 E/XL/GS	90-91	F&R	D-XC/EXC/E-GS 250	91	F&R	500 MX				94-98	F
125/250/300/600 Enduro	92-93	F	D-XC/E-XC/T-XC/E-GS 250	92-93	F	OSSA					
125/250/400/600 LC Models	89-91	F&R	MX/EXC/EGS 350	88	F&R	500				92	F
MX 125	89-91	F&R	MX 350	89-91	F&R	PHB					
MX 125	92-93	F	DXC/EXC/EGS 350	90-91	F&R	500				92	F
EXC 125	89	F&R	EXC 350	89	F&R						
D-XC/E-XC/E-GS 125	90-91	F&R	LC-4 MX/EXC 500/600	89-91	F&R						

FA134 79.5 x 46.5 x 9mm

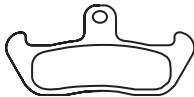

MATERIAL AVAILABILITY											
FA	TT	V	R	HH	MXS	SXR	EPFA	GPFA	SFA	SFAC	SFAHH
✓			✓								

APRILIA			HUSQVARNA			XC 500				87-88	F
AF1 125	87	F	CR 125	91	F	TC 510				89-90	F
CAGIVA			WR 125	87-88/91	F	TE 510				89-90	F
Cruiser 125	87	F	CR 240	87-88	F	WMX 510				89	F
WMX 125	89	F	WR 240	87-88/90-91	F	WXE 510				89	F
Excaliber 501 RLX	92	F	CR 250	87-88/91	F	TC 610				91	F
WMX 250	86-89	F	WR 250	87-88/90-91	F	TE 610				91	F
WM 125	87-88	F	XC 250	87-88	F	KRAM-IT (KRAMER)					
750 Elefant	90-92	F	WR 260	90-91	F	ER 125/250/300 RV3				88-	F
GILERA			TE 350	90-91	F	ER 500/600				96-	F
125 Apache	91-	F	WR 400	87-88	F	MOTO MORINI					
RC 125 Top Rally	89-92	F	CR 430	87-88	F	Excaliber 350/501 RLX				93-	F
RC 600	89-90	F	WR 430	87-88	F	Dart 350				87	F
HONDA HM (Italy)			XC 430	87-88	F	YAMAHA					
CRE 50 Six/Baja/Derapage Brembo caliper/Kayaba forks	95-02	F	430 Automatic CR 500	87-88	F	TDR 125 (3HS1/3XD0/3HS3/3XD01)				89-93	F
				87-88	F	TDR 125 R Lightburner (3SH2/3XE2)				93-94	F

FA135 A 97 x 43 x 7.5mm B 77 x 42 x 9mm



MATERIAL AVAILABILITY											
FA	TT	V	R	HH	MXS	SXR	EPFA	GPFA	SFA	SFAC	SFAHH
	✓		✓		✓						

AEON			CF 500 US - Z Force 550 (Side x Side)	15	F(left)	KX 125 G1/H1/H2/J1/J2				89-93	F
Crossland 400 (2x4/4x4)	12-15	R	CF 500 UU U Force 550 (Side x Side)	15	F(left)	KLX 150 L (KLX 150 EFF)				14-15	F
APACHE			CF 600 Z Force Z8 (Side x Side)	13-15	F(left)	KLX 150 D-Tracker (KLX150 HGF)				16	F
RLX 250 S/SX (Mk1) Rear disc model		R	CF 600 Z Force Z8-EX (Side x Side)	13-15	F(left)	KDX 200 E5/E6				93-94	F
BAROSSA QUADS			CF 625 3 (Z6 Terra Cross)	11-12	F(left)	KDX 200 SR (DX200G)					F
170 Sport	03-04	R	CF 800 Z Force Z8 (Side x Side)	13-15	F(left)	KX 250 G1/H1/H2/J1/J2				89-93	F
170 Cheetah/Magna	03-05	R	CF 800 Z Force Z8-EX (Side x Side)	14-15	F(left)	KDX 250 SR (KDX 250 F1)				91-94	F
Quarterback 250	05	R	CF 800-3 (Tracker 800 Side x Side)	13	F(left)	KDX 250 D1				91-93	F
CAN AM (SIDE X SIDE)			CF 800 UU-AA U-Force 800	14-16	F(left)	KLX 250 F				09-20	F
Commander 800 (XT/DPS)	11-15	F(right)&R	U Force 800 (Side x Side)	14-16	F(left)	KLF 300 C1-C17 "Bayou"				89-05	F(right)
Commander 800 R (STD)	11-15	F(right)&R	ECO			KLX 300 R				19-20	F
Commander 800 R XT	11-14	F(right)&R	Bushman 150 (LX 150 GY)		F	KVF 650 FCF/FCS/FDF				12-13	F(right)
Commander 1000 (STD)	11-15	F(right)&R	GAS GAS			KLX 400 B1-B7 Bayou				93-99	F(right)
Commander 1000 X	11-13	F(right)&R	KZ 250 RV Quad	06	F(left)	KX 500 E1-E5				89-93	F
Commander 1000 XT	11-15	F(right)&R	GOES			KVF 650 F7F/F8F Brute Force					
Commander 1000 XT-P	14-15	F(right)&R	G 520 UTX (Side x Side)	10-11	F(right)	4x4i Hardwoods Green				07-08	F(right)
Commander 1000 (DPS)	13-15	F(right)&R	HUSQVARNA			KVF 650 H7F/H8F Brute Force 4x4i				07-08	F(right)
Commander 1000 LTD	12-15	F(right)&R	CR 125	92-94	F	KVF 650 67F/68F Brute Force					
Maverick 1000 R STD	13-14	F(right)	WR 125	93-94	F	4x4i Hardwoods Green				07-08	F(right)
Maverick 1000 R-XRS	13-14	F(right)	CR 250/WR 250	92-94	F	KVF 750 A1/B1/A2/B2					
Maverick 1000 R-XRS/DPS	14	F(right)	TE 350	92-94	F	Brute Force 4x4				05-06	F(right)
Maverick 1000 R XMR	14	F(right)	CR 360/WR 360	92-94	F	KVF 750 E8FA Brute Force					
Maverick 1000 R XXC	14	F(right)	TE 610/TC 610	92-94	F	4x4 Hardwoods Green HD				08	F(right)
Ryker 600 Ace	18-21	F(right)	KAWASAKI			KVF 750 D8F/D9F/DAF/DBF				08-11	F(right)
Ryker 900 Ace	18-21	F(right)	KLX 125 CAF/CBF/CCF/CCS/			KVF 750 GCF/GDF/GEF/GFF					
CF MOTO			CDS/CDF/CEF/CFF/CGF	10-16	F	/GGF/GHF Brute Force 4X4i EPS				12-17	F(right)
CF 500 3 (Rancher 500 Side x Side)	10-11	F(left)	KLX 125 DAF/DBF/DCF/DDF/DEF			KVF 750 HCF/HDF/HEF/HFF/HGF					
CF 500 AU-6L - C Force 550 (ATV)	15	R	D-Tracker	10-14	F	/HHF Brute Force 4X4i EPS/Camo				12-17	F(right)

FA135 A 97 x 43 x 7.5mm B 77 x 42 x 9mm

MATERIAL AVAILABILITY											
FA	TT	V	R	HH	MXS	SXR	EPFA	GPFAX	SFA	SFAC	SFAHHI
	✓		✓		✓						

Contd.

KVF 750 JCF/JDF/JEF/JFF/JGF /JHF Brute Force 4x4i EPS	12-17	F(right)	Mule Pro FX/EPS LE	16-18	F(right)	LT-F 300 FK2			02	F(right)
KVF 750 LCF/LDF/LEF/LFF/LGF /LHF Brute Force 4x4i	12-17	F(right)	KAF 820 HGF/HHF Mule PRO - FX/EPS Camo	16-17	F(right)	DR 350 SL/SM/SN/SP 4 bolt front disc/kick start			90-93	F
KRF 750 Teryx 750 4x4 (RUV) A8F/B8F	08	F(right)	KAF 820 JGF/JHF Mule PRO - FXT Ranch Edition	16-17	F(right)	DR 350 SER/SES (Electric start /4 bolt front disc)			94-95	F
KRF 750 Teryx 750 4x4 LE (RUV) C8F/D8F	08	F(right)	KAF 1000 AGF/AHF/AJF Mule Pro DXT/Diesel	16-18	F(right)	DR 350 SET/SEV (Electric start /4 bolt front disc)			96-97	F
KRF 750 TAF/VBP Teryx 750 Fi 4x4 SGO	10-11	F(right)	KAF 1000 BGF/BHF/BJF Mule Pro DXT/Diesel EPS	16-18	F(right)	LT-R 450 K6/K7/K8/K9/L0/L1			06-12	F(right)
KRF 750 G9F/NAF/NBF/NCS/NDF Teryx 750 Fi 4x4	09-12	F(right)	KAF 1000 CGF/CHF - Mule Pro DXT/Diesel EPS	16-17	F(right)	LT-A 500 FY/FK1			00-01	F(right)
KRF 750 J9FA/K9F/PAF/RAF/PBF /RBF/RCS/PDF/RDF Teryx 750 Fi 4x4 LE	09-13	F(right)	KAF 1000 DGF/DHF - Mule Pro DX/Diesel	16-17	F(right)	LT-F 500 FW/FX/FY/FK1/FK2			98-02	F(right)
KRF 750 L9F Teryx 750 Fi 4x4 LE Sport	09	F(right)	KAF 1000 EGF/EHF/EJF Mule Pro DX/Diesel	16-18	F(right)	YAMAHA XTZ 125 K/E			05-10	F
KRF 750 M9F Teryx 750 Fi 4x4 NRA Outdoors	09	F(right)	KAF 1000 FGF/FHF - Mule Pro DX EPS LE/Diesel	16-17	F(right)	XTZ 125 (5RM)			03-10	F
KRF 750 SAF/SAFA/SBF/SBFA/SCS /SCSA Teryx 750 Fi 4x4 Sport LE	10-12	F(right)	KAF 1000 GGF/GHF - Mule Pro DX EPS LE/Diesel	16-17	F(right)	YZ 125 W/A/B/D/E/F/G/H/J			89-97	F
KRT 750 ACF/ADF (Teryx 4 750 4x4)	12-13	F(right)	KAF 1000 HGF/HHF - Mule Pro MX 300 (4T/4V)	11-12	F	DT 200 WR (3XP)			92-93	F
KRT 750 ACFA/ADFA (Teryx 4 750 4x4 EPS)	12-13	F(right)	KAF 1000 IGF/IFH - Mule Pro MX 300 (4T/4V) (Enduro model)	11-12	F	WR 200 D/E/F			92-94	F
KRT 750 CCF/CD (Teryx 4 750 4x4 EPS LE)	12-13	F(right)	KREIDLER 125 DD Supermoto	12-13	F	DT 230 (4TP1/2) Lanza			91-98	F
Teryx 750 4x4 NRA Outdoors (RUV) KRF 750 F8F	08	F(right)	LEXMOTO Adrenaline 125 XFLM125GY-2B	13-18	F	TT 250 R (4GY) Raid/4MR2			96	F
KRF 800 BEF/BFF/FGF/FHF/FJF (Teryx)	14-18	F(right)	Michigan 125 (ZS125-79)	13-20	F	TT 250 R RL/RM/RN/RR/RS			99-04	F
KRF 800 CEF/CFE/CGF/GHF/GJF (Teryx LE)	14-18	F(right)	MOTO ROMA Road Runner 125	04-05	F	TT 250 R (4R1/2) Japan)			93-94	F
KRF 800 DEF/DFF/HGF/HHF/HJF (Teryx Camo)	14-18	F(right)	PUZEY MTD 300 (4T/4V) (Motard model)	11-12	F	TT 250 RL (4PX5)			99	F
KRT 800 BEF/BFF/FGF/FHF/FJF (Teryx 4)	14-18	F(right)	MX 300 (4T/4V) (Enduro model)	11-12	F	TT 250 RM (4PX6)			00	F
KRT 800 CEF/CFE/CGF/GHF/GJF (Teryx 4 LE)	14-18	F(right)	QUADZILLA Stingr R170E	06	R	TT 250 R (4GY3/4GY5/4WA1) Raid			94-96	F
KRT 800 DEF/DFF/HGF/HHF/HJF (Teryx 4 Camo)	14-18	F(right)	ST 200 E (Automatic)	06	R	WR 250 ZB/ZD/ZE/ZF/ZG/ZH/ZJ			91-97	F
KAF 820 AFF/AGF/AHF/AJF Mule Pro FXT	15-18	F(right)	Z8 4X4 (Side X Side/800cc)	14-15	F (Left)	XTZ 250 Lander (Brasil) (4B41/2/3)			07-09	F
KAF 820 BFF/BGF/BHF/BJF Mule Pro FXT/EPS	15-18	F(right)	SINNIS Apache 125 QM 125 GY-2B(A) (Rear disc model)	09-10	F	YZ 250 D/E/F/G/H/J			92-97	F
KAF 820 CFF/CGF/CHF/CJF Mule Pro FXT/EPS LE	15-18	F(right)	Apache (Rear drum model)	09-10	F	YZ 250 W/WRW			89	F
KAF 820 DFF/DGF/DHF/DJF Mule Pro FXT/EPS Camo	15-18	F(right)	Apache SM/SMR 125	15-20	F	YZ 250 A/WRA/B			90-91	F
KAF 820 EGF/EHF/EJF Mule Pro FX	16-18	F(right)	Blade 125 QM 125 GY-2B	08-10	F	YZ 250 A/WRA/B			90-91	F
KAF 820 FGF/FHF/FJF Mule Pro FX/EPS	16-18	F(right)	Blade X 125	15-20	F	YZ 250 W/WRW			89	F
KAF 820 GGF/GHF/GJF	16-18	F(right)	QM 250 GY-D Apache 250	13-14	F	YZ 250 A/WRA/B			90-91	F
			SUPERBYKE RMR 125	07-09	F	YZ 250 W/WRW			89	F
			SUZUKI EN 125-2/125-2A	05	F	YZ 250 W/WRW			89	F
			TS 125 RK/RL/RM/RN/RR	90-96	F	YZ 250 W/WRW			90-91	F
			RM 125/250 H/J/K/L/M/N/P/R/S	87-95	F	YZ 250 W/WRW			90-91	F
			TS 200 RK/RL/RM/RN/RR	89-94	F	YZ 250 W/WRW			90-91	F
			DR 250 SL/SM/SN/SEP/SER			YZ 250 W/WRW			90-91	F
			/SES (SJ448)	90-95	F	YZ 250 W/WRW			90-91	F
			RMX 250 K/M/N/P/R/S	89-95	F	YZ 250 W/WRW			90-91	F
			RMX 250 SN/SR/SS (SJ13A)	95-97	F	YZ 250 W/WRW			90-91	F

FA136 80 x 40 x 10mm



MATERIAL AVAILABILITY											
FA	TT	V	R	HH	MXS	SXR	EPFA	GPFAX	SFA	SFAC	SFAHHI
✓											

YAMAHA
XV 535 Virago

88-94 F

FA137 47 x 45 x 7.5mm



MATERIAL AVAILABILITY											
FA	TT	V	R	HH	MXS	SXR	EPFA	GPFAX	SFA	SFAC	SFAHHI
	✓		✓								

ARCTIC CAT

400 DVX (2x4) Sport
400 DVX TS Sport

KAWASAKI

KSF 400 A1/A2/A3 (KFX 400)

SUZUKI

LT 250 RH/RJ/RK/RL

LT-Z 400 K3-K9/L0/L1

LT-R 450 K6-K9/L0/L1-L3

LT 500 RL

87-90 R
03-12 R
06-13 R
90 R

FA140 86 x 40 x 10.5mm



MATERIAL AVAILABILITY											
FA	TT	V	R	HH	MXS	SXR	EPFA	GPFA	SFA	SFAC	SFAHH
✓		✓		✓					✓	✓	✓

HONDA

FES 125/150 3/4/5 Pantheon	03-06	R
CB 250 FT/FV/FX/FY/F1 'Hornet'	96-01	R
CBR 250 RH (MC17)	87	R
CBR 250 RJ/RK/RK2 (MC19)	88-89	R
FES 250 Y1/2/5 Foreight	00-05	R
NSR 250 R6K/R6K-2 (MC18-110)	89	R
NSR 250 R7L/R7N (MC21-100/106)	90	R
NSR 250 R8L-3/R9L/R8N/R8N-3 (MC21-101/102/106)	90-92	R
NSR 250 R9N (MC21-106)	92	R
NSR 250 R2J (MC18-100/R4J (MC18-100)	88	R
NSR 250 R5K/R5K-2 (MC18-110)	89	R
VT 250 FL Spada/Castec	88-90	R
VTR 250 W/Y/1-7 (MC33)	98-07	R
VTR 250-9	09-10	R
CB-1 (CB 400 F)	89-90	R
NT 400 'Bros' NC25		R
CB 400 SF (F2N/F2R) Superfour (NC31)	92-	R
CB 400 SF (F2V/F3T) Superfour (NC31)	96-97	R
CB 400 SF (F3V) Superfour (NC31)	97	R
CB 400 Four V/V-II/W/W-II (NC36)	97-98	R
CBR 400 RR/JK (NC23 Tri-arm)	92-93	R
CBR 400 RRL/RRN/RRR (NC29 Gull-arm)	90-94	R
VFR 400 RH2/RJ (NC24)	87-88	R
CB 500 FA	13-21	R
CB 500 X (Non ABS/Twin)	14-20	R
CB 500 XA (ABS/Twin)	14-21	R
CBR 500 R (Non ABS/Twin)	13-20	R
CBR 500 RA (ABS/Twin)	13-21	R
CMX 500 Rebel ABS	18-21	R
NX 500 J/K/L/M/N/P/R/S/T Dominator	92-96	R
NTV 600 J/K/M Revere	88-92	R
XL 600 VM/VN/VP/VR/VT/VV/W/VX "Trans Alp"	91-00	R
FMX 650 5/6	05-08	R
NT 650 J/K/L 'Bros'	88-92	R
NT 650 V/W	98	R
NTV 650 J/K/L/M/P/S/T/V	88-97	R
NX 650 J/K/L/M/N/P/R/S/T "Dominator"	88-	R
NT 650 VW/VX/VY/V1 "Deauville"	98-01	R
XL 650 VY/V1-V7 Transalp	00-07	R
XRV 650 J Africa Twin	88-89	R
CTX 700 DE-DCT	14-21	R
CTX 700 N-DCT	14-21	R
NC 700 S (Non ABS)	12-13	R
NC 700 X (Non ABS)	12-13	R
NM4 Vultus (NC 750 J)	15-20	R
XL 700 V8/V9/VA (Transalp/2 piston front caliper/ABS on rear disc)	08-11	R
XRV 750 L/M/N/P/R/S/T/V/W/X/Y "Africa Twin"	90-03	R

KAWASAKI

EN 650 AFF - Vulcan S - Non ABS	15	R
EN 650 BFF - Vulcan S - ABS	15	R
KLE 650 Verseys (KLE 650 EFF Non ABS)	15	R
KLE 650 Verseys (KLE 650 FFF ABS)	15	R
Z 750 R Non ABS (ZR 750 NBF/NCF)	11-12	R
Z 750 R ABS (ZR 750 PBF/PCF)	11-12	R
Z 800 E (Z 800 CDS/CEF/CCF/CGF - Non ABS)	13-20	R
Z 800 E (Z 800 DDS/DEF/DF/DFG - ABS Model)	13-20	R
Z 800 (Z 800 ADS/AEF/AFF/AGF - Non ABS)	13-20	R
Z 800 (Z 800 BDS/BEF/BFF/BGF - ABS Model)	13-20	R
Z 900 (ZR 900 AHF/AJF - Non ABS)	17-21	R
Z 900 (ZR 900 BHF/BJF/DJF - ABS)	17-21	R
Z 900 RS	18-20	R
Z 900 Café	18-21	R

KREIDLER

125 Street DD	12-13	R
---------------	-------	---

LEXMOTO

Assault 125 Efi HJ125-J-E4	21	R
LXR 125 SE SY125-10-SE	19-21	R
LXR 380 TR380-GP1	19-21	R

BUELL

X1 Lightning	98-05	R
M2 Cyclone	00-05	R
Blast	00-07	R
Firebolt XB9R	02-07	R
XB9S Lightning	03-04	R
XB9SX Lightning CityX	05-09	R
XB9SX Lightning	08-10	R
XB12R Firebolt	04-10	R
XB12S Lightning	04-08	R
XB12SS Lightning	09-10	R
XB12X Ulysses	06-10	R
XB12XT Ulysses	08-10	R
XB12 SCG Lightning	06-08	R
XB12SS Lightning Long	06-09	R
XB12STT Lightning	08	R
XB12SCG Lightning	09-10	R

PEUGEOT

SV 250	01-02	R
--------	-------	---

SINNIS

Stealth 125 QM125-2D	08-10	R
----------------------	-------	---

SUZUKI

XF 650 V/W/X/Y Freewind	97-02	R
-------------------------	-------	---

TRIUMPH

Daytona 600	03-04	R
Speedfour 600	02-05	R
TT 600	00-03	R

Daytona 650	05	R
Trident 660cc	21	R
Daytona 675	06-12	R
Daytona 675 R (Brembo calipers)	11-12	R
Street Triple 675 (Naked)	07-12	R
Street Triple R 675	09-12	R
Tiger 800 (Non ABS)	11-14	R
Tiger 800 (ABS)	11-14	R
Tiger 800 XC (Non ABS)	11-14	R
Tiger 800 XC (ABS)	11-20	R
Tiger 800 XCa (ABS)	15-20	R
Tiger 800 XCx (ABS)	15-20	R
Tiger 800 XR (ABS)	15-20	R
Tiger 800 XRt (ABS)	15-20	R
Tiger 800 XRx (ABS)	15-20	R
Tiger 900	20	R
Tiger 900 GT	20	R
Tiger 900 GT low	20	R
Tiger 900 GT Pro	20	R
Tiger 900 Rally	20	R
Tiger 900 Rally Pro	20	R
Trident 660cc	21	R
Daytona 955i	01-04	R
Bonneville Bobber		R
(1200cc Liquid Cooled)	17-21	R
Bonneville Bobber Black (1200cc Liquid Cooled)	18-21	R
Bonneville Speedmaster (1200cc Liquid Cooled)	18-21	R

YAMAHA

XJ6-N (600cc) (Naked - 20S)		R
ABS/Non ABS	09-12	R
XJ6-S Diversion (600cc) (Top fairing - 36C) ABS and Non ABS version	09-12	R
XJ6-F Diversion (600cc) (Full Fairing - 1CW) (Non ABS/ABS)	10-12	R

ZERO

Zero DS (Dual Sport)		R
(Nissan F/J.Juan R Calipers)	14	R
Zero FX (Stealthfighter)		R
(Nissan F/J.Juan R Calipers)	14	R
Zero S (Streetfighter) / (Nissan F/J.Juan R Calipers)	14	R
Zero SR (Max Performance) / (Nissan F/J.Juan R Calipers)	14	R

ZONTES

R 310	20	R
X 310	20	R
T 310	20	R
V 310	20	R

FA141 A 106 x 38 x 9mm

B 76.5 x 27 x 10.5mm



MATERIAL AVAILABILITY											
FA	TT	V	R	HH	MXS	SXR	EPFA	GPFA	SFA	SFAC	SFAHH
✓											

KAWASAKI

KR-1 (KR 250 B2)	89	F&R
KR1S (KR 250C2/C3)	90-92	R
GPX 250 R (ZX 250 F2-F9)	88-95	R
GPX 250 R (EX 250 F)	87	R
GPX 250 R II (EX 250 G)	88	F&R
ZXR 250 C1-C5 (ZX 250 C1-C5)	91-95	F
ZXR 250 R (ZX 250 D1)	91	F
ZXR 250 (ZX 250 A1/A2)	89/90	F&R
ZXR 250 R (ZX 250 B1/B2)	89-90	F&R
GPX 400 R (ZX 400 F1)	87	F

GPZ 400 R 'D4'	88	F
ZR 400 D1/D3/D4 'Zanthus'	92-95	F
ZX-4 (ZX 400 G1/G1A/G1B)	88	F&R
GPZ 500 S (EX 500 E1-E10)	94-04	F
ZR 550 B2/B3 'Zephyr'	91-93	R
RGV 250 M/N/P/R/S/T	91-96	R
RGV 250 T (RGVR 250 SP VJ23A)	96	R

SUZUKI

RGV 250 M/N/P/R/S/T	91-96	R
RGV 250 T (RGVR 250 SP VJ23A)	96	R

BUYERS GUIDE

DO NOT REFIT ANY SHIMS/INSULATORS TO EBC PADS FROM ORIGINAL PADS UNLESS INSTRUCTED ON NOTE ON PAD PACKAGING AND ON FA DRAWING ASSOCIATED WITH THAT PAD.

FA142 102 x 38 x 9mm

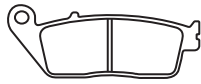

MATERIAL AVAILABILITY

FA	TT	V	R	HH	MXS	SXR	EPFA	GPFA	SFA	SFAC	SFAHH
✓		✓		✓					✓	✓	✓

BRAKE PAD BUYERS GUIDE

DO NOT REFIT ANY SHIMS/INSULATORS TO EBC PADS FROM ORIGINAL PADS UNLESS INSTRUCTED ON NOTE ON PAD PACKAGING AND ON FA DRAWING ASSOCIATED WITH THAT PAD.

BENELLI

Leoncino 500 Trail 18-19 F

BMW

C Evolution Electric 18-20 F
 C 600 Sport Scooter 12-15 F
 C 600 Sport Highline 13-15 F
 C 650 GT Scooter 12-21 F
 C 650 GT Highline 13-18 F
 C 650 Sport Scooter 16-21 F
 C Evolution (Scooter) 14-18 F

CAGIVA

900 IE Canyon/Gran Canyon' 98-00 F
 Navigator 1000 00-05 F

DAELIM

SQ 125 Freewing S2 06 F
 Roadwin R 250 Fi (VJF 250) 08-11 F
 Roadsport 250 (VJF 250) 10-14 F
 SQ 250 Freeway S2 06 F
 VL 250 Daystar 13-14 F

HONDA

CBR 250 RB/RC (Non ABS) 11-13 F
 CBR 250 RJ/RK/RK2 (MC19) 88-89 F
 CBR 250 RRL/RRN/RRR (MC22) 90-94 F
 VT 250 FL Spada/Castec 88-90 F
 CBR 300 RAE (ABS) 14 F
 CB-1 (CB 400 F) 89-90 F
 CB 400 SF "Superfour" (NC31) 92-95 F
 (F2N/F2R/F2S/F2T/F3S)
 CB 400 Four V/V-II/W/W-II (NC36) 97-98 F
 CBR 400 RR/J/K (NC23 Tri-Arm) 92-93 F
 CBR 400 RRL/RRN/RRR (NC29 Gull Arm) 90-94 F
 NV 400 CS/CV 'Steed' 95-97 F
 XR 400 M (ND08/NC38E) Supermotard 06-08 F
 NTV 600 J/K/M Reverse 88-92 F
 VT 600 CR/CS/CT/CV/CW/CX 'Shadow Custom' 94-99 F
 CB 650 FE/FG/FH/FJ 14-20 F
 CB 650 FAE/FAF/FAG/FAH (ABS) 14-20 F
 CBR 650 FAE/FAF/FAG/FAH/FAJ (ABS) 14-20 F
 NTV 650 J/K/L/M/P/S/T/V 88-97 F
 NX 650 J/K/L/LI/M/N/P/R/S/T/V 88-97 R
 CBR 750 FJ "Superaero" 88 F
 VFR 750 FJ/FK/FL/FM/FN/FP/FR/FS/FT/FV 88-97 F
 CB 750 F2N/F2R/F2S/F2T/F2V/F2W /F2X/F2Y/F21 'CB Seven fifty' 92-02 F
 PC 800 'Pacific Coast' 89-97 F
 Z 800 E (Z 800 CDS - Non ABS) 13 F
 CBR 1000 FK/FL/FM/FN 89-92 F
 ST 1100 AN/AP/AR/AS Pan European (ABS Model) 92-95 F
 ST 1100 L/M/N/P/R/S/T/V/W/X/Y/1/2 Pan European - Non ABS 90-02 F
 GL 1500 'CV/CW/CX/CY/C1/C2' (F6C) 97-03 F

GENERIC/KSR

TW 125 SM 13-15 F

ITALJET

Marco Polo 400xx Scooter 07-09 F

CZ/JAWA

350 Classic 13-14 F
 350 New Classic 13-14 F

KAWASAKI

J 125 ABS (SC125 AGF/BGF/CGF /CHF/CJF) 16-18 F
 J 125 SE/ABS (SC125 AGFA/BGFA /CGFA/CHFA/CJFA) 16-21 F
 J300 AEF/AFF/AGF (Non ABS) 14-16 F
 J300 AEFA/AFFA/AGFA Special Edition (Non ABS) 14-16 F
 J300 BEF/BFF/BGF/CHF/CJF (ABS) 14-20 F
 J300 BEFA/BFFA/BGFA/CHFA/CJFA Special Edition (ABS) 14-20 F
 KLE 300 CHF/CJF Versys-X 300 ABS 17-20 F

KLE 300 BHF Versys-X 300 Non ABS 17-20 F

EN 650 AFF - Vulcan S - Non ABS 15 R

EN 650 BFF - Vulcan S - ABS 15 R

KLE 650 Versys (KLE 650 EFF Non ABS) 15 F

KLE 650 Versys (Non ABS) KLE650 EGF 16-21 F

KLE 650 Versys (ABS) KLE 650 FGF/FHF/FHFA/FJF/JFA 16-21 F

Z 650 (ER650GHF/Non ABS) 17-21 F

Z 650 (ER650HHF/HJF - ABS) 17-20 F

Z 750 (ZR 750 L7F-L9F/LAF/LBF) 07-11 F

Z 750 ABS (ZR 750 M7F-M9F /MAF/MBF) 07-11 F

Z 800 E CDS/CEF/CFF (Non ABS) 13-16 F

KYMCO

Downtown/Super Dink 125i (C21000) 09-15 F
 Grand Dink 125 12-15 F
 K-XCT 125i 12-15 F
 Dntown 200i 10-15 F
 People 250 03-06 R
 Xciting 250/250i 05-07 F
 Xciting 250 05 F
 Xciting 250i 06-08 F
 Dntown/Super Dink 300i (V20000) 09-12 F
 Dntown 300i (ABS/C20010) 10-15 F
 Grand Dink 300i 12-20 F
 Xciting 300i (T72000) (EFI Model) 08 F
 Xciting 300i R (T72001/72011) 08-15 F
 Xciting 500 Ri (T70021) (EFI Model) 09-15 F
 Xciting 500i (T70020) (EFI Model) 06-08 F
 Xciting 500 (T70000) (Carb Model) 05 F
 Xciting Evo 500i ABS 13 F
 My Road 700i 12-15 F

MASH

Family Side 400cc Side Car Outfit 18-20 F
 Scrambler 400cc (Dirtstar 400) 17-20 F
 400 Roadstar (Five Hundred) 14-20 F

PEUGEOT

Geopolis 300 GT 14 F
 Satelis 400 Premium (Nissin Calipers) 08-11 F
 Satelis 400 Urban (Nissin Calipers/ABS) 08-12 F
 Satellis 400 RS (Nissin Calipers) 08-14 F
 Geopolis 500 08-11 F
 Satelis 500 07-12 F
 Satelis 500 RS (Nissin Calipers) 08-12 F

SACHS

Quattrocento 400 08 F

SUZUKI

GW 250 L3/ZL5 Inazuma 13-15 F
 GW 250 FL5 Inazuma 15 F
 GSX 400 R/S/T/ZR/ZS/ZT "Impulse Type" 94-96 F
 RF 400 RP/RR/VR/RT/RVT/RV-V (GK78A) 93-97 F
 RF 600 RP/RR/RS/RT/RV 93-97 F
 AN 650 K3-K9/LO Burgman/Non ABS 04-11 F
 AN 650 AK4-AK9/AZK8/ALO Burgman/ABS 04-12 F
 AN 650 ZL3-ZL8 Burgman ABS Executive 13-19 F
 AN 650 L3-L6 Burgman Non ABS 13-16 F
 GSF 650 S/T/V/W/X Naked Bandit 95-99 F
 GSX 650 ST/SV/SW/SX Faired Bandit 95-99 F

S.W.M.

Gran Milano 440 (4T) 15 F
 Gran Turismo 440 (4T) 15 F
 Silver Vase 440 (4T) 15 F

TRIUMPH

Speedmaster (865cc/EFI) 08-10 F
 Street Scrambler (900cc Liquid Cooled) 16-20 F
 Street Twin (900cc Liquid Cooled) 16-20 F
 Street Cup (900cc Liquid Cooled) 16-20 F
 Thruxton 900 04-16 F
 Thruxton Ace 900 15-16 F

Thruyton 1200 (Liquid Cooled) 16-20 F

T100 900cc 16-21 F

T100 Black 900cc 16-21 F

Bonneville T120 (1200cc Liquid Cooled) 16-20 F

Bonneville T120 Black (1200cc Liquid Cooled) 16-20 F

Bonneville Bobber (1200cc Liquid Cooled) 17-20 F

America (6 spoke cast wheel) 07-09 F

America (12 spoke cast wheel - 865cc) 10-17 F

America LT (12 spoke cast wheels /865cc) 14-17 F

Bonneville America 02-06 F

Bonneville 800 01-06 F

Bonneville/Bonneville Black (865cc) 07-08 F

Bonneville T214 (Spoke wheel/865cc) 15 F

Bonneville Spirit (Spoke wheel/865cc) 15 F

Bonneville T100 (790cc) 02-04 F

Bonneville T100 (865cc) 05-09 F

Bonneville T100 (865cc/Air Cooled /Spoke wheel) 10-16 F

Bonneville T100 Black (865cc /Air Cooled/Spoke wheel) 14-16 F

Bonneville Steve McQueen SE 12 F

Scrambler (865cc) 06-15 F

Bonneville T100 (900cc /Liquid Cooled/Spoke Wheel) 16-20 F

Bonneville T100 Black (900cc /Liquid Cooled/Spoke Wheel) 16-20 F

VOXAN

Scrambler 1000 06 F

YAMAHA

Majesty S 125 XC 125 R 14-15 F

WR 125 X (Supermoto) 09-18 F

WR 125 R 09-15 F

WR 250 XX/XY (Supermoto) (32D2/4) 08-15 F

ZONTES

R 310 20 F

X 310 20 F

T 310 20 F

V 310 20 F

FA143 94 x 32 x 10mm



MATERIAL AVAILABILITY												
FA	TT	V	R	HH	MXS	SXR	EPFA	GPFAX	SFA	SFAC	SFAHH	
✓												

HONDA

NSR 250 R2R/R3R (MC28-110)						VFR 400 RK/R3L/R3M/R3N (NC30)	89-92	R
R2T/R3T (MC28-120)	94	R				NR 750 N	92	R
NSR 250 RR (MC28-100)	94	R				VFR 750 RJ/RK/RL (RC30)	88-90	R
RVF 400 RR/RR-II/RT/RT-II (NC35)	94-96	R				RVF 750 RR/RS 'RC45'	94-98	R

FA145 70 x 55.5 x 8mm

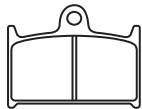

MATERIAL AVAILABILITY												
FA	TT	V	R	HH	MXS	SXR	EPFA	GPFAX	SFA	SFAC	SFAHH	
✓				✓			✓					

SUZUKI

GSXR 400 RL/RM/RN/RP/RS (GK76A)	90-95	F									
GSXR 750 J/K/L/M/WN/WP	88-93	F									
GSXR 750 RG	86	F									
RF 900 RR/RS/RS2/RT/RV/RW	94-98	F									
GSXR 1100 K/L/M/N	89-92	F									
GSF 1200 T/ST/V/SV/W/SW/X											
/SX/SY 'Bandit'	96-00	F									
GSF 1200 SAV ABS Bandit	97	F									

YAMAHA

TZ 125	94-97	F
TZ 250	89-02	F
FZR 750 R "OWO1"	89-90	F
MZ/MUZ		
1000 S	03-07	F
1000 SF	05-07	F
1000 SFX	07	F
1000 ST	07	F

FA146 59 x 57 x 9mm

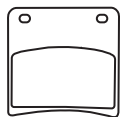

MATERIAL AVAILABILITY												
FA	TT	V	R	HH	MXS	SXR	EPFA	GPFAX	SFA	SFAC	SFAHH	
✓		✓		✓								

SUZUKI

GW 250 L3 Inazuma	13	F				GSX 1100 FJ/FK/FL/FM/FN/FP/FR	88-94	F
GSX 400 FJ/FK/FAK/FL (GK74A)	88-90	F				GSX 1100 GM/GN	91-94	R
GSX 600 FJ/FK/FL/FM/FN/FP/FR/FS/FT/FV	88-97	F				GV 1400 GDG/GCG/GDH/GDJ		
GSX 750 FK/FL/FM/FN/FP/FR/FS/FT/FV	89-97	F				"Cavalcade"	86-88	F
VX 800 L/M/N/P/R/T	90-96	R						

FA147 A 118 x 48 x 8.5mm B 97.5 x 57 x 11mm

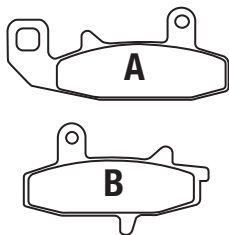

MATERIAL AVAILABILITY												
FA	TT	V	R	HH	MXS	SXR	EPFA	GPFAX	SFA	SFAC	SFAHH	
✓			✓									

SUZUKI

DR 650 RER/RES (SP45A/B)	94-95	F				DR 650 RSL/RSM (SP42A)	90-91	F
DR 650 RSEM/RSEN/RSEP (SP43A/B)	91-93	F				DR 650 RUN/RN/RUP/RP (SP44A/B)	92-93	F
DR 650 RL/RM (SP41A)	90-91	F				DR 750 SJ/SK	88-89	F
						DR 800 SL	90	F

FA150 57.5 x 59 x 9mm

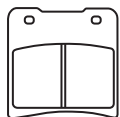

MATERIAL AVAILABILITY												
FA	TT	V	R	HH	MXS	SXR	EPFA	GPFAX	SFA	SFAC	SFAHH	
✓		✓		✓								

SUZUKI

GV 1400 GDG/GCG/GDH/GDJ/GCH											
'Cavalcade' (from f.no -103765)	86-88	R									

FA151 51 x 36.5 x 8.5mm



MATERIAL AVAILABILITY												
FA	TT	V	R	HH	MXS	SXR	EPFA	GPFAX	SFA	SFAC	SFAHH	
✓									✓	✓		

HONDA

Mio 50	05-20	F
RS 125/250	88-07	R
Tonik 50 (4T)	11-15	F
NSF 250 R	12-20	R
Mio 100	05-15	F
MORIWAKI/HONDA		
E W00 Electric	11	F
MD 250 H/S	08-13	R
Tonik 110 (4T)	11-13	F
GO CCIA (ELECTRIC SCOOTER)		
Tonik 125 (4T)	11-14	F
Sunday	12-15	F
E-Virid (Electric) Deluxe	12-15	F
SYM		
E-Symmetry	12-13	F
Cinderella 50/100	99-00	F
HONLEY		
DD 50 (2T)	02-12	F
Oliver 125	15-16	

FA152 62 x 41 x 9mm

FA152/2 62 x 41 x 11mm

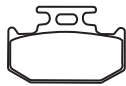

MATERIAL AVAILABILITY - FA152											
FA	TT	V	R	HH	MXS	SXR	EPFA	GPFAX	SFA	SFAC	SFAHH
	✓		✓		✓						

MATERIAL AVAILABILITY - FA152/2											
FA	TT	V	R	HH	MXS	SXR	EPFA	GPFAX	SFA	SFAC	SFAHH
	✓		✓		✓						

FA152 - CANNONDALE

MX 400						00	R	GT 125 Hammerhead			12-18	R
KAWASAKI								YZF-R 125 Inc Monster Energy Edition	19-21			R
KX 125 G1/H1/H2/J1/J2/K1						89-94	R	YZ 125 A/B			90-91	R
KDX 125 A1/A2/B1/B2						90-94	R	TT 250 RL/RM/RN/RR/RS			99-04	R
KDX 200 E1-E6						89-94	R	XG 250 Tricker (5XT1)			04-06	R
KDX 200 H1-H5						95-99	R	XT 250 X (3C51/2)			05-08	R
KDX 200 SR (DX 200 G)								XTZ 250 Lander (Brasil) (4B41/2)			07-08	R
KDX 220 R A4-A12/A6F						97-06	R	YZ 250 A/W/A/B			90-91	R
KDX 220 SR (DX 220 B)								WR 200 D/E/F			92-94	R
KDX 250 SR (KDX 250 F1)						91	R	WR 250 ZB/ZD/ZE/ZF/ZG/ZH/ZJ			91-97	R
KX 250 G1/H1/H2/J1/J2/K1						89-94	R	YZ 400 FK			98	R
KDX 250 D1						91-93	R	WR 500 ZD			92	R
KLX 250 R D1/D2/G1						93-97	R	TT 600 RES			04	R
KLX 250 F1-F4						94-97	R	TT 600 K (4LW1/4GV1/4LW2)				
KX 500 E1-E7						89-95	R	Up to 4GV 003403 (Nissin rear caliper)	93-95			R
KLX 650 C1-C3						93-97	R					

SUZUKI

TS 125 RK/RL/RM/RN/RR						90-96	R	RM 125 N/P/R/S			92-95	R
RM 125/250 K/L/M						89-91	R	DR-Z 250 K1-K7 (DJ43A)			01-07	R
TS 200 RK/RL/RM/RN/RR						89-94	R	RM 250 N/P/R/S			92-95	R
DR 250 RS/RLS/RT/RV/RLV/RLW/RW/RY (SJ45A/DOHC)						95-00	R	RMX 250 R/S			94-95	R
DR 250 RXT/RXLT/RXV/RXLV/RXW/RXLW/RXGW/RXGLW/RXY/RXGY (Dejbel 250 XC/GPS Ver (SJ45A))								RMX 250 SN/SR/SS (SJ13A)			95-97	R
DR 250 SL/SM/SN/SEP/SER/SES (SJ44A)						90-95	R	YAMAHA				
RMX 250 K/M/N/P						89-93	R	YZ 125 D/E/F/G/H/J			92-97	R
RMX 250 T/V/W						96-98	R	DT 200 WR (3XP)			92-93	R
DR 350 SL/SM/SN/SP								XT 225 WE (4JG5/6) Serrow			97-98	R
4 bolt front disc/kick start						90-93	R	DT 230 (4TP1/2) Lanza			97-96	R
DR 350 SER/SES								TT 250 R (4GY) Raid/4MR2			96	R
(Electric start/4 bolt front disc)						94-95	R	TT 250 R (4GY1 Japan)			93-94	R
DR 350 SET/SEV								TT 250 R (4RR1/2) Japan)			95-97	R
(Electric start/4 bolt front disc)						96-97	R	TT 250 RL (4PX5)			99	R
DR 350 SEW/SEX								TT 250 RM (4PX6)			00	R
(Electric start/6 bolt front disc)						98-99	R	TT 250 R (4GY3/4GY5/4WA1) Raid			94-96	R
DR 650 SE						96-21	R	YZ 250 D/E/F/G/H/J			92-97	R

YAMAHA

DT 125 RE						05-07	R	WR 400 FK			98	R
DT 125 X						05-06	R	WR 400 FK			98	R
								TT 600 E (4GV2)			94-95	R

FA153 75 x 40 x 8mm



MATERIAL AVAILABILITY											
FA	TT	V	R	HH	MXS	SXR	EPFA	GPFAX	SFA	SFAC	SFAHH
✓											

HONDA								RTL 250 S			88-89	R
AX-1 (NX 250 J/K/R/R3)						89-94	R	XLR 250 R (MD22)			88-90	R
CRM 250 R (RK) MK1 MD24								XLR 250 Baja MK2 (MD22)				R
(100001-1008385)						89-90	R	TLM 260			89-93	R

**FA155 A 37 x 7.8mm
B 39 x 23mm**



MATERIAL AVAILABILITY											
FA	TT	V	R	HH	MXS	SXR	EPFA	GPFAX	SFA	SFAC	SFAHH
✓			✓								

YAMAHA								YFS 200 B/F/G/H/J/K/L/M/N/P "Blaster"	91-02			R
---------------	--	--	--	--	--	--	--	---------------------------------------	-------	--	--	---

FA156 56 x 45.5 x 6mm



MATERIAL AVAILABILITY											
FA	TT	V	R	HH	MXS	SXR	EPFA	GPFAX	SFA	SFAC	SFAHH
✓											

APRILIA								CAGIVA				
280 Climber						94-96	R	Blues 50			93-95	F
BETA								Super City 50/80			93-95	F
Synt/Gara						93-95	R	Prima 50			92-94	F
Techno						95	R					

DO NOT REFIT ANY SHIMS/INSULATORS TO EBC PADS FROM ORIGINAL PADS UNLESS INSTRUCTED ON NOTE ON PAD PACKAGING AND ON FA DRAWING ASSOCIATED WITH THAT PAD.

FA157 A 99.5 x 44 x 7.5mm
B 47.5 x 83.5 x 9.5mm

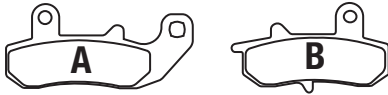

MATERIAL AVAILABILITY												
FA	TT	V	R	HH	MXS	SXR	EPFA	GPFA	SFA	SFAC	SFAHH	
✓			✓									

SUZUKI			DR 650 RUN/RN/RUP/RP (SP44A/B)	92-93	R
RG 125 FN/FP/FR (NF13A)			DR 650 RER/RES (SPA45A/B)	94-95	R
Gamma/Rear Disc Model	92-94	R	DR 650RSEM/RSEN/RSEP (SP43A/B)	91-93	R
RG 125 FUN/FUP/FUR (NF13B)			DR 750 SK	89	R
Gamma/Rear Disc Model	92-94	R	DR 800 SL	90	R
RG 125 UN "Wolf" (ND13E) Naked	92-94	R	YAMAHA		
DR 600 RK (SN41A) (Rear disc model)	89	R	DTZ 125 Tenere/Tenere	89-90	R
DR 650 RL/RM (SP41A)	90-91	R	DT 125 Chesterfield Scout	89-90	R
DR 650 RSL/RSM (SP42A)	90-91	R			

FA158 46.5 x 70 x 8mm



MATERIAL AVAILABILITY												
FA	TT	V	R	HH	MXS	SXR	EPFA	GPFA	SFA	SFAC	SFAHH	
✓				✓			✓					

KAWASAKI			GSX 400 SSN (GK77A) Katana	92	F
KRIS (KR 250 C2/C3)	90-92	F	GSR 600 K6/K7/K8	06-10	F
ZR 400 Zephyr (G2/G3/G3A/G4/G5)	97-01	F	GSXR 600 V/W/X/Y/K1/K2/K3/ZK3	97-03	F
ZXR 400 H1/H2	89-90	F	GSF 650 AK7/AK8/AK9/ALS/AL1/AL2		
ZXR 400 J1/J2	89-90	F	Naked Bandit - ABS	07-11	F
ZXR 400 R (ZX 400 M1-M4)	91-94	F	GSF 650 SAK7/SAK8/SAK9/SALO		
ZZR 400 (ZX 400 K1/K2/K3)	90-92	F	/SAL1/SAL2 Faired Bandit - ABS	07-15	F
ZZR 400 (ZX 400 N1-N7)	93-99	F	GSF 650 K7/K8/K9/L0/L1/L2		
ZZR 600 (ZX 600 D1-D3/E1-E13)	90-05	F	(Naked Bandit/Non ABS)	07-11	F
ZZR 600 (ZX 600 E6F)	06-07	F	GSX 650 FK8/FK9/FL0/FL1/FL2	08-14	F
ZX6 R (ZX 600 F1/F2/F3)	95-97	F	GSX 650 SK7/SK8/SK9		
ZXR 750 H1/H2/J1/J2/K1/K2/L1-L3/M1/M2	89-95	F	(Faired Bandit/Non ABS)	07-09	F
GPz 900 R A7/A8	90-96	F	GSX 650 FAK8/FAK9/FALO/FAL1/FAL2		
GPZ 900 R (ZX 900 A11)	98	F	(ABS Model)	08-15	F
ZX9 R (ZX 900 B1/B2)	94-95	F	SV 650 ABS	19-21	F
KLZ 1000 ACF/ADF/AEF/BFF/BGF			SV 650 X ABS	18-21	F
/BHF/BJF/BJFA Versys	12-18	F	GSXR 750 Y/K1/K2/K3	00-02	F
KLZ 1000 Versys SE LT (BJF - ABS)	18-20	F	SV 1000 K3/K4/K5/K6/K7	03-07	F
ZZR 1100 (ZX 1100 C1-C3) (D1-D9)	90-01	F	SV 1000 SK3-SK7 (Faired model)	03-07	F
ZR 1100 A1-A4 'Zephyr'	92-95	F	TL 1000 SV/SW/SX/SY/SK1	97-01	F
ZZR 1200 C1H/C2H	02-04	F	GSF 1200 SK6/SAK6 ABS & Non ABS Faired Bandit 4 Piston Caliper	06	F
VN 1700 B9F/BAF/BBF/BCF/BCF/BEF			GSF 1200 SK7/SK8/SK9/SLO		
/BFF/BGF/BHF/BJF Voyager ABS	09-20	F	Faired Bandit Non ABS 4 Piston Caliper	07-10	F
VN 1700 KBF/KCF/KDF/KEF			GSF 1250 K6/AK6 ABS & Non ABS Naked Bandit 4 Piston Caliper	06	F
Voyager Custom	11-14	F	GSF 1250 K7/K8/K9/OLO		
VN 1700 DAF/DBF/DCF/DDF/DEF			Non ABS Naked Bandit 4 Piston Caliper	07-11	F
Classic Tourer ABS	10-14	F	GSF 1250 AK7/AK8 ABS Model		
VN 1700 DFF/DGF Vulcan 1700 Nomad	15-16	R	Naked Bandit 4 Piston Caliper	07-08	F
VN 1700 FAF/FBF/FCF/DFD/FEF Classic ABS	10-14	F	GSF 1250 SAK7-SAK9/SAZK9/SALO		
VN 2000 A1/A2/A6F	04-08	F	/SAL1-SAL6 (Faired Bandit - ABS Model - 4 Piston Caliper)	07-16	F
VN 2000 H8F/H9F Classic	08-09	F	GSX 1250 FALO/FAL1-FAL6	10-16	F
			GSX 1250 FAL0ST/FAL1ST Sports Touring	10-14	F
SUZUKI			BEHRINGER		
RG 125 FN/FP/FR (NF13A)			4 Piston (Old Design)		
Gamma/Rear disc	92-94	F	MOTOMASTER		
RG 125 FUN/FUP/FUR (NF13B)			4 Piston		
Gamma/Rear disc	92-94	F	PRE TECH		
GSXR 250 RK (GJ73A)			4 Piston (P402) Lockheed Replacement Caliper		
RGV 250 J/K/L/M/N/P/R/S	88-95	F	PRO ONE		
TV 250 J/K/AK/L (VJ21A) Wolf	88-90	F	4 Piston		
SG 350 N 'Goose'	92	F	VERTEMATI		
GSF 400 K/NK/Z/VM/VZM/P/NP/VP			4 Piston Caliper	99-04	F
/VZP/VR (GK75A) "Bandit"	89-94	F			
GSF 400 S/VS/V-V/VZ-V Bandit (GK7AA)	95-97	F			
GSXR 400 J/RR/RAK (GK73A)	88-90	F			
GSXR 400 K6/K7/K8	06-08	F			

FA159 97 x 40 x 8mm



MATERIAL AVAILABILITY												
FA	TT	V	R	HH	MXS	SXR	EPFA	GPFA	SFA	SFAC	SFAHH	
	✓		✓			✓						

AEON			POLARIS		
Crosslander 600i	14-15	R	Crosslander 600i	14-15	R

FA160 75 x 54 x 10mm

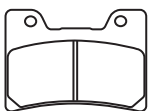

MATERIAL AVAILABILITY												
FA	TT	V	R	HH	MXS	SXR	EPFA	GPFA	SFA	SFAC	SFAHH	
✓				✓								

MZ			TDM 850	96-01	F
850 KBT			FZR 1000 EX UP (Std Forks)	89-90	F
YAMAHA			V-MAX 12	93-03	F
FZR 600	90-93	F	FJ 1200 A (ABS Model)	91-95	F
FZR 600 R	94-95	F			

FA161 52.5 x 52.5 x 8mm

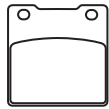

MATERIAL AVAILABILITY												
FA	TT	V	R	HH	MXS	SXR	EPFA	GPFA	SFA	SFAC	SFAHH	
✓		✓		✓								

KAWASAKI											
Z 250 A1/A2/A3				78-81	R	ZX-7R (ZX 750 P1-P7)				96-03	R
ZXR 400 (L1-L9)				91-03	R	ZXR 1100 D1-D9				93-01	R
ZXR 400 H1/H2				89-90	R	ZRX 1100 (ZR 1100 C1/C2/C3/C4)				97-00	R
ZXR 400 J1/J2				89-90	R	ZX12R (ZX 1200 A1/A2/B1/B2)				00-03	R
ZXR 400 R (ZX 400 M1-M4)				91-94	R	ZRX 1200 R(A1/A2/A3/A4/A5/A6F)				01-08	R
ZXR 750 H1/H2/J1/J2/K1/K2/L1-L3						ZRX 1200 S (B1-B3)				01-04	R
/M1/M2				89-95	R	ZZR 1200 C1H/C2H				02-04	R
						ZX 12R (ZX 1200 B3/B4/B6F)				04-06	R

FA162 48 x 48.5 x 7mm



MATERIAL AVAILABILITY												
FA	TT	V	R	HH	MXS	SXR	EPFA	GPFA	SFA	SFAC	SFAHH	
✓												

YAMAHA											
TZ 125				94-97	R	TZ 250 (Radial Caliper)				02-10	R
TZ 250				89-01	R						

FA163 99.5 x 52 x 8mm

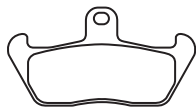

MATERIAL AVAILABILITY												
FA	TT	V	R	HH	MXS	SXR	EPFA	GPFA	SFA	SFAC	SFAHH	
✓												

GAGIVA											
Mito 125				91-92	F	Tuareg Rally 215				89	F
W8 125				93-98	F	Tuareg Wind 600				89	F
Elefant 125				88-90	F	GILERA					
Freccia 125 SY				89	F	Nord-West 350				94-	F
Supercity 125				92-	F	MOTO GUZZI					
Tamanaco 125				88-89	F	1000 Quota				92-97	R
W12 "350"				93-95	F						
W16 "600"				94-98	F						
750 Elefant				90-92	R						

FA164 74 x 40.5 x 6.5mm



MATERIAL AVAILABILITY												
FA	TT	V	R	HH	MXS	SXR	EPFA	GPFA	SFA	SFAC	SFAHH	
✓			✓									

BETA											
Trial Evo 125 (2T) MY20				20	F	TR34 260				89-91	R
Trial Evo 200 (2T) MY20				20	F	Synt				92	R
Trial Evo 250 (2T) MY20 Inc GB				20	F	Zero				92	R
Trial Evo 300 (2T) MY20 Inc GB and SS				20	F	Supertrial ST				94	R

FA165 A 96.5 x 42 x 7.5mm B 77.5 x 42 x 7.5mm



MATERIAL AVAILABILITY - FA165												
FA	TT	V	R	HH	MXS	SXR	EPFA	GPFA	SFA	SFAC	SFAHH	
✓	✓		✓	✓	✓							

FA165/2 A 96.5 x 42 x 9.5mm B 77.5 x 42 x 8mm

MATERIAL AVAILABILITY - FA165/2												
FA	TT	V	R	HH	MXS	SXR	EPFA	GPFA	SFA	SFAC	SFAHH	
	✓		✓									

FA165 - AEON

Cobra RS 180 (Quad)	06	R	Maverick 1000 R XRS							13-14	F (Left)
Overland 125 (AT08) (Quad)	02-06	R	Maverick 1000 R XRS/DPS							14	F (Left)
Overland 180 (AT08) (Quad)	02-11	R	Maverick 1000 R XMR							14	F (Left)
Crossland RX 350	11	R	Maverick 1000 R XXC							18-21	F (Left)
APACHE			Ryker 600 Ace							18-21	F (Left)
RLX 150 S		R	Ryker 900 Ace							18-21	F (Left)
BLANEY (Quads)			CF MOTO								
XL 200 Trooper	03-04	R	CF 500-5 (Rancher UTV)							11-14	F (Left)
CAN AM (SIDE X SIDE)			CF 500 US - Z Force 550 (Side x Side)							15	F(Right)
Commander 800 R (STD)	11-15	F (Left)	CF 600 Z Force Z6 EX (Side x Side)							13-15	F (Left)
Commander 800 R XT	11-14	F (Left)	CF 625-3 (Z6 Terra Cross)							11-12	F(left)&R(left)
Commander 800 (XT/DPS)	11-15	F (Left)	CF 800 UU-A - U Force 800 (Side x Side)							13-16	F(Right)
Commander 1000 (STD)	11-15	F (Left)	CF 800 Z Force Z8 (Side x Side)							13-15	F (Left)
Commander 1000 LTD	12-15	F (Left)	CF 800 Z Force Z8 EX (Side x Side)							14-15	F (Left)
Commander 1000 X	11-13	F (Left)	CF 800-3 (Tracker 800 Side x Side)							13	F (Left)
Commander 1000 XT	11-15	F (Left)	U Force 800 (Side x Side)							14-16	F (Left)
Commander 1000 XT-P	14-15	F (Left)	CPI								
Commander 1000 (DPS)	13-15	F (Left)	XT 50 Quad							06-09	R
Maverick 1000 R STD	13-14	F (Left)									

FA165 A 96.5 x 42 x 7.5mm B 77.5 x 42 x 7.5mm

FA165/2 A 96.5 x 42 x 9.5mm B 77.5 x 42 x 8mm

E-TON QUADS

RXL 150 Viper R	05
CXL 150 Yukon II/Challenger	02-
EXL 150 Eukon St	05-07
RXL 150 Viper	05-06

GOES

G 520 UTX (Side x Side)	10-11
-------------------------	-------

JONWAY

YY 125	08-09
YY 150	08-09
YY 250/250 A	08-09

KAWASAKI

Kazer 115	
KLF 300 C1-C17 "Bayou"	89-05
KLF 400 B1-B7 Bayou	93-99
KVF 650 F7F/F8F Brute Force 4x4i Hardwoods Green	07-08
KVF 650 FCF/FCS/FDF	12-13
KVF 650 H7F/H8F Brute Force 4x4i	07-08
KVF 650 G7F/G8F Brute Force 4x4i Hardwoods Green	07-08
KVF 750 A1/A6F/B1/B6F Brute Force 4x4	05-06
KVF 750 E8FA Brute Force 4x4 Hardwoods Green HD	08
KVF 750 D8F/D9F/DAF/DBF	08-11
KVF 750 GCF/GDF/GEF/GFF/GGF/GHF	
Brute Force 4X4i EPS	12-17
KVF 750 HCF/HDF/HEF/HFF/HGF/HHF	
Brute Force 4X4i EPS/Camo	12-17
KVF 750 JCF/JDF/JEF/JFF/JGF/JHF Brute Force 4x4i EPS	12-17
KVF 750 LCF/LDF/LEF/LFF/LGF/LHF Brute Force 4x4i	12-17
KRF 750 A8F/B8F Teryx 750 4x4 (RUV)	08
KRF 750 C8F/D8F Teryx 750 4x4 LE (RUV)	08
KRF 750 F8F Teryx 750 4x4 NRA Outdoors (RUV)	08
KRF 750 TAF Teryx 750 Fi 4x4 SGE	10-11
KRF 750 G9F/NAF/NBF/NCS/NDF Teryx 750 Fi 4x4	09-13
KRF 750 J9FA/K9F/PAF/RAF/PBF/RBF/RCS/PDF/RDF Teryx 750 Fi 4x4 LE	09-13
KRF 750 L9F Teryx 750 Fi 4x4 LE Sport	09
KRF 750 M9F Teryx 750 Fi 4x4 NRA Outdoors	09
KRF 750 SAF/SAFA/SBF/SBFA/SCS/SCSA/SDF Teryx 750 Fi 4x4 Sport LE	10-13
KRT 750 ACF/ADF (Teryx 4 750 4X4)	12-13
KRT 750 ACFA/ADFA (Teryx 4 750 4X4 EPS)	12-13
KRT 750 CCF/CDF (Teryx 4 750 4X4 EPS LE)	12-13
KRF 800 BEF/BFF/FGF/FHF/FJF (Teryx)	14-18
KRF 800 CEF/CFF/GGF/GHF/GJF (Teryx LE)	14-18
KRF 800 DEF/DFE/HGF/HFF/HJF (Teryx Camo)	14-18
KRT 800 BEF/BFF/FGF/FHF/FJF (Teryx 4)	14-18
KRT 800 CEF/CFF/GGF/GHF/GJF (Teryx 4 LE)	14-18
KRT 800 DEF/DFE/HGF/HFF/HJF (Teryx 4 Camo)	14-18
KAF 820 AFF/AGF/AHF/AJF Mule Pro FXT	15-18
KAF 820 BFF/BGF/BHF/BJF Mule Pro FXT/EPG	15-18
KAF 820 CFF/CGF/CHF/CJF Mule Pro FXT/EPG LE	15-18
KAF 820 DFF/DGF/DHF/DJF Mule Pro FXT/EPG Camo	15-18
KAF 820 EGF/EHF/EJF Mule Pro FX	16-18
KAF 820 FGF/FHF/FJF Mule Pro FX/EPG	16-18
KAF 820 GGF/GHF/GJF Mule Pro FX/EPG LE	16-18
KAF 820 HGF/HHF Mule PRO - FX/EPG Camo	16-17
KAF 820 JGF/JHF Mule PRO - FXT Ranch Edition	16-17
KAF 1000 AGF/AHF/AJF Mule Pro DXT/Diesel	16-18
KAF 1000 BGF/BHF/BJF Mule Pro DXT/Diesel EPS	16-18
KAF 1000 CGF/CHF - Mule Pro DXT EPS LE/Diesel	16-17
KAF 1000 DGF/DHF - Mule Pro DX /Diesel	16-17

KAF 1000 EGF/EHF/EJF Mule Pro DX EPS/Diesel	16-18	F(left)
KAF 1000 FGF/FHF - Mule Pro DX EPS LE/Diesel	16-17	F(left)
KAF 1000 DGF Mule Pro DX Diesel	16	F(left)
KAF 1000 BGF Mule Pro DXT Diesel	16	F(left)
LEXMOTO		
Milano 125 EFI (FT125T-27-E4)	16-20	R
MBK		
TZR 50 'X-Blazer'	00	F
MOTO-ROMA		
Go-Go 110	02	F
Geko 300 Quad	04-06	R
QUADZILLA		
4 Cross 200cc		R
Z8 4X4 (Side X Side/800cc)	14-15	F (Right)
SINNIS		
QM 250 GY-D Apache 250	13-14	R
SUZUKI		
LT-F 300 FK2	02	R(left)
LT-R 450 K6/K7/K8/K9/L0/L1	06-12	F(left)
LTA 500 FY/FK1	00-01	F(left)
LT-F 500 FW/FX/FY/FK1/FK2	98-02	F(left)
TAISHAN		
Panther 90 Quad	04	R
Hurricane 125 Quad	04	R
Explorer 150 Quad	04	R
Tornado 200 Quad	04	R
YAMAHA		
YZF 450 S/T/V/W/X	04-08	F(left)
YZF 450 RY/RZ (Quad)	09-10	F(left)
YZF 450 R	11-14	F(left)
YZF 450 RSEA/RSEB/RSED/RSE	11-14	F(left)
YXR 66 FAS/FAT Rhino 4x4 Side x Side	04-05	F(left)
YFM 700 RV/RW/RX/RY/RA/RB Raptor	06-12	F(left)
YFM 700 RD Raptor	13	F(left)
YFM 700 RSE	13-18	F(left)
YXR 700 Rhino 4x4 SE	09	F(left)
YXR 700 FA/FB/FD Rhino Side x Side	11-13	F&R(left)
XTZ 750 "Super Tenere"	89-95	F&R(left)

FA165/2 BOMBARDIER

Rally 200	05-06	R
CAGIVA		
Canyon 600 E	96-99	R
Canyon 500	96-00	R
900 IE Canyon/Gran Canyon	97-00	R
E 900 Elephant Dakar Rep (300mm front disc)	90	R
E 900 ie Lucky Explorer (296mm front disc)	90	R
E 900 ie GT (296mm front disc)	91-92	R
Navigator 1000	00-05	R
HYOSUNG		
XR 125 Supermoto	07-11	R
MZ/MUZ		
VRT 125 Quad	05	R
VRT 175 Quad	05	R
SUZUKI		
DR 800 SM/SN/SP/SR/SS (SR43B)	91-95	R
DR 800 ST/SV (SR43B)	96-97	R
YAMAHA		
XTZ 750 "Super Tenere"	89-95	R
VOXAN		
Scrambler 1000	02-06	R

FA166 100 x 47 x 7.5mm



MATERIAL AVAILABILITY											
FA	TT	V	R	HH	MXS	SXR	EPFA	GPFA	SFA	SFAC	SFAHH
✓											

HONDA HM (ITALY)

CRE 50 Six/Baja/Derapage Grimeca	
caliper twin pin Kayaba forks	95-02

YAMAHA

DT-Z 125 'Tenere/Tenere Scout'	89-90	F
DT 125 Chesterfield Scout	89-90	F

BRAKE PAD BUYERS GUIDE

DO NOT REFIT ANY SHIMS/INSULATORS TO EBC PADS FROM ORIGINAL PADS UNLESS INSTRUCTED ON NOTE ON PAD PACKAGING AND ON FA DRAWING ASSOCIATED WITH THAT PAD.

FA171 57.5 x 53.5 x 9mm

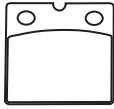

MATERIAL AVAILABILITY												
FA	TT	V	R	HH	MXS	SXR	EPFA	GPFA	SFA	SFAC	SFAHH	
✓		✓		✓								

BMW

K 75/75-2				09/88-96	F	K 100 LT				09/88-91	F
K 75/75-S				08/90-96	F	K 100 RS				10/88-89	F
K 75 C				09/88-90	F	K 100 RT				10/88-89	F
K 75 RT				89-96	F	R 80/R 80 RT				09/88-95	F
K 75 RT				89-96	F	R 100 RS				9/9-92	F
K 75 S				09/88-95	F	R 100 RT				09/88-95	F
K 75 S				09/88-95	F	QUADZILLA					
K 100/2				09/88-90	F	RL 500 Buggie				08-09	F&R

**FA172 A 104 x 46 x 10mm
B 88 x 46 x 10mm**

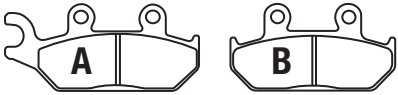

MATERIAL AVAILABILITY												
FA	TT	V	R	HH	MXS	SXR	EPFA	GPFA	SFA	SFAC	SFAHH	
	✓		✓									

YAMAHA

XT 600 E				92-03	F						
XTZ 660 "Tenere"				91-98	F						

**FA173 A 82 x 42.5 x 7.5mm
B 56 x 35 x 9.5mm**



MATERIAL AVAILABILITY												
FA	TT	V	R	HH	MXS	SXR	EPFA	GPFA	SFA	SFAC	SFAHH	
✓									✓			

APRILIA											
ETX 125				99-01	R	X-Limit 50				02	R
Moto 6.5				95-01	R	MZ/MUZ					
Pegaso 650				91-00	R	Baghira - Forest/Forest HR					
BETA						21" front wheel/spoke wheel				96-05	R
Jonathan 125				02-05	R	Baghira - Street Moto					
CAGIVA						17" front wheel/spoke wheel				96-05	R
W12 "350"				93-95	R	Baghira - 21" front wheel/spoke wheel				99-05	R
W16 "600"				94-98	R	Baghira - Black Panther -					
GILERA						17" front wheel/spoke wheel				96-03	R
Eagle 50				96	R	Mastiff - 21" front wheel/spoke wheel				96-05	R
50 RC Top Rally				90-	F&R	YAMAHA					
MALAGUTI						TDR 125 (3HS1/3XD0/3SH3/3XD01)				89-93	R
F10 Jetline				91-93	F						
50 America				91-	F						

FA174 86.5 x 41.5 x 10mm

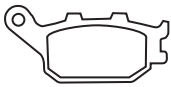

MATERIAL AVAILABILITY												
FA	TT	V	R	HH	MXS	SXR	EPFA	GPFA	SFA	SFAC	SFAHH	
✓		✓		✓								

HONDA											
CB 400 SF4/5/S5 (NC39)	04-05	R	CB 750 F2N/F2R/F2S/F2T/F2V/F2W/ F2X/F2Y/F21 CB Seven Fifty	92-02	R	VTR 1000 SP2/SP3/SP4/SP5/SP6				02-07	R
VRX 400 T (NC33)	96	R	750 Integra Scooter - DCT (NC 750 D)	14-16	R	CB 1100 AD				13	R
CB 500 A4/A5/A6/A7	04-07	R	CBR 900 RRN/RRP/RRR/RRS/RRT/RRV			CB 1100 AE (Cast Wheels/2 Piston Caliper)				13	R
CBF 500 4 (Non ABS Model)	04-	R	/RRW/RRX/RRY/RR1-RR3 Fireblade	92-03	R	CB 1100 EX (SAE)				14-21	R
CB 600 FW/FX/ "Hornet"	98-00	R	CB 900 F2-F7 Hornet	02-07	R	CB 1100 RS				17-21	R
CB 600 FY/F2Y/F1-F6/F21/F22		R	CB 1000 FP/FR/FS/FT/FV	93-97	R	VT 1100 C2 (W/X/Y/1/2/3/4/5)				98-05	R
/FA7-FA9/FAA/FAB Hornet	00-12	R	CBF 1000 6/7/8/9/A (Non ABS Model)	06-10	R	VT 1100 C2 (S/T/V)				95-97	R
CBF 600 N8/N9 (Non ABS)	08-09	R	CBF 1000 F (FA) (2 piston front calipers/non ABS)	10-15	R	VT 1100 C3 (W/X/Y)				98-00	R
CBF 600 S4-S6/S8/S9 (Non ABS)	04-06/08-09	R	CBF 1000 FA FAA (3 Piston Front Caliper/ABS Model)	10-15	R	CB 1300 F3/F13				03-04	R
CBF 600 SA4-SA6/SA8/SA9 /SAA (ABS)	04-06/08-12	R	CBF 1000 FS FSA (3 Piston Front Caliper/ABS Model)	10-11	R	CB 1300 5/6/7/8/9 (Superfour)				05-09	R
CBF 600 NA8/NA9 (ABS)	08-09	R	CBF 1000 FT FTA (3 Piston Front Caliper/ABS Model)	10-11	R	CB 1300 A5-A9 (Superfour ABS)				05-09	R
CBF 600 N4/N5/N6 (Non ABS)	04-06	R	CBF 1000 6/7/8/9/A (2 piston front caliper/Non ABS)	06-11	R	CB 1300 SA5-SA9/SAA				05-12	R
CBF 600 NA4/NA5/NA6 (ABS)	04-06	R	CBR 1000 RR4/RR5 Fireblade	04-05	R	CB 1300 S5/S6/S7/S8/S9				05-09	R
CBR 600 FM/FN/FP/FR/FS/FT /FV/FW/FX/FY	91-00	R	CRF 1000 LAG/LAH (Manual Clutch/ABS)	16-17	R	VT 1300 CXA Chopper (9 spoke cast wheel/non ABS)				10-12	R
CBR 600 F1/F2/2CBR 600 FS1/FS2 'Sport'	01-02	R	CRF 1000 LAG/LAH (DCT/ABS)	16-17	R	VT 1300 CXAA "Chopper" (9 spoke cast wheel/ABS model)				10-11	R
CBR 600 F3/F4/F5/F6	03-06	R	CRF 1000 LAJ (DCT/ABS) Africa Twin (inc Adventure Sport)	18-19	R	VTX 1300 S3/S4/S5/S6/S7/S8				03-08	R
CBR 600 RR3/RR4/RR5/RR6	03-06	R	CRF 1100 Africa Twin Adventure	19-21	R	KAWASAKI					
CBR 600 FAB/FAC (ABS Model)	11-13	R	Sport ES ABS Manual	19-21	R	ZX-25 Ninja				20-21	R
700 Integra Scooter NC 700 DC	12-14	R	CRF 1100 Africa Twin Adventure	19-21	R	EN650 AFF/AGF/AGFA/CHF Vulcan S - Non ABS				15-21	R
NC 700 XA (ABS)	12-13	R	Sport ES ABS DCT	19-21	R	EN650 BFF/BGF/BGFA/BGFB/DHF /DHFA/EHF/DJF/DJFA/EJF Vulcan S					
NC 700 XD (ABS/DCT)	12-13	R	VTR 1000 FV/FW/FX/FY/F1-F6 'Firestorm'	97-06	R	- ABS				15-21	R
NC 700 SA (ABS)	12-13	R	VT-R 1000 SPY/SP1 (SC45)	00-01	R	EN 650 Vulcan S Café ABS				18-20	R
NC 700 SD (ABS/DCT)	12-14	R				EN 650 Vulcan S SE ABS				18-20	R
XL 700 VA8/VA9/VA4 (Transalp/3 piston front caliper/ABS front & rear wheels)	08-11	R				Ninja 650 (EX 650 KHf/KHFA					
						/KJF/KJFA - ABS)				17-21	R

FA174 86.5 x 41.5 x 10mm

Ninja 650 (EX 650 JHF/JJF Non ABS)	17-20	R	GSX-S 750 AL7-AL9/AZL7-ALZ9	17-21	R	FZ6 Fazer S2 (ABS/Half Fairing /4 Piston Caliper) (5S2)	08	R
KLE 650 Versys (Non ABS) KLE650 EGF	16	R	DL 900 Migrator	14-19	R	FZ6 Fazer S2 (Non ABS/Half Fairing /4 Piston Caliper) (4S81/4S8)	07-09	R
KLE 650 Versys (ABS) KLE 650 F6F /FHF/FHFA/FJF/FJFA	16-21	R	GSX-S 950	21	R	FZ6 S2 (Naked/Non ABS)		
Z 650 (ER650 GHF / Non ABS)	17-20	R	DL 1000 K2-K9/L0 V-Strom	02-10	R	(4 Piston Caliper) (5S51/5S5)	07-09	R
Z 650 (ER650 HHF/HJF / ABS)	17-21	R	SV 1000 K3/K4/K5/K6/K7	03-07	R	MT-07 Non ABS (689cc/2 Cyl)	14-16	R
Z 750 (ZR 750 L7F-L9F/LAF/LBF)	07-11	R	SV 1000 SK3-SK7 Faired Model	03-07	R	MT-07A ABS (689cc/2 Cyl)	14-21	R
Z 750 ABS (ZR 750 M7F/M8F/M9F /MAF/MBF)	07-11	R	GSX-S 1000 L6-L9 (Naked/Non ABS)	16-20	R	MT-07 Moto Cage ABS (689cc/2 Cyl)	15-17	R
KLX 1000 (LV 1000 A1H/A2H)	04-05	R	GSX-S 1000 AL6-AL9 (Naked/ABS)	16-21	R	MT-07A Moto Cage (Non ABS)	14-16	R
KLZ 1000 ACF/ADF/AEF/BFF/BGF /BHF/BJF/BJFA Versys	12-18	R	GSX-S 1000 FL6-FL9 (Faired/Non ABS)	16-20	R	Tracer 700 (MTT 690)	16-21	R
KLZ 1000 Versys SE LT (BJF - ABS)	19-21	R	GSX-S 1000 FAL6-FAL9 (Faired/ABS)	16-21	R	XSR 700 ABS (MTM 690-U)	16-21	R
KLZ 1000 Versys SE LT+ ABS Inc DKF	19-21	R	GSX 1000 Katana	18-21	R	YZF-R7	22	R
KLZ 1000 Versys S Tourer and Grand Tourer ABS	20-21	R	GSF 1250 SK6/SAK6 ABS & Non ABS		R	FZ8 N-Naked/Single Headlight /Non ABS (800cc) (RN255/39P1)	11-15	R
Z 1000 (ZR 1000 B7F/B8F/B9F)	07-09	R	Faired Bandit 4 Piston Caliper	06	R	FZ8 NA-Naked/Single Headlight /ABS (800cc) (RN256/59P1)	11-15	R
Z 1000 ABS (ZR 1000 C7F-C9F)	07-09	R	Naked Bandit 4 Piston Caliper	06	R	Fazer 8 - FZ8-S (800cc) (Top fairing/ Twin headlight/Non ABS) (RN251/42P1)	11-15	R
SUZUKI			GSF 1250 K6/AK6 ABS & Non ABS		R	Fazer 8 - FZ8-SA (800cc) (Top fairing/ Twin headlight/ABS) (RN252/1BD1)	11-15	R
SV 400 K3/K4/K5	03-05	R	Naked Bandit 4 Piston Caliper	07-11	R	MT-09 (IRC) Non ABS (847cc/3 cyl)	14-16	R
SV 400 SK3/SK4/SK5	03-05	R	GSF 1250 SK7-SK9/SLO Faired Band Non ABS 4 Piston Caliper	07-10	R	MT-09A (ZDR) ABS (847cc/3 cyl)	14-16	R
DL 650 AK9 GT V-Strom Traveller ABS	09-11	R	GSF 1250 SAK7/-SAK9/SAZK9/?		R	MT-09 A Sport Tracker (ABS/847cc /3 cyl engine)	14-16	R
DL 650 K4/K5/K6 V-Strom	04-06	R	SALO/SAL1-SAL6 (Faired Bandit - ABS Model - 4 Piston Caliper)	07-16	R	MT-09 ABS (MT850-A 847cc /3 Cyl Engine)	17-21	R
DL 650 XK7-XK9/XL0 V-Strom X	07-11	R	GSF 1250 AK7/AK8 ABS Model		R	MT-09 SP ABS (MT850-D 847cc /3 Cyl Engine)	18-21	R
DL 650 AK7-AK9/XL0 V-Strom ABS	07-11	R	Naked Bandit 4 Piston Caliper	07-08	R	MT-09 Tracer 900 (ABS/847cc /3 Cyl engine)	15-21	R
DL 650 AL1 XP V-Strom Xpedition	11	R	GSX 1250 FALO/FAL1-FAL6	10-16	R	MT-09 Tracer 900 GT ABS (847cc /3 Cyl Engine)	18-21	R
DL 650 AL2-AL9 V-Strom ABS	12-21	R	GSX 1250 FAL0ST/FAL1ST Sports Tourer	10-14	R	MT-10 (MTN 1000/998cc)	16-19	R
DL 650 XT XAL5-XAL9 V-Strom ABS	15-21	R	YAMAHA			MT-10 Tourer Edition (998cc)	18-19	R
GSF 650 AK5/AK6 Naked Bandit ABS	05-06	R	XJ6-F Diversion 600 (Full Fairing Non & ABS Models)	13-15	R	MT-10 SP (MTN 1000D/998cc)	17-21	R
GSF 650 AK7/AK8/AK9/AK0		R	XJ6-S Diversion 600 (Top fairing model Non & ABS Models)	13-15	R	XSR 900 ABS (MTM 850)	16-18	R
/AL1/AL2 Naked Bandit ABS	07-12	R	XJ6-N Diversion Naked	13-15	R	XSR 900 Abarth ABS (MTM 850)	17-18	R
GSF 650 K7/K8/K9/L0/L1/L2		R	XJ6 SP	13	R	FZ1 N/NA Naked (Non ABS/ABS)	10-15	R
Naked Bandit/Non ABS	07-12	R	YZF-R6	03-07	R	FZ1 Fazer (Half Fairing - ABS - 5D0)	08-15	R
GSF 650 SAK5/SAK6 Faired Bandit ABS	05-06	R	YZF R6	08-16	R	FZ1 Fazer (Half Fairing/Non ABS)	06-15	R
GSF 650 SAK7/SAK8/SAK9/SALO		R	FZ6 Fazer	04-07	R	YZF-R1SP	06	R
/SAL1/SAL2 Faired Bandit ABS	07-15	R	FZ6 (Naked version)	04-07	R	YZF R1	04-06	R
GSX 650 FK8/FK9/FL0/FL1/FL2	08-12	R	FZ6 Naked/Non ABS		R	YZF R1 (6 piston radial caliper)	07-14	R
GSX 650 SK7/SK8/SK9		R	2 Piston Caliper (1B3/1B3D)	04-07	R			
Faired Bandit/Non ABS	07-09	R	FZ6-NS Naked/Non ABS/		R			
GSX 650 FAK8/FAK9/FALO/FAL1/ FAL2 (ABS Model)	08-15	R	2 Piston Caliper (1B35/6)	05-06	R			
SV 650 K3-K9/L0 Naked - Non ABS	03-10	R	FZ6 S2 ABS (Naked)	07-09	R			
SV 650 SK3-SK9/SLO Top Fairing Non ABS	03-15	R	FZ6 Fazer S2 (ABS) (4 piston caliper)	07-09	R			
SV 650 AK7-AK9/ALO Naked - ABS	07-10	R	FZ6 Fazer (Half Fairing/Non ABS)		R			
SV 650 SAK7/SAK8/SAK9/SALO	07-15	R	FZ6 Fazer (Half Fairing/Non ABS)	04-07	R			
GSR 750 L1/L2/L3/L4 Non ABS	11-14	R	/2 Piston Caliper) (4P5)	06-07	R			
GSR 750 AL2/AL4/AL5 ABS	11-15	R			R			

FA175 33.5 x 50.5 x 7mm



MATERIAL AVAILABILITY												
FA	TT	V	R	HH	MXS	SXR	EPFA	GPFA	SFA	SFAC	SFAHH	
✓				✓			✓					

HARRISON BILLET AFTERMARKET CALIPER

2 Piston (1296040)
Slim Design
Mini 6

ISR AFTERMARKET CALIPER

22-032 (6 Piston Large)
22-042 (6 Piston Racing)

SFA176 47.5 x 36 x 7.5mm



MATERIAL AVAILABILITY												
FA	TT	V	R	HH	MXS	SXR	EPFA	GPFA	SFA	SFAC	SFAHH	
✓									✓			

HONDA

NH 50 Lead 50 SS 84 F NH 80 Lead 80/SS 85 F
NH 50 Lead AF01/d716 84-85 F NH 125 Lead 125 86-87 F

FA177 87 x 53 x 7.5mm



MATERIAL AVAILABILITY												
FA	TT	V	R	HH	MXS	SXR	EPFA	GPFA	SFA	SFAC	SFAHH	
✓												

APRILIA

Pegaso 650 91-96 F Baghira - 21" front wheel/spoke wheel 99-05 F
Baghira - Black Panther - 17" front wheel/spoke wheel 96-03 F
Mastiff - 21" front wheel/spoke wheel 96-05 F
Baghira - Forest/Forest HR - 21" front wheel/spoke wheel 96-05 F
Baghira - Street Moto - 17" front wheel/spoke wheel 96-05 F

FA179 102 x 41 x 10mm

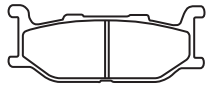

MATERIAL AVAILABILITY												
FA	TT	V	R	HH	MXS	SXR	EPFA	GPFA	SFA	SFAC	SFAHH	
✓		✓		✓					✓	✓	✓	

BRAND	MODEL	YEAR	TYPE	AVAILABILITY
CF MOTO				
	CF 250 T-5 V5 Custom	11-12	F	XJ 600 N 95-97 F
	250 NK	20	F	XJ 600 S "Diversion" 92-97 F
	250 SR	21	F	XVS 650 Drag Star 97-04 F
	300 NK	20	F	XVS 650 A Dragstar classic 98-07 F
	300 SR	21	F	XV 750 Virago 94-97 F
				XJ 900 S "Diversion" 95-03 F
KYMGCO				
	AK 550	17-20	R	SCR 950 (XVS 950XR-A) 17-18 F
				XV 950 Racer (Remote Reservoir Rear Shocks) 15-16 F
MOTOM				
	Transcity 125/250	08-09	F	XVS 950 A Midnight Star 09-13 F
SYM				
	SB 125 N (Carb) Wolf (Drum Rear)	11-15	F	XV 950 - XVS 950 (Non ABS) /Standard Rear Shocks) 14 F
YAMAHA				
	FZX 250 Zeal (3YX1/2/4)	91-92	F	XV 950 CU - XVS 950 ' (1XC1/ABS/Standard Rear Shocks) 14-15 F
	SRV 250 'Soulfultwin/Renaissa' (4DN1-6)	92-97	F	XV 950 R - XVS 950 R (2DE) /Remote Reservoir Rear Shocks) 14-18 F
	SR 400 (2RD)	14-17	F	XV 1100 Virago 94-98 F
	XP 400 Majesty	04	F	XVS 1300 CU Custom 14-17 F
	XVS 400	96	F	XVZ 1300 TF 'Venture Star' 99-01 F
	XP 500 N/P/R T-Max	01-03	F	XV 1600 A 'Wildstar' 99-04 F
	XV 535/535 S 'Virago'	95-03	F	

FA180 59 x 43.5 x 8mm

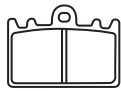

MATERIAL AVAILABILITY												
FA	TT	V	R	HH	MXS	SXR	EPFA	GPFA	SFA	SFAC	SFAHH	
✓				✓								

BRAND	MODEL	YEAR	TYPE	AVAILABILITY
PRE TECH AFTERMARKET CALIPER				
	4 Piston (Uni P401)			
KAWASAKI				
	ZXR 400 L1-L9	91-03	F	
SUZUKI				
	RGV 250 T (RGVR 250 SP VJ23A)			96 F

FA181 94 x 37.5 x 7.5mm



MATERIAL AVAILABILITY												
FA	TT	V	R	HH	MXS	SXR	EPFA	GPFA	SFA	SFAC	SFAHH	
	✓	✓	✓	✓	✓		✓		✓	✓	✓	

BRAND	MODEL	YEAR	TYPE	AVAILABILITY
ALFER				
	VR 250	98-13	F	R35/R 35 S 06-09 F
ALTA MOTORS				
	Redshift MX	16-18		FT 35 S (400cc) (DRZ 400 motor) 07-09 F
APRILIA				
	RX 125	00-01/08-12/18-21	F	R 45 07-09 F
	MX 125	04-06	F	404E 03-04 F
	SX 125	08-13	F	404 DS 03-04 F
	SRV 850	12-14	F	404 DS Supermoto 03-04/07-09 F
	RST 1000 Futura	01-04	R	404 DS Trail 07-09 F
BAJAJ				
	Pulsar 180 (UG4)	12-16	F	604E Supermotard/RS/Dual Sport 98-03 F
	Pulsar 150	07-16	F	644 DS Supermoto 04 F
	Pulsar 220 F/S	15-16	F	644 DS Supermoto 04 F
	Pulsar Adventure AS 150/200	15-16	F	644 DS Supermoto 04 F
	XCD 125 (Drum Brake)		F	FT 650 08 F
	Pulsar RS 200 (inc Lower Fairing)	15-16	F	FT 710 S Flat Tracker 08-09 F
	Pulsar 200 NS	14-16	F	620 Multistrada (Twin disc) 06 F
	Pulsar 135 LS	12-16	F	620 Multistrada (Single pin pad fixing) 06 F
	Discover 125 ST	13-15	F	695 Monster 07-08 F
	Discover 150 S (Disc Brake)	14-16	F	950 Multistrada (936cc) 17-18 R
	Discover 150 F (Disc Brake)	14-16	F	1200 Multistrada ABS (Single Pin F/Caliper) 15-17 R
	Discover 125 M	14-16	F	1200 Multistrada DVT 15-17 R
BENELLI				
	BX 250 Motard	12-13/16-18	F	1200 Multistrada Enduro 17-18 R
	BX Cross (449cc)	07-12	F	1200 Multistrada Enduro Pro 18 R
	BX Enduro (505cc)	08-12	F	1200 Multistrada Touring 15-17 R
BMW				
	GX 450 X	08-11	F	1200 Multistrada DVT 15-17 R
BREMO				
	XQ 21361 P2/28 Off Road Caliper			1200 Multistrada Enduro 17-18 R
	122A99021 P2 24 Off Road Caliper			1200 Multistrada Enduro Pro 18 R
CAGIVA				
	E 750 Elefant	93-95	R	1200 Multistrada Touring 15-17 R
	E 900 C Elefant (282mm front discs /USD forks/Brembo front/rear calipers)	93-97	F&R	FACTORY YR 250 03 R
	E 900 C ie Lucky Explorer	95-97	F&R	FANTIC Caballero 50 Regularita Competizione 06-09 F
CCM				
	R30 (Spoke & Mag Wheel)	02-04	F	Caballero 50 Supersei Competizione 07-08 F
				Caballero 125 Regularita Competizione 07-09 F
				Caballero Regularita Competizione Mini 50 08-09 F
				GAS GAS (Pierer Mob) Quad Wild HP 50 04-07 F&R
				Enduro EC 125/200/250/300 97-99 F
				Wild HP 240/300 03-06 F&R
				Quad HP 300 RV 03-06 F&R
				Pampera 400 06 F
				Wild HP 450 Quad 04-09 F&R
				Wild HP 515cc Quad 09 F&R
				MC 85 2T 21 F
				MC 125 2T 21 F
				EC 250 2T 21 F
				EC 250 F 4T 21 F
				EX 250 F 4T 21 F
				MC 250 F 4T 21 F
				EC 300 2T 21 F
				EX 300 2T 21 F
				EC 350 F 4T 21 F
				EX 350 F 4T 21 F
				MC 350 F 4T 21 F
				EX 450 F 4T 21 F
				MC 450 F 4T 21 F
				HARLEY DAVIDSON XG 500/750 Street 16-20 R
				GILERA Nexus 500 03-12 F
				GP 800 (Chain drive) 08-14 F
				HIGHLAND 950 V2 Outback/Motard 00-04 F
				HONDA HM (Italy) CRE 50 Six 01-02 F
				CRE 50 Baja/Derapage 01-02 F
				HUSABERG TE 125 2T 12-14 F
				FE 250 (4T) 13-14 F
				TE 250/300 (2T) 11-14 F
				FE 350 (4T) 13-14 F
				FE 390 (New 70° Engine) 10-12 F
				Enforcer Four 00-03 F&R
				FE 450 E 06-08 F

FA181 94 x 37.5 x 7.5mm

Contd.

FE 450 (New 70° Engine)	08-14	F	EXC 125 (2T) Six Days	11-17	F	SX 620	96-98	F	
FX 450	10-12	F	SX 125	94-18	F	SC 620 Supercompetition	96-00	F	
FE 501 (4T)	13-14	F	SX 125 (Upside down forks)	09-22	F	EGS/EGS-E/LSE 620 Enduro	96-99	F	
FE 550/650 E	06-08	F	XC-W 125 (2T)	17-19	F	EGS-E 620 Adventure/Rallye	99	F	
FE 570	09-12	F	SM 125 Supermoto	00	F	LC4 620 SC Supermoto	00	F	
HUSQVARNA									
TC 85 17" F/wheel,			EXE 125	00	F	SXC 625	05-06	F	
14" R/wheel small wheel 2T	21-22	F	XC-W 125 (2T)	17-18	F	LC4-E 640 Enduro	00-04	F	
TC 85 19" F/wheel,			150 EXC Tpi	21-22	F	LC4-E 640 Supermoto	00-06	F	
16" R/wheel big wheel 2T	21-22	F	SX 150	09-22	F	LC4 640 Adventure R	99-02	F	
CR 125	95-13	F	XC 150 (USD)	11-13	F	LC4 640 Adventure	03	F	
SM 125	98-00	F	XC-W 150 (2T) Inc Tpi	17-21	F	LC4 625 SC Supermoto/Supercompetition	02	F	
SM 125 S	02-13	F	EXC 200/EGS	94-03	F	SXC 625	03-04	F	
SMR 125 (4T)	11-13	F	EXC 200 (inc Six Days)	04-17	F	LC4 640 Adventure	01-06	F	
SMS 4-125cc (4T)	11	F	EXC 250 Racing	06	F	790 Adventure R	19-21	R	
TC 125 (2T)	14-22	F	EXC-F 250	06-22	F	790 Adventure R Rally	19-21	R	
TE 125 (2T)	14-19	F	EXC-F 250 (4T) Six Days	11-22	F	890 Adventure Inc L	21	R	
TE 125 (4T)	11-13	F	MX 250	92-93	F	890 Adventure R	21	R	
TX 125 (2T)	18-19	F	SX 250 (2T/Std Forks)	94-99	F	890 Adventure R Rally	21	R	
TE 150 Tpi (2T)	18-22	F	SX 250 (2T) (Upside Down Forks)	09-22	F	950 Adventure S	03-06	R	
WR 125	05-13	F	SX-F 250 (4T)	06-22	F	950 Supermoto	05-07	R	
WRE 125	93-13	F	SX-F 250 Ken Roczen Edition	12	F	950 R Superenduro	06-08	R	
CR 250	95-05	F	EXC/EGS 250	94	F	990 Adventure	06-08	R	
FC/FE 250 (4T)	14-22	F	EXC 250	95-99	F	990 Adventure R	09-12	R	
TC 250 (4T)	02-13	F	EXC 250 Inc Tpi (2T)	11-22	F	990 T (SM-T)	09-13	R	
TC 250 (2T)	14-22	F	EXC 250 Inc Tpi (2T) Six Days	11-22	F	990 Supermoto R (SM-R)	08-13	R	
TE 250 (2T) Inc Tpi	14-22	F	XC 250-W (2TD) Inc Tpi	11-21	F	1050 Adventure	15-20	R	
TE 250 (4T)	02-13	F	XC-F 250 (USD)	11-21	F	1090 Adventure Inc R	17-20	R	
TE 250 Meo Replica (4T)	11	F	EXC 300 (Upside Down Forks)	00-21	F	1190 Adventure	13-20	R	
TE 250 R (4T)	13	F	EXC 300 (2T) Inc Tpi Six Days	11-22	F	1190 Adventure R	13-20	R	
WR 250 (2T)	95-13	F	& Erzbergrodeo	11-22	F	1290 Super Adventure Inc R and S	15-20	R	
TE 300 (2T)	14-19	F	XC 300 Inc XC-W Tpi (2T)	11-21	F	MAICO			
TE 300 Tpi (2T) Tpi Inc Jarvis Edition	19-22	F	EXC 350 LC4	94-95	F	500 MX/Enduro	99	F	
TX 300 (2T)	14-22	F	SX-F 350 (Upside down forks)	11-22	F	MBK			
WR 300 (2T)	09-12	F	SX-F 350 Tony Cairoli Edition	12	F	XQ 125/150 Thunder	01-03	F	
TE 310 (4T)	09-13	F	EXC-F 350 (USD)	11-22	F	YP 125 D Skyliner	98-10	F	
TE 310 R (4T)	13	F	EXC-F 350 WESS	21	F	VP 300 R Kilibre	03-04	F&R	
FC/FE 350 (4T)	14-22	F	EXC-F 350 Six Days	12-22	F	MOTO GUZZI			
FX 350 (4T)	18-22	F	XC-F Inc XCF-W 350	12-21	F	850 Brevia ie	06-07	R	
TE 350	95-97	F	SX 360	96-97	F	850 Griso	06-07	R	
WR 360	95-02	F	EXC 360	96-97	F	940 Bellagio	07-13	R	
TE 400	02	F	SX 380	98-03	F	Brevia V1100	05	R	
TE 410	95-00/06	F	EXC 380	98-03	F	Brevia 1100 (ABS)	07	R	
TE 410 E	00	F	EXC 400 Racing	04-07	F	Brevia 1100	05-06	R	
TC/TE 449 (4T)	11-13	F	EXC 400 (4T)	09-11	F	1100 Brevia (Std/ABS Models)	05-07	R	
FC 450 (4T) Inc Rockstar Edition	14-22	F	SC 400	96-99	F	Quota 1100 ES	99-01	R	
FE 450 (4T)	14-22	F	EGS/EGS-E/LSE 400 (LC4 Enduro)	96-99	F	1100 Griso 4V (1064cc)	05-08	R	
FX 450 (4T)	17-22	F	SX 400	00-02	F	1100 Griso	05-08	R	
TC/TE 450	03-10	F	EXC/EGS 400 (USD)	00-03	F	1100 Quota ES	99-01	R	
FE 501 (4T)	14-22	F	EXC 400 Racing (USD)	00	F	Brevia 1200	08-09	R	
TC 510	04-09	F	EXC 400	04-11	F	Norge 1200	06-09	R	
TE 510	04-10	F	LC4-E 400 Enduro	00-01	F	1200 Norge GT 8V (ABS)	08-15	R	
TE 511 (4T)	11-13	F	SX 440	94-95	F	1200 Griso 8v Special Edition			
TC 570	02-03	F	EXC 440	94-95	F	(1151cc/Spoke Wheel/Radial Caliper)	09-15	R	
TE 570	01-04	F	SX 450 (4T)	03-07	F	1200 Griso 8v (Std - Cast wheel			
TC/TE 610	00	F	SX-F 450 (4T)	09-22	F	/radial caliper)	07-12	R	
TC 610 E	95-99	F	EXC 450 Racing	06-07	F	1200 Griso 8v (1151cc/Cast Wheel			
TE 610 E	95-00/02-03	F	EXC-R 450 (4T)	08	F	/Radial Caliper)	09-11	R	
TE 610/IE	06-09	F	EXC 450 (4T)	03-22	F	1200 Sport	06-07	R	
TE 630	10-12	F	EXC 450 (4T) Six Days	11-22	F	1200 Sport (2V)	06-09	R	
KEEWAY									
Silverblade 125/150/250	07	F	EXC-F 500 (4T)	12-22	F	1200 Sport 4 Valve	08-12	R	
KXM/KXV 200	14	F	EXC-F 500 (4T) Six Days	12-22	F	1200 Stelvio	08-11	R	
KRAM-IT (KRAMER)									
GS 250	00-	F	XCF-W 500 (4T)	21	F	1200 Stelvio 8V (ABS)	11-15	R	
SM 250	00-	F	MX 500	92-95	F	1200 Stelvio NTX ABS	09-10	R	
KTM									
SX 85cc 17" F/wheel,			SX-F 505	07-09	F	1200 Stelvio 8v NTX (ABS)	11-15	R	
14" R/wheel small wheel	21-22	F	SX 520	01-03	F	MOTO MORINI			
SX 85cc 19" F/wheel,			SX 525	01-03	F	Granpasso 1200	08-13	R	
16" R/wheel big wheel	21-22	F	EXC 525	03	F	Scrambler 1200	10-13	R	
LC2 125	96-98	F	SX 525	03-06	F	PEUGEOT			
MX 125	92-93	F	EXC 525	04-05	F	Enduro 250/300 i	12	F	
D-XC/E-XC/E-GS 125	92-93	F	MXC 525	03-04	F	PIAGGIO			
EXC/EGS 125	94	F	XC 525 Racing	06-07	F	X9 250 Linked brake f&r wheel 14" dia	04	F	
EXC 125	95-17	F	EXC-R 530 (4T)	08	F	Beverley 400ie	07	F	
			EXC 530	09-11	F	X9 500cc Evolution	03-06	F	
			EXC 530 (4T) Six Days	11	F	X9 500ie	07	F	
			MXC 550	96	F	RIEJU			
			SX/EXC/EGS 620	94-95	F	Marathon 250/450	09-10	F	

FA181 94 x 37.5 x 7.5mm

Contd.

MR Pro 200/250/300cc 2T	19-21	F	5.1i Enduro (4T)	06-09	F	EN 450 Fi ES	10-21	F
MR racing 200/250/300cc 2T	19-21	F	Enduro 5.1iF	07-10	F	MX 450 F (4T)	04	F
MR RANGER 200/250/300cc 2T	19-21	F	5.1i Supermotard	06-09	F	MX 450 Fi ES	10-21	F
ROYAL ENFIELD			SM 5.1iF Supermotard	07	F	530 Cross (4T)	98-00	F
Bullet 500 (EFI/Single Seat)	16-18	F	SINNIS			EN 530 Fi ES (4T)	10-21	F
ROYAL ENFIELD (Contd.)			RSX 125	19-20	F	MX 530 Fi ES	10-21	F
Classic 500 (EFI/Single Seat)	16-21	F	SUZUKI			TRIUMPH		
Classic Chrome 500 (EFI/Single Seat)	16-18	F	UH 125 K2/K3/K4/K5/K6 Burgman	02-06	F	T100 900cc	16-21	F
Himalayan	16-21	F	S.W.M.			T100 Black 900cc	16-21	F
SHERCO			MC 125 R	18	F	T120 1200cc	16-21	F
125 SC-Factory	19-21	F	RS 125 R	16-17	F	T120 Black 1200cc	16-21	F
125 SE-R	19-21	F	SM 125 R	16-17	F	Bobber 1200cc	17-21	F
250 SC-Factory	19-21	F	MC 250 S	16	F	Bobber Black 1200cc	18-21	F
250 SCF-Factory	19-21	F	FT 300 R (RS 300 R Flat Track)	17	F	900cc	16-20	F
250 SE-R	19-21	F	RS 300 R (4T)	15-18	F	900cc	16-20	F
250 SE-Factory	19-21	F	RS 340 S	16	F	900cc	16-18	F
250 SEF-R	19-21	F	RS 500 R (4T)	15-18	F	900	04-16	F
250 SEF-Factory	19-21	F	RS 650 R	16-18	F	Tiger 800 XCa (ABS) from VIN 855532	18-20	F
SE 250 i Enduro (Brembo rear caliper) (2T)	12-15	F	TM			Tiger 800 XCx (ABS) from VIN 855532	18-20	F
SEF 250 (4T)	13-15	F	80 Enduro	96-00	F	Tiger 800 XRt (ABS) from VIN 855532	18-20	F
SEF-R 250 (4T)	13-15	F	80/85 Cross	96-01	F	Tiger 800 XRx (ABS) from VIN 855532	18-20	F
SE-R 250 (2T)	12-15	F	80/85/100 (Big wheel)	02-04	F	VECTRIX		
SEF 300 (4T)	13-15	F	Junior 80/85/100 Cross (Small wheel)	02-04	F	VX-1 (Li/NiMh)	07-14	F&R
SE-R 300 (2T)	12-15	F	Junior 80/85/100	05-08	F	VX-3 Li+ (3 wheeler model)	12-13	R
300 SC-Factory	19-21	F	MX 85 JR (Small Wheel)	02-15	F	VERTEMATI		
300 SCF-Factory	19-21	F	MX 85 (Big Wheel)	02-15	F	All models (2 piston Brembo)	99-04	F
300 SE-R	19-21	F	125 Cross	95-00	F	VOR		
300 SE-Factory	19-21	F	MX 125 2S (2T)	10-21	F	All models (2 piston Brembo)	03-04	F
300 SEF-R	19-21	F	125 Enduro	95-00	F	YAMAHA		
300 SEF-Factory	19-21	F	EN 125 2S Tsi (2T)	10-21	F	FZS 25	19-21	R
450 SM	04-08	F	MX 125 (2T)	05-14	F	GT 125 Hammerhead	12-18	F
2.5i Enduro (4T)	06-09	F	EN 144 2S Inc Tsi (2T)	10-21	F	YBA 125 Enticer (3P01/3P41)	05-06	F
Enduro 2.5iF (4T) (inc SE models)	08-10	F	MX 144 2S (2T)	10-21	F	YP 125 Majesty	98-09	F
SM 2.5i Supermotard	08	F	250 Cross	95-00	F	XQ 125/150 N Maxster	01-03	F
SX 2.5iF Moto Cross	10	F	250 (4T) Cross MX	02-14	F	YZF-R 125	08-13	F
Enduro SE 3.0i (4T)	10	F	MX 250 ES 2S (2T)	10-21	F	VP 300 Versity	03-05	F&R
SEF 300 (4T)	13-15	F	MX 250 (4T)	02-09	F	XC 300 Versity	06	R
SE-R 300 (2T)	12-15	F	MX 250 Fi ES (4T)	10-21	F	TT 600 R (5CH1/5CH2/5CH3)	97-02	F
4.5i (Enduro)	04-09	F	250 Enduro	95-00	F	TT 600 RE (5CH5)	04	F
Enduro 4.5i	04-10	F	EN 250 Tsi ES (2T)	10-21	F	TT 600 E (4LW3/4LW4/4GV4/4GV5)	94-01	F
SE 450 iR Enduro (Nissin rear caliper)	12	F	EN 250 F (4T) Enduro	04-09	F	TT 600 E (4GV2)	94-95	F
SEF 450 (4T)	14-15	F	EN 250 Fi ES Twin (4T)	10-21	F	TT 600 K (4LW1/4GV1/4LW2)		
SE-R 450 (2T)	14-15	F	300 Cross	95-00	F	Up to 4GV 003403	93-95	F
450 SCF-Factory	19-21	F	MX 300 2S ES (2T)	10-21	F	TT 600 K From 4GV 003404	95-96	F
450 SE-R	19-21	F	MX 300 Fi ES (4T)	10-21	F	XT 660 Z Tenere	08-16	F
450 SEF-Factory	19-21	F	EN 300 2S Inc Tsi (2T) Enduro	10-21	F	XT 660 ZA Tenere (ABS)	11-16	F
500 SCF-Factory	19-21	F	FT 300 2s ES 2T	19-21	F	XT700 Z Tenere	19-21	F
500 SEF-R	19-21	F	300 Enduro (2T)	95-00	F	ZERO		
500 SEF-Factory	19-21	F	400 (4T) MX Cross	02-03	F	Zero FX (ZF2.8/ZF5.7)		
SE 510 iR (Nissin rear caliper)	12	F	400 Cross (4T)	95-00	F	(J.Juan F&R Calipers)	15	F

FA182 75 x 54 x 10mm

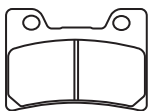

MATERIAL AVAILABILITY

FA	TT	V	R	HH	MXS	SXR	EPFA	GPFAX	SFA	SFAC	SFAHH
✓				✓							

YAMAHA

FZR 1000 EX UP (USD Forks) 91-93 F

GFA183HH 102.5 x 55 x 8mm

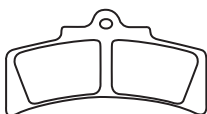

MATERIAL AVAILABILITY

FA	TT	V	R	HH	MXS	SXR	EPFA	GFA	SFA	SFAC	SFAHH
								✓			

PVM AFTERMARKET CALIPER

6 Piston (old large design)

FA184 28.5 x 46 x 7mm



MATERIAL AVAILABILITY

FA	TT	V	R	HH	MXS	SXR	EPFA	GPFAX	SFA	SFAC	SFAHH
								✓			

ISR AFTERMARKET CALIPER

22-034 (6 Piston Small)

22-036 (2 Piston)

22-043 (4 Piston)

Radial 6 Piston Monoblock

FA185 94 x 34 x 7mm



MATERIAL AVAILABILITY

FA	TT	V	R	HH	MXS	SXR	EPFA	GPFA	SFA	SFAC	SFAHH
✓	✓		✓		✓		✓				

AJP PR5 Supermoto/Enduro 250cc PR5 250cc Extreme	09 12-15	F	CRM 250 RR/RR11 (MD24 140) MK3 CRM 250 'Active Radial' (MD32) ARV/ARW	94-96 97-98	F	KLX 250 R D1/D2 KLX 250 G1				93-94 94	F		
ALFER AR 250	93-	F	CRF 250 RE (Limited Road Use) CRF 250 R4-R9/RA/RB/RC/RD/RE/RF/RG	16 04-16	F	KLX 250 J1-J6 D-Tracker KLX 250 H6F/H7F				98-03 06-07	F		
APRILIA MXV 450 RXV 450/550 Enduro	09-13 06-13	F	CRF 250 R (260mm F/Disc) CRF 250 X (18" rear wheel) CRF 250 RX (18" rear wheel) CRF 250 XRL (Road legal)	15-21 04-20 19-21 14-20	F	KX 250 F (KX 250 N1/N2) KX 250 F (T6F/T7F/T8F) KX 250 F (KX 250 W9F/XAFB/YBF				04-05 94-08 06-08	F		
BETA Enduro RR 125 LC (2T) MY20 RR 125 (2T) Inc MY20 RR 200 (2T) MY20 RR 250 2T RR 250 Enduro (2T) Inc MY20 RR 250 Enduro Racing (2T) RR 250 4T Enduro RR 250 Racing (2T) 250 X-Trainer RR 300 Enduro 2T RR 300 Enduro Racing (2T) RR 300 Racing (2T) 300 X-Trainer (2T) RR 350 Enduro Racing (4T) Enduro RR 350 (4T) Inc Racing and MY20 Enduro 350 RR-S RR 350 4T Enduro Enduro RR 390 (4T) MY20 Enduro 390/430 RR-S RR 400 4T Enduro Enduro RR 430 (4T) Inc Racing and MY20 Enduro 430 RR-S RR 450 4T Enduro RR 450 Enduro Racing (4T) RR 450 4T Cross Country Enduro RR 480 (4T) Inc Racing and MY20 RR 498 4T Enduro RR 498 Enduro Racing (4T) Enduro 500 RR-S RR 520 Enduro RR 525 4T Enduro	20-21 18-21 20-21 13-14 14-21 18-19 05-07 15 20-21 13-14/18-21 13-14 15 15-21 13 15-20 20-21 11-14 20-21 05-14 15-21 20-21 05-14 13-14 12 15-21 12-14 13-14 20-21 05-11 05-09	F	XL 250 Degree (MD26) XLR 250 RM/R3N/PP/RR/R3R (MD22) XLR 250 Baja MK2 (MD22) XR 250 Y/3 (MD30) XR 250 3/S (MD30) Motard XR 250 III Y/3 Baja XR 300 R10 NX4 Falcon XR 400 RT/RV/RW/RX/R1-R5 CRF 450 L CRF 450 R CRF 450 RL CRF 450 R-S CRF 450 RWE CRF 450 RX (18" Rear Wheel) CRF 450 X CRF 450 XRL (Road legal) TRX 450 R4-R9/ER6-ER9 CR 500 RS/RT/RV/RW/RX/R1 XR 600 RP/RR/RS/RT/RV/RW/RX/R1 XL 600 VV/VX Transalp XL 650 VV/V1-V7 Transalp XR 650 RY/R1-R7 XR 650 L TRX 700 XX8/XX9/XXB XL 700 V8/V9/VA (Transalp/2 piston front caliper/ABS on rear disc) XRV 750 P/R/S/T/V/W/X/Y 'Africa Twin'	96-04 94-96 91- 00-03 03-05 00-03 10 02-05 96-05 18-20 02-22 20-22 22 19-22 19-22 05-21 14-16 04-09 95-01 93-00 97-00 00-07 00-07 93-21 08-11 08-11 94-03	F	KLX 250 R D1/D2 KLX 250 G1 KLX 250 J1-J6 D-Tracker KLX 250 H6F/H7F KX 250 F (KX 250 N1/N2) KX 250 F (T6F/T7F/T8F) KX 250 F (KX 250 W9F/XAFB/YBF /YCF/ZDF/ZEF/ZFF/ZGF) (4T) KX 250 F KX-F 250 KX-F 250 XC Enduro KLX 300 A2-A10/A6F/A7F KLX 400 R (KLX 400 B1/B2) KLX 450 R (A8F/A9F/AAF/ABF/ACF /ADF/AEF/AFF/AGF/AHF/AJF) KX 450 F KX-F 450 KX-F 450 XC Enduro KX 500 E6-E16 KLX 650 C1/C2/C3					09-16 15-21 15-22 21-22 97-07 03-04 08-18 06-21 06-22 21-22 94-04 93-97	F	
SUZUKI DR 125 SMK8/SMK9/SML0 RM 125 T/V/W/X/K1-K9 RM 125 XCK8 250 SBK2 (LX 250 L) DR 250 RLV/RL/RLY/RS/RLS/RT/RV/ RL/RLW/RW/R1 (SJ45A/DOHC) DR 250 RXT/RXLT/RTV/RXLX/RXW/ RXLW/RXGW/RXGLW/RXY/RXGY (Djebel 250 XC/GPS Ver (SJ45A) DR-Z 250 K1-K7 (DJ43A) RM 250 T/V/W/X/K1-K9 RM 250 XCK8 RMX 250 T/V/W RMX 250 ST/SV/SW/SW/SX (SJ14A) RM-Z 250 DR 350 SEW/SEX Electric Start /6 bolt front disc DR-Z 400 S DR-Z 400 SMK5-SMK9 RMX 450 ZL0/ZL2 RM-Z 450 DR 650 SET/SEV		F	DR 125 SMK8/SMK9/SML0 RM 125 T/V/W/X/K1-K9 RM 125 XCK8 250 SBK2 (LX 250 L) DR 250 RLV/RL/RLY/RS/RLS/RT/RV/ RL/RLW/RW/R1 (SJ45A/DOHC) DR 250 RXT/RXLT/RTV/RXLX/RXW/ RXLW/RXGW/RXGLW/RXY/RXGY (Djebel 250 XC/GPS Ver (SJ45A) DR-Z 250 K1-K7 (DJ43A) RM 250 T/V/W/X/K1-K9 RM 250 XCK8 RMX 250 T/V/W RMX 250 ST/SV/SW/SW/SX (SJ14A) RM-Z 250 DR 350 SEW/SEX Electric Start /6 bolt front disc DR-Z 400 S DR-Z 400 SMK5-SMK9 RMX 450 ZL0/ZL2 RM-Z 450 DR 650 SET/SEV		F	DR 125 SMK8/SMK9/SML0 RM 125 T/V/W/X/K1-K9 RM 125 XCK8 250 SBK2 (LX 250 L) DR 250 RLV/RL/RLY/RS/RLS/RT/RV/ RL/RLW/RW/R1 (SJ45A/DOHC) DR 250 RXT/RXLT/RTV/RXLX/RXW/ RXLW/RXGW/RXGLW/RXY/RXGY (Djebel 250 XC/GPS Ver (SJ45A) DR-Z 250 K1-K7 (DJ43A) RM 250 T/V/W/X/K1-K9 RM 250 XCK8 RMX 250 T/V/W RMX 250 ST/SV/SW/SW/SX (SJ14A) RM-Z 250 DR 350 SEW/SEX Electric Start /6 bolt front disc DR-Z 400 S DR-Z 400 SMK5-SMK9 RMX 450 ZL0/ZL2 RM-Z 450 DR 650 SET/SEV				08-12 96-12 09 02 95-00 01-07 96-12 09 96-98 96-99 04-22 98-99 00-22 05-22 10-15 05-21 96-21	F		
YAMAHA YZ 125 K/L/M/N/P/R/S/T/V/W (2T) WR 250 FN/FP/FR/FS/FT/FV/FW/FX /FY/FZ/FA/FB/FD (4T) WR 250 FF/FG (4T/Reverse Cylinder) WR 250 ZK WR 250 R (32D1/3) YZ 250 K/L/M/N/P/R/S/T/V/W YZ 250 FN/FP/FR/FS/FT/FV (4T) YZ 400 FK/FL WR 400 FL/FM/FN WR 426 FN/FP YZ 426 FM/FN/FP WR 450 FR/FS/FT/FV/FW/FX/FY/FA /FB/FD/FE/FF (4T) YZ 450 FR/FS/FT/FV/FW		F	YAMAHA YZ 125 K/L/M/N/P/R/S/T/V/W (2T) WR 250 FN/FP/FR/FS/FT/FV/FW/FX /FY/FZ/FA/FB/FD (4T) WR 250 FF/FG (4T/Reverse Cylinder) WR 250 ZK WR 250 R (32D1/3) YZ 250 K/L/M/N/P/R/S/T/V/W YZ 250 FN/FP/FR/FS/FT/FV (4T) YZ 400 FK/FL WR 400 FL/FM/FN WR 426 FN/FP YZ 426 FM/FN/FP WR 450 FR/FS/FT/FV/FW/FX/FY/FA /FB/FD/FE/FF (4T) YZ 450 FR/FS/FT/FV/FW		F	YAMAHA YZ 125 K/L/M/N/P/R/S/T/V/W (2T) WR 250 FN/FP/FR/FS/FT/FV/FW/FX /FY/FZ/FA/FB/FD (4T) WR 250 FF/FG (4T/Reverse Cylinder) WR 250 ZK WR 250 R (32D1/3) YZ 250 K/L/M/N/P/R/S/T/V/W YZ 250 FN/FP/FR/FS/FT/FV (4T) YZ 400 FK/FL WR 400 FL/FM/FN WR 426 FN/FP YZ 426 FM/FN/FP WR 450 FR/FS/FT/FV/FW/FX/FY/FA /FB/FD/FE/FF (4T) YZ 450 FR/FS/FT/FV/FW					98-07 01-13 15-16 98 08-20 98-07 01-06 98-99 99-01 01-02 00-02	F	
ZERO Zero DS (ZF8.5/ZF11.4) (Nissin F&R Calipers) Zero MX (ZF2.8/ZF5.7) (Nissin F&R Calipers) Zero S (ZF8.5/ZF11.4) (Nissin F&R Calipers) Zero XU (Nissin F&R Calipers) Zero FX (Nissin F&R Calipers) Zero DS (Dual Sport) Zero F/J.Juan R Calipers) Zero FX (Stealthfighter) (Nissin F/J.Juan R Calipers) Zero S (Streetfighter) (Nissin F/J.Juan R Calipers) Zero SR (Max Performance) (Nissin F/J.Juan R Calipers)		F	ZERO Zero DS (ZF8.5/ZF11.4) (Nissin F&R Calipers) Zero MX (ZF2.8/ZF5.7) (Nissin F&R Calipers) Zero S (ZF8.5/ZF11.4) (Nissin F&R Calipers) Zero XU (Nissin F&R Calipers) Zero FX (Nissin F&R Calipers) Zero DS (Dual Sport) Zero F/J.Juan R Calipers) Zero FX (Stealthfighter) (Nissin F/J.Juan R Calipers) Zero S (Streetfighter) (Nissin F/J.Juan R Calipers) Zero SR (Max Performance) (Nissin F/J.Juan R Calipers)		F	ZERO Zero DS (ZF8.5/ZF11.4) (Nissin F&R Calipers) Zero MX (ZF2.8/ZF5.7) (Nissin F&R Calipers) Zero S (ZF8.5/ZF11.4) (Nissin F&R Calipers) Zero XU (Nissin F&R Calipers) Zero FX (Nissin F&R Calipers) Zero DS (Dual Sport) Zero F/J.Juan R Calipers) Zero FX (Stealthfighter) (Nissin F/J.Juan R Calipers) Zero S (Streetfighter) (Nissin F/J.Juan R Calipers) Zero SR (Max Performance) (Nissin F/J.Juan R Calipers)					13 13 14 13 14 14	F	
HONDA CR 125/250 RS/RT/RV/RW/RX/R1-R7 CRF 125 F Small wheel (FR 17"/RR 14" Wheels) CRF 125 FB Big wheel (FR 19"/RR 16" Wheels) XLR 125 RW XR 125 L3-L8 CRF 150 F CTX 200/CTX 200 A Bushlander CRF 230 F AC CRF 230 L CRF 230 M SL 230 'Free Landsports' (MD33) V/W/X1	09-07 14-21 14-21 98-01 03-08 03-20 04-16 04-20 08-10 09-10 97-01	F	HONDA CR 125/250 RS/RT/RV/RW/RX/R1-R7 CRF 125 F Small wheel (FR 17"/RR 14" Wheels) CRF 125 FB Big wheel (FR 19"/RR 16" Wheels) XLR 125 RW XR 125 L3-L8 CRF 150 F CTX 200/CTX 200 A Bushlander CRF 230 F AC CRF 230 L CRF 230 M SL 230 'Free Landsports' (MD33) V/W/X1		F	HONDA CR 125/250 RS/RT/RV/RW/RX/R1-R7 CRF 125 F Small wheel (FR 17"/RR 14" Wheels) CRF 125 FB Big wheel (FR 19"/RR 16" Wheels) XLR 125 RW XR 125 L3-L8 CRF 150 F CTX 200/CTX 200 A Bushlander CRF 230 F AC CRF 230 L CRF 230 M SL 230 'Free Landsports' (MD33) V/W/X1						95-07 14-21 14-21 98-01 03-08 03-20 04-16 04-20 08-10 09-10 97-01	F
KAWASAKI KX 125 K1-K5/L1-L4/M1-M3/M6F-M8F KDX 200 H1-H5 RM 125 K6/K7/K8 KDX 220 R A4-A12/A6F KDX 220 SR (DX 220 B) KLX 250 F1-F4	94-08 95-99 06-08 97-06 94-97	F	KAWASAKI KX 125 K1-K5/L1-L4/M1-M3/M6F-M8F KDX 200 H1-H5 RM 125 K6/K7/K8 KDX 220 R A4-A12/A6F KDX 220 SR (DX 220 B) KLX 250 F1-F4		F	KAWASAKI KX 125 K1-K5/L1-L4/M1-M3/M6F-M8F KDX 200 H1-H5 RM 125 K6/K7/K8 KDX 220 R A4-A12/A6F KDX 220 SR (DX 220 B) KLX 250 F1-F4						94-08 95-99 06-08 97-06 94-97	F

DO NOT REFIT ANY SHIMS/INSULATORS TO EBC PADS FROM ORIGINAL PADS UNLESS INSTRUCTED ON NOTE ON PAD PACKAGING AND ON FA DRAWING ASSOCIATED WITH THAT PAD.

BRAKE PAD
BUYERS GUIDE

SFA186 31.5 x 51 x 5.5mm



MATERIAL AVAILABILITY												
FA	TT	V	R	HH	MXS	SXR	EPFA	GPFA	SFA	SFAC	SFAHH	
									✓	✓		

CAGIVA

Blues 50
Supercity 50/80
Prima 50

93-95 R
93-95 R
92-94 R

PIAGGIO

Quartz 50
Sfera 50 RST
Skipper 125/150
LX 60 (Special Anniversary Model)

92-96 F
95-97 F
94-97 F
06 F

LML

Star 125i (4T)
Star 125 (2T)
Star 125 Deluxe (2T) (Front disc)
Star 150 (2T)
Star 150 Deluxe (2T) (Front disc)
Star 151i (4T)
Star 200i (4T)

10-15 F
10-14 F
01-03 F
10-14 F
01-03 F
10-15 F
10-15 F

VESPA

PX 125 (Disc brake model/2T)
PX 125 Touring (Disc brake model)
PX 150 (Disc brake model)
PX 150 Touring (Disc brake model)
PX 200 (Disc brake model)

98-30/04/11 F
15 F
98-15 F
15 F
98-07 F

FA187 68 x 54 x 8mm

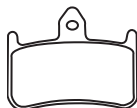

MATERIAL AVAILABILITY												
FA	TT	V	R	HH	MXS	SXR	EPFA	GPFA	SFA	SFAC	SFAHH	
✓		✓		✓			✓					

HONDA

CB 250 FT/FV/FX/FY/F1 'Hornet'
NSR 250 R6K/R6K-2 (MC18-110)
NSR 250 R7L (MC21-100) R7N (MC21-106)
NSR 250 R8L-3 (MC21-101) R9L (MC21-102) R8N/R89N-3 (MC21-106)
NSR 250 R2R/R3R (MC28-110)
R2T/R3T (MC28-120)
NSR 250 R9N (MC21-106)
NSR 250 RR (MC28-100)
NSR 250 R2J (MC18-100) R4J (MC18-100)
NSR 250 R5K/R5K-2 (MC18-110)
CB 400 SF (F2V/F3T) Superfour (NC31)

96-01 F
89 F
90 F
90-92 F
94 F
92 F
94 F
88 F
89 F
96-97 F

NT 400 'Bros' NC25
VFR 400 R3K/R3L/R3M/R3N (NC30)
RVF 400 RR/RRII/RT/RT-II (NC35)
Bros Product One 650
NT 650 J/K/L 'Bros'
NR 750 N
VFR 750 RJ/RK/RL (RC30)
RVF 750 RR/RS 'RC45'
CBR 900 RRN/RRP/RRR/RRS
/RRT/RRV Fireblade
CB 900 F2/F3/F4/F5/F6/F7 Hornet
CB 1000 FP/FR/FS/FT/FV
VTR 1000 FV/FW/FX/FY/F1-F6 Firestorm
'X4' CB 1300 DCV/DCW/DCX/DCY (SC38)

F
89-92 F
94-96 F
88-92 F
92 F
88-90 F
94-98 F
02-07 F
93-97 F
97-06 F
97-00 F

FA188 89 x 53 x 8.5mm



MATERIAL AVAILABILITY												
FA	TT	V	R	HH	MXS	SXR	EPFA	GPFA	SFA	SFAC	SFAHH	
✓				✓			✓					

KAWASAKI

ZX-6R (ZX 600 G1/G2/J1/J2)
ZX6R (ZX 636 A1P) '636cc'
ZX-7R (ZX 750 P1-P7)
GPZ 900 R (ZX 900 A12-15)
ZX-9R (ZX 900 B3/B4/C1/C2/E1/E2)
ZRX 1100 C1/C2/C3/C4
ZX12R (ZX 1200 A1/A2/B1/B2)
ZRX 1200 R(A1/A2/A3/A4/A5/A6F)
ZRX 1200 S (B1/B2/B3)
VN 1500 Mean Streak P1/P2
VN 1600 B1 Mean Streak

98-01 F
02 F
96-03 F
99-02 F
96-01 F
97-00 F
00-03 F
01-08 F
01-04 F
02-04 F
04 F

GSXR 1000 K1/K2
TL 1000 RW/RX/RV/RK1
GSXR 1100 WP/WR/WS/WT
GS 1200 SSK1/ZK1 (GV78A)
GSF 1200 SK1/K1-K5/SK2-SK5
GSX 1300 RX/RV/RK1-RK5/K6/K7
'Hayabusa'
GSX 1400 K1-K7/FE
M 1600 (VZ 1600 K4 Intruder)
VZ 1600 K4 Marauder
JAYBRAKE
J-Four (300-44) (4 Piston)

01-02 F
98-02 F
93-96 F
02 F
01-05 F
99-07 F
01-07 F
04 F
04 F

SUZUKI

GSXR 750 WR/WS
GSXR 750 T/V/W/X

94-95 F
96-99 F

FA189 125.5 x 45 x 9mm

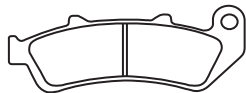

MATERIAL AVAILABILITY												
FA	TT	V	R	HH	MXS	SXR	EPFA	GPFA	SFA	SFAC	SFAHH	
✓				✓								

HONDA

CBR 1000 FP/FR/FS/FT/FV/FW/FX 93-99 F&R

FA190 99 x 49.5 x 9.5mm

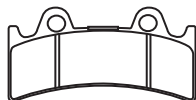

MATERIAL AVAILABILITY												
FA	TT	V	R	HH	MXS	SXR	EPFA	GPFA	SFA	SFAC	SFAHH	
✓		✓		✓			✓					

PERFORMANCE AFTERMARKET CALIPER

112 X 6RSB
112 X 6SSB

PRE TECH AFTERMARKET CALIPER
6 Piston

TRIUMPH

Daytona Super III (3 cyl)
YAMAHA
YZF 750 R/SP
FZR 1000 EX UP (6 piston caliper)

94-97 F
93-97 F
94-95 F

DO NOT REFIT ANY SHIMS/INSULATORS TO EBC PADS FROM ORIGINAL PADS UNLESS INSTRUCTED ON NOTE ON PAD PACKAGING AND ON FA DRAWING ASSOCIATED WITH THAT PAD.

SFA193 40 x 51 x 7mm

GARELLI

Flo 50 F
 Skynet 250/40 02 R
GENERIC/KSR

Onyx 50 (2T/4T) 10-18 F
 Pandora 50 (2T/4T) 13-18 F

GILERA

Stalker 50 97-06 F
 50 DD/SP Runner/Purejet 99-04 F
 Ice 50 01-03 F
 Runner 50 98 F
 SKP 50 98-01 F
 Storm 50 94-95 F
 Easy Moving 50 95-96 F
 Stalker 50 (Rear drum model) 97-02 F
 Typhoon 125 95-98 F
 Typhoon 125 X-XR 99-00 F

GOVECS (ELECTRIC SCOOTERS)

GO S 1-2 11-14 F
 GO T 1-2 11-14 F
 GO T 1-4 13-14 F
 GO S 1-4 11-14 F
 GO S 2-4 11-14 F
 GO T 2-4 11-14 F
 GO S 3-4 11-14 F
 GO T 3-4 11-14 F

HONDA

SFX 50 S/T/V/W/X/Y/1 95-04 F
 SGX 50 V/W/X/Y/1 "Sky Deluxe" 97-03 F
 SH 50 T Fifty/Scoopy W/X/Y/1 97-03 F
 SRX 50 W/SW/X/SX 98-99 F
 SZX 50 (X8R) SW/SX/SY/S1
 'Supersport Scooter' 98-04 F
 SZX 50 (X8R) XW/XX/XY/X1
 'Cross Sport' 98-04 F
 SH 100 T/W/X/Y/1 Scoopy 96-01 F

ITALJET

50 Formula 98-00 F&R

KEEWAY

Goccia 50 (2T/4T) 08-15 F

MALAGUTI

F18 Warrior 125/150 00-03 F
 Ciak 50/100 00-04 F
 Ciak 50 00-03 F&R
 Ciak 50 (4T) Master 04-08 F
 Ciak 100 99-03 F&R
 Ciak (electrical power) 00-05 F
 F10 Jetline/ 94-07 F
 F10 Jetline WAP 06-10 F
 F10 Tribal 08-10 F
 F12 50 Phantom 98-02 R
 F12 Phantom (All liquid cooled models) 99-07 F&R
 Phantom F12R 50 A/C 07-11 F
 Phantom F12R 50 L/C 07-11 F&R
 F15 RR 99-01 R
 F12 Phantom (A/C) 02-08 F
 F15 Firefox (Liquid cooled models) 01-08 F&R
 Firefox F15 (Air cooled models) 99-08 F
 F69 Phantom 70 98 F

MBK

CS 50 Mach G AC (Air Cooled) 02-10 F
 CS 50 Mach G LC (Liquid Cooled) 03-10 F
 CW 50 R Booster Road 94-95 F
 CW 50 Booster Spirit 96-98/09 F
 CW 50 Booster Naked (10" wheels) 06-10 F
 CW 50 Naked Booster (12" wheels) 09-10 F
 CW 50 RS Booster NG 95-98 F
 CW 50 RS Booster NG 01-06 F
 CW 50 RS Booster Naked 04-08 F
 CW 50 RSX Booster Track 96-98 F
 CW 50 RS Booster Spirit 99-06 F
 CW 50 RSP Rocket 97-00 F
 CW 50 Fizz 50 93-97 F
 CW 50 Evolis 97 F
 CW 50 Power Rocket 06 F
 CW 50 Booster (12" wheels) 06-10 F
 CW 50 Booster (10" wheels) 09-10 F
 YA 50 R Forte 94-95 F
 YE 50 Evolis 92-95 F
 YH 50 Flipper 98-10 F
 YM 50 Fizz 94-95 F
 YN 50 R Ovetto (2T) 98-10 F
 YN 50 Ovetto (4T) 09-10 F
 YQ 50 Nitro 97-10 F
 YQ 50 Nitro Naked 06-10 F
 CV 80 Evolis 97 F
 YN 100 Ovetto 99-03 F
 YQ 100 Nitro 01-02 F
 XN 125/150 Doo Doo 00-05 F

MOTRON

50 Sting 98 F
 50 Syncro 98 F
 50 Thunder 98 F

PEUGEOT

Buxy/Buxy RS 94-97 F
 Zenith L (All models) 96-99 F
 Ludix Pro (14" wheels/4T) (J. Juan Caliper) 11-13 F

PGO

Rodo Show 50 00-09 F

PIAGGIO

Zip Fast Raider 93-97 F
 Free 50 02 F
 NRG 50 94-96 F
 NRG 50 Extreme 99-01 F
 NTT 50 95-96 F
 Zip 50 Base (Disc Model) 95-96 F
 Zip 50 Elettrico 02 F
 NRG 50 RST "MC2" (Rear drum models) 96-97 F
 NRG 50 RST (DD/DT) "MC2" (Rear drum models) 98 F
 NRG 50 RST "MC2" (Rear disc models) 98 F
 NRG 50 Extreme (Rear drum models) 99-01 F
 NRG 50 Extreme (Rear disc models) 99-01 F
 NRG 50 DT MC3 01-05 F
 NRG 50 MC3 DD 01-05 F
 Typhoon 50 (2T) Heng Tong Caliper
 /10" wheels 01-09 F

Typhoon 50 (2T) Grimeca Caliper

/10" wheels 00-04 F
 Free 100 02 F
 Hexagon 125/150 94-97 F
 Typhoon 125 99-03 F

QUADRA

350 D 11-15 F
 350 S 13-15 F
 350 4 14-15 F

RIEJU

RS NKD 50 (Scooter) 13-20 R
 RS Sport 50 (Scooter) 12-20 R

SUZUKI

AP 50 R/S/T/V/W 96-02 F
 AY 50 V/W/W/WW/WRW/WRX/WX /WRY/WRK1/WRK2/WRK3/WRK4 /K1/K2/K3 Katana (Grimeca Caliper) 97-04 F
 UX 50 WX/WY 'Zillion' 99-02 F

YAMAHA

Aerox 4 (NS 50 F 1GB) 14-18 F
 BW's 50 Next Generation (Twin headlight model) (190mm disc) 99-07 F
 BW's 50 Original (180mm disc) 99-02 F
 BW's 50 (5WW1) 04 F
 BW's 50 (5WW4/6/8/9/B/D/F/H/K/M/P) 05-15 F
 BW's R 50 (5SX1) 01 F
 BW's 50 Naked (1D11/2B71) 03-04 F
 BW's 50 Naked (2B7B/D/F/H) 09-15 F
 CW 50 RS (4YA1/2/BW'S) (180mm front disc) 96-97 F
 CS 50 Jog R 02-05 F
 CS 50 Jog R 06-15 F
 CS 50 Z (Jog RR) 03-05 F
 CS 50 Z (Jog RR) 06-12 F
 CW 50 RS (AYA4/BW'S NG) (180mm front disc) 98 F
 CW 50 RS (5FXA/VG5SA BW'S) (190mm front disc) 99 F
 CW 50 RS (5FXJ/VG5SA BW'S) (190mm front disc) 00 F
 CW 50 RS (5FXM/VG5SA BW'S) (190mm front disc) 01-05 F
 CW 50 (5MS2/4G54R) 02 F
 CW 50 (5WW4/BW'S) 04-07 F
 CW 50 RSP (5CC1/3/4YA BW'S Sply) (180mm front disc) 97-98 F
 NS 50 Aerox (2T) 13-16 F
 NS 50 N Aerox Naked (2T) 13-16 F
 YA 50 R Axis (4PC) 95-96 F
 YE 50 Zest 93-95 F
 YFM 50 Breeze (4KH) 94-95 F
 YN 50 R Neos (5AD/5MR/5RN3) 97-02 F
 YN 50 Neos (5RN/1P9) 02-06 F
 YN 50 F Neos (4T) (5C3) 09-18 F
 YN 50 Neos (2T) (IF5C2/IH5C2) 07-16 F
 YQ 50 Aerox R/Aerox 97-16 F
 YH 50 Why 99-09 F
 YN 100 Neos 100 99-03 F
 YQ 100 Aerox 100 00-04 F
 XN 125 Teos 00-03 F

BRAKE PAD BUYERS GUIDE

DO NOT REFIT ANY SHIMS/INSULATORS TO EBC PADS FROM ORIGINAL PADS UNLESS INSTRUCTED ON NOTE ON PAD PACKAGING AND ON FA DRAWING ASSOCIATED WITH THAT PAD.

FA194 A 95.5 x 42 x 7.5mm B 77 x 42 x 7.5mm

MATERIAL AVAILABILITY											
FA	TT	V	R	HH	MXS	SXR	EPFA	GPFAX	SFA	SFAC	SFAHH
✓				✓					✓	✓	✓



AJP

PR3 125 Enduro/Enduro Pro 08-12 F
 PR3 125 Supermoto 08-12 F
 PR3 125 Trial 11-12 F
 PR4 125 Enduro/Enduro Pro 10-12 F
 PR4 125 Supermoto 10-12 F
 PR4 125 Supermoto Pro 10-11 F
 PR3 200 Enduro/Supermoto 08-14 F
 PR3 200 Enduro Pro 12-14 F

PR3 200 Supermotard Pro 10-11 F
 PR3 200 MX 10-11 F
 PR3 200 M/X Pro 10-14 F
 PR4 200 Enduro/Extreme 12-14 F
 PR4 200 Enduro Pro/Supermoto 10-14 F
 PR4 200 SM Pro 10-11 F
ALFER
 VR 125 Raider 12-13 F
 VX 125 Explorer 12-13 F

VX 200 Explorer 12-13 F
 EVX 400 Electric 12-13 F
APRILIA
 MX 50 03-05 F
 Pegaso 50 92-94 F
 RS 50 99-05 F
 RX 50 C/CD 93-04 F
 RX 50 Racing 03-06 F
 RX 50 06-20 F

FA194 A 90 x 51 x 8.5mm B 68 x 52 x 9.5mm

DO NOT REFIT ANY SHIMS/INSULATORS TO EBC PADS FROM ORIGINAL PADS UNLESS INSTRUCTED ON NOTE ON PAD PACKAGING AND ON FA DRAWING ASSOCIATED WITH THAT PAD.

SX 50	06-14	F	GAS GAS			Elystar 125/150 (5 bolt fixing			
SX 50 Factory	19-20	F	EC 50	05	F	- front disc)	06-07	F	
SX 50 Limited Edition	14-16	F	SM 50	05	F	Geopolis 125 Executive/Non ABS			
Tuorno 50	03-04	F	Pampera 250	02	F	(AJP Calipers)	07-12	F	
ETX 125	99-01	F	Pampera 125/250/280	04	F	Geopolis 125 Urban/ABS			
RX 125	92-99	F	Pampera 125 (2T)	05-08	F	(AJP Calipers)	07-12	F	
Pegaso 125 "Kat"	94-95	F	Pampera 250	02-03	F	Jet Force 125 (All models)	03-07	F	
BENELLI			GENERIC/KSR			Satelis 125 Compressor (4T)	06-11	F	
Velvet 125/150 (Touring)	08-12	F	Toxic 50	07-08	F	Satelis 125 RS	07-12	F	
Velvet 250	99-12	F	Trigger X 50 (All Models/TR X 50)	06-18	F	Satelis RS 125 (AJP Caliper)	07-12	F	
Velvet 400 Dusk	03-04	F	Trigger SM 50 (All Models)	06-18	F	Satelis 125 Blacksat (AJP Caliper)	10-12	F	
BETA			Trigger 125 SM	08-09	F	Satelis Urban 125 (AJP Caliper/ABS)	07-12	F	
RR Enduro Alu 50/Motard Alu 50	04-08	F	Trigger 125 X	08-09	F	Satelis 125 Whitesat (AJP Caliper)	10-12	F	
RR Enduro 50	04-07	F	GILERA (Grimeca Calipers)			XPS Supermoto (17" front wheel			
RR 50 Enduro Racing	09-11	F	DNA 50	01-06	F	/260mm disc)	03-10	F	
RR 50 Enduro Factory	12-19	F	DNA 125/180	01-05	F	XPS Street (17" front wheel/			
RR 50 Motard Track/Racing (Spoke wheel)	14-20	F	125 VX 4T/180 VXR 4T	01-04	F	280mm disc)	03-09	F	
RR 50 Enduro	08-19	F	FX/FXR 125/180 Runner			Geopolis 250 (Urban/ABS/AJP Calipers)	07-10	F	
RR 50 Enduro Standard	09-13	F	(Rear drum brake model			Geopolis 250 (Executive/AJP			
RR Motard 50 Track (Cast Wheels)	08-14	F	/Grimeca front caliper)	97-02	F	Calipers/Non ABS)	07-10	F	
RR Motard 50 Skull	11	F	Coguar	00-01	F	Satelis 250 Urban (AJP Caliper/ABS)	07-12	F	
RR Motard 50 Standard			VXR 200 Runner (4T)	02-04	F	Geopolis 400 (Urban/AJP Calipers/ABS)	07-11	F	
(Cast wheel 5 spoke)	13-15	F	HONDA HM (Italy)			PIAGGIO/VESPA (Grimeca Calipers)			
RR Motard 50 Sport			CRE 50 Six/Baja/Derapage Brembo			Beverley B 125	03-06	F&R	
(Cast wheel 5 spoke)	14-20	F	caliper twin pin/41mm Paioli forks	95-02	F	Beverley 200	03-05	F&R	
RR 50 Standard	05-08	F	CRE 50 Baja/Derapage	01-02	F	Hexagon GT 250	98-99	F	
RR 50 Track (Spoke wheel)	14	F	CRE 50 Baja RR Up to			Hexagon LX 180	98-99	F	
Alp 125 (4T)	05-15	F	ZEN50XACEA7700324	07-09	F	Hexagon LXT 180	98-99	F	
RE 125 4T Enduro	09-10	F	CRE 50 Baja/Six/Derapage	03-09	F	Hexagon LX4 125	98-99	F	
RR 125 4T Enduro (A/C)	09-14	F	CRE 50 Baja RR			Skipper LX 125/150	98-99	F	
RR 125 4T Enduro (LC)	11-18	F	From ZEN50XACEA7700325	07-09	F	Super Hexagon GTX 125/180			
RR 125 Motard (4T)			CRE 50 Baja RR	10-12	F	(11" wheels)	00	F	
(A/C - Spoke Wheel)	08-14	F	CRE 50 Derapage RR			Skipper ST 125/150 4T			
RR Motard 125 4T (LC) (Cast wheels)	11-18	F	Up to ZEN50XACMA7700384	07-09	F	Grimeca Caliper	00-04	F	
Urban 125	08-15	F	CRE 50 Derapage RR			Super Hexagon GTX 250	00-02	F	
Urban 125 Special	09-15	F	From ZEN50XACMA7700385	07-09	F	GT 125 L Granturismo	03-06	F	
Alp 200 (4T)	05-15	F	CRE 50 Six Competition	07-08	F	GT 200 L Granturismo	03-06	F	
Urban 200	08-15	F	CRM 50 Derapage Competition	07-08	F	RIEJU			
Urban 200 Special	09-15	F	CRE 125 X	09	F	MRX 50 Pro/Top	04-08	F	
Alp 4.0 (4T/349cc)	05-15	F	CRM F 125 X	09	F	SMX 50 Pro Supermotard/Top	04-07	F	
CCM			HRD			RS2 NKD	05	F	
SR 40 Street Scrambler	07-09	F	GS 50			RS2 50cc Pro	06-09	F	
CPI			KEEWAY			SMX 50 Pro Street	06-08	F	
GTS 50/125/200	02-03	F	X Ray 50 Supermoto	07-09	F	SACHS			
GTR 50/125/200	02	F	TX 50	10-12	F	ZX 125 Enduro	01	F	
SX 50	06-07	F	TX 125	10-12	F	ZZ 125 Funbike	02	F	
DAELIM			TX 125 SM (17" f/wheel)	13-15	F	SHERCO			
ST 125	03	F	TX 200 (19" f/wheel)	13-14	F	EN 50 Champion Replica	08	F	
DERBI			MALAGUTI			Replica Cup SM 50	08	F	
GP1 50 Open	06-11	F	XSM 50 Supermotard	03-11	F	Enduro 50 (EN50)	08-09	F	
Mulhacen 125 (4T) Upto Ref No 7N001790			Madison 125/150/180	99-03	F	Enduro/Urban/SU 50cc(2T)			
Spoke wheel/2 pinpad fixing	07	F	Madison 125-3	06-09	F	(Spoke wheel)	08-13	F	
Senda R DRD	02	F	Madison R125	03-07	F	Black Panther SM 50	08-09	F	
Senda 125 Baja R (4T) (260mm disc)	06-12	F	Phantom Max 125/200	04-08	F	Supermotard 50	08-12	F	
Senda 125 Baja SM (4T) (360mm disc)	06-12	F	Madison 250 ie 3	06-10	F	Supermotard SM 50	08-13	F	
Senda DRD Racing 50 SM			Phantom Max 250	04-08	F	SM 0.5 Black Panther	08-10	F	
(300mm disc/Std caliper mounted)	04-11	F	Madison S200	04	F	City Corp 125 (All models)	08	F	
Senda DRD Racing 50 R			R 125 Madison	03-06	F	SM 1.25 F Black Panther (4T)	10-12	F	
(260mm disc/Std mounted caliper)	04-11	F	250 Madison	04-07	F	SE 1.25 F Enduro (4T)	10-12	F	
Senda DRD Racing 50 R			Password 250	05-11	F	SIAMOTO			
(Spoke Wheel/260mm F/disc)	11-12	F	X3M Motard (Cast wheels)	08-10	F	SX1 125	04	F	
Senda DRD Racing 50 SM			MBK			YAMAHA			
(Cast Wheel/260mm F/disc)	11-12	F	TZR 50 X Power	03-09	F	DT 50 X (Supermotard)	04-08	F	
Senda 125 SM (Twin headlight)	04-07	F	X-Limit Supermoto	03-09	F	TZR 50	03-16	F	
Senda R 125 Vin# SCIAIA	04	F	MH/MOTORHISPANIA			XT 125 X (3D62/3D64)	05-06	F	
Cross City 125	07-08	F	RYZ 50 Pro Racing Enduro	13-14	F	XT 125 X (13D2)	07	F	
FACTORY			RYZ 50 Pro Racing Supermotard	06-14	F	XT 125 X (13D4/13D6)	07-11	F	
RP 50	05	F	RYZ 50 Pro Racing Urban Bike	06-10	F				
YM 50	05	F	RYZ 50 Supermotard	06-10	F				
YR 50 Desert	04-05	F	Duna 125 Dual Plus Trail	08-10	F				
Chrono SM 50	04	F	Duna 125 Sports City Supermotard	08-10	F				
YR 125 4T	05	F	Duna Plus 125	14	F				
FANTIC			PEUGEOT						
Caballero 50 Regularita Casa	06-09	F	Elyseo 125/150 Rear Disc Model	03	F				
Caballero 50 Supersei Motard	06-09	F	Elystar 125/150 (3 bolt fixing						
Caballero 125 Regularita Casa	07-08	F	- front disc)	02-05	F				
Caballero 125 Supersei Motard	07-09	F							

FA196 101 x 39 x 9mm

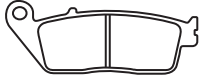

MATERIAL AVAILABILITY

FA	TT	V	R	HH	MXS	SXR	EPFA	GPFA	SFA	SFAC	SFAHH
✓		✓		✓			✓		✓	✓	✓

Brand	Model	Year	Type	Part No.	Material	Part No.	Material	Part No.	Material
BENELLI				VT 750 CV/C2V/CW/C2W/CX/C2X/CY/ C2Y/C1/C21/C31/C4-C8 'Shadow'	97-09	F	Cross Country	10-17	R
BMW	Imperiale 400	18	F	VT 750 C2BA/C2BB/C2BC/C2BE	97-09	F	Cross Country Tour	13-17	R
	C Evolution Electric	18-20	R	Shadow Black Spirit (Rear drum)	10-16	F	Cross Country 8 Ball	15-16	R
	C 600 Sport Scooter	12-15	R	VT 750 DC1/DC2 Black Widow	01-04	F	Cross Roads	10-11	R
	C 600 Sport Highline	13-15	R	VT 750 DC7/DC8 Shadow Spirit	07-09	F	Cross Roads Classic (Spoke Wheel)	13-14	R
	C 650 GT Scooter	12-20	R	VT 750 S (VT 750 SA/SB)	10-12	F	Cross Touring	13-14	R
	C 650 GT Highline	13-18	R	CBR 1000 FK/FL/FM/FN	89-92	R	Cross Roads 8-Ball (Cast Wheel)	14	R
	C 650 Sport Scooter	16-20	R	ST 1100 AN/AP/AR/AS Pan European			Gunner	15-17	R
	C Evolution (Scooter)	14-18	R	(ABS Model)	92-95	R	Hammer	08-11	R
				ST 1100 L/M/N/P/R/S/T/V/W/X/Y/1/2			Hammer S	08-17	R
BUELL	Blast	00-07	F	Pan European - Non ABS	90-02	R	Hammer 8 Ball	10-16	R
DAELIM	Roadwin R 125 (VJF 125)	08-14	F	VT 1100 CR/CS/CT/CV/CW Shadow	94-98	F	Hard Ball	12-13	R
	Roadtwin (VJ 125)	04-13	F	VT 1100 C2 (S/T/V/W/X/Y/1/2/3/4/5)	95-05	F	Highball (Cast & Spoke Wheel)	12-17	R
	VL 125 Daystar/125 L	03-14	F	VT 1100 C3 (W/X/Y)	98-00	F	Jackpot	10-16	R
	VT 125 Evolution	03	F	VT 1300 CXA Chopper			Judge	13-17	R
	VS 125 Evolution	01-04	F	(9 spoke cast wheel/non ABS)	10-12	F	Kingpin Tour	08-09	R
	(VJ 125) Roadwin	04-11	F	VTX 1300 S3/S4/S5/S6/S7/S8	03-08	F	King Pin	08-09	R
				GL 1500 'CV/CW/CX/CY/C1/C2 (F6C)'	97-03	R	Kingpin 8-Ball	08-12	R
HARLEY DAVIDSON	FXDR 114	18-20	F				Kingpin-Low	09	R
HONDA	NSS 125 Forza (2 Piston Caliper)	15-21	F	INDIAN			Magnum	15-17	R
	SH 125i (2 Piston Caliper/ABS)	14-21	F	Chief Classic (Spoke Wheel/ Nissin Calipers)	14-18	R	Vegas 8-Ball	08-17	R
	SH 150i (2 Piston Caliper/ABS)	14-21	F	Chief Vintage (Spoke Wheel/ Nissin Calipers)	14-20	R	Vegas	08-17	R
	CB 250 N/T/W/X/Y/1/4 "Two Fifty"	92-05	F	Chieftain (Cast Wheel/Nissin Calipers)	14-20	R	Vegas Low	08-09	R
	CN 250 3 (MF02) Fusion/Fusion X		F	Chieftain Dark Horse			Vegas Jackpot	08-09	R
	/Fusion X Special	03	F	Chieftain Limited (Cast Wheel/ Nissin Calipers)	16-20	R	Vision Street	08-09	R
	VT 250 Spada	89-	F	(Cast Wheel/Nissin Calipers)			Vision Tour (All models)	08-17	R
	VT 250 CR/CT/CV 'Magna'	95-97	F	Chieftain Limited (Cast Wheel/ Nissin Calipers)	17-20	R	Vision 8 Ball	10-12	R
	VTR 250 W/Y/1-7 (MC33)	98-07	F	Chieftain Limited (Cast Wheel/ Nissin Calipers)	17-20	R	Zach Ness Vegas	11-12	R
	VTR 250-9	09-10	F	Chief Dark Horse	14-20	R	W.K. BIKES		
	CBR 300 RA ABS	14-21	F	Roadmaster (Cast Wheel/Nissin Calipers)	15-20	R	WK 125 R (4T)	10-14	F
	NSS 300 D Forza (ABS)	18-21	F	Roadmaster Classic (Nissin Calipers)	17-18	R	WK 125 Sport	11-14	F
	NSS 350 AM Forza (ABS)	21-22	F	Roadmaster Elite (Nissin Calipers)	17-20	R	YAMAHA		
	SH 300i (2 Piston Caliper/ABS)	16-21	F	Springfield	16-20	R	VP 125 X-City (16P)	08-15	F
	SH 350i (2 Piston Caliper/ABS)	20-21	F	Springfield Dark Horse	18	R	YP 125 Majesty DX (Taiwan Production)	02	F
	CB 400 SS (SS2-N41)	01-05	F	Challenger 1800cc	19-20	R	YP 125 RA X-Max ABS		
	CL 400 (NC38)	98-03	F	Challenger Dark Horse 1800cc	19-20	R	(39D2/Nissin F/Caliper)	11-17	F
	FJS 400 D6/D7/D8	06-08	R	Challenger Limited 1800cc	19-20	R	YP 125 R (X-Max - Non ABS)		
	NV 400 DCY/DC1/DC2 (NC40)		F	LEXMOTO			(39D1/5) Nissin F/Caliper	10-15	F
	Shadow Slasher	00-02	F	Assault 125 Efi HJ125-J-E4	19-21	F	YP 125 X-Max Business (ABS)	11	F
	SW-T 400 (FJS 400 D9)	09	R	KYMCO			YP 125 R X-Max Sport	11-12	F
	SW-T 400 (FJS 400 A9/AB) (ABS)	09-16	R	Venox 250 (R20010/RA50AA /Carb Model)	00-03	F	YP 125R X-Max (2DM /Heng Tong R/Caliper)	14	F
	VRX 400 T (NC33)	96	F	Venox 250 (RFBR20011/RA50AD /Carb Model)	04-06	F	YP 125R X-Max (2DM/Brembo R/Caliper)	14-16	F
	CBF 500 4 (Non ABS Model)	04	F	Venox 250 (R20012/EFI Model)	07-14	F	X-Max 125 (2DM/Heng Tong R/Caliper)		
	CB 500 R/T	94-96	F	MBK			See- YP 125R X-Max X-Max 125 (2DM/Brembo R/Caliper)	14	F
	CB 500 F (Non ABS)	13-20	F	VP 125 Cityliner	08-10	F	YW 125 G Zuma	16-21	F
	CB 500 FA (ABS)	13-21	F	SUZUKI			See- YP 125R X-Max	14-16	F
	CB 500 X (Non ABS/Twin)	14-20	F	VL 1500 BTL3/BTL4/BTL5 (CT 1500 BT Intruder)	13-15	F	XP 125 RA X-Max - Iron-Max (ABS)	16	F
	CB 500 XA (ABS/Twin)	14-21	F	SYM			X-Max 125 Momo Design	14-15	F
	CBR 500 R (Non ABS/Twin)	13-20	F	Cevalo B9A (125cc 4T)	10	F	XC 155 F/G SMax	15-16	F
	CBR 500 RA (ABS/Twin)	13-21	F	TRIUMPH			VP 250 X-City (5B2)	07-16	F
	CMX 500 REBEL	17-21	F	Adventurer	96-01	F&R	XP 250 R X-Max (37P)		
	FJS 600 1/2/D3-D7/A3-A7 Silverwing	01-09	R	Bonneville (865cc/Cast wheels)	09-15	F	(Nissin front caliper/Non ABS)	10-13	F
	SW-T 600 (FJS 600 AB) (ABS)	11-16	R	Bonneville Newchurch			XP 250 R X-Max (2PLI)		
	XL 600 VR/VT "Transalp"	94-96	F	(865cc/Cast wheels)	15	F	Non ABS (Nissin front/Brembo Rear)	14-15	F
	FMX 650 5/6	05-08	F	Bonneville SE (865cc)	09-13	F	YP 250 R X-Max Sport	11	F
	DN-01 (680cc) (NSA700 A8/A9)	08-11	R	Legend TT	98-01	F&R	YP 250 R X-Max ABS	11-16	F
	CTX 700 DE-DCT	14-21	F	Speedmaster (765cc/Carb)	03-04	F	YP 250 R X-Max ABS	14-15	F
	CTX 700 N-DCT	14-21	F	Speedmaster (865cc/Carb)	05-07	F	YP250 R X-Max (2DL/Non ABS /Heng Tong R/Caliper)	14-16	F
	NC 700 S (Non ABS)	12-13	F	Speedmaster (865cc/EFI)	11-16	F	X-Max 250 (Non ABS/Heng Tong R /Caliper/2DL) - See YP250 R X-Max	14-16	F
	NC 700 X (Non ABS)	12-13	F	Thunderbird	95-03	F&R	XP 250 RA X-Max - Iron-Max (ABS)	16	F
	CBR 750 FJ 'Superaero'	-88	R	Thunderbird Sport	98-03	F&R	X-Max 250 Momo Design	14-15	F
	NC 750 S	14-15	F	Tiger 855i (From VIN 71699)	98-99	F&R	XC 300 Versity	06	F
	NC 750 S ABS	14-18	F	Tiger 885cc	92-99	F&R	XP 400 X-Max Momo Design ABS	15	F
	NC 750 S ABS DCT	14-18	F	Tiger 955cc Up to VIN 198874	00-04	F&R	XP 400 RA X-Max - Iron Max (ABS)	16	F
	NC 750 X	14-15	F	from VIN 198875	05-06	F	YP 400 R X-Max (Non ABS)	13-16	F
	NC 750 X ABS	14-21	F	VICTORY			YP 400 RA X-Max (ABS)	13-18	F
	NC 750 X ABS DCT	14-21	F	Arlen Ness Victory Vision	09-12	R	MT-01 (1670cc)	05-10	R
	NC 750 Integra Scooter - DCT (NC 750 D)	14-21	F	Boardwalk (Spoke Wheels)	13-15	R	MT-01S (5YUR)	09	R
	NM4 Vultus (NC 750 J)	15-17	F	Cory Ness Jackpot	08-10	R			
	VF 750 CP/CR/CS/CT/CV/CW/CX	93-99	F	Cory Ness Victory Cross Country	11-12	R			
	VFR 750 FJ/FK/FL/FM/FN/FP/FR/FS/FT/VS	88-97	R						

BUYERS GUIDE

DO NOT REFIT ANY SHIMS/INSULATORS TO EBC PADS FROM ORIGINAL PADS UNLESS INSTRUCTED ON NOTE ON PAD PACKAGING AND ON FA DRAWING ASSOCIATED WITH THAT PAD.

FA197 A 96.5 x 42 x 9mm
 B 77.5 x 42 x 9mm

MATERIAL AVAILABILITY											
FA	TT	V	R	HH	MXS	SXR	EPFA	GPFAX	SFA	SFAC	SFAHH
✓				✓			✓	✓	✓	✓	✓

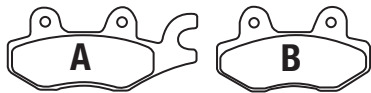

BRAKE PAD BUYERS GUIDE

DO NOT REFIT ANY SHIMS/INSULATORS TO EBC PADS FROM ORIGINAL PADS UNLESS INSTRUCTED ON NOTE ON PAD PACKAGING AND ON FA DRAWING ASSOCIATED WITH THAT PAD.

AJS												
Crazy Naked 50	10-11	F	SP R 125 (Motorcycle)	10-12	R	Silverblade 125				10-11	F&R	
Regal Raptor DD 100 E	04-06	R	HARTFORD			RKS 150				12-14	F	
Bobber 125 (Custom)	10-15	R	VR 125/150 H/X/Z	04	R	RKS 200				12-14	F	
Daytona 125	13-15	R	HERO HONDA			250 Blackster				14	R	
DD 125 E Mk2 Regal Raptor (Cast Wheels)	10-14	R	Magellan 125	06	F	250i Silverblade				13-14	F(right)	
EOS 125 Regal Raptor	09-15	R	Pluto 125	06	F	KREIDLER						
JSM 125 Supermotard	10-14	R	HP POWER			50 Supermoto (2T)				14-15	R	
JSM 125 Trail	13-14	R	Nickel 150 (4T/2V)	10-11	R	125/250 Insignio (4T)				14-15	F (Left)	
NKT 1-125/2-250 Naked	08-09	F&R	Barum 260 (4T/2V/LC)	10-11	F	KYMCO						
Regal Raptor DD 125 E	04-06	F	HYOSUNG			Activ 50/110/125				04-06	F	
Regal Raptor DD 250 E	04-09	F	MS3 (125cc)	07-09	F&R	Bet & Win 50/Dink Sports 50				02-06	F	
EOS 350	13-14	R	MS3 250i	07-09	F&R	Dink 50/Spacer 50/Yager 50				98-06	F	
350 E-9PB	13-14	R	ITALJET			Dink Classic 50 Euro 2				03	F	
SPT 350	13-14	R	50 it Scooter	09	F	Dink 50 (4T)				07-14	F	
HONDA			LEXMOTO			Grand Dink 50 (2T)				04-15	F	
CB 50 V/W Dream 50	97-98	F	FMX 125 (WY125T-108)	15-18	R	Jetix 50				10-15	R	
NSR 50 RV/RW/RX/RY	97-00	F	Matador 125 EFI (ZS125T-40-E4)	13-17	R	K-Pipe 50				12	F	
NSR 50 V (AC10-180)	97	F	Michigan 125 EFI (ZS125-79-E4)	13-20	R	Kymcosento 50i				13	F	
NSR 50 X (AC10-190)	99	F	Venom 125 SK125-22-E4	21	F	Newsento 50i				13	F	
XR 50 M5 (AD14) Motard	05	F	XTR-S 125	13-18	F	Super 9 50 (LC)				00-07	F	
NSR 75 N/P/R/X/Y (N5-1/NSR 80)	92-00	F	MODENAS			Super 9 (A/C) 50				00-07	F	
NSR 80 P/R/S (HC06)	93-95	F	Kriss 115		F	Yager 50				07	F	
NSR 80 V (HC06-170)	97	F	Dynamic 125	08-09	F&R	Bet & Win 125/150				00-06	F&R	
NSR 80 X (HC06-180)	99	F	Kristar 125	08-11	F&R	CK 125 Pulsar (RJ25CB)				01-07	F	
Astra Supra NF 100	99	F	X-Cite 135	09-10	F&R	CK 125 Pulsar 11 (KE25RF)				08-10	F	
XR 100 M5 (HD13) Motard	05	F	SILENCE Electric Scooters			CK 125 Pulsar S				11-15	F	
CB 125 F (GLF 125 1WHF)	15-16	F	S01	21	R	CK 1 125 (4T/KT25AA)				14-15	F	
LS 125 RY	00-	R	S02	21	R	Cruiser 125				99	F	
VT 125 CX-C8 'Shadow'	99-08	F	S02LS	21	R	Dink 125/150/Spacer				97-04	F&R	
XL 125 V1-VA 'Varadero'	01-11	F	YAMAHA			Dink Classic 125/150				02	F&R	
NSR 150 RR (Malaysian market)	F&R		TZR 50 Thunderkid (5DU1/3)	97-00	F	Dink LX 125/150				98-00	F&R	
TA 200 (TA Shadow)	02-05	F&R	Crypton-R New 110cc	04	F	Dink 125 i				06-15	F&R	
CBF 250 4/7	04-07	F	YS 250 Fazer (Brasil) (1S41/2/3)	06-08	F	Grand Dink/Miler 125/150				01-07	F&R	
CB 300 R10	10	F	KAWASAKI			Grand Dink 125				12-13	R	
ARCTIC CAT			BN 125 A3-A5/A6F/A7F Eliminator	00-07	F	Hipster 125/150				99-06	F	
DVX 50 (Y6)	06	R	Kaze-R New 112cc	04	F	Jetix 125				10-15	R	
DVX 90 (Y12 4 Stroke)	06	R	Ninja 125	16-21	F&R	KR 125 Sport Quannon				07-08	F&R	
BAJAJ			Z 125	16-21	F&R	K-Pipe 125				12-21	F	
Discover 125 (Disc Model)	14-16	F	ZX 130 R Kaze	08-10	F	Movie XL 125/150				01-09	F	
Avenger 150 Street (Cast Wheel)	15-16	F	Z 250 SL (Naked/Non ABS)			KR 125 Quannon Naked				10-15	F&R	
Avenger Cruise 220 DTS-I (Spoke Wheel)	15-16	F	BR 250 EFF/EGF	15-16	F&R	KR 125 Quannon Sport				07-13	F&R	
Avenger Cruise 220 DTS-I (Spoke Wheel)	08-14	F	Z 250 SL (Naked/ ABS)			Like 125 (D20000)				09	R	
Avenger 220 Street (Cast Wheel)	15-16	F	BR 250 FFF/FGF/FHF	15-17	F&R	Like 125				10-14	R	
BENELLI			Ninja 250 SL (BX 250 AFF/AFS/AFSA			Movie 125i				12-13	F	
Caffe Nero 250	08-14	F(left)	- KRT Edition - Non ABS)	15	F&R	Sector 125				98-01	F	
CCM			Ninja 250 SL (BX 250 BFF/BFS			Spike 125 R				04-06	F&R	
RL 125	08-09	F	/BGF/BGFS - ABS)	15-16	F&R	Straight 125				05-06	F	
SM 125	08-09	F&R	Ninja 250 SL (BX 250 BFS/BGSA			Yager 125				00	F&R	
TL 125	08-09	R	KRT/ABS Edition)	15-16	F&R	Yager GT 125				07-13	F&R	
GPI			EX 250 K8F/K9F/KAF/KBF/KBFA			Zing 125/150 Custom				97-13	F	
125 Prince	01	F	/KCF Ninja 250 R	08-12	F&R	Agility 150 R16 (C30000) (16" wheels)				08-12	R	
X Large 125/300	11-12	F&R	EX 300 AEFA/AFFA/AGFA Ninja 300			Jetix 150				10	R	
DAELIM			Special Edition Non ABS	14-16	F&R	Like 150 I Inc Noodoe				20-21	R	
S-Four 50cc ES 50	10-12	F	EX 300 ADF/AEF/AFF Ninja 300			Spade 150 I				20-21	R	
Roadwin (VJ 125)	04-13	R	Non ABS	13-15	F&R	Activity 200i R16				10-12	R	
Roadsport R 125 (VJF 125)	08-14	R	EX 300 BDF/BEF/BFF/			Dink 200 i				06-15	F&R	
S3 125 (SV 125)	10-11	R	BGF Ninja 300 ABS Model	13-16	F&R	Like 200 i				09-15	R	
SQ 125 Freewing A2	06	R	EX 300 BEFA/BFFA/BGFA Ninja			Yager 200i				07-13	F&R	
SU 125 Delfino	07-11	F	Special Edition With ABS	14-16	F&R	Bet & Win 250				00-06	F&R	
SQ 250 Freeway S2	06	R	KLE 300 CHF/CJF Versys-X 300 ABS	17-20	R	People 250				03-06	F	
Roadwin R 250 Fi (VJF 250)	08-11	R	KLE 300 BHF Versys-X 300 Non ABS	17-20	R	People 250 S				06-08	F(right)	
Roadsport 250 (VJF 250)	10-14	R	Z 300 Non ABS - ER 300 AFF/AGF			Yup 250				03-06	F	
VL 250 Daystar	13-14	R	/AGFA	15-16	F&R	Yup 250				04-06	R	
GARELLI			Z 300 ABS - ER 300 BFF/BGF/BGFA	15-20	F&R	People S 300 i				08-10	F(right)	
Tiger 125	07	F&R	Ninja 400 (EX 400 GJF/GJFA- ABS)	18-21	F&R	LEONART						
GENERIC/KSR			Z 400 ABS	18-21	R	Bobber 125				13-14	R	
Code 125	17-20	R	KLR 650 (KL 650 E8F/E9F)	08-09	R	Daytona 125/350				13-14	R	
Worx 125/150 (4T)	12-16	F	KLR 650 ABS	21	R	Raptor 125/250				13-14	R	
GOES			W 800 ABS	16-21	R	Spyder 125				13-14	R	
G 125 M Big Wheel	08-09	R	KEEWAY			Bobber 350				13-14	R	
			125i Silverblade	13-15	F(right)	MOTOM						
			RKS 125	12-15	F	ANA 50				08-09	R	

FA197 A 96.5 x 42 x 9mm B 77.5 x 42 x 9mm

ANA 151	08-09	R	G Max 125 (Wave disc)	08-12	R	(BA-CJ45SA)	07-08	F(right)
MZ/MUZ			G Max 250	06-08	R	AN 250 Skywave/Type D (BA-CK44A)	07-08	F(right)
RT 125	02-07	F&R	QUADZILLA					
SM 125	02-07	R	WK 300	06-08	R	AN 250 8 Skywave SS (CJ46A)	08	F(right)
SX 125	02-07	R	SFM			AN 400 K7/ZK7/K8/ZK8/K9/L0/L1-L4	07-15	F(right)
NIPPONIA			ZX 125 Enduro (Spoke Wheels)	13-15	R	Burgman/Non ABS/Skywave	07-15	F(right)
Brio 50 (4T)	12-13	R	ZZ 125 Enduro (Spoke Wheels)	13-15	R	AN 400 Skywave/Burgman/ABS	09-20	F(right)
Arte 125 (4T)		F&R	SINNIS			W.K. BIKES		
Brio 125 (4T)	12-15	R	Stealth 125 QM125-2D	08-10	F(right)	Trial 125	11-15	F
Dion 125 (4T)	13-15	R	SYM			Wasp 125 (4T)	13-15	R
Arte 150 (4T)		F&R	Euro MX 125 (Rear disc model)			WK 125 R (4T)	10-14	R
Dion 150 (4T)		R	(HF12 W3-6 Euro 2)	06-09	R	WK 125 Sport	11-14	F
PEUGEOT			Shark 4VR-125	01-02	R	WK Jetmax 250 (4T)	10-14	F(right)
Django 50 Heritage (2T)	14	F	XS 125 K	07-13	F	GTR 300	13-15	R
Django 50/125 Heritage (4T)	14	F	SUZUKI			WUYANG		
WTR 125	08	F	FL 125 SDWK7/SDWK8 Address /Underbone	07-10	F	WY 125 24B	06-07	F
Metropolis 400 RS (3 Wheel Model /Nissin Caliper)	17-18	R	FX 125		F	XOR		
Metropolis 400 RX-R (3 Wheel Model /Nissin Caliper)	17-18	R	Shogun-R FD-112	04	F	XO 2 (4.0KW)	13-14	F
Metropolis 400 Allure (3 Wheel Model /Nissin Caliper)	17-18	R	UH 125 L4-L6 Burgman (Non ABS)	14-16	F	XO 2 (8.0KW)	13-14	F
			UH 125 AL4-AL8 Burgman (ABS)	14-21	F	YAMAHA		
			UH 200 L4-L6 Burgman (Non ABS)	14-16	F	YBR 250 (5D11/3/4)	07-11	F
			UH 200 Burgman ABS	14-21	F	ZONTES		
PGO						ZT125-5A Monster	09-15	F&R
G Max 125	06-08	R	AN 250 Skywave Type M			ZT125-8A Tiger	09-15	F

FA198 60.18 Over lugs x 51.8 x 6mm

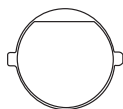

MATERIAL AVAILABILITY											
FA	TT	V	R	HH	MXS	SXR	EPFA	GPFA	SFA	SFAC	SFAHH
✓											

CZ / JAWA											
All Disc Models											03-04 F
125 Travel				03-04		F	350 Chopper				03-04 F
125 Chopper				03-04		F	350 Tramp				03-04 F
							350 Californian				03-04 F

FA199 94 x 40.5 x 10mm



MATERIAL AVAILABILITY											
FA	TT	V	R	HH	MXS	SXR	EPFA	GPFA	SFA	SFAC	SFAHH
✓		✓		✓					✓	✓	✓

YAMAHA											
TDR 125 (4GW/GX 1/2/3/4)	93-03	F									XJ6 SP 13 F
XV 125 'Virago'	97-00	F									MT-03 (660cc) 06-12 F
XVS 125 Dragstar	00-03	F									XV 1100 Virago 99 F
SR 125	97-03	F									XVS 1100 Dragstar 99-04 F
TZR 150 R (4AP2)	00	F									XVS 1100 A Dragstar Classic 00-07 F
CP 250 (EB71) Maxam/Morphus	05-08	F									XVS 1300 A Midnight Star 07-13 F
XV 250 S 'Virago'	95-00	F									XVS 1300 ACFD Midnight Star/Casual
XVS 250 Dragstar	01-04	F									Full Dresser (With Handbar Fairing) 14-16
YP 250 DX/A/Majesty	98-03	F									ADIVA SCOOTERS
XJR 400 (4HM3/4HM5/4HM6/4HM9 /4HMA/4HMB) Brembo calipers	95-99	F									AD 125 09-11 R
YP 400 Majesty (Non ABS)	05-13	F									AR 125 10-11 R
YP 400 Majesty (ABS)	07-13	F									AD 200 09-11 R
XP 500 T-Max (5VU1/2)	04-07	F									AR 200 10-11 R
FZ6 Naked/Non ABS 2 Piston Caliper (1B3/1B3D)	04-07	F									ITAJET
FZ6-NS Naked/Non ABS /2 Piston Caliper	05-06	F									Jupiter 125/150 02 F
FZ6-Fazer (Half Fairing/Non ABS /2 Piston Caliper) (5VX/5VXL)	04-07	F									Jupiter 250 02-03 F
FZ6 - Fazer (ABS/Half Fairing /2 Piston Caliper)	06-07	F									LINHAI
XJ 600 S/N	98-03	F									Monarch 125/150 T 06-07 F
XJ6-F Diversion (600cc) (Full Fairing-1CW) (Non ABS/ABS)	10-15	F									Main Street 300cc (Scooter) 07-08 F
XJ6-N (600cc) (Naked 20S) Non ABS/ABS	09-15	F									MBK
XJ6-S Diversion (600cc) (Top Fairing - 36C) ABS/Non ABS	09-15	F									YP 250 Skyliner 96-99 F
											YP 250 Skyliner 250 (+ABS) 00-02 F
											YP 400 Skyliner 04 F
											SINNIS
											Max 125 QM 125-2V 08-09 F
											JS 125-6C SC 125 12-14 F

FA200 104 x 62.5 x 11mm

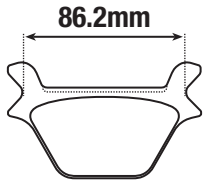

INCLUDES STEEL SLIDER SHIMS

MATERIAL AVAILABILITY												
FA	TT	V	R	HH	MXS	SXR	EPFA	GPFA	SFA	SFAC	SFAHH	
✓		✓		✓			✓					

HARLEY DAVIDSON

FXST/FXSTB/FXSTC/FXSTS/FLST/
 FLSTC/FLSTF/FLSTS/FLSTN Late 87-99 R FXD/FXDL/FXDWG/FXR/FXRS/
 XL/XLH/XLCH/XLS/XLX Late 87-99 R FXRT/FXRD/FXLR Late 87-99 R

FA201 104 x 62.5 x 11.5mm

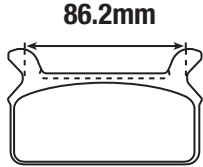

MATERIAL AVAILABILITY												
FA	TT	V	R	HH	MXS	SXR	EPFA	GPFA	SFA	SFAC	SFAHH	
✓		✓		✓								

HARLEY DAVIDSON

FLT/FLHT/FLHTCI 86-99 R
 FLHR/FLHRCI 94-99 R

FA203 81 x 42 x 9.5mm



MATERIAL AVAILABILITY												
FA	TT	V	R	HH	MXS	SXR	EPFA	GPFA	SFA	SFAC	SFAHH	
✓				✓								

HONDA

CBR 600 FM/FN/FP/FR 91-94 F

FA208 78 x 41 x 9mm



MATERIAL AVAILABILITY												
FA	TT	V	R	HH	MXS	SXR	EPFA	GPFA	SFA	SFAC	SFAHH	
	✓		✓		✓		✓					

ALFER

VRE 125 4T	98-	R	Spitfire Six	19-20	R	TC 450					02-04	R
Divertida 250 Super Motard	01-	R	Spitfire Six Stealth Edition	19-20	R	TE 450					02-05	R
Diferente Enduro	01-	R	Spitfire Stealth	19-20	R	TC/TE 510					04-05	R
VR 250	98-13	R	GAS GAS			SM 510 R					05-06	R
			EC 125/250/300/200 Enduro	97-99	R	SM 570 R					01-04	R

APRILIA

650 ie	01-04	R	Enforcer four 400/501/600 2 Quad	99	F	TC/TE 570					01-04	R
--------	-------	---	----------------------------------	----	---	-----------	--	--	--	--	-------	---

BENELLI

BX Cross (449cc)	07-12	R	HIGHLAND			TE 570					01-04	R
BX Enduro (505cc)	08-12	R	950 V2 Outback	00-04	R	TC/TE 610 E					95-04	R
BX 570 Motard	08-10	R	950 V2 Motard	00-04	R	LT 610					00-01	R

CCM

404 E	03-04	R	HRD			SM 610					98-00/05	R
-------	-------	---	------------	--	--	--------	--	--	--	--	----------	---

HUSABERG

404 DS	03-04	R	GS 50		R	SM 610 R					00	R
404 DS Supermoto	03-04/07-08	R	HUSABERG			SM 610 R/E					05-07	R
404 DS Trail	07-08	R	FE/FS 450 E	06-08	R	SM 610 S (Radial caliper)					06	R
CMX 450 (MX)	08	R	FS 450 R	06	R	SM 610 S (4 bolt front disc)					02-06	R
450 FS Trail	07-08	R	FE 550 E	06-07	R	SM 610 ie					07-09	R

HUSQVARNA

644 DS Supermoto	04	R	FE 650 E	06-08	R	TC 610					00	R
644 DS	04	R	FS 650 C	06-08	R	TC 610 E					95-99	R
R 30 (Spoke & Mag)	02-04	R	HUSQVARNA			TE 610					00	R
R 35/R35S	06-08	R	CR 125	95-04	R	TE 610 E					95-03	R
FT 35 S (400cc) (DRZ 400 Motor)	07-08	R	SM 125 S Supermotard	98-10	R	TE 610 IE					06-09	R

CF MOTO

250 NK	20	R	SM 125	98-00	R	SMR 630					06	R
250 SR	21	R	SM 125 S (4 bolt fixing) (2T)	02-13	R	TE 630					10-12	R
250 NK	20	R	SMR 125 (4T)	11-13	R	STR 650 CRC					07	R
300 SR	21	R	SMS 4-125cc (4T)	11	R	701 Enduro					16-20	R
650 MT	21	R	Svartpilen 125cc 4T	21	R	701 Enduro LR					19-20	R

FACTORY

YR 250	03	R	TE 125 (4T)	11-13	R	701 Supermoto					16-20	R
--------	----	---	-------------	-------	---	---------------	--	--	--	--	-------	---

CCM

604E Dual Sport/Supermoto/RS	98-03	R	WRE 125	93-13	R	701 Vitpilen					18-20	R
604E R30	02-04	R	WR 125	95-08	R	701 Svartpilen					18-20	R
600 Spitfire	19	R	CR 250	95-04	R	KRAM-IT (KRAMER)						
Spitfire Bobber	19-20	R	TE 250	02-05	R	GS 250					00-	R
Spitfire Bobber Stealth Edition	19-20	R	TC 250	02-04	R	SM 250					00-	R
Spitfire Foggy Edition	19-20	R	WR 250	92-11	R	SMR 250					00-	R
Spitfire Foggy Edition S	19-20	R	WR 250 2T	09-13	R	KTM						
Spitfire Foggy Stealth Edition	19-20	R	WR 300	06-11	R	LC2 125					96-98	R
Spitfire RAFBF 100	19-20	R	WR 300 (2T)	11-13	R	Sting 125					97-99	R

BRAKE PAD BUYERS GUIDE

DO NOT REFIT ANY SHIMS/INSULATORS TO EBC PADS FROM ORIGINAL PADS UNLESS INSTRUCTED ON NOTE ON PAD PACKAGING AND ON FA DRAWING ASSOCIATED WITH THAT PAD.

FA208 78 x 41 x 9mm

Contd.

EXC 250	95-03	R	LC4 625 SC Supermoto	02	R	125/250 Enduro	95-00	R
EXC 300	00-03	R	SMC 625	04-06	R	300 Cross	95-00	R
EXC 350	94-95	R	SXC 625	03-06	R	300 Enduro (2T)	95-00	R
SX 360	96-97	R	LC4-E 640 Enduro/Supermoto	00-06	R	400 Cross (4T)	95-00	R
EXC 360	96-97	R	LC4-E 640 (Central Single Pin Fixing)	03	R	530 Cross (4T)	98-00	R
SX 380	98-03	R	LC4-E 640 (2 pin fixing)	04-06	R	VERTEMATI		
EXC 380	98-03	R	LC4 640 Adventure R	99-02	R	All models	99-04	R
Duke 400 LC4	94-98	R	LC4 640 Adventure	03/05-07	R			
SC 400	96-99	R	LC4 640 Adventure R	04	R	VOR		
EGS/EGS-3/LSE 400	96-99	R	SM 640 LC4	05	R	All models	99-04	R
SX 400	00-02	R	640 LC4 Adventure	03-07	R	YAMAHA		
EXC/EGS 400 (USD)	00-03	R	SMC 660 Supermoto	03-04	R	TT 600 R (5CH1/5CH2/5CH3)	97-02	R
EXC 400 Racing (USD)	00	R	SMC 660	05-06	R	TT 600 RE (5CH5)	04	R
LC4-E 400 Enduro	00-01	R	690 Enduro R	09-20	R	TT 600 E (4LW3/4LW4/4GV4/4GV5)	94-01	R
SX 440	94-95	R	690 Enduro R (ABS)	14-20	R	TT 600 K From 4GV 003404		
EXC 440	94-95	R	690 Enduro	08-20	R	(Brembo rear caliper)	95-96	R
EXC 450	03	R	690 SMC R (ABS)	14-20	R	XT 660 Z Tenere (Non ABS)	08-15	R
MX 500	95	R	MAICO			XT 660 ZA Tenere (ABS)	11-15	R
EXC 525	03	R	500 MX/Enduro	99	R	XT 700 Z Tenere	19-21	R
SX 520	01-03	R	S.W.M.			ZERO		
EXC 520	01-03	R	Gran Milano Special (4T)	15	R	Zero DS (ZF8.5/ZF11.4)		
MXC 525 (Desert Racing)	03-04	R	Super Dual T 600	16-21	R	(Nissin F/J.Juan R Calipers)	14	R
MXC 550	96	R	Super Dual GT 600	16-21	R	Zero FX (ZF2.8/ZF5.7)		
Duke 620 LC4	94-98	R	RS 650 R	16-18	R	(Nissin F/J.Juan R Calipers)	14	R
SX EXC/EGS 620	95	R	SM 650 R	16-18	R	Zero S (ZF8.5/ZF11.4)		
SX 620	96-99	R	TM			(Nissin F/J.Juan R Calipers)	14	R
SC 620 Supercompetition	96-00	R	80 Enduro	96-00	R	Zero SR (ZF11.4)		
EGS/EGS-E/LSE 620 Enduro	96-99	R	80/85 Cross	96-01	R	(Nissin F/J.Juan R Calipers)	14	R
EGS-E 620 Adventure/Rallye	99	R	80/85/100 (Big wheel)	02-04	R	Zero FX (ZF2.8/ZF5.7)		
LC4 620 SC Supermoto			Junior 80/85/100 Cross (Small wheel)	02-04	R	(J.Juan F&R Calipers)	15	R
/Supercompetition	00	R	125/250 Cross	95-00	R			

FA209/2 109 x 41.5 x 7.5mm

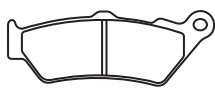

MATERIAL AVAILABILITY

FA	TT	V	R	HH	MXS	SXR	EPFA	GPFA	SFA	SFAC	SFAHH
✓		✓		✓			✓		✓		✓

APRILIA			G 650 GS (R131) (Single cylinder								19-21	R
Moto 6.5	95-01	F	/chain drive/cast wheel)	09-15	F	(Disc has fixed bobbins)					19-21	R
Pegaso 650/650 IE	97-04	F	G 650 GS Sertao (Spoke wheels)	12-14	F	R 1250 RS					19-21	R
Pegaso 650 Trial	06-08	F	G 650 Xchallenge	06-09	F	R 1250 R					19-21	R
ETV 1000 Caponord			G 650 Xcountry	06-09	F	R 1250 RT					19-21	R
(Non ABS - Bolt fixing)	01-03	F	F 700 GS	13-18	F	R 1250 RT SE					19-21	R
ETV 1000 Caponord Rally			F 750 GS	16-20	F	R 1250 RT LE					19-21	R
(Non ABS - Bush fixing)	03	F	F 750 GS Edition 40	20-21	F	K1600 B Bagger					17-21	R
ETV 1000 Caponord (ABS - Bush fixing)	04-07	F	F 800 GS	08-18	F	K1600 B Grand America					18-20	R
BENELLI			F 800 GS Adventure	12-18	F	K 1600 GT					11-20	R
TRK 502	17-20	F	F 800 GS (30 Years GS)	11	F	K 1600 GT SE					12-15	R
BIMOTA			F 800 GS Triple Black	12	F	K 1600 GTL					11-20	R
DBX 1100 (MX)	12-14	F&R	F 800 GS Trophy	12	F	K 1600 GTL Exclusive					12-16	R
BMW			F 850 GS	16-20	F	BRAMMO						
C1 125	99-03	F	F 850 GS Edition 40	20-21	F	Enertia					12-13	F
C1 200	01-03	F	F 850 GS Adventure	16-20	F	CCM						
F 650 (E169/0161) Standard	09/93-96	F	F 850 GS Adventure Edition 40	20-21	F	GP 450 (4T)					13-15	F
F 650 (E169/0162) (Funduro			HP2 1200 Enduro	05-09	F	CF MOTO						
/High Screen) (19" front wheel)	97-00	F	R 1200 GS (K50) (Liquid Cooled			650 NK 7B					17-19	F
F 650 CS Scarver (K14/0174/0184			/Radial Mount Caliper)	13-18	R	DUCATI						
Belt Drive/17" wheels cast)	00-03	F	R 1200 GS Adventure			400 Scrambler Sixty 2					16-21	F
F 650 CS Scarver (K14/0177/0187			(Inc TE/XE Models/K51/LC)	14-18	R	Diavel ABS					11-18	R
Belt Drive/17" wheels cast)	04-07	F	R 1200 R (Disc has fixed bobbins)	15-18	R	Diavel Carbon ABS					11-18	R
F 650 GS (R13/0172/0182)			R 1200 R Sport (Disc has fixed bobbins)	15-18	R	Diavel Chromo ABS					12	R
19" front wheel	99-03	F	R 1200 RS (Disc has fixed bobbins)	15-18	R	Diavel AMG					11-12	R
F 650 GS Dakar (R13/0173/0183)			R 1200 RS Sport (Disc has fixed bobbins)	15-18	R	Diavel Strada					13-14	R
21" front wheel	99-03	F	R 1200 RT (K52 Radial F/Caliper/LC)	14-18	R	Diavel Dark					13-14	R
F 650 GS (R13/0175/0185)			R 1250 GS (Disc has fixed bobbins)	19-20	R	Diavel Diesel (1200cc)					17-18	R
Single Cylinder 19" front wheel	04-07	F	R 1250 GS Edition 40	20-21	R	XDIAVEL					16-18	R
F 650 GS Dakar (R13/0176/0186)			R 1250 GS Adventure	19-20	R	XDIAVEL S					16-18	R
21" front wheel	04-07	F	R 1250 GS Adventure Edition 40	20-21	R	XDiavel Diesel (1262cc)					17-18	R
F 650 GS (K72/0218/0228)			R 1250 GS TE (Disc has fixed bobbins)	19-20	R	1262 XDiavel					16-21	R
(798cc Twin Cylinder/Cast Wheels)	07-12	F	R 1250 GS Exclusive TE			1262 Xdiavel S					16-21	R
F 650 GS (30 Years GS)			(Disc has fixed bobbins)	19-20	R	1262 Xdiavel Dark					21	R
(Twin Cylinder 798cc/Cast Wheel)	11	F	R 1250 GS Rallye			1262 Xdiavel dark Star					21	R
F 650 ST (E169/0163/168) Strada			(Disc has fixed bobbins)	19-20	R	Paul Smart 1000 Limited					06	F
(18" front wheel/low screen)	97-00	F	R 1250 GS Rallye TE			Paul Smart 1000 LE (992cc)					06	F
						Classic Sport Biposto (992cc)					07	F

FA209/2 109 x 41.5 x 7.5mm

GT 1000 (992cc)	07-10	F	LC4 640 Adventure R	04	F	Granpasso 1200	08-13	F
GT 1000 Touring (992cc)	09	F	LC4 640 Adventure	05-07	F	Scrambler 1200	10-13	F
Sport 1000 S (992cc)	07	F	690 Enduro R	09-20	F	ROYAL ENFIELD		
Sport 1000 S	07-09	F	690 Enduro R (ABS)	14-20	F	535cc Continental GT (Non ABS)	13-16	F
Sport Classic 1000 (992cc)			690 Enduro	08-20	F	535cc Continental GT (ABS)	17-21	F
(Monoposto - Japan/Biposto - Europe)	06-08	F	690 Rally Factory Replica	07-09	F	Interceptor 650 Twin	18-21	F
Multistrada V4	21	R	950 Adventure S	02-06	F	Continental 650 twin	18-21	F
Multistrada V4 S	21	R	950 Adventure S	03-06	F	SWM		
Multistrada V4 Sport	21	R	950 R Superenduro	06-08	F	Super Dual T 600	16-21	F
1200 Multistrada ABS (Single Pin F/Caliper)	15-18	R	990 Adventure S (Non ABS)	06-08	F	Super Dual X 600	16-21	F
1200 Multistrada Enduro	16	R	990 Adventure R (Non ABS)	09-12	F	TRIUMPH		
1200 S Multistrada	15-18	R	MOTO GUZZI			Note - Use FA209/2HH only		
1200 S Multistrada Pikes Peak	16-17	R	940 Belagio	07-13	F	on this Triumph fitment		
1200 S Multistrada D air	15-17	R	1100 California Aluminium	02-05	R	Rocket III 2300cc	04-09	R
1200 S Multistrada D air DVT	15-17	R	1100 California Titanium			Rocket III Classic	07-09	R
1260 Multistrada	18-21	R	(With top fairing)	04-05	R	Rocket III Touring	08-17	R
1260 Multistrada Touring	2018	R	1100 California Aquila Nera	09-11	R	Rocket III Roadster- ABS	10-18	R
1260 S Multistrada	18-20	R	1100 California Classic Touring	06-08	R	Rocket X	15-16	R
1260 S Multistrada D air	18-20	R	1100 California EV			Thunderbird (1597cc)	09-18	R
1260 S Multistrada Pikes Peak	18-20	R	(Up to KD115426/Single pin pad fixing)	97-00	R	Thunderbird Commander (1699cc)	14-18	R
1260 Multistrada Enduro	18-21	R	1100 California EV Touring	03-05	R	Thunderbird LT (1699cc)	14-18	R
1260 Multistrada S Grand Tour	18-21	R	1100 California Jackal			Thunderbird Storm (1699cc)	11-18	R
HARLEY DAVIDSON			(Up to KD142328/Single pin pad fixing)	94-01	R	Thunderbird Nightstorm	15-18	R
XG 500 Street	16-20	F	1100 California Jackal			VICTORY		
XG 750 Street	16-20	F	(Up to KD152328/2 pin pad fixing)	94-01	R	Victory All models	98-07	R
HONDA			1100 California Special			Octane 1200cc	17	F
CB 500 V/W/SW/X/SX/Y/SY/2/S2	97-03	F	(Up to KD131644/single pin pad fixing)	99-00	R	YAMAHA		
NX 500 V/W/X Dominator	97-99	F	1100 California Special			DT 125 X	05-06	F
SRL 650 V/W	97-98	F	(From KD131645/2 pin pad fixing)	99-00	R	XT 660 R	04-15	F
NT 650 VV/XV/XY/V1 'Deauville'	98-01	F	1100 California Sport	01-02	R	ZERO		
NX 650 V/W/X Dominator	97-02	F	1100 California Stone	01-05	R	Zero DS (ZF9.4/ZF12.5) (J.Juan F&R Calipers)	15	F
FX 650 X/Y 'Vigor'	99-03	F	1100 California Stone Metal	02-03	R	Zero S (ZF9.4/ZF12.5) (J. Juan F&R Calipers)	15-19	F
HUSQVARNA			1100 California Vintage	06-12	R	Zero SR (ZF12.5) (J. Juan F&R Calipers)	15-16	F
FR 450 (4T)	16-19	F	1100 California 1100 190	12	R	Zero S (ZF9.8/ZF13.0) (J. Juan F&R Calipers)	16-17	F
701 Enduro	16-20	F	1100 Quota ES	99-01	F	Zero S (ZF7.2)	19-20	F
TR 650 Terra (Spoke wheel)	12-13	F	1200 Griso 8v Special Edition			Zero S (ZF14.4)	19-20	F
TR 650 Strada (Cast wheel)	12-13	F	/Spoke wheels/radial caliper	07-12	R	Zero SR (ZF13.0) (J. Juan F&R Calipers)	16-20	F
INDIAN			1400 Audace	15-16	R	Zero DSR (ZF13.0) (J.Juan F&R Calipers)	16-19	F
Scout	17-20	F	1400 California Custom	13-15	R	Zero DS II (ZF7.2)	19-20	F
Scout Bobber	18-20	F	1400 California Touring	13-21	R	Zero DS II (ZF14.4)	19-20	F
Scout Sixty	17-20	F	1400 California Touring SE	15-17	R	Zero DS (ZF13.0) (J.Juan F&R Calipers)	16-19	F
ITALJET			1400 Eldorado	15-17	R	Zero DSR (ZF14.4.0)	19-20	F
Griffon #59	07	R	1400 Audace Carbon	16-17	R	Zero DSR Black Forest Edition (ZF14.4.0)	19-20	F
KTM			MGX 21 1400	16-21	R	Zero FX (ZF3.3/ZF6.5) (J.Juan F&R Calipers)	16-20	F
450 Rally	17-20	F	MOTO MORINI			Zero FXS (ZF3.3/ZF6.5) (J.Juan F&R Calipers)	17-20	F

FA210 112 x 56.5 x 11mm



MATERIAL AVAILABILITY											
FA	TT	V	R	HH	MXS	SXR	EPFA	GPFAX	SFA	SFAC	SFAHH
✓		✓									

BUELL

M2 Cyclone	94-97	F
S2 "Thunderbolt"	94-97	F
S1 Lightning	94-97	F
S3 Thunderbolt	94-97	F

PERFORMANCE MACHINE AFTERMARKET

CALIPER	
125 X 6	
137 X 6	

FA211 78 x 45.5 x 8.5mm



MATERIAL AVAILABILITY											
FA	TT	V	R	HH	MXS	SXR	EPFA	GPFAX	SFA	SFAC	SFAHH
✓							✓				

PVM AFTERMARKET CALIPER

4 Piston race caliper old design

FA213 78 x 41 x 9mm



MATERIAL AVAILABILITY												
FA	TT	V	R	HH	MXS	SXR	EPFA	GPFA	SFA	SFAC	SFAHH	
✓		✓		✓			✓		✓		✓	

Brand	Model	Year	Code	Spec	Material	Code	Spec	Material	Code	Spec	Material
APRILIA	F900 XR				R	/5 Spoke cast wheel)			12		R
	Pegaso Strada 650	05-06	R	HP4		13-14	R	690 Duke (2 pin pad fixing			
	Pegaso 650 Trial/Factory	06-08	R	HP4 Carbon		13-14	R	/Multi Spoke cast wheel)		13-20	R
	Pegaso 650	07-08	R	HP4 Race		19-20	R	690 Duke R		10-11	R
	Dorsoduro 750 ABS	08-16	R	S 1000 R Naked (K47)		14-18	R	690 R Duke (Multi spoke cast wheels)		13-18	R
	Dorsoduro Factory 750	10-13	R	S 1000 R Naked		20-21	R	690 Rally Factory Replica		07-09	R
	Dorsoduro Factory 750 (ABS)	10-12	R	S 1000 RR (K46)(Disc has fixed bobbins)	10-18	R	690 SM		07-09	R	
	Shiver 750 GT	09-10	R	S 1000 R/RR (Models fitted with			690 SMC		08-10	R	
	Shiver 750	07-10	R	Forged race wheels -7 Spoke type)	10-18	R	690 SMC R		12-13	R	
	Shiver 750 (RAE00) (Std & ABS)	10-16	R	S 1000 R		18-20	R	690 SM-LE (Limited Edition)		10-11	R
	Shiver 750 GT ABS	10-12	R	S 1000 RR/RR Sport/RR M Sport		18-20	R	790 Duke/Adventure R		18-20	R
	Dorsoduro 900 (ABS)	17-21	R	BORILE				890 Duke		20-21	R
Shiver 900 (ABS)	17-21	R	B 500 CR		02-04	R	890 Duke R		20-21	R	
Caponord 1200 (Cast Wheels)	13-16	R	B 500 MT		02	R	990 Superduke		05-11	R	
Caponord Rally 1200 (Spoke Wheels)	15-16	R	CCM				990 Superduke R		07-13	R	
Dorsoduro 1200	11-12	R	CR 40 S Café Racer (Full fairing)	07-09	R	ROYAL ENFIELD					
Dorsoduro 1200 ATC/ABS	11-14	R	CR 40 Café Racer (Handlebar fairing)	07-08	R	Bullet 500 (EFI/Single Seat)		16-18	R		
BAJAJ			SR 40 Street Scrambler	07-09	R	Classic 500 (EFI/Single Seat)		16-21	R		
Pulsar 220 F/S	15-16	R	GP 450 (4T)	13-15	R	Classic Chrome 500 (EFI/Single Seat)		16-18	R		
Pulsar Adventure AS 200	15-16	R	DUCATI			535cc Continental GT (Non ABS)		13-16	R		
Pulsar RS 200 (inc Lower Fairing)	15-16	R	4400 Scrambler Sixty2	16-21	R	535cc Continental GT (ABS)		17-21	R		
Pulsar 200 NS	14-16	R	797 Monster	17-21	R	Himalayan		16-21	R		
BENELLI			797+ Monster	18-20	R	Interceptor 650 Twin		18	R		
Aurak MY 125 (BJ 125 10A)	16-17	R	803 Scrambler Café Racer	17-21	R	Continental 650 twin		18-21	R		
BETA			803 Scrambler Classic	15-20	R	SWM					
Jonathan 125	00-01	R	803 Scrambler Desert Sled	17-21	R	RS 125 R		16-17	R		
Euro 350	00-01	R	803 Scrambler Flat Traack	16	R	SM 125 R		16-20	R		
BMW			803 Scrambler Full Throttle	15-21	R	TRIUMPH					
C1 125	99-03	R	803 Scrambler Icon	15-21	R	Daytona 675/675 R		13-17	R		
C1 200	01-03	R	803 Scrambler Icon Dark	15-21	R	Street Triple 675		13-16	R		
G 310 R	17-21	R	803 Scrambler	18-20	R	Street Triple S 660		17-19	R		
G 310 GS	17-21	R	803 Scrambler Nightshift	20-21	R	Street Triple S 765		17-20	R		
G 310 GS Edition 40	20-21	R	803 Scrambler Street Classic	18-20	R	Street Triple RX 675		15	R		
C 400 X	18-20	R	803 Scrambler Urban Enduro	15-16	R	Street Triple 675 R		13-16	R		
C 400 GT	18-20	R	Monster 937cc New Monster	21	R	Street Triple RS 765		17-20	R		
F 650 GS Scarver K14	00-03	R	Monster 937cc New Monster	21	R	Speed Triple RS 1200 ABS		21	R		
F 650 GS Scarver K14	04-07	R	1100 Scrambler	18-20	R	YAMAHA					
G 650 X-Challenge	07-09	R	1100 Scrambler Special	18-20	R	Majesty S 125 (XC 125 R)		14-15	R		
G 650 X-Moto cast wheel	07-09	R	1100 Scrambler Sport	18-20	R	WR 125 X (Supermoto)		09-18	R		
G 650 X- Country	07-09	R	1100 Scrambler Pro	18-21	R	WR 125 R		09-15	R		
G 650 GS R131	09-15	R	1100 Scrambler Sport Pro	18-21	R	X-Max 125 Momo Design		15	R		
G 650 GS Sertao	12-14	R	1100 Scrambler Dark Pro	18-21	R	XC 155 F/G SMax		15-16	R		
F 650 E169	93-96	R	HONDA			WR 250 XX/XY (Supermoto) (32D2/4)		08-10	R		
F 650 E169 Funduro	97-03	R	CB 500 V/W/SW/X/SX/Y/SY/2/S2	97-03	R	WR 250 RX/RV (32D1/3)		08-10	R		
F 650 GS R13	99-03	R	NX 500/NX V/W/X Dominator	97-99	R	YP 250 R X-Max (2PLI) Non ABS					
F 650 GS R13	04-07	R	FX 650 X/Y "Vigor"	99-03	R	Nissin F/Brembo R		14-15	R		
F 650 GS K72	44537	R	SLR 650 V/W	97-98	R	X-Max 250 Momo Design		15	R		
F 650 GS 30 Years	2011	R	H P POWER			XT 660 X Supermoto		04-16	R		
F 650 GS Dakar R13	99-03	R	Pantera 600	11	R	XT 660 R		04-16	R		
F 650 GS Dakar R13	04-07	R	HUSQVARNA			MT-03 (660cc)		06-12	R		
F 650 ST E169	97-03	R	TR 650 Terra (Spoke wheel)	12-13	R	VICTORY					
F 700 GS	13-18	R	TR 650 Strada (Cast wheel)	12-13	R	Octane 1200cc		17	R		
F 750 GS	16-20	R	Nuda 900/900 R	12-13	R	ZERO					
F 750 GA Edition 40	20-21	R	INDIAN			Zero DS (ZF9.4/ZF12.5)					
F 800 GS	08-18	R	Scout	17-20	R	(J. Juan F&R Calipers)		15	F		
F 800 GS Adventure	12-18	R	Scout Bobber	18-20	R	Zero S (ZF9.4/ZF12.5)					
F 800 GS 30 Years	2011	R	Scout Sixty	17-20	R	(J. Juan F&R Calipers)		15-19	F		
F 800 GS Triple Black	2012	R	KTM			Zero SR (ZF12.5)					
F 800 GS Trophy	12-18	R	Duke 125 (4T)	11-18	R	(J. Juan F&R Calipers)		15-16	F		
F 800 GT	13-20	R	RC 125	14-19	R	Zero S (ZF9.8/ZF13.0)					
F 800 R	09-14	R	Duke 200 (4T)	12-15	R	(J. Juan F&R Calipers)		16-17	F		
F 800 R	14-20	R	RC 200	14-15	R	Zero S (ZF7.2)		19-20	F		
F 800 R Sport	2015	R	Duke 250	15-20	R	Zero S (ZF14.4)		19-20	F		
F 800 R Christian Pfeiffer Edition	09-11	R	Duke 390	13-20	R	Zero SR (ZF13.0) (J. Juan F&R Calipers)		16-20	F		
F 800 GS Trophy	12	R	390 Adventure	20	R	Zero SR/F 14.4kWh		19-21	R		
F 800 GT	13-18	R	390 Duke (4T)	15	R	Zero SR/S 14.4kWh		19-21	R		
F 800 R	09-18	R	RC 390	14-15	R	Zero DSR (ZF13.0) (J. Juan F&R Calipers)		16-19	F		
F 800 R Chris Pfeiffer Edition	09-11	R	RC 390 (4T)	15	R	Zero DS II (ZF7.2)		19-20	F		
F 800 S (Half Fairing)	06-17	R	Duke-E 640 (Single pin pad fixing			Zero DS II (ZF14.4)		19-20	F		
F 800 ST (Full Fairing)	06-12	R	/zero offset disc)	98	R	Zero DS (ZF13.0) (J. Juan F&R Calipers)		16-19	F		
F 800 ST Touring	10-17	R	Duke II 640 (2 pin pad fixing			Zero DSR (ZF14.4.0)		19-20	F		
F 850 GS	16-20	R	/zero offset disc)	99-02	R	Zero DSR Black Forest Edition (ZF14.4.0)		19-20	F		
F 850 GS Edition 40	20-21	R	Duke II 640 (2 pin pad fixing			Zero FX (ZF3.3/ZF6.5)					
F 850 GS Adventure	16-20	R	/disc with offset)	03-07	R	(J. Juan F&R Calipers)		16-20	F		
F 850 Adventure Edition 40	20-21	R	690 Duke	08-11	R	Zero FXS (ZF3.3/ZF6.5)					
F900 R	20	R	690 Duke (2 pin pad fixing			(J. Juan F&R Calipers)		17-20	F		

BRAKE PAD BUYERS GUIDE

DO NOT REFIT ANY SHIMS/INSULATORS TO EBC PADS FROM ORIGINAL PADS UNLESS INSTRUCTED ON NOTE ON PAD PACKAGING AND ON FA DRAWING ASSOCIATED WITH THAT PAD.

FA214 A 96.5 x 42 x 7.5mm
 B 77.5 x 42 x 8mm

FA214/2 A 96.5 x 42 x 9.5mm
 B 77.5 x 42 x 8mm

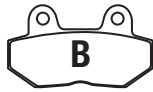

MATERIAL AVAILABILITY											
FA	TT	V	R	HH	MXS	SXR	EPFA	GPFA	SFA	SFAC	SFAHH
✓		✓		✓							

FA214

TRIUMPH

Sprint (All carb models)	93	F(Left)										Speed Triple	97-01	R
Tiger 885cc	92-97	F(Left)										Speed Triple 955cc	02-04	R
Trident 750	92-98	F(Left)										Sprint RS	99-04	R
Trident 900	92-98	F(Left)										Street Twin (900cc Liquid Cooled)	16-20	R
Trophy 900	92-93	F(Left)										Thruxtun 900	04-16	R
Trophy 1200	92-93	F(Left)										Thruxtun Ace 900	15-16	R
												Scrambler (865cc)	06-15	R
												Street Scrambler (900cc Liquid Cooled)	16-20	R
												Street Cup (900cc Liquid Cooled)	16-20	R

FA214/2

TRIUMPH

America (6 spoke cast wheel)	07-09			R								Speedmaster (765cc/Carb)	03-04	R
America (12 spoke cast wheel - 865cc)	10-17			R								Speedmaster (865cc/Carb)	05-07	R
America LT (12 spoke cast wheels /865cc)	14-17			R								Speedmaster (865cc/EFI)	08-16	R
Bonneville America	02-06			R								Speed Triple 1050 (Non ABS)	05-16	R
Bonneville 800	01-06			R								Speed Triple 1050 (ABS)	07-16	R
Bonneville T100 (790cc)	02-04			R								Speed Triple S (1050cc/ABS)	17-18	R
Bonneville T100 (865cc)	05-09			R								Speed Triple R 1050 (2 Pad caliper /Non ABS/5 Spoke wheel)	12-13	R
Bonneville T100 (865cc/Air Cooled /Spoke wheel)	10-16			R								Speed Triple R 1050 (2 Pad caliper /ABS/5 Spoke wheel)	12-13	R
Bonneville T100 Black (865cc/Air Cooled/Spoke Wheel)	14-16			R								Speed Triple R 1050 (2 Pad caliper /ABS/10 Spoke wheel)	14-16	R
Bonneville T100 (900cc/Liquid Cooled/Spoke Wheel)	16-21			R								Speed Triple R (1050cc/ABS)	17-21	R
Bonneville T100 Black (900cc/Liquid Cooled/Spoke Wheel)	16-21			R								Speed Triple RS (1050cc/ABS)	17-21	R
Bonneville (865cc/Cast Wheel)	09-15			R								Sprint 955i ST Front Disc with offset /6 bolt fixing)	99-04	R
Bonneville SE (865cc)	09-13			R								Sprint GT 1050 SE (ABS)	10-16	R
Bonneville Newchurch (865cc/Cast wheel)	15			R								Sprint 1050i GT Front disc with offset /5 bolt fixing	05-06	R
Bonneville Spirit (Spoke wheel/865cc)	15			R								Sprint 1050i Sprint ST (Non ABS) front disc with zero offset	11-12	R
Bonneville T214 (Spoke wheel/865cc)	15			R								Sprint 1050i ST (ABS) Front disc with zero offset	11-12	R
Bonneville/Bonneville Black (865cc)	07-08			R								Sprint 1050 ST (5 spoke wheel /Non ABS Model/5 bolt disc with offset)	05-10	R
Bonneville Steve McQueen SE	12			R								Sprint 1050 ST (5 spoke wheel /ABS Model/5 bolt disc with offset)	05-10	R
Bonneville T120 (1200cc Liquid Cooled)	16-21			R								Sprint 1050 ST (5 spoke wheel /ABS Model/5 bolt disc with offset)	05-10	R
Bonneville T120 Black (1200cc Liquid Cooled)	16-21			R								Tiger Explorer 1200	12-15	R
Bonneville Speedtwin (1200cc)	19-20			R								Tiger Explorer 1200 XC	13-15	R
T595 Daytona	97			R								Tiger Sport 1050cc (Single Side S/Arm)	13-18	R
Daytona 955i	98-00			R								Thruxtun 1200 (Liquid Cooled)	16-20	R
Daytona 955i (From VIN 132513) (5 bolt front disc single sided s/arm)	01-04			R								Thruxtun R 1200 (Liquid Cooled)	16-20	R
Daytona 955i	05-06			R										

FA215 A 96.5 x 42 x 7.5mm
 B 77.5 x 42 x 8mm

FA215/2 A 96.5 x 42 x 9.5mm
 B 77.5 x 42 x 8mm

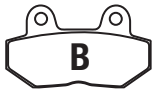

MATERIAL AVAILABILITY											
FA	TT	V	R	HH	MXS	SXR	EPFA	GPFA	SFA	SFAC	SFAHH
✓		✓		✓							

FA215

TRIUMPH

Sprint	93	F(Right)										Daytona Super III	94-97	R
Trident 750	92-98	F(Right)										Daytona 1200	93-98	R
Tiger 885cc	92-97	F(Right)										Speed Triple	94-97	R
Trident 900	92-98	F(Right)										Sprint	93-98	R
Trophy 900	92-93	F(Right)										Sprint RS	99-02	R
Trophy 1200	92-93	F(Right)										Trident 750	92-98	R
Bonneville Speedtwin (1200cc)	19-20			R								Tiger 885cc	92-97	R
												Trident 900	92-98	R
												Trophy 900	92-01	R
												Tiger 955 (from VIN198875)	04-06	R

FA215/2

TRIUMPH

Daytona 750	92			R								Tiger 1050 (Radial caliper)	07-12	R
Daytona 1000	92			R								Tiger 1050 SE - ABS (1050cc)	10-13	R
Daytona 900	93-96			R								Trophy 1200	92-01	R

FA216/2 69.5 x 49 x 10.5mm

FA216/3 69.5 x 49 x 8mm

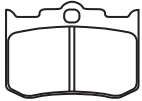

MATERIAL AVAILABILITY											
FA	TT	V	R	HH	MXS	SXR	EPFA	GPFAX	SFA	SFAC	SFAHH
✓		✓		✓							

FA216/2

EBC AFTERMARKET CALIPER

4 Piston

PERFORMANCE MACHINE AFTERMARKET

CALIPER

124 x 4HR

137 x 4

FA216/3

HHI - Hawg Halters AFTERMARKET CALIPERS

4 Piston - All types

INDIAN

Nova

Legends

Thunderheart

NOVA/LEGENDS AFTERMARKET CALIPER

4 Piston

PERFORMANCE MACHINE AFTERMARKET

CALIPER

125 x 4R

125 x 4RSPH

137 x 4B

REVTECH AFTERMARKET CALIPER

New Black 4 Piston Caliper

THUNDERHEART AFTERMARKET CALIPER

4 Piston Caliper

FA217 106 x 31.5 x 8.5mm

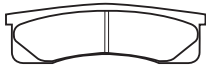

MATERIAL AVAILABILITY											
FA	TT	V	R	HH	MXS	SXR	EPFA	GPFAX	SFA	SFAC	SFAHH
✓											

AP/LOCKHEED

6 Piston / No Pins (CP3366/67)

REVTECH

6 Piston VR1000 Race Caliper

FA218 77.5 x 40.5 x 9.5mm

EFA218/2HH 77.5 x 40.5 x 8mm

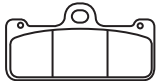

MATERIAL AVAILABILITY - FA218											
FA	TT	V	R	HH	MXS	SXR	EPFA	GPFAX	SFA	SFAC	SFAHH
				✓			✓				

MATERIAL AVAILABILITY - FA218/2											
FA	TT	V	R	HH	MXS	SXR	EPFA	GPFAX	SFA	SFAC	SFAHH
							✓				

BREMBO AFTERMARKET CALIPER

XA9.33.10/11 - 4 Piston P32/36 Radial mount

monobloc @ 108mm spacing

(single pin pad fixing)

X97.37.60/61 - 4 Piston Monobloc 32/36 Radial

Mount @ 108mm (Single pin fixing)

S.W.M.

Gran Milano Special (4T)

15

F

TM

MX 660

06

F

FA218/2

BREMBO AFTERMARKET CALIPER

XA3.B8.30/31 - 4 Piston P32/36 Radial Mount

Caliper @ 108mm Spacing (Titanium Pistons)

XA3.B8.60/61 - 4 Piston P32/36 Radial Mount

Caliper @ 108mm Spacing (Aluminium Pistons)

X1017.40/41 - 4 Piston/40mm Axial Monobloc

XA7G2.40/41 - 4 Piston 100mm CNC Monobloc

Race Caliper

XA7G2.10/11 P4 32/36 Radial monobloc

100mm spacing

FA220 69 x 50.5 x 8.5mm

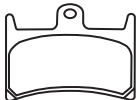

MATERIAL AVAILABILITY											
FA	TT	V	R	HH	MXS	SXR	EPFA	GPFAX	SFA	SFAC	SFAHH
✓											

YAMAHA

FZR 250 R

F

R1-Z (250CC/3XC)

90-92

F

FA222 52.5 x 56.5 x 9mm

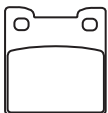

MATERIAL AVAILABILITY											
FA	TT	V	R	HH	MXS	SXR	EPFA	GPFAX	SFA	SFAC	SFAHH
✓											

SUZUKI

RF 900 RR/RS/RS2

94-95

R

DO NOT REFIT ANY SHIMS/INSULATORS TO EBC PADS FROM ORIGINAL PADS UNLESS INSTRUCTED ON NOTE ON PAD PACKAGING AND ON FA DRAWING ASSOCIATED WITH THAT PAD.

FA226 102 x 39 x 9mm

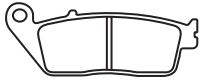

MATERIAL AVAILABILITY

FA	TT	V	R	HH	MXS	SXR	EPFA	GPFAF	SFA	SFAC	SFAHH
✓				✓			✓				

HONDA				KAWASAKI								
RS 125				90-94	F	Ninja 650 (EX 650 KH/KHFA)						
RS 250				90-94	F	/KJF/KJFA - ABS)				17-21	F	
CB 300 F AC (ABS)				15-17	F	Ninja 650 (EX 650 JHF - Non ABS)				17	F	
CB 300 FA AC (ABS)				18-20	F	SUZUKI						
CBR 300 RA (ABS)				15-20	F	DL 250 V-Strom ABS				18-21	F	
CB 600 FW/FX/FY/F2-Y/F1-F9/F21						GSX 250 RL7/RL8				17-18	F	
/F22/FA/FB/FC Hornet				98-13	F	TRIUMPH						
CBF 600 N4/NA4/S4/SA4/N5/NA5/S5/SA5				04-05	F	Street Triple 675 (Naked)				07-12	F	
CBF 600 N8/N9/NA (Non ABS)				08-11	F	Street Triple 675				13-16	F	
CBF 600 NA4/NA5/NA6 (ABS Model)				04-06	F	Street Triple S 660				17-19	F	
CBF 600 S4/S5/S6 (Non ABS)				04-06	F	Street Triple S 765				17-20	F	
CBF 600 SA4/SA5/SA6 (ABS Model)				04-06	F	Tiger 800				11-21	F	
CBF 600 S8/S9 (Non ABS)				08-09	F	Tiger 800 XC (Non ABS)				11-14	F	
CBF 600 N4/N5/N6 (Non ABS)				04-06	F	Tiger 800 XC (ABS)				11-20	F	
CBF 600 NA4/NA5/NA6 (ABS)				04-06	F	Tiger 800 XCa (ABS) up to VIN 855531				15-20	F	
CBR 600 FS/FT/FV/FW				95-98	F	Tiger 800 XCa (ABS) up to VIN 855531				15-20	F	
CBR 600 FB/FC				11-13	F	Tiger 800 XR (ABS)				15-20	F	
CBF 1000 6/7/8/9/A (2 piston front calipers/Non ABS Model)				06-11	F	Tiger 800 XRt (ABS) up to VIN 855531				15-20	F	
CBF 1000 F (FA) (2 piston front calipers/Non ABS)				10-15	F	Tiger 800 XRx (ABS) up to VIN 855531				15-20	F	
						Trident 660				21	F	

FA228 A 96.5 x 42 x 9mm B 77.5 x 42 x 9mm



MATERIAL AVAILABILITY

FA	TT	V	R	HH	MXS	SXR	EPFA	GPFAF	SFA	SFAC	SFAHH
✓				✓					✓	✓	✓

AEON				KAWASAKI							
Elite 125 (4T)	12-13	F	KLR 650 (KL 650 E8F/E9F)	08-09	F	Stryker 125				01-06	F
MY 125		F	KLR 650 ABS	21	R	Like 125 LX				10-15	F
OZ 125 (4T)	13	F	Ninja H2 SX (ZX1002 AJF)	18-20	R	Movie 125				99-00	F
Urban 125 (Scooter)	11	F	Ninja H2 SX SE (ZX1002 BJF)	18-20	R	Vivio 125/150				00-03	F
Urban 125 (4T)	13	F	Ninja H2 SX SE+ (ZX1002 DKF)	19-20	R	Django 150 Heritage 4T/196mm rear disc	14-21			F	
OZ 150 (4T)	13	F	Ninja 1000 SX	21	R	Stryker 150 (Off road)				00-06	F
Elite 200i (Scooter)	11	F	KEEWAY		R	Like 200i LX				10-15	F
Elite 350i (4T)	12-13	F	Partner 110	06-07	F	Super 8 150 X	19-21			F	
Urban 350i (Scooter)	11	F	Cityblade 125	13-15	F	People 250 S				06-08	F(left)
Urban 350i (4T)	13	F	125i Silverblade	13-15	F(left)	People S 300 i				08-10	F(left)
ASPES			125 Logik	13-15	F&R	MALAGUTI					
50 Vega Hybrid	10-14	F	Outlook 125/150	07-10	F&R	Blog 125 ie				09-11	F
BENELLI			Cityblade 150	13-15	F	Centro 125 ie/SL				07-11	F
Caffe Nero 125/150	11-16	F&R	150 Logik	13-15	F&R	Blog 160 ie				09-11	F
Hobby 125 (4T)	13	F&R	Superlight LTD 125	07-15	F	Centro 160 ie/SL				07-11	F
Macis 125/150	10-16	F&R	Superlight 150	07-10	F	MASH					
X 125	12-14	F	250i Blackster	14-15	F	Café Racer 125				14-16	F
X 150	12-14	F	Cruiser 250	09-14	F	Seventy Five 125				14-16	F
Hobby 151 (4T)	13	F&R	250i Silverblade	13-14	F(left)	MZ/MUZ					
Caffe Nero 250	08-14	F(right)	350i Index	13-14	F	SX/SM 125				02-07	F
Zenzero 350	12-16	F	KREIDLER			NIPPONIA					
CF MOTO			50 Supermoto (2T)	14-15	F(Left)	Duel 125 (4T)					F
CF 125 T-22/22A Glory	10-11	F	125 Enduro (4T)	14-15	F(Left)	PEUGEOT					
CF 125 T-21A E-Charms	10-11	F	125 Insignio (4T)	14-15	F(Right)	50 Django Heritage (2T/4T)	14-18			F	
CF 125-3A ST Papio	21	F	125 Supermoto (4T)	14-15	F(Left)	125 Citystar (AC/Carb)				11-15	F
CF 150 T-6/6A Glory	10-11	F	250 Insignio (4T)	14-15	F(Left)	Citystar 125i (LC)				13-19	F
CF 150 T-Si Charm	10-12	F	KYMCO			125 Citystar Blue Line	15			F	
DAELIM			Agility 50	05-08	F	125 Django Heritage (4T)	14-20			F	
SJ 50 R A-Four (50cc)	06-09	F	Agility 50 City+ 50 (4T)	18-20	F	Geopolis 125 (Premium/Non ABS)					
GENERIC/KSR			Agility 50 R10 (4T) (CK 50 QT S)	06-14	F	(Nissin Calipers)	07-12			F&R	
TR 125 SM (4T)	12-16	F	Agility 50 R12 (4T) (CK 50 QT S)	06-21	F	Geo RS 125 (Nissin Caliper)	07-12			F&R	
Zion 125/150 (Rear drum model)	08-10	F	Agility RS 50 Naked (2T/12" wheels)	10-14	F	Satelis 125 Avenue (Nissin calipers)	08-09			F&R	
Zion 125/150 (Rear disc model)	11-16	F&R	Filly 50 LX (S210)	00-06	F	Satelis 125 (4T)				13	R
Inox 125 (2T)	12-14	F	Like 50 (2T)	10-21	F	Satelis 125 RS (4T)				13	F
HARTFORD			Like 50 LX (4T)	10-21	F	Satelis 125 Blue Line				15	F
VR-125 Z Velo Sport	00-03	F	Sento 50	08-15	F	E-Satelis (Electric)				11	F&R
VR-125 X/H Velo-Cross	00-03	F	Vitality 50 (2T) (SF10FA)	04-09	F	E-Vivacity (Electric)				11-15	F
CR 125/150 H/X/Z	04	F	Vitality 50 (4T) (U31000)	04-09	F	Vivacity 125 (4T)				10-15	F
HONDA			Yup 50	01-09	F	Vivacity Sixties 125 (4T)				11-12	F
CA 125 S/T 'Rebel'	95-97	F	Cobra 100 Racer	99-03	F	150 Citystar (AC/Carb)				11-15	F
CMX 250 CT 'Rebel'	96-97	F	Agility 125 (4T) U62000/1 1 2" wheels/3 spoke	06-14	F	150 i Citystar (LC)				13-15	F
HYOSUNG			Agility RS 125 (4T 12" wheels /5 spoke)	10-15	F	Citystar One 150				13-14	F
MS3 (125cc)	07-09F (Left)&R					Django 150 Heritage (4T/196mm Rear Disc)				14-20	F
MS3 250i	07-09 F(Left)&R					Citystar 200i				12-18	F

BRAKE PAD BUYERS GUIDE

DO NOT REFIT ANY SHIMS/INSULATORS TO EBC PADS FROM ORIGINAL PADS UNLESS INSTRUCTED ON NOTE ON PAD PACKAGING AND ON FA DRAWING ASSOCIATED WITH THAT PAD.

FA228 A 96.5 x 42 x 9mm B 77.5 x 42 x 9mm

PEUGEOT (Contd)

Geo RS 250 (Nissin Caliper)	07-12	F&R
Geopolis 250 (Premium/ Nissin Calipers/Non ABS)	07-12	F&R
Satelis RS 250 (Nissin Calipers)	07-12	F&R
Satelis 250 Premium (Nissin Calipers)	07-12	F&R
Geopolis 300	10-15	F&R
Geopolis 300 (Nissin Calipers)	10-14	F&R
Geopolis 300 GT	14	R
Geo RS 300 (Nissin Calipers)	10-12	F&R
Metropolis 400 RS I (3 Wheel Model/Nissin Caliper)	17-18	R
Metropolis 400 RX-R (3 Wheel Model/Nissin Caliper)	17-18	R
Metropolis 400 Allure (3 Wheel Model/Nissin Caliper)	17-18	R
Satelis 300 (4T)	13-14	F&R
Satelis 2 300 (4T)	14-15	F&R
Geopolis 400 (Premium/ Nissin Calipers/Non ABS)	07-12	F&R
Geo RS 400 (Nissin Calipers)	08-12	F&R
Satelis 400 Premium (Nissin Calipers)	08-12	R
Satelis 400 Urban (Nissin Calipers/ABS)	08-12	R
Satelis 400 RS (Nissin Calipers)	08-14	R
Satelis 2 400 (4T)	14-15	R
Satelis 2 400 RS	14-15	R
Geopolis 500	08-11	R
Satelis 500	07-12	R
Satelis 500 RS (Nissin Calipers)	08-12	R

QUADZILLA

WK 300	06-08	F
ROYAL ENFIELD		
Bullet 350 (Efi/Dual Seat)	09-15	F
Bullet 500 (Efi/Dual Seat)	09-15	F
Clubman 500 EFI (Single Seat)	09-12	F
Bullet Battle Green 500 EFI (Single Seat)	09-15	F
Bullet Classic 500 EFI (Single Seat)	09-21	F
Bullet Classic Chrome 500 EFI (Single seat)	09-15	F
Bullet Desert Storm 500 (EFI/Single Seat)	12-15	F
Electra 500 EFI (Dual Seat)	09-12	F
Electra 500 EFI	09-14	F
Fury 500	11-12	F
Trails 500 EFI	09-12	F
Woodsmen 500cc EFI	10-12	F
SINNIS		
Hawk 50 QM 50 10A-(C)	08-10	F
Stealth 125 QM125-2D	08-10	F(left)
QM 50 T-10R Eagle 50	10-12	F
ZN 50 QT-30A Strada 50	12-14	F
ZN 125 T-ES Spirit 125	12-14	F
ZN 125 T-30A Strada 125		F
SUZUKI		
AN 250 Skywave Type M (BA-CJ45A)	07-08	F(left)
AN 250 Skywave/Type S (BA-CJ44A)	07-08	F(left)
AN 250 8 (CJ46A) Skywave SS	08	F(left)
AN 400 K7-K9/ZK7/ZK8/L0/L1-L4		

Burgman/Non ABS/Skywave	07-15	F(left)
AN 400 Burgman/Skywave ABS	07-20	F(left)
SFM		
SFM 125 A8 Roadster	13-15	F
SYM		
XPro 125	11-13	F
RS 150	06	R
TRIUMPH		
Tiger 1200 XR/XRx/XRr Low	18-20	R
Tiger 1200 XRr/Xca/XCc	18-20	R
Tiger Explorer XC (1215cc)	16-17	R
Tiger Explorer XCx/Xc Low (1215cc)	16-17	R
Tiger Explorer XCa (1215cc)	16-17	R
Tiger Explorer XR (1215cc)	16-17	R
Tiger Explorer XRx/XRr Low (1215cc)	16-17	R
Tiger Explorer XRt (1215cc)	16-17	R
Trophy 1215	12-16	R
Trophy SE 1215	12-17	R
VECTRIX		
VT-1	14	F
VIALLI		
DXB 50	06	F
Fireforce 50	06	F
W.K. BIKES		
WK 125 C (2T) (16" wheel)	10-13	F
WK 125 SC (4T) (14" wheels)	10-14	F
WK Jetmax 250 (4T)	10-14	F(left)
YAMAHA		
YBR 125 ED (5HHB/F/H) Brasil (Disc front)	06-08	F

FA229 A 133.5 x 37 x 8.5mm B 110 x 51.5 x .5mm

MATERIAL AVAILABILITY

FA	TT	V	R	HH	MXS	SXR	EPFA	GPFAX	SFA	SFAC	SFAHH
✓		✓		✓			✓				



CF MOTO

650 NK	12-15	F(left)
650 TK	13-15	F(left)
650 TR	13-14	F(left)
650 MT	21	F(left)
KAWASAKI		
ZR-X 400 E3 (ZR 400 E3)	96	F(left)
ER-5 ER 500 C1-C5P	01-07	F
ER-6f (EX 650 A6F-A8F/C9F/CAF/CBF)	06-11	F(left)
ER-6f (EX 650 B6F-B8F/D9F /DAF/DBF) ABS	06-11	F(left)
ER-6f (FCF/FDF/FEF/FFF/FGF (With ABS)	12-16	F(left)
ER-6f (ECF/EDF/EEF/EFF/EGF (Non ABS)	12-16	F(left)
ER-6n (ER 650 A6F-A8F/C9F/CAF/CBF)	06-11	F(left)
ER-6n (ER 650 B6F-B8F/D9F/DAF)	06-10	F(left)
ER-6n (FCF/FDF/FEF/FFF/FGF (With ABS)	12-16	F(left)
ER-6n (ECF/EDF/EEF/EFF/EGF (Non ABS)	12-16	F(left)
KLE 650 A7F/A8F/A9F/CAF/CBF/CCF /CDF/CEF Versys	07-14	F(left)
KLE 650 B7F/B8F/B9F/DAF/DBF /DCF/DDF/DEF Versys ABS	07-14	F(left)
KLR 650 C1-C10	95-04	F
ZR 750 D1 "Zephyr"	96	F(left)
ZR-7 (ZR 750 F1/F3/F5)	99-04	F(left)
ZR-7S (ZR 750 H1/H2)	01-04	F(left)
Z 750 (ZR 750 J1/J2)	04-05	F(left)
Z 750 S (ZR 750 K1/K6F)	05-07	F(left)
VN 800 C1/C2/E1/E2/E3 "Drifter" (Non ABS)	99-04	F
VN 800 B1-B10/B6F/BDF "Classic"	96-06	F
VN 900 A6F Classic	06	F
VN 900 Classic (Spoke wheel)	07-21	F
VN 900 Custom (Cast wheel)	07-21	F
VN 900 Classic Special Edition		

/White Wall Tyres/Spoke Wheel	11-20	F
KLV 1000 (LV 1000 A1H/A2H)	04-05	F(left)
GPZ 1100 E1/E2/F1	95-98	F(left)
ZR 1100 B1 "Zephyr"	96-97	F(left)
ZR 1100 B5 (Zephyr 1100 RS)	02	F(left)
VN 1500 D1/D2/E1/E2 "Classic"	96-99	F
VN 1500 G1/G2 Classic Tourer	98-00	F(left)
VN 1500 J1/J2/R1/R2/R3 Drifter	99-04	F
VN 1500 L1/L2/L3/L4 "Nomad Fi"	00-03	F(left)
VN 1500 N1/N2/N3 Classic Fi	00-04	F
VN 1600 A1/A2/A3/A6F	03-08	F(left)
VN 1600 D1H/D6F Classic Tourer	05-08	F(left)
VN 1700 C9F Classic Tourer	09	F(left)
VN 1700 E9F Classic	09	F(left)
SUZUKI		
GSF 250 VS/VT/VV/VW/VX/VY (GJ77) Bandit	95-00	F
TU 250 GY/GBK1 Grass Tracker		
/Big Boy NJ47A-117/123)	00-01	F
TU 250 XTX/XTY (NJ47A/115) Volty	99-00	F
SV 400 X/Y/K1/K2	00-02	F(left)
SV 400 SX/SY/SK1/SK2	00-02	F(left)
SV 400 K3/K4/K5	03-05	F(left)
SV 400 SK3/SK4/SK5	03-05	F(left)
GSX 600 FW/FX/FY/FK1-FK6	98-06	F(left)
GSF 600 Y/SY/K1/SK1-SK4/K2-K4 /SK4 Bandit	00-04	F(left)
DL 650 K4/K5/K6 V-Strom	04-06	F(left)
DL 650 XK7-XK9/XL0 V-Strom X	07-11	F(left)
DL 650 AK7-AK9/ALO V-Strom ABS	07-11	F(left)
DL 650 AL1 XP V-Strom Expedition	11	F(left)
DL 650 AK9 GT V-Strom Traveller ABS	07-11	F(left)
DL 650 V-Strom ABS	12-21	F(left)
DL 650 XT V-Strom ABS	15-21	F(left)
GSF 650 SK5/SK6 Faired Bandit Non ABS	05-06	F(left)
GSF 650 K5/K6 Naked Bandit Non ABS	05-06	F(left)
GSF 650 AK5/AK6 Naked Bandit ABS	05-06	F(left)

GSF 650 SAK5/SAK6 Faired Bandit ABS	05-06	F(left)
SFV 650 K9/L0/L1-L5 Gladius	09-15	F(left)
SFV 650 AK9/ALO/AL1-AL5 (ABS)	09-15	F(left)
SV 650 K3-K9/L0 Naked Non ABS	03-10	F(left)
SV 650 AK7-AK9/ALO Naked ABS	07-10	F(left)
SV 650 SAK7-SAK9/SALO	07-15	F(left)
SV 650 SK3-SK9/SLO Top Fairing		
Non ABS	03-15	F(left)
SV 650 X/Y/K1/K2 Naked Non ABS	99-02	F(left)
SV 650 SX/SY/SK1/SK2 Top Fairing		
Non ABS	99-02	F(left)
SV 650 ABS	16-20	F(left)
SV 650 X ABS	18-20	F(left)
GSR 750 L1-L6 (Non ABS)	11-16	F(left)
GSR 750 AL2/AL4-AL6 (ABS)	11-16	F(left)
GSX 750 FW/FX/FY/FK1-FK6	98-06	F(left)
GSX 750 W/X/Y	98-03	F(left)
DR 800 ST/SV (SR43B)	96-97	F
VX 800 T	96	F
DL 900 Migrator	14-19	F
DL 1000 K2-K9/L0 V-Strom	02-10	F(left)
M 1500 (VZ 1500 K9/L0/L1 Intruder)	09-13	F(left)
VL 1500 K2/K3	02-03	F(left)
VL 1500 K5-K8 (C1500 Intruder)	05-08	F(left)
WK		
650i (Naked)	13-14	F(left)
650 TR (Touring)	13-14	F(left)

BUYERS GUIDE

DO NOT REFIT ANY SHIMS/INSULATORS TO EBC PADS FROM ORIGINAL PADS UNLESS INSTRUCTED ON NOTE ON PAD PACKAGING AND ON FA DRAWING ASSOCIATED WITH THAT PAD.

FA230 A 99 x 40 x 7.5mm
B 75.5 x 38 x 8mm



MATERIAL AVAILABILITY

FA	TT	V	R	HH	MXS	SXR	EPFA	GPFAX	SFA	SFAC	SFAHH
	✓		✓								

SUZUKI

RM 80 T/V/W/X/Y/K1
RM 85 K2/LK2/K3/LK3/LK4/K4
DR-Z 125

96-01 F KLX 125 L (B1/B2/B3/B6F)
02-04 F KMX 125 B2-B12
03-21 F (From E/No MX AE 013437)

KAWASAKI

03-06 F
87-03 F

FA231 A 133.5 x 37 x 8.5mm
B 109.5 x 37 x 8.5mm

MATERIAL AVAILABILITY - FA231

FA	TT	V	R	HH	MXS	SXR	EPFA	GPFAX	SFA	SFAC	SFAHH
✓		✓		✓			✓				

FA231/2 A 133.5 x 37 x 10.5mm
B 109.5 x 37 x 10.5mm

MATERIAL AVAILABILITY - FA231/2 & FA231/3

FA	TT	V	R	HH	MXS	SXR	EPFA	GPFAX	SFA	SFAC	SFAHH
		✓									

FA231/3 A 133.5 x 37 x 10.5mm
B 109.5 x 37 x 11.5mm



C F MOTO

650 NK
650 TK/TR
650 MT

KAWASAKI

BJ 250 F1/F2 (250 TR)
ZR 250 B6 (Balus II)
ZR-X 400 E3 (ZR 400 E3)
650 (KLE 650 Versys CBF/CCF) (Non ABS)
ER-6f (EX 650 A6F/A7F/A8F/C9F/CAF/CBF)
ER-6n (ER 650 A6F/A7F/A8F/C9F/CAF/CBF)
ER-6f (EX 650 B6F/B7F/B8F/D9F/DAF/DBF) ABS
ER-6f (FCF/FDS/FEF/FFF/FGF) (With ABS)
ER-6f (ECF/EDS/EEF/EFF/EGF) (Non ABS)
ER-6n (ER 650 B6F/B7F/B8F/D9F/DAF)
ER-6n (FCF/EDF/FEF/FFF/FGF) (With ABS)
ER-6n (ECF/EDF/EEF/EFF/EGF) (Non ABS)
KLE 650 A7F/A8F/A9F/CAF/CBF/CCF/CDF/CEF Versys
KLE 650 B7F/B8F/B9F/DAF/DBF/DCF/DDF Versys ABS
W 650 (EJ 650-A1/C3/C4/C5/C6/C7)
650 (KLE 650 DCF/DDF Versys) ABS Model
Z 750 (ZR 750 J1/J2)
Z 750 S (ZR 750 K1/K6F)
ZR 750 D1 'Zephyr'
ZR-7 (ZR 750 F1/F3/F5)
ZR-7S (ZR 750 H1/H2)
EJ 800 ABF/ACF (W 800/Solid F/Disc)
EJ 800 (W 800 Cafe Style/Cockpit Fairing)
EJ 800 ACFA (W 800 Special Edition Black Exhaust/Gold rims)
EJ 800 ADF/AEF/AFF/AGF (W 800)
EJ 800 ADFA/AEFA/AFFA/AGFA (W 800 Special Edition)
VN 800 C1/C2/E1/E2/E3 'Drifter'
W 800 ABF
W 800 ADF/AEF/AFF/AGF (EJ 800)
W 800 Special Edition ADFA/AEFA/AFFA/AGFA
(EJ 800 Special Edition)
VN 900 A6F Classic
VN 900 Custom (Cast wheel)
VN 900 Classic (Spoke wheel)
VN 900 Classic Special Edition/White Wall Tyres/Spoke Wheel
KLV 1000 (LV 1000 A1H/A2H)
GPz 1100 E1/E2/F1
ZR 1100 B1 'Zephyr'
ZR 1100 B5 (Zephyr 1100 RS)
VN 1500 G1/G2 Classic Tourer
VN 1500 J1/J2/R1-R3 Drifter
VN 1500 L1-L4 'Nomad Fi'
VN 1500 N1/N2/N3 'Classic Fi'
VN 1500 P1/P2 Mean Streak
VN 1600 A1/A2/A3/A6F
VN 1600 B1 Mean Streak
VN 1600 B2H/B6F/B7F (Mean Streak)
VN 1600 D1H/D6H Classic Tourer
VN 1700 Voyager ABS
VN 1700 C9F Classic Tourer
VN 1700 E9F Classic
VN 1700 DAF/DBF/DCF/DDF/DEF Classic Tourer ABS
VN 1700 DFF/DGF - Vulcan 1700 Nomad
VN 1700 FAF/FBF/FCF/FDF/FEF Classic ABS

12-15	F(right)	VN 1700 KBF/KCF/KDF/KEF Voyager Custom	11-13	R
13-15	F(right)	VN 2000 A1/A2/A6F	04-08	R
21	F(right)	VN 2000 H8F/H9F Classic	08-09	R
		SUZUKI		
02-03	F	RV 125 K2-K9/L0/L3-L8 Van-van	02-18	F
02	F	RV 200 K2/K3	02-03	F
96	F(right)	RV 200 L6/L7/L8/L9 Van-Van	16-19	F
12	F(right)	GSX 250 FXK2/K3/K4/K5	02-05	F
06-11	F(right)	SV 400 N (VK53A)	98	F
06-11	F(right)	SV 400 SV (VK53A)	98	F
06-11	F(right)	SV 400 X/Y/K1/K2	00-02	F(right)
06-11	F(right)	SV 400 SX/SY/SK1/SK2	00-02	F(right)
12-16	F(right)	SV 400 K3/K4/K5	03-05	F(right)
12-16	F(right)	SV 400 SK3/SK4/SK5	03-05	F(right)
06-10	F(right)	GS 500 ET/EV/EW/EX/EY/K1-K8/FK4-FK8	96-08	F
12-16	F(right)	GSF 600 Y/SY/K1-K4/SY1/SK2-SK4 Bandit	00-04	F(right)
12-16	F(right)	GSF 600 Y/K1-K4 (Naked Bandit)	00-04	F(right)
07-14	F(right)	GSF 600 SY/SK1-SK4 (Faired Bandit)	00-04	F(right)
07-14	F(right)	GSX 600 FW/FX/FY/FK1-FK6	98-06	F(right)
99-05	F	DL 650 K4-K6 V-Strom	04-06	F(right)
12-13	F(right)	DL 650 XK7-XK9/XL0 V-Strom X	07-11	F(right)
04-05	F(right)	DL 650 AK7-AK9/ALO V-Strom ABS	07-11	F(right)
05-07	F(right)	DL 650 AL1XP V-Strom Xpedition	11	F(right)
99-04	F(right)&R	DL 650 AK9 GT V-Strom Traveller ABS	09-11	F (right)
01-04	F(right)&R	DL 650 V-Strom ABS	12-21	F(right)
11-12	F	DL 650 XT V-Strom ABS	15-21	F (right)
11	F	GSF 650 SK5/SK6 Faired Bandit Non ABS	05-06	F(right)
12	F	GSF 650 AK5/AK6 Naked Bandit - ABS	05-06	F(right)
13-16	F	GSF 650 SAK5/SAK6 Faired Bandit - ABS	05-06	F(right)
13-16	F	GSF 650 K5/K6 Naked Bandit - Non ABS	05-06	F(right)
13-16	F	SVF 650 K9/L0/L1-L5 Gladius	09-15	F(right)
99-03	R	SV 650 AK9/ALO/AL1-AL5 (ABS)	09-15	F(right)
11	F	SV 650 K3-K9/L0 Naked - Non ABS	03-10	F(right)
13-16	F	SV 650 SK3-SK9/SLO Top Fairing - Non ABS	03-15	F(right)
13-16	F	SV 650 X/Y/K1/K2 Naked - Non ABS	99-02	F(right)
06	R	SV 650 SX/SY/SK1/SK2 Top Fairing Non ABS	99-02	F(right)
07-21	R	SV 650 AK7/AK8/AK9/ALO Naked - ABS	07-10	F(right)
07-21	R	SV 650 SAK7/SAK8/SAK9/SALO	07-15	F(right)
11-20	R	SV 650 ABS	16-20	F(right)
04-05	F(right)	SV 650 X ABS	18-20	F(right)
95-98	F(right)	XF 650 V/W/X/Y Freewind	97-02	F
96-97	F(right)	GSX 750 FW/FX/FY/FK1-FK6	98-06	F(right)
02	F(right)	GSX 750 W/X/Y	98-03	F(right)
98-99	F(right)	GSR 750 L1-L6 (Non ABS)	11-16	F(right)
99-04	R	GSR 750 AL2/AL/AL4/AL5/AL6 (ABS)	11-16	F(right)
00-03	F(right)&R	C 800 (VL 800 K6-K9/L0/L1-L5) Intruder (Spoke wheel model)	06-15	F
00-04	R	C 800 C (VL 800 CK7-CK9/CL0/CL1-CL3) Intruder (Cast wheel model)	07-15	F
02-04	R	VL 800 K1-K5 'Intruder Volusia'	01-21	F
03-08	F(right)&R	VL 800 C 50 Boulevard Inc Tourer	05-21	F
04	R	VZ 800 V/W/X/Y/K1/K2 Marauder	97-03	F
05-08	R	M 800 Z (VZ 800 K5-K9/L0/L1/L3 Intruder)	05-13	F
05-08	F(right)&R	M 800 Z (VZ 800 K9Z Intruder)	09-10	F
09-20	R	VL 800 BTL4 C800 Intruder	14	F
09	F(right)&R	VZ 800 L4/L5 Intruder M800/T	14-15	F
09	F(right)&R	DL 1000 K2-K9/L0 V-strom	02-10	F(right)
10-13	R	M 1500 (VZ 1500 K9/L0 Intruder)	09-13	F(right)&R
15-16	R	VL 1500 K2/K3	02-03	F(right)
10-13	R	VL 1500 K5-K8 (C1500 Intruder)	05-08	F(right)
		VL 1500 BTL3/BTL4/BTL5 (CT 1500 BT Intruder)	13-15	R

**BRAKE PAD
BUYERS GUIDE**

DO NOT REFIT ANY SHIMS/INSULATORS TO EBC PADS FROM ORIGINAL PADS UNLESS INSTRUCTED ON NOTE ON PAD PACKAGING AND ON FA DRAWING ASSOCIATED WITH THAT PAD.

FA231 A 133.5 x 37 x 8.5mm**B 109.5 x 37 x 8.5mm****FA231/2 A 133.5 x 37 x 10.5mm****B 109.5 x 37 x 10.5mm****FA231/3 A 133.5 x 37 x 11.5mm****B 109.5 x 37 x 11.5mm**

M 1600 (VZ 1600 K4/K5 Intruder)	04-05	R	VN 1700 KBF/KCF/KDF/KEF Voyager Custom	11-13	R
C 1800 R (VLR 1800 K8/K9/L0/L1)(C 1800 R Intruder)	08-13	R	VN 2000 A1/A2/A6F	04-08	R
C 1800 RT (VLR 1800 K8RT/K9RT) Touring Intruder	08-10	R	VN 2000 H8F/H9F Classic	08-09	R
M 1800 R (VZR 1800 K6/K7/K8/K9) Intruder			SUZUKI		
- Handlebar Cowling	06-09	R	VL 1500 BTL3/BTL4/BTL5 (CT 1500 BT Intruder)	13-15	R
M 1800 R2 (VZR 1800 NK8/NK9) Intruder			M 1500 (VZ 1500 K9/L0 Intruder)	09-13	R
- No Handlebar Cowling	08-09	R	M 1600 (VZ 1600 K4 Intruder)	04	R
M 1800 RZ (VZR 1800 ZK7/ZK8/ZL1/ZL2 Intruder)			C 1800 R (VLR 1800 K8/K9/L0/L1) (C 1800 R Intruder)	08-13	R
With Handlebar Cowling	07-13	R	C 1800 RT (VLR 1800 K8RT/K9RT) Touring Intruder	08-10	R
H P POWER			F FA231/3 - KAWASAKI		
Pantera 600	11	F	VN 1500 P1/P2 Mean Streak	02-04	R
WK			VN 1600 A1/A2/A3/A6F	03-08	R
650i (Naked)	13-14	F(right)	VN 1600 B1 Mean Streak	04	R
650 TR (Touring)	13-14	F(right)	SUZUKI		
			M 1600 (VZ 1600 K5 Intruder)	05	R
FA231/2 - KAWASAKI			M 1800 R (VZR 1800 K6/K7/K8/K9) Intruder		
VN 1600 B2H/B6F/B7F (Mean Streak)	05-08	R	- Handlebar Cowling	06-09	R
VN 1600 D1H/D6H Classic Tourer	05-08	R	M 1800 R2 (VZR 1800 NK8/NK9) Intruder		
VN 1700 B9F/BAF/BBF/BCF/BDF/BEF/BFF Voyager ABS	09-15	R	- No Handlebar Cowling	08-09	R
VN 1700 C9F Classic Tourer	09	R	M 1800 RZ (VZR 1800 ZK7/ZK8/ZL1/ZL2 Intruder)		
VN 1700 DAF/DBF/DCF/DDF/DEF Classic Tourer ABS	10-13	R	With Handlebar Cowling	07-13	R
VN 1700 DFF - Vulcan 1700 Nomad	15	R	VZR 1800 BZL4 /BZL5/BZL6/BZL7/BZL8 - M1800 RB	14-18	R
VN 1700 E9F Classic	09	R			
VN 1700 FAF/FBF/FCF/FDF/FEF Classic ABS	10-13	R			

FA232 72.5 x 43.5 x 7mm**MATERIAL AVAILABILITY**

FA	TT	V	R	HH	MXS	SXR	EPFA	GPFAX	SFA	SFAC	SFAHH
	✓		✓								

APACHE

Mini Tomahawk 50 (2T)	08-09	R	JORDAN		
CF MOTO			HIPO/MARS/BOB 50/90/100	03-04	R

CF 500 C/Force (X5 Terralander)	11-15	PB	QUADZILLA		
CF 625 C/Force (X6 Terralander)	11-15	PB	R 50 (Rear disc model)	03-06	R

POLARIS			CUV 500 Side x Side (Parking brake)	10-11	
Rear pad most models	89-00		QZ 500 E/ES 4x4 (Parking brake)	09-11	R
See main application list for full details.			RS5 4WD (Parking brake)	10-11	
			RS6 EFI 4WD (Parking brake)	10-11	

This pad has increased friction area. Can be fitted in place of FA178 to improve wear life on Polaris ATV's

SFA233 75 x 37 x 9.5mm**MATERIAL AVAILABILITY**

FA	TT	V	R	HH	MXS	SXR	EPFA	GPFAX	SFA	SFAC	SFAHH
									✓		

DAELIM

BESB1 125 (SC125)	08-13	F	ZX 50 Super Fever/Scout	99-06	F
			KB 50 Scout	97	F

KYMCO

Cobra 50 Cross	00-06	F	Filly 50 LX	00-02	F
Cobra Racer (SF10AG)	00-06	F	Sniper 50 (PR 50 B)	93	F
CX 50 Super (PR50AC)	94-97	F	Sniper 50 DD (PR50BB)	94-96	F
K12 Sport 50 (SE10CA)	95-00	F	KB 100 Manboy	97-00	F
KB 50 (SE10CA)	95-00	F	Top Boy 100	97	F

SACHS

Looping 50	98	F	49 ER 10"	07	F
Top Boy 50 (SF10GG)	97-06	F			

SFA234 59 x 44.5 x 9.5mm**MATERIAL AVAILABILITY**

FA	TT	V	R	HH	MXS	SXR	EPFA	GPFAX	SFA	SFAC	SFAHH
									✓		

HONDA

SZX 50 X8R-SW/SX/SY/S1			KYMCO		
"Supersport Scooter"	98-04	R	Sniper 50 DD (PR50BB)	94-96	R
			Heroism 150	95-97	R

SYM

SZX 50 X8R-XW/XX/XY/X1			Jet Sport X 50 SR	06-15	R
"Cross Sport"	98-04	R			

SFA235 59.5 x 44.5 x 9mm



MATERIAL AVAILABILITY												
FA	TT	V	R	HH	MXS	SXR	EPFA	GPFA	SFA	SFAC	SFAHH	
									✓	✓		

AJS

Digita 50	13-15	F	Epico 50 (2T)	10-18	F	KYMCO						
Exactly 50	08-11	F	Epico Electric	12-13	F	DJW 50 World (PR50AD)			95-97		R	
Firefox 50	13-15	F	Evolution 50 (2T)	10-11	F	Matrix 25/50			06-08		F	
Exactly 125 Scooter (4T)	08-15	F	XOR 50	05-14	F	Heroism 125 (SE25BA)			95-97		F	

BAOTAIN

BT49 QT-12 Rebel (4T)	06-11	F	Race 2 50 (2T/4T)	10-14	F	Heroism 50 (SE10BA)			95-97		F	
BT 49 QT 18F1 Tanco 125cc	08-11	F	Roc 50	08-11	F	Heroism 150 (SE30AD)			95-97		F	

BEELINE

Veloce 50	08-10	F	Sirion 50 (2T/4T)	12-18	F	MASH						
Veloce GT 50	08-10	F	Toxic 50 Sport	12-18	F	Bibop 50			14-16		F	

BENELLI

49X-Scooter	07	F	Race 2 125 (4T)	10-14	F	Bibop Racing 50			14-16		F	
Quattro Nove X (50cc)			Soho 125/150	06-15	F	MOTOM						

(All rear drum models)

Quattro Nove X (50cc)

All rear disc models)

10-16 F&R Wiki 125 (Scooter)

10-14 F G 125 RT Retro (Scooter)

08 F **H P POWER**

BS 50 Cuba/Sting

08 F Tin 50 (4T/4V)

08 F **ITALJET**

Nag 50 Scooter

08 F SX1 50 Scooter

07-09 F **KEEWAY**

Aragon 50

07-12 F F-Act 50

Aragon GP50

08-12 F F-Act 50 Evo DD (2T)

Aragon GP Paddock

07-12 F F-Act 50 Evo City (2T)

Aragon Club 50

07-12 F F-Act 50 RS

Aragon S-Line 50

07-08 F F-Act Nkd 50

Formula 50 Basic

07-12 F F-Act Racing 50 (25/45)

Formula 50 R

07 F Flash 50 Electric

Freaky 50

03-12 F Focus 50

Oliver 50 (All models)

03-05 F Matrix 50

Hussar 50

03-05 F Matrix V4 50 (25/50)

Popcorn 50

07-12 F RY6 50 (25/45)

Aragon GP 125

07-12 F RY8 SP 50 (25/45)

Aragon S Line 125

06-12 F RY8 Racing 50 (25/45)

Oliver 125

04-06 F&R Swan 50 (25/45)

CSR

ONA 125 (4T)

04-06 F&R F-Act 100

Scoo 125 (4T)

04-06 F&R F-Act 125

GARELLI

GP 50 (2T)

09-10 F Matrix 125

Flexi 50

09-12 F F-Act 150

Tesse 50 (2T/4T)

08-10 F Matrix 150

VIP 50

07 F RY8 50cc (All models)

XO 50

09 F Matrix Electric

XO 50 (TM 50 QT-31) (2T/4T)

10-12 F&R **KM (KEEN MOTORBIKES)**

Flexi 125

09-12 F Badboy 50 CX

09 F Badboy 100 CX

09 F **KREIDLER**

Cracker 50 (2T/4T)

09-18 F 50 City (50cc/2T/A-C)

50 GT Race Explorer

09 F 50 Florett 2.1 RS (50cc/2T/A-C)

FA236 70 x 55.5 x 8.5mm

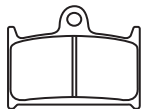

MATERIAL AVAILABILITY												
FA	TT	V	R	HH	MXS	SXR	EPFA	GPFA	SFA	SFAC	SFAHH	
✓				✓								

TRIUMPH

T595 Daytona	97	F	Sprint 955i ST Front disc with offset			Rocket III Roadster - ABS			10-18		F	
Daytona 600	03-04	F	/6 bolt fixing	99-04	F	Rocket X			15-16		F	
Daytona 650	05	F	Sprint 1050i ST (Non ABS)			Sprint			94-98		F	
Speedfour 600	02-05	F	Front disc with zero offset	11-12	F	Sprint GT 1050 SE (ABS)			10-20		F	
TT 600	00-03	F	Sprint 1050 ST (5 spoke wheel			Sprint RS			99-04		F	
Daytona 750	92	F	/non ABS model/5 bolt disc with offset)	05-10	F	Tiger Explorer 1200			12-15		F	
Daytona 900	93-96	F	Sprint 1050 ST (5 spoke wheel)			Tiger Explorer 1200 XC			13-15		F	
Trophy 900	94-01	F	/ABS model 5 bolt fixing disc with offset)	05-10	F	Thunderbird (1597cc)			09-18		F	
Daytona 955i	98-04	F	Daytona 1000	92	F	Thunderbird Commander (1699cc)			14-18		F	
Daytona 955i (From VIN 132513)			Daytona 1200	93-98	F	Thunderbird LT (1699cc)			14-18		F	
(5 bolt front disc single sided s/arm)	01-04	F	Trophy 1200	94-01	F	Thunderbird Storm (1699cc)			11-18		F	
Speed Triple	94-01	F	Rocket III (2300cc)	04-09	F	Thunderbird Nightstorm			15-18		F	
Speed Triple 955cc	02-04	F	Rocket III Classic	07-09	F							
			Rocket III Touring	08-17	F							

BRAKE PAD BUYERS GUIDE

DO NOT REFIT ANY SHIMS/INSULATORS TO EBC PADS FROM ORIGINAL PADS UNLESS INSTRUCTED ON NOTE ON PAD PACKAGING AND ON FA DRAWING ASSOCIATED WITH THAT PAD.

FA239 69.5 x 52 x 8mm

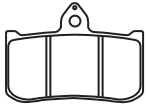

MATERIAL AVAILABILITY											
FA	TT	V	R	HH	MXS	SXR	EPFA	GPFAF	SFA	SFAC	SFAHH
✓							✓				

HONDA RACE BIKES
 RS 125
 RS 250
 95-03 F
 93-02 F

FA243 99 x 49.5 x 8.5mm

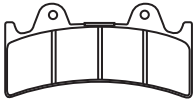

MATERIAL AVAILABILITY											
FA	TT	V	R	HH	MXS	SXR	EPFA	GPFAF	SFA	SFAC	SFAHH
✓				✓							

JAYBRAKE CALIPERS
 J-Six (300-64) (6 Piston)

FA244 75 x 55 x 8.5mm

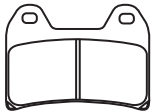

MATERIAL AVAILABILITY											
FA	TT	V	R	HH	MXS	SXR	EPFA	GPFAF	SFA	SFAC	SFAHH
✓		✓		✓			✓	✓			

ALTA MOTORS

Redshift SM 16-18

APRILIA

RS 250 98-02 F
 Pegaso Strada 650 05-06 F
 Pegaso 650 07-08 F
 Dorsoduro Factory 750 10-13 F
 Dorsoduro Factory 750 (ABS) 10-12 F
 Dorsoduro 750 ABS 08-12 F
 ETV 1000 Caponord 01-02 F
 SL 1000 Falco 00-04 F
 RST Futura 1000 01-04 F
 RSV 1000 R Tuono (Radial caliper /2 pin pad fixing) 07-08 F
 RSV 1000 SP 99-00 F
 RSV 1000 Mille 98-00 F
 RSV 1000 Mille R 00 F
 RSV 1000 R Tuono 02-06 F
 Tuono R 1000 Radial caliper/2 pad type 02-10 F
 Tuono V4R-APRC 11-13 F
 Tuono V4R 11-12 F
 Dorsoduro 1200 11-12 F
 Dorsoduro 1200 ATC/ABS 11-14 F

BIMOTA

Later models 98/99- F
 SB8K Gobert (996cc Suzuki engine) 06 F

BENELLI

Uno C 150 13 F
 Uno C 250 (Single) 13 F
 TRE-K 502 16 F
 BN 600 GT (2 pin/2 pad f/caliper) 14 F
 2 UE 750 09-10 F
 800 Leoncino 20-21 F
 800 Trail 20-21 F
 TNT 899 Tornado Naked Tre 07-16 F
 TNT 899 S Tornado Naked Tre 07-11 F
 Trek 899 07-14 F
 Tornado 900 02 F
 TNT 1130 Cafe Racer/Titanium 05 F
 Tornado Naked Tre TNT 1130 06-07 F
 Tre 1130 K 06-17 F
 Tre 1130 K Amazonas 07-15 F

BMW

G 650 Xmoto 07-09 F
 F 800 GT 13-18 R
 F 800 R 09-14 F
 F 800 R Chris Pfeiffer Edition 09-11 F
 F 800 S (Half Fairing) 06-17 F
 F 800 ST (Full Fairing) 06-12 F
 F 800 ST Touring 10-17 F
 R Nine T K21 14-20 F
 R Nine T/5 K21 20-21 F
 R Nine T Pure (K22/1170cc) 16-21 F
 R Nine T Scrambler (K21/1170cc) 16-21 F
 R Nine T Café Racer (K32/1170cc) 16-21 F
 R Nine T Urban GS (K33/1170cc) 17-21 F

BRAMMO

Empulse R 12-13 F

BREMBO

20 6800 10/20 - Goldline 4 piston P4 30/34 @
 65mm Spacing (Two pin pad fixing)
 XA69510 P4 30/34 Motard radial
 108mm mount 2 pin fixing
 XZ78910 P4 30/34 Motard radial
 100mm mount 2 pin fixing
 220A80310 P4 30/34 2 pin pad fixing
 100mm radial mount
 220A16820 P30/34 Yamaha R1
 Radial mount 07-10
 220A01610 P4 30/34 2 pin pad fixing
 108mm radial mount
 220A80210 P4 30/34 2 pin pad fixing
 108mm radial mount
 220A16810 P4 30/34 2 pin pad fixing
 100mm radial mount

CAGIVA

Raptor 650 00-07 F
 1000 Raptor/V-Raptor 00-05 F

CF MOTO

CLX 700 20-21 F
 MT 800 20-21 F

DUCATI

400 Monster/Dark 00-04 F
 Monster Dark ie 400 (Japan) 05-06 F
 Monster Dark ie 400 (Single disc) 05 F
 Monster 400 (Single disc) 00-02 F
 Monster 400 (Twin disc) 03-04 F
 600 Monster 00-01 F
 620/IE Monster 02-04 F
 620 Sport 03 F
 620 Monster ie 03-04 F
 620 Monster Dark 03-04 F
 620 Multistrada Dark (Single disc /twin pin pad fixing) 06 F
 696 Monster 08-14 F
 696 + Monster (inc ABS models) 09-12 F
 Monster 696 20th Anniversary Model 13 F
 748 S (Biposto/Monoposto) 00-02 F
 748 SPS 98-99 F
 748 Testa Bassa (Mono/Biposto) 07 F
 748 Biposto 99-02 F
 748 SP/Monoposto 99-02 F
 748 R (2 pad caliper) 00 F
 750 Supersport 99 F
 750 Supersport IE 00-02 F
 750 Sport 01-02 F
 750 Monster 00-01 F
 Monster ie 750 02 F
 796 Hypermotard 10-13 F
 796 Monster (inc ABS models) 10-14 F
 Monster 796 20th Anniversary Model 13 F
 Monster 800 03-04 F
 800 Sport 03 F

800 Supersport 03-05 F
 848 (Radial 2 pad caliper) 08-10 F
 848 Streetfighter 11-15 F
 900 Supersport 98-99 F
 900 Supersport IE 00-01 F
 900 Sport 02 F
 900 IE Monster 00-01 F
 900 MH Evoluzione 00-01 F
 ST2 (944cc) 97-03 F
 ST3 (Non ABS) (992cc) 04-07 F
 ST3S (ABS Model) (992cc) 06-07 F
 Monster S4R (996cc) (2 pad caliper) 05-06 F
 Monster S4R (996cc) 03-06 F
 Monster S4 Foggy (916cc) 02 F
 Monster S4 (916cc) 01-02 F
 ST4S (ABS Model) (996cc) 03-05 F
 ST4S (Non ABS/996cc) 01-05 F
 ST4 (916cc) 99-02 F
 996 SPS (996cc) 99 F
 996 (996cc) (Monoposto/Biposto) 99-01 F
 996 S 01 F
 998 Matrix (998cc) 04 F
 998 (Monoposto/Biposto) (998cc) 02-03 F
 Monster 1000 Dark 03 F
 Monster 1000 ie (992cc) 04-05 F
 Monster 1000 S ie (992cc) 03-05 F
 Monster S2R 1000 (992cc) 06-08 F
 Multistrada 1000 DS (992cc) 03-06 F
 Multistrada S 1000 DS (992cc) 05-06 F
 Supersport 1000 DS (992cc) 03-06 F
 Hypermotard 1100 07-09 F
 Multistrada 1100/1100 S (1078cc) 07-09 F
 1100 Monster 09-10 F
 1100 S Monster 09-10 F
 1100 Evo Hypermotard 10-11 F
 1100 Monster Evo 11-13 F
 Monster 1100 Evo 20th Anniversary Model 13 F
 Monster Diesel 1100 13 F
 1200 Multistrada Standard 10-11 F
 1200 Multistrada ABS 10-14 F
 1200 Multistrada 1200 S Pikes Peak 11-14 F
 1200 S Multistrada Sport Edition 10-13 F
 1200 S Multistrada Touring Edition 10-18 F
 Multistrada 1200 S Granturismo 13-14 F

GENERIC

Code S 125/150/200 (4T) 12-14 F
 Code X 125/150/200 (4T) 12-14 F

HONDA

CB 400 SF (F3V) Superfour (NC31) 97 F

HOREX

VR6 Classic 13-14 F
 VR6 Roadster 11-14 F

HUSQVARNA

SM 610 (6 bolt front disc) 98-00 F
 SM 610/S (4 bolt front disc) 02-06 F
 SM 610 R 00 F

BRAKE PAD BUYERS GUIDE

DO NOT REFIT ANY SHIMS/INSULATORS TO EBC PADS FROM ORIGINAL PADS UNLESS INSTRUCTED ON NOTE ON PAD PACKAGING AND ON FA DRAWING ASSOCIATED WITH THAT PAD.

FA244 75 x 55 x 8.5mm

LT 610 (6 bolt front disc)	00	F	750 V7 III Rough	17-21	F	Scrambler 1200	08-09	F
701 Vitpilen/Svartpilen	18-20	F	V85TT	18-21	F	1200 Sport	08-10	F
Nuda 900	12-13	F	850 Brevia ie (Non ABS Models)	06-07	F	MV (AGUSTA)		
KEEWAY			850 Griso	06-07	F	675 F3	12-20	F
RKV 125	10-14	F	850 Norge (Non ABS Models)	07	F	675 F3 RC	15-18	F
RKX 125	13-14	F	V9 Bobber	16-21	F	675 Brutale	12-17	F
RKV 150		F	V9 Bobber Sport	16-21	F	Brutale 800	12-18	F
RKX 150	13-14	F	V9 Roamer	16-21	F	800 Brutale Dragster	14-15	F
RKV 200 S	14	F	940 Bellagio	07-12	F	800 Dragster RC	17-21	F
RKX 200	13-14	F	1100 Brevia (Non ABS Models)	05-07	F	800 Dragster RR	15-21	F
RKX 200 S Factory	14	F	1100 Brevia (ABS Models)	05-07	F	800 Brutale RR	19-21	F
KTM			1100 California Aluminium	02-05	F	800 Brutale RR SCS	19-21	F
SMC 625	04-06	F	1100 California Titanium		F	800 Brutale Rosso	19-21	F
Duke II 640 (2 pin pad fixing /Disc with Zero offset)	99-02	F	(with top fairing)	04-05	F	800 Dragster RR SCS	19-21	F
Duke II 640 (2 pin pad fixing /Disc with offset)	03-07	F	1100 California Aquila Nera	09-11	F	800 Dragster Rosso	19-21	F
LC4-E 640 (2 pin fixing)	04-06	F	1100 California Classic Touring	06-08	F	920 Brutale	11-12	F
SMC 640 LC4	05	F	1100 California EV (From KD115427 /2 pin pad fixing)	97-02	F	989 Brutale	08-09	F
SMC 660	05-06	F	1100 California EV Touring	03-05	F	990 Brutale R	10-11	F
690 Duke (2 pin pad fixing /5 Spoke cast wheels)	12	F	1100 California Jackal		F	1090 Brutale R	12-15	F
690 Duke (2 pin pad fixing /multi spoke cast wheel)	13-20	F&R	(From KD152329/2 pin pad fixing)	94-01	F	Brutale 1090	13-15	F
690 SM	07-09	F	1100 California Special		F	NORTON		
690 SM-LE (Limited Edition)	10-11	F	(From KD131645/2 pin pad fixing)	99-00	F	Commando Sport (961cc)	10-15	F
790 Duke	18-20	F	1100 California Sport	01-02	F	SCORPA		
790 Adventure	18-21	F	1100 California Stone	01-05	F	Raidster 660	07	F
790 Adventure R	19-21	F	1100 California Stone Metal	02-03	F	SUZUKI		
790 Adventure R Rally	19-21	F	1100 California Vintage	06-12	F	GSX 400 X Impulse	99	F
890 Duke	20-21	F	1100 California 1100 190	12	F	GSX 400 FSW/FSK1 (GK7B) Inazuma	00	F
890 Adventure	21	F	1100 Griso	05-08	F	GSX 1200 FSW/FSX 'Inazuma'	98-99	F
890 Adventure R	21	F	1100 V11 Ballabio	03-05	F	URAL		
890 Adventure R Rally	21	F	1100 V11 Le Mans	01-05	F	Tourist with Sidecar		
1050 Adventure	15-20	F	1100 V11 Sport	99-01	F	(Brembo 2 pin pad fixing)	11-12	F
1090 Adventure Inc R	17-20	F	1100 V11 Scura	01-03	F	Cross with Sidecar		
1190 Adventure/Adventure R	13-20	F	1100 V11 Naked	02-03	F	(Brembo 2 pin pad fixing)	11-12	F
1290 Super Adventure Inc R and S	15-21	F	1200 Brevia	08-09	F	Sportsman with Sidecar		
LEXMOTO			1200 Griso 8v (Std Cast Wheel)		F	(Brembo 2 pin pad fixing)	11-12	F
Vendetta 250 LJ250-3V	19-21	F	Radial caliper	07-12	F	Ranger with Sidecar		
MAGNI			1200 Griso 8v Special Edition		F	(Brembo 2 pin pad fixing)	11-12	F
Sport 1200 'S'	01	F	Spoke wheels/radial caliper	07-15	F	Retro with Sidecar		
MOTO GUZZI			1200 Norge	06-07	F	(Brembo 2 pin pad fixing)	11-12	F
750 Brevia ie (3 spoke cast wheels)	03-07	F	1200 Norge GT 8v (ABS)	08-15	F	Solo ST (Brembo 2 pin pad fixing)	11-12	F
750 Nevada Classic ie (spoke wheels)	04-15	F	1200 Sport 4v	06-07	F	Wolf Solo (Brembo 2 pin pad fixing)	11-12	F
750 Nevada	02-11	F	1200 Sport 8v	08-13	F	Ural T (Brembo 2 pin pad fixing)	11-12	F
750 V7 Classic	08-12	F	1200 Stelvio	08-11	F	VICTORY		
750 V7 Cafe Classic	09-12	F	1200 Stelvio 8v (ABS)	11-15	F	Victory All models	98-07	F
750 V7 Racer	10-14	F	1200 Stelvio NTX ABS	09-10	F	VOXAN		
750 V7 Stone/Special	12-14	F	1200 Stelvio 8V NTX (ABS)	11-15	F	Black Magic	04-08	F
750 V7 Racer II (ABS/Spoke Wheel)	15-17	F	1400 Audace	15-16	F	VB1-Evo	03-04	F
750 V7 Stone II (ABS/Spoke Wheels)	15-17	F	1400 Audace Carbon	16-17	F	Cafe Racer	06-08	F
750 V7 Special II (ABS/Cast Wheels)	15	F	1400 California Custom	13-15	F	Roadster	06-08	F
750 V7 Special III (ABS/Spoke Wheel)	17-21	F	1400 California Touring	13-21	F	YAMAHA		
750 V7 Stone III (ABS/Cast Wheel)	17-21	F	1400 California Touring SE	15-17	F	FZ 400 (4YR1)	96	F
750 V7 II Stornello	16-17	F	1400 Eldorado	15-17	F	XJR 400 (4HM3/4HM5/4HM6/4HM9 /4HMA/4HMB) Brembo calipers)	95-99	F
750 V7 III Carbon	17-21	F	1400 MGX 21 1400	16-21	F	XT 660 X Supermoto	04-16	F
750 V7 III Limited	17-21	F	MOTO MORINI			XJR 1300 (5EA1/5EA7 Brembo calipers		
750 V7 III Racer	17-21	F	Corsaro 1200	05-10	F	(320mm front discs)	98-99	F
			Corsaro 1200 Veloce	07-08	F	SR/F ZF14.4	19-21	F
			9 1/2 (1200cc)	06-10	F	SR/S ZF14.4	19-21	F
			Corsaro Avio	08	F			

BRAKE PAD BUYERS GUIDE

DO NOT REFIT ANY SHIMS/INSULATORS TO EBC PADS FROM ORIGINAL PADS UNLESS INSTRUCTED ON NOTE ON PAD PACKAGING AND ON FA DRAWING ASSOCIATED WITH THAT PAD.

FA249 91.5 x 51.5 x 10mm

FA249/2 91.5 x 51.5 x 12mm

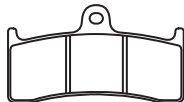

MATERIAL AVAILABILITY												
FA	TT	V	R	HH	MXS	SXR	EPFA	GPFA	SFA	SFAC	SFAHH	
✓				✓			✓					

FA249 - BEHRINGER
6 Piston (Old Design)
PERFORMANCE MACHINE
112 x 6B
112 x 6QC
PRE TECH
6 Piston (Radial Mount)

THUNDERHEART
6 Piston Caliper
FA249/2 - BEHRINGER
6 Piston (Old Design/Endurance)

SFA255 32 x 49 x 7mm



MATERIAL AVAILABILITY												
FA	TT	V	R	HH	MXS	SXR	EPFA	GPFA	SFA	SFAC	SFAHH	
									✓			

PIAGGIO

Mana 850
Mana F

08-12 R

FA256 78.5 x 47 x 7.5mm

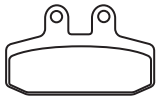

MATERIAL AVAILABILITY												
FA	TT	V	R	HH	MXS	SXR	EPFA	GPFA	SFA	SFAC	SFAHH	
✓	✓			✓					✓	✓	✓	

APRILIA

Pegaso 50	92-94	F	Rambla 250 i	08-09	F	NX 125 K/S/F Transcity				89-97	F	
Scarabeo 125/150/200	99-02	F	Rambla 300 i	10-12	F	XL 125 L Paris-Dakar				85	F	
Red Rose 125	87-94	F	GARELLI 50 Tiger XLE	86-	F	XL 200 L				85	F	
Sport City 125	04-08	F	125 Tiger XLE	86-	F	CMX 250 CV/CW/CX 'Rebel'				97-00	F	
Sport City Cube 125	08-12	F	GILERA Spidermax RS 500							04-11	F	
Tuareg Rally 125 (L/M)	90-91	F	Cougar 125	99-02	F	Spidermax GT 500				04-10	F	
Sport City 200	04-08	F	125 XR1/XR2	89-	F	MOTO GUZZI 750-V7 Special				12-14	R	
Sport City Cube 200	08-10	F	RC 125 Rally	87-88	F	750-V7 Stone				12-14	R	
Leonardo 250 ST/SP	00-04	F	200 Arizona Hawk	85-	F	750-V7 Racer				12-14	R	
Sport City 250 ie	06-08	F	200 RTX	85-	F	750 V7 Racer II (ABS/Spoke Wheel)				15-17	R	
Sport City Cube 250	08-09	F	200 ER	87-	F	750 V7 Stone II (ABS/Spoke Wheels)				15-17	R	
Leonardo 300	05-06	F	200 Fast Bike	87-	F	750 V7 Special II (ABS/Cast Wheels)				15	R	
Sport City Cube 300	08-12	F	RV 200 ES	87-	F	750 V7 Special III (ABS/Spoke Wheel)				17-21	R	
Sport Cube 300 Blackline	11	F	RC 250 Rally	87-	F	750 V7 Stone III (ABS/Cast Wheel)				17-21	R	
Scarabeo 400 ie	07-08	F	350 Dakota	85-	F	750 V7 II Stornello				16-17	R	
Atlantic 500	02-04	F	ER 350	87-	F	V7 III Carbon				17-21	R	
Scarabeo 500/500 AB3	03-06	F	XRT 350	90-	F	V7 III Limited				17-21	R	
Scarabeo 500 Light	06	F	500 Dakota	87-	F	V7 III Racer				17-21	R	
Scarabeo 500 ie	07-09	F	ER 500	87-	F	V7 III Rough				17-21	R	
Scarabeo 125/200	03	F	XRT 600	88-	F	V85TT				18-21	R	
Mana 850	08-11	R	HONDA SJ 50 P/R/S/T/V/W/X 'Bali'	93-99	F	V9 Bobber				16-21	R	
Mana 850 GT (ABS Model)	09-14	R	SJ 100 T/V/W/X 'Bali-Ex'	96-99	F	V9 Bobber - incl. Sport				16-21	R	
Mana 850 ABS	08-13	R	CA 125 V/W/X 'Rebel'	98-00	F	V9 Roamer				16-21	R	
CAGIVA Blues 125	92-95	F	CLR 125 W 'City Fly'	98-03	F	MOTO MORINI 350 'Kanguro'				87	F	
Roadster 125 (521 1A Model)	92-94	F	CRM 125 RL/RM/RN/RR/RV/RX	90-99	F	SCARABEO 500 ie				10-12	F	
Roadster 125 (1AA Model)	95-99	F	NS 125 FG/FH/RH	86-87	F	WK 125 RR				12-13	R	
DERBI Boulevard S125	07	F	NSR 125 FJ/FK/FL/FM/FN	88-92	F							
Rambla 125	08-12	F	NSR 125 RK/RL/RM/RN/RR/RS/RV	89-01	F							
		F	/RW/RX/RV/R1									

SFA257 41 x 43 x 7.5mm



MATERIAL AVAILABILITY												
FA	TT	V	R	HH	MXS	SXR	EPFA	GPFA	SFA	SFAC	SFAHH	
									✓	✓		

BRANSON

BS 125 Snooker	08	F	Panther 125/150/250	02	F							
BS 125 Boulevard	08	F	HONDA Tact 50									F
CAGIVA City 50	91-94	F	SK 50 MM-II/MM-YD/MM-II/MP-II									
DAELIM Bonita 50 (SE 50 C)	09-12	F	(AF28) Dio SR									
Cordi 50/SE 50 R	04-12	F	SK 50 MN-III/MP-III/MP-IV									
'S' Five (SJ50)	01-12	F	(AF28) Dio-ZX									
E-Five (SJ50A)	03-06	F	SK 50 MMR-II/MMT-II (AF28) Dio-XR									
GZ 50 Message	97-02	F	SYM Super Fancy 50	96-02	F							
Delfino 100 (SH100)	01-04	F	City Hopper 50	99-02	F							
B-Bone 125 (SN 125)	09-14	R	Orbit 50	08-09	F							
S1 125 (SL 125)	07-14	R	Orbit 125	08-09	F							

SFA257/2 41 x 43 x 5.5mm



MATERIAL AVAILABILITY												
FA	TT	V	R	HH	MXS	SXR	EPFA	GPFAX	SFA	SFAC	SFAHH	
									✓			

HONDA

FJS 400 Silverwing D6/D7/D8		
Non ABS 256mm front disc	06-08	PB
SW-T 400 (FJS 400 A9/AB)	09-16	PB
SW-T 600 (FJS 600 AB)	11-16	PB
FJS 600 1/2/B3/B4/D5-D8		
Silverwing	01-08	PB
DN-01 (680cc) (NSA 700 A8/A9)	08-11	PB
CTX 700 DE-DCT	14-16	PB
CTX 700 N-DCT	14-17	PB
NC 700 XD (ABS/DCT)	12-14	PB
NC 700 SD (ABS/DCT)	12-14	PB
NC 700 DC-700 Integra	12-15	PB
ADV 750 H (ADV X DCT)	17-18	PB
NM 4 Vultus (NC750J)	15-17	PB
NC 750 X (NC 750 XDE/DCT ABS)	14-18	PB
NC 750 S (NC 750 SDE/DCT ABS)	14-18	PB
750 Integra Scooter DCT (NC 750 D)	14-17	PB
750 Integra S Scooter NC 750 DDSE	14	PB
CRF 1000 Africa Twin ABS DCT	16-20	PB
CRF 1000 Africa Twin Adventure		
Sport ES ABS DCT	18-20	PB
VFR 1200 FAD	10-17	PB
VFR 1200 FAD - GT	14-15	PB
VFR 1200 XDC-DCT Crosstourer	13-18	PB
GL 1800 J Goldwing DCT	18-20	PB
GL 1800 D Goldwing Tour J DCT	18-20	PB
GL 1800 DA Goldwing Tour Airbag J DCT	18-20	PB

APRILIA

NA 850 Mana (Non ABS)	08-11	PB
NA 850 Mana GT (ABS)	09-16	PB
NA 850 Mana (ABS)	08-13	PB
SRV 850	12-14	PB
BMW		
C Evolution (Scooter)	14-20	PB
C 600 Sport Scooter	12-15	PB
C 600 Sport Highline	13-15	PB
C 650 GT Scooter	12-20	PB
C 650 GT Highline	13-18	PB
C 650 Sport Scooter	16-20	PB
GILERA		
Fuoco 500 IE	07-13	PB
Fuoco 500 LT (4V/4T)	13-15	PB
GP 800	08-14	PB
KYMCO		
Maxxer 400	09-10	PB
MXU 400 (A40000)	08-11	PB
Maxxer 450i (4T)	10-15	PB
MXU 450 i (4x4 LOF)	12-15	PB
PIAGGIO		
Liberty 125 MyMoover E5 3 Wheeler	21	PB
MP3 125/250/400	07-08	PB
MP3 - Hybrid (125cc)	09-10	PB
MP3 125 ie (EFI Models)	08-11	PB
MP3 250cc (EFI)	06-08	PB
MP3 250 LT (EFI)	09	PB
MP3 LT 300 i	10	PB

MP3 300 ie (Hybrid)	11-15	PB
MP3 300 ie (Hybrid) LT	11-12	PB
MP3 Business LT 300 ie	13	PB
MP3 Business LT 300 ie ABS		
(13" Front Wheel/14" Rear Wheel)	14-18	PB
MP3 Sport LT 300 ie	13	PB
MP3 Sport LT 300 ie ABS		
(13" Front Wheel/14" Rear Wheel)	14-18	PB
MP3 Touring 300 ie	11-12	PB
MP3 Touring LT 300 ie	11-12	PB
MP3 Yourban LT 300 ie	11-16	PB
MP3 Yourban Sport 300ie	11-16	PB
MP3 Yourban LT RL 300	17-18	PB
X10 ie 350 (4V/4T/EFI)	12-15	PB
MP3 400 i	07-11	PB
MP3 400 Touring ie	11-12	PB
MP3 Touring Business 500 ie	11-12	PB
MP3 500 LT Business	11-15	PB
MP3 500 LT Business ABS (13 Inch Front Wheel/14 Inch Rear Wheel)	14-20	PB
MP3 Touring Sport 500 ie	11-12	PB
MP3 500 LT Sport	11-15	PB
MP3 500 LT Sport ABS (13 Inch Front Wheel/14 Inch Rear Wheel)	14-20	PB
X10 500ie (4V/4T/EFI)	12-15	PB
VECTRIX		
VX-3 Li+ (3 wheeler model)	12-13	PB

FA258 A 119.5 x 26 x 7mm B 94.5 x 35.5 x 8mm

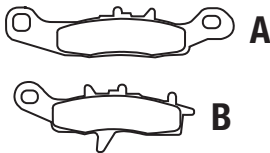

MATERIAL AVAILABILITY												
FA	TT	V	R	HH	MXS	SXR	EPFA	GPFAX	SFA	SFAC	SFAHH	
	✓		✓									

KAWASAKI

KX 80 R7/W1/W2/W3	97-00	F
KX 85 (17" front wheel/14" rear wheel)	01-21	F
KX 85 (19" front wheel/16" rear wheel)	01-21	F
KX 100 B7/C1/C2/C3	97-01	F
KL 250 G1/G1A Super Sherpa	97-00	F
KL 250 J1-J3 Stockman	00-02	F
KLX 250 H1 'Super Sherpa'	98	F

SUZUKI

RM 85 (Small Wheel F 17"/R 14")	05-22	F
RM 85 L (Big Wheel F 19" R 16")	05-21	F
RM 100 K3	03	F

SFA260 35 x 49 x 7mm



MATERIAL AVAILABILITY												
FA	TT	V	R	HH	MXS	SXR	EPFA	GPFAX	SFA	SFAC	SFAHH	
									✓	✓	✓	

ADIVA

AD1 (125/150 3 Wheel Type)	14-15	F&R
AD3 (300 3 Wheel Type)	14-15	F
BENELLI		
X 150 Street	12	R
CPI		
GTR 50	11-12	R
GTS 50/125/200	02-03	R
DERBI		
Sonar 50 2S (2T)	10-11	F
Sonar 125 4S (4T)	10-11	F
Sonar 150 (4T)	09-10	F
GILERA		
DNA 50	01-06	R
50 DD/SP Runner/Purejet	99-05	R
Runner 50 P/J/SP	06-14	R
SKP 50	99-01	R
Stalker 50	97-03	R
Stalker 50	03-06	R
125/180 Runner All models	99-04	R
Fuoco 500 RC/ie	07-13	F
Fuoco 500 LT (4V/4T)	13-15	F

ITALJET

Formula 125 (4T/Single Cyl)	14-15	R
KEEWAY		
Cityblade 125	13-15	R
Cityblade 150	13-5	R
KREIDLER		
50 Galactica 3.0 RS (50cc/2T/A-C)	14-15	R
PEUGEOT		
Speedfight 50 1/2 (L/C)	97-08	R
Tweet 50 RS (4T/Rear disc model)	10-13	R
New Tweet Evo 50 (4T/Rear disc model)	14-15	R
Belville 125 Allure	18-20	R
Belville 125 RS	18-20	R
Citystar 125 (AC/Carb)	11-15	R
Citystar 125 i (LC)	13-19	R
New Tweet Evo 125		
(4T/Rear disc model)	14-20	R
New Tweet Evo 125 (4T)	14-20	R
Satelis 125 RS (4T)	13	R
Tweet 125 (4T)	10-11	R
Tweet 125 RS (4T/Rear disc model)	10-12	R
Tweet 125 (Rear disc)	12-13	R
Citystar 150 (AC/Carb)	11-15	R

Citystar 150i (LC)	13-15	R
Citystar One 150	13-14	R
New Tweet Evo 150 (4T)	14-18	R
New Tweet Evo RS 150 (4T)	14-18	R
Tweet 150 (4T)	10-19	R
Tweet 150 RS (4T/Rear disc model)	10-19	R
Belville 200 Allure	18-19	R
Belville 200 RS	18-19	R
Citystar 200i	12-18	R
PGO		
Tigra 125 (4V/4T)	12	R
PIAGGIO		
NRG 50 RST "MC2"	98	R
Zip 50 RST	96-99	F
Liberty 50 2T (Grimeca Caliper)	97-08	F
Liberty 50 (Heng Tong Caliper) (2T)	97-08	F
NRG 50 Extreme	99-01	R
NRG 50 MC3 DD	01-05	R
NRG 50 Pure Jet	06-09	R
NRG 50 Silver Bullet	10	R
NRG 50 Power DD	05-21	R
Zip 50 Grimeca caliper (A/C 4T)	00-08	F
Zip 50 SP (Liquid Cooled)	96-12	F

BUYERS GUIDE

DO NOT REFIT ANY SHIMS/INSULATORS TO EBC PADS FROM ORIGINAL PADS UNLESS INSTRUCTED ON NOTE ON PAD PACKAGING AND ON FA DRAWING ASSOCIATED WITH THAT PAD.

SFA260 35 x 49 x 7mm

Zip 50 (2T)	00-15	F	MP3 Touring 300 ie	11-12	F	VESPA							
Zip 50 (4T)	00-20	F	MP3 Touring LT 300 ie	11-12	F	Elettrica models	19-21	F					
Zip 50 SP (Liquid Cooled)	96-15	F	300 ie MP3 Yourban Sport	11-16	F	ET2 50		F					
Liberty 50 4T (Grimeca caliper)	00-08	F	MP3 Yourban LT 300 ie	11-16	F	ET4 50 (Grimeca caliper)		F					
Liberty 50 4T (Heng Tong caliper)	00-08	F	MP3 400 ie	07-11	F	ET4 125		F					
Liberty S 50 (2T/4T)	07-08	F	MP3 Touring 400 ie	11-12	F	ET4 125/150		F					
Zip 100	06-13	F	MP3 Touring 400 ie LT	11-12	F	ET4 (Heng Tong Caliper)		F					
125 ie MP3 Yourban	11-12	F	MP3-LT 400 ie	09-10	F	LX 50 (2T)		F					
Liberty Elettrico	11-12	F	MP3 500 Efi	09-10	F	LX 50 (4T/4V)		F					
Liberty 125 (5 Spoke Wheel)	98-08	F	MP3 Touring Business 500 ie	11-12	F	LXV 50		F					
Liberty 125 (4T) 10 Spoke Cast Wheels)	09-14	F	MP3 500 LT Business	11-15	F	S 50 (2T)		F					
Liberty S125	07-08	F	MP3 Touring Sport 500 ie	11-12	F	S 50 (4T/4V)		F					
MP3-Hybrid (125cc)	09-12	F	MP3 500 LT Sport	11-15	F	S 50 Sport (2T)		F					
MP3-125ie (EFI models)	08-11	F	QUADRA			S 50 Sport (4T/4V)		F					
MP3 125 Carb models	06-08	F	4D	11	F&R	LX 125/150 (4T)		F					
Zip 125	00-01	F	SACHS			LX 125 (4T/Serie Speciali)		F					
Liberty 150	08	F	Speedjet RS 125	10	R	LXV 125		F					
Liberty 200	98-07	F	SFM			PX 125 (Disc Brake Model/2T)	01/05/11-16	F					
Liberty S 200	07-08	F	Speedjet RS 3 50	14-15	R	S 125 (4T)		F					
MP3 250 MIC/EFI	08-09	F	SYM			S 125 Sport (4T)		F					
MP3 250cc (EFI)	06-08	F	Symphony S 50 (4T) Rear Disc Model	10-21	R	LX 150 (4T)		F					
MP3 250 LT (EFI)	09	F	Symphony SR 50	10-15	R	LX 150 (4T/Serie Special)		F					
MP3 300 LT (EFI)	10-11	F	Symphony S 125 (4T/Rear Disc Model)	10-21	R	S 150 Sport (4T)		F					
MP3 300 ie (Hybrid)	11-15	F	Symphony 125 SR (4T/Rear Disc Model)	10-15	R	S 150 (4T)		F					
MP3 300 ie (Hybrid LT)	11-13	F	Symphony S 151 (4T/Rear Disc Model)	10-21	R	WK							
MP3 Business LT 300 ie	13	F	Symphony 151 SR (4T/Rear Disc Model)	10-15	R	WK GTR 50 (2T)		F					
MP3 Sport LT 300 ie	13	F						F					

FA261 A 115.5 x 41 x 8.5mm B 115.5 x 41 x 8.5mm

FA261/2 A 115.5 x 41 x 10.5mm B 115.5 x 41 x 10.5mm

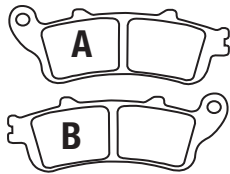

MATERIAL AVAILABILITY											
FA	TT	V	R	HH	MXS	SXR	EPFA	GPFAX	SFA	SFAC	SFAHH
		✓		✓			✓				

MATERIAL AVAILABILITY											
FA	TT	V	R	HH	MXS	SXR	EPFA	GPFAX	SFA	SFAC	SFAHH
FA261											
HONDA											
FJS 400 D6/D7/D8	06-08	F									02-07 F&R
FJS 400 A9/D9	09	F									08-09 R
FJS 600 1/2/D3-D7/A3-A7 Silverwing	01-09	F									
NT 650 V2/V3/V4/V5	02-05	F&R									08-17 R
NT 700 V6/VA6/VA7/V7/VA8/V8											
/VA/VAA Deauville	06-13	R									01-05 F
VFR 800 F/W/FiX/FiY/Fi1/2/3/4/5/A2-A5	98-05	F&R									02-08 F&R
VFR 800 6/8/9	06-09	R									13-17 F
VFR 800 A6/A8/A9	06-13	R									
VICTORY											
XL 1000 VX/VY/V1/V2 Varadero											08-09 F
- Non ABS Model	99-02	F&R									08-17 F
XL 1000 V3-V6 Varadero Non ABS	03-06	F&R									10-12 F
XL 1000 V7-V9/VA/VB Varadero											
- Non ABS	07-11	R									10-12 F
XL 1000 VA4-VA9/VAA/VAB Varadero ABS	04-11	R									
CB 1100 SFY/SF1 "XII"	00-04	F&R									15 R
CBR 1100 XXV/XXW/XXX											
/XXY/XX1-XX6 "Blackbird"	97-08	F&R									02-09 R
ST 1100 AT/AV/AW/AX/AY/A1/A2											
Pan European (ABS)	96-02	F&R									06-18 R
CTX 1300 AE	14-17	R									13-17 R
ST 1300 2/3/4/6 Pan European											
(Non ABS)	02-07	F&R									14-17 R

FA263 106 x 34 x 8.5mm



MATERIAL AVAILABILITY											
FA	TT	V	R	HH	MXS	SXR	EPFA	GPFAX	SFA	SFAC	SFAHH
							✓	✓			

AP/LOCKHEED AFTERMARKET CALIPER
6 Piston/2 Pins (CP4466)

PFM AFTERMARKET CALIPER
6 Piston Superbike Caliper

BRAKE PAD BUYERS GUIDE

DO NOT REFIT ANY SHIMS/INSULATORS TO EBC PADS FROM ORIGINAL PADS UNLESS INSTRUCTED ON NOTE ON PAD PACKAGING AND ON FA DRAWING ASSOCIATED WITH THAT PAD.

FA264 A 85 x 43 x 8mm B 70 x 41 x 8mm

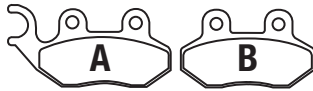

MATERIAL AVAILABILITY												
FA	TT	V	R	HH	MXS	SXR	EPFA	GPFA	SFA	SFAC	SFAHH	
✓		✓		✓					✓	✓	✓	

ADIVA SCOOTERS

AD 125/200	09-11	F	T-Rex 3 (50cc) (3 wheeler)	03-04	F	Jet 100 (G100P-6)						99-00	F
AR 125/200	10-11	F	Bubu 100/125	03-08	F	Allo 125 (4T)						11-15	F
AJS			T/Rex 50	99-12	F	City Com 125						08-10	F
Crazy 50 Naked	13-14	F	Charge 125 A/B	00-02	F	Crox 125 (4T)						15-21	F
BAROSSA			i-Charge 125	03-05	F	Fiddle II 125						08-15	F
XS 125 T-13	07-10	F	PMX 50	00-07	F	Fiddle III 125 (4T)						14-21	F
CAGIVA			PMX 50 Naked			Attila 125						99-00	F
Stella 50	97	F&R	PMX 110	00-07	F	HD 125 S Evo						07	F
Passing 125	93-97	F	T-Rex 110	99-06	F	HD Evo 125 (Carb & Efi models/4T							
GARELLI			Libra 125 Efi (4T)	09-12	F	/Single Headlamp)						03-13	F
KRS 50		F	Ligero 125	06-08	F	H2-125i (4T/Twin Headlamps)						10-15	F
Joker 125/150	02	F	Ligero 125 (4T)	08-12	F	Jet 4 (125cc 4T)						10-15	F
Freeland 125/150		F	T-Rex 125 (Wave disc)	08-12	F	Megalo 125						00-06	F
GENERIC/KSR			Tigra 125 (4V/4T)	12	F	Orbit II /Symply 125 (4T)						09-15	F
Vendetta 50 (2T)	12-13	F	Libra 150 (4T)	09	F	Super Duke 125/150						99-02	F
LAMBRETTA			TR-3 150cc (3 wheeler)	03-09	F	Symply 125						07-08	F
LJ/LT 50	12-13	F	SCOMADI			Symply 11 125						09-14	F
LN 125 (4T)	10-13	F	TL 200 Liquid Cooled	15-19	R	Symphony 125 S (4T)						09	F
LN 151 (4T)	10-13	F	SINNIS			Symphony S 125 (4T/Rear disc model)						10-21	F
PEUGEOT			Orbit II 50cc (4T)	12-14	F	Symphony 125 SR (4T/Rear disc model)						10-15	F
Tweet 50 (4T/Rear drum model)	10-13	F	Orbit II 50 Naked (4T)	12-14	F	Symphony 125 ST (4T/Rear disc model)						10-21	F
Tweet 50 RS (4T/Rear disc model)	10-13	F	Orbit II 50 TS (4T)	12-14	F	Allo 150 (4T)						11-15	F
New Tweet Evo 50 (4T/Rear drum model)	14-19	F	X-Pro 50	13-14	F	Crox 150 (4T)						15	F
New Tweet Evo RS 50 (4T)	14-15	F	SYM			Jet 4 150cc						13-15	F
Belville 125 Allure	18-21	F	Allo 50 (4T)	11-15	F	Fiddle 11 151						08-15	F
Belville 125 RS	18-21	F	Allo GT 50 (4T)	13-15	F	Symphony S 151 (4T/Rear disc model)						09-15	F
LXR 125 (4T)	10-13	F	Crox 50 (4T)	15-21	F	Symphony 151 SR (4T/Rear disc model)						10-15	F
New Tweet Evo 125 (4T/Rear disc model)	14-19	F	Fiddle II 50	08-15	F	Fiddle III 200i (4T)						14-21	F&R
New Tweet Evo RS 125 (4T)	14-19	F	Fiddle III 50 (4T)	14-21	F	H 200 SE						06	F
Tweet 125 (4T/Rear drum model)	10-12	F	Mask 50	00-05	F	HD 200 S Evo						07	F
Tweet 125 RS (4T/Rear disc model)	10-12	F	Jet Sport 50/Jet Sport 50 S	14-15	F	HD Evo 200 (Carb & Efi models							
New Tweet 150 (4T)	14-19	F	Jet 4 (50cc 4T)	10-15	F	/4T/Single Headlamp)						03-13	F
New Tweet RS 150 (4T)	14-19	F	Jet 4 R50 (2T)	11-15	F	HD2-200i (4T) Twin Headlights						10-15	F
Tweet 150 (4T/Rear drum model)	10-12	F	Jet 4 R Naked (50/4T)	13-15	F	Symphony 200 ST 4T Rear disc						14-21	F&R
Tweet 150 RS (4T/Rear disc model)	10-12	F	Jet Basix 50	06-09	F	City Com 300i						08-14	F&R
Belville 200 Allure	18-21	F	Jet Evo 50 (2T)	13-15	F	City Com S 300i CBS						15	F&R
Belville 200 RS	18-21	F	Jet 50/Euro XS	99-05	F	TGB							
LXR 200i (4T)	10-12	F	Jet Euro X 50	06-14	F	Akros Tec (50)						03-04	F
PGO			Jet Sport X 50 SR	06-15	F	Delivery 50 Scooter							
i-Dep Electric Scooter	09	F&R	Red Devil 50	99-09	F	(Up to E/F No 609099)						04-05	F
Big Max 50 S	03-04	F	Orbit II 50 (4T)	12-15	F	101 R (50cc)						04-08	F
Big Max 50 (Front wave disc)	07-09	F	Orbit II 50 Naked (4T)	12-15	F	202 Classic (50cc)						03-14	F
Big Max 50 Naked (Round disc			Orbit II 50 TS	12-15	F	Bellavita 125i (4T)						12-14	F
/no cover on H/bars)	07-09	F	Symply 50	07-08	F	Bellavita 300i (4T)						12-14	F
G-Max 50	05-07	F	Symphony 50 (4T)	09	F	TOMOS							
G-Max 50 (Wave disc)	08-09	F	Symphony 50 S (4T) Rear disc model	10-21	F	Twister 50/125							F
G-Max 50 Naked (Wave disc)	09	F	Symphony SR 50	10-15	F	ZERO (ELECTRIC MOTORCYCLES)							
Libra 50 (2T)	09	F	Symply 11 50	09-13	F	Zero DS ZF6/ZF9						10-12	F
Ligero 50 (2T)	08-12	F	Junngle 50	99-02	F	Zero S ZF6/ZF9						10-12	F
			X'Pro 50	13-15	F	Zero XU/X/MX						10-12	F

FA265 75 x 55.5 x 8.5mm

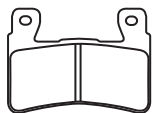

MATERIAL AVAILABILITY												
FA	TT	V	R	HH	MXS	SXR	EPFA	GPFA	SFA	SFAC	SFAHH	
				✓			✓					

HONDA			VTR 1000 SPY/SP1 (SC45)	00-01	F							
CBR 900 RRW/RRX/RRY/RR1-RR3			VTR 1000 SP-2/SP-3/SP-4/SP-5/SP-6	02-06	F							
'Fireblade'	98-03	F	CB 1300 F1 (SC40)	01	F							

DO NOT REFIT ANY SHIMS/INSULATORS TO EBC PADS FROM ORIGINAL PADS UNLESS INSTRUCTED ON NOTE ON PAD PACKAGING AND ON FA DRAWING ASSOCIATED WITH THAT PAD.

FA266 54 x 51 x 8mm



MATERIAL AVAILABILITY											
FA	TT	V	R	HH	MXS	SXR	EPFA	GPFA	SFA	SFAC	SFAHH
✓		✓	✓	✓			✓		✓	✓	✓

Model/Description	Year	Type	Material	Year	Material	Year	Material	Year	Material	Year	Material
ADIVA SCOOTERS											
Tre 1130 K Amazonas	07-15	R								750 Sport	01-02 R
AD2 (300 3 Wheel Type)	14-15	F	BIMOTA							796 Hypermotard	10-13 R
AD 400	09-11	F&R	Elirio	06	R					796 Monster (Non ABS models)	10-13 R
APRILIA											
DB5 (All models)	06-07	R								796 Monster (ABS models)	10-14 R
RS 50	06-11	F	DB5R	06	R					796 Monster 20th Anniversary Model	
RS 660 8V ABS	20-21	R	DB5 Desiderio (1078cc)	12-14	R					(ABS & Non ABS)	13 R
RS 660 8V Tuono ABS	20-21	R	DB6 Delirio 992cc Ducati engine)	07	R					800 Supersport	03-04 R
ETV 1000 Caponord			DB6 (1100cc)	08	R					821 Hypermotard	13-16 R
(Non ABS - Bolt fixing)	01-03	R	DB6R Delirio (1100cc)	08	R					821 Hypermotard SP	13-16 R
ETV 1000 Caponord Rally			DB7 (1098cc)	08-14	R					821 Hyperstrada	13-16 R
(Non ABS - Bush fixing)	03	R	DB8 (1198cc)	10-14	R					821 Monster	15-18 R
ETV 1000 Caponord (ABS - Bush fixing)	04-07	R	DB9 Brivido (1198cc)	12-14	R					821 Monster Dark/Monster Stripe	15-18 R
RSV 1000 Mille	98-02	R	DB9 Brivido S (1198cc)							848	08-10 R
RSV 1000 R Mille	98-02	R	(with BCA 6 piston caliper)	12-14	R					848 Evo (Monobloc front calipers)	10-13 R
RSV 1000 Mille (Radial caliper)	03	R	DB11 VLX (1198cc)	12-14	R					848 Streetfighter	11-15 R
RSV 1000 R Mille (Radial caliper)	03	R	DB12B Tourist (1198cc)	12-13	R					848 Evo Corse SE	12-13 R
RSV 1000 R Racing/Factory			BOMBARDIER								
(Radial caliper/4 pad)	04-08	R	Traxter (4x4)	99-01	F&R					848 Evo Dark	12 R
RSV 1000 R Tuono (Radial caliper/			BREMBO								
2 pin pad fixing)	07-08	R	Raptor/V-Raptor 650	00-07	R					899 Panigale	14-15 R
RSV 1000 SP	99-00	R	1000 Raptor/V-Raptor	00-05	R					900 Supersport	98-99 R
RSV 1000 R Factory	04-08	R	BRAMMO							900 Supersport IE	00-01 R
RSV 1000 R	04-08	R	Empulse R	12-13	R					900 Sport	02 R
RSV 1000 R Tuono	02-06	R	Enertia	12-13	R					900 MH Evoluzione	00-01 R
SL 1000 Falco	00-04	R	CAGIVA							Supersport (936cc)	17-18 R
Tuono R Factory 1000 Radial caliper			Raptor/V-Raptor 650	00-07	R					Supersport S (936cc)	17-18 R
/4 pad type	06-10	R	1000 Raptor/V-Raptor	00-05	R					939 Hypermotard/Hypermotard SP	16-18 R
Tuono R 1000 Radial caliper			BRAMMO								
/2 pad type	02-10	R	Empulse R	12-13	R					939 Hyperstrada	16-17 R
Tuono R 1000 Radial caliper			Enertia	12-13	R					ST2 (944cc)	97-03 R
/4 pad type	02-05	R	CF MOTO							Supersport 950 937cc	17-21 R
Tuono 4VR-APRC	11-13	R	CF 125 T-22 Glory	10-11	R					Supersport 950 S 937cc	17-21 R
Tuono V4R APRC ABS	14	R	CF 150 T-6A Glory	10-11	R					959 Panigale (ABS)	16-18 R
Tuono V4R	11-12	R	CF 250 T-6A Jetmax (Scooter)	12-14	R					959 Panigale Corse (ABS)	18 R
Tuono Factory 1100 V4	15-18	R	CPI							ST3 (Non ABS) (992cc)	04-07 R
Tuono 1100 RR V4	17-21	R	GTR 50	11-12	R					ST3 S (ABS Model) (992cc)	06-07 R
Tuono 1100 RR V4 Factory	19-21	R	X-Large 125/150/200	02-03	F&R					ST4S (ABS Model/996cc)	03-05 R
RSV4 R	10	R	DERBI							ST4S (Non ABS/996cc)	01-05 R
RSV4 R APRC	11-13	R	GP1 50 Euro 2 Chain Driven/Radial							ST4 (916cc)	99-02 R
RSV4 R APRC ABS	13-14	R	caliper 5 bolt fixing front disc	05	F					Desmosedici RR (D16RR/989cc)	08 R
RSV4 Factory	09-10	R	caliper 5 bolt fixing front disc							998 Panigale V4 Superleggera	21 R
RSV4 Factory APRC	11-13	R	caliper 5 bolt fixing front disc	05-07	F					999 S (Std caliper mount monoposto	
RSV4 Factory APRC ABS	13-14	R	GPR 50 Nude (Radial caliper)	04-09	F					/biposto)	03-04 R
RSV4 RF/RR 1000	15-18	R	GPR 50 Racing 40mm forks	08-10	F					999 (Std mount caliper)	03-06 R
RSV4 1100 Factory	19-21	R	/180mm rear disc/radial caliper							999 R (Radial mount caliper)	03-06 R
RSV4 1100 RR	19-21	R	GPR 50 40mm forks/180mm rear disc/radial caliper	04-07	F					999 R Fila (Radial mount caliper)	03- R
AUSA QUADS										999 S (Radial caliper Monoposto/biposto)	05-06 R
M 50 Task Side x Side		F&R	Senda DRD Pro 50 R Radial caliper	05-13	F					999 R Xerox	06 R
BENELLI										Multistrada 1000 DS (992cc)	02-06 R
TRE-K 502	16	R	Senda DRD Pro 50 SM Radial caliper							Multistrada S 1000 DS (992cc)	05-06 R
BN 600 GT	14-15	R	/260mm disc	05-14	F					Supersport 1000 DS (992cc)	03-06 R
BN 600 i	14-15	R	/300mm disc	05-14	F					1098	07-08 R
BN 600 R	14-16	R	Senda DRD 50 Evo SM (Cast wheels)	08-11	F					1098 S	07-08 R
BN 600 S	14-15	R	Senda DRD X-Treme 50 SM (Cast Wheel							1098 S Tricolore	07 R
2 UE 750	09-10	R	/260mm F disc/17" front wheel)	11-14	F					1098 R	08-09 R
800 Leoncino	20-21	R	GRP 80 Cup (Radial Caliper)	04-05	F					Hypermotard 1100/1100 S	07-09 R
800 Trail	20-21	R	GP1 125cc Scooter Full height seat							Multistrada 1100/1100 S (1078cc)	07-09 R
Cafe 899 Racer	10-12	R	/5 bolt fixing front disc	06	F&R					1100 Monster (ABS & Non ABS)	09-10 R
Century Racer 899	11-12	R	Mulhacen 125 Cafe Cast wheel							1100 S Monster (ABS & Non ABS)	09-10 R
TNT 899 Tornado Naked Tre	07-16	R	/radial caliper	08-10	F					Monster Diesel 1100	13 R
TNT 899 S Tornado Naked Tre	07-11	R	Senda DRD 125 R	10-12	F					Streetfighter 1100 (1099cc)	09-11 R
Tre-k 899	07-16	R	Senda DRD 125 SM	10-14	F					Streetfighter 1100 S (1099cc)	09-13 R
Tornado 900	02	R	GP1 250cc Scooter	06-07	F&R					1100 Evo Hypermotard	10-12 R
Tornado LE/Tre Novecento/RS	03-05	R	Mulhacen 659	06-08	R					1100 Evo SP Hypermotard	10-12 R
Century 1130 Racer	11-12	R	DUCATI							1100 Monster Evo	11-13 R
TNT 1130 Sport/Sport Evo	04-09	R	696 Monster	08-14	R					Monster 1100 Evo 20th	
TNT 1130 Cafe Racer	05-12	R	696 + Monster (inc ABS Models)	09-12	R					Anniversary Model	13 R
TNT 1130 Titanium	05-06	R	Monster 696 20th Anniversary Model	13	R					1103 Panigale V4	18-21 R
Tornado TRE1130 (Radial caliper)	06-10	R	749 Dark (Monoposto/Biposto)	04-06	R					1103 Panigale V4 S	18-21 R
Tornado Naked Tre R 160	09-12	R	749 R (Radial caliper)	04-06	R					1103 Panigale V4 SP	21 R
Tornado Naked Tre TNT 1130	06-07	R	749 S (Monoposto/Biposto)	03-06	R					1103 Panigale V4 R	21 R
Tornado Naked Tre 1130 TNT R	13-16	R	749 (Monoposto/Biposto)	03-06	R					Panigale V4 SP (1103cc)	21 R
Tre 1130 K	06-17	R	750 Supersport	99	R					Streetfighter V4	19-21 R
			750 Supersport IE	00-02	R					Streetfighter V4 S	19-21 R
										1198	09-11 R
										1198 S	09-10 R

BRAKE PAD BUYERS GUIDE

DO NOT REFIT ANY SHIMS/INSULATORS TO EBC PADS FROM ORIGINAL PADS UNLESS INSTRUCTED ON NOTE ON PAD PACKAGING AND ON FA DRAWING ASSOCIATED WITH THAT PAD.

FA266 54 x 51 x 8mm

Contd.

1198 R/S Corse	10	R	YP 125 D Skyliner	00-10	R	X9 125	00-02	F&R
1198 SP	11	R	YP 125 Skycruier	06-10	R	X9 125 Evolution (Brembo single pin fixing)	03-04	F&R
1199 Panigale	12-13	R	MONDIAL					
1199 Panigale ABS	12-15	R	Piega 1000	03-04	R	X9 125 Evolution	05-07	R
1199 Panigale S ABS	12-15	R	EVO	04	R	X9 180 Amalfi	00-03	F&R
1199 Panigale S Tricolore	12-13	R	MOTO GUZZI			X8 200	04-05	R
1199 Panigale R	13-16	R	750 Brevia ie (3 spoke cast wheels)	03-07	R	X9 200	02-03	F&R
1199 Superleggera	14	R	750 Nevada	02-11	R	X9 200 Evolution	03-04	F&R
1200 Monster	14-21	R	750 Nevada Classic ie (spoke wheels)	04-15	R	X9 250/250 SL	00-04	F&R
1200 S Monster	14-21	R	750 Nevada Club (From LK112434-)	00-01	R	X9 250 Linked brake f&r wheel 14" dia	04	R
1200 S Monster Stripe	15	R	750 V7 Classic	08-12	R	Beverley Tourer 400 ie	08-09	F&R
1200 R Monster	16-18	R	750 V7 Cafe Classic	09-12	R	Beverley B500	02-04	F&R
1200 Multistrada Standard	10-11	R	750 V7 Racer	10-11	R	Beverley 500	06	F
1200 Multistrada ABS	10-14	R	1000 MGS-01 Corsa	03-11	R	Beverley Cruiser 500 ie	07-11	F&R
1200 Multistrada DVT	15	R	1100 California EV	98-00	R	Beverley 500 ie	12	F&R
1200 Multistrada 1200 S Pikes Peak	11-14	R	V 1100 Brevia	04	R	X9 500/500 SL	00-02	F&R
1200 S Multistrada Sport Edition	10-12	R	Fionda 1100	05	R	X9 500cc Evolution (inc ABS)	03-06	R
1200 S Multistrada Touring Edition	10-14	R	MOTO MORINI			X9 500 ie	07	R
1200 S Multistrada DVT	15	R	Corsaro 1200	05-10	R	RIEJU		
1200 S Multistrada D Air DVT	15	R	Corsaro 1200 Veloce	07-08	R	Tango 50 (2T)	07-12	F
1200 S Multistrada Granturismo	13-14	R	9 1/2 (1200cc)	06-10	R	MRT-Pro 50 (Radial/double piston caliper)	09-20	F
1299 Panigale	15-18	R	Corsaro Avio	08	R	MRT Pro Supermotard		
1299 Panigale R	15-17	R	Rebello 1200 Giubileo	12-13	R	(Radial caliper/cast wheel)	09-15	F
1299 Panigale R Final Edition	18	R	Scrambler 1200	08-09	R	Marathon Pro Supermotard 125		
1299 Panigale S	15-18	R	1200 Sport	08-10	R	(Cast wheel/radial caliper)	09-20	F
1299 Superleggera	17	R	MV			Marathon Pro 125 (
ENERGICA ELECTRIC			675 F3 Serie Oro	12-13	R	Radial/double piston caliper)	09-15	F
Electric EVA	20-21	R	675 F3	12-20	R	RS3 NKD 50	12-20	F
Electric EVA Ribelle	21	R	675 F3 RC	15-18	R	City Line 125 ie	13-15	R
Electric EVA Ribelle RS	21	R	675 Brutale	12-17	R	SMX 125	07-08	F
Electric EGO	20-21	R	Brutale 800	12-18	R	Tango 125	06-20	F
Electric EVA Esse Esse 9	20-21	R	800 Brutale Dragster	14-15	R	Tango 125 Motard (Cast wheel)	08-10	F
GENERIC			800 Dragster RC	17-21	R	Tango Pro 125	07-10	F
GRS 600	13-14	R	800 Dragster RR	15-21	R	RS3 NKD 125	11-20	F
GILERA			800 Brutale RR/RR SCS	19-21	R	Marathon 200 Pro SM	11-15	F
Nexus 500	03-11	R	800 Brutale Rosso	19-21	R	Tango 250	08-11	F
GOGORO (E SCOOTER)			800 Dragster RR SCS	19-21	R	City Line 300 ie	14-15	R
SMART SCOOTER	15-17	F	800 Dragster Rosso	19-21	R	SINNIS		
HARLEY DAVIDSON			Rivale 800	14-18	R	Ecocity 125 (125T-8G)	07-09	R
LiveWire	18-20	R	800 F3	13-18	R	SUZUKI		
HONDA			800 F3 Ago	14-15	R	UH 125 K2/K3/K4/K5/K6 Burgman	02-06	R
CBR 1000 RR-SP Fireblade ABS/			800 F3 RC	15-20	R	TOMOS		
Brembo F/calipers	14-21	R	800 Stradale	15	R	SM 125 F	05-08	F
RC 213 V-S	15-17	R	800 Turismo Veloce	14-21	R	VECTRIX		
HOREX			800 Turismo Veloce RC	17-21	R	VX-3 Li+ (3 wheeler model)	12-13	F
VR6 Classic	13-14	R	800 Turismo Veloce Lusso	15-21	R	VOXON		
VR6 Roadster	11-14	R	NORTON			Cafe Racer	06	R
INDIAN			961 Commando Sport	10-20	R	Roadster	06	R
FTR 1200	18-20	R	961 Commando Cafe Racer	10-20	R	W.K. BIKES		
FTR 1200 S	19-20	R	961 Commando Dominator SS	15-20	R	WK GTR 50 (2T)	10-14	F
FTR 1200 S Race Replica	19-20	R	961 Commando SE	10-11	R	WK 125 SC (4T) (14" wheels)	10-14	R
FTR Rally	20	R	961 Commander SF	10-15	R	WK Jetmax 250 (4T)	10-14	R
KAWASAKI			PETRONAS			YAMAHA		
H2 Ninja (ZX 1000 NFF/NGF)	15-16	R	FP1	05	R	XQ 125/150 Maxster	01-03	R
H2 R Ninja (ZX 1000 PFF.PGF)	15-16	R	PEUGEOT			VP 125 X-City (16P)	08-15	R
Ninja H2 (ZX1000 XHF/XJF)	17-20	R	Speedfight 3 50cc (L/C 2T)	09-15	R	YP 125 Majesty	01-09	R
Ninja H2 Carbon (ZX1000 XHFA/XJFA)	17-20	R	Speedfight 3-RS (50cc-L/C 2T)	09-12	R	YP 125 R X-Max	06-10	R
Ninja H2R (ZX1000 YHF/YJF)	17-20	R	Speedfight 3 RS (50cc AC)	10-12	R	YP 125 R (X-Max - Non ABS)		
Z H2	20-21	R	Speedfight 3 Darkside (50cc/LC/2T)	13-15	R	(39D1/5) Nissin F/Caliper	10-15	R
KEEWAY			Speedfight 3 Furious (50cc/LC/2T)	13	R	YP 125 R X-Max		
125/150 Cityblade	13-14	F	Speedfight 3 Iceblade (50cc/LC/2T)	13	R	(2DM/Brembo R/Caliper)	14-16	
Silverblade 125/150/250	07	R	Speedfight 4 Classic (50cc/LC/2T & 4T)	15-20	R	YP 125 R X-Max Sport	11-12	R
KTM			Speedfight 4 Darkside (50cc/LC/2T & 4T)	15-18	R	YP 180 Majesty	06	R
RC8 (1190cc)	08-11	R	Speedfight 4 Iceblade (50cc/LC/2T & 4T)	15-18	R	VOXAN		
RC8 R (1190cc)/Track	09-15	R	Speedfight 4 Pure (50cc/LC/2T & 4T)	15-18	R	Cyclope 1000	02	R
1290 Super Duke R	14-20	R	Speedfight 4 R-Cup (50cc/LC/2T)	18-20	R	Cafe Racer 1000	02-08	R
1290 Super Duke R SE	16-18	R	City Star 125cc I Active	13-14	R	Roadster 1000	02-08	R
1290 Super Duke GT	16-20	R	125 Django Heritage (4T)	14-19	R	Black Magic	04-08	R
LAVERDA			Speedfight 3 125 (4T)	14-15	F	Street Scrambler	03-05/07-08	R
SFC 1000	03-04	R	Speedfight 3 125 Darkside (4T)	14-15	F	VB1-Evo	03-04	R
MALAGUTI			Speedfight 3 125 Iceblade (4T)	14-15	F	GTV 1200	08	R
NKD 50 Drakon	05-09	F	Speedfight 3 125 Team (4T)	14-15	F			
Drakon S	06	F	Django 150 Heritage (4T/196mm Rear Disc)	14-19	R			
MBK			PIAGGIO					
VP 125 Cityliner	08-10	R	X8 125	04-05	R			
XQ 125/150 Thunder	01-03	R						

BUYERS GUIDE

DO NOT REFIT ANY SHIMS/INSULATORS TO EBC PADS FROM ORIGINAL PADS UNLESS INSTRUCTED ON NOTE ON PAD PACKAGING AND ON FA DRAWING ASSOCIATED WITH THAT PAD.

FA267 52 x 60 x 9mm



MATERIAL AVAILABILITY												
FA	TT	V	R	HH	MXS	SXR	EPFA	GPFAX	SFA	SFAC	SFAHH	
✓				✓								

YAMAHA

YZF 1000 R1	98-00	R
YZF R7 750 '0W02' Road version	99-00	R
XJR 1300 (5EA9/5EAG) (298mm front disc)	00	R

SFA268 46 x 53 x 6.5mm



MATERIAL AVAILABILITY												
FA	TT	V	R	HH	MXS	SXR	EPFA	GPFAX	SFA	SFAC	SFAHH	
									✓	✓	✓	

YAMAHA

Aerox 4 (NS 50 F)	14-18	R	YQ 50 Nitro	97-10	R
NS 50 Aerox (2T)	13-16	R	YQ 50 Nitro Naked	06-10	R
NS 50 N Aerox Naked (2T)	13-16	R	QUADRO		
YQ 50 Aerox R/Aerox	97-16	R	QV3	18-20	R
EW 50 Slider	00-05	F	Qooder	18-20	R
MBK					
EW 50 Stunt	00-06	F			
EW 50 Stunt Naked	05-10	F			

FA270 74 x 53 x 7mm



MATERIAL AVAILABILITY												
FA	TT	V	R	HH	MXS	SXR	EPFA	GPFAX	SFA	SFAC	SFAHH	
	✓		✓									

POLARIS

Most models 98 onwards. Check application pages for fitment details.			CUV 300 E 4x4 Side by Side	08-09	R
			QZ 300 E 4x4		R
			320 e4x4	07-08	R
			CVT 320 e	07-11	R
QUADZILLA			QZ 320 E 4x4	09	R
CVT 150 E (Parking brake)	10-11		400 4x4	06-07	R
Quadzilla 300 "Utility"	04-06	R	LINHA!		
300 E SUV	06	R	Muddy 300 4 x 4 (ATV) (Parking Brake)	07-09	
300 E (4x4) (Auto)	06-07	R			

FA271 67.5 x 44 x 8mm



MATERIAL AVAILABILITY												
FA	TT	V	R	HH	MXS	SXR	EPFA	GPFAX	SFA	SFAC	SFAHH	
	✓		✓									

ARCTIC CAT

Most models	96-04	F&R	MASSEY FERGUSON (ATV)		
Check application fitment details			MF 250 (2WD/4WD)	04	F&R
			MF 300 (2WD/4WD)	04	F&R
LAVERDA			MF 400 4WD	04	F&R
Quasar 4x4 500c	04	F&R	MF 400 Auto 4WD	04	F&R
Quasar 4x4 500	04	F&R	MF 500 (Auto 4WD) TBX Auto	04	F&R
Quasar 4x4 400	04	F&R	WILWOOD		
			PS1 Caliper (Part # 150-4091K)		

FA272 39.5 x 44.5 x 7mm



MATERIAL AVAILABILITY												
FA	TT	V	R	HH	MXS	SXR	EPFA	GPFAX	SFA	SFAC	SFAHH	
✓												

AP LOCKHEED CALIPERS

2 Piston / 1 Pin (CP4226-2S0)
2 Piston / 1 Pin (CP4227-2S0)
2 Piston / 1 Pin (CP7003-2S0) Radial mount

FA273 60.5 x 50.5 x 12.5mm

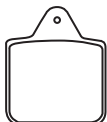

MATERIAL AVAILABILITY												
FA	TT	V	R	HH	MXS	SXR	EPFA	GPFAX	SFA	SFAC	SFAHH	
			✓									

POLARIS

Big Boss 400 L 6x6	96	
400 Big Boss L 6x6	96	Middle Axle Brake
Big Boss 425 6x6	96	Middle Axle Brake
425 Magnum 6x6	96	Middle Axle Brake
Ranger	99	R

FA275 99.5 x 30 x 9mm



MATERIAL AVAILABILITY												
FA	TT	V	R	HH	MXS	SXR	EPFA	GPFA	SFA	SFAC	SFAHH	
✓	✓			✓					✓	✓	✓	

MATERIAL AVAILABILITY												
FA	TT	V	R	HH	MXS	SXR	EPFA	GPFA	SFA	SFAC	SFAHH	
YAMAHA												
RZ 50 (5FC1/2)					02	F			VP 250 X-City			07-16 R
T 105 E (5ER1/2) Crypton-R					99	F			XP 250 R X-Max (ICO)			05-09 R
T 105 SE Crypton (5EA3)					02	F			(Brembo Front Caliper/Non ABS)			
V 110 ZE/ZK/ZHE/ZHK FIZR/FIZR Sport					96	F			XP 250 R X-Max (37P)			10-13 R
AT 115 Neo (Brasil) (2B81/2/3)					05-07	F			(Nissin front caliper/Non ABS)			16 R
AT 115 (Neo CVT/Brasil) (15S1)					08	F			XP 250 RA X-Max - Iron-Max (ABS)			05-09 R
TW 125 (5EK/5RS)					99-04	F			YP 250 R (X-Max)			98-03 R
XP 125 RA X-Max - Iron-Max (ABS)					16	R			YP 250 DX/A Majesty			11-16 R
YP 125 RA X-Max ABS									YP 250 R X-Max (ABS)			11-12 R
(39D2/Nissin F/Caliper)					11-17	R			YP 250 R X-Max Sport			16 R
YP 125 X-Max Business (ABS)					11	R			XP 400 RA X-Max - Iron Max (ABS)			13-16 R
TW 200 (2JL/4CS1/2/3/5)					91-98	F			YP 400 R X-Max (Non ABS)			13-18 R
TW 200 E (4CS4/6/5LB1/2)					98-01	F			YP 400 RA X-Max (ABS)			
ST 225 (5BT) Bronco					97	F			LINHAI			06-07 R
TW 225 E (5VC1/2)					02-03	F			Monarch 125/150 T			07-08 R
XT 225 WE (4JG5/6) Serrow					97-98	F			Main Street 300cc (Scooter)			
Serrow 250 (3C51/52)					05	F			MBK			98-02 R
XG 250 Tricker (5XT1)					04-06	F			YP 250 Skyliner 250 (+ABS)			
XT 250 Serrow (3C51/2)					05-08	F			ITALJET			02 R
									Jupiter 125/150			

FA281 115.5 x 41 x 9.5mm



MATERIAL AVAILABILITY												
FA	TT	V	R	HH	MXS	SXR	EPFA	GPFA	SFA	SFAC	SFAHH	
				✓					✓	✓	✓	

MATERIAL AVAILABILITY												
FA	TT	V	R	HH	MXS	SXR	EPFA	GPFA	SFA	SFAC	SFAHH	
GARELLI												
SkyNet 250/400					02	F			Non ABS 256mm front disc			06-08 F
									FJS 600 1/2/D3-D7/A3-A7 Silverwing			01-08 F
HONDA												
FES 125 W/Y/1/2/3/4/5 Pantheon					98-06	F			KAWASAKI			
FES 150 W/Y/1/2/3/4/5 Pantheon					98-06	F			EN650 AFF/AGF/AGFA/CHF/CGF			
FES 250 W/X/Y/1/2/5 Foresight					98-05	F			/CGFA Vulcan S - Non ABS			15-21 F
NSS 250 Y/AY/1/A1/A3/3 Forza									EN650 BFF/BGF/BGFA/BGFB/DHF			
/Forza-S/Forza-T/Forza-ST/Jazz									/DHFA/EHF/DJF/DJFA/EJF/EJFA			15-21 F
/Reflex (MF04/MF06)					00-04	F			/FJF/FJFA Vulcan S - ABS			
FJS 400 Silverwing D6/D7/D8									PEUGEOT			01-02 F
									SV 250			

SFA283/4 53.5 x 44.5 x 8.5mm



MATERIAL AVAILABILITY												
FA	TT	V	R	HH	MXS	SXR	EPFA	GPFA	SFA	SFAC	SFAHH	
✓									✓	✓	✓	

MATERIAL AVAILABILITY												
FA	TT	V	R	HH	MXS	SXR	EPFA	GPFA	SFA	SFAC	SFAHH	
KAWASAKI												
SC 250 A1 Epsilon					02-03	F			SYM			04 F
									GT 500			
SUZUKI												
AN 250 W/X/Y Burgman/Skywave					98-00	F						
AN 250 K1/K2 Burgman/Skywave					01-02	F						
AN 250 K3-K6 Burgman (CJ43A)					03-06	F						
AN 400 X/Y/K1/K2 Burgman/Skywave					99-02	F						
AN 400 K3-K6 Burgman/Skywave					03-06	F						

FA291 43.5 x 57 x 6.5mm



MATERIAL AVAILABILITY												
FA	TT	V	R	HH	MXS	SXR	EPFA	GPFA	SFA	SFAC	SFAHH	
✓												

MATERIAL AVAILABILITY												
FA	TT	V	R	HH	MXS	SXR	EPFA	GPFA	SFA	SFAC	SFAHH	
GAS-GAS												
TXE Electric Bike					20	F			TXT 125/200/249/280/321			00-03 F&R
Cross MC 50					06	F			Pampera 250			02-03 R
125/200/249/270/280/321 TXT					99-03	F&R			GAS GAS (Pierer Mob)			
50/80 TXT					01-02	F&R			TXT Racing 125cc 2T			21-22 F
50 EC Rookie					01-02	R			TXT GP 125cc 2T			21-22 F
50 EC Boy					01	F&R			TXT Racing 250cc 2T			21-22 F
TXT Boy 50/280					01	F&R			TXT GP 250cc 2T			21-22 F
EC Boy 50					01	F&R			TXT Racing 280cc 2T			21-22 F
EC 50 (Boy)					01-04	F&R			TXT GP 280cc 2T			21-22 F
EC 50 (Rookie)					01-04	R			TXT Racing 300cc 2T			21-22 F
EC 50					05	R			TXT GP 300cc 2T			21-22 F
TXT 50 (Boy)					01	F&R						
TXT 50 (Rookie)					02-03	F&R						
SM 50 (Rookie)					01-04	R						
SM 50					05	R						
TXT 80 (Rookie)					02-03	F&R						
Pampera 125/250/280					04	R						
Pampera 250					02	R						
SM 50 Rookie					01-02	R						
TXT 200/270/321					99	F&R						

FA293 22 x 6mm

MATERIAL AVAILABILITY												
FA	TT	V	R	HH	MXS	SXR	EPFA	GPFA	SFA	SFAC	SFAHH	
✓												

MINI MOTO
Pasini/GRC
HRD
SX 50 Mini Cross

POLINI
Mini Bikes
F&R

FA294 81 x 46 x 7.5mm

MATERIAL AVAILABILITY												
FA	TT	V	R	HH	MXS	SXR	EPFA	GPFA	SFA	SFAC	SFAHH	
				✓			✓					

BMW								R 1200 C Classic		03-04	F
R 850 R			04-06	F		R 1200 R SE				10-11	F
R 1100 S (with integral ABS)	12/00-06	F			R 1200 R Classic					11-12	F
R 1150 GS (EVO - R21/0415/0495)	11/01-03	F			R 1200 R					12/07-13	F
R 1150 GS Adventure	07/01-06	F			K 1200 R Sport					07	F
R 1150 R/RS	01-06	F			K 1200 LT (Evo Integral ABS/						
R 1150 R Rockster	03-06	F			Disc has fixed bobbins)					08-09	F
R 1150 Rockster Edition 80	04	F			K 1300 R					09-12	F
K 1200 LT	11/00-09	F			K 1300 R Dynamic					11-15	F
K 1200 R (Urban)	05-08	F			K 1300 R Carbon					12	F
K 1200 R (K27/0378) Tokico Caliper	06-11	F			KAWASAKI						
R 1200 CL	02-04	F			ZRX 400 (ZR 400 E4-E7)					98-01	F
R 1200 C Independent (Cast wheel)	03-04	F									
R 1200 C Montauk	04	F									

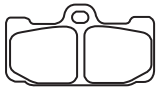
EPFA295HH 77.5 x 53 x 7mm

MATERIAL AVAILABILITY												
FA	TT	V	R	HH	MXS	SXR	EPFA	GPFA	SFA	SFAC	SFAHH	
							✓	✓				

BREMBO
X9737 80/81 Radial Mount Endurance Caliper
108mm Spacing

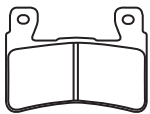
FA296 75 x 55.5 x 7.5mm

MATERIAL AVAILABILITY												
FA	TT	V	R	HH	MXS	SXR	EPFA	GPFA	SFA	SFAC	SFAHH	
				✓			✓	✓				

HARLEY DAVIDSON								CBR 600 F3/F4/F5/F6		03-06	F
XR 1200			08-10	F		CBR 600 RR3/RR4				03-04	F
XR 1200 X			10-12	F		CB 1000 R				17-21	F
FXST Softail Deluxe/Standard			15	F		CB 1100 AE (Cast Wheels					
FLS Softail Slim			15-17	F		/2 Piston Caliper)				13	F
FXSB Breakout			15-17	F		CB 1100 EX (SAE)				14-21	F
FLSTF Fatboy			15-17	F		CB 1300 F3/F13				03-04	F
FLFB Fat Boy			18	F		CB 1300 5/6/7/8/9 (Superfour)				05-09	F
FLSTFB Fatboy LO			15-17	F		CB 1300 A5/A6/A7/A8/A9					
FLFBS Fat Boy 114			18	F		(Superfour ABS)				05-09	F
FLFBS Fat Boy 114 Anniv			18	F		CB 1300 SA5/SA6/SA7/SA8/SA9				05-09	F
FLSTC Heritage Softail Classic			15-17	F		F6C Goldwing (4 Piston Caliper)					
FLHC Heritage Classic			18	F		(GLF6CAE)				14-17	F
FLHCS Heritage Classic 114			18	F		HYOSUNG					
FLHCS Heritage Classic 114 Anniv.			18	F		GD 250 i Naked				13-15	F
FLSS Softail Slim S			16-20	F		GT 650 (Naked)				09-12	F
FLSL Softail Slim			18	F		GT 650 i R				09-15	F
FXSB Softail Breakout			16	F		GT 650 i (Naked)				12-15	F
FXBR Breakout			18-20	F		ST7 (ST 700 i)				10-15	F
FXBRS Breakout 114			18-20	F		ST7 Deluxe (ST 700 i)				12-15	R
FXBRS Breakout 114 Anniv.			18-20	F		KAWASAKI					
FLSTFBS Fat Boy S			16-17	F		Ninja ZX-6R (Non ABS - 636cc)				13-20	F
FLDE Deluxe			18-20	F		Ninja ZX-6R (Non ABS/KRT Edition					
FXBB Street Bob			18-20	F		- 636cc)				16-20	F
FXFB Fat Bob			18-20	F		Ninja ZX-6R (ABS - 636cc)				13-20	F
FXBS Fat Bob			18-20	F		Ninja ZX-6R (ABS/KRT Edition - 636cc)				16-20	F
FXLR Low Rider			18-20	F		ZX-6R 30th Anniversary Edition					
HONDA						(ZX 636 EPPA/Non ABS/636cc)				15	F
CB 400 SFX/SFY/SF1-SF3 Super Four	99-03	F				ZX-6R 30th Anniversary Edition					
CB 400 SF4/5/S5 (NC39)	04-05	F				(ZX 636 FFFA ABS/636cc)				13-15	F
CBR 600 FX/FY	99-00	F									
CBR 600 F1/F2/CBR 600											
FS1/FS2 'Sport'	01-02	F									

Part numbers, prefixes, suffixes, photos and illustrations shown in this catalogue are trademarks and/or copyrights of EBC Brakes or the trademark owner A C Freeman Investments Limited and use without express written permission of the owners is punishable by law.

FA297 A. 105 x 43.5 x 8mm
B. 66 x 36.5 x 12.5mm

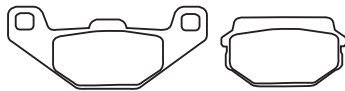

MATERIAL AVAILABILITY											
FA	TT	V	R	HH	MXS	SXR	EPFA	GPFA	SFA	SFAC	SFAHH
✓											

SYM
 Huskey 125/150
 CT 125

99-05 F
 03-04 F

FA298 51 x 53.5 x 9.5mm



MATERIAL AVAILABILITY											
FA	TT	V	R	HH	MXS	SXR	EPFA	GPFA	SFA	SFAC	SFAHH
✓									✓	✓	✓

APRILIA

Scarabeo 50 (Ditech) (2T) (SCA00)	01-04	R	BX 250 Motard	16-18	R	KXV 200					14	R
SR 50 Ditech (LC) (RLD100)	02-03	R	BN251	14-16	R	RKX 200					13-14	R
SR 50 Street (LC/2T) (TE00/TEA00)	03-15	R	Velvet 250	99-12	R	RKV 200 S Factory					14	R
SR 50 R/Factory (LC/2T) (VFB00/VFD00)	04-18	R	BN302	15-16	R	RKV 200 S					14	R
SR 50 H20 (ditech) (RLA1/RLB1)	00-03	R	Velvet 400	03-04	R	TX 200 (19" f/wheel)					13-14	R
SR 50 R SBK Aprilia (Replica) (LC)	10-11	R	BETA									
Atlantic 125/200/250	03-06	R	Eikon 125/150	00-06	R	Madison T125/150/R180/S250					99-03	R
Atlantic 125	03-08/10	R	BAOTIAN			Madison 125-3					06-09	R
RS 125 (Radial Caliper model) 2T	06-14	R	Falcon 50	10-11	R	F18 Warrior 125/150					00-03	R
Scarabeo 125/150/200	99-02	R	DERBI			Phantom Max 125/200					04-08	R
Scarabeo 125/200	03/07-09	R	Boulevard S125	07	R	R 125 Madison					03-07	R
Scarabeo 125/150/250 GT	04-06	R	Rambla 125	08-12	R	Madison S 200					04	R
Sport City 125	04-08	R	Rambla 250 i	08-09	R	Madison 250 ie 3					06-10	R
Sport City Cube 125	08-12	R	Rambla 300 i	10-12	R	Password 250					05-11	R
Atlantic 200	03-05	R	GENERIC/KSR			Phantom Max 250					04-08	R
Sport City 200	04-08	R	Code S 125/150/200 (4T)	12-16	R	250 Madison					04-07	R
Sport City Cube 200	08-10	R	Code X 125/150/200 (4T)	12-16	R	Scarabeo 300 S					09-10	R
Atlantic 250 ie	06-08	R	GRS 125	17-20	R	Madison K 400					02-06	R
Atlantic 250	03-05	R	TR 125 SM (4T)	12-18	R	Spidermax RS 500					04-11	R
Leonardo 250 ST/SP	00-04	R	TR 125 X	17-18	R	Spidermax GT 500					04-10	R
Scarabeo 250	06	R	TW 125 SM	13-18	R	SCARABEO						
Scarabeo 250 ie	07-10	R	Worx 125/150 (4T)	12-16	R	125 ie					10-15	R
Sport City 250 ie	06-08	R	H P POWER			125 Net					10-11	R
Sport City Cube 250	08-09	R	Iron 50 (2T)	10-12	R	200 ie					10-15	R
Atlantic 300	10-11	R	HUSQVARNA			200 Net					10-11	R
Sport Cube 300 Blackline	11	R	GD 250 N	13-14	R	300 S					09-11	R
Leonardo 300	05-06	R	HYOSUNG			500 ie					10-11	R
Sport City Cube 300	08-12	R	GD 250 i Naked	13-15	R	TGB						
Atlantic Sprint 400	05-08	R	GT 250 i R (Efi)	14-15	R	Bellavita 125i (4T)					12-14	R
Scarabeo 400 ie	07-08	R	GT 650 i R	14-15	R	Bellavita 300i (4T)					12-14	R
Atlantic 500	02-04	R	ITALJET									
Atlantic Sprint 500	05-08	R	Marco Polo 400cc Scooter	07-09	R							
Scarabeo 500	03-06	R	KEEWAY									
Scarabeo 500 ie	07-09	R	RKV 125	10-15	R							
Scarabeo 500 Light	07	R	TX 125 SM (17" f/wheel)	13-15	R							
BENELLI			Cityblade 125	13-14	R							
Velvet 125/150 (13" front wheel /touring)	08-12	R	RKV 150	13-15	R							
X 125	12-13	R	RKX 150	13-14	R							
			KXM 200	14	R							

SFA301 54 x 51 x 8mm

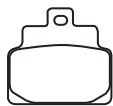

MATERIAL AVAILABILITY											
FA	TT	V	R	HH	MXS	SXR	EPFA	GPFA	SFA	SFAC	SFAHH
									✓	✓	✓

APRILIA							Leonardo 125/150 ST/SP				99-04	F&R
Scarabeo 100 (2T)				00	F	Leonardo 125					05-06	F&R
Scarabeo 100 (4T) (SA000/VA000)	01-09	F	SR 125/150								99-02	F
Habana 125	00-02	F	Mojito/Mojito Custom 125								03-12	F

FA302 A 67.5 x 36.5 x 7.5mm
B 52 x 40 x 7.5mm



MATERIAL AVAILABILITY											
FA	TT	V	R	HH	MXS	SXR	EPFA	GPFA	SFA	SFAC	SFAHH
	✓		✓								

KAWASAKI							SUZUKI					
KX 65				00-22	F	RM 65 K3/K4/K5					03-05	F

DO NOT REFIT ANY SHIMS/INSULATORS TO EBC PADS FROM ORIGINAL PADS UNLESS INSTRUCTED ON NOTE ON PAD PACKAGING AND ON FA DRAWING ASSOCIATED WITH THAT PAD.

FA303 50 x 44 x 6mm



MATERIAL AVAILABILITY											
FA	TT	V	R	HH	MXS	SXR	EPFA	GPFA	SFA	SFAC	SFAHH
	✓										

Model	Year	Prefix	Model	Year	Prefix	Model	Year	Prefix	Model	Year	Prefix
AJP			TXT 125 Randonne (4T)	11-15	F	SY 250 F (4T) Long Ride	07-08	F			
PR3 125 Enduro	08-12	R	TXT 200 Randonne (4T)	11-15	F	SY 250 R (2T)	00-09	F			
PR3 125 Enduro Pro	10-12	R	EC 50 Boy (LC)	05-07	F	SY 250 FR Long Ride	10	F			
PR3 125 Supermoto	08-12	R	TXT 50/80 Rookie	04-09	F	SY 250 FR	06-10	F			
PR3 125 Supermoto Pro	10-11	R	TXT 80 (Cadet)	07-09	F	Twenty 250 (2T)	15	F			
PR3 125 Trail	11-12	R	TXT 80 Pro Racing (2T)	15	F	SR 280 (2T)	09-14	F			
PR4 Enduro 125	04-09	R	TXT-E (Full size electric bike)	12-14	F	SR 280 (2T) Long Ride	09-11	F			
PR4 Supermoto 125/200	04-11	R	TXT 250 Contact (2T)	15	F	Twenty 300 (2T)	15	F			
PR3 200 Enduro/Enduro Pro	08-11	R	MONTESA/HONDA			SHERCO					
PR3 200 Supermoto	08-11	R	315R	01-04	F	Trials 0.8 (2T)	05-10	F			
PR3 200 Supermotard Pro	10-11	R	250 4RT Cota	05-10	F	ST 80 (2T/Braktec Caliper)	14-15	F			
PR3 200 M/X	10-11	R	260 4RT Cota (STD Version ED/3E)	14-21	F	125 ST-R	18-19	F			
PR3 200 M/X Pro	10-11	R	OSSA			125 TY Classic	18-19	F			
PR4 Enduro 200	04-09	R	TR 125i	13-15	F	FST 125	18-19	F			
BETA			Explorer 250 i	14-15	F	Trials 1.25 (2T) AJP Caliper	06-12	F			
Evo 80 Senior	09-19	F	TR 250 i	14-15	F	ST 125 (2T/Braktec Caliper)	14-15	F			
Rev 80	08	F	TR 280 i	10-15	F	XY 125 (4T)	14-15	F			
Evo 125 (2T)	09-15	F	Explorer 280 i	12-15	F	Trials 2.5 (2T) AJP Caliper	06-12	F			
Rev 3 125/200	00-06	F&R	TR 300 i	14-15	F	250 ST Factory	18-19	F			
Rev 3 125/200	06-08	F	SCORPA			250 ST-R	18-19	F			
Evo 200 (2T)	09-15	F	SR 125 (2T)	10-13	F	ST 250 (2T/Braktec Caliper)	14-15	F			
Rev 3 250/270	00-04	F&R	SR 125 Long Ride (2T)	10-11	F	Trials 2.9 (2T) AJP Caliper	06-12	F			
Rev 3 250/270	05-08	F	SY 125 F	03-10	F	ST 290 (2T/Braktec Caliper)	14-15	F			
Evo 250 (2T)	09-15	F	SY 125 4T Long Ride	09-10	F	300 FST	18-19	F			
Evo 250 (4T)	09-15	F	SY 125 FR (4T)	03-11	F	300 ST-R	18-19	F			
Rev 4T 250	07-08	F	Twenty 125 (2T)	15	F	Trials 3.2 (4T) AJP Caliper	05-12	F			
Evo 300 (2T)	09-19	F	TY 125 (4T)	11-15	F	ST 305 (2T/Braktec Caliper)	14-15	F			
Evo 300 (4T)	09-19	F	SY 175 F	06	F	XISPA					
GAS-GAS			SY 200 F (4T) (163cc)	08	F	X 125 R	08-09	F			
TXT 125/200/250/280/300 (TXT PRO)	04-11	F	SY 250 F	06-10	F	X 250 R	08-09	F			
TXT 125/250/280/300 (For models with AJP caliper with 2 pin pad fixing)	12-14	F	SY 250 Long Ride (2T)	04-06	F	X 280 R	08-09	F			
			SY 250 (2T)	00-09	F						

FA304 75 x 55 x 9mm



MATERIAL AVAILABILITY											
FA	TT	V	R	HH	MXS	SXR	EPFA	GPFA	SFA	SFAC	SFAHH
✓		✓		✓							

BMW											
R 1200 CL				02-04	R						
K 1200 LT (All models)				97-09	R						

FA305 A 85 x 43.5 x 8.5mm B 64 x 36 x 11mm



MATERIAL AVAILABILITY											
FA	TT	V	R	HH	MXS	SXR	EPFA	GPFA	SFA	SFAC	SFAHH
	✓		✓						✓	✓	✓

Model	Year	Prefix	Model	Year	Prefix	Model	Year	Prefix	Model	Year	Prefix
ARCTIC CAT			People S 50 2T (5 bolt fixing)	05-15	F	Super 8 (125cc) (4T)	08-15	F			
50 DVX (4T) Sport	06/08	R	People S 50 (4T) (B91000)			Agility 150 R16 (C30000) (16" wheels)	08-14	F			
50 4x4 Auto Youth	08	R	(5 bolt fixing)	06-20	F	Like 150 i	20-21	F			
90 DVX	06-14	R	People 50 (2T) (3 bolt fixing)	99-14	F	Like 150 i Noodoe	20-21	F			
90 DVX SE	09	R	Supew 8 (50cc) (2T)	07-15	F	Mxer 150 Quad	02-07	R			
90 2x4 (4T) Youth (Rear disc model)	06	R	Super 8 (50cc) (4T)	07-20	F	MXU 150 (4T)	05-20	R			
90 SE	09	R	Super 9 50 (LC)	01-07	R	People 150	99-04	F			
90 (Reverse gear model)	10-14	R	MXU 50 (Quad) (2T)	05-14	R	Agility 200i R16	10-15	F			
150 Utility 2x4	09-14	R	KXR 90/S Mongoose	04-20	R	Like 200 i	09	F			
KAWASAKI			Maxxer 90	05-06	R	People S 200 (D11000)	05-06	F			
KFX 50 (KSF 50 B7F/B8F/B9S/BDF/BEF/BFF/BGF/BHF)	07-09/13-17	R	Agility 125 R16 (C20000) (16" wheels)	08-15	F	People S 200i DD (D12000)	07-15	F			
KFX 90 (KSF 90 A7F/A8F/A9F/AAF/ABF/ACF/ADF/AEF /AFF/AGF/AHF)	07-17	R	Agility RS125 (2T/12" wheels)	09-13	F	SYM					
LAVERDA			Agility 125 Carry (4T)	11-15	F	Combiz 125	11-15	F			
Phoenix 125/150/200	01-04	R	Agility City 125	18-21	F	HD 125/200	04-07	F			
KYMCO			Agility City+ 125	18-21	F	Joyride 125/200	01-07	R			
Agility 50 R16 (2T/16" wheels)	08-15	F	DJ 125 S	12-13	F	SK 125	03-04	R			
Agility 50 R16 (4T/16" wheels)	08-15	F	Like 125 (D20000)	09	F	Joyride 150	01-06	R			
Agility 50 Carry (4T)	11-18	F	Looker 125 S	07-08	F	GT 500	04	R			
DJ 50 S	12-15	F	People One 125i	13-15	F						
Like 50 (4T)	09	F	People S 125 DD	07-20	F						
Looker 50	07-08	F	People S 125	05-06	F						
			People 125	99-14	F						

BRAKE PAD BUYERS GUIDE

DO NOT REFIT ANY SHIMS/INSULATORS TO EBC PADS FROM ORIGINAL PADS UNLESS INSTRUCTED ON NOTE ON PAD PACKAGING AND ON FA DRAWING ASSOCIATED WITH THAT PAD.

SFA306 70 x 42 x 8mm



MATERIAL AVAILABILITY												
FA	TT	V	R	HH	MXS	SXR	EPFA	GPFAX	SFA	SFAC	SFAHH	
✓									✓	✓		
LAVERDA												
Phoenix 125/150/200				01-04	F	Shark 125/150				99-02	F	
RS 50				04-09	F	Shark 4VR 125				01-02	F	
Shark 50				99-03	F	Joyride 125/150/200				01-07	F	
Euro MX 125 (Rear drum model)						Joyride 125 i				07-09	F	
(HF12-W6 Euro 1)				02-07	F	Joyride Evo 125i (Twin Headlights)				09-21	F	
Euro MX 125 (Rear disc model)						VS 125				06-15	F	
(HF12 W3-6 Euro 2)				06-09	F	RS 150				06	F	
RS 125				04-06	F	VS 150				06-15	F	
SK 125				03-04	F	Joyride 200 i				07-09	F	
						Joyride Evo 200i				09-21	F	

FA307 A 82 x 41 x 9.5mm B 62 x 41 x 9.5mm



MATERIAL AVAILABILITY												
FA	TT	V	R	HH	MXS	SXR	EPFA	GPFAX	SFA	SFAC	SFAHH	
	✓		✓						✓		✓	
FA307TT												
YAMAHA												
YFM 400 FAM/FAN				00-01	R	CAN AM				Most models (see application pages)		
YFM 400 FWT (Big Bear)				05	R	CANNONDALE				07-15 F(left)&R		
YFM 400 FGW/FGX Grizzly				07-08	R	All quads (check main application pages for fitments)				01-04 F(left)&R		
YFM 450 FAR/FAS				03-04	R	JOHN DEERE ATV				Most models (see application pages)		
YFM 450 FAT/FAHT/FAV (Kodiak)				05-06	R	UX 125 K8/K9/L0/L1 SIXteen				08-14 R		
YFM 450 FXV/FXW/FXX/FXY/FXZ						UX 150 K8/K9/L0/L1 SIXteen				08-14 R		
Wolverine				06-10	R					04-05 F(left)&R		
BOMBARDIER												
Most models (see application pages)				01-06	F(left)&R							

FA313 123.5 x 55 x 9mm



MATERIAL AVAILABILITY												
FA	TT	V	R	HH	MXS	SXR	EPFA	GPFAX	SFA	SFAC	SFAHH	
			✓									
POLARIS												
Sportsman 6x6				00-03	R	PTV (6x6)				03 R		
500 Sportsman 6x6				00-08	R	PPS/PTV 6x6/Series 10				R		
						PPS LUH 6x6				02 R		

FA314 90.5 x 41 x 8mm



MATERIAL AVAILABILITY												
FA	TT	V	R	HH	MXS	SXR	EPFA	GPFAX	SFA	SFAC	SFAHH	
			✓									
POLARIS												
250 Trail Blazer				05-06	R	500 Scrambler 2x4				07-08 R		
Magnum 325/500				02-03	R	500 Sportsman HO/EFI				03-06 R		
325 Magnum (2x4) HDS				02	R	500 Sportsman HO (Up to 15/12/2008)				08 R		
325 Magnum 4x4 (A02CD32AA/AB/AC)				02	R	500 Sportsman EFI/HO				07-08 R		
325 Magnum 4x4 GDS (A02CD32FB)				02	R	500 Sportsman EFI Quad				08-11 R		
Xpedition 325				02	R	500 Sportsman X2				06-08 R		
Magnum 330 (2x4/HDS)				03-06	R	500 Sportsman Forest				12 R		
Magnum 330 (4x4/HDS)				03-04	R	Sportsman 500 HP				03-04 R		
330 Trial Boss				05-13	R	Sportsman 600 4x4				03-05 R		
330 Trial Blazer				08-13	R	Sportsman 700 (4x4)				02-04 R		
Sportsman 400				03	R	700 Sportsman (4x4)/EFI				02-06 R		
400 Sportsman 400				03-05	R	700 Sportsman EFI				07 R		
400 Sportsman				03-04	R	Sportsman MV 700				05-06 R		
450 Sportsman				06-07	R	Sportsman 800				05 R		
ATV Pro 500 4x4 TPS				02	R	800 Sportsman EFI				05-07 R		
500 ATV Pro 4x4 PPS				02	R	800 Sportsman EFI Intl/HO				07-11 R		
Magnum 500 HDS				02-03	R	800 Sportsman Big Boss/6x6/EDi				09-12 R		
Magnum 500 (2x4/4x4 HDS)				02	R	800 Sportsman HO/EFI (Up to 15/12/2008)				08 R		
500 Scrambler 4x4				05-11	R	PPS/PTV 4x4/Series 10				R		

FA317 A 82 x 41 x 9.5mm B 62 x 41 x 9.5mm



MATERIAL AVAILABILITY												
FA	TT	V	R	HH	MXS	SXR	EPFA	GPFAX	SFA	SFAC	SFAHH	
	✓		✓									
SUZUKI												
LT-A 500 FK2 Vision 4WD				02	R	Ryker 900 Ace				18-21		
BOMBARDIER												
Most models (see app. pages)				01-06	F(right)&R	CANNONDALE				All quads (check main app. pages for fitments)		
						01-04				F(Right)		
CAN-AM												
Most models (see app. pages)				07-15	F(right)&R	JOHN DEERE ATV				Most models (see app. pages)		
Ryker 600 Ace				18-21		01-05				F(right)&R		

DO NOT REFIT ANY SHIMS/INSULATORS TO EBC PADS FROM ORIGINAL PADS UNLESS INSTRUCTED ON NOTE ON PAD PACKAGING AND ON FA DRAWING ASSOCIATED WITH THAT PAD.

SFA319 100 x 36 x 12mm

FA319/2 100 x 36 x 9.5mm



MATERIAL AVAILABILITY – SFA319											
FA	TT	V	R	HH	MXS	SXR	EPFA	GPFA	SFA	SFAC	SFAHH
									✓	✓	✓

MATERIAL AVAILABILITY – FA319/2											
FA	TT	V	R	HH	MXS	SXR	EPFA	GPFA	SFA	SFAC	SFAHH
✓		✓		✓							

SFA319 - YAMAHA		
XP 500 N/P/R T-Max	01-03	R
XP 500 - T-Max 500 (530cc Engine Non ABS Models)	12-16	R
XP 500 A T-Max (530cc Engine/ ABS Models)	12-16	R
XP 530 Black Bronze Max (59CE)	13-14	R
XP 530 A (530cc Engine - Iron Max - ABS Model)	15-16	R
XP 500 A T-Max - LUX Max (ABS)	16	R
XP 530E-A T-Max (530cc Engine - ABS Model)	17-18	R
XP 530-A T-Max SX (530cc Engine - ABS Model)	17-18	R
XP 530D-A T-Max DX (530cc Engine - ABS Model)	17-18	R
SYM		
Voyager 250	05	R

FA319/2 - YAMAHA					
TDM 900 (5PS/Non ABS)	02-14	R	XT 1200 ZE Super Tenere Raid Edition (ABS/UBS Brake System)	18	R
TDM 900 (2B0/ABS)	05-13	R	FJR 1300 A (ABS)	03-20	R
SCR 950 (XVS 950XR-A)	17-18	R	FJR 1300 AE (Electronic Suspension Adjustment/USD Forks)	14-21	R
XV 950 Racer (Remote Reservoir Rear Shocks)	15-16	R	FJR 1300 AS (ABS/Electric Shift)	06-20	R
XVS 950 A Midnight Star	09-13	R	XVS 1300 A Midnight Star	07-16	R
XV 950 - XVS 950 (Non ABS /Standard Rear Shocks)	14	R	XVS 1300 CU Custom	14-17	R
XV 950 CU - XVS 950 (1XC1/ABS /Standard Rear Shocks)	14-15	R	XVS 1300 ACFD Midnight Star/Casual Full Dresser (With Handlebar Fairing)	14-16	R
XV 950 R - XVS 950 R (2DE /Remote Reservoir Rear Shocks)	14-18	R	XV 1700 PCR	03-05	R
XT 1200 Z Super Tenere ABS			XV 1700 V-Max	09-21	R
/UBS Brake system	11-17	R	XV 1900 A Midnight Star	06-08/11-13	R
XT 1200 ZE Super Tenere ABS /UBS Brake system	14-17	R			

FA320 70 x 42.5 x 7.5mm



MATERIAL AVAILABILITY											
FA	TT	V	R	HH	MXS	SXR	EPFA	GPFA	SFA	SFAC	SFAHH
				✓							

MV		
750 Brutale S F4	03-05	R
750 Brutale Oro F4	03-05	R
750 F4S (Mono Posto)	99-04	R
750 F4S 1+1 (Bi-Posto)	01-04	R
750 F4 SPR	01-04	R
750 F4 SPR Senna	01-03	R
910 Brutale S (Nissin Calipers)	06-08	R
910 Brutale R (Brembo calipers/4 pads)	06-08	R
920 Brutale	11-12	R
990 Brutale R	10-11	R
998 Freccce Tricolori	10	R

998 F4RR	10-14	R	1000 F4 R 312 (From VIN 008065)		
998 F4 RR Corsa Corta	12	R	Brembo 2 pad caliper)	08-09	R
998 F4R	12-14	R	1000 F4 R 312 1+1	07-08	R
998cc F4	10-14	R	1078 F4 RR 312	09	R
1000 Brutale	19-21	R	1078 Brutale RR	08-09	R
1000 F4 Ago	05	R	1078 F4100cc Claudio Castiglioni	07-08	R
1000 F4 S (Mono Posto)	04-06	R	1090 Brutale RR	10-15	R
1000 F4 S 1+1 (Bi-Posto)	04-06	R	1090 Brutale R	12-15	R
1000 F4 Tamburini	05	R	1090 Brutale	13-15	R
1000 F4 R	06-07	R	1090 Brutale Corsa	13-15	R
1000 F4 R 312 (Brembo 4 pad caliper up to VIN 008064)	07	R			

SFA321 55.5 x 49 x 7.5mm



MATERIAL AVAILABILITY											
FA	TT	V	R	HH	MXS	SXR	EPFA	GPFA	SFA	SFAC	SFAHH
									✓	✓	✓

BENELLI											
Adiva 125/150	01-04	R	GTS 125 Super ie (Inc ABS Models)	09-21	R						
			GTS 125 Supersport ie (Inc ABS Models)	13-21	R						
GILERA											
Also see SFA459 if pad is a different shape to SFA321			GTV 125	07-08	R						
125 VX 4T/180/VXR 200 4T	01-05	R	946 Special (4T/3V/125cc)	13-15	R						
DNA 125/180	01-03	R	GT 200 L Granturismo	03-06	R						
VX 125 Runner/ST (4T)	05-14	R	GTS 250 ie/ABS	05-10	R						
VXR/VX 200 Runner/ST (4T)	02-11	R	GTS 250 ie/ABS	05-11	R						
			GT 60 (Special Anniversary Model) (GTV 250)	06	R						
PIAGGIO											
Also see SFA459 if pad is a different shape to SFA321			GTV 250 ie	07-08	R						
New Fly 125ie (3V)	12-13	R	GTS 300 ie (Non ABS Models)	08-15	R						
Fly 125 (4T/3V) Rear Disc Model	12-15	R	GTS 300 ie Super (Non ABS Models)	08-15	R						
Liberty 125 MyMoover E5 3 Wheeler 2021		R	GTS 300 ie Super (ABS Models)	08-21	R						
Super Hexagon GTX 125/180 12" wheels	01-03	R	GTS 300 ie Super Sport (Non ABS Models)	08-15	R						
Super Hexagon GTX 250	00-02	R	GTS 300 ie Super Sport (ABS Models)	08-18	R						
			GTS 300 ie Touring (Non ABS Models)	11-16	R						
VESPA											
Also see SFA459 if pad is a different shape to SFA321			GTS 300 ie Touring (ABS Models)	11-21	R						
GT 125 L Granturismo	03-06	R	GTS 4V ABS/Super Sport/Touring	18-19	R						
GTS 125	07-11	R	GTS 300 HPE IE 4T/4V E4	20-21	R						
			GTV 300 Sei Giorni IE E4	20-21	R						

BRAKE PAD BUYERS GUIDE

DO NOT REFIT ANY SHIMS/INSULATORS TO EBC PADS FROM ORIGINAL PADS UNLESS INSTRUCTED ON NOTE ON PAD PACKAGING AND ON FA DRAWING ASSOCIATED WITH THAT PAD.

FA322/4 35 x 40.5 x 7.5mm



MATERIAL AVAILABILITY

FA	TT	V	R	HH	MXS	SXR	EPFA	GPFA	SFA	SFAC	SFAHH
				✓			✓				

APRILIA

RSV 1000 Mille	01-02	F	S4RS (Tricolore/Monster Testastretta)						SM 4.5iF Black Panther Supermotard	08-10	F
RSV 1000 R Mille	01-02	F	(998cc) Radial 4 pad caliper	08	F				SM 5.1iF Black Panther	08-10	F
RSV 1000 Mille (Radial caliper)	03	F	996 R		01	F			SWM		
RSV 1000 R Mille (Radial caliper)	03	F	998 R (998cc)		02	F			Ace of Spades 500	18-21	F
RSV 1000 R Racing/Factory			998 S Baylis/Bostrom		02	F			Gran Milano Outlaw 500	18-21	F
(Radial caliper/4 Pad)	04-08	F	998 S (998cc) (4 pad caliper)	02-04	F				SM 450 R	15-18	F
RSV 1000 R Factory	04-08	F	999 S (Std Caliper Mount						SM 500 R	16-21	F
RSV 1000 R	04-08	F	Monoposto /Biposto)	03-04	F				Gran Milano (4T)	16-18	F
Tuono R Factory 1000			999 (Std mount caliper)	03-06	F				Gran Milano Boggi SE	18	F
Radial caliper/4 pad type	06-10	F	999 R (Radial mount caliper)	03-06	F				Gran Milano Outlaw 500	18-20	F
Tuono R 1000 Radial caliper/4 pad type	02-05	F	999 R Fila (Radial mount caliper)	03	F				SM 650 R	16-18	F
			999 S (Radial caliper monoposto						TM		
BENELLI			/biposto)	05-06	F				SMM 125 (2T)	08-15	F
Leoncino (500cc)	17-18	F	999 R Xerox	06	F				SMR 125 (2T)	15	F
Leoncino Trail (500cc)	17-18	F	GENERIC						SMX 125 (2T)	15	F
TRK 502	17-18	F	GRS 600	13-14	F				SMM 250 (2T)	15	F
BX 570 Motard	08-10	F	HUSQVARNA						SMM 250 F (4T)	10-15	F
BN 600 GT	14-17	F	SMR 449	11	F				SMR 250 (2T)	15	F
BN 600i	14-17	F	SMR 450 RR Radial caliper	06-07	F				SMR 250 F (4T)	10-15	F
752S	18	F	SM 450 R Radial caliper	07-10	F				SMX 250 (2T)	15	F
Cafe 899 Racer	10-12	F	SM 450 RR	08-10	F				SMX 250 Fi	12-15	F
Century Racer 899	11-12	F	SM 510 R (Radial caliper)	06-10	F				SMM 300 (2T)	15	F
Century 1130 Racer	11-12	F	SMR 511	11-13	F				SMR 300 (2T)	15	F
TNT 1130 Sport/Sport Evo	04-09	F	SM 530 RR	08-10	F				SMX 300 (2T)	15	F
TNT 1130 Cafe Racer	06-12	F	SM 610 S (Radial caliper)	06	F				SMM 450 F Black Dream ES	08-11	F
TNT 1130 Titanium	06-08	F	SM 610 ie	07-09	F				SMM 450 F	11-15	F
Tornado LE/Tornado TRE Novecento/RS	03-05	F	SMR 630 (4T)	10-12	F				SMR 450 Fi (4T)	10-15	F
Tornado Tre 1130	06-10	F	STR 650 CRC	07	F				SMX 450 Fi	05-15	F
Tornado Naked Tre R160 1130cc	09-12	F	701 Supermoto	16-20	F				SMM 530 F Black Dream ES	08-10	F
			KTM						SMM 530 Fi	15	F
BIMOTA			690 Duke	08-11	F				SMR 530 Fi (4T)	10-15	F
Elirio	06	F	690 Duke R	10-11	F				SMX 530 Fi	05-15	F
DB5 (All models)	06-07	F	690 SM Prestige	07	F				SMX 660 F	05-10	F
DB5R	06-13	F	690 SMC (4 pad type caliper						TRIUMPH		
DB5R/S (1078cc)	08-09	F	/cast wheel)	07-11	F				Speed Triple 1050 (Non ABS)		
DB5 Desiderio (1078cc)	12-14	F	690 SMC (4 pad type caliper						To VIN 461331	07-11	F
DB6 Delirio (992cc Ducati engine)	07	F	/spoke wheel)	08-11	F				Speed Triple 1050 (ABS)		
DB6 (1078cc)	08-09	F	690 SMC R	12-13	F				To VIN 461331	07-11	F
DB6/R (1078cc)	08-09	F	690 SMC R (ABS)	14-17	F				VOXAN		
DB6 (1100cc)	08	F	950 Supermoto	05-07	F				Charade Racing	06	F
DB6R Delirio (1100cc)	08	F	990 Superduke	05-11	F				GTV 1200	08	F
DB6 Delirio (1078cc)	12-13	F	990 Superduke R	07-13	F						
DB7 (1098cc)	08	F	990 Supermoto T (SM-T)	09-13	F						
DB9 Brivido (1198cc)	12-14	F	990 Supermoto R (SM-R)	08-09	F						
DB10 Motard (1078cc)	12-14	F	LAVERDA								
DB12 B Tourist (1198cc)	12-14	F	SFC 1000	03-04	F						
SB8K Santamonica (996cc Suzuki engine)			MONDIAL								
Tesi-3D (1078cc)	09-13	F	Piega 1000	03-04	F						
			EVO	04	F						
BREMBO			MOTO GUZZI								
20 7850 11/21 - 4 Piston P4/34 @ 65mm			Griso	04	F						
Spacing (Wire clip pad retention only)			1000 MGS-01 Corsa	04-07	F						
20 8343 11/21 or 35/45 - 4 piston			Fionda 1100	05	F						
P4/34 @ 100mm Spacing (wire clip			MOTO MORINI								
pad retention only)			Rebello 1200 Giubileo	12-13	F						
XA 32950 P4/34 Motard Avial Mount			M.V. AGUSTA								
65mm 4 pad set			Brutale 910 R	05-08	F						
CAGIVA			910 Brutale R (Brembo calipers								
Mito 500 (4T)	08	F	/4 pads)	06-08	F						
Raptor X3 1000	03-04	F	F4R 1000	06-07	F						
DERBI			1000 F4R	06-07	F						
Mulhacen 659	06-08	F	1000 F4R 312 (Brembo 4 pad								
			caliper Up to VIN 008064)	07	F						
DUCATI			1000 F4 R 312 1+1	07-08	F						
748 R (4 pad caliper)	01	F	F4RR 312R 1000	07	F						
748 R (4 pad caliper)	02	F	NORTON								
749 Dark (Monoposto/Biposto)	04-06	F	Commando Cafe Racer (961cc)	10-14	F						
749 R (Radial caliper)	04-06	F	Commando SE (961cc)	10-11	F						
749 S (Monoposto/Biposto)	03-06	F	Commando 961 SF	13-14	F						
749 (Monoposto/Biposto)	03-06	F	PETRONAS								
S4 RS Monster (998cc)			FP1	05	F						
(Radial 4 pad caliper)	06	F	SHERCO								
S4R Monster Testastretta (998cc)			SM 4.5iF Supermoto	04-07	F						
(Radial 4 pad caliper)	07-08	F									
S4RS Monster Testastretta (998cc)											
(Radial 4 pad caliper)	07	F									

BUYERS GUIDE

DO NOT REFIT ANY SHIMS/INSULATORS TO EBC PADS FROM ORIGINAL PADS UNLESS INSTRUCTED ON NOTE ON PAD PACKAGING AND ON FA DRAWING ASSOCIATED WITH THAT PAD.

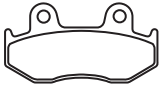
FA323 81 x 42 x 9mm**SFA323/2 81 x 42 x 7mm****SFA323/3 81 x 42 x 8mm**

MATERIAL AVAILABILITY – FA323											
FA	TT	V	R	HH	MXS	SXR	EPFA	GPFAFX	SFA	SFAC	SFAHH
	✓		✓						✓	✓	✓

MATERIAL AVAILABILITY – SFA323/2 & SFA323/3											
FA	TT	V	R	HH	MXS	SXR	EPFA	GPFAFX	SFA	SFAC	SFAHH
									✓		✓

FA323**YAMAHA**

YFZ 450 V/W/X	06-08	R
YFZ 450 RY/RZ (Quad)	09-10	R
YFZ 450 R	11-14	R
YFZ 450 RSEA/RSEB/RSED/RSE	11-14	R
YFZ 450 B/D	13-14	R
YFM 700 RD/RE	13-14	R
YFM 700 RSE	13-18	R

WK

Tria 125	11-14	F
----------	-------	---

SFA323**HONDA**

SCV 110 Lead (NHX 110 WH8 - 3 bolt disc fixing)	08-09	F
---	-------	---

NES 125 Y/1/2/3/4/5/6

(@ 125 Scooter)	00-06	F
PES 125 6/7/8/9/A (PS 125)	06-10	F
PES 125 R8/R9/RA (PS 125) ABS	08-12	F
SH 125 i 4/5/6/7/8/R8/S7/S8/D9		
Fuel Injection	04-09	F
SH 125 1/3 Carb/Rear drum model	01-03	F
NES 150 Y/1/2/3/4/5/6 “@150 Scooter”	01-06	F
SH 150 1/3 Carb/Rear drum model	01-03	F
SH 150i 4/5/6/7/8/S7/S8/R8/D9		
Fuel Injection	04-09	F
PES 150 6/7/8/9 (PS 150)/A	06-10	F
PES 150 R8/R9/RA ABS	08-12	F
SES 125/150 2/3/4 Dylan	02-07	F

ITALJET

Torpedo 125/150	07-09	F
Jack 125/150	07	F&R
MZ Mantizz 125 S	05-07	F

SFA232/2**HONDA**

CH 250 F/G “Spacy”	85-86	F
--------------------	-------	---

SFA323/3**SUZUKI**

AN 250 W/X/Y ‘Burgman’	98-00	R
------------------------	-------	---

AN 400 X/Y ‘Burgman’

	99-00	R
--	-------	---

KAWASAKI

SC 250 A1 (Epsilon 250)	02-03	R
-------------------------	-------	---

SFA324 117.5 x 41.5 x 8.5mm

MATERIAL AVAILABILITY											
FA	TT	V	R	HH	MXS	SXR	EPFA	GPFAFX	SFA	SFAC	SFAHH
									✓	✓	✓

APRILIA

Atlantic 125	03-08	F
Atlantic 125	10	F
Scarabeo 125/150/250 GT	04-06	F
Scarabeo 125/200	07-09	F
Atlantic 200	03-05	F
Atlantic 250	03-05	F
Atlantic 250 ie	06-08	F
Scarabeo 250 ie	07-10	F
Atlantic 300	10-11	F
Atlantic Sprint 400	05-08	F
Atlantic Sprint 500	05-08	F

BETA

RR-S 125 ZD3E9143 4T LC CBS	18-20	F
-----------------------------	-------	---

RR-S 125 Motard ZD3E9143 4T LC CBS	18-20	F
------------------------------------	-------	---

KYMCO

Downtown 125i	15-20	F
People GTi 125	10-15	F
X Town 125	16-18	F
X Town 125i ABS	16-20	F
People GTi 200	10-15	F
300i Agility Max ABS	15	F
K-XCT 300 i	12-15	F
People GTi 300	10-20	F
X Town 300i	17-20	F
Downtown 350i	15-20	F
MALAGUTI Madison S 250	99-03	F
Madison K 400	02-06	F

PEUGEOT

LOOXOR 125/150	03-06	F
PIAGGIO Beverly 350 ie Sport Touring		
Non ABS (330cc/4T)	11-20	F
Beverly 350 ie ABS Sport		
Touring (330cc/4T)	11-20	F
SCARABEO 125 ie	10-15	F
125 Net	10-11	F
200 ie	10-15	F
200 Net	10-11	F
300 S ie	09-12	F

FA325 43 x 25 x 5mm

MATERIAL AVAILABILITY											
FA	TT	V	R	HH	MXS	SXR	EPFA	GPFAFX	SFA	SFAC	SFAHH
	✓		✓								

GAS GAS (Pierer Mobility)

ME-E 5 Electric	21	F&R
MC 50	21	F&R

HUSQVARNA

CR 50 Senior Pro	05	R
CR 50	11-13	F&R
EE 5 Electric	21-22	F&R
SM 50	11-13	F&R
TC 50/ Mini	18-22	F&R

LEM

R2/R3 (Hydraulic System)	03-05	F&R
RX 65		F&R
RX 2/3		F&R
CX 2/3		F&R

KTM

CR 50 Senior Pro	05	R
SX-E 5 Electric	20-22	F&R
50 SX Pro Senior LC	02-22	F

50 SX Senior Adventure	02-07	F
50 SX Pro Senior LC (12" F/wheel)	04-15	F&R
50 SX	06-20	F&R
50 SX Mini	08-20	F&R
50 Supermoto	06	F&R
65 SX	04-08	R

POLINI

X1R/X3R H20 50cc		F&R
------------------	--	-----

TOMOS

MC 50 Senior	05	F&R
--------------	----	-----

CFA327 35 x 30.5 x 4mm

MATERIAL AVAILABILITY											
FA	TT	V	R	HH	MXS	SXR	EPFA	GPFAFX	SFA	SFAC	SFAHH
✓			✓	✓							

BETA

Minitrail Electric	14-15	F&R
--------------------	-------	-----

FA335 77 x 51.5 x 8.5mm

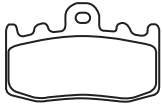

MATERIAL AVAILABILITY												
FA	TT	V	R	HH	MXS	SXR	EPFA	GPFA	SFA	SFAC	SFAHH	
				✓			✓					

BMW											
R 850 RT				06	F			R 1200 GS Triple Black (Spoke wheels)		11-13	F
R 1100 S (Non ABS)				12/00-03	F			R 1200 GS (30 years GS)		11	F
R 1150 RT (Integral ABS)				00-06	F			R 1200 RT K29/0368 Brembo caliper		05-09	F
K 1200 RS/R/S				01-05	F			R 1200 RT		10-13	F
K 1200 GT (K41)				03-06	F			R 1200 RT-SE		10-13	F
K 1200 GT (K44)				06-08	F(Left)			R 1200 ST K28/0328		03-08	F
K 1200 S (K40)				05-08	F			R 1200 S K29/0366 Brembo caliper		06-08	F
R 1200 GS (K25/0307/Cast /Spoke wheel)				02-11/07	F			R 1200 GS Rallye (Spoke wheels)		12	F
R 1200 GS Adventure (K25/0382/Spoke wheel)				05-11/07	F			R 1200 GS Adventure Triple Black		12	F
R 1200 GS/Adventure (Spoke wheels)				10-12	F			HP2 Megamoto		07-09	F
R 1200 GS Adventure/M (K25/0380 /Spoke wheel)				06-09	F			HP2 Megamoto (K25)		07-10	F
R 1200 GS/M (K25/0303/Cast wheel)				06-09	F			K 1300 GT		09-11	F
R 1200 GS (Cast wheels)				10-12	F			K 1300 GT EE		10-11	F
R 1200 GS Adventure (30 years GS)				11	F			K 1300 GT SE		10-11	F
								K 1300 S (Non & ABS Models)		09-15	F
								K 1300 S Sport		12-15	F
								K 1300 S HP		12	F

SFA336 78 x 46.5 x 7mm



MATERIAL AVAILABILITY												
FA	TT	V	R	HH	MXS	SXR	EPFA	GPFA	SFA	SFAC	SFAHH	
									✓			

YAMAHA								MIO (113cc)		05-07	F
CV 50 ZR (5PT1) Evolution				01-02	F			MIO Sporty (113cc)		05-07	F
CV 50 (5KN1/2) Jog-Cool Style				00-02	F			Nuovo-Z (113cc)		06-07	F

FA337 35 x 51.5 x 6mm



MATERIAL AVAILABILITY												
FA	TT	V	R	HH	MXS	SXR	EPFA	GPFA	SFA	SFAC	SFAHH	
	✓		✓									

APRILIA								JCM			
Pegaso 50				92-94	R			240 Europa		89-	R
280 R Climber				92-93	R			KTM			
BETA								60 SX		00	R
R150 (Minicross/4T/49cc)				10-14	R			65 SX		00-03	R
M4 350 Supermotard				04-06	R						

FA342 A 26 x 120.5 x 7mm B 35.5 x 94.5 x 8mm

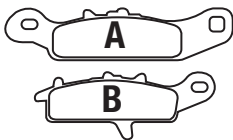

MATERIAL AVAILABILITY												
FA	TT	V	R	HH	MXS	SXR	EPFA	GPFA	SFA	SFAC	SFAHH	
			✓									

KAWASAKI								KVF 700 A1/B1/A2/A6F/B2/B6F /A7F/A8F 4x4 (Prairie)		04-08	F(Left)
KFX 450 R Quad(KSF 450 B8F/B9F /BAF/BBF/BCS/BDF/BEF)				08-14	F(Left)			KVF 700 D1 Team Green		05	F(Left)
KVF 650 A1/A2 Prairie				02-03	F(Left)			SUZUKI			
KVF 650 D1/D6F/D7F/D8F/D9F /DAF/DBF Brute Force 4x4				05-11	F(Left)			LT-V 700 FK4/FK5 Twin Peaks		04-05	F(Left)
KVF 650 E1/E6F/E7F/E8F/E9F Brute Force 4x4 Hardwoods Green HD				05-09	F(Left)						

FA343 A 107 x 41 x 10mm B 91.5 x 40.5 x 10mm



MATERIAL AVAILABILITY												
FA	TT	V	R	HH	MXS	SXR	EPFA	GPFA	SFA	SFAC	SFAHH	
✓				✓					✓			

AJS								YAMAHA			
Regal Raptor CR3-125				06	R			MW 125 Tricity Scooter		14-16	R
HERO											
Karizma ZMR 230				11-12	R						
HONDA											
CBR 125 R4/R5/RS5/RW5-RW9 /RWA (6 bolt front disc/Canada)				04-10	R						
XL 125 V1-VA Varadero				01-11	R						
Z 125 Monkey ABS				18-21	R						
CBR 150 R				00-03	R						

FA344 65.5 x 45 x 11.5mm



MATERIAL AVAILABILITY												
FA	TT	V	R	HH	MXS	SXR	EPFA	GPFA	SFA	SFAC	SFAHH	
	✓		✓									

YAMAHA						G 520 UTX (Side x Side)	10-12	R
YFM 660 FWAP/FWAR/FWAS/FWAT						G 525 (4x4)	12-13	R
/FWAW/FGW/FGX Grizzly						G 525 4x4 Max	12-13	R
YFM 660 FR/FS/FT Grizzly						G 625i (All models)	12	R
LX 700-4A Quad						G 625i (4x4)	12-14	R
CCM						G 625i 4x4 Max	12-14	R
LX 700-4A Quad						G 625i UTX 4x4 (Side x Side)	12-13	R
C F MOTO						G E-SSV Electric (Side x Side)	12-13	R
CF 500 5B/5C-C/Force 500 Classic						QUADZILLA		
CF 500-C/Force (X5 Terralander)						CUV 500 Side x Side	10-11	R
CF 500 5 - Ranger UTV						QZ 500 E/ES 4x4	09-11	R
CF 625-C/Force (X6 Terralander)						RL 500 MKII Buggie	10-11	R
CF 800-2 - C/Force (ATV)						RS5 4WD	10-11	R
EXPLORER						RS6 EFI 4WD	10-11	R
Atlas 500/4x4						Z6 4x4	10-13	R
Everest 500 L/4x4						X8 (4x4/EFI)	12-15	R
GOES						WT MOTORS		
G 520 F (Quad)						WT 500 Alaska Quad	08-09	R
520 Max (Quad)								

FA345 92 x 49.5 x 8mm



MATERIAL AVAILABILITY												
FA	TT	V	R	HH	MXS	SXR	EPFA	GPFA	SFA	SFAC	SFAHH	
				✓			✓					

BUELL						XB 12 R Firebolt	04-08	F
Firebolt XB9R						XB 12 SS Lightning Long	06-08	F
XB9S Lightning						XB 12 SCG Lightning	06-08	F
XB9SX Lightning City X						XB 12 X Ulysses	06-10	F
XB9 SX Lightning						XB 12 XT Ulysses	08-10	F
XB 12 S Lightning						XB 12 STT Lightning	08	F

FA346 A 60 x 45 x 11mm B 60 x 45 x 11mm



MATERIAL AVAILABILITY												
FA	TT	V	R	HH	MXS	SXR	EPFA	GPFA	SFA	SFAC	SFAHH	
	✓		✓		✓		✓					

ALFER						CR 250 R2/R3/R4/R5/R6/R7	02-07	R	CRM 125 (Derapage Competition 2T)	11	R
EVX 400 Electric						CRF 250 R4-R9/RA/RB/RC/RD/RE/RF/RG	04-16	R	CRM F 125 X (Derapage Competition 4T)	10-11	R
FANTIC						CRF 250 RE (Limited Road Use)	16	R	CRM 125 (Derapage RR 2T)	11	R
TR 125 CR (2T) Cross Competizione						CRF 250 X	04-20	R	CR 150 R/R2	07-09	R
TR 125 MR (2T) Motard Competizione						CRF 250 XRL (Road legal)	14-20	R	CR 230 Easy Trail	04	R
TZ 125 CS Caballero Cross (2T)						CCRF 450 R	02-15	R	CRF 230 Easy Enduro	04	R
TZ 125 ES Regularita Scuderia (2T)						CRF 450 L	18-20	R	CRF 230 Easy Motard	04	R
TZ 125 SM Caballero Motard (2T)						CRF 450 R	15-22	R	CRE 250	02	R
TZ 170 E Regularita Casa (125E/4T)						CRF 450 RL	20-22	R	CRE 250 R Supermotard	02-03	R
TZ 170 ER Caballero Regularita						CRF 450 R-S	22	R	CRE 250 R Enduro	02-06	R
TZ 170 M Motard Casa (125SM/4T)						CRF 450 RWE	19-22	R	CRE 250 X		R
TZ 170 MR Motard Competizione (125 MR 4T)						CRF 450 RX	19-22	R	CRE F 250 X	08-11	R
TX 180 E Regularita Casa 50E						CRF 450 XRL (Road legal)	14-16	R	CRM 250 X Supermoto	07	R
(49cc/2T)						CRF 450 RX (18" Rear Wheel)	17-21	R	CR 250 R Moto	04	R
TX 180 ER Regularita Competizione (49cc/2T) 50ER						HONDA-DALL'ARA			CRF 250 F Enduro	04	R
TX 180 ES Regularita Scuderia (49cc/2T) 50ES						XR 250 SM	04	R	CRF 250 Motard	04	R
TX 180 M Motard Casa (49cc/2T)						XR 400/440 R	04	R	CRF 250 F	04-08	R
TZ 180 MR Motard Competizione (49cc/2T) 50MR						XR 400/440 SM	04	R	CRF 250 R	08-09	R
TZ 180 MR Motard Competizione (49cc/2T) 50MR						HONDA-HM (ITALY)			CRE F 290 X	07	R
TZ 200 ER Caballero Regularita Competizione (200ER/4T)						CR 50 Derapage RR			CRE F 300 X	08-09	R
TZ 200 MR Motard (200 SMR 4T)						From ZEN50XACMA7700385	07-09	R	CRE 450 F Enduro	02-06	R
Casa 250 E 4T carb model						CRE 50 Baja RR			CRE 450 F	02	R
Casa 250 Efi 4T Injection model						From ZEN0XACEA7700325	07-09	R	CRF 450 Motard	04	R
TZ 250 ES Regularita (2T)						CRE 50 Six Competition	07-08/10-12	R	CRE 450 F Supermoto	02-03	R
TF 250 ES Regularita (4T)						CRM 50 Derapage Competition	07-09	R	CRE 450 X		R
TR 250 ES (2T) Enduro Six Days						CRE 125 R Supermotard	02-03	R	CRF 450 R	04-08	R
TR 300 ES (2T) Enduro Six Days						CRE 125 R Enduro	04-06	R	CRM F 450 R/X Supermoto	07	R
TZ 300 ES Regularita Scuderia						CR 125 Motard	04	R	CRE F 490 X	07	R
HONDA						CRE 125 R Enduro	02-03	R	CRM F 490 X Supermoto	07	R
CR 125 R2/R3/R4/R5/R6/R7						CRE 125 (Six Competitin 2T)	11	R	CRE F 500 X	08-09	R
CRF 150 R Small wheel (FR 17"/RR 14")						CRE 125 (Baja RR 2T)	11	R	CRM F 500 X	11	R
CRF 150 RB Big wheel (FR 19"/RR 16")						CRE 125 X	09	R	MEGELLI		
						CRE F 125 X	09	R	125 M	08-10	R
						CRM 125 X Six 4T	10-11	R	PUZEY		
						CRM 125 R Supermoto	07	R	MTD 300 (4T/4V) (Motard model)	11-12	R
						CRM F 125 X	09	R	MX 300 (4T/4V) (Enduro model)	11-12	R

BRAKE PAD BUYERS GUIDE

DO NOT REFIT ANY SHIMS/INSULATORS TO EBC PADS FROM ORIGINAL PADS UNLESS INSTRUCTED ON NOTE ON PAD PACKAGING AND ON FA DRAWING ASSOCIATED WITH THAT PAD.

FA347 69.5 x 49.5 x 7mm



MATERIAL AVAILABILITY												
FA	TT	V	R	HH	MXS	SXR	EPFA	GPFAX	SFA	SFAC	SFAHH	
				✓			✓	✓				

HONDA

RS 125 (Radial caliper)	04-07	F	Chieftain (Cast Wheel/Nissin Calipers)	14-20	F	Cross Country				10-17	F	
NSF 250 R	12-13	F	Chieftain Dark Horse (Cast Wheel /Nissin Calipers)	16-20	F	Cross Country Tour				13-17	F	
KAWASAKI			Chieftain Limited (Cast Wheel /Nissin Calipers)	17-20	F	Cross Country 8 Ball				15-16	F	
Z 800 E (Z 800 DDS/DEF/DFD/DGF - ABS Model)	13-16	F	Chief Dark Horse	14-20	F	Cross Roads				10-12	F	
Z 800 (Z 800 ADS/AEF/AFF/AGF - Non ABS)	13-16	F	Roadmaster (Cast Wheel/Nissin Calipers)	15-20	F	Cross Roads Classic (Spoke Wheel)				13-14	F	
Z 800 (Z 800 BDS/BEF/BFF/BGF ABS Model)	13-16	F	Roadmaster Classic (Nissin Calipers)	17-18	F	Cross Roads 8-Ball (Cast Wheel)				14	F	
Z 900 (ZR 900 AHF/AJF - Non ABS)	17-20	F	Roadmaster Elite (Nissin Calipers)	17-20	F	Gunner				15-17	F	
Z 900 RS ABS (ZR 900 CJF/EJF ABS)	18-21	F	Springfield	16-20	F	Hammer				08-11	F	
Z 900 RS Café (ZR 900 CJFA/CJFB ABS)	18-20	F	Springfield Dark Horse	18	F	Hammer S				08-17	F	
ZX9R (ZX 900 F1/F2)	02-04	F	MORIWAKI/HONDA			Hard Ball				12-13	F	
Z 1000 (ZR 1000 A1/A2/A3)	03-05	F	MD 250 H/S	08-13	F	Highball (Spoke & Cast Wheel)				12-17	F	
SUZUKI			TRIUMPH			Jackpot				10-16	F	
GSX-S 750 all models	17-21	F	Daytona 675	06-08	F	Judge				13-17	F	
GSX 1300 BKK8/BKK9/BKLO/BKL1 B-King	08-12	F	Street Triple 675 R	09-16	F	King Pin				08-12	F	
YAMAHA			Street Triple RX675	15-16	F	Kingpin Tour				08-09	F	
TZ 250 (Radial Caliper)	02-10	F	Speed Triple (1050cc)	05-06	F	Kingpin 8-Ball				08-11	F	
INDIAN			(Nissin Radial caliper)			Kingpin Low				09	F	
Chief Classic (Spoke Wheel /Nissin Calipers)	14-18	F	Tiger 1050 (radial caliper)	07-12	F	Magnum				15-17	F	
Chief Vintage (Spoke Wheel /Nissin Calipers)	14-20	F	Tiger SE - ABS (1050cc)	10-13	F	Vegas 8-Ball				08-17	F	
			Tiger Sport (ABS) 1050cc	13-18	F	Vegas				08-17	F	
			VICTORY			Vegas Low				08-09	F	
			Boardwalk (Spoke Wheels)	13-15	F	Vegas Jackpot				08-09	F	
			Cory Ness Jackpot	08-10	F	Zach Ness Vegas				11-12	F	
			Cory Ness Victory Cross Country	11-12	F							

FA348 63.5 x 60.5 x 9mm



MATERIAL AVAILABILITY												
FA	TT	V	R	HH	MXS	SXR	EPFA	GPFAX	SFA	SFAC	SFAHH	
✓				✓								

YAMAHA			XJR 1300 R/S 5WM1/5WM3/5WM5									
FZS 1000 Fazer	01-05	R	/5WM6/5WM7/5WM9							03-04	R	
XJR 1300 C / Racer	15-16	R	XJR 1300 TV/W/X/Y 5WMA/5WMC									
XJR 1300 N/P (5EAP/5EAR/5EAS/5EAT /5EAW/5EAV/5EAY) (298mm front disc)	01-02	R	/5WMD/5WMMF							05-14	R	

FA349 A 119.5 x 26 x 7mm B 94.5 x 35.5 x 8mm



MATERIAL AVAILABILITY												
FA	TT	V	R	HH	MXS	SXR	EPFA	GPFAX	SFA	SFAC	SFAHH	
			✓									

KAWASAKI			KVF 700 A1/B1/A2/A6F/B2/B6F									
KFX 450 R Quad (KSF 450 B8F/B9F /BAF/BBF/BCS/BDF/BEF)	08-14	F(right)	/A7F/A8F 4x4 (Prairie)							04-08	F(right)	
KVF 650 A1/A2 Prairie	02-03	F(right)	KVF 700 D1 Team Green							05	F(right)	
KVF 650 D1/D6F/D7F/D8F/D9F /DAF/DBF Brute Force 4x4	05-11	F(right)	SUZUKI									
KVF 650 E1/E6F/E7F/E8F/E9F Brute Force 4x4 Hardwoods Green HD	05-09	F(right)	LT-V 700 FK4/FK5 Twin Peaks							04-05	F(right)	

FA350 50 x 47.5 x 7mm



MATERIAL AVAILABILITY												
FA	TT	V	R	HH	MXS	SXR	EPFA	GPFAX	SFA	SFAC	SFAHH	
✓	✓	✓							✓	✓	✓	

CPI			Senda R 125	04	R	Elystar 50 TSDi				02-07	R	
SM 250	11-12	R	Senda R Euro 2 125	04-07	R	Elyseo 125/150				01-03	R	
SX 250	11-12	R	Senda 125 Baja (4T) (260mm disc)	06-12	R	Elystar 125/150						
DERBI			Senda 125 Baja SM (4T) (300mm disc)	06-12	R	(3 bolt fixing - front disc)				02-05	R	
Senda DRD Pro 50 R Radial caliper /260mm disc	05-13	R	Boulevard 150	03-07	F	Elystar 125/150						
Senda DRD Pro 50 SM Radial caliper /300mm disc	05-14	R	Boulevard 200	05	F	(5 bolt fixing - front disc)				06-07	R	
Senda DRD 50 Evo SM (Cast wheels)	08-11	R	GP1 250cc Racing Low seat /radial caliper 6 bolt disc fixing	07-09	R	Jet Force 125 (All models)				03-07	R	
Boulevard 125	03-07	F	HONDA HM (Italy)			Satelis 125 Compressor (4T)				06-11	R	
Cross City 125	07-14	R	CRE 50 Baja RR	03-09	R	Satelis 125 RS				07-11	R	
GP1 125cc Racing Low seat /radial caliper 6 bolt disc fixing	07-09	R	Up to ZEN50XACEA7700324	07-09	R	Satelis 250 (AJP Calipers)				07-10	R	
Senda 125 SM (Twin headlight)	04-07	R	CRE 50 Derapage RR			ITALJET						
Senda R 125 SM	04-07	R	Up to ZEN50XACMA7700384	07-09	R	Jet Set 50/125/150				02-03	F	
			PEUGEOT			Millenium 100/125/150				02-04	F	
						MALAGUTI						
						X3M Enduro (Spoke wheel)				08-10	F	

FA350 50 x 47.5 x 7mm

MASH

Two Fifty 250	14-16	R
MBK		
X-Limit Enduro	03-09	F&R
X-Limit Supermoto	03-09	R

PEUGEOT

Geopolis 125 Executive/Non ABS (AJP calipers)	07-12	R
Geopolis 125 Urban/ABS (AJP Calipers)	07-12	R
Satelis 125 Blacksat (AJP Calipers)	10-12	R
Satelis 125 Whitesat (AJP Caliper)	10-12	R
Satelis RS 125 (AJP Calipers)	07-12	R
Satelis Urban 125 (AJP Caliper/ABS)	07-12	R
Geopolis 250 Urban/ABS (AJP Calipers)	07-10	R
Geopolis 250 Executive (AJP Calipers/Non ABS)	07-10	R
Satelis 250 Urban (AJP Calipers/ABS)	07-12	R
Geopolis 400 Urban (AJP Calipers/ABS)	07-12	R

RIEJU

RS2 Matrix (50cc)	02-08	R
Tango 50	07-12	R
Tango 50 (Spoke wheel)	11	R
Tango 50 Motard	09-10	R
Tango 50 (2T)	13-15	R
Tango 50 (4T)	07-08	R
RS2 125	06-10	R
125 NKD	06-07	R
SMX 125	02-08	R
Tango Pro 125	07-10	R
Tango 125	06-20	R
RS2 Matrix	02-08	R
Tango 250	08-15	R

SCORPA

T-Ride 125 F	10	R
T-Ride 250 F (Enduro)	08-10	R

SHERCO

Enduro/Urban/SU 50cc (2T) (Spoke wheel)	08-13	R
SU 50cc (2T) Urban Base (Cast Wheels)	10	R
SM 0.5 "Black Panther"	08-10	R
Supermotard SM50	08-13	R
City Corp 125 (All models)	08	R
SM 1.25 F Black Panther (4T)	10-12	R
SE1.25 F Enduro (4T)	10-12	R

YAMAHA

DT 50 R	02-08	F&R
DT 50 X	04-08	R
XT 125 R (3D61/3D63/13D1/13D3/13D5)	05-12	F&R
XT 125 X (3D62/3D64)	05-06	R
XT 125 X (13D2/13D4/13D6)	07-11	R

FA351 36 x 39 x 6mm



MATERIAL AVAILABILITY

FA	TT	V	R	HH	MXS	SXR	EPFA	GPFAX	SFA	SFAC	SFAHH
	✓										

APRILIA

Mini RX 50 Experience	04	F
-----------------------	----	---

BETA

Minicross Pro Race 12/10	04-06	F&R
Minitrial 50 (A/C)	09-12	F
Minitrial LC (Hydraulic Brakes)	13-15	F
Pro Race 50	05	R

FACTORY

Phantom R14 Agua	04	F
------------------	----	---

GAS-GAS

TXE Electric Bike	20	R
Cross MC 50	06	R
EC 50	06-07	R
TXT 50 Cadet	06-09	F
TXT 50 Rookie	04-09	R
Cross MC 65	06	F&R
TXT Cadet 80	06	F&R
TXT 80 Rookie	04-09	R
TXT 80 (Cadet)	07-09	R
TXT 80 Pro Racing (2T)	15	R
TXT 125 Randonne (4T)	11-15	R
TXT 200 Randonne (4T)	14-15	R
TXT 125/200/250/280/300 (TXT PRO)	04-11	R
TXT 125/250/280/300		

(For models with Formula front caliper/single pin pad fixing)

TXT 125/250/280/300 (For models with AJP caliper/2 pin pad fixing)

TXT-E (Full size electric bike)

TXT 250 Contact (4T)

TXT Racing 125/250/280/300 (2T Monobloc Caliper)

TXT Replica Factory Models

125/250/280/300 (2T Monobloc Caliper)

EC 50 Boy (Air cooled)

EC 50 Boy (LC)

MX 65

GAS GAS (Pierer Mob)

TXT Racing 125cc 2T

TXT GP 125cc 2T

TXT Racing 250cc 2T

TXT GP 250cc 2T

TXT Racing 280cc 2T

TXT GP 280cc 2T

TXT Racing 300cc 2T

TXT GP 300cc 2T

HONDA HM (Italy)

Baja 10/10 JR & SR

Baja 12/14 MX

HUSQVARNA

CR 50 Senior Pro	05	F
CR 50 Junior	05	F
TE 100	05	F

METRAKIT

XL 80 Mini GP	09	R
Pre GP 125	09	R

MONTESA/HONDA

Honda 315 R	01-04	R
250 4RT Cota	05-10	R
260 4RT Cota (Repsol Edition 2E/4E)	14-18	R
4 Ride Enduro (260cc/4T)	16-18	R
Cota 300 RR (4T)	16-21	R

OSSA

TR 125 i	13-15	R
TR 250 i	14-15	R
TR 280 i	10-15	R
250 i Explorer	14-15	R
280 i Explorer	12-15	R
TR 300 i	14-15	R

POLINI

XP4 Street 50 10" wheels	F&R
XP 65 R	F&R
XP4 Street 125 10" wheels	F&R
XP4 Off Road 125 14" front /12" rear wheel	F&R

SACHS

Dirty Devil 125	08	F&R
-----------------	----	-----

SCORPA

*SR 125 (2T)	09-13	R
*SR 125 Long Ride (2T)	09-11	R
*SY 125 F	03-08	R

*Note: Check friction shape with

FA471 to get correct pad

SY 125 4T Long Ride

SY 125 FR (4T)

TYS 12F Long Ride

Twenty 125 (2T)

TY 125 (4T)

TYS 125 F

SY 175 F

TY-S 175 F

SY 200 F (4T) (163cc)

SY 250 (2T)

SY 250 Long Ride (2T)

SY 250 F (4T) Long Ride

SY 250 F

SY 250 FR Long Ride

SY 250 FR	06-10	R
SY 250 R (2T)	00-09	R
SR 280 (2T)	09-14	R
SR 280 (2T) Long Ride	09-11	R
Twenty 250 (2T)	15	R
Twenty 300 (2T)	15	R
Roadster 660	07	R

Trials 0.8 (2T)	01-10	R
ST 80 (2T/Formula Caliper)	13-14	R
ST 80 (2T/Braktec Caliper)	14-15	R
FST 125	18-19	R
125 ST-R	18-19	R
125 TY Classic	18-19	R
Trials 1.25 (2T/AJP Caliper)	06-12	R
ST 125 (2T/Formula Caliper)	13-14	R
ST 125 (2T/Braktec Caliper)	14-15	R
XY 125 (4T)	14-15	R
Trials 2.5 (2T/AJP Caliper)	06-12	R
ST 250 (2T/Formula Caliper)	13-14	R
ST 250 (2T/Braktec Caliper)	14-15	R
250 ST Factory	18-19	R
250 ST-R	18-19	R
Trials 2.9 (2T/AJP Caliper)	06-12	R
ST 290 Cabestany Replica (2T/Formula Caliper)	12	R
ST 290 (2T/Formula Caliper)	13-14	R
ST 290 (2T/Braktec Caliper)	14-15	R
300 FST	18-19	R
300 ST-R	18-19	R
Trials 3.2 (4T/AJP Caliper)	05-12	R
ST 305 (2T/Formula Caliper)	13-14	R
ST 305 (2T/Braktec Caliper)	14-15	R

TOMOS

MC 50 Senior Pro	05-07	F&R
------------------	-------	-----

XISPA

X 125 R	08-09	R
X 250 R	08-09	R
X 280 R	08-09	R

BRAKE PAD BUYERS GUIDE

DO NOT REFIT ANY SHIMS/INSULATORS TO EBC PADS FROM ORIGINAL PADS UNLESS INSTRUCTED ON NOTE ON PAD PACKAGING AND ON FA DRAWING ASSOCIATED WITH THAT PAD.

FA352 37.5 x 31.5 x 5.5mm



MATERIAL AVAILABILITY											
FA	TT	V	R	HH	MXS	SXR	EPFA	GPFA	SFA	SFAC	SFAHH
✓											

MINI MOTO

Pasini/GRC Calipers (Square 2 pin type)

POLINI

F&R Mini Motard 110cc 10" wheels (2 pin fixing) F&R
 XP4T 110cc Cross 14" front/12" rear wheel F&R
 XP4T 110cc Cross 12" front/10" rear wheel F&R

SFA353 A 97 x 39.5 x 9.5mm B 77 x 42 x 9.5mm

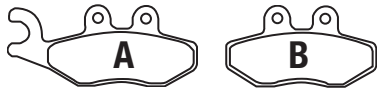

MATERIAL AVAILABILITY											
FA	TT	V	R	HH	MXS	SXR	EPFA	GPFA	SFA	SFAC	SFAHH
									✓	✓	✓

APRILIA

Sport City One 50 (2T) 08-11 F
 Sport City One 50 (4T) 08-10 F
 SR 50 Motard (2T) 12-15 F
 SR 50 Motard (4T/4V) 12-15 F
 Sport City One 125cc 08-11 F
SX 125 18-21 F
 SR 125 Max (4T) 11-15 F&R
 SR 125 Motard (4T) 12-15 F
 SR 300 Max (4T) 11-15 F&R
 SRV 850 12-14 R

DERBI

Boulevard 50 (2T) 09-12 F
 Boulevard 50 (4T) 09 F
 Vibrant Sport 50 (2T) 12 F
 Boulevard 125 (4T) 08-12 F
 Vibrant Sport 125 (4T) 12 F

GILERA

DNA 50 (Heng Tong Caliper) 01-05 F
 Runner 50 PJ/SP 06-14 F
 125 VX/180 VXR (4T) 01-04 F
 DNA 125/180 (Heng Tong Caliper) 01-03 F
 FX/FXR 125/180 Runner (Rear drum brake model/Heng Tong front caliper) 97-02 F
 Runner 125/180 FX/FXR/SP (2T) 99-02 F
 VXR 200 Runner (4T) 02-04 F
 Nexus 125 07-12 F&R
 Nexus 250 ie 07-08 F&R
 VX 125 Runner/ST (4T) 05-14 F
 VX 200 Runner/ST (4T) 05-11 F
 Nexus 300 i 08-12 F&R
 Fuoco 500 RC/ie 07-13 R
 Fuoco 500 LT (4V/4T) 13-15 R
 GP 800 (Chain drive) 08-14 R

KEEWAY

K2 125/150/250 07 F&R

PEUGEOT

Citystar 125 i 11-14 F
 Citystar 125 Active 13 F

PIAGGIO

Fly 50 (2T/4T) 05-18 F
 Liberty 50 (2T/4T) (10 spoke cast wheels) 09-20 F
 Typhoon 50 (2T) (12" wheels) 10-20 F
 Fly 100 (4T) 07-15 F
 Beverly 125 07 F
 Beverly B125 02-06 F&R
 Beverly Tourer 125 08-09 F&R
 Beverly 125 (4T) (Multi spoke cast wheel) 11-14 F
 Beverly S 125 07 F&R
 Beverly 125 ie S 14-15 F
 Carnaby 125 07-09 F&R
 Fly 125 (4T/2V) 05-11 F
 Fly 125ie (3V/4T) 12-14 F
 Fly 125 (4T/3V) Rear Disc Model 12-15 F
 Liberty 125 (2V/4T) 10 spoke cast wheels 09-15 F
 Liberty 125 Full optional (4T/3V/10 spoke wheel) 13-15 F
Liberty 125 Mymoover E5 3 Wheeler 21 F
 New Fly 125 ie (3V) 12-13 F

Skipper ST 125/150 4T 00-04 F
 Super Hexagon GTX 125/180 (11" wheels) 00 F
 Super Hexagon 125/180 (12" wheels) 01-03 F
 Typhoon 125 (4T) (12" wheels) 10-15 F
 Xevo 125 07-16 F
 X7 125cc 08-09 F
 X7 Evo 125 ie (EFI) 09-12 F
 X8 125 04-06 F
 X8 125 ie 07 F
 X8 125/Street 07 F
 X9 125 Evolution 05-07 F(left)
 X10 125ie (4V/4T/EFI/All models) 12-15 F(left)
 Fly 150 (4T) 05-12 F
 Liberty 15 (2V/4T) 10 spoke 09-12 F
 cast wheels 09-12 F
 Liberty 150 (2V/4T) 10 spoke 08-12 F
 cast wheels 13-15 F
 Liberty 150 Full optional (4T/3V/10 spoke wheel) 13-15 F
 X8 150 Street 07 F
 Beverly B 200 02-05 F&R
 Carnaby 200 07-09 F&R
 GT 200 L Granturismo 03-06 F
 Heng Tong Caliper 03-06 F
 X8 200 04-05 F
 Beverly 250 (Carb) 04-07 F&R
 Beverly 250 ie 06-07 F&R
 Beverly S 250 ie 07 F&R
 Beverly Tourer 250 ie 08-09 F&R
 Beverly Cruiser 250 ie 07-08 F&R
 Carnaby 250 ie 08-09 F&R
 X7 250cc ie 08-09 F
 X8 250 ie 05-07 F
 X9 250 05-06 F(left)
 Xevo 250 ie 07-10 F
 Beverly 300 (278cc/4T) Multi spoke cast wheel 10-15 F
Beverly 300 ie S 14-21 F
 Beverly Police 300 ABS ASR (278cc) 16-18 F
 Carnaby 300 ie 12 F&R
 Carnaby Cruiser 300 08-11 F&R
Beverly 350 ie Sport Touring ABS (330cc/4T) 16-21 R
 X7 300 Evo 09-12 F
 X10 ie 350 (4V/4T/EFI) All models 12-14 F(left)
 Beverly 400 ie 07 R
 Xevo 400 ie 07-11 F
 F(left)&R
 MP3 400 ie 07-09 R
 MP3-LT 400 ie 09-10 R
 X8 400 ie 06-08 F
 F(left)&R
 MP3 Touring Business 500 ie 11-12 R
 MP3 500 LT Business 11-15 R
 MP3 500 LT Business ABS (13 Inch) 11-15 R
 Front Wheel/14 Inch Rear Wheel 14-20 R
 MP3 Touring Sport 500 ie 11-12 R
 MP3 500 LT Sport 11-15 R
 MP3 500 LT Sport ABS (13 Inch) 11-15 R
 Front Wheel/14 Inch Rear Wheel 14-20 R
 X10 500ie (4V/4T/EFI) All models 12-14 F(left)

RIEJU

City Line 125 ie 13-15 F
 City Line 300 ie 14-15 F

VESPA

Primavera 50 (2T) 13-20 F
 Primavera 50 Touring (2T) 15 F
 Primavera 50 (4T/4V) 13-15 F
 Primavera 50 Touring (4T/4V) 15 F
 Sprint 50 (2T/4T) 14-20 F
 Sprint S 50 (2T) 15 F
 GT 125 L Granturismo Heng Tong Caliper 03-06 F
 GTS 125 07-11 F
GTS 125 Super ie (Inc ABS Models) 09-21 F
 GTS 125 Supersport ie (Inc ABS Models) 13-15 F
 GTV 125 07-09 F
 Primavera 125 (4T/3V) 13-15 F
Primavera 125 (4T/3V/ABS) 13-21 F
Primavera Touring 125 (4T/3V/ABS) 15-21 F
 Primavera Touring 125 (4T/3V/Non ABS) 15 F
 946 Special (4T/3V/125cc) 13-15 F
 Sprint 125 (4T/3V/ ABS) 14-20 F
 Sprint 125 (4T/3V/Non ABS) 14-20 F
Sprint S 125 (4T/3V/ABS) 15-21 F
 Primavera 150 (4T/3V) 13-15 F
 Primavera 150 (4T/3V/ABS) 13-20 F
 Primavera Touring 150 (4T/3V/ABS) 15 F
 Primavera Touring 150 (4T/3V/Non ABS) 15 F
 Sprint S 150 (4T/3V/ABS) 15-20 F
 GTS 250 ie/ABS 05-11 F
 GTS 250 ie/ABS 05-10 F
 GTV 250 ie 07-09 F
 GT 60 (Special Anniversary Model) (GTV 250) 06 F
 GTS 300 ie (Non ABS Models) 08-15 F
 GTS 300 ie Super (Non ABS) 08-15 F
 GTS 300 ie Super Sport (Non ABS) 08-15 F
 GTS 300 ie Touring (Non ABS Models) 11-16 F
GTV 300 ie Inc Super ABS models 10-21 F
GTS 4V ABS/Super Sport/Touring 18-21 F
 GTS 4V ABS 18-19 F

DO NOT REFIT ANY SHIMS/INSULATORS TO EBC PADS FROM ORIGINAL PADS UNLESS INSTRUCTED ON NOTE ON PAD PACKAGING AND ON FA DRAWING ASSOCIATED WITH THAT PAD.

FA354 97 x 51.5 x 7mm



MATERIAL AVAILABILITY												
FA	TT	V	R	HH	MXS	SXR	EPFA	GPFA	SFA	SFAC	SFAHH	
			✓			✓						
POLARIS												
Ranger (2x4/4x4)				02-05	F&R		500 Ranger 4x4 EFI				11-13	F&R
UTV 2x4 (Utility task vehicle series 10)				03	F&R		500 Sportsman Touring HO				11-13	R
PPS/UTV/Series 10 2x4					F&R		570 Ranger Crew				14-15	R
PPS/UTV/Series 10 4x6					F&R		570 Sportsman Ace				15	R
PPS/Series II UTV 1500 2x4					F&R		570 Sportsman Ace Euro				15	R
Ranger Series 10 "500 6x6"					F&R		Ranger 6x6 EFI 700				06-09	F&R
Ranger Series 11					F&R		Ranger XP 700 4x4				06/08	F&R
PPS/Series 11 2x4/4x4					F&R		Ranger EU Electric				10-14	R
PPS/Series 11 6x6					F&R		700 Ranger 4x4 EFI/LE				07	F&R
Ranger 6x6				04-05	F&R		700 Ranger 4x4 EFI				09	R
Ranger TM				04-06	F&R		700 Ranger 6x4 EFI				08	R
Ranger XP				05	F&R		Ranger TM				06	F&R
Ranger 2x4/4x4				04-06	R		800 Ranger HD				10-11	R
325 Sportsman Ace				14	R		800 Ranger XP				10-12	R
325 Sportsman Ace Efi				15	R		800 Ranger 6x6				10-14	R
325 Sportsman Ace Euro				14-15	R		800 Ranger RZR 4 EPS				12	R
325 Sportsman Ace HD				15	R		RZR-4 800 EFI				10-14	R
400 Ranger				10-14	R		900 D Ranger Diesel				11-14	R
Ranger EV (Electric)				10-11	R		Ranger RZR XP 900				11	R
Ranger 500 (2x4/4x4)				06-07	F&R		Ranger RZR XP 900 White Lightning LE				11	R
Ranger 500 (4x4 EFI)				06-07	F&R		900 Ranger RZR XP EFI				12	R
500 Ranger 4x4 EFI				08	R		900 Ranger RZR XP				12	R
500 Ranger 2x4				08	R		900 XP Ranger				13-15	R
500 Ranger (Carb) 2x4				09	R		1000 Ranger Diesel				15	R
500 Ranger (EFI) 4x4 HO				09-11	R		1000 Ranger Diesel Crew				15	R
500 Ranger Series 10 6x6					F&R		325 Ranger ETX				15-16	F&R
500 Ranger Crew				11-13	R		Brutus				13-14	R

FA355/4 45 x 51 x 7mm



MATERIAL AVAILABILITY												
FA	TT	V	R	HH	MXS	SXR	EPFA	GPFA	SFA	SFAC	SFAHH	
	✓		✓						✓	✓	✓	
ARCTIC CAT												
250 DVX Sport				06-08	R		SYM				10-15	F
300 DVX				09-14	R		GTS 125 i Joymax (All models)				14-15	F
							GTS 125 i Sport (All models)				07-08	F
							GTS 250				09-15	F
				01-06	F		GTS 250i/Joymax (All models)				06	F
				04-07	R		Joymax 250				07-08	F
				04-13	R		Joymax 250 i				07-08	F
				06	R		Voyager 250				05	F
				12-13	R		Voymax 250				06	F
				06-13	R		GTS 300/Joymax (All models)				08-15	F
							GTS 300 i Sport (All models)				14-15	F
				07	R		Cruisym 300 ABS				17-21	F
							Joymax Z 300 ABS				17-21	F
				05-07	R							
				05-07	R							

SFA356 55.5 x 46 x 7mm



MATERIAL AVAILABILITY												
FA	TT	V	R	HH	MXS	SXR	EPFA	GPFA	SFA	SFAC	SFAHH	
									✓		✓	
KYMCO												
Grand Dink 250				01-06	R							

FA357 A 62 x 31.5 x 6.5mm B 62 x 31.5 x 6.5mm

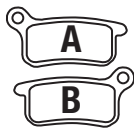

MATERIAL AVAILABILITY												
FA	TT	V	R	HH	MXS	SXR	EPFA	GPFA	SFA	SFAC	SFAHH	
	✓		✓									
GAS GAS												
MC 65				21	F&R		SX 65				09-21	F&R
							SX 85				03-10	F&R
							SX 85 (17"/14" wheels)				2011	F
				11-13	F		SX 85 (19"/16" wheels)				03-10	F&R
				18-22	F&R		SX 85 (19"/16" wheels)				2011	F
							SWM					
				02-08	F		MC 650 R				18	F

SFA358 A 86 x 40 x 9mm B 86 x 40 x 9mm



MATERIAL AVAILABILITY												
FA	TT	V	R	HH	MXS	SXR	EPFA	GPFA	SFA	SFAC	SFAHH	
									✓		✓	
HONDA												
NSS 250 Y/AY/1/A1/A3/3 Forza/Forza-S/Forza-T/Forza-ST/Jazz/Reflex (MF04/MF06)				00-04	R							

BRAKE PAD BUYERS GUIDE

DO NOT REFIT ANY SHIMS/INSULATORS TO EBC PADS FROM ORIGINAL PADS UNLESS INSTRUCTED ON NOTE ON PAD PACKAGING AND ON FA DRAWING ASSOCIATED WITH THAT PAD.

FA363 A 94 x 37.5 x 8.5mm
B 89.5 x 37.5 x 10mm



MATERIAL AVAILABILITY											
FA	TT	V	R	HH	MXS	SXR	EPFA	GPFA	SFA	SFAC	SFAHH
✓		✓	✓								

BMW		R Nine T Scrambler (K21/1170cc)		16-21	R	R 1200 GS (Cast wheels)		10-12	R
F 800 R	09-10	R	R Nine T Café Racer (K32/1170cc)	16-21	R	R 1200 GS Adventure (Spoke wheels)		10-12	R
R 850 C	97-00	R	R Nine T Urban GS (K33/1170cc)	17-21	R	R 1200 GS Adventure (30 Years GS)		11	R
R 850 GS	96-00	R	HP2 Enduro	05-08	R	R 1200 GS Adventure Triple Black		12-13	R
R 850 R	94-06	R	HP2 Megamoto (K25)	07-10	R	R 1200 GS Triple Black		11-12	R
R 850 RT	96-01	R	HP2 Sport (K29)	08-11	R	R 1200 GS (30 Years GS)		11	R
R 850 RT	06	R	S 1000 XR	15-21	R	R 1200 GS Rallye (Spoke wheels)		12	R
S 1000 XR	15-18	R	R 1200	00-02	R	R 1200 R SE		10-11	R
R 1100 GS	93-99	R	R 1200 C	96-04	R	R 1200 R Classic		11-14	R
R 1100 R	93-01	R	R 1200 RT K26/0368 Brembo Caliper	05-09	R	K 1200 S (K40)		05-08	R
R 1100 S	96-06	R	R 1200 RT	10-12	R	K 1200 R (K27/0378)			
R 1100 RT	94-01	R	R 1200 RT-SE	10-12	R	Tokico Caliper		11/05-10	R
R 1150 R	01-06	R	R 1200 ST K28/0328	03-08	R	R 1200 R		12/07-14	R
R 1150 RS	01-04	R	R 1200 S K29/0366 Brembo Caliper	06-07	R	K 1300 GT		09-11	R
R 1150 RT	00-06	R	R 1200 GS (K25/0307/Cast			K 1300 GT EE/SE		10-11	R
R 1150 R Rockster	03-06	R	/Spoke Wheel)	02-11/07	R	K 1300 R		09-12	R
R 1150 GS (EVO R21/0415/0495)	11/01-03	R	R 1200 GS Adventure (K25/0382			K 1300 R Dynamic		11-15	R
R 1150 GS (R21/0415/0495)	98-10/01	R	/Spoke wheel)	05-11/07	R	K 1300 R Carbon		12	R
R 1150 GS Adventure	07/01-06	R	R 1200 GS Adventure/M (K25/0380			K 1300 S (Non & ABS Models)		09-15	R
R Nine T (K21 1170cc)	14-18	R	/Spoke wheel)	06-09	R	K 1300 S Sport		12-15	R
R Nine T/T (K21 1170cc)	20-21	R	R 1200 GS/M (K25/0303/Cast			K 1300 S HP		12	R
R Nine T Pure (K22/1170cc)	16-21	R	/Spoke Wheel)	06-09	R				

FA366 70 x 46.5 x 13mm



MATERIAL AVAILABILITY											
FA	TT	V	R	HH	MXS	SXR	EPFA	GPFA	SFA	SFAC	SFAHH
	✓	✓		✓							

SUZUKI

VL 1500 K2/K3 Intruder	02-03	R
VL 1500 K5-K8 (C 1500 Intruder)	05-08	R

FA367 67 x 36 x 11mm

FA367/2 67 x 36 x 8.5mm



MATERIAL AVAILABILITY											
FA	TT	V	R	HH	MXS	SXR	EPFA	GPFA	SFA	SFAC	SFAHH
	✓		✓		✓		✓				

BETA		KX 250 F (KX 250 W9F/XAFB/YBF/				TM			
Minitrial E	14	F&R	YCF/ZDF/ZEF/ZFF/ZGF) (4T)	09-16	R	MX 85 JR (Small wheel 14" - 17")		10-21	F&R
APRILIA			KX 250 F (ZFF/ZGF/AHF/AJF)	15-18	R	MX 85 (Big Wheel 16" - 19")		10-21	F&R
MXV 450	09-13	R	KX-F 250	15-22	R	MX 100 Jnr (Small wheel 14" - 17")		19-21	F&R
RXV 450/550 Enduro	06-13	R	KX-F 250 XC Enduro	21-22	R	MX 100 JR (Big wheel 16" - 19")		19-21	F&R
SVX 450/550 Supermotard	06-13	R	KX 450 F (D6F/D7F/D8F/E9F/EAF/EBF			Enduro EN 125 2S Inc Tsi (2T)		10-21	R
BETA			/FCF/FDF/FCF/FFF/HGF/HJF)	06-18	R	MX 125 2S (2T)		10-21	R
RR 125 4T Enduro (LC)	11	R	KX 450 F (JKF)	18-20	R	SMR 125 Tsi (2T)		10-21	R
FANTIC			KX-F 450	18-22	R	EN/MX 144 2S Inc Tsi (2T)		08-21	R
Caballero 50 Regularita Competizione	06-09	R	KX-F 450 XC Enduro	21-22	R	EN 250 F (4T) Enduro		05-09	R
Caballero 50 Supersei Competizione	07-08	R	KLX 450 R (A8F/A9F/AAF/ABF/ACF/ADF			EN 250 Fi ES (4T)		10-21	R
Caballero 125 Regularita Competizione	07-09	R	/AEF/AFF/AGF/AHF/AJF)	08-18	R	EN 250 Tsi ES Enduro (2T)		10-21	R
Caballero Regularita Competizione Mini 50	08-09	R	SHERCO			MX 250 Es 2S (2T)		10-21	R
XE 125CC 2T	21	R	Enduro 2.5i F (4T) (inc SE models)	08-11	R	MX 250 (4T)		05-09	R
XX 125cc 2T	21	R	SM 2.5i Supermotard	08	R	MX 250 Fi ES (4T)		10-21	R
XX 125 2T	21-22	F	SX 2.5i F Moto Cross	10	R	SMM 250 F (4T)		10-15	R
XX 250	21-22	F	Enduro SE 3.0i (4T)	10-11	R	SMR 250 (2T)		05-15	R
XEF 250	21-22	F	SE 450 iR Enduro (Nissin rear caliper)	12	R	SMR 250 F (2T/4T)		10-15	R
XEX 250	21-22	F	SM 450i	04-09	R	SMX 250 (2T)		15	R
XEF 450	21-22	F	Enduro 4.5i	04-10	R	SMX 250 F		10-15	R
XXF 450	21-22	F	SM 4.5i F Supermoto	04-07	R	EN 300 2S Inc Tsi ES Enduro (2T)		10-21	R
GAS GAS			SM 4.5i F Black Panther	08-12	R	FT 300 2S ES		19-21	R
EC 125/200/250/300 (All Models/2T)	09-15	R	4.5i Enduro (4T)	06-09	R	MX 300 (2T)		10-21	R
EC 200-250-300 XC 250-300 Euro4	18-20	R	5.1i Enduro	06-09	R	MX 300 Fi ES - Twin 4T		10-21	R
EC Ranger 200/300	18-20	R	Enduro 5.1iF	07-11	R	SMR 300 Tsi ES (2T)		05-21	R
EC Six Days 250/300	19	R	5.1i Supermotard	06-09	R	SMX 300 2S ES (2T)		15-21	R
MX 125/250	09-11	R	SM 5.1iF Supermotard	07	R	EN 450 F		04	R
EC 250 F (All Models/4T)	12-15	R	SM 5.1iF Black Panther	08-12	R	EN 450 Fi ES		10-21	R
EC 300/450 F (All Models/4T)	13-15	R	SE 510 iR (Rear Nissin Caliper)	12	R	FT 450		19-21	R
EC 450 Raid	14	R	SUZUKI			MX 450 Fi ES		10-21	R
KAWASAKI			RM-Z 250	04-21	R	SMM 450 F		11-15	R
KX 250 F (KX 250 N1/N2)	04-05	R	RMX 450 ZL0/ZL2	10-15	R	SMR 450 FES		05-11	R
KX 250 F (T6F/T7F/T8F)	06-08	R	RM-Z 450	05-21	R	SMR 450 Fi ES (4T)		10-21	R

BRAKE PAD BUYERS GUIDE
DO NOT REFIT ANY SHIMS/INSULATORS TO EBC PADS FROM ORIGINAL PADS UNLESS INSTRUCTED ON NOTE ON PAD PACKAGING AND ON FA DRAWING ASSOCIATED WITH THAT PAD.

FA367 67 x 36 x 11mm

FA367/2 67 x 36 x 8.5mm

SMX 450 F	05-15	R	Zero S (ZF8.5/ZF11.4)			RR 300 Enduro (2T)	13-14	R
EN 530 Fi ES (4T)	10-21	R	(Nissin F&R Calipers)	10-13	R	Enduro RR 300 (2T) Inc Racing and MY20	15-21	R
FT 530 Fi ES	19-21	R	Zero XU (Nissin F&R Calipers)	10-13	R	RR 300 Enduro Racing (2T)	13-14	R
MX 530 Fi ES	10-21	R	Zero FX (Nissin F&R Calipers)	10-13	R	RR 300 Racing (2T)	15	R
SMR 530 FES	05-09	R	FA367/2 - BETA			300 X-Trainer (2T)	15-21	R
SMR 530 Fi ES	10-21	R	RR 50 Motard (Spoke wheel)	09-12	R	Alp 4.0 (4T/349cc)	05-15	R
SMR 530 F (4T)	10-14	R	RR Motard 50 Track (Cast wheels)	08-20	R	M4 350 Motard	07-15	R
SMX 530 F	05-15	R	RR Motard 50 Standard			RR 350 4T Enduro	11-14	R
SMX 660 F	05-10	R	(Cast wheel/5 spoke)	13-15	R	RR 350 EFi (4T)	15	R
WK			RR Motard 50 Sport			RR 350 Enduro Racing 4T	13	R
Trial 125	11-14	R	(Cast wheel/5 spoke)	14-20	R	Enduro RR 350 (4T) Inc Racing and MY20	15-21	R
YAMAHA			RR Motard 50 (Spoke wheel)	12-13	R	Enduro RR 390 (4T) Inc Racing and MY20	15-21	R
YZ 125 R/S/T/N/W/X/Y/Z/A/B/D/E/F/G/H/J/K (2T)	03-21	R	RR Enduro 50 Standard	09-14	R	Enduro 350 RR-S (4T) MY20	20-21	R
WR 250 FR/FS/FT/FV/FW/FX/FY/FZ/FA/FB/FD (4T)	03-13	R	RR Enduro 50	08-20	R	Enduro 390 RR-S (4T)	20-21	R
WR 250 FF/FG/FH/FJ/FK (4T/Reverse Cylinder)	15-21	R	RR 50 Enduro Factory	12-20	R	RR 400 4T Enduro	05-11	R
WR 250 RX/RX (32D-)	08-19	R	RR Motard 50 Standard	09-12	R	RR 430 (4T)	15	R
WR 250 XX/XY (32D-)	08-15	R	RR Motard 50 Skull	11	R	Enduro RR 430 (4T) Inc Racing and MY20	15-21	R
YZ 250 R/S/T/N/W/X/Y/Z/A/B/D/E/F/G/H/J (2T)	03-18	R	RR 50 Track (Spoke wheel)	14	R	Enduro 430 RR-S (4T)	20-21	R
YZ 250 FR/FS/FT/FV/FW/FX/FY/FZ/FA/FB/FD/FE/FF (4T)	03-15	R	Alp 125 (4T)	05-15	R	RR 450 4T Enduro	12-14	R
YZ 250 FG/FH/FJ (270mm Disc)	16-21	R	Enduro RR 125 (2T) MY20	20-21	R	RR 450 Enduro Racing (4T)	13-14	R
YZ 250 FGY (60th Anniversary Edition/270mm Disc)	16	R	RR 125 4T Enduro (A/C)	09-14	R	RR 450 4T Cross Country	12	R
YZ 450 FG/FH/FJ/FK (270mm Disc)	16-21	R	RE 125 4T Enduro	08-14	R	RR 480 (4T)	15	R
YZ 450 FGY (60th Anniversary Edition/270mm Disc)	16	R	RR 125 4T Enduro (L/C)	11-18	R	Enduro RR 480 (4T) Inc Racing and MY20	15-21	R
WR 450 FR/FS/FT/FV/FW/FX/FY/FA/FB/FD/FE/FF (4T)	03-15	R	RR 125 Motard (4T)	08-15	R	RR 498 4T Enduro	12-14	R
WR 450 FG/FH/FJ/FK (270mm F/Disc/4T)	16-21	R	RR Motard 125 4T (LC) (Cast wheels)	11-18	R	RR 490 Enduro Racing (4T)	13-14	R
YZ 450 FR/FS/FT/FV/FW/FX/FY/FZ/FA/FB/FD/FE/FF (4T)	03-15	R	RR-S 125 ZD3E9143 4T LC CBS	18-20	R	Enduro 500 RR-S (4T)	20-21	R
ZERO			RR-S 125 Motard ZD3E9143 4T LC CBS	18-20	R	RR 520 Enduro	05-11	R
Zero DS (ZF8.5/ZF11.4) (Nissin F&R Calipers)	113	R	Urban 125	08-15	R	RR 525 4T Enduro	05-09	R
Zero MX (ZF2.8/ZF5.7) (Nissin F&R Calipers)	10-13	R	Urban 125 Special	09-15	R	KTM		
			Alp 200 (4T)	05-15	R	SX85 (Aftermarket caliper used with 220mm disc)	03-15	R
			Enduro RR 200 (2T) MY20	20-21	R	RIEJU		
			RR 250 4T Enduro	05-07	R	MRX 50 Pro Competizione (Spoke Wheel)	11-14	R
			Urban 200	08-15	R	Marathon Pro 125 Competizione	11-14	R
			RR 250 Special	09-15	R			
			RR 250 Enduro (2T)	13-14	R			
			RR 250 Enduro Racing (2T)	14	R			
			Enduro RR 250 (2T) Inc Racing and MY20	15-21	R			
			250 X-Trainer 2T	20-21	R			

FA368 A 64 x 41.5 x 9mm B 64 x 41.5 x 9mm



MATERIAL AVAILABILITY											
FA	TT	V	R	HH	MXS	SXR	EPFA	GPFA	SFA	SFAC	SFAHH
	✓		✓		✓		✓				

ALTA MOTORS			FE 450 (New 70° Engine)	08-14	R	TX 300 Inc Tpi model (2T)	18-22	R
Redshift MX	16-18		FX 450	10-12	R	TE 310 (4T)	09-13	R
Redshift SM	16-18		FE 501 (4T)	13-14	R	TE 310 R (4T)	13	R
BMW			FS 570 Supermoto	10-12	R	FC 350 (4T)	14-22	R
G 450 X	08-11	R	FE 570	09-12	R	FX 350 4T	18-22	R
BREMBO			TE 570	09	R	TE 410	06	R
Xq 21390 PF 26 Off Road Rear Caliper			HUSQVARNA			SMR 449	11	R
GAS GAS (Pierer Mob)			TC 85 17" F/wheel,			TC/TE 449 (4T)	11-13	R
MC 85 2T	21-22	R	14" R/wheel small wheel	21-22	R	FC 450 (4T)	14-22	R
MC 125 2T	21-22	R	TC 85 19" F/wheel,			FE 450 (4T)	14-20	R
EC 250 2T	21-22	R	16" R/wheel big wheel	21-22	R	FR 450 (4T)	16-20	R
EC 250 F	21-22	R	CR 125	05-13	R	FX 450 (4T)	17-22	R
EX 250 F	21-22	R	SMS 4 125 (4T)	11	R	SMR 450 RR (Radial caliper)	06-07	R
MC 250 F 4T	21-22	R	TC 125 (2T)	14-22	R	SM 450 R Radial Caliper	07-10	R
EC 300 2T	21-22	R	TE 125 (2T)	14-19	R	SM 450 RR	08-10	R
EX 300 2T	21-22	R	WR 125	06-13	R	TC 450	05-10	R
EC 350 F 4T	21-22	R	TE 150i 2T	18-20	R	TE 450	06-10	R
EX 350 F	21-22	R	CR 250	05	R	FE 501 (4T)	14-15	R
EX 450 F	21-22	R	FC 250 (4T)	14-22	R	SM 510 R (Radial caliper)	06-09	R
MC 450 F 4T	21-22	R	FE 250 (4T)	14-20	R	TC 510	05-09	R
HUSABERG			TC 250 (2T)	14-20	R	TE 510	06-10	R
TE 125 2T	12-14	R	TC 250 (4T)	02-13	R	SMR 511	11-13	R
FE 250 (4T)	13-14	R	TE 250 Inc Tpi (2T)	14-20	R	TE 511 (4T)	11-13	R
TE 250 (2T)	11-14	R	TE 250 (4T)	06-13	R	SM 530 RR	08-10	R
TE 300 (2T)	11-14	R	TE 250 Meo Replica (4T)	11	R	SM 630 (4T)	10	R
FE 350 (4T)	13-14	R	TE 250 R (4T)	13	R			
FE 390 (New 70° Engine)	10-12	R	TE 300 Inc Tpi and Jarvis Edition (2T)	14-20	R			

BRAKE PAD BUYERS GUIDE

DO NOT REFIT ANY SHIMS/INSULATORS TO EBC PADS FROM ORIGINAL PADS UNLESS INSTRUCTED ON NOTE ON PAD PACKAGING AND ON FA DRAWING ASSOCIATED WITH THAT PAD.

FA368 A 64 x 41.5 x 9mm B 64 x 41.5 x 9mm

KTM

SX 85 17" F/wheel, 14" R/wheel small wheel	21-22	R	EXC-F 450 (4T) Six Days	11-22	R	SE-R 250 (2T)	12-15	R
SX 85 19" F/wheel, 16" R/wheel big wheel	21-22	R	SMR 450	04-13	R	SEF 250 (4T)	13-15	R
SX 125 (Upside Down Forks)	09-22	R	SMR 450 (Brembo f/caliper)	14	R	SEF-R 250 (4T)	13-15	R
EXC 125	04-17	R	SX 450 (4T)	03-06	R	250 SC-Factory	19-21	R
EXC 125 (2T) Six Days	11-17	R	SX-F 450 (4T) Inc Cairoli	07-22	R	250 SCF-Factory	19-21	R
XC-W 125 (2T)	17-19	R	EXC-R 450 (4T)	08	R	250 SE-R	19-21	R
150 EXC Tpi	22	R	EXC-F 500 (4T)	12-21	R	250 SE-Factory	19-21	R
SX 150	08	R	EXC-F500 (4T) Six Days	12-21	R	250 SEF-R	19-21	R
SX 150 (Upside Down Forks)	09-22	R	500 XCF-W	21	R	250 SEF-Factory	19-21	R
XC 150 (USD)	11-13	R	SX-F 505	07-09	R	SE300 i (2T/Brembo Rear Caliper)	12-15	R
XC-W 150 (2T) Inc Tpi	17-21	R	SMR 525	04-05	R	SE-R 300 (2T)	12-15	R
EXC 200 (inc Six Days)	04-16	R	SX 525	03-06	R	SEF 300 (4T)	13-15	R
SX 250 (2T) (Upside Down Forks)	09-22	R	EXC 525	04-05	R	SEF-R 300 (4T)	13-15	R
SX-F 250 (4T) Inc Prado	06-22	R	EXC 525 Racing	04-06	R	300 SC-Factory	19-21	R
EXC 250 Inc Tpi (2T)	04-22	R	XC 525 Racing	06-07	R	300 SCF-Factory	19-21	R
EXC 250 Racing	06	R	EXC-R 530 (4T)	08	R	300 SE-R	19-21	R
EXC 250 Inc Tpi (2T) Six Days	11-22	R	EXC 530	09-11	R	300 SE-Factory	19-21	R
EXC-F 250	06-22	R	EXC 530 (4T) Six Days	11	R	300 SEF-R	19-21	R
EXC-F 250 (4T) Six Days	11-22	R	SMR 560	07	R	300 SEF-Factory	19-21	R
SX-F 250 Ken Roczen Edition	12	R	SXC 625	05-06	R	SEF 450 (4T)	14-15	R
XC 250-W (2T) Tpi	11-21	R	SMR 650 Supermoto	06	R	SEF-R 450 (4T)	14-15	R
XC-F 250 (USD)	11-22	R	SMR 650	05	R	450 SCF-Factory	19-20	R
EXC 300 (2T)	09-22	R	OSSA			450 SE-R	19-20	R
EXC 300 (2T) Tpi Six Days & Erzbergroede	11-22	R	Enduro 250 i	12	R	450 SEF-Factory	19-20	R
XC 300 Inc XC-W Tpi (2T)	11-21	R	Enduro 300 i	12	R	500 SCF-Factory	19-20	R
EXC-F 350	11-22	R	RIEJU			500 SEF-R	19-20	R
EXC-F 350 WESS	21	R	Marathon 250	09-10	R	500 SEF-Factory	19-20	R
EXC-F 350 Six Days	12-22	R	Marathon 450	09-10	R	SWM		
SX-F 350 (Upside Down Forks)	11-22	R	MR Pro 200/250/300cc 2T	19-21	R	MC 1265 R	18	R
SX-F 350 Tony Cairoli Edition	12	R	MR Ranger 200/250/300cc 2T	19-21	R	MC 250 S	16	R
XC-F 350 Inc XCF-4T	12-22	R	MR Ranger 200/250/300cc 2T	19-21	R	FT 300 R (RS 300 R Flat Track)	17	R
EXC 400 Racing	04-07	R	SHERCO			RS 300 R (4T)	15-18	R
EXC 400 (4T)	09-11	R	125 SC-Factory	19-20	R	RS 340 S	16	R
450 Rally	17-21	R	125 SE-R	19-20	R	SM 450 R (4T)	15-18	R
EXC-F 450 (4T)	11-22	R	SE 250 i Enduro (2T)			RS 500 R (4T)	15-18	R
EXC 450 Racing	06-07	R	(Brembo rear caliper)	12-15	R	SM 500 R (4T)	16-20	R
			SE 300 i Enduro (2T)					
			(Brembo rear caliper)	12-15	R			
			SE250 i (2T/Brembo Rear Caliper)	12-15	R			

FA369/4 49.5 x 38.5 x 8mm



MATERIAL AVAILABILITY											
FA	TT	V	R	HH	MXS	SXR	EPFA	GPFA	SFA	SFAC	SFAHH
				✓			✓				

KAWASAKI

ZX-6RR (ZX 600 K1/M1/N1/N6F)	03-06	F	GSXR 1000 K3	03	F
ZX6R (ZX 636 B1/B2/C1/C6F)	03-06	F	M 1600 (VZ 1600 K5 Intruder)	05	F
ZX 10 R (ZX 1000 C1/C2/D6F/D7F)	04-07	F	VZ 1600 K5 (M 1600 Intruder)	05	F
ZX 12 R (ZX 1200 B3/B4/B6F)	04-06	F			
VN 1600 B2H/B6F/B7F (Mean Streak)	05-08	F			

SUZUKI

FA372 A 55.5 x 37 x 11mm B 85 x 43 x 8.5mm



MATERIAL AVAILABILITY											
FA	TT	V	R	HH	MXS	SXR	EPFA	GPFA	SFA	SFAC	SFAHH
	✓		✓								

SUZUKI

LT-A 500 FK3/FK4/FK5/FK6/FK7											
Vinson 4WD Auto	03-07	R									
LT-F 500 FK3/FK4/FK5/FK6/FK7	03-07	R									

FA373 75.5 x 39.5 x 12mm



MATERIAL AVAILABILITY											
FA	TT	V	R	HH	MXS	SXR	EPFA	GPFA	SFA	SFAC	SFAHH
	✓		✓								

HONDA

TRX 420 FA9/FAA/FBB Fourtrax							TRX 450 R4-R9/ER6-ER9	04-09	R
Auto 4WD	09-11	R	TRX 650 FA3-FA5 Rincon 4x4 Auto	03-05	R				
TRX 420 FPA9/FPAA/FPBA Fourtrax			TRX 680 FA6-FA9/FAA/FAB/FAC						
Auto Power Steering	09-11	R	Rincon 4x4 Auto	06-21	R				
TRX 420 All Models	14-21	R							

FA374 A. 95.5 x 42 x 8mm B. 77 x 42 x 8mm

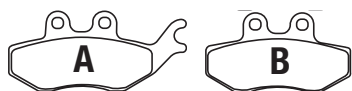

MATERIAL AVAILABILITY											
FA	TT	V	R	HH	MXS	SXR	EPFA	GPFAX	SFA	SFAC	SFAHH
✓									✓		

ITALJET											
Jupiter 250				02-03	R		RS3 50				11-20 F
RIEJU							RS3 50 Pro				11-20 F
NKD 50				07	F		RS2 125				06-08 F
RS2 Matrix (50cc)				02-08	F		RS3 125				11-20 F
							125 NKD				06-07 F

FA375 A 110.5 x 34.5 x 7.5mm B 99 x 33.5 x 7.5mm

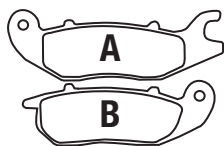

MATERIAL AVAILABILITY											
FA	TT	V	R	HH	MXS	SXR	EPFA	GPFAX	SFA	SFAC	SFAHH
✓		✓		✓					✓		

AJS							Monkey 125				18-21 F
Regal Raptor CR3-125				06	F		MSX 125 D/E/F/G/H Grom (Non ABS)				13-21 F
HERO							MSX 125 AH Grom (ABS)				18-21 F
Karizma ZMR 230				11-12	F		CBR 150 R				00-03 F
HONDA							LIFAN				
ANF 125 3/5/T5/6/T6/7/A Innova				03-11	F		Smart 50/125				F
CBF 125 M9/MA/MB/MD/ME				09-15	F		RIEJU				
CBR 125 R4/R5/RS5/RS6				04-06	F		NKD 50				08-09 F
CBR 125 RW5/RW6/RW7/RW8/ RW9/RWA/RWB/RC/RD/RF				05-16	F		RS2 50cc Matrix/Pro				07-09 F
CBR 125 R4/R5/RS5/RW5-RW9/ RWA (6 Bolt Front Disc/Canada)				04-10	F		RS2 50 FR				09-10 F
CBR 125 RWB/RC/RD/RF/RG							NKD 125				08-09 F
(5 Bolt Front Disc)				11-16	F		RS2 125/Pro				07-09 F
FS 125 Sonic				03-04	R		SUPERBYKE				
							CQ 50 Road Classic				F
							CU 125 Road Classic				F

FA377 A 94 x 46 x 8.5mm B 73 x 46 x 11mm



MATERIAL AVAILABILITY											
FA	TT	V	R	HH	MXS	SXR	EPFA	GPFAX	SFA	SFAC	SFAHH
✓	✓	✓	✓	✓							

ADLY			KYMCO			TGB					
Crossroad 220 Sentinel Quad		F	KXR 250 Mongoose Quad	04-07	F	Blade 325 LE (4x2)				09-10	F
Canyon 280 Quad	08-09	F	Maxxer 250	12-13	F	Avenger 400 Quad (4x2)				07-08	F&R
Hurricane 280 Quad	08-09	F	MXU 250	04-13	F	Avenger 400 LE (4x2)				09-10	F
Canyon 300 Quad	08-09	F	MXU 250 R	12-13	F&R	Blade 425 Quad (4x4)				07-08	F&R
Crossroad 300 Sentinel Quad	08-09	F	Urban Quad 250	06	F	Blade 425 SE (4x4)				09-10	F
Utility 300	05-07	F	MXU 300	06-21	F&R	Blade 450 SE 4x4				10-11	F
Hurricane 300 Quad	08-09	F	MXU 300 R	10-21	F&R	Blade 460 SL IRS 4x4				12	F
300 RS Quad	07-08	F	Maxxer 300	06-13	F	500 Avenger R (4x2)				09-10	F
300 XS Quad	07-08	F	MXU 450i (Side X Side)	15-21	F&R	Blade 510 LE				11-12	F
320 S Quad	08	F	UXV 450i (Side x Side)	15-21	F&R	Blade 525 SE				09-10	F
Hurricane 320 Quad	08-09	F	MXU 500i (4x4 IRS) (LAAOCD/CM)			Blade 525 SL				09-10	F
500 S	08	F	(Parking brake)	09-14	PB	Blade 525 SE 4x4				09-10	F&R
AEON			MXU 500 4x4/Carb Model	05-09	F&R	Blade 550 LT 4x4				10-11	F
Overland 600 (Quad)	10-11	F	UXV 500 4x4 (Side x Side) (U10000)	08-21	F&R	Blade 550 SL 4x4				09-10	F
ARCTIC CAT			UXV 500i (Side x Side/4x4) U10100	10-21	F&R	Blade 550 SE 4x4				09-11	F
Alterra 90	17-19	R	MXU 550i (4x4 LOF) Parking Brake	13-20	PB	Blade 550 4x4 IRS Target				11-12	F
DVX 90	2018	R	MXU 700i (4x4 LOF) Parking Brake	13-18	PB	Gunner 550 4x4 Target				10-12	F&R
150 Utility 2 x 4	15-18	R	UXV 700i Turf Parking Brake	14-21	PB	Target 550 IRS Blade LT				10-12	F
250 DVX Sport	06-08	F	PGO			YAMAHA					
300 Alterra	17-19	F&R	BR-500i Racer	07-09	R	MT 125 (Non ABS)				14-21	R
300 DVX	09-14	F	500 Bug	08-09	R	MT 125A (ABS)				14-21	R
300 2x4 Utility (Mid Size)	10-14	F&R	BR 600 I Bug Racer	12	R	YZF-R 125				08-14	R
500 Prowler	18-19	F&R	QUADZILLA			YZF-R 125 (Radial F/Caliper/Non ABS)				14-16	R
BOMBARDIER			RS7 4WD	10-11	F	YZF-R 125A (Radial F/Caliper/ ABS)				14-21	R
DS 250	06	F&R	RS8	10-11	F						
CAN-AM			X7R	10-11	F						
DS 250 (3J7A/B)	07-15	F&R	SYM								
CECTEK			SB 125 Ni-Wolf	11-15	R						
500 EFI Gladiator	09-10	F	Quadlander 200	12-13	F						
GPI			Trackrunner 200 Quad	05-07	F						
XS 250 Quad	06-09	F	Quadlander 250	05-13	F						
INDIAN			SB 250 Ni (Wolf SB)	12-15	R						
Scout (Cast Wheels/Toso Calipers)	15-16	R	Citymax 300 Quad	06	F						
Scout Sixty (Cast Wheel/Toso Calipers)	16	R	Quadlander 300	08-10	F&R						
KAWASAKI			Quadlander 300 S	07-15	F&R						
KVF 300 CCF/CDF/CEF/CFE/CGF			Quadraider 600	06-07	R						
/CHF Brute Force	12-17	F&R	Quadraider 600	08-15	F&R						
			Quadraider 600 LE (Quad)	10-15	F&R						

FA379 71.5 x 50 x 8mm

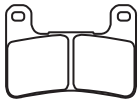

MATERIAL AVAILABILITY												
FA	TT	V	R	HH	MXS	SXR	EPFA	GPFAX	SFA	SFAC	SFAHH	
				✓			✓	✓				
KAWASAKI												
ZX 25 Ninja				20-21								
Z 900 RS Performance				18-21	F							
ZX10R (ZX 1000 E8F/E9F/FAF)				08-10	F						14-21	F
ZX10R ABS (ZX 1000 KBF/KCF /KDF/KEF/KFF)				11-15	F						14-21	F
ZX10R (ZX 1000 JBF/JCF/JDF/JEF/JJF)				11-15	F						21	F
ZX10R 30th Anniversary Edition Non ABS (ZX 1000 JFFA)				15	F						18-20	F
ZX10R 30th Anniversary Edition ABS (ZX 1000 KFFA)				11-15	F						18-20	F
KLZ 1000 Versys SE LT & LT+ ABS				18-21	F						19-20	F
KLZ 1000 Versys S Tourer & Grand Tourer				20-21	F							
Z 1000 (ZR 1000 DAF/DBF/DCF /DDF/FEF/FFF)				10-15	F							
Z 1000 EAF/EBF/ECF/ECFA/EDF/EDFA (ABS/300mm Discs)				10-13	F							
Z 1000 FEF/FEFA/FFF/FGF (Non ABS/310mm Discs)				14-16	F							
Z 1000 GEF/GEFA/GFF/GGF/HHF/HJF (ABS/310mm Contour Discs)				14-18	F							
Z 1000 ABS (ZR1000 EAF/EBF/ECF /EDF/GEF/GFF)				10-15	F							
Z 1000 SX (ZX 1000 HBF/HCF/HDF) (ABS)				11-13	F							
Z 1000 SX (ZX 1000 GBF/GCF/GDF) (Non ABS)				11-13	F							
Z 1000 SX (ZX 1000 LEF/LFF/LGF) (Non ABS)				14-16	F							
Z 1000 SX ABS Model (ZX1000 MEF/MFF/MGF/WHF/WJF)				14-18	F							
Z 1000 SX Tourer				14	F							
Z 1000 Special Edition (ZR 1000 GEFA)				14	F							
Z 1000 (ZR 1000 GEF)				14	F							
Z 1000 Black Edition (ZR 1000 DCF/DDFA/FEFA)				12-15	F							
SUZUKI												
GSXR 600 K4/K5/K6/K7/K8/K9/L0				04-10	F							
GSXR 750 K4/K5/K6/K7/K8/K9/L0				04-10	F							
GSX-S 950				21	F							
DL 1000 AL4-AL9 V-Strom (ABS)				14-20	F							
DL 1000 XT XAL8/XAL9 V-Strom (ABS)				18-20	F							
DL 1050 V-Strom (ABS)				14-21	F							
DL 1050 V-Strom XT (ABS)				14-21	F							
DL 1050 V-Strom XT Tour (ABS)				18-21	F							
GSXR 1000 K4-K9/L0/L1				04-11	F							
GSX 1300 RK8/RK9/K9/RL0/RL1 /RL2 Hayabusa				08-12	F							
M 1800 R (VZR 1800 K6/K7/K8/K9) Intruder - Handlebar Cowling				06-09	F							
M 1800 R2 (VZR 1800 NK8/NK9) Intruder - No Handlebar Cowling				08-09	F							
M 1800 RZ (VZR 1800 ZK7/ZK8 /ZL1/ZL2) Intruder - With Handlebar Cowling				07-13	F							
VZR 1800 K6/K7/K8 (M 1800 R Intruder)				06-09	F							
VZR 1800 RZK8 Intruder M1800 R2/M109 R2				08-09	F							
VZR 1800 BLZ4/BZL5/BZL6/BZL7 /BZL8 M1800 RB				14-18	F							

FA380 50.5 x 69 x 8.5mm



MATERIAL AVAILABILITY												
FA	TT	V	R	HH	MXS	SXR	EPFA	GPFAX	SFA	SFAC	SFAHH	
				✓			✓	✓				
KAWASAKI												
ST 700 Stallion				14-18	F							
YAMAHA												
FZ1 N/NA Naked (Non ABS/ABS)				10-14	F							
FZ6 Fazer S2 (ABS) (4 piston caliper)				07-09	F							
FZ8N-Naked/Single Headlight/ Non ABS (RN255/39P1) (800cc)				11-15	F							
FZ8NA-Naked/Single Headlight/ ABS (RN256/59P1) (800cc)				11-15	F							
Fazer 8-FZ8-S (800cc) (Top Fairing/Twin Headlight/Non ABS) (RN251/42P1)				11-15	F							
Fazer 8-FZ8-SA (800cc) (Top Fairing/Twin Headlight/ABS) (RN252/1BD1)				11-15	F							
Niken ABS (847cc/3 Cyl Engine)				18-20	F							
YZF R6				04-21	F							
YZF R1				04-06	F							
FZ1 N/NA (Naked) Non ABS/ABS				10-15	F							
FZ1 Fazer (Half Fairing - ABS - 5D0)												
FZ1 Fazer (3C3) Non ABS) Half Fairing				08-15	F							
MT-01 (1670cc)				06-15	F							
MT-10 (MTN 1000/998cc)				05-06	F							
MT-10 Tourer Edition (998cc)				16-20	F							
MT-10 SP (MTN 1000D/998cc)				18-20	F							
YZF- R1SP				17-21	F							
YZF-R1				06	F							
YZF-R1M				15-21	F							
YZF-R1 (60th Anniversary Edition)				16	F							
XT 1200 Z Super Tenere				10-18	F							
(ABS/UBS Brake system)					F							
XT 1200 ZE Super Tenere				14-18	F							
(ABS/UBS Brake system)					F							
XT 1200 ZE Super Tenere Raid Edition (ABS/UBS Brake System)				18	F							
XSR 900 ABS (MTM 850)				16-21	F							
XSR 900 Abarth ABS (MTM 850)				17-18	F							

FA381 103 x 48 x 11mm

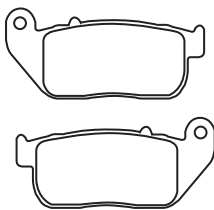

MATERIAL AVAILABILITY												
FA	TT	V	R	HH	MXS	SXR	EPFA	GPFAX	SFA	SFAC	SFAHH	
✓		✓		✓			✓					
HARLEY DAVIDSON												
XL 883 L Superlow												
XL 50 50th Anniversary Sportster				07	F							
XL 883 Sportster STD				04-08	F							
XL 883C Sportster Custom				04-10	F							
XL 883 L (883 Low)				04-10	F							
XL 883 R Sportster R				05-13	F							
XL 883 R Roadster				10-13	F							
XL 883 N Iron				09-13	F							
XL 1200 C Sportster Custom				04-13	F							
XL 1200 C Custom				11-13	F							
XL 1200 R Sportster Roadster				04-08	F							
XL 1200 L Sportster Low				07-11	F							
XL 1200 N Nightster (Spoke Wheel)				08-12	F							
XL 1200 X Sportster Forty-Eight)				10-13	F							
XL 1200 V Seventy Two				12-13	F							

BUYERS GUIDE

DO NOT REFIT ANY SHIMS/INSULATORS TO EBC PADS FROM ORIGINAL PADS UNLESS INSTRUCTED ON NOTE ON PAD PACKAGING AND ON FA DRAWING ASSOCIATED WITH THAT PAD.

FA382 A. 85 x 42.5 x 7.5mm B. 56 x 35 x 9.5mm



MATERIAL AVAILABILITY											
FA	TT	V	R	HH	MXS	SXR	EPFA	GPFA	SFA	SFAC	SFAHH
✓											

APRILIA				HONDA HM (Italy)				
MX 125			04-06	R	CRE 50 Six		01-02	R
Tuareg Rally 125			89-93	R	CRE 50 Six/Baja/Derapae		95-02	R
Tuareg Rally 125 (L/M)			90-91	R	CRE 50 Six/Baja/Derapage			
RX 125			92-01	R	Grimeca caliper		95-02	F&R
Pegaso 125			91	R	SACHS			
Pegaso 125 KAT			94-95	R	XTC 125 Supersport		00-07	R
Pegaso 600			91	R	XTC 125 N		00-07	R
Tuareg Wind 600			89	R	X Road 125		06-07	R
FANTIC					Roadster 650		01-04	R
Caballero 50 Regularita Casa			06-09	R	YAMAHA			
Caballero 50 Supersei Motard			06-09	R	DT 50 R-L (SM-5VB1/VG55BK)		02-03	F
Caballero 125 Regularita Casa			07-08	R				
Caballero 125 Supersei Motard			07-09	R				

SFA384 A 99 x 42.5 x 9mm B 77 x 41 x 9mm

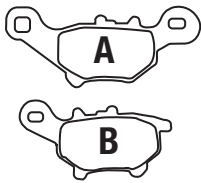

MATERIAL AVAILABILITY											
FA	TT	V	R	HH	MXS	SXR	EPFA	GPFA	SFA	SFAC	SFAHH
									✓		

YAMAHA				AEON				
CV 50 A/R Jog (5SU1/2/SA16J)			03-08	F	CO IN Eco (Electric)		13	F
					CO IN 125 (4T)		13	F

FA387 87 x 50 x 10.5mm

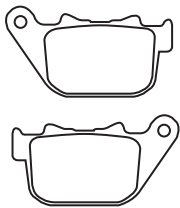

MATERIAL AVAILABILITY											
FA	TT	V	R	HH	MXS	SXR	EPFA	GPFA	SFA	SFAC	SFAHH
✓		✓		✓			✓				

HARLEY DAVIDSON				XL 1200 C Sportster Custom				
XL 50 50th Anniversary Sportster			07	R	XL 1200 C Custom		11-13	R
XL 883 Sportster STD			04-08	R	XL 1200 R Sportster Roadster		04-08	R
XL 883C Sportster Custom			04-10	R	XL 1200 L Sportster Low		07-11	R
XL 883 L (883 Low)			04-10	R	XL 1200 N Nightster (spoke wheel)		08-12	R
XL 883 R Sportster R			05-13	R	XL 1200 V Seventy Two		12-13	R
XL 883 R Roadster			10-13	R	XL 1200 X Sportster - Forty-Eight		10-13	R
XL 883 N Iron			09-13	R	XR 1200		08-10	R
XL 883 L Superlow			11-13	R	XR 1200 X		10-12	R

FA388 118 x 47 x 8.5mm FA388/2 118 x 47 x 10.5mm

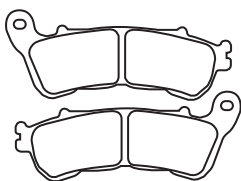

MATERIAL AVAILABILITY - FA388											
FA	TT	V	R	HH	MXS	SXR	EPFA	GPFA	SFA	SFAC	SFAHH
✓				✓			✓		✓	✓	✓

MATERIAL AVAILABILITY - FA388/2											
FA	TT	V	R	HH	MXS	SXR	EPFA	GPFA	SFA	SFAC	SFAHH
				✓							

HONDA				(ABS Model)				
FES 125 A7/A9/AA S-Wing	07-15	F	SH 300i R8/R9/RA (Non ABS)	08-10	F	XL 700 VA8/VA9/VAA (Transalp/3 piston front caliper/ABS front & rear wheels)	08-11	F
FES 125 7/9/A S-Wing (Non ABS Model)	07-13	F	SH 300i AR8/AR9/ARA (ABS Model)	08-10	F	VT 750 CS2A Shadow (3 piston caliper/rear disc/17" front wheel)	10-12	F
SH 125i 9/A/B Fuel Injection	09-12	F	SH 300i ABS	14	F	VT 750 C Shadow Aero	18-20	F
SH 125i RA (Fuel injection/rear disc model)	10-14	F	SW-T 400 (FJS 400 D9)	09	F	VT 750 C Shadow Aero ABS	18-20	F
SH 125i (3 Piston Caliper/ABS)	14-16	F	SW-T 400 (FJS 400 A9/AB ABS Model)	09-16	F	VFR 800 6/8/9	06-09	F
FES 150 7/9/A S-Wing	07-13	F	CBF 600 NA8/NA9/NAA (ABS)	08-11	F	VFR 800 A6/A8/A9	06-13	F
FES 150 A7/A9/A (S-Wing) ABS Model	07-13	F	CBF 600 SA8/SA9/SAA (ABS)	08-12	F	VFR 800 XB/XC/XD (Crossrunner/ABS)	11-13	F
SH 150i 9/A/B Fuel Injection	09-12	F	CBF 600 FA7/FA8/FA9/FAA/FAB	07-13	F	CB 1000 RA9/RAA/RAB/RAC/RAD/RAE/RAF/RAG (ABS Model)	09-16	F
SH 150 RA Fuel Injection (Rear disc)	10-14	F	CBF 600 SA8/SA9/SAA (ABS)	08-12	F	CBF 1000 A6/A7/A8/A9/AA (ABS)	06-10	F&R
SH 150i (3 Piston Caliper/ABS)	14-21	F	CBF 600 FAB/FAC (ABS Model)	11-13	F	CBF 1000 FA (FAA/FAB) (3 piston front caliper/ABS)	10-13	F&R
CBR 250 RAB/RAC (ABS)	11-13	F	SW-T 600 (FJS 600 AB) (ABS Model)	11-16	F	CBF 1000 A (A6/A7/A8/A9/AA)	06-10	F&R
CB 250 Twister	16-19	F	(NC 700 DC) 700 Integra Scooter	12-14	F	CBF 1000 S (S7/S8/S9/SA)	07-11	F&R
NSS 250 EX5/EX7/EX8 (ABS) Forza EX	05-08	F	DN-01 (680cc) NSA 700 A8/A9	08-11	F	CBF 1000 T (T7/T8/T9/TA) GT	07-16	F&R
NSS 250 AX5/AX6/A7 (ABS) Forza Z	05-07	F	NC 700 XA (ABS/DCT)	12-13	F	XL 1000 VA4-VA9/VAA/VAB Varadero		
NSS 250 X5/X7/X8 Forza	05-08	F	NC 700 XD (ABS/DCT)	12-14	F	- ABS Model	04-11	F
PS 250 5/6 Big Ruckus	05-06	F	NC 700 SA (ABS)	12-13	F			
NSS 300 AD Forza (ABS)	13-17	F	NC 700 SD (ABS/DCT)	12-14	F			
NSS 300 D Forza (NON ABS)	13-15	F	NT 700 V6/VA6/VA7/V7/V8/VA8/VA	06-13	F			
SH 300i 7/8/9/A/B (Non ABS)	07-12	F	/VAA Deauville					
SH 300i A7/A8/A9/AA/AB/AC								

BRAKE PAD BUYERS GUIDE

DO NOT REFIT ANY SHIMS/INSULATORS TO EBC PADS FROM ORIGINAL PADS UNLESS INSTRUCTED ON NOTE ON PAD PACKAGING AND ON FA DRAWING ASSOCIATED WITH THAT PAD.

FA388 118 x 47 x 8.5mm

FA388/2 118 x 47 x 10.5mm

XL 1000 V7/V8/V9/VA/VB Varadero			ST 1300 8/9 Pan European (Non ABS)	08-09	F	C 1800 R Intruder)	08-13	F
Non ABS Model	07-11	F	ST 1300 A8/A9/AA-AE Pan European			C 1800 RT VLR 1800 K8RT/K9RT		
CB 1100 AD	13	F	- ABS Model	08-17	F	C 1800 RT Touring Intruder	08-10	F
VFR 1200 Crosstourer Highlander			VT 1300 CTA Interstate	15	F			
-T/DCT	15-16	F	VT 1300 CXAA "Chopper"					
VFR 1200 XAC/XAD/XAE/XAF/XAH/ XAJ Crosstourer (Manual G/Box)	12-18	F	(9 spoke cast wheel/ABS model)	10-11	F	FA388/2HH		
VFR 1200 XDC/XDCD/XDE/XDF/XDG /XDH/XDJ DCT Crosstourer	12-18	F	F6B Goldwing (GLF6BAE)	13-15	F	HONDA		
VFR 1200 XDC-DCT Crosstourer			SUZUKI			GL 1800 B Goldwing J (Manual)	18	R
Highlander	13-14	F	UH 125 K7/K8/K9/L0/L1/L3 Burgman	07-13	F	GL 1800 Goldwing Tour J (Manual)	18	R
CB 1300 SA ABS	10-11	F	UX 125 K8/K9/L0/L1 SIXteen	08-14	F	GL 1800 BD Goldwing J (DCT)	18	R
CTX 1300 AE	14-17	F	UX 150 K8/K9/L0/L1 SIXteen	08-14	F	GL 1800 D Goldwing Tour J (DCT)	18	R
			UH 200 K7/K8/K9/L0/L1/L3 Burgman	07-13	F	GL 1800 DA Goldwing Tour Airbag J (DCT)	18	R
			C 1800 R (VLR 1800 K8/K9/L0/L1)					

FA390 75 x 48 x 8mm



MATERIAL AVAILABILITY											
FA	TT	V	R	HH	MXS	SXR	EPFA	GPFA	SFA	SFAC	SFAHH
				✓			✓	✓			

HONDA											
CBR 600 RR5-RR9/RAA/RRB/RRC/											
RRD/RRE/RRF/RRG (Radial Caliper)	05-16	F									F
CBR 600 RA9/RAA/RAB/RAC/RAD											F
/RAG (C-ABS)	09-16	F									F
CBR 600 RR Hannspree	08	F									F
VFR 800 F ABS	14-18	F									F
VFR 800 XF/XG/XH (Crossrunner/ABS)	15-17	F									F
HONDA											
CBR 1000 RR4-RR9/RRA/RRB/RRC/RRD											
/RRE/RRF/RRG Fireblade Non ABS	04-16	F									
CBR 1000 RA9/RAA/RAB/RAC/RAD											
/RAE/RAF/RAG (C-ABS) Fireblade	09-16	F									F
CB 1000 R9/RA/RB/RC/RD/RE/RF											
Non ABS Model	09-15	F									F
CB 1100 RS	17	F									F
YAMAHA											
YZF-R1 M1 Mission	20	F									F

SFA393 77 x 42 x 9.5mm



MATERIAL AVAILABILITY											
FA	TT	V	R	HH	MXS	SXR	EPFA	GPFA	SFA	SFAC	SFAHH
									✓	✓	

MBK											
NXC 125 Flame X (240mm H disc O/D)	07-12	F									
YP 125 Flame X	04-10	F									F
YAMAHA											
NXC 125-Cygnus X											
- 220mm Disc (5ML)											04-06
NXC 125-Cygnus X											
- 240mm Disc (4P9)											07-13

FA395 95 x 48 x 7mm



MATERIAL AVAILABILITY											
FA	TT	V	R	HH	MXS	SXR	EPFA	GPFA	SFA	SFAC	SFAHH
	✓		✓			✓					

ARCTIC CAT		XC 450i		650 H1 4X4 Auto Utility		05/08		F&R	
250 (2x4) (Utility)	05-09	F&R	500 4x4 Auto TRV Multirider	05-06/08	F&R	650 H1 4x4 Auto TBX Utility	07	F&R	
250 (4x4) (Utility)	05/08	F&R	500 4x4 Auto TBX/LE Utility	05-06	F&R	650 H1 4x4 Auto LE Utility	07	F&R	
300 (2x4) (Utility)	05	F&R	500 4x4 Auto Utility	05-08	F&R	650 H1 4x4 SE Utility	06	F&R	
300 ATV	10-12	F&R	500 4x4 Utility (Manual G/box)	05-09	F&R	650 H1 4x4 Auto Utility	07	F&R	
350 ATV	12	F&R	500 Alterra	16-20	F&R	650 H1 4x4 Auto TRV Plus Multirider	07	F&R	
366 4x4 Auto Utility	08-09	F&R	500 ATV (Midsized)	13-14	F&R	650 H1 4x4 TRV Plus LE Multirider	07	F&R	
366 SE	10	F&R	500 ATV XT (Midsized)	13-14	F&R	650 H1 4x4 Auto TRV	08	F&R	
400 4x4 Auto Utility	05-08	F&R	500 TRV (Core/2 Up)	13-14	F&R	650 H1 TRV	09	F&R	
400 4x4 Auto VP Utility	05-06	F&R	550 Alterra TRV and XT	16-20	F&R	650 H1	10	F&R	
400 4x4 Auto LE Utility	05-07	F&R	550 GT TRV	11-12	F&R	650 H1 Mudpro	10-11	F&R	
400 4x4 Auto TBX Utility	05-06	F&R	550 H1 EFI	09-10	F&R	650 V2 4x4 LE TS Utility	06	F&R	
400 4x4 VP Utility	05-06	F&R	550 H1 EFI LE	09-10	F&R	650 V2 4x4 Auto LE Utility	04-05	F&R	
400 4x4 Utility	05-07	F&R	550i	11-12	F&R	650 V2 4x4 Auto Utility	04-06	F&R	
400 4x4 Auto TRV Multirider	06	F&R	550i GT	11-12	F&R	TBX 650	09	F&R	
400 4x4 Auto TRV Plus Multirider	07	F&R	550i GT TRV	11	F&R	700 Alterra inc XT and Mudpro	16-20	F&R	
400 Alterra	16-20	F&R	550i LTD	11-12	F&R	700 Alterra TBX/VLX	17-20	F&R	
400 ATV (Core Mid Size)	13-14	F&R	550i TRV Cruiser	11	F&R	700 XR LTD and XT	15-20	F&R	
400 TRV	09/13	F&R	550 S	10	F&R	700 ATV/Core	13-14	F&R	
400 TRV H1	10	F&R	550 S Ltd	10	F&R	700 ATV Diesel	12-14	F&R	
425i	12	F&R	550 TRV EFI	09-10	F&R	700 ATV Ltd	12-14	F&R	
425i SE	12	F&R	550 TRV Hi EFI LE	09-10	F&R	700 ATV XT	13-14	F&R	
450 Alterra	2016	F&R	550 TRV S GT	10	F&R	700 EFI 4x4 Auto Utility	07-08	F&R	
450 H1 EFI	10	F&R	550 TRV	11	F&R	700 EFI 4x4 Auto LE Utility	07	F&R	
450 TRV	11-12	F&R	550 TRV Cruiser	11	F&R	700 EFI 4x4 SE Utility	06	F&R	
450i	11-12	F&R	550 TRV Ltd (2 Up)	13-14	F&R	700 EFI 4x4 Auto M4	08	F&R	
450i GT	12	F&R	550 ATV (Mid Size)	13-14	F&R	700 H1 EFI 4x4 Auto SE	08-09	F&R	
450i TRV	11	F&R	550 ATV Ltd (Mid Size)	13-14	F&R	700 H1 EFI Mudpro	09-11	F&R	
450i XC	13-17	F&R	550 ATV XT (Mid Size)	13-14	F&R	700 H1 EFI/EFI LE	09-10	F&R	
450 ATV (Core/Midsized)	13-14	F&R	570 Alterra EPS and XT	19-20	F&R	700i	11-12	F&R	

FA395 95 x 48 x 7mm

700i GT	11-12	F&R	1000 TRV H2 EFI Cruiser 2 Up	09-10	F&R	XTX 700 Hi EFI Prowler	09	F&R
700i Ltd/Mudpro	11-12	F&R	1000 TRV H2 EFI	10	F&R	XTX 700	10-11	F&R
700 EFI Cruiser	08	F&R	1000 TRV Cruiser	11	F&R	XTX 700i Prowler	11-17	F&R
700 EFI 4x4 Auto TRV LE	08	F&R	1000 XT	13-14	F&R	Wildcat Trail 700 XT inc LTD	15-20	F&R
700 Diesel Utility	07-08	F&R	KYMGCO			Wildcat 1000i GTI	12	F&R
700 Mudpro	10-11	F&R	Maxxer 400	09-10	F&R	Wildcat 1000 4X	14-16	R
700 Mudpro i Ltd	11	F&R	MXU 400 (A40000)	08-11	F&R	Wildcat 1000/1000 Ltd	13-14	F&R
700 S	10	F&R	Maxxer 450i (4T)	10-15	F&R	Wildcat 1000 X	14	F&R
700 S Ltd	10	F&R	MXU 450 i IRS	11-12	F&R	Wildcat 1000 4 LTD	14	R
700 TBX H1 EFI	10	F&R	MXU 450 i IRS	12-18	F&R	Wildcat 1000 4	13-16	R
700 TRV	11	F&R	MXU 450 i LE 7 LE Prime	20-21	F&R	XTZ 1000 H2 EFI Prowler	09	F&R
700 TRV GT	11	F&R	ARCTIC CAT SIDE X SIDE			XTZ 1000	10-14	F&R
700 TRV H1 EFI Cruiser	09-10	F&R	Prowler 500 HDX LTD	14	F&R	MASSEY FERGUSON		
700 TRV Cruiser	11	F&R	Prowler 500 HDX XT	14-20	F&R	MF 400/4WD Auto (386cc)	05-09	F&R
700 TRV XT	13-14	F&R	Prowler 500 HDX	14	F&R	MF 500/4WD Auto (493cc)	05-09	F&R
700 Super Duty Diesel	10-11	F&R	550 H1 EFI Prowler	09	F&R	MF 650 2 cyl/4WD Auto (633cc)	05-09	F&R
700 TBX Ltd	11	F&R	XT 550	10-11	F&R	MF 650/4WD Auto (641cc)	05-09	F&R
1000 Alterra TRV, XT and EPS	17-20	F&R	XT 550i Prowler	11-15	F&R	MF 700 D/4WD Auto (686cc Diesel)	05-08	F&R
1000 GT	11-12	F&R	XT 650 H1 Prowler	06-09	F&R	PIAGGIO		
Thundercat 1000 H2	08-10	F&R	650 H1 Prowler	07	F&R	Trackmaster 400 Quad	06	F&R
Thundercat 1000 H2 LE	10	F&R	650 Prowler 4x4 Auto/M4	08	F&R	POLARIS		
1000 Mudpro H2 EFI	11-12	F&R	HDX 700i Prowler	11-14	F&R	300 Hawkeye 2x4/4x4	06	F&R
1000 Mudpro LTD	13-14	F&R	Prowler 700 HDX LTD	14	F&R			
1000 Mudpro SE EPS	16-20	F&R	XTX 700 Hi LE Prowler	08	F&R			

SFA396 A. 99 x 44 x 7.5mm B. 75.5 x 38 x 8.5mm



MATERIAL AVAILABILITY												
FA	TT	V	R	HH	MXS	SXR	EPFA	GPFA	SFA	SFAC	SFAHH	
✓									✓			✓

KAWASAKI												
SC 150 A1 (Epsilon 150)	02-03	F							UG 110 W/SW/Y/SY/SK1 Hokuto/Address	98-02		F
SUZUKI									UG 110 L5/L6/L7/L8 Address	15-16		F
AZ 50 RY/RK2 (ZZ Inch Up Sport)	00-02	F							AN 125 S/T/V/W/XX	95-00		F
TR 50 SW/SX	98-00	F							UC 125 X/Y 'Epicuro'	99-02		F
									UZ 125 K5/GK5 (CF46A) (V126G)	05		F

FA398 95.5 x 39.5 x 7mm



MATERIAL AVAILABILITY												
FA	TT	V	R	HH	MXS	SXR	EPFA	GPFA	SFA	SFAC	SFAHH	
			✓									

JOHN DEERE									CAN AM			
Gator HPX All models	04-05	F&R							DS 450 (2x4/EFI)	08-15		R
HPX 4x4 Gator (Petrol)	10-11	F&R							DS 450 X (2x4/EFI)	08-09		R
HPX 4x4 Gator (Petrol) Parking brake	10-11	F&R							DS 450 XXC/XXM	10-15		R
HPX 4x4/4x4 Trail Gator (Petrol)	10-11	F&R										
HPX 4x4 Gator (Diesel)	10	F&R										

FA399 69.5 x 51.5 x 7mm

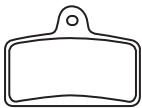

MATERIAL AVAILABILITY												
FA	TT	V	R	HH	MXS	SXR	EPFA	GPFA	SFA	SFAC	SFAHH	
✓												

APRILIA									GILERA			
RS4 50 (4T) (AJP Caliper)	11-14	F							SC 125	06-07		F
RS4 125 (4T) (AJP Caliper)	11-20	F							METRAKIT			
RS 125 (4T)	17-18	F							Pre GP 125	09		F
RS 125 (4T) GP Replica	18-20	F							MH/MOTORHISPANIA			
Tuono 125	17-20	F							KN2 50	12-13		F
BLATA									RX 50 R	08-14		F
Enduro 125	07-08	F							125 LC Hard Road SM	12		F
Motard 125	07-08	F							KN1 (125cc) AC/LC	09-14		F
CONTI									KN2 (125/4T)	12-14		F
RX 356 V3 (12" wheels)	05-06	F							RX 125 R	08-14		F
RX 356 V3 (17" wheels)	05-06	F							MH7 Naked (125cc/Air Cooled)	08-14		F
DERBI									MH7 Naked (125cc/Liquid Cooled)	08-14		F
GPR 50 (2T) 41mm forks/ 218mm rear disc	09-12	F							PEUGEOT			
GP1 125cc Racing Low seat/ radial caliper/6 bolt disc fixing	07-09	F							XR7 (50cc)	08-12		F
GPR 125 Racing (Radial caliper)	04-07	F							NK7 "Naked" 50cc	09-12		F
GPR 125 Nude (Radial caliper)	04-08	F							RIEJU			
GPR 125 (4T) 4V	09-14	F							RS3 NKD 50	12-14		F
GP1 250i cc Racing Low seat /radial caliper/6 bolt disc fixing	07-09	F							RS3 NKD 125	12-14		F

FA400 A 97.5 x 64 x 8mm

B 97.5 x 64 x 8mm

HH = 7.5mm thickness

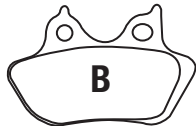

MATERIAL AVAILABILITY

FA	TT	V	R	HH	MXS	SXR	EPFA	GPFA	SFA	SFAC	SFAHH
✓		✓		✓			✓				

HARLEY DAVIDSON											
XLH883 Sportster	00-03	F&R	FXDCi Superglide Custom (Cast wheel)	06	F&R						
XLH883r Sportster Flat Track	00-03	F&R	FXST/FXSTi Softail Standard	00-05	F&R						
XL883 Sportster Hugger	00-03	F&R	FXSTB/FXSTBi Night Train	00-05	F&R						
XL53c Sportster Custom (883cc)	00-03	F&R	FXSTD/FXSTD Softail Deuce/i	00-07	F&R						
XL883 R 100th Anniversary Edition	03	F&R	FLSTF/FLSTFi Fat Boy	00-06	F&R						
XL1200c Sportster Custom	00-03	F&R	FLSTFi Fat Boy 15th Anniversary Edition	05	F&R						
XL1200s Sportster Sport	00-03	F&R	FLSTF/FLSTFi Fat Boy	07	F&R						
FXD Super Glide	00-03	F&R	FLSTCi/FLSTC Heritage Classic/i	00-07	F&R						
FXDX Super Glide Sport	00-03	F&R	FLSTN/FLSTNi Softail Deluxe	05-07	F&R						
FXDL Low Rider	00-03	F&R	FLST/FLSTi Heritage Softail	06	F&R						
FXDWG Wide Glide	00-03	F&R	FXST/FXSTi Softail Standard	06-07	F&R						
FXDS-CON Dyna Convertible	00-02	F&R	FXSTB/FXSTBi Night Train Softail	06-07	F&R						
FXDXT Superglide T-Sport	01-03	F&R	FXSTC Softail Custom	07	F&R						
FXDi Super Glide 1450	04-05	F&R	FLSTC Heritage Softail Classic	07	F&R						
FXDi 35 35th Anniversary Super Glide (Spoke wheels)	06	F&R	FLHRCi Road King Classic	00-07	F&R						
FXDXi Super Glide Sport	04-05	F&R	FLHT/FLHTi Electra Glide Standard	00-07	F&R						
FXDLi Low Rider 1450	04-05	F&R	FLTR/FLTR-i Road Glide	00-07	F&R						
FXDLi Dyna Low Rider (Spoke wheels)	06	F&R	FLHTCU-i Electra Glide Ultra Classic	00-07	F&R						
FXDWGi Wide Glide 1450	04-05	F&R	FLHRS/FLHRSi Road King Custom	04-07	F&R						
FXDWGi Dyna Wide Glide (Spoke wheels)	06-07	F&R	FLHTC/FLHTCi Electra Glide Classic	04-07	F&R						
FXDC/FXDCi Super Glide Custom	05	F&R	FLHX/FLHXi Street Glide	06-07	F&R						
FXDCi Dyna Superglide Custom (Spoke wheels)	06-07	F&R	V-Rod (Hayes Caliper)	02-05	F&R						
FXDBi Street Bob (Spoke wheels)	06-07	F&R	XLH883 Sportster	00-03	F&R						
FXDi Super Glide (Cast wheel)	06-07	F&R	XLH883r Sportster Flat Track	00-03	F&R						
FXDLi Low Rider (Cast wheel)	06-07	F&R	XL883 Sportster Hugger	00-03	F&R						
FXDLi Low Rider (Spoke wheel)	06-07	F&R	XL53c Sportster Custom (883cc)	00-03	F&R						
			XL883 R 100th Anniversary Edition	03	F&R						
			XL1200c Sportster Custom	00-03	F&R						
			XL1200s Sportster Sport	00-03	F&R						

FA401 A 99 x 40 x 7.5mm

B 75.5 x 38 x 8mm



MATERIAL AVAILABILITY

FA	TT	V	R	HH	MXS	SXR	EPFA	GPFA	SFA	SFAC	SFAHH
	✓		✓								

SUZUKI											
RM 85 K5/K6/K7/K8/K9/L0/L2/L5/L6/L7 (Small Wheel F 17 Inch/R 14 Inch)	05-21	R	RM 85 LK5/LK6/LK7/LK8/LK9/LL0/LL2/LL5/LL6/LL7 (Big Wheel F 19 Inch R 16 Inch)	05-21	R						

FA403 41 x 45 x 6.5mm



MATERIAL AVAILABILITY

FA	TT	V	R	HH	MXS	SXR	EPFA	GPFA	SFA	SFAC	SFAHH
✓											

BETA											
EVO 80 Senior	09-20	R	REV 3 125/200	06-08	R						
REV 80	08	R	REV 3 250/270	05-08	R						
			REV 4T 250	07-08	R						

FA405 76 x 45 x 6.5mm



MATERIAL AVAILABILITY

FA	TT	V	R	HH	MXS	SXR	EPFA	GPFA	SFA	SFAC	SFAHH
					✓		✓				

APRILIA											
SXV 450/550 Supermotard	06-13	F	FS 550 E Supermoto	05-07	F						
Pegaso 650 Factory	06-08	F	FS 650 C	06-08	F						
			FS 650 E Supermoto	05-08	F						
BEHRINGER											
4 Piston (Radial)			SMR 450	05-06	F						
FTE											
4 Piston Radial Supermoto			SMR 525	05							
			SMR 650 Supermoto	06	F						
HUSABERG											
FS 450 C	06	F									
FS 450 E	06-08	F									

FA406 102 x 48 x 8mm



MATERIAL AVAILABILITY

FA	TT	V	R	HH	MXS	SXR	EPFA	GPFA	SFA	SFAC	SFAHH
					✓		✓				

BEHRINGER											
6 Piston (New Design)			SMR 450/525	04	F						
FTE											
6 Piston Radial Supermoto											
HUSABERG											
FS Supermotard Models	04-	F									

BRAKE PAD BUYERS GUIDE

DO NOT REFIT ANY SHIMS/INSULATORS TO EBC PADS FROM ORIGINAL PADS UNLESS INSTRUCTED ON NOTE ON PAD PACKAGING AND ON FA DRAWING ASSOCIATED WITH THAT PAD.

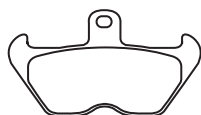
FA407 100 x 57 x 8.5mm

MATERIAL AVAILABILITY												
FA	TT	V	R	HH	MXS	SXR	EPFA	GPFX	SFA	SFAC	SFAHH	
✓				✓			✓					
BMW												
K 100 RS				89-92	F	R 850 R				94-02	F	F
K1				88-93	F	R 100 Mystic				96-01	F	F
K 1100 LT				89-07/93	F	R 100 R				91-95	F	F
KL 1100 LT				89-99	F	R 1100 GS				93-99	F	F
K 1100 RS				92-96	F	R 1100 R				93-01	F	F
K 1200 RS				96-00	F	R 1100 RS				92-01	F	F
K 1200 LT				97-10/00	F	R 1100 S				96-11/00	F	F
R 80 Mystic				94-95	F	R 1100 RT				94-01	F	F
R 80 R				91-94	F	R 1150 GS (R21/0415/0495)				98-10/01	F	F
R 850 C				97-00	F	R 1200				00-02	F	F
R 850 GS				96-00	F	R 1200 C				96-02	F	F

SFA408 100 x 38.5 x 12mm

MATERIAL AVAILABILITY												
FA	TT	V	R	HH	MXS	SXR	EPFA	GPFX	SFA	SFAC	SFAHH	
									✓	✓	✓	
YAMAHA												
CP 250 (1B71) Maxam/Morphus				05-06	R	XP 500 T-Max Non ABS Models				08-11	R	R
YP 400 Majesty (Non ABS)				04-13	R	XP 500 T-Max (ABS Models)				08-11	R	R
YP 400 Majesty (ABS)				07-13	R	MBK						
XP 500 T-Max (5VU1/2/4BS)				04-07	R	YP 400 Skyliner				04	R	R

FA409 92 x 56 x 7mm

MATERIAL AVAILABILITY												
FA	TT	V	R	HH	MXS	SXR	EPFA	GPFX	SFA	SFAC	SFAHH	
✓		✓		✓								
VRSCA/VRSCB												
V-Rod				06	F&R	FLHTCUL Electra Glide Ultra Classic LOW				15	F&R	F&R
VRSCR Street Rod				06-07	F&R	FLHT Electra Glide Standard				08-10	F&R	F&R
VRSCD Night Rod (Cast Wheel)				06-08	F&R	FLHTK Electra Glide Ultra Ltd				10-20	F&R	F&R
VRSCAW V-Rod				07-10	F&R	FLHTK Ultra LTD				15-20	F&R	F&R
VRSCDX Night Rod Special (Cast wheel)				07-17	F&R	FLHTKL Ultra LTD LOW				15-20	F&R	F&R
VRSCX VRod				07	F&R	FLTRX Road Glide Custom				10-13	F&R	F&R
VRSCF V-Rod Muscle				09-17	F&R	FLTRX Road Glide				15-20	F&R	F&R
VRSC Night Rod Special					F&R	FLTRXS Road Glide Special				15-17	F&R	F&R
VRSC 10th Anniversary V-Rod				12	F&R	FLHX Street Glide				08-20	F&R	F&R
FLHR/FLHRCI						FLHXS Street Glide Special				14-20	F&R	F&R
FLHR Road King				08-12	F&R	FLHTCUTG Tri Glide Ultra Classic Trike				09-13	F	F
FLHRC Road King Classic				08-20	F&R	FLTRU Road Glide Ultra				11-12	F&R	F&R
FLTR Road Glide				08-09	F&R	FLHXXX Street Glide Trike				10-11	F	F
FLHTC Electra Glide Classic				08-11	F&R	FLHR Road King (Cast Wheel Type)				15-20	F&R	F&R
FLHTCU Ultra Classic Electra Glide				08-20	F&R	FLTRU Road Glide Ultra				16-20	F&R	F&R

FA410 82 x 38.5 x 11mm

MATERIAL AVAILABILITY												
FA	TT	V	R	HH	MXS	SXR	EPFA	GPFX	SFA	SFAC	SFAHH	
	✓		✓									
HONDA												
TRX 500 FA5-FA9/FAA/FAB				05-11	F	Fourtrax Foreman Power Steering				08-11	F	F
TRX 500 FE5-FE9/FEA/FEB F						TRX 500 TM5/TM6 Fourtrax Foreman				05-06	F	F
ourtrax Foreman 4WD ES				05-11	F	TRX 680 FGA6-FGA9/FA6/7/8/9						
TRX 500 FM5-FM9/FMA/FMB						Fourtrack Rincon				06-09	F	F
Fourtrax Foreman 4WD				05-11	F	TRX 680 FA6-FA9/FAA/FAB/FAC						
TRX 500 FPE8/FPE9/FPEA						Rincon 4x4 Auto				06-21	F	F
						TRX 700 XX8/XX9/XXB				08-11	R	R

SFA411 81 x 42 x 8mm

MATERIAL AVAILABILITY												
FA	TT	V	R	HH	MXS	SXR	EPFA	GPFX	SFA	SFAC	SFAHH	
									✓	✓	✓	
SUZUKI												
AN 250 K1/K2 Burgman				01-02	R	AN 400 K1-K6 Burgman/Skywave				01-06	R	R

SFA412 88 x 41 x 8.5mm

MATERIAL AVAILABILITY												
FA	TT	V	R	HH	MXS	SXR	EPFA	GPFX	SFA	SFAC	SFAHH	
									✓	✓	✓	
SUZUKI												
AN 250 Skywave Type M (BA-CJ4SA)				07-08	R	AN 400 AK9/ZAK9/ALO/ZALO/AL1-AL8/				09-20	R	R
AN 250 Skywave/Type S (BA-CJ44A)				07-08	R	ZAL1-ZAL8 Skywave/Burgman/ABS				04-11	R	R
AN 250 8 Skywave SS (CJ46A)				08	R	AN 650 K3-K9/LO Burgman/Non ABS				13-18	R	R
AN 400 K7-K9/ZK7/ZK8/LO/L1-L4						AN 650 ZL3-ZL8 Burgman ABS Executive				13-16	R	R
Burgman/Non ABS/Skywave				07-15	R	AN 650 L3-L6 Burgman Non ABS				04-12	R	R
						AN 650 AK4-AK9/ALO Burgman/ABS						

FA413 A 82 x 41 x 8mm
B 62 x 41 x 8.5mm



MATERIAL AVAILABILITY												
FA	TT	V	R	HH	MXS	SXR	EPFA	GPFA	SFA	SFAC	SFAHH	
	✓		✓						✓	✓	✓	
BENELLI												
Caffe Nero 250				08-14	R		LT-A 450 XK7-XK9 King Quad					07-10 F(left)
							LT-A 500 XPK9/XPZK9/XPLO-XPL5					
SUZUKI												
UH 125 K7-K9/L0/L1-L6 Burgman				07-16	R		King Quad (Power Steering)					09-15 F(left)
UH 125 AL4-AL8 Burgman (ABS)				14-21	R		LT-A 700 XK5/XCK6/XK6/XK7					05-07 F(left)
UH 200 K7-K9/L0/L1-L6 Burgman				07-16	R		LT-A 750 XZK8/XK8/XK9/XZK9/L0					08-10 F(left)
UH 200 AL4-AL9 Burgman (ABS)				14-21	R		King Quad					
LT-A 400 FK8/FK9/FL0/FL1							LT-A 750 XPK9/XPZK9/XPLO-XPL5					
King Quad Auto 4WD				08-12	F(left)		King Quad Power Steering					09-15 F(left)
LT-F 400 FK8/FK9/FL0/FL1												
King Quad 4WD				08-12	F(left)							

FA414 A 82 x 41 x 8mm
B 62 x 41 x 8.5mm



MATERIAL AVAILABILITY												
FA	TT	V	R	HH	MXS	SXR	EPFA	GPFA	SFA	SFAC	SFAHH	
	✓		✓									
SUZUKI												
LT-A 400 FK8/FK9/FL0/FL1							LT-A 700 XK5/XCK6/XK6/XK7					05-07 F(right)
King Quad Auto 4WD				08-12	F(right)		King Quad					
LT-F 400 FK8/FK9/FL0/FL1							LT-A 750 XK8/XK9/XZK9/XL0					08-10 F(right)
King Quad 4WD				08-12	F(right)		King Quad					
LT-A 450 XK7/XK8/XK9 King Quad				07-10	F(right)		LT-A 750 XPK9/XPZK9/XPLO/XPL1/					09-12 F(right)
LT-A 500 XPLO/XPK9/XPZK9/							XZK8 King Quad (Power Steering)					
XPLO-XPL5 King Quad (Power steering)				09-15	F(right)							

SFA415 82 x 37 x 9mm



MATERIAL AVAILABILITY												
FA	TT	V	R	HH	MXS	SXR	EPFA	GPFA	SFA	SFAC	SFAHH	
									✓	✓	✓	
GENERIC/KSR												
Classic 125				17-18	R		NSS 300 AD Forza (ABS)					13-21 R
							NSS 300 D Forza (Non ABS)					13-15 R
HONDA												
FES 125 A7/A9/AA S-Wing				07-15	R		NSS 350 AM Forza (ABS)					21-22 R SH
FES 125 7/9/A S-Wing (Non ABS)				07-13	R		300i 7/8/9/A/B (Non ABS)					07-12 R
NSS 125 Forza (2 Piston Caliper)				15-18	R		SH 300i A7/A8/A9/AA/AB/AC (ABS)					07-13 R
SH 125i 9/A/B Fuel Injection				09-12	R		SH 300i R8/R9/RA (Non ABS)					08-10 R
SH 125i RA Fuel Injection							SH 300i AR8/AR9/ARA (ABS Model)					08-10 R
(Rear disc model)				10-14	R		SH 300i ABS					14 R
SH 125i (2 Piston Caliper/ABS)				14-21	R		SH 300i (2 Piston Caliper/ABS)					16-21 R
SH 125i (3 Piston Caliper/ABS)				14-21	R		SH 350i (2 Piston Caliper/ABS)					20-21 R
FES 150 7/9/A S-Wing				07-13	R		LEXMOTO					
FES 150 A7/A9/AA (S-Wing) ABS				07-13	R		Vendetta 250 LJ250-3V					19-21 R
SH 150i 9/A/B Fuel Injection				09-12	R		PEUGEOT					
SH 150 RA Fuel Injection (Rear disc)				10-14	R		Metropolis 400 RS					
SH 150i (2 Piston Caliper/ABS)				14-21	R		(3 Wheel Model/Nissin Caliper)					17-21 F
SH 150i (3 Piston Caliper/ABS)				14-21	R		Metropolis 400 RX-R					
NSS 250 EX5/EX7/EX8 Forza EX				05-08	R		(3 Wheel Model/Nissin Caliper)					17-21 F
NSS 250 AX5/AX6 (ABS) Forza Z				05-06	R		Metropolis 400 Allure					
NSS 250 X5/X7/X8 Forza				05-08	R		(3 Wheel Model/Nissin Caliper)					17-21 F

FA416 A. 85 x 37 x 8mm
B. 48 x 32 x 10mm



MATERIAL AVAILABILITY												
FA	TT	V	R	HH	MXS	SXR	EPFA	GPFA	SFA	SFAC	SFAHH	
	✓		✓						✓	✓		
ADLY												
Interceptor 300 Quad							MH10 125 Enduro					13-14 F
							MH10 125 SM					13 F
EXPLORER												
Ranger 300 2x4/4x4				08-09	F		PGO					
							BR 150 E Bugrider					04-07 F
HAMMERHEAD BUGGIES												
80T				08-09	R		Bugrider 150					F
150 Supersport ES 150 11 R				08-09	F		BR-200 Bugrider					07-12 F
							BR 250 Bugrider E					05-12 F
KAZUMA												
MF 90 Falcon						F&R	Bugrider 250 SS (Single seat)					F
							Bugrider 250					F
MH												
KN2 50				12-13	R		250 Bug					F
MH10 Eco Urban				14	F		Bugrider 50 (Buggie)					06 F
MH10 50 Enduro/Pro 50 Enduro				13-14	F		QUADZILLA					
MH10 50 SM/Pro 50 SM				13	F		RV 125 Midi RV Bug					F
MH10 Pro Urban 50				14	F		RV 150 Midi RV Buggie					F
RYZ 50 Enduro				13-14	F		BR 200					07-08 F
RYZ SM 50				13	F		BR 250					F
RYZ Pro SM 50				13	F		XRV 250 (Off road)					06-07 F
Duna 125/Pro 125				13-14	F		XRV 250 E					06-07 F
KN2 (125/4T)				12-14	R		XRV 250					F
125 LC Hard Road SM				12	R		RL 300 Buggie					07-08 F
							XL 300					F

DO NOT REFIT ANY SHIMS/INSULATORS TO EBC PADS FROM ORIGINAL PADS UNLESS INSTRUCTED ON NOTE ON PAD PACKAGING AND ON FA DRAWING ASSOCIATED WITH THAT PAD.

FA417/4 50 x 38 x 8mm

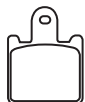

MATERIAL AVAILABILITY												
FA	TT	V	R	HH	MXS	SXR	EPFA	GPFAX	SFA	SFAC	SFAHH	
				✓			✓	✓				

KAWASAKI					
ZX6R (ZX 600 P7F/P8G/R9F/RAF/RBF/RCF/RDF/REF/RFF/RGF)	07-16	F			ZR 1400 (ZX 1400 A6F/A7F) ZR 1400 ABS (ZX 1400 B6F/B7F/
Z 750 R Non ABS (ZR750 NBF/NCF)	11-12	F			D8F/D9F/DAF/DBF/FCF/FDF/FEF/
Z 750 R ABS (ZR 750 PBF/PCF)	11-12	F			FFF/HGF/HHF/HJF)
Z 1000 (ZR 1000 B7F/B8F/B9F)	07-09	F			ZR 1400 Special Edition
Z 1000 ABS (ZR 1000 C7F/C8F/C9F)	07-09	F			(ZX 1400 FDFA/FEFA/FEFB/FFFA)
GTR 1400 (ZG 1400 A8F/A9F/CAF/CBF/CCF/CDF/CEF/EEF/EGF/EHF/EJF)	08-20	F			12-16

SFA418 A 97 x 39.5 x 9.5mm B 77 x 42 x 9.5mm

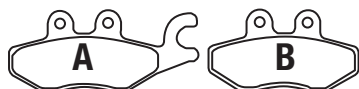

MATERIAL AVAILABILITY												
FA	TT	V	R	HH	MXS	SXR	EPFA	GPFAX	SFA	SFAC	SFAHH	
									✓	✓	✓	

PIAGGIO					
Beverly 125 (4T) (Multi spoke cast wheel)	11-14	R			Wheel/14" Rear Wheel)
Beverly S 125 ie	14-15	R			14-20
MP3 Hybrid (125cc) (14" rear wheel)	09-12	R			MP3 Touring 300 ie
MP3 125 ie (EFI Models)	08-11	R			11-12
125 ie MP3 Yourban	11-12	R			MP3 Touring LT 300 ie
Medley 125 (ABS)	16-20	R			11-12
Medley S 125 (ABS)	16-21	R			MP3 Yourban LT 300 ie
X7 125cc	08-09	R			11-16
X7 Evo 125 ie (EFI)	09-12	R			MP3 Yourban Sport 300 ie
X9 125 Evolution	05-07	F(right)			17-18
X10 125 ie (4V/4T/EFI) All models	12-10	F(right)&R			MP3 Yourban LT RL 300
Xevo 125	07-16	R			17-18
Medley 150 (ABS)	16-20	R			MP3 Sport LT 300 ie
Medley S 150 (ABS)	16-21	R			13
MP3 250 MIC/EFI (14" rear wheel)	08-09	R			MP3 Sport LT 300 ie ABS
MP3 250 LT (EFI) (14" rear wheel)	09	R			14-20
X7 250 ie	08-09	R			R (13" Front Wheel/14" Rear Wheel)
X9 250	05-06	F(right)			09-12
Xevo 250 ie	07-10	R			X7 300 Evo
Beverly 300 (278cc/4T) (5 spoke cast wheel)	10-15	R			Beverly 350 ie Sport Touring
Beverly S 300 ie	14-21	R			Non ABS (330cc/4T)
Beverly Police 300 ABS ASR (278cc)	16-18	R			11-15
300 ie MP3 Yourban	11-12	R			Beverly 350 ie ABS Sport Touring
MP3 300 LT ie	10	R			(330cc/4T)
MP3 300 ie (Hybrid)	11-15	R			11-15
MP3 300 ie (Hybrid LT)	11-12	R			Beverly 350 ie Sport Touring ABS
MP3 Business LT 300ie	13	R			(330cc/4T)
MP3 Business LT 300 ie ABS (13" Front					16-21
					R X10 ie 350 (4v/4t/efi)
					12-15
					F(right)&R
					11-12
					R
					400 ie (MP3 Touring)
					11-12
					R
					MP3 Touring 400 ie LT
					11-12
					R
					Xevo 400 ie
					07-10
					F(right)
					X8 400 ie
					06-08
					F(right)
					MP3 500 EFI
					09-10
					R
					X10 500ie (4V/4T/EFI) All models
					12-15
					F(right)&R
					08-18
					F
					GTS 300 ie (ABS)
					08-18
					F
					GTS 300 ie Super (ABS)
					08-18
					F
					GTS 300 ie Super Sport (ABS)
					08-18
					F
					GTS 300 ie Touring (ABS Models)
					11-21
					F
					GTS 300 HPE IE 4T/4V ABS E5
					20-21
					F
					GTV 300 Sei Giorni IE E4 ABS
					20-21
					F

FA419 A 89 x 40.5 x 9.5mm B 89 x 40.5 x 9.5mm



MATERIAL AVAILABILITY												
FA	TT	V	R	HH	MXS	SXR	EPFA	GPFAX	SFA	SFAC	SFAHH	
✓		✓		✓								

SUZUKI					
GSR 400 K6/K7/K8	06-08	R			GSXR 1000 K7/K8
GSR 600 K6/K7/K8	06-10	R			07-10
GSXR 600 K6/K7/K8/K9/L0	06-10	R			GSX 1300 RK8/RK9/RL0/RL1/RL2
GSXR 750 K6/K7/K8/K9/L0	06-10	R			Hayabusa
DL 1000 AL4-AL9 V-Strom (ABS)	14-20	R			08-12
DL 1000 XT XAL8/XAL9 V-Strom (ABS)	18-20	R			R
DL 1050 V-Strom (ABS)	14-21	R			GSX 1300 BKK8/BKK9/BKLO
DL 1050V-Strom XT (ABS)	18-21	R			08-12
DL 1050 V-Strom XT Tour (ABS)	18-21	R			/BKL1 B-King
					08-12
					R
					GSX 1300 RL3/RL4 Hayabusa
					(Brembo calipers)
					13-14
					R
					GSX 1300 RAL3-RAL8 Hayabusa
					(Brembo calipers)
					13-18
					R

FA420 69.5 x 54.5 x 8mm

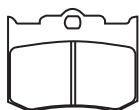

MATERIAL AVAILABILITY												
FA	TT	V	R	HH	MXS	SXR	EPFA	GPFAX	SFA	SFAC	SFAHH	
				✓								

PERFORMANCE MACHINE CALIPERS
137 X 4

BRAKE PAD BUYERS GUIDE

DO NOT REFIT ANY SHIMS/INSULATORS TO EBC PADS FROM ORIGINAL PADS UNLESS INSTRUCTED ON NOTE ON PAD PACKAGING AND ON FA DRAWING ASSOCIATED WITH THAT PAD.

DO NOT REFIT ANY SHIMS/INSULATORS TO EBC PADS FROM ORIGINAL PADS UNLESS INSTRUCTED ON NOTE ON PAD PACKAGING AND ON FA DRAWING ASSOCIATED WITH THAT PAD.

FA423/4 45 x 53.5 x 8.5mm



MATERIAL AVAILABILITY

FA	TT	V	R	HH	MXS	SXR	EPFA	GPFA	SFA	SFAC	SFAHH
				✓							

YAMAHA												
FJR 1300 A (ABS) (4 pad caliper)	06-20	F	XVS 1900 A (Midnight Star)	11-13	F							
FJR 1300 AE (Electronic Suspension Adjustment/USD Forks)	14-21	F	TRIUMPH Trophy 1215cc	12-16	F							
FJR 1300 AS (ABS/Electric Shift)	06-21	F	Trophy 1215cc SE	12-17	F							
XV 1900 ACFD Midnight Star/ Casual Full Dresser (With Handlebar Fairing)	13-16	F										

FA424 91.5 x 51.5 x 8.5mm

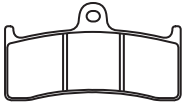

MATERIAL AVAILABILITY

FA	TT	V	R	HH	MXS	SXR	EPFA	GPFA	SFA	SFAC	SFAHH
✓				✓			✓				

HONDA												
CB 1300 FW/FX/FY (SC40)	98-00	F	MV 750 Brutale S F4	03-05	F							
KAWASAKI			750 Brutale Oro F4	03-05	F							
ZX-7RR (ZX750 N1/N2)	96-99	F	750 F4S (Mono Posto)	99-04	F							
YAMAHA			750 F4S 1+1 (Bi-Posto)	01-04	F							
YZF-R7 750 '0W02' (Race version)	99-01	F	750 F4 SPR	01-04	F							
BUELL			750 F4 SPR Senna	01-03	F							
X1 Lightning	98-05	F	910 Brutale S (Nissin Calipers)	06-08	F							
M2 Cyclone	98-05	F	1000 F4 AGO	05	F							
HHL (Hawg Halters)			1000 F4 S (Mono Posto)	04-06	F							
6 Piston - All types			1000 F4 S 1+1 (Bi Posto)	04-06	F							
			1000 F4 Tamburini	05	F							

SFA425 55.5 x 54.5 x 8mm



MATERIAL AVAILABILITY

FA	TT	V	R	HH	MXS	SXR	EPFA	GPFA	SFA	SFAC	SFAHH
									✓	✓	✓

PIAGGIO												
MP3 125 (Carb models) (12" rear wheel)	06-08	R	MP3 250cc (EFI) (12" rear wheel)	06-08	R							
X8 125	05-06	R	X8 250 ie	05-07	R							
X8 125 ie	07	R	X9 250	05-07	R							
X8 150 Street	07	R	Beverley 500	06	R							

FA426 64 x 48 x 8mm

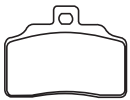

MATERIAL AVAILABILITY

FA	TT	V	R	HH	MXS	SXR	EPFA	GPFA	SFA	SFAC	SFAHH
✓											

BETA												
M4 350 Supermotard	04-15	F										

SFA427 94 x 36 x 10.5mm

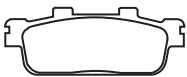

MATERIAL AVAILABILITY

FA	TT	V	R	HH	MXS	SXR	EPFA	GPFA	SFA	SFAC	SFAHH
	✓		✓						✓	✓	✓

ADIVA												
AD2/AD3 (300 3 Wheel Type)	14-15	R	Citymax 300 Quad	06	R							
DAELIM												
ET 250 Quad	05-08	R	GTS 300/Joymax (All models)	08-15	R							
ET 300 Quad	07-09	R	GTS 125i Joymax (All models)	14-15	R							
ST 250 Sector Quad	05-06	R	GTS 125i Sport (All models)	14-15	R							
S3 125 (SV 125)/S3 250 (SV 250)	12-14	R	HD Evo 125 (Carb & EFI models									
E-TON			/4T/Single headlamp)	03-13	R							
RXL 150 Vector	07	R	HD2-125i (4T) (Twin Headlamps)	10-15	R							
XVL 250 ST Vector	06-07	R	Joyride 125 i	07-09	R							
VXL 250 Vector	06-07	R	Joyride Evo 125i (Twin Headlamps)	09-21	R							
VXL 300 Vector/Vector ST	07	R	SB 125 Ni-Wolf	11-14	F							
VTX 300 Vortex/Vortex ST	07	R	HD 200 S Evo	07	R							
H P POWER			Quadlander 200	12-13	R							
Barum 260 (4T/2V/LC)	10-11	R	Trackrunner 200 Quad	05-08	R							
KYMCO			H200SE	06	R							
People S 125 DD	07-11	R	HD Evo 200 (Carb & EFI models/4T									
People S 200i DD	07-11	R	/Single headlamp)	03-13	R							
Xciting 250 i	06-08	R	HD2-200i (4T) (Twin Headlamps)	10-15	R							
Xciting 250	05	R	Joyride 200i	07-09	R							
Xciting 300i (T72000) (EFI Model)	08	R	Joyride Evo 200i	09-21	R							
Xciting 300i R (T72001/72011)	08-10	R	GTS 250	07-08	R							
PEUGEOT			GTS 250i/Joymax (All models)	09-15	R							
LXR 125 (4T)	10-12	R	Joymax 250 GTS	06-07	R							
LXR 200i (4T)	10-12	R	Joymax 250i	07-08	R							
			Quadlander 250	05-07	R							

FA428 A 82 x 41 x 9.5mm
B 62 x 41 x 9.5mm

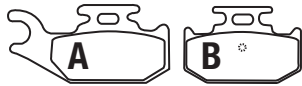

MATERIAL AVAILABILITY											
FA	TT	V	R	HH	MXS	SXR	EPFA	GPFA	SFA	SFAC	SFAHH
	✓		✓								

YAMAHA
YXR 66 FAS/FAT/FAV Rhino 4x4
Side x Side 04-06 R
YFM 700 RV/RW/RA 06-12 R

FA430 94.5 x 40 x 7.5mm



MATERIAL AVAILABILITY											
FA	TT	V	R	HH	MXS	SXR	EPFA	GPFA	SFA	SFAC	SFAHH
									✓	✓	✓

MBK XP 250 R-X-Max (ICO)
YP 125 Skycruiser 06-10 F (Brembo Front Caliper/Non ABS) 05-09 F
YAMAHA
YP 125 R (X-Max) 06-09 F

FA431 A. 103.5 x 42.5 x 9mm
B. 63 x 34.5 x 11mm



MATERIAL AVAILABILITY											
FA	TT	V	R	HH	MXS	SXR	EPFA	GPFA	SFA	SFAC	SFAHH
	✓		✓								

ADLY Crossroad 220 Sentinel Quad R 150 Supersport ES 150 11 R 08-09 R
Canyon 280 Quad 08-09 R
Hurricane 280 Quad 08-09 R
Canyon 300 Quad 08-09 R
Crossroad 300 Sentinel Quad 08-09 R
Interceptor 300 Quad R
Utility 300 05-07 R
Hurricane 300 Quad 08-09 R
300 RS Quad 07-08 R
300 XS Quad 07-08 R
Hurricane 320 Quad 08-09 R
320 S Quad 08 R
500 S 08 R
CPI XS 250 06-09 R
EXPLORER Ranger 300 2x4/4x4 08-09 R

HAMMERHEAD BUGGIES 150 Supersport ES 150 11 R 08-09 R
QUADZILLA CVT 150 E 10-11 R
XRV 250 (Off road) 06-07 R
XRV 250 E 06-07 R
QZ 300 E 4x4 (Parking brake) R
RL 300 Buggy 07-08 R
320 e 4x4 07-08 R(left)
CVT 320 e 07-11 R(left)
QZ 320 E 4x4 (Parking brake) 09 R

PGO BR-200 Bugdrider 07-12 R
BR 250 E Bugrider 05-12 R
250 Bug R

FA432 68 x 55 x 9mm

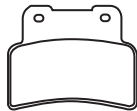

MATERIAL AVAILABILITY											
FA	TT	V	R	HH	MXS	SXR	EPFA	GPFA	SFA	SFAC	SFAHH
✓				✓					✓		✓

APRILIA Dorsoduro 900 (ABS) 17-21 F
RS 125 (Radial Caliper) 2T 06-12 F
Shiver 750 GT 09-10 F
Shiver 750 07-10 F
Shiver 750 (RAE00) (Std & ABS) 10-16 F
Shiver 750 GT ABS 10-12 F
Dorsoduro 750 (ABS) 08-16 F
Mana 850 08-11 F
Mana 850 GT (ABS Model) 09-14 F
Mana 850 ABS 08-13 F

Dorsoduro 900 (ABS) 17-21 F
Shiver 900 (ABS) 17-21 F
KYMCO Xciting 400i 12-20 F
Xciting S 400i 17-20 F
YAMAHA MT-125 (Non ABS) 14-16 F
MT-125A (ABS) 14-21 F
YZF-R 125 (Radial Caliper/Non ABS) 14-16 F
YZF-R 125A (Radial Caliper/ABS) 14-21 F

FA433/4 46 x 35 x 7.5mm



MATERIAL AVAILABILITY											
FA	TT	V	R	HH	MXS	SXR	EPFA	GPFA	SFA	SFAC	SFAHH
✓				✓			✓				

HONDA HM (Italy) CRM 125 R Supermoto 07 F
CRM 250 X Supermoto 07 F
CRM 450 R/X Supermoto 07-09 F
CRM F 490 X Supermoto 07 F
CRM F 500 X 11 F

HUSABERG FS 570 Supermoto 10-11 F
KTM SMR 450 (Magura caliper) 07-13 F
SMR 560 07 F
MAGURA 4 Piston Radial Supermoto Caliper

FA434 A 97.5 x 64 x 8mm
B 97.5 x 64 x 8mm



MATERIAL AVAILABILITY												
FA	TT	V	R	HH	MXS	SXR	EPFA	GPFA	SFA	SFAC	SFAHH	
✓		✓		✓			✓					

HARLEY DAVIDSON

FXST/FXSTi Softail Standard	06-07	R
FXSTB/FXSTBi Night Train Softail	06-07	R
FLSTSC/FLSTSCi		
Springer Softail Classic	06-07	R
FLSTF/FLSTFi Fat Boy	07	R

FA435/4 49 x 43.5 x 9.5mm



MATERIAL AVAILABILITY												
FA	TT	V	R	HH	MXS	SXR	EPFA	GPFA	SFA	SFAC	SFAHH	
				✓			✓	✓				

AP/LOCKHEED

4 Piston Radial Mount / 4 Separate Pads
(CP6688 - 8EOM/9EOM)

BREMBO

X00.C04 60/61 - 4 Piston P 34/34 Radial Mount Caliper @ 108mm spacing (4 pad set)
XA07680 - 2 Piston P2 34 Radial Mount (Note only sold as set of 4 pads)
X99C4 60/61 P4/34 Radial monobloc 4 pad 108mm spacing

MV AGUSTA

F4 100cc (1078cc) (Claudio Castiglioni) 07-08 F

PVM

2 Piston Rear Caliper (Note only 2 pads required)
4 Piston Radial Mount Caliper

FA436 77.5 x 42.5 x 9mm



MATERIAL AVAILABILITY												
FA	TT	V	R	HH	MXS	SXR	EPFA	GPFA	SFA	SFAC	SFAHH	
✓		✓		✓								

HONDA

CB 600 F7/F8/F9/FA/FB/FC	07-13	R
CBR 600 FB/FC	11-13	R
CBR 600 RR7/RR8/RR9/RRA/RRB/RRC /RRD/RRE/RRF/RRG (Radial Caliper)	07-16	R
CBR 600 RA9/RAA/RAB/RAC/RAD/RAG (C-ABS)	09-16	R
CBR 600 RR Hannspree	08	R
CBR 600 RR ABS	17-21	R
CBR 1000 RR6-RR9/RRA/RRB/RRC /RRD/RRE	06-16	R
CBR 1000 RA9/RAA/RAB/RAC/RAD /RAE/RAF/RAG/RAH/RAJ (C-ABS)		
Fireblade	09-18	R
CBR 1000 Fireblade C-ABS Nissin F/Calipers	17-21	R
CBR 1000 RR-SP ABS Fireblade (CBR 1000 SAE/SAF/SAG/SAH/SAJ)	14-18	R
CBR 1000 RR-SP ABS-TT Edition	16	R
CBR 1000 RR-SP Non ABS Fireblade (CBR 1000 SAE/SAF/SAG)	14-16	R
KAWASAKI		
Ninja ZX-6R (ZX 636 Non ABS 636cc)	13-20	R
Ninja ZX-6R (ZX 636 Non ABS/ KRT Edition - 636cc)	16-20	R
Ninja ZX-6R (ZX 636 ABS 636cc)	13-20	R
Ninja ZX-6R (ZX 636 ABS/KRT Edition 636cc)	16-20	R
ZX-6R 30th Anniversary Edition (ZX 636 EPPA /Non ABS/636cc)	15	R

ZX-6R 30th Anniversary Edition

(ZX 636 FFFA / ABS/636cc)	15	R
ZX 10 R ABS (ZX 1000 KBF/KCF /KDF/KEF/KFF)	11-15	R
ZX 10 R (ZX 1000 JBF/JCF/JDF /JEF/JFF)	11-15	R
ZX-10R 30th Anniversary Edition (ZX 1000 JFFA /Non ABS)	15	R
ZX-10R 30th Anniversary Edition (ZX 1000 KFFA /ABS)	15	R
ZX 10 R (ZX1000)	16-20	R
ZX 10R Winter Test Edition (ZX1000 SGFB)	16	R
ZX 10 R Ninja KRT Replica	16-20	R
ZX 10 R SE Ninja	18-21	R
Ninja ZX-10RR (ZX1000ZHF)	17-21	R
SUZUKI		
GSX-R 600	11-21	R
GSX-R 750	11-21	R
GSX-R 1000	11-21	R
GSX-R 1000 R	17-21	R
GSX-S 1000 (ABS)	15-21	R
YAMAHA		
YZF-R6	17-21	R
Niken ABS (847cc/3 Cyl Engine)	18-20	R
YZF-R1	15-21	R
YZF-R1 M	15-21	R
YZF-R1 (60th Anniversary Edition)	16	R

FA438 103 x 37.5 x 8.5mm



MATERIAL AVAILABILITY												
FA	TT	V	R	HH	MXS	SXR	EPFA	GPFA	SFA	SFAC	SFAHH	
				✓								

BMW

K 1200 GT (K44) 06-08 R

FA441 77.5 x 51.5 x 8.5mm



MATERIAL AVAILABILITY												
FA	TT	V	R	HH	MXS	SXR	EPFA	GPFA	SFA	SFAC	SFAHH	
				✓								

BMW

K 1200 GT (K44) 06-08 F (Right)

DO NOT REFIT ANY SHIMS/INSULATORS TO EBC PADS FROM ORIGINAL PADS UNLESS INSTRUCTED ON NOTE ON PAD PACKAGING AND ON FA DRAWING ASSOCIATED WITH THAT PAD.

DO NOT REFIT ANY SHIMS/INSULATORS TO EBC PADS FROM ORIGINAL PADS UNLESS INSTRUCTED ON NOTE ON PAD PACKAGING AND ON FA DRAWING ASSOCIATED WITH THAT PAD.

FA442/4 A 61.5 x 44 x 8mm
B 48 x 31 x 8mm

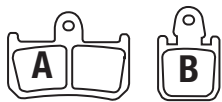

MATERIAL AVAILABILITY												
FA	TT	V	R	HH	MXS	SXR	EPFA	GPFAX	SFA	SFAC	SFAHH	
✓				✓			✓	✓				

YAMAHA

YZF R1 (6 piston radial caliper)	07-14	F	XV 1700 V-Max	09-21	F
MT-01 (6 piston radial caliper)	07-10	F	MT-01S (5YUR)	09	F

FA443 A 107 x 34 x 8mm
B 91.5 x 38 x 8mm

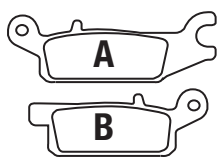

MATERIAL AVAILABILITY												
FA	TT	V	R	HH	MXS	SXR	EPFA	GPFAX	SFA	SFAC	SFAHH	
	✓		✓									

YAMAHA

YFM 250 RX/RV Raptor	08-09	F(left)	YFM 550 FWAD Grizzly EPS		
YFM 250 R (33B)	09-13	F(left)	(Power Steering)	11-14	F(left)
YFM 550 FWA Grizzly IRS	11-14	F(left)	YFM 700 FWAD Grizzly EPS	07-18	F(left)

FA444 A 107 x 34 x 8mm
B 91.5 x 38 x 8mm

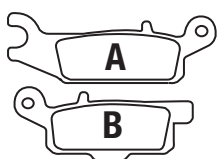

MATERIAL AVAILABILITY												
FA	TT	V	R	HH	MXS	SXR	EPFA	GPFAX	SFA	SFAC	SFAHH	
	✓		✓									

YAMAHA

YFM 250 RX/RV Raptor	08-09	F(right)	YFM 550 FWAD Grizzly EPS		
YFM 250 R (33B)	09-13	F(right)	(Power Steering)	11-14	F(right)
YFM 550 FWA Grizzly IRS	11-14	F(right)	YFM 700 FWAD Grizzly EPS	07-18	F(right)

FA445 A 107 x 34 x 8mm
B 91.5 x 38 x 8mm

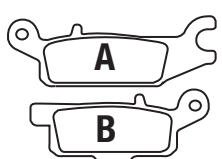

MATERIAL AVAILABILITY												
FA	TT	V	R	HH	MXS	SXR	EPFA	GPFAX	SFA	SFAC	SFAHH	
	✓		✓									

YAMAHA

YFM 700 FWAD Grizzly EPS	07-18	R(left)	YFM 550 FWAD Grizzly EPS		
YFM 550 FWA Grizzly IRS	11-14	R(left)	(Power Steering)	11-14	R(left)

FA446 A 107 x 34 x 9mm
B 91.5 x 38 x 9mm

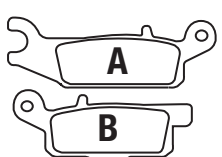

MATERIAL AVAILABILITY												
FA	TT	V	R	HH	MXS	SXR	EPFA	GPFAX	SFA	SFAC	SFAHH	
	✓		✓									

YAMAHA

YFM 700 FWAD Grizzly EPS	07-18	R(left)	YFM 550 FWAD Grizzly EPS		
YFM 550 FWA Grizzly IRS	11-14	R(left)	(Power Steering)	11-14	R(left)

FA447 102 x 42 x 7.5mm



MATERIAL AVAILABILITY												
FA	TT	V	R	HH	MXS	SXR	EPFA	GPFAX	SFA	SFAC	SFAHH	
				✓			✓	✓				

APRILIA			DB8 SP (1078cc)	12-13	F	Diavel - ABS			11-18	F
RSV4 R	10	F	DB11 VLX (1198cc)	12-13	F	Diavel Carbon - ABS			11-20	F
RSV4R APRC	11-13	F	BMW			Diavel Chromo ABS			12	F
RSV4R APRC ABS	13-14	F	HP2 Sport (K29)	08-11	F	Diavel AMG			11-12	F
RSV4 Factory	09-10	F	HP4	13-14	F	Diavel Strada			13-14	F
RSV4 Factory APRC	11-13	F	HP4 Carbon	13-14	F	Diavel Dark			13-14	F
RSV4 Factory APRC ABS	13-14	F	HP4 Race	19-20	F	Diavel Diesel (1200cc)			17-18	F
RSV4 RF 1000	15-18	F	BREMBO			990 Supermoto R (SM-R)			10-11	F
RSV4 1100 Factory/RR	19-21	F	220B01010 - GP4-RX 4 Piston			998 Panigale V4 Superleggera			21	F
RSV4 RR 1000	15-18	F	Radial Mount @ 108mm Spacing			1098			07-08	F
RSV4 1100 RR	19-21	F	220A39710 P4/34 108mm			1098 S			07-08	F
Tuono Factory 1100 V4	17-18	F	Mount monobloc radial			1098 R			08-09	F
Tuono 1100 RR V4	17-21	F	220988530 P4/34 100mm Mount			1098 S Tricolore			07	F
Tuono V4 1100 Factory	19-21	F	monobloc radial			Hypermotard 1100 S			07-09	F
BENELLI			20 9883 Radial monobloc 100mm centres			Desmosedici RR (D16RR/989cc)			08	F
Tornado Naked Tre 1130 TNT R	13-16	F	DUCATI			Streetfighter 1100 (1099cc)			09-11	F
BIMOTA			848 Evo (Monobloc front calipers)	10-13	F	Streetfighter 1100 S (1099cc)			09-13	F
DB7 (1099cc)	09	F	848 Evo Dark	12	F	Streetfighter V4 and V4 S 1103cc			19-21	F
DB8 (1198cc)	10-13	F	848 Evo Corse SE	12-13	F	1100 Evo SP Hypermotard			10-12	F

Part numbers, prefixes, suffixes, photos and illustrations shown in this catalogue are trademarks and/or copyrights of EBC Brakes or the trademark owner A C Freeman Investments Limited and use without express written permission of the owners is punishable by law.

FA447 102 x 42 x 7.5mm

DUCATI (Contd)

1103 Panigale V4 (1103cc) 18-21 F
 1103 Panigale V4 S 18-21 F
 1103 Panigale V4 SP 21 F
 1103 Panigale V4 R 21 F
 Streetfighter V4 1103cc 19-21 F
 Streetfighter V4 S 1103cc 19-21 F
 Multistrada V4 S 1158cc 21 F

1198 09-11 F
 1198 S 09-10 F
 1198 R/S Corse 10 F
 1198 SP 11 F
 1199 Panigale 12-13 F
 1199 Panigale ABS 12-15 F
 1199 Panigale S ABS 12-15 F
 1199 Panigale S Tricolore 12-13 F
 1199 Panigale R 13-16 F
 1199 Superleggera 14 F
 1200 S Monster 14-21 F
 1200 Monster Stripe 15-20 F
 1200 Monster R 16-18 F
 1200 S Multistrada DVT 15-17 F
 1200 S Multistrada D air DVT 15-17 F
 1200 S Multistrada Touring 15-16 F
 1200 Multistrada Touring 15-16 F
 1200 S Multistrada 15-18 F
 1200 S Multistrada D air 15-16 F
 1200 S Multistrada Pikes Peak 16-17 F
 1200 Multistrada V4S 21 F
 1260 S Multistrada 18-20 F
 1260 S Multistrada D air 18-20 F
 1260 Multistrada Pikes Peak 18-20 F
 1260 Multistrada Enduro 18-20 F
 1260 Multistrada S Grand Tour 19-21 F
 1262 X Diavel S 16-21 F
 1262 X Diavel Black Star 21 F
 1299 Panigale 15-18 F
 1299 Panigale R 15-17 F
 1299 Panigale V4 Corse/ Speciale 18-21 F
 1299 Panigale V4 R 19-20 F
 1299 Panigale R Final Edition 18 F
 1299 Panigale S 15-18 F
 1299 Superleggera 17 F

ENERGICA ELECTRIC

Electric EVA 20-21 F
 Electric EVA Ribelle 21 F
 Electric EVA Ribelle RS 21 F
 Electric EGO 20-21 F

Electric EVA Esse Esse 9 20-21 F
HONDA
 CBR 1000 RR-SP ABS Fireblade 14-21 F
 (CBR1000 SAE/SAF/SAG/SAH/SAJ) 14-21 F
 CBR 1000 RR-SP Non ABS Fireblade 14-16 F
 (CBR 1000 SE/SF/SG) 14-16 F
 RC 213 V-S 15-17 F
HUSQVARNA
 Nuda 900 R 12-13 F
KAWASAKI
 H2 Ninja (ZX 1000 NFF/NGF) 15-16 F
 H2 R Ninja (ZX 1000 PFF/PGF) 15-16 F
 ZX 10R (ZX 1000 SGF/SHF/SJF) 16-20 F
 ZX 10R Winter Test Edition 16 F
 (ZX 1000 SGFB) 16 F
 ZX 10R Ninja KRT Replica 16-20 F
 (ZX 1000 SGFA/SHFA/SJFA) 16-20 F
 ZX 10 R SE Ninja 18-21 F
 Z 1000 JHF/JJF (ABS/310mm Round Discs) 17-18 F
 Ninja H2 (ZX 1000 XHF/XJF) 17-20 F
 Ninja H2 Carbon (ZX 1000 XHFA/XJFA) 17-20 F
 Ninja H2R (ZX 1000 YHF/YJF) 17-20 F
 Ninja ZX-10RR (ZX 1000 ZHF) 17-21 F
 ZZR 1400 Performance Sport (ZX 1400 JGF/JHF/JJF) 16-20 F
KTM
 SMR 450 (Brembo F/caliper) 14 F
 Duke 690 R (Multi spoke cast wheels) 13-18 F
890 Duke R 21 F
 990 Supermoto R (SMR) 10-13 F
 RC8 (1190cc) 08-11 F
 RC8 R (1190CC)/Track 09-15 F
 1290 Super Duke R 14-21 F
1290 Super Duke RR 21-22 F
 1290 Super Duke R SE 16-18 F
 1290 Super Duke GT 16-21 F
MV AGUSTA
 675 F3 Serie Oro 12-13 F
 800 F3 13-18 F
 800 F3 Ago 14-15 F
 800 F3 RC 15-18 F
 998 Freccce Tricolori 10 F
 F4 998cc 10-15 F
 998 F4R 12-15 F
 998 F4RR 10-15 F
 998 F4RR Corsa Corta 12 F
 F4 1000 CC 07 F

1000 F4R 312 (From VIN 008065 Brembo 2 pad caliper) 08-09 F
1000 Brutale 19-21 F
 1078 Brutale RR 08-09 F
 F4RR 1078cc 312 08-09 F
 1078 F4 RR 312 09 F
 Brutale 1090 RR 10-15 F
 1090 Brutale Corsa 13-15 F
SUZUKI
 GSX-R 600 Inc 100th Anniversary 11-21 F
 GSX-R 750 Inc 100th Anniversary 11-21 F
 GSX-R 1000 12-21 F
 GSX-R 1000 R Inc 100th Anniversary 17-21 F
 GSX-S 1000 (Naked/Non ABS) 16-20 F
 GSX-S 1000 (Naked/ABS) 16-21 F
 GSX-S 1000 F (Faired/Non ABS) 16-20 F
 GSX-S 1000 F (Faired/ABS) 16-21 F
 GSX 1000 Katana 18-21 F
 GSX 1300 R Hayabusa (Brembo calipers) 13-18 F
TM RACING
 SMR 125 Tsi 19-21 F
 SMR 300 Tsi 19-21 F
 SMX 300 2S ES 19-21 F
 SMR 450 Fi ES 10-21 F
 SMR 530 Fi ES 19-21 F
TRIUMPH
 Daytona 675R (Brembo calipers) 11-17 F
Rocket 3 R 19-21 F
Rocket 3 GT 19-21 F
 Speed Triple R 1050 (2 Pad caliper /Non ABS /5 Spoke wheel) 12-13 F
 Speed Triple R 1050 (2 Pad caliper /ABS/5 Spoke wheel) 12-13 F
 Speed Triple R 1050 (2 Pad caliper /ABS/10 Spoke wheel) 14-16 F
 Speed Triple R 1050 (2 Pad caliper /Non ABS/10 Spoke wheel) 14-16 F
 Speed Triple R (1050cc/ABS) 17-21 F
 Speed Triple S (1050cc/ABS) 17-21 F
 Speed Triple RS 1200 ABS 21 F
 Street Triple R (Bembo F&R Calipers) 17-21 F
 Street Triple RS (Bembo F&R Calipers) 17-21 F
 Thruxton R 1200 (Liquid Cooled) 16-17 F
 Thruxton TFC 1200 19-20 F
 Tiger 900/GT/GT Low/GT Pro 20-21 F
 Tiger 900 Rally/Rally Pro 20-21 F

FA448 58 x 33.5 x 6mm



MATERIAL AVAILABILITY

FA	TT	V	R	HH	MXS	SXR	EPFA	GPFAX	SFA	SFAC	SFAHH
✓											

ELSTARS (PIT BIKES)

Various models (Check parts before fitting) F&R

ITALJET

Pit Jet 50 (2T) 07-09 F&R

Pit Jet 125 4T (Pro) 07-09 F&R

GENERIC/KSR

Mini Trigger X50 08-09 F&R

Mini Trigger SM 50 08-09 F&R

LIFAN

LF 125 Off Road 07 F

MOTOM

Spasso 50 08-09 F

QUADZILLA

WK 140 06-08 F

STOMP MINI MOTO

125cc Elite 07-09 F

FA450 A 94 x 32 x 7mm B 94 x 32 x 7mm



MATERIAL AVAILABILITY

FA	TT	V	R	HH	MXS	SXR	EPFA	GPFAX	SFA	SFAC	SFAHH
	✓		✓		✓		✓				

FANTIC

XE 125cc 2T 21 F YZ-F 250 (4T) 07-15 F

XX 125cc 2T 21 F YZ-F 450 (4T) 08-15 F

WR-F 250 (4T/Reverse Cylinder) 17-20 F

WR-F 450 (270mm F/Disc/ 4T) 16-20 F

YAMAHA
 YZ 125 2T 08-22 F YZ-F 250 (270mm Disc) 16-20 F

YZ 125 Monster Energy 2T 22 F YZ 250 F (60th Anniversary Edition/ 270mm Disc) 16 F

YZ 125 X 2T 21-22 F YZ-F 450 (270mm Disc) 16-20 F

YZ 250 2T 08-18 F YZ 450 F (60th Anniversary Edition/ 270mm Disc) 16 F

YZ 250 Monster Energy 2T 22 F

YZ 250 X 2T 17-22 F

BUYERS GUIDE
BRAKE PAD

DO NOT REFIT ANY SHIMS/INSULATORS TO EBC PADS FROM ORIGINAL PADS UNLESS INSTRUCTED ON NOTE ON PAD PACKAGING AND ON FA DRAWING ASSOCIATED WITH THAT PAD.

FA452 120.5 x 57.5 x 8mm

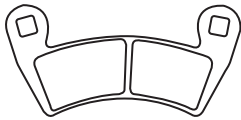

MATERIAL AVAILABILITY												
FA	TT	V	R	HH	MXS	SXR	EPFA	GPFA	SFA	SFAC	SFAHH	
	✓		✓			✓						✓

MATERIAL AVAILABILITY												
FA	TT	V	R	HH	MXS	SXR	EPFA	GPFA	SFA	SFAC	SFAHH	
POLARIS												
400 Ranger				10-14	F				900 D Crew Ranger Diesel			F&R
Ranger 500 4x4 EFI				08-13	F				900 Ranger Crew			F&R
500 Ranger (EFI) 4x4 HO				09-11	F				900 D Ranger Diesel	11-14		F
Ranger 500 2x4				08	F				Ranger RZR XP 900	11		F
500 Ranger Crew				11-13	F				Ranger RZR XP 900 White Lightning LE	11		F
500 Ranger (Carb) 2x4				09	F				900 Ranger RZR XP EFI	12		F
Ranger 700 6x4 EFI				08	F				900 Ranger RZR XP	12		F
Ranger XP 700 4x4				08	F				RXR-4 XP900	12-14		F&R
700 Ranger 4x4 EFI				09	F				900 XP Ranger	13-15		F
700 Ranger Crew (EFI) 4x4				09	F&R				1000 Ranger Diesel	15		F
Ranger EV (Electric)				10-14	F				1000 Ranger Diesel Crew	15		F
800 Ranger XP				10-12	F				RZR 1000 XP	14		F&R
800 Ranger 6x6				10-14	F				Brutus	13-14		F
800 Ranger Crew				10-14	F&R				1000 General EPS (2 Seat)	16		F
800 Ranger RZR 4 EPS				12	F				1000 General EPS (2 Seat)	17-19		F
RZR-4 800 EFI				10-14	F				1000 General 4 EPS (4 Seat)	17-19		F

FA453 97 x 37 x 7mm



MATERIAL AVAILABILITY												
FA	TT	V	R	HH	MXS	SXR	EPFA	GPFA	SFA	SFAC	SFAHH	
	✓		✓									

MATERIAL AVAILABILITY												
FA	TT	V	R	HH	MXS	SXR	EPFA	GPFA	SFA	SFAC	SFAHH	
AJS												
Crazy 50 Naked				13-14	R				ATV 420 4x2/LOF	13		F&R
C F MOTO												
CF 500-C/Force (X5 Terralander)				11-15	F				ATV 420 4x4/LOF	13		F&R
CF 500 5B/5C C-Force 500 Classic				14-15	F				ATV 420 4x4 Carrier/LOF	13		F&R
CF 625-C/Force (X6 Terralander)				11-15	F				ATV 600 EFI 4x4/LOF	13		R
EXPLORER												
Atlas 500/4x4				08-09	F				CUV Jobber 4x4	13		R
Everest 500 L/4x4				08-09	F				NEW FORCE QUADS			
Most models (Check shape of old pad)												
PEUGEOT												
									Metropolis 400 RS (3 Wheel Model)	14		F&R
GOES												
220 UTS (Side x Side)				13-14	F				QUADZILLA			
360 Max (Quad)				08-14	F				CVT 150 E	10-11		F
G 520 (Quad)				07-14	F				CUV 300 (4x4 Super Utility Side x Side)	08		R
520 Max (Quad)				07-14	F				Quadzilla 300 Utility	04-06		F
G 525 (4x4)				12-13	F				300 E SUV (Manual)	06-07		F
G 525 4x4 Max				12-13	F				300 E SUV (Automatic)	06		F
G 625i (All models)				12	F				300 E (4x4) (Auto)	06		F
G 625i (4x4)				12-14	F				320 e 4x4	07-11		F
G 625i 4x4 Max				12-14	F				CVT 320 e	07-11		F
G 625i UTX 4x4 (Side x Side)				12-14	F				500 4x4	09-11		F
625i UTS (Side x Side)				13-14	F				CUV 500 Side x Side	10-11		F
G E-SSV Electric (Side x Side)				12-13	F				RL 500 MKII Buggy	10-11		F
LINHAI												
Goon 260 ATV (2x4/4x4)				07-09	F&R				RS5 4WD	10-11		F
CUV Carry 300 (ATV)				07-09	F&R				RS6 EFI 4WD	10-11		F
Muddy 300 4x4 (ATV)				07-09	F&R				X8 (4x4/EFI)	12-13		F
ATV 310 (4x2)				13	F&R				ZX6 4x4	10-15		F
ATV 320 4x4 Carrier				13	F&R				W.T. MOTORS			
WT 500 Alaska Quad												

FA454/4 61.5 x 47 x 7.5mm

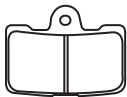

MATERIAL AVAILABILITY												
FA	TT	V	R	HH	MXS	SXR	EPFA	GPFA	SFA	SFAC	SFAHH	
				✓			✓					

MATERIAL AVAILABILITY												
FA	TT	V	R	HH	MXS	SXR	EPFA	GPFA	SFA	SFAC	SFAHH	
BUELL												
1125 R				08-10	F							
1125 CR				09-10	F							
XB12 SCG Lightning				09-10	F							
XB12 R Firebolt				09-10	F							
XB12 SS Lightning				09-10	F							
EBR												
									1190RX	14-15		F
									1190SX	14-15		F

FA455 99 x 55 x 9mm



MATERIAL AVAILABILITY												
FA	TT	V	R	HH	MXS	SXR	EPFA	GPFA	SFA	SFAC	SFAHH	
		✓		✓								

MATERIAL AVAILABILITY												
FA	TT	V	R	HH	MXS	SXR	EPFA	GPFA	SFA	SFAC	SFAHH	
JAYBRAKE CALIPERS												
6 PF-L (6 Piston for 13" disc - Full Height Friction)												

FA456 97 x 47 x 8mm



MATERIAL AVAILABILITY											
FA	TT	V	R	HH	MXS	SXR	EPFA	GPFA	SFA	SFAC	SFAHH
	✓		✓			✓					

POLARIS		RZR-S 900 "60 Inch All Options"		15-19	R	
450 S Outlaw		08	F	Scrambler 1000 XP	19-20	R
450 Outlaw MXR		09-10	F	Sportsman 1000 XP 55		
525 S Outlaw		08-10	F	Inc 1000 S 55" models	20-21	R
525 Outlaw IRS		08-11	F	RZR 100060"	16-19	R
RZR 570		12-19	F	1000 General EPS (2 Seat)	16	R
RZR 800 Ranger		08-14	F	1000 General EPS (2 Seat)	17-19	R
RZR 900 "50 Inch All Options"		15-19	R	1000 General 4 EPS (4 Seat)	17-19	R

FA457 A 90.5 x 62 x 8mm B 90.5 x 62 x 8mm

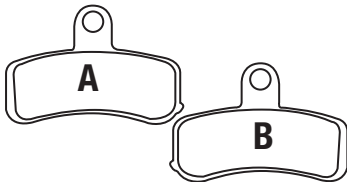

MATERIAL AVAILABILITY											
FA	TT	V	R	HH	MXS	SXR	EPFA	GPFA	SFA	SFAC	SFAHH
		✓	✓	✓							

HARLEY DAVIDSON		FSXT Softail Standard		08-14	F
FXDL Low Rider (Cast wheel)	10-17	F	FXCW Rocker	08-09	F
FXDL Low Rider (Spoke wheel)	08-09	F	FXCWC Rocker C	08-11	F
FXDL Low Rider (Spoke wheel)	10-17	F	FXD Super Glide	08-10	F
FXDLS Low Rider S	17		FXDB Street Bob	08-17	F
FLD Switchback	12-15	F	FXDC Super Glide Custom	08-14	F
FLS Softail Slim	12-14	F	FXDF Fat Bob	08-17	F
FLSTC Heritage Softail Classic	08-14	F	FXDWG Dyna Wide Glide (Spoke wheels)	08-17	F
FLSTF Fat Boy	08-14	F	FXSB Breakout	13-14	F
FLSTFB Fat Boy LO	10-14	F	FXSTB Night Train	08-09	F
FLSTFB Fat Boy Special	10-13	F	FXSTC Softail Custom	08-10	F
FLSTFB Fat Boy Lo Softail	10-14	F	Softail FXS Blackline	11-13	F
FLSTN Softail Deluxe	08-14	F	FXDBC Street Bob LTD	16	F

FA458 A 130 x 56.5 x 8mm B 130 x 56.5 x 8mm

HH thickness = 7.5mm

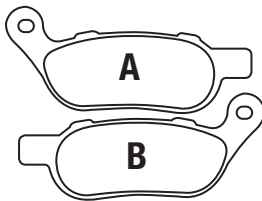

MATERIAL AVAILABILITY											
FA	TT	V	R	HH	MXS	SXR	EPFA	GPFA	SFA	SFAC	SFAHH
		✓		✓			✓				

HARLEY DAVIDSON		FXCWC Rocker C		08-11	R
FXDL Low Rider (Cast wheel)	10-17	R	FXD Super Glide	08-10	R
FXDL Low Rider (Spoke wheel)	08-09	R	FXDB Street Bob	08-20	R
FXDL Low Rider (Spoke wheel)	10-17	R	FXDC Super Glide Custom	08-14	R
FXDLS Low Rider S	17	R	FXDF Fat Bob	08-17	R
FLD Switchback	12-15	R	FXDWG Dyna Wide Glide (Spoke wheels)	08-20	R
FLS Softail Slim	12-17	R	FXSB Breakout	13-17	R
FLSTC Heritage Softail Classic	08-17	R	FXST Softail Standard	08-15	R
FLSTF Fat Boy	08-17	R	FXSTB Night Train	08-09	R
FLSTFB Fat Boy Lo Softail	10-14	R	FXSTC Softail Custom	08-10	R
FLSTFB Fat Boy Special	10-13	R	Softail FXS Blackline	11-13	R
FLSTFB Fat Boy LO	10-17	R	FLSS Softail Slim S	16-20	R
FLSTN Softail Deluxe	08-17	R	FXSB Softail Breakout	16	R
FLSTSB Softail Cross Bones	08-11	R	FLSTFBS Fat Boy S	16-17	R
FXCW Rocker	08-09	R	FXDBC Street Bob LTD	16	R

FA460 49 x 46.5 x 7mm



MATERIAL AVAILABILITY											
FA	TT	V	R	HH	MXS	SXR	EPFA	GPFA	SFA	SFAC	SFAHH
				✓							

BUELL		EBR				
1125 R		08-10	R	1190RX	14-15	R
1125 CR		09-10	R	1190SX	14-15	R

FA462 75 x 37 x 7.5mm



MATERIAL AVAILABILITY											
FA	TT	V	R	HH	MXS	SXR	EPFA	GPFA	SFA	SFAC	SFAHH
			✓								

KTM		XC 450 Quad		08-10	F	
450 SX-F (Quad)		09-11	F	XC 450 Quad	08-10	F
505 SX-F (Quad)		09-12	F	XC 525 Quad	08-12	F

FA463 58.5 x 35.5 x 8.5mm



MATERIAL AVAILABILITY											
FA	TT	V	R	HH	MXS	SXR	EPFA	GPFA	SFA	SFAC	SFAHH
			✓								

KTM		XC 450 Quad		08-10	R	
450 SX-F (Quad)		09-11	R	XC 450 Quad	08-10	R
505 SX-F (Quad)		09-12	R	XC 525 Quad	08-12	R

FA464 A 109.5 x 50.5 x 8.5mm
B 95.5 x 37 x 8.5mm

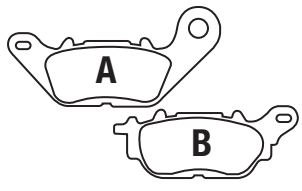

MATERIAL AVAILABILITY												
FA	TT	V	R	HH	MXS	SXR	EPFA	GPFA	SFA	SFAC	SFAHH	
✓									✓	✓		

YAMAHA			GPD 150 A - N-Max/2DP4	15-17	R
GPD 125 A - N-Max/2DS1	15-18	R	N-Max 150- See GPD 150 A	15-18	R
N-Max 125- See GPD 125 A	15-21	R	MWS 125 Tricity Scooter (3 Wheeler)	17-18	R
XC 115 S-D'elight	14-16	F	HONLEY		
FZS 25	19-21	F	HD1 125	14-15	F
XC 125 Vity (4P7)	08-13	F	HD2 125	16-17	F
YBR 125 (3D92/9)	07-09	F	HD3 125	16-17	F
YBR 125 Custom	08-16	F	HD3 SE 125	16-17	F
YBR 125 (51D1/2)	10-16	F	LEXMOTO		
YS 125	17-21	F	Aspire 125 TD125-43	12-16	R
T 135 HC/S (2S61) Crypton X			MBK		
/Jupiter MX/Spark 135/Exciter			XC 125 WAAP	08-10	F
/135 LC/Sniper	06-08	F			
T 135-SE (1S71) (Automatic Clutch)					
Crypton X/Jupiter MX/Spark 135/Exciter/135 LC/Sniper	06-08	F			

FA465 A 110.5 x 34.5 x 7.5mm
B 98.5 x 33.5 x 7.5mm

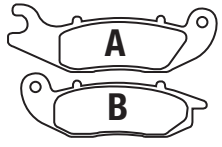

MATERIAL AVAILABILITY												
FA	TT	V	R	HH	MXS	SXR	EPFA	GPFA	SFA	SFAC	SFAHH	
	✓		✓		✓							

AJP			TZ 170 E Regularita (125E/4T)	11-15	F	HONDA						
PR3 125 Enduro	13-15	F	TZ 170 ER Caballero Regularita			CRF 250 L			13-20	F		
PR3 125 Enduro Pro	13-15	F	Competizione (125ER/4T)	11-15	F	CRF 250 L ABS			17-21	F		
PR3 125 Extreme	13-15	F	TZ 170 M Motard (125SM/4T)	11-15	F	CRF 300 L ABS			20-21	F		
PR3 125 Supermoto	13-15	F	TZ 170 MR Motard Competizione			CRF 250 Rally			17-20	F		
PR4 125 Enduro	13-15	F	(125SM/4T)	11-15	F	CRF 250 Rally ABS			17-21	F		
PR4 125 Trail	13-15	F	TX 180 E Regularita Casa 50 E			CRF 300 Rally ABS			20-21	F		
PR4 125 Enduro Pro	13-15	F	(49cc/2T)	12-15	F	CRF 250 ME Supermoto			14-16	F		
PR4 125 Supermoto	13-15	F	TX 180 ER Regularita Competizione			HONDA H-M						
PR3 250 MX Pro	13-15	F	50 ER (49cc/2T)	12-15	F	CRE 125 (Baja RR 2T)			11	F		
PR4 240 Extreme	13-15	F	TX 180 ES Regularita Scuderia			MH						
PR5 250 Enduro	10-15	F	50 ES (49cc/2T)	12-15	F	Duna 125 Supermotard			14	F		
PR5 250 Extreme	12-15	F	TX 180 M Motard Casa 50M (49cc/2T)	12-15	F	Ranger 125 Enduro			13-14	F		
PR5 250 Supermoto	10-15	F	TZ 180 MR Motard Competizione			RIEJU						
DERBI			50 MR (49cc/2T)	12-15	F	MTR 50 Pro Competizione						
Cross City 125	09-14	F	TZ 200 ER Caballero Regularita			(Spoke wheel)			11-14	F		
Mulhacen 125 (4T) From Ref No. 7N001791 Spoke wheel			Competizione (200ER/4T)	11-15	F	Tango 50 2T			13-15	F		
/single pin fixing	07-10	F	TZ 200 MR Motard (200 MR/4T)	11-15	F	Marathon Pro 125 Competizione			11-14	F		
Terra 125 Euro (Single pin pad fixing)	07-11	F	TF 250 ES Regularita (4T)	11-13	F	Tango 125			11-20	F		
Terra 125 Adventure	07-14	F	TR 250 ES (2T) Enduro Six Days	13	F	Tango 250			12-15	F		
FANTIC			TR 300 ES (2T) Enduro Six Days	13	F	SCORPA						
TR 125 CR (2T) Cross Competizione	13	F	TZ 300 ES Regularita Scuderia	11-12	F	T-Ride 125 F			10	F		
TZ 125 CS Caballero Cross (2T)	11-12	F	GAS-GAS			T-Ride 250 F (Enduro)			08-10	F		
TZ 125 ES Regularita Scuderia (2T)	11-12	F	EC Cami 250 F (4T)	14-15	F							

FA468 67 x 52 x 7.5mm



MATERIAL AVAILABILITY												
FA	TT	V	R	HH	MXS	SXR	EPFA	GPFA	SFA	SFAC	SFAHH	
			✓									

CAN AM			DS 450 (2x4/EFI)	08-15	F
DS 450 X (2x4/EFI)	08-09	F			
DS 450 Xxc/Xxm	10-15	F			

FA471 36 x 39 x 6mm



MATERIAL AVAILABILITY												
FA	TT	V	R	HH	MXS	SXR	EPFA	GPFA	SFA	SFAC	SFAHH	
✓												

SCORPA			SY 250 R (2T)	00-09	R
SR 125 (2T)	09-13	R	SY 250 FR Long Ride	10	R
SR 125 Long Ride (2T)	09-11	R	SY 250 FR	06-10	R
SY 125 FR (4T)	03-11	R	SR 280 (2T)	09-14	R
SY 125 (4T) Long Ride	09-10	R	SR 280 (2T) Long Ride	09-11	R
TY 125 (4T)	11-13	R	Twenty 280	14	R

FA473 110.5 x 54.5 x 8mm

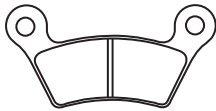

MATERIAL AVAILABILITY											
FA	TT	V	R	HH	MXS	SXR	EPFA	GPFA	SFA	SFAC	SFAHH
✓		✓									

CAN AM

Spyder RS SE5	08-09	R	Spyder RT	10-12	R
Spyder RS SM5	08-09	R	Spyder RS-S	10-12	R
Spyder RS Phantom Black	09	R	Spyder RS	10-12	R
Spyder RT-S	10-12	R	Spyder RT LTD	11-12	R

FA474 A 75.5 x 32 x 8mm B 75.5 x 32 x 8mm



MATERIAL AVAILABILITY											
FA	TT	V	R	HH	MXS	SXR	EPFA	GPFA	SFA	SFAC	SFAHH
✓	✓										

CAN AM

Spyder RS SE5	08-09	F	Spyder RT	10-12	F
Spyder RS SM5	08-09	F	Spyder RS-S	10-12	F
Spyder RS Phantom Black	09	F	Spyder RS	10-12	F
Spyder RT-S	10-12	F	Spyder RT LTD	11-12	F

FA475 97 x 42.5 x 7mm



MATERIAL AVAILABILITY											
FA	TT	V	R	HH	MXS	SXR	EPFA	GPFA	SFA	SFAC	SFAHH
	✓		✓								

POLARIS

325 Hawkeye 2x4	15	R	570 Sportsman 6x6	17-21	R
400 Hawkeye H.O. (2x4)	11-14	R	570 Sportsman 6x6 Tractor	17-21	R
400 Sportsman HO 4x4	11-14	R	800 Sportsman HO/EFI		
500 XP Sportsman	09	F&R	800 Sportsman EFI	09	R
500 Sportsman H0			800 Sportsman	12-14	F&R
(After 16/12/2008)	09-13	R	850 Scrambler	13-18	F&R
500 Sportsman Forest	10-14	F&R	850 Forest	15	F&R
550 Sportsman XP EPS	09-14	F&R	850 XP Sportsman	09-15	F&R
550 Sportsman X2	10-14	F&R	850 XP EPS Sportsman	09-14	F&R
550 XP Sportsman EPS	09-14	F&R	850 Sportsman Touring EPS	10-14	F&R
550 Sportsman Touring EPS	10-18	F&R	850 Sportsman Touring H.O. EPS	13-15	F&R
550 Sportsman EPS	10-14	F&R	850 Sportsman Forest	12-15	F&R
550 Sportsman	11-13	F&R	850 Sportsman SP	15-18	F&R
550 Sportsman XP	09-13	F&R	850 Sportsman Touring SP	15-18	F&R
550 Sportsman XP Touring EPS	12	F&R	850 Sportsman XP Touring EPS	12	F&R
550 Sportsman X2 EPS	14	F&R	1000 Forest	15	F&R
570 Forest Tractor Efi/EPS	15	R	1000 Scrambler	15-21	F&R
570 Sportsman Efi (Inc EPS models)	11-21	R	1000 XP Scrambler	19-20	F&R
570 Sportsman Touring Efi	14-21	R	1000 Sportsman MD/XP	15-19	F&R
570 Sportsman Touring Tractor Efi EPS	16-21	R	1000 Sportsman XP 55 inc S 55" model	20-21	F&R
570 Sportsman Efi HD	14-18	R	1000 Sportsman XP Tractor	16-21	F&R
570 Sportsman Efi UTE	14-18	R	1000 Sportsman Touring	15-20	F&R
570 Sportsman Efi X2 EPS	15-18	R	1000 Sportsman Touring Tractor	16-21	F&R
570 Sportsman SP	15-18	R	1000 Sportsman XP High Lifter	19	F&R
570 Sportsman SP Touring	15-18	R			

FA476 A 104 x 43.5 x 13mm B 104 x 43.5 x 13mm

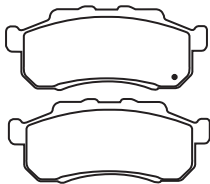

MATERIAL AVAILABILITY											
FA	TT	V	R	HH	MXS	SXR	EPFA	GPFA	SFA	SFAC	SFAHH
	✓										

HONDA

MUV 700-9 Big Red Side x Side 09 F Left

FA477 A 104 x 43.5 x 13mm B 104 x 43.5 x 13mm

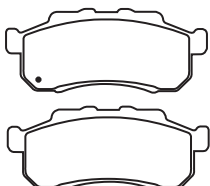

MATERIAL AVAILABILITY											
FA	TT	V	R	HH	MXS	SXR	EPFA	GPFA	SFA	SFAC	SFAHH
	✓										

HONDA

MUV 700-9 Big Red Side x Side 09F Right

DO NOT REFIT ANY SHIMS/INSULATORS TO EBC PADS FROM ORIGINAL PADS UNLESS INSTRUCTED ON NOTE ON PAD PACKAGING AND ON FA DRAWING ASSOCIATED WITH THAT PAD.

DO NOT REFIT ANY SHIMS/INSULATORS TO EBC PADS FROM ORIGINAL PADS UNLESS INSTRUCTED ON NOTE ON PAD PACKAGING AND ON FA DRAWING ASSOCIATED WITH THAT PAD.

FA478 A 89 x 36.5 x 14mm
B 89 x 36.5 x 14mm

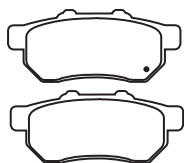

MATERIAL AVAILABILITY											
FA	TT	V	R	HH	MXS	SXR	EPFA	GPFAX	SFA	SFAC	SFAHH
	✓										

HONDA
MUV 700-9 Big Red Side x Side 09 R Left

FA479 A 89 x 36.5 x 14mm
B 89 x 36.5 x 14mm

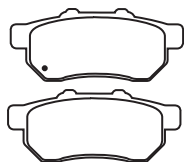

MATERIAL AVAILABILITY											
FA	TT	V	R	HH	MXS	SXR	EPFA	GPFAX	SFA	SFAC	SFAHH
	✓										

HONDA
MUV 700-9 Big Red Side x Side 09R Right

FA480 A 74 x 36.5 x 7mm
B 38 x 27 x 9mm



MATERIAL AVAILABILITY											
FA	TT	V	R	HH	MXS	SXR	EPFA	GPFAX	SFA	SFAC	SFAHH
✓											

LIFAN LF 125 Off Road 07 R **STOMP MINI MOTO** 125cc Elite 07-09 R
QUADZILLA WK 140 06-08 R

FA481 88 x 48 x 8mm



MATERIAL AVAILABILITY											
FA	TT	V	R	HH	MXS	SXR	EPFA	GPFAX	SFA	SFAC	SFAHH
✓											

QUADZILLA
CUV 300 E 4x4 Side by Side (Parking brake)08-09

FA482 110 x 49.5 x 8mm



MATERIAL AVAILABILITY											
FA	TT	V	R	HH	MXS	SXR	EPFA	GPFAX	SFA	SFAC	SFAHH
	✓		✓								

KEEWAY GTX 300 Quad 10-11 R **QUADZILLA** CUV 300 (4x4 Super Utility Side x Side) 08 F
LINHAI CUV 300 4x4 "Side x Side" 08-09 F
CUV Jobber 4x4 13 F 325 4x4 10-11 R

FA483 96.5 x 41 x 7mm



MATERIAL AVAILABILITY											
FA	TT	V	R	HH	MXS	SXR	EPFA	GPFAX	SFA	SFAC	SFAHH
	✓		✓								

KEEWAY GTX 300 Quad 10 F
QUADZILLA QZ 300 E 4x4 F
QZ 320 E 4x4 09 F
325 4x4 10-11 F

FA484 A. 116.5 x 42 x 9.5mm
B. 77 x 42 x 9.5mm

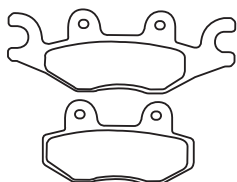

MATERIAL AVAILABILITY											
FA	TT	V	R	HH	MXS	SXR	EPFA	GPFAX	SFA	SFAC	SFAHH
	✓		✓						✓		

CECTEK 500 EFI King Cobra 09-10 F X-Motion 125 08-14 F
500 EDI Quadrift 09-10 F X-Motion 125 Ri 11-12 F
500i Estoc 10 F X-Motion 250 i 08-10 F
PGO X-Motion 300 EFI 10-12 F
BR 500i Racer 07-09 F
500 Bug 08-09 F
BR 600 I Bug Racer 12 F

FA485 A. 32 x 39 x 5mm
B. 35 x 31.5 x 5mm

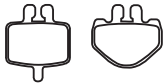

MATERIAL AVAILABILITY												
FA	TT	V	R	HH	MXS	SXR	EPFA	GPFAX	SFA	SFAC	SFAHH	
	✓											

HAMMERHEAD BUGGIES

Mini (45cc) 08-09 R

QUADZILLA

Micro Buggy MKII/III (RV50) 05-09 R

FA486 49.5 x 47 x 9mm



MATERIAL AVAILABILITY												
FA	TT	V	R	HH	MXS	SXR	EPFA	GPFAX	SFA	SFAC	SFAHH	
✓												

BETTER

BT 125-20 06-09 F

HONGDOU

GHD 125-7 05-07 F

KYMCO

CK 125 Pulsar 99-00 F

ZING BIKES

Vogue 150 (3 wheeler) 08-09 F

FA488 A 99.5 x 38.5 x 9mm
B 99.5 x 38.5 x 9mm

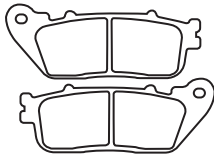

MATERIAL AVAILABILITY												
FA	TT	V	R	HH	MXS	SXR	EPFA	GPFAX	SFA	SFAC	SFAHH	
				✓								

HONDA

VFR 800 F (ABS Model) 14-18 R Non ABS Model 09-15 R

VFR 800 XB/XC/XD (Crossrunner/ABS) 11-13 R /RAE/RAF/RAG (ABS Model) 09-16 R

VFR 800 XF/XG/XH/XJ (Crossrunner/ABS) 15-18 R CB 1000 R 17-21 R

CB 1000 R9/RA/RB/RC/RD/RE/RF VFR 1200 FAA/FAB/FAC/FAE 10-16 R

CB 1000 R9/RA/RB/RC/RD/RE/RF VFR 1200 FA - GT 14-15 R

FA489 88.5 x 46.5 x 8mm



MATERIAL AVAILABILITY												
FA	TT	V	R	HH	MXS	SXR	EPFA	GPFAX	SFA	SFAC	SFAHH	
			✓									

POLARIS

Ranger RZR 170 09-14 R

FA490 87 x 42.5 x 8mm



MATERIAL AVAILABILITY												
FA	TT	V	R	HH	MXS	SXR	EPFA	GPFAX	SFA	SFAC	SFAHH	
			✓									

POLARIS

Ranger RZR 170 09-14 F 200 Phoenix Quadricycle Model

200 Phoenix (Rear drum model) 10-14 F (Rear disc model) 10 F

FA491 78 x 46 x 7.5mm



MATERIAL AVAILABILITY												
FA	TT	V	R	HH	MXS	SXR	EPFA	GPFAX	SFA	SFAC	SFAHH	
				✓			✓	✓				

TRIUMPH (Hinckley Produced Models)

Daytona 675 09-17 F

SFA492 A 109.5 x 51 x 9.5mm
B 114 x 41.5 x 9mm

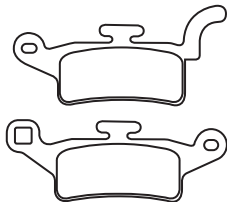

MATERIAL AVAILABILITY												
FA	TT	V	R	HH	MXS	SXR	EPFA	GPFAX	SFA	SFAC	SFAHH	
									✓	✓		

YAMAHA

HW125/Xenter 125 12-18 F YW 125 Z X-Over 10 F

YW 125 (BW's 125) 10-13 F

HW150/Xenter 150 12-17 F

FA495 35.5 x 42 x 5.5mm



MATERIAL AVAILABILITY												
FA	TT	V	R	HH	MXS	SXR	EPFA	GPFAX	SFA	SFAC	SFAHH	
✓												

BETA

Evo 80 09-15 R Evo 250 (4T/2T) 09-15 R

Evo 125 (2T) 09-15 R Trial Evo 250 (2T) MY20 Inc GB 20 R

Trial Evo 125 (2T) MY20 20 R Evo 300 (2T) 09-15 R

Evo 200 (2T) 09-15 R Trial Evo 300 (2T) MY20 Inc GB and SS 20 R

Trial Evo 200 (2T) MY20 20 R Evo 300 (4T) 09-15 R

DO NOT REFIT ANY SHIMS/INSULATORS TO EBC PADS FROM ORIGINAL PADS UNLESS INSTRUCTED ON NOTE ON PAD PACKAGING AND ON FA DRAWING ASSOCIATED WITH THAT PAD.

FA496 86 x 40 x 9mm

MATERIAL AVAILABILITY												
FA	TT	V	R	HH	MXS	SXR	EPFA	GPFAX	SFA	SFAC	SFAHH	
✓		✓		✓								

HONDA													
CB 300 FAF/FAG (ABS)				15	R		NC 750 S					14-15	R
CBR 250 RRL/RRN/RRR (MC22)				90-92	R		NC 750 S ABS					14-18	R
CBR 250 RB (Non ABS)				11-13	R		NC 750 S ABS DCT					14-18	R
CBR 250 RAB/RAC (ABS)				11-13	R		NC 750 X					14-15	R
CBR 300 RA (ABS)				15-21	R		NC 750 X ABS					14-21	R
CBR 300 R Non ABS				18-20	R		NC 750 X ABS DCT					14-21	R
CB 300 F ABS				18-20	R		750 Integra (Scooter) (NC 750 DDE)					14-18	R
CB 300 R				18-21	R		750 Integra S Scooter (NC 750 DDSE)				14	14	R
CMX 300 Rebel/Rebel ABS				18-21	R		SINNIS						
CB 500 F (Non ABS)				13-20	R		RSX 125					19-20	R
CMX 500 Rebel				17-21	R		SUZUKI						
CB 650 FE/FG				14-16	R		DL 250 V-Strom (ABS)					18-21	R
CB 650 FAE/FAF/FAG/FAH/FAJ (ABS)				14-20	R		GSX 250 RL7/RL8					17-18	R
CB 650 R				19-21	R		GW 250 L3/FL5 Inazuma					13-15	R
CBR 650 FE/FG/FH (Non ABS)				14-20	R		GW 250 FL5 Inazuma					15	R
CBR 650 FAE/FAF/FAG/FAH/FAJ (ABS)				14-20	R		SVF 650 K9/L0/L1-L5 Gladius					09-15	R
CBR 650 RR				19-21	R		SVF 650 AK9/AL0/AL1-AL5 (ABS)					09-15	R
ADV 750 H (ADV X DCT)				17-21	R		SV 650 ABS					16-21	R
							SV 650 X ABS					18-21	R

FA497 62 x 41 x 7mm

MATERIAL AVAILABILITY												
FA	TT	V	R	HH	MXS	SXR	EPFA	GPFAX	SFA	SFAC	SFAHH	
	✓											

YAMAHA													
YXR 700 Rhino 4x4 SE				09	PB		YXC 700 E Viking VI EP					15-18	PB
YXR 700 FA/FB/FD Rhine Side x Side				11-13	PB		(YXC 700 PF/PXG/PXH/PXJ)					16	PB
YXM 700 E Viking EPS COMO							YXZ 1000 R EPS (Side x Side)					16	PB
(YXM70VPHG)				16	PB		YXZ 1000 R SE (Side x Side)					17-18	PB
YXM 700 E Wolverine R (YXE70WPHG)				16	PB		YXZ 1000 R SS (Side x Side)					17-18	PB
YXM 700 ES - Viking EPS SE													
(YXM 700 PSE)				14-16	PB								

SFA498 90 x 33.5 x 10mm

MATERIAL AVAILABILITY												
FA	TT	V	R	HH	MXS	SXR	EPFA	GPFAX	SFA	SFAC	SFAHH	
									✓	✓	✓	

BENELLI													
Velvet 125/150 (Touring)				08-11	R		J300 BEF/BFF/BGF/CHF/CJF (ABS)					14-21	R
KAWASAKI							J300 BEFA/BFFA/BGFA/CHFA/CJFA						
J 125 ABS (SC125 AGF/BGF/CGF/CHF/CJF)				16-21	R		Special Edition (ABS)					14-21	R
J 125 SE/ABS (SC125 AGFA/BGFA/CGFA/CHFA/CJFA)				16-21	R		KYMCO						
J300 AEF/AFF/AGF (Non ABS)				14-16	R		Downtown/Superdink 125i (V21000)					09-14	R
J300 AEFA/AFFA/AGFA Special Edition (Non ABS)				14-16	R		Downtown 200i					10-14	R
							Downtown/Superdink 300i (V20000)					09-12	R
							Downtown 300i (ABS/V20010)					10-14	R

**FA499/4 A 69 x 51.5 x 9mm
B 33 x 51.5 x 9mm**

MATERIAL AVAILABILITY												
FA	TT	V	R	HH	MXS	SXR	EPFA	GPFAX	SFA	SFAC	SFAHH	
				✓								

HONDA													
VFR 1200 FAA/FAD/FAC/FAE				10-14	F		VFR 1200 FA - GT					14-15	F
VFS 1200 FADE/FADB/FADC/FADE (Automatic transmission)				10-14	F		VFR 1200 FAD - DCT/GT					14-15	F

FA600 102.5 x 42.5 x 8mm

MATERIAL AVAILABILITY												
FA	TT	V	R	HH	MXS	SXR	EPFA	GPFAX	SFA	SFAC	SFAHH	
	✓		✓									

KYMCO ATV													
MXU 500i (4x4 IRS) (LAAOCD/CM)				09-14	F		MXU 550i (4x4 LOF)					13-20	F
MXU 500i DX				11-13	F		MXU 700i (4x4 LOF)					13-21	F
MXU 550i				12-15	F		UXV 700i Turf					14-15	F

FA600/2 102.5 x 42.5 x 7mm

MATERIAL AVAILABILITY												
FA	TT	V	R	HH	MXS	SXR	EPFA	GPFAX	SFA	SFAC	SFAHH	
	✓		✓									

KYMCO ATV													
MXU 500i (4x4 IRS) (LAAOCD/CM)				09-14	R		MXU 550i (4x4 LOF)					13-20	R
MXU 500i DX				11-13	R		MXU 700i (4x4 LOF)					13-18	R
MXU 550i				12-15	R		UXV 700i Turf					14-15	R

FA602 41 x 42.5 x 7.5mm



MATERIAL AVAILABILITY												
FA	TT	V	R	HH	MXS	SXR	EPFA	GPFA	SFA	SFAC	SFAHH	
	✓		✓									
HUSQVARNA						SX 85 (17"/14" wheels)		11-21		R		
CR 65						11-13 R SX 85 (19"/16" wheels)		11-21		R		
TC 85 (2T) (17"/14" wheels)						14-21 F 250 Freeride R (2T)		14-15		R		
TC 85 (2T) (19"/16" wheels)						14-21 F 350 Freeride (4T)		12-15		R		
KTM						OHVALE						
Freeride E-SM						15-17 R GP-0 110,160		19-20		R		
Freeride E-SX						15-17 R SWM						
Freeride E-XC						15-20 R MC 650 R		18		R		

SFA603 A 111.5 x 43 x 8mm B 109.5 x 43 x 8mm

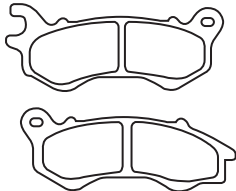

MATERIAL AVAILABILITY												
FA	TT	V	R	HH	MXS	SXR	EPFA	GPFA	SFA	SFAC	SFAHH	
									✓	✓	✓	
HONDA						Django 50 Sport (2T/4T)		14-21		F		
NSC 50 MPDC/E/F/G/H/J						Django 50 S (2T)		14-18		F		
Vision 50 (4T) (16" wheels)						12-18 F Django 50 S (4T)		14-18		F		
NSC 50 WHC/T2E/F Vision 50 (4T) (14" wheels)						12-16 F Django 125 Allure (4T)		14-21		F		
NSC 50 R (14" wheels)						13-16 F Django 125 Allure SBC (4T/190mm Rear Disc)		14-21		F		
NSC 110 WHB/E Vision 110 (4T)						11-16 F Django 125 Evasion (4T)		14-21		F		
NSC 110 MPDC/E "Vision" (16" Wheels)						12-14 F Django 125 Evasion SBC (4T/190mm Rear Disc)		14-21		F		
SCV 110 (NHX 110 WHA) 4 bolt disc fixing						10-12 F Django 125 Heritage SBC (4T/190mm Rear Disc)		14-21		F		
PCX 125 (WW 125 EX2 C/D/F/H/J)						12-18 F Django 125 Sport (4T)		14-21		F		
SH 125i Mode (ANC 125 E)						14-20 F Django 125 Sport SBC (4T/190mm Rear Disc)		14-21		F		
PCX 150 (WW 150 EXC2)						12-20 F Django 125 S (4T/190mm Rear Disc)		14-21		F		
PCX 150 (ABS)						18-20 F Django 125 S (4T/190mm Rear Disc)		14-21		F		
KYMCO						Satelis 125 (4T)		13		F		
People One 125i						16-20 F Django 150 Allure (4T)		14-21		F		
LEXMOTO						Django 150 Evasion (4T)		14-21		F		
Adrenaline 125 EFI (XFLM125GY-2B-E4)						15-18 F Django 150 Sport (4T)		14-21		F		
Enigma ZS 125 T-48 Euro 4 Scooter						18-20 F Django 150 S (4T) (4T/190mm Rear Disc)		14-21		F		
PEUGEOT						Speedfight 125 4 (4T)		17-21		F		
Django 50 Allure (2T/4T)						14-18 F Speedfight 125 4 I R-Cup SBC (4T)		18-21		F		
Django 50 Evasion (2T/4T)						14-21 F Speedfight 125 4 SBC (4T)		17-21		F		

FA604/4 35 x 40.5 x 8mm



MATERIAL AVAILABILITY												
FA	TT	V	R	HH	MXS	SXR	EPFA	GPFA	SFA	SFAC	SFAHH	
				✓			✓	✓				
BMW						TRIUMPH						
S 1000 R Naked (K47)						14-18 F Speed Triple 1050 (Non ABS)						
S 1000 RR (K46)(Disc has fixed bobbins)						10-18 F - From VIN461332		11-16		F		
S 1000 R/RR (Models fitted with Forged race wheels - 7 Spoke type)						10-18 F Speed Triple 1050 (ABS) - From VIN461332		09-16		F		
						Bonneville Street Twin 900cc		18-21		F		
						Bonneville Speed Twin (1200)		19-20		F		
						Daytona 765 Moto 2		20		F		

FA605/4 98 x 47 x 8mm



MATERIAL AVAILABILITY												
FA	TT	V	R	HH	MXS	SXR	EPFA	GPFA	SFA	SFAC	SFAHH	
		✓		✓								
HARLEY DAVIDSON®												
FLHTCUTG Tri Glide Ultra Classic Trike						09-12 R						
FLHXXX Street Glide Trike						10-11 R						

FA606 69.5 x 45 x 8.5mm



MATERIAL AVAILABILITY												
FA	TT	V	R	HH	MXS	SXR	EPFA	GPFA	SFA	SFAC	SFAHH	
✓				✓			✓					
BMW						Duke 250		15-20		F		
C 400 X						18 F 390 Adventure		20		F		
G 310 R						17-21 F Duke 390		13-20		F		
G 310 GS						17-21 F RC 390		14-15		F		
G 310 GS Edition 40						20-21 F 390 Duke (4T)		15		F		
KTM						RC 390 (4T)		15		F		
Duke 125 (4T)						11-18 F HUSQVARNA						
RC 125						14-20 F Vitpilen 125cc (4T)		21		F		
Duke 200 (4T)						12-15 F Vitpilen 401 (4T)		18-20		F		
RC 200						14-15 F						

SFA607 94 x 36 x 10.5mm

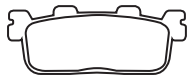

MATERIAL AVAILABILITY												
FA	TT	V	R	HH	MXS	SXR	EPFA	GPFAX	SFA	SFAC	SFAHH	
									✓			✓

KYMGCO				300i Agility Max ABS				15		R		
K-XCT 125				12-15		R		K-XCT 300i / ABS		12-15		R
Downtown 125i				15-20		R		Grand Dink 300i		12-20		R
People GT 125i				10-15		R		People GT 300i		10-15		R
People S125 DD (D1000 rear disc)				07-15		R		People S 300i		08-10		R
X Town 125i ABS				16-20		R		X Town 300i		17-20		R
X Town 125				16-18		R		Xciting 300i (T72000 - EFI Model)		08		R
People S200i DD (D12000)								Xciting 300i R (T72001/T72011)		09-14		R
(5 bolt fixing disc)				07-15		R		New Downtown 350i		15-20		R
People 250 Si DD				07-08		R		Xciting 500R (T70021 EFI model)		07-14		R
People GT 200i				10-14		R		YAMAHA				
Xciting 250 (T71000)				05		R		YP 400 RA X-MAX (ABS)		18-21		R
Xciting 250 i (T71010)				06-08		R		XP 400 X-Max Momo Design ABS		15		R

SFA608 102 x 38 x 10.5mm

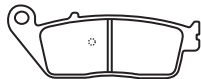

MATERIAL AVAILABILITY												
FA	TT	V	R	HH	MXS	SXR	EPFA	GPFAX	SFA	SFAC	SFAHH	
									✓			✓

KYMGCO				X-Citing 500i (T70020) (EFI Model)				06-08		R		
X-Citing 400i				12-20		R		X-Citing 500 (T70000) (Carb Model)		05		R
Xciting S 400i				17-20		R		Xciting Evo 500i ABS		13		R
X-Citing 500 Ri (T70021) (EFI Model)				09-15		R		MX Road 700i		12-15		R

FA609 98 x 42.5 x 7.5mm



MATERIAL AVAILABILITY												
FA	TT	V	R	HH	MXS	SXR	EPFA	GPFAX	SFA	SFAC	SFAHH	
			✓									

JCB (UTILITY VEHICLES)				JOHN DEERE (SIDE X SIDE)								
Groundhog 800 D (4x4)				08-09		F&R		HPX 4X4 Gator (Diesel)		10-11		F&R
Workmax 800 D (4x4)				10-14		F&R		XUV 620i Gator (Petrol)		10		F&R
Groundhog 1000 D (4x4)				08-09		F&R		XUV 625i Gator (Petrol)		11		R
Groundhog 6x4 1000 D				08-09		F&R		XUV 825i Gator (Petrol)		11		R
Workmax 1000 D (4x4)				10-14		F&R		XUV 850 D Gator (Diesel)		10		F&R
Workmax 6x4 1000 D				10-14		F&R		XUV 855 D Gator (Diesel)		11		R

FA610 135.5 x 55 x 8mm



MATERIAL AVAILABILITY												
FA	TT	V	R	HH	MXS	SXR	EPFA	GPFAX	SFA	SFAC	SFAHH	
			✓			✓						

JOHN DEERE (SIDE X SIDE)				ARTIC CAT (SIDE X SIDE)								
XUV 625i Gator (Petrol)				11		F		Wildcat 1000 4		13-14		F
XUV 825i Gator (Petrol)				11		F		Wildcat 1000 4X		14-16		F
XUV 855 D Gator (Diesel)				11		F		Wildcat 1000 4X LTD		14-15		F

GPFAX611HH 82 x 29 x 9.5mm



MATERIAL AVAILABILITY												
FA	TT	V	R	HH	MXS	SXR	EPFA	GPFAX	SFA	SFAC	SFAHH	
								✓				

BMW				S 1000 RR HP4 Race				17-18		F	
BREMBO				XA3.J7.50/51 - 4 Piston P34/38 Radial Mount @ 108mm Spacing (Pinless Fixing)							
				XA3.J7.60/61 - 4 Piston P 34/38 Radial Mount @ 108mm Spacing (Pinless Fixing/Lithium Body)							
				XA8.Y3.310/11 - 4 Piston P34/38 Radial Mount @ 130mm Spacing (Pinless Fixing)							

FA612 40 x 59 x 7.5mm



MATERIAL AVAILABILITY												
FA	TT	V	R	HH	MXS	SXR	EPFA	GPFAX	SFA	SFAC	SFAHH	
	✓		✓									

GAS-GAS				SX 85 19/16" wheels				12-21		F		
TXT 125/250/280/300 (For models with formula front caliper/single pin pad fixing)				12		F		250 Freeride R (2T)		14-15		F
								350 Freeride (4T)		12-15		F
HUSQVARNA				OHVALE								
TC 85 (2T) (17"/14" wheels)				14-21		F		GP-0 110,160		19-20		F
TC 85 (2T) (19"/16" wheels)				14-21		F		SHERCO				
KTM				ST 80/125/250 (2T/Formual Caliper)				13-14		F		
Freeride E-SM/E-SX				15-17		F		ST 290 Cabastany Replica				
Freeride E-XC				15-20		F		(2T/Formula Caliper)		12		F
SX 85 17/14" wheels				12-21		F		ST 290/305 (2T/Formula Caliper)		13-14		F

FA613 81 x 46 x 9.5mm



MATERIAL AVAILABILITY												
FA	TT	V	R	HH	MXS	SXR	EPFA	GPFA	SFA	SFAC	SFAHH	
				✓								

BMW

K1600 B Bagger	17-20	F	K 1600 GT SE	12-15	F
K1600 B Grand America	18-20	F	K 1600 GTL	11-18	F
K 1600 GT	11-18	F	K 1600 GTL Exclusive	13-16	F

FA617 A 109 x 39 x 9mm B 96.5 x 36.5 x 9mm

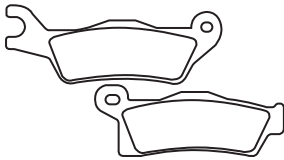

MATERIAL AVAILABILITY												
FA	TT	V	R	HH	MXS	SXR	EPFA	GPFA	SFA	SFAC	SFAHH	
	✓		✓									

CAN AM

Outlander 500 (STD)	13-14	F(Right)&R	Outlander Max 800 R 4x4 (STD/XT/XT-P)	13-14	F(Right)&R
Outlander 500 XT	13-14	F(Right)&R	Renegade 800 R STD	12-15	F(Right)&R
Outlander 500 4x4 (DPS/XT)	13-14	F(Right)&R	Renegade 800 R XXC	12-14	F(Right)&R
Outlander Max 500 4x4 (DPS)	13-14	F(Right)&R	Outlander 1000 STD	12	F(Right)&R
Outlander Max 500 XT	14	F(Right)&R	Outlander 1000 XT/XT-P	12-14	F(Right)&R
Renegade 500 (STD)	12-15	F(Right)&R	Outlander 1000 4x4 (DPS)	13	F(Right)&R
Outlander 650 4x4 (STD/DPS/XT)	13-15	F(Right)&R	Outlander 1000 4x4 (LTD)	13	F(Right)&R
Outlander 650Max 4x4 (STD/DPS/XT)	13-14	F(Right)&R	Outlander 1000 4x4 (XMR)	13-14	F(Right)&R
Outlander 800 R STD	12-15	F(Right)&R	Outlander Max 1000 4x4 (DPS/XT/XT-P/LTD/STD)	13-14	F(Right)&R
Outlander 800 R XT	12	F(Right)&R	Renegade 1000 STD	12-14	F(Right)&R
Outlander 800 R 4x4 (DPS)	13	F(Right)&R	Renegade 1000 XXC	12-14	F(Right)&R

FA618 A 109 x 39 x 7.5mm B 96.5 x 36.5 x 7.5mm

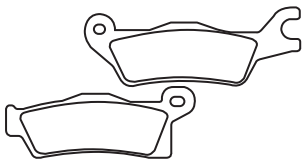

MATERIAL AVAILABILITY												
FA	TT	V	R	HH	MXS	SXR	EPFA	GPFA	SFA	SFAC	SFAHH	
	✓		✓									

CAN AM

Outlander 500 4x4 (DPS)	13-14	F&R(Left)	Outlander Max 800 R 4x4 (STD/XT/XT-P)	13-14	F&R(Left)
Outlander 500 (STD)	13-14	F&R(Left)	Renegade 800 R STD	12-15	F&R(Left)
Outlander 500 XT	13-14	F&R(Left)	Renegade 800 R XXC	12-14	F&R(Left)
Outlander Max 500 4x4 (DPS)	13-14	F&R(Left)	Outlander 1000 STD	12	F&R(Left)
Outlander Max 500 XT	14	F&R(Left)	Outlander 1000 XT	12-14	F&R(Left)
Renegade 500 (STD)	12-15	F&R(Left)	Outlander 1000 4x4 (DPS) XT/XT-P1	13	F&R(Left)
Outlander 650 4x4 (STD/DPS/XT)	13-15	F&R(Left)	Outlander 1000 4x4 (LTD)	13	F&R(Left)
Outlander 650 Max 4x4 (STD/DPS/XT)	13-14	F&R(Left)	Outlander 1000 4x4 (XMR)	13-14	F&R(Left)
Outlander 800 R STD	12-15	F&R(Left)	Outlander Max 1000 4x4 (DPS/XT/XT-P/STD)	13-14	F&R(Left)
Outlander 800 R XT	12-13	F&R(Left)	Renegade 1000 STD	12-14	F&R(Left)
Outlander 800 R 4x4 (DPS)	13-14	F&R(Left)	Renegade 1000 XXC	12-14	F&R(Left)

CFA619 33.5 x 30 x 4mm



MATERIAL AVAILABILITY												
FA	TT	V	R	HH	MXS	SXR	EPFA	GPFA	SFA	SFAC	SFAHH	
✓												

BULTACO

Brinco C/R/RE/S	15-17	F
-----------------	-------	---

SFA621 27.8mm Ø



MATERIAL AVAILABILITY												
FA	TT	V	R	HH	MXS	SXR	EPFA	GPFA	SFA	SFAC	SFAHH	
		✓										

YAMAHA

XP 500 T-Max (530cc Engine /Non ABS Models)	12-16	PB	XP 500 A T-Max - Lux Max (ABS)	16	PB
XP 500 A T-Max (530cc Engine /ABS Models)	12-16	PB	XP 530E-A T-Max (530cc Engine - ABS Model)	17-20	PB
XP 500 Black Bronze Max (59CE) (530cc engine Non & ABS models)	13-14	PB	XP 530-A T-Max SX (530cc Engine - ABS Model)	17-20	PB
XP 530 A (530cc Engine - Iron Max - ABS Model)	15-16	PB	XP 530D-A T-Max DX (530cc Engine - ABS Model)	17-20	PB
			T-Max 560 ABS	19-20	PB
			T-Max 560 ABS Tech Max	19-20	PB

FA622 77.5 x 42 x 7mm



MATERIAL AVAILABILITY												
FA	TT	V	R	HH	MXS	SXR	EPFA	GPFA	SFA	SFAC	SFAHH	
	✓		✓									

KIOTI/MECHRON (Side x Side)

2200 UTV (Side x Side)	09-14	F&R	2210 UTV (Side x Side)	11-14	F&R
2200 PS UTV (Side x Side)	14-15	F&R	2240 UTV (Side x Side)	14-15	F&R

FA623 84.5 x 59.5 x 10mm

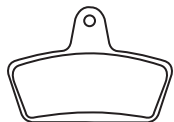

MATERIAL AVAILABILITY												
FA	TT	V	R	HH	MXS	SXR	EPFA	GPFAX	SFA	SFAC	SFAHH	
✓				✓								

HHI HAWG HALTERS AFTERMARKET CALIPERS
4 Piston Sprocket Brake

FA624 42 x 50 x 6.5mm



MATERIAL AVAILABILITY												
FA	TT	V	R	HH	MXS	SXR	EPFA	GPFAX	SFA	SFAC	SFAHH	
	✓											

HHI HAWG HALTERS AFTERMARKET CALIPERS
4 Piston Sprocket Brake

SFA625 A. 85 x 44 x 7mm B. 74.5 x 41.5 x 7mm



MATERIAL AVAILABILITY												
FA	TT	V	R	HH	MXS	SXR	EPFA	GPFAX	SFA	SFAC	SFAHH	
									✓			

HONDA
AFS 110 2SHC/CSFF Wave 12-16 F
NSC 110 MPDH Vision (16" Wheels) 17 F

SFA627 72.5 x 53.5 x 8mm

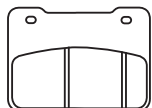

MATERIAL AVAILABILITY												
FA	TT	V	R	HH	MXS	SXR	EPFA	GPFAX	SFA	SFAC	SFAHH	
									✓		✓	

AEON
Elite 400i (ABS) 14-15 F

SYM
SB 250 Ni (Wolf SB) 12-15 F
Max Sym 400i (Inc ABS) 11-21 F
Max Sym 600i (ABS) 14-15 F

SFA628 83.5 x 47.5 x 12mm

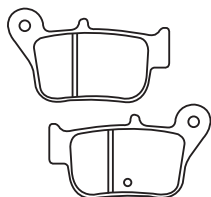

MATERIAL AVAILABILITY												
FA	TT	V	R	HH	MXS	SXR	EPFA	GPFAX	SFA	SFAC	SFAHH	
✓												

SYM
Max Sym 400i (Inc ABS) 11-21 R
Max Sym 600i (ABS) 14-15 R

FA629 88 x 40 x 10mm

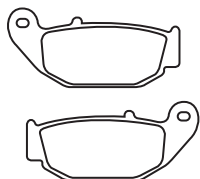

MATERIAL AVAILABILITY												
FA	TT	V	R	HH	MXS	SXR	EPFA	GPFAX	SFA	SFAC	SFAHH	
✓	✓		✓	✓								

BENELLI
TNT 125 (Tornado Naked T 125cc) 17-21 R CRF 250 L ABS 17-21 R
TNT 135 (Tornado Naked T 135cc) 18 R CRF 300 L ABS 20-21 R
TNT 200 (Tornado Naked T 200cc) 17-18 R CRF 250 Rally 17-20 R
BN125 18-21 R CRF 250 Rally ABS 17-21 R
HONDA
CB 125 R 18-21 R CRF 300 Rally ABS 20-21 R
CB 125 F (GLR 125 1WHH) 17-21 R CRF 250 ME Supermoto 14-15 R
CB 300 R 18 R
CBR 125 RWB/RC/RD/RF/RG
(5 bolt front disc/Canada) 11-16 R
SUZUKI
MSX 125 D/E/F/G/H Grom (Non ABS) 13-21 R GSX-R 125 RLXL8/RLL8 18-21 R
MSX 125 AH Grom (ABS) 18-21 R GSX-S 125 MLXL8/MLL8 18-21 R
CBF 150 SH 07-10 R GSX-R 150 FRFAL7/FRZAL7 17-20 R
CBF 150 MB/MC Unicorn (Cast Wheels) 11-12 R GSX-R 150 RF-Q/RFX-Q 17-20 R
CB 190 R (CBF190WH) 16-18 R GSX-R 150 RFL8/RFXL8/RFXL9 18-20 R
CRF 250 L 13-20 R GSX-S 150 MFL8/MFXL8/MFXL9 18-20 R

DO NOT REFIT ANY SHIMS/INSULATORS TO EBC PADS FROM ORIGINAL PADS UNLESS INSTRUCTED ON NOTE ON PAD PACKAGING AND ON FA DRAWING ASSOCIATED WITH THAT PAD.

FA634 64 x 45 x 10.5mm



MATERIAL AVAILABILITY												
FA	TT	V	R	HH	MXS	SXR	EPFA	GPFAX	SFA	SFAC	SFAHH	
	✓											

AJP												
PR3 125 Trial				13-15	R		PR3 200 Enduro Pro				12-14	R
PR3 125 Enduro				13-15	R		PR3 200 M/X Pro				12-14	R
PR3 125 Enduro Pro				13-15	R		PR3 200 Supermoto				12-14	R
PR3 125 Supermoto				13-15	R		PR4 200 Enduro				12-14	R
PR3 240 MX Pro				13-15	R		PR4 200 Extreme				12-14	R
PR4 125 Enduro				13-15	R		PR4 200 Supermoto				12-14	R
PR4 125 Enduro Pro				13-15	R		PR4 200 Enduro Pro				12-14	R
PR4 125 Extreme				13-15	R		PR4 240 Extreme				13-15	R
PR4 125 Supermoto				13-15	R		PR5 250 Enduro				10-15	R
PR3 200 Enduro				12-14	R		PR5 250 Extreme				10-15	R
							PR5 250 Supermoto				10-15	R

SFA635 A. 96.5 x 43 x 7.5mm B. 77 x 42 x 7.5mm

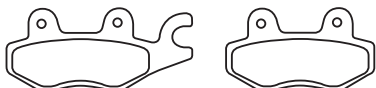

MATERIAL AVAILABILITY												
FA	TT	V	R	HH	MXS	SXR	EPFA	GPFAX	SFA	SFAC	SFAHH	
									✓			

PEUGEOT												
VOX 110				12-13	F							

FA636 102 x 40 x 9.5mm

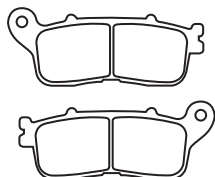

MATERIAL AVAILABILITY												
FA	TT	V	R	HH	MXS	SXR	EPFA	GPFAX	SFA	SFAC	SFAHH	
				✓								

HONDA							Crosstourer (Manual G/Box)				12-18	R
VFR 1200 Crosstourer Highlander							VFR 1200 XDC/XCD/XDE/XDF/XDG					
-T/DCT				15-16	R		/XDH/XDJ DCT Crosstourer				12-18	R
VFR 1200 XAC/XAD/XAE/XAF/XAH/XAJ							VFR 1200 FAD DCT				10-17	R

FA638 174 x 50 x 8.5mm

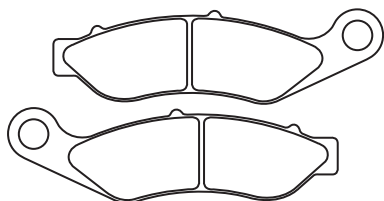

MATERIAL AVAILABILITY												
FA	TT	V	R	HH	MXS	SXR	EPFA	GPFAX	SFA	SFAC	SFAHH	
		✓		✓								

HARLEY DAVIDSON												
FLRT Freewheeler Trike				15-20	F							
FLHTCUTG Trike Tri Glide Ultra				14-20	F							

FA640 118 x 47.5 x 9mm

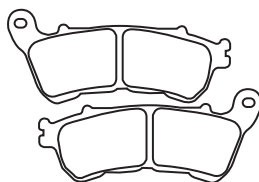

MATERIAL AVAILABILITY												
FA	TT	V	R	HH	MXS	SXR	EPFA	GPFAX	SFA	SFAC	SFAHH	
✓		✓		✓								

HARLEY DAVIDSON							XL 1200 CX Roadster				16-20	F
XL 883 L (Cast Wheels)				14-20	F		XL 1200 T Superlow				14-20	F
XL 883 N Iron (Cast Wheels)				14-20	F		XL 1200 V Seven Two				14	F
XL 883 R Roadster (Cast Wheels)				14	F		XL 1200 X Forty Eight				14-17	F
XL 1200 C Custom (Spoke Wheels)				14-20	F		XL 883 N				16	F

FA641/4 88 x 43 x 8.7mm



MATERIAL AVAILABILITY												
FA	TT	V	R	HH	MXS	SXR	EPFA	GPFAX	SFA	SFAC	SFAHH	
		✓		✓								

HARLEY DAVIDSON												
FLRT Freewheeler Trike				15-20	R							
FLHTCUTG Trike Tri Glide Ultra				14-20	R							

FA642 A 104 x 46 x 8.5mm B 88 x 46 x 8.5mm

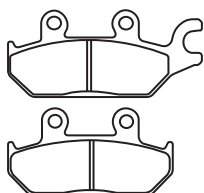

MATERIAL AVAILABILITY												
FA	TT	V	R	HH	MXS	SXR	EPFA	GPFAX	SFA	SFAC	SFAHH	
✓	✓		✓								✓	

YAMAHA												
YXM 700 E Viking EPS COMO												
(YXM70VPHG)				16	F(left)							
YXM 700 E Wolverine R (YXE70WPHG)				16	F(left)							
YXM 700 ES - Viking EPS SE												
(YXM700PSE)				14-16	F(left)							
YXC 700 E Viking VI EP												
(YXC700PF/PXG/PXH/PXJ)				15-18	F(left)							
CAN AM (SIDE X SIDE)												
Commander Max 1000 DPS/XT											14	F(left)
Maverick Max 1000 STD/XRS/DPS											14-15	F(left)

FA643 A 94 x 37.5 x 9mm
B 94 x 37.5 x 9mm



MATERIAL AVAILABILITY												
FA	TT	V	R	HH	MXS	SXR	EPFA	GPFAX	SFA	SFAC	SFAHH	
✓		✓		✓								

HARLEY DAVIDSON

XG 500 Street (549cc X-Engine) 14-15 F&R
XG 750 Street (749cc X-Engine) 14-15 F&R

FA644 56 x 32 x 5mm



MATERIAL AVAILABILITY												
FA	TT	V	R	HH	MXS	SXR	EPFA	GPFAX	SFA	SFAC	SFAHH	
	✓											

MONTESA-HONDA

260 4RT Cota (Repsol Edition 2E/4E) 14-21 F
4 Ride Enduro (260cc/4T) 16-18 F
Cota 300 RR (4T) 16-21 F

GAS GAS

TXT Replica Factory Models 125/250 /280/300 (2T Monobloc Caliper) 13-14 F
TXT Racing 125/250/280/300 (2T Monobloc Caliper) 14-19 F

FA645 A 104 x 46 x 8.5mm
B 88 x 46 x 8.5mm

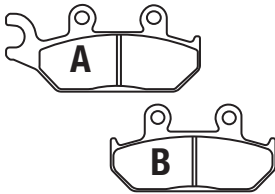

MATERIAL AVAILABILITY												
FA	TT	V	R	HH	MXS	SXR	EPFA	GPFAX	SFA	SFAC	SFAHH	
	✓		✓			✓						

YAMAHA

YXM 700 E Viking EPS COMO (YXM70VPHG) 16 F(right)
YXM 700 E Wolverine R (YXE70WPHG) 16 F(right)
YXM 700 ES - Viking EPS SE (YXM700PSE) 14-16 F(right)
YXC 700 E Viking VI EP (YXC700PF/PXG/PXH/PXJ) 15-18 F(right)

CAN AM (SIDE X SIDE)

Commander Max 1000 DPS/XT 14 F(right)
Maverick Max 1000 STD/XRS/DPS 14-15 F(right)

GFA646HH 94 x 34 x 11.5mm

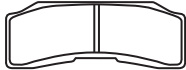

MATERIAL AVAILABILITY												
FA	TT	V	R	HH	MXS	SXR	EPFA	GPFAX	SFA	SFAC	SFAHH	
								✓				

BREMBO AFTERMARKET CALIPER

XB2P710/XB2P711

FA649 99 x 55 x 8.5mm

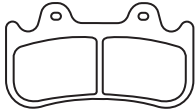

MATERIAL AVAILABILITY												
FA	TT	V	R	HH	MXS	SXR	EPFA	GPFAX	SFA	SFAC	SFAHH	
				✓								

JAYBRAKE CALIPER

6 PF-L (6 Piston for 11.5" disc - Lower Height Friction)

SFA650 97 x 39 x 7mm



MATERIAL AVAILABILITY												
FA	TT	V	R	HH	MXS	SXR	EPFA	GPFAX	SFA	SFAC	SFAHH	
									✓	✓	✓	

PEUGEOT

Metropolis 400 T (3 Wheel Model) 14-16 F&R
Metropolis 400 T-RS (3 Wheel Model) 14-16 F&R
Metropolis 400 Blue Line (3 Wheel Model) 15-16 F&R

FA651 72.5 x 30.5 x 10mm



MATERIAL AVAILABILITY												
FA	TT	V	R	HH	MXS	SXR	EPFA	GPFAX	SFA	SFAC	SFAHH	
✓	✓		✓			✓						

CF MOTO





CF 500 US Z -Force 550 (Side x Side) 15 R (Left) & R (Right)
500 C-Force 17-19 R (Left) & R (Right)
CF 600 Z -Force Z6 (Side x Side) 13-15 R (Left) & R (Right)
CF 600 Z -Force Z6-EX (Side x Side) 13-15 R (Left) & R (Right)
600 C-Force 17-19 R (Left) & R (Right)
500 C-Force 17-19 R (Left) & R (Right)
CF 800 Z -Force Z8 (Side x Side) 13-15 R (Left) & R (Right)
CF 800 Z -Force Z8-EX (Side x Side) 14-15 R (Left) & R (Right)
950 Z-Force 20 R (Left) & R (Right)
1000 U-Force 20 R (Left) & R (Right)

QUADZILLA

Z8 4 X 4 (Side x Side /800cc) 14-15 R (Left) & R (Right)

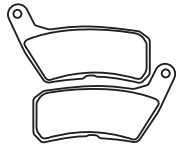
DO NOT REFIT ANY SHIMS/INSULATORS TO EBC PADS FROM ORIGINAL PADS UNLESS INSTRUCTED ON NOTE ON PAD PACKAGING AND ON FA DRAWING ASSOCIATED WITH THAT PAD.

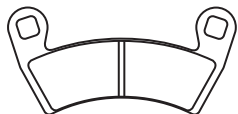
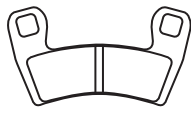
DO NOT REFIT ANY SHIMS/INSULATORS TO EBC PADS FROM ORIGINAL PADS UNLESS INSTRUCTED ON NOTE ON PAD PACKAGING AND ON FA DRAWING ASSOCIATED WITH THAT PAD.

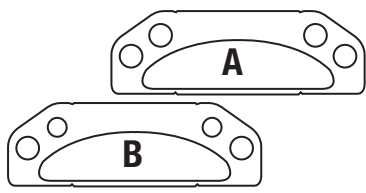
<p>SFA652 A. 85 x 44 x 9mm B. 75.5 x 40.5 x 9mm</p> 	<p>MATERIAL AVAILABILITY</p> <table border="1" style="width: 100%; border-collapse: collapse;"> <thead> <tr> <th>FA</th><th>TT</th><th>V</th><th>R</th><th>HH</th><th>MXS</th><th>SXR</th><th>EPFA</th><th>GPFAX</th><th>SFA</th><th>SFAC</th><th>SFAHH</th> </tr> </thead> <tbody> <tr> <td></td><td></td><td></td><td></td><td></td><td></td><td></td><td></td><td></td><td style="text-align: center;">✓</td><td></td><td></td> </tr> </tbody> </table> <p>SUZUKI UK 110 Address 17-21</p> <p>YAMAHA Tricity 125 14-21 F (Left)</p>	FA	TT	V	R	HH	MXS	SXR	EPFA	GPFAX	SFA	SFAC	SFAHH										✓																																																																										
FA	TT	V	R	HH	MXS	SXR	EPFA	GPFAX	SFA	SFAC	SFAHH																																																																																						
									✓																																																																																								
<p>FA654 73.5 x 42 x 6.5mm</p> 	<p>MATERIAL AVAILABILITY</p> <table border="1" style="width: 100%; border-collapse: collapse;"> <thead> <tr> <th>FA</th><th>TT</th><th>V</th><th>R</th><th>HH</th><th>MXS</th><th>SXR</th><th>EPFA</th><th>GPFAX</th><th>SFA</th><th>SFAC</th><th>SFAHH</th> </tr> </thead> <tbody> <tr> <td style="text-align: center;">✓</td><td></td><td></td><td></td><td></td><td></td><td></td><td></td><td></td><td></td><td></td><td></td> </tr> </tbody> </table> <p>HM CRE 50 Six Competition 07-12 F CRM 125 (Derapage Competition 2T) 11-12 F CRM 50 (Derapage Competition) 09-12 F CRM F 125 X (Derapage Competition 4T) 10-11 F CRE F 125 X Six 4T 10-11 F</p>	FA	TT	V	R	HH	MXS	SXR	EPFA	GPFAX	SFA	SFAC	SFAHH	✓																																																																																			
FA	TT	V	R	HH	MXS	SXR	EPFA	GPFAX	SFA	SFAC	SFAHH																																																																																						
✓																																																																																																	
<p>SFA655 A. 85 x 44 x 9mm B. 74.5 x 41.5 x 9mm</p> 	<p>MATERIAL AVAILABILITY</p> <table border="1" style="width: 100%; border-collapse: collapse;"> <thead> <tr> <th>FA</th><th>TT</th><th>V</th><th>R</th><th>HH</th><th>MXS</th><th>SXR</th><th>EPFA</th><th>GPFAX</th><th>SFA</th><th>SFAC</th><th>SFAHH</th> </tr> </thead> <tbody> <tr> <td style="text-align: center;">✓</td><td></td><td></td><td></td><td></td><td></td><td></td><td></td><td></td><td style="text-align: center;">✓</td><td></td><td></td> </tr> </tbody> </table> <p>YAMAHA MW 125 Tricity Scooter 14-16 F (Right) MWS 125 Tricity Scooter (3 Wheeler) 17-18 F (Right)</p>	FA	TT	V	R	HH	MXS	SXR	EPFA	GPFAX	SFA	SFAC	SFAHH	✓									✓																																																																										
FA	TT	V	R	HH	MXS	SXR	EPFA	GPFAX	SFA	SFAC	SFAHH																																																																																						
✓									✓																																																																																								
<p>FA656 57 x 121 x 8mm</p> 	<p>MATERIAL AVAILABILITY</p> <table border="1" style="width: 100%; border-collapse: collapse;"> <thead> <tr> <th>FA</th><th>TT</th><th>V</th><th>R</th><th>HH</th><th>MXS</th><th>SXR</th><th>EPFA</th><th>GPFAX</th><th>SFA</th><th>SFAC</th><th>SFAHH</th> </tr> </thead> <tbody> <tr> <td></td><td style="text-align: center;">✓</td><td></td><td style="text-align: center;">✓</td><td></td><td></td><td style="text-align: center;">✓</td><td></td><td></td><td></td><td></td><td></td> </tr> </tbody> </table> <p>POLARIS</p> <table style="width: 100%;"> <tr> <td>325 Sportsman Ace</td><td>14</td><td>F</td><td>570 Ranger full size</td><td>17-19</td><td>F</td> </tr> <tr> <td>325 Sportsman Ace Efi</td><td>15</td><td>F</td><td>570 Ranger EPS Crew MD</td><td>18</td><td>F</td> </tr> <tr> <td>325 Sportsman Ace Euro</td><td>14-15</td><td>F</td><td>570 Ranger EFI Crew</td><td>17</td><td>F</td> </tr> <tr> <td>325 Sportsman Ace HD</td><td>15</td><td>F</td><td>RZR-4 XP 900</td><td>12-14</td><td>F</td> </tr> <tr> <td>570 Ranger Crew</td><td>14-19</td><td>F</td><td>RZR 1000 XP</td><td>14-21</td><td>F&R</td> </tr> <tr> <td>570 Sportsman Ace</td><td>15-20</td><td>F</td><td>RZR XP Turbo Inc Pro model</td><td>16-22</td><td>R</td> </tr> <tr> <td>570 Sportsman Ace Euro</td><td>15-20</td><td>F</td><td>RZR XP 4 Turbo</td><td>16-21</td><td>R</td> </tr> <tr> <td></td><td></td><td></td><td>RZR XP 4 Turbo</td><td>19-21</td><td>R</td> </tr> </table>	FA	TT	V	R	HH	MXS	SXR	EPFA	GPFAX	SFA	SFAC	SFAHH		✓		✓			✓						325 Sportsman Ace	14	F	570 Ranger full size	17-19	F	325 Sportsman Ace Efi	15	F	570 Ranger EPS Crew MD	18	F	325 Sportsman Ace Euro	14-15	F	570 Ranger EFI Crew	17	F	325 Sportsman Ace HD	15	F	RZR-4 XP 900	12-14	F	570 Ranger Crew	14-19	F	RZR 1000 XP	14-21	F&R	570 Sportsman Ace	15-20	F	RZR XP Turbo Inc Pro model	16-22	R	570 Sportsman Ace Euro	15-20	F	RZR XP 4 Turbo	16-21	R				RZR XP 4 Turbo	19-21	R																								
FA	TT	V	R	HH	MXS	SXR	EPFA	GPFAX	SFA	SFAC	SFAHH																																																																																						
	✓		✓			✓																																																																																											
325 Sportsman Ace	14	F	570 Ranger full size	17-19	F																																																																																												
325 Sportsman Ace Efi	15	F	570 Ranger EPS Crew MD	18	F																																																																																												
325 Sportsman Ace Euro	14-15	F	570 Ranger EFI Crew	17	F																																																																																												
325 Sportsman Ace HD	15	F	RZR-4 XP 900	12-14	F																																																																																												
570 Ranger Crew	14-19	F	RZR 1000 XP	14-21	F&R																																																																																												
570 Sportsman Ace	15-20	F	RZR XP Turbo Inc Pro model	16-22	R																																																																																												
570 Sportsman Ace Euro	15-20	F	RZR XP 4 Turbo	16-21	R																																																																																												
			RZR XP 4 Turbo	19-21	R																																																																																												
<p>FA657 97 x 47 x 8mm</p> 	<p>MATERIAL AVAILABILITY</p> <table border="1" style="width: 100%; border-collapse: collapse;"> <thead> <tr> <th>FA</th><th>TT</th><th>V</th><th>R</th><th>HH</th><th>MXS</th><th>SXR</th><th>EPFA</th><th>GPFAX</th><th>SFA</th><th>SFAC</th><th>SFAHH</th> </tr> </thead> <tbody> <tr> <td></td><td style="text-align: center;">✓</td><td></td><td style="text-align: center;">✓</td><td></td><td></td><td style="text-align: center;">✓</td><td></td><td></td><td></td><td></td><td></td> </tr> </tbody> </table> <p>POLARIS RZR 900 (50 Inch All Options) 15-19 F RZR 1000 60 Inch Options 16-19 F RZR-S 900 (60 Inch All Options) 15-19 F</p>	FA	TT	V	R	HH	MXS	SXR	EPFA	GPFAX	SFA	SFAC	SFAHH		✓		✓			✓																																																																													
FA	TT	V	R	HH	MXS	SXR	EPFA	GPFAX	SFA	SFAC	SFAHH																																																																																						
	✓		✓			✓																																																																																											
<p>FA658 67.5 x 48.5 x 7mm</p> 	<p>MATERIAL AVAILABILITY</p> <table border="1" style="width: 100%; border-collapse: collapse;"> <thead> <tr> <th>FA</th><th>TT</th><th>V</th><th>R</th><th>HH</th><th>MXS</th><th>SXR</th><th>EPFA</th><th>GPFAX</th><th>SFA</th><th>SFAC</th><th>SFAHH</th> </tr> </thead> <tbody> <tr> <td style="text-align: center;">✓</td><td></td><td style="text-align: center;">✓</td><td></td><td style="text-align: center;">✓</td><td></td><td></td><td></td><td></td><td></td><td></td><td></td> </tr> </tbody> </table> <p>BENELLI</p> <table style="width: 100%;"> <tr> <td>TNT 200 (Tornado Naked T 200cc)</td><td>17-18</td><td>F</td><td>GENERIC/KSR</td><td></td><td></td> </tr> <tr> <td>Leoncino 125</td><td>18-20</td><td>F</td><td>Code S/X 125/150/200 (4T)</td><td>12-16</td><td>F</td> </tr> <tr> <td>TRK 125</td><td>18-20</td><td>F</td><td>GRS 125</td><td>13-16</td><td>F</td> </tr> <tr> <td>Leoncino 250</td><td>18-20</td><td>F</td><td>Worx 125/150 (4T)</td><td>12-16</td><td>F</td> </tr> <tr> <td>BN251</td><td>14-18</td><td>F</td><td>KEEWAY</td><td></td><td></td> </tr> <tr> <td>TRK 251</td><td>18-20</td><td>F</td><td>RKV 125</td><td>10-15</td><td>F</td> </tr> <tr> <td>TNT 300 (Tornado Naked T 300cc)</td><td>16-18</td><td>F</td><td>RKV 150</td><td>13-15</td><td>F</td> </tr> <tr> <td>302R</td><td>17-20</td><td>F</td><td>RKV 150/200</td><td>13-14</td><td>F</td> </tr> <tr> <td>302S</td><td>18-20</td><td>F</td><td>RKV 200 S</td><td>14</td><td>F</td> </tr> <tr> <td>BN302</td><td>15-18</td><td>F</td><td>RKX 200 S Factory</td><td>14</td><td>F</td> </tr> <tr> <td>402S</td><td>18</td><td>F</td><td>WK BIKES</td><td></td><td></td> </tr> <tr> <td></td><td></td><td></td><td>150 NK</td><td>15</td><td>F</td> </tr> </table> <p>CF MOTO RCF 150 - 3 (150 NK) 15 F</p>	FA	TT	V	R	HH	MXS	SXR	EPFA	GPFAX	SFA	SFAC	SFAHH	✓		✓		✓								TNT 200 (Tornado Naked T 200cc)	17-18	F	GENERIC/KSR			Leoncino 125	18-20	F	Code S/X 125/150/200 (4T)	12-16	F	TRK 125	18-20	F	GRS 125	13-16	F	Leoncino 250	18-20	F	Worx 125/150 (4T)	12-16	F	BN251	14-18	F	KEEWAY			TRK 251	18-20	F	RKV 125	10-15	F	TNT 300 (Tornado Naked T 300cc)	16-18	F	RKV 150	13-15	F	302R	17-20	F	RKV 150/200	13-14	F	302S	18-20	F	RKV 200 S	14	F	BN302	15-18	F	RKX 200 S Factory	14	F	402S	18	F	WK BIKES						150 NK	15	F
FA	TT	V	R	HH	MXS	SXR	EPFA	GPFAX	SFA	SFAC	SFAHH																																																																																						
✓		✓		✓																																																																																													
TNT 200 (Tornado Naked T 200cc)	17-18	F	GENERIC/KSR																																																																																														
Leoncino 125	18-20	F	Code S/X 125/150/200 (4T)	12-16	F																																																																																												
TRK 125	18-20	F	GRS 125	13-16	F																																																																																												
Leoncino 250	18-20	F	Worx 125/150 (4T)	12-16	F																																																																																												
BN251	14-18	F	KEEWAY																																																																																														
TRK 251	18-20	F	RKV 125	10-15	F																																																																																												
TNT 300 (Tornado Naked T 300cc)	16-18	F	RKV 150	13-15	F																																																																																												
302R	17-20	F	RKV 150/200	13-14	F																																																																																												
302S	18-20	F	RKV 200 S	14	F																																																																																												
BN302	15-18	F	RKX 200 S Factory	14	F																																																																																												
402S	18	F	WK BIKES																																																																																														
			150 NK	15	F																																																																																												
<p>FA659 A 134.5 x 44.5 x 7.5mm 4 x 12mm holes B 134.5 x 44.5 x 7.5mm 2 x 10mm holes</p> 	<p>MATERIAL AVAILABILITY</p> <table border="1" style="width: 100%; border-collapse: collapse;"> <thead> <tr> <th>FA</th><th>TT</th><th>V</th><th>R</th><th>HH</th><th>MXS</th><th>SXR</th><th>EPFA</th><th>GPFAX</th><th>SFA</th><th>SFAC</th><th>SFAHH</th> </tr> </thead> <tbody> <tr> <td></td><td style="text-align: center;">✓</td><td></td><td></td><td></td><td></td><td></td><td></td><td></td><td></td><td></td><td></td> </tr> </tbody> </table> <p>KIOTI/MECHRON (SIDE X SIDE)</p> <table style="width: 100%;"> <tr> <td>2200 UTV (Side x Side)</td><td>09-14</td><td>PB</td><td>POLARIS</td><td></td><td></td> </tr> <tr> <td>2200 PS UTV (Side x Side)</td><td>14-15</td><td>PB</td><td>Ranger Handbrake Pads</td><td></td><td></td> </tr> <tr> <td>2210 UTV (Side x Side)</td><td>11-14</td><td>PB</td><td>(Various Models 05-16)</td><td>05-16</td><td>R</td> </tr> <tr> <td>2240 UTV (Side x Side)</td><td>14-15</td><td>PB</td><td></td><td></td><td></td> </tr> </table>	FA	TT	V	R	HH	MXS	SXR	EPFA	GPFAX	SFA	SFAC	SFAHH		✓											2200 UTV (Side x Side)	09-14	PB	POLARIS			2200 PS UTV (Side x Side)	14-15	PB	Ranger Handbrake Pads			2210 UTV (Side x Side)	11-14	PB	(Various Models 05-16)	05-16	R	2240 UTV (Side x Side)	14-15	PB																																																			
FA	TT	V	R	HH	MXS	SXR	EPFA	GPFAX	SFA	SFAC	SFAHH																																																																																						
	✓																																																																																																
2200 UTV (Side x Side)	09-14	PB	POLARIS																																																																																														
2200 PS UTV (Side x Side)	14-15	PB	Ranger Handbrake Pads																																																																																														
2210 UTV (Side x Side)	11-14	PB	(Various Models 05-16)	05-16	R																																																																																												
2240 UTV (Side x Side)	14-15	PB																																																																																															

SFA661/4 53.5 x 45 x 7.5mm
(4 pad set)

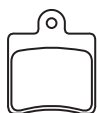

MATERIAL AVAILABILITY												
FA	TT	V	R	HH	MXS	SXR	EPFA	GPFAX	SFA	SFAC	SFAHH	
									✓	✓		

DAELIM

B-Bone 125 (SW125) 09-14 F

FA662 A 109.5 x 50.5 x 11mm
B 95.5 x 37 x 11mm

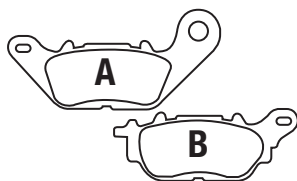

MATERIAL AVAILABILITY												
FA	TT	V	R	HH	MXS	SXR	EPFA	GPFAX	SFA	SFAC	SFAHH	
✓		✓		✓				✓				

YAMAHA

MTN 320 A (MT-03 321cc) 16-21 R
YZF - R3 (321cc/ABS) 15-21 R

FA663 A 113.5 x 54.5 x 8.5mm
B 99 x 45.5 x 8.5mm



MATERIAL AVAILABILITY												
FA	TT	V	R	HH	MXS	SXR	EPFA	GPFAX	SFA	SFAC	SFAHH	
✓		✓		✓				✓				

YAMAHA

MTN 320 A (MT-03 321cc) 16-21 F
YZF - R3 (321cc/ABS) 15-21 F

FA664 A 94 x 32 x 8mm
B 94 x 32 x 8mm



MATERIAL AVAILABILITY												
FA	TT	V	R	HH	MXS	SXR	EPFA	GPFAX	SFA	SFAC	SFAHH	
✓	✓		✓									

HONLEY

RX3 Venture 250

15-17 F

SWM

Gran Turismo 440

18 F

WK BIKES

WK 400 Trial

15-17 F

Six Days

18-21 F

FA665 54 x 41 x 6mm

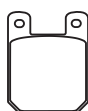

MATERIAL AVAILABILITY												
FA	TT	V	R	HH	MXS	SXR	EPFA	GPFAX	SFA	SFAC	SFAHH	
✓												

CPI

SM 250

09-12 R

SX 250

09-12 R

FA669/4 137.5 x 49.5 x 15mm
(4 pad set)

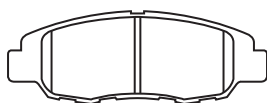

MATERIAL AVAILABILITY												
FA	TT	V	R	HH	MXS	SXR	EPFA	GPFAX	SFA	SFAC	SFAHH	
✓												

Also available in Yellow Coded Sport Upgrade Pad Blend
- Order FA4669/4

POLARIS

Slingshot

15-17 F

Slingshot SL

15-18 F

Slingshot S

18 F

Slingshot SL SE

15-18 F

Slingshot SLR

17-18 F

FA670 137.5 x 50 x 6mm
(2 pad set)

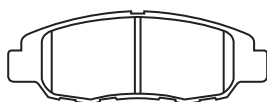

MATERIAL AVAILABILITY												
FA	TT	V	R	HH	MXS	SXR	EPFA	GPFAX	SFA	SFAC	SFAHH	
✓												

Also available in Yellow Coded Sport Upgrade Pad Blend
- Order FA4670

POLARIS

Slingshot

15-17 R

Slingshot SL SE

15-18 R

Slingshot S

18 R

Slingshot SLR

17-18 R

Slingshot SL

15-18 R

DO NOT REFIT ANY SHIMS/INSULATORS TO EBC PADS FROM ORIGINAL PADS UNLESS INSTRUCTED ON NOTE ON PAD PACKAGING AND ON FA DRAWING ASSOCIATED WITH THAT PAD.

DO NOT REFIT ANY SHIMS/INSULATORS TO EBC PADS FROM ORIGINAL PADS UNLESS INSTRUCTED ON NOTE ON PAD PACKAGING AND ON FA DRAWING ASSOCIATED WITH THAT PAD.

FA671 A 94 x 37.5 x 10mm
B 94 x 37.5 x 8.5mm



MATERIAL AVAILABILITY												
FA	TT	V	R	HH	MXS	SXR	EPFA	GPFAX	SFA	SFAC	SFAHH	
✓		✓		✓								

BMW

K 1200 S				03-08	R		Tokico Caliper				11/05-10	R
K 1200 R				05-10	R		K 1300 R				09-12	R
K 1300 S				09-15	R		K 1300 R Dynamic				11-15	R
K 1300 R				09-15	R		K 1300 R Carbon				12	R
K 1200 S (K40)				05-08	R		K 1300 S (Non & ABS Models)				09-15	R
K 1200 R (K27/0378)							K 1300 S Sport				12-15	R
							K 1300 S HP				12	R

FA672 114.5 x 39 x 9.5mm



MATERIAL AVAILABILITY												
FA	TT	V	R	HH	MXS	SXR	EPFA	GPFAX	SFA	SFAC	SFAHH	
✓		✓		✓								

INDIAN

Scout Sixty (Cast Wheel/Toso Calipers)	16	F	
Scout (Cast Wheels/Toso Calipers)	15-16	F	

GFA673HH 94 x 33.5 x 9.5mm



MATERIAL AVAILABILITY												
FA	TT	V	R	HH	MXS	SXR	EPFA	GPFAX	SFA	SFAC	SFAHH	
✓								✓				

BREMBO AFTERMARKET CALIPER
XB0 B1 30/31 P4 30/34

FA674 A 96.5 x 42 x 7.5mm
B 77 x 42 x 8mm

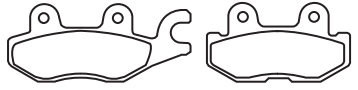

MATERIAL AVAILABILITY												
FA	TT	V	R	HH	MXS	SXR	EPFA	GPFAX	SFA	SFAC	SFAHH	
✓	✓		✓									

YAMAHA

YXM 700 E Viking EPS COMO (YXM70VPHG)	16	R(Left)		YXM 700 ES - Viking EPS SE (YXM700PSE)			14-16	R(Left)
YXM 700 E Wolverine R (YXE70WPHG)	16	R(Left)		YXC 700 E Viking VI EP (YXC700PF/PXH/PXJ)			15-18	R(Left)

FA675 A 96.5 x 42 x 7.5mm
B 77 x 42 x 8mm

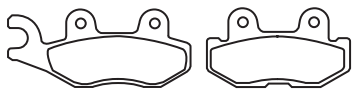

MATERIAL AVAILABILITY												
FA	TT	V	R	HH	MXS	SXR	EPFA	GPFAX	SFA	SFAC	SFAHH	
	✓		✓									

YAMAHA

YXM 700 E Viking EPS COMO (YXM70VPHG)	16	R(Right)		YXM 700 ES - Viking EPS SE (YXM700PSE)			14-16	R(Right)
YXM 700 E Wolverine R (YXE70WPHG)	16	R(Right)		YXC 700 E Viking VI EP (YXC700PF/PXH/PXJ)			15-18	R(Right)

FA676 114 x 36.6 x 9mm



MATERIAL AVAILABILITY												
FA	TT	V	R	HH	MXS	SXR	EPFA	GPFAX	SFA	SFAC	SFAHH	
✓	✓		✓			✓						

YAMAHA

YZZ 1000 R EPS (Side X Side) YZZ10PXG	16	F		YZZ 1000 R SE (Side X Side)			16	F
				YZZ 1000 R SS (Side x Side)			17-18	F

FA677 104 x 35 x 9mm



MATERIAL AVAILABILITY												
FA	TT	V	R	HH	MXS	SXR	EPFA	GPFAX	SFA	SFAC	SFAHH	
	✓		✓									

YAMAHA

YZZ 1000 R EPS (Side X Side) YZZ10PXG	16	R		YZZ 1000 R SE (Side X Side)			16	R
				YZZ 1000 R SS (Side x Side)			17-18	R

SFA678 A. 80 x 43.5 x 8.5mm
B. 80 x 43.5 x 8.5mm



MATERIAL AVAILABILITY												
FA	TT	V	R	HH	MXS	SXR	EPFA	GPFAX	SFA	SFAC	SFAHH	
									✓	✓	✓	

YAMAHA

X-Max 250 (2DL/Non ABS/Heng Tong R/Caliper) See YP250 R X-Max	14-16	R		YP250 R X-Max (2DL/Non ABS/Heng Tong R/Caliper)			14-16	R
---	-------	---	--	---	--	--	-------	---

FA679 83 x 40 x 8mm



MATERIAL AVAILABILITY												
FA	TT	V	R	HH	MXS	SXR	EPFA	GPFAX	SFA	SFAC	SFAHH	
				✓								

HONDA						
CB 125 R		18-21	F	CRF1000 LAG (Manual Clutch/ABS)	16-17	F
CB 300 RA AC		18-21	F	CRF 1000 LAG (DCT/ABS)	16-19	F
CB 650 RA/RA AC		19-21	F	CRF 1100 Africa Twin Adventure		
CBR 650 R 2AC/RA 2AC		19-21	F	Sport ES ABS Manual	19-21	F
ADV 750 H (ADV X DCT)		17-21	F	CRF 1100 Africa Twin Adventure		
				Sport ES ABS DCT	19-21	F

FA680 158 x 54.5 x 7mm

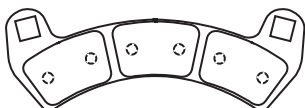

MATERIAL AVAILABILITY												
FA	TT	V	R	HH	MXS	SXR	EPFA	GPFAX	SFA	SFAC	SFAHH	
			✓									

POLARIS						
RZR XP Turbo		16-20	F	RZR XP 4 Turbo	16-20	F
				RZR Pro XP Turbo	20-22	F

SFA681 55.5 x 49.5 x 7.5mm

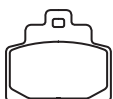

MATERIAL AVAILABILITY												
FA	TT	V	R	HH	MXS	SXR	EPFA	GPFAX	SFA	SFAC	SFAHH	
									✓	✓	✓	

PIAGGIO				VESPA			
MP3 Business LT 300 ie ABS				GTS 300 ie (Non ABS)	08-15	R	
(13" Front Wheel/14" Rear Wheel)	14-18	F		GTS 300 ie (ABS)	08-21	R	
MP3 Sport LT 300 ie ABS	14-15	F		GTS 300 ie Super (Non ABS)	08-15	R	
MP3 Sport LT 300 ie ABS				GTS 300 ie Super (ABS)	08-21	R	
(13" Front Wheel/14" Rear Wheel)	14-15			GTS 300 ie Super Sport (Non ABS)	08-15	R	
MP3 Touring Business LT 300 ie ABS	14-15	F		GTS 300 ie Super Sport (ABS)	08-18	R	
MP3 Touring Sport LT 300 ie ABS	14-18	F		GTS 300 ie Touring (Non ABS)	11-16	R	
MP3 Yourban LT RL 300	17-18	F		GTS 300 ie Touring (ABS)	11-21	R	
MP3 500 LT Business ABS				GTS 4V ABS/Super Sport/Touring	18-19	R	
(13" Front Wheel/14" Rear Wheel)	14-20	F		GTS 4V ABS	18-19	R	
MP3 500 LT Sport ABS							
(13" Front Wheel/14" Rear Wheel)	14-18	F					

FA682 A 117.5 x 50.5 x 8mm B 95 x 50.5 x 8mm

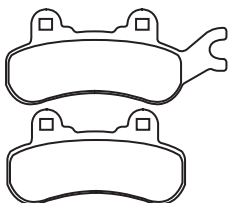

MATERIAL AVAILABILITY												
FA	TT	V	R	HH	MXS	SXR	EPFA	GPFAX	SFA	SFAC	SFAHH	
	✓		✓			✓						

CAN-AM (Side x Side)						
Defender HD5 500cc	17-19	F(Left)		Defender XT 976cc	16	F(Left)
Defender HD8 799cc	17-19	F(Left)		Defender XT 799cc	16	F(Left)
Defender HD10 976cc	17-19	F(Left)		Defender XT Cab 976cc	16	F(Left)
Defender 799cc	16	F(Left)		Defender XT Cab 799cc	16	F(Left)
Defender 976cc	16	F(Left)		Maverick Trail 800R EFI	18	F(Left)
Defender DPS 799cc	16	F(Left)		Maverick Trail 1000 EFI	18	F(Left)
Defender DPS 976cc	16	F(Left)		Maverick X3	17	F(Left)&R(Left)
Defender Max	17	F(Left)		Maverick X3 Max Turbo	17	F(Left)&R(Left)
Defender Max HD8 799cc	18-19	F(Left)		Maverick X3 Turbo	18	F(Left)&R(Left)
Defender Max HD10 976cc	18-19	F(Left)		Maverick X3 Max Turbo	18	F(Left)&R(Left)
Defender T	17	F(Left)R(Left)		Maverick X3 Turbo R	18	F(Left)&R(Left)
				Maverick X3 Max Turbo R	18	F(Left)&R(Left)

FA683 A 117.5 x 50.5 x 8mm B 95 x 50.5 x 8mm

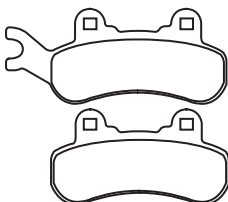

MATERIAL AVAILABILITY												
FA	TT	V	R	HH	MXS	SXR	EPFA	GPFAX	SFA	SFAC	SFAHH	
	✓		✓			✓						

CAN-AM (Side x Side)						
Defender HD5 500cc	17-19	F(Right)&R(Right)		Defender XT 799cc	16	F(Right)
Defender HD8 799cc	17-19	F(Right)&R(Right)		Defender XT Cab 976cc	16	F(Right)
Defender HD10 976cc	17-19	F(Right)&R(Right)		Defender XT Cab 799cc	16	F(Right)Maverick
Defender 799cc	16	F(Right)		Trail 800R EFI	18	F(Right)
Defender 976cc	16	F(Right)		Maverick Trail 1000 EFI	18	F(Right)
Defender Max	17	F(Right)&R(Right)		Maverick X3	17	F&R(Right)
Defender Max HD8 799cc	18-19	F(Right)&R(Right)		Maverick X3 Max Turbo	17	F&R(Right)
Defender Max HD10 976cc	18-19	F(Right)&R(Right)		Maverick X3 Turbo	18	F&R(Right)
Defender T	2017	F(Right)&R(Right)		Maverick X3 Max Turbo	18	F&R(Right)
Defender DPS 799cc	16	F(Right)		Maverick X3 Turbo R	18	F&R(Right)
Defender DPS 976cc	16	F(Right)		Maverick X3 Max Turbo R	18	F&R(Right)
Defender XT 976cc	16	F(Right)				

FA684 A 101.5 x 44 x 8mm
B 83 x 43 x 8mm

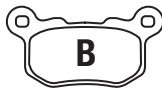



MATERIAL AVAILABILITY												
FA	TT	V	R	HH	MXS	SXR	EPFA	GPFA	SFA	SFAC	SFAHH	
	✓		✓			✓						

CAN-AM (Side x Side)

Defender 799cc	16 R(Left) Defender XT 976cc	16 R(Left)
Defender 976cc	16 R(Left) Defender XT 799cc	16 R(Left)
Defender DPS 799cc	16 R(Left) Defender XT Cab 976cc	16 R(Left)
Defender DPS 976cc	16 R(Left) Defender XT Cab 799cc	16 R(Left)

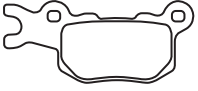
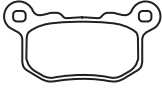
FA685 A 101.5 x 44 x 8mm
B 83 x 43 x 8mm





MATERIAL AVAILABILITY												
FA	TT	V	R	HH	MXS	SXR	EPFA	GPFA	SFA	SFAC	SFAHH	
	✓		✓			✓						

CAN-AM (Side x Side)

Defender 799cc	16 F(Right) Defender XT 976cc	16 F(Right)
Defender 976cc	16 F(Right) Defender XT 799cc	16 F(Right)
Defender DPS 799cc	16 F(Right) Defender XT Cab 976cc	16 F(Right)
Defender DPS 976cc	16 F(Right) Defender XT Cab 799cc	16 F(Right)

FA686 A 94 x 44.5 x 8.5mm
B 73 x 46 x 10mm





MATERIAL AVAILABILITY												
FA	TT	V	R	HH	MXS	SXR	EPFA	GPFA	SFA	SFAC	SFAHH	
	✓		✓									

KAWASAKI

KAF 820 AFF/AGF/AHF/AJF -	15-18 R Mule PRO FXT Ranch Edition	16-17 R
Mule Pro FXT	KAF 1000 AGF/AHF/AJF -	16-18 R
KAF 820 BFF/BGF/BHF/BJF -	Mule Pro DXT/Diesel	16-18 R
Mule Pro FXT/EP	KAF 1000 BGF/BHF/BJF -	16-18 R
KAF 820 CFF/CGF/CHF/CJF -	Mule Pro DXT/Diesel EPS	16-18 R
Mule Pro FXT/EP	KAF 1000 CGF/CHF -	16-17 R
KAF 820 DFF/DGF/DHF/DJF -	Mule Pro DXT EPS LE/Diesel	16-17 R
Mule Pro FXT/EP	KAF 1000 DGF/DHF -	16-17 R
KAF 820 EGF/EHF/EJF Mule Pro FX	Mule Pro DX /Diesel	16-17 R
KAF 820 FGF/FHF/FJF -	KAF 1000 EGF/EHF/EJF	16-18 R
Mule Pro FX/EP	Mule Pro DX EPS/Diesel	16-18 R
KAF 820 GGF/GHF/GJF -	KAF 1000 FGF/FHF -	16-17 R
Mule Pro FX/EP	Mule Pro DX EPS LE/Diesel	16-17 R
KAF 820 HGF/HHF -		
Mule PRO FX/EP		

CFA689 43.5 x 29 x 3.5mm





MATERIAL AVAILABILITY												
FA	TT	V	R	HH	MXS	SXR	EPFA	GPFA	SFA	SFAC	SFAHH	
✓												

BULTACO

Brinco (Electric Trials Bike - C/R/RE/S Models)	15-17 F	
---	---------	--



FA691 A 84.5 x 44 x 7mm
B 74 x 41.5 x 7mm

MATERIAL AVAILABILITY												
FA	TT	V	R	HH	MXS	SXR	EPFA	GPFA	SFA	SFAC	SFAHH	
✓				✓								

HONDA	KAWASAKI	
Super Cub C 125 (ABS)	Z 125 PRO (BR125 HGF/JHF)	
Super Cub C 125 (ABS) 007	Manual G/Box)	16-20 F
CT 125	Z 125 Pro SE (BR125 JJFS Manual G/Box)	18-20 F



SFA693 A 110.5 x 34.5 x 7.5mm
B 98.5 x 33.5 x 7.5mm

MATERIAL AVAILABILITY												
FA	TT	V	R	HH	MXS	SXR	EPFA	GPFA	SFA	SFAC	SFAHH	
									✓	✓	✓	

HONDA	Liberty i-get 150 (3V/4T)	15-21 F
PCX 125 S (WW 125 AK)	Medley 125 (ABS)	16-21 F
PIAGGIO	Medley S 125 (ABS)	16-21 F
Liberty i-get 50 (3V/4T)	Medley 150 (ABS)	16-21 F
Liberty i-get 125 (3V/4T)	Medley S 150 (ABS)	16-21 F

SFA694 A 98.5 x 48.5 x 7.5mm
B 85 x 39.5 x 7.5mm

MATERIAL AVAILABILITY												
FA	TT	V	R	HH	MXS	SXR	EPFA	GPFA	SFA	SFAC	SFAHH	
									✓	✓		

YAMAHA

GPD 125 A - N-Max/2DS1	15-18 F N-Max 150 -See GPD150 A	15-17 F
N-Max 125- See GPD 125 A	LTS 125-C D'elight	17-21 F
GPD 150 A - N-Max/2DP4		

FA696 55 x 53.6 x 9mm



MATERIAL AVAILABILITY												
FA	TT	V	R	HH	MXS	SXR	EPFA	GPFAX	SFA	SFAC	SFAHH	
✓		✓		✓								

INDIAN												
Chief Standard (Brembo calipers)	09-11	R	Chief Deluxe (Brembo calipers)	09	R							
Chief Blackhawk	11	R	Chief Roadmaster (Brembo calipers)	09-11	R							
Chief Blackhawk Dark	11	R	Chief Vintage (Brembo calipers)	09-13	R							
Chief Classic	11-13	R	Dark Horse (Brembo calipers)	10-13	R							
			Bomber (Brembo calipers)	10-11	R							

FA697 75 x 42.5 x 9.5mm

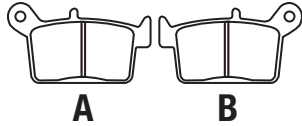

MATERIAL AVAILABILITY												
FA	TT	V	R	HH	MXS	SXR	EPFA	GPFAX	SFA	SFAC	SFAHH	
✓	✓		✓	✓								

WKBikes												
Wk 400 Trail	15-17	R	Gran Milano (4T)	16-18	R							
RS 125 R	18	R	Gran Milano Boggi SE	18	R							
SM 125 R	18-20	R	Gran Milano Outlaw 500	18-21	R							
Ace of Spades 500cc	18-21	R	Gran Turismo 440	18	R							
			Silver Vase 440	18	R							
			Six Days	18-21	R							

FA698 81.5 x 37.5 x 9mm



MATERIAL AVAILABILITY												
FA	TT	V	R	HH	MXS	SXR	EPFA	GPFAX	SFA	SFAC	SFAHH	
✓		✓		✓								

BENELLI												
Leoncino 125	18-20	R	TNT 300 (Tornado Naked T 300cc)	16-18	R							
TRK 125	18-20	R	Imperiale 400	18-20	R							
Leoncino 250	18-20	R	402S	18	R							
TRK 251	18-20	R	Leoncino (500cc)	17-20	R							
302R	18-20	R	Leoncino Trail (500cc)	17-20	R							
302S	18-20	R	TRK 502	17-20	R							
BN302	17-18	R	TRK 502 X	17-20	R							
			752S	18-20	R							

FA700 78 x 43 x 8mm

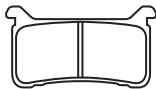

MATERIAL AVAILABILITY												
FA	TT	V	R	HH	MXS	SXR	EPFA	GPFAX	SFA	SFAC	SFAHH	
✓				✓			✓	✓				

HONDA												
CBR 600 RR	17-20	F	CBR 1000 Fireblade C-ABS	17-20	F							
CBR 600 RR ABS	17-21	F	Nissin F/calipers 5 bolt hole fitting	17-20	F							
VFR 800 XH/XJ (Crossrunner/ABS)	17-18	F	CB 1100 RS	18-21	F							

FA701 115 x 40.5 x 11mm



MATERIAL AVAILABILITY												
FA	TT	V	R	HH	MXS	SXR	EPFA	GPFAX	SFA	SFAC	SFAHH	
	✓		✓			✓						

HONDA												
SXS 1000 M3 Pioneer (3 Seater)	16-20	F (Left)	SXS 1000 M5L Pioneer (5 Seater)	16-20	F (Left)							
SXS 1000 M3P Pioneer (3 Seater)	16-20	F (Left)	SXS 1000 M5P Pioneer (5 Seater)	16-20	F (Left)							
SXS 1000 M5D Pioneer (5 Seater)	16-20	F (Left)	SXS S2R Talon (2 Seater)	19-21	F (Left)							

FA702 115 x 40.5 x 11mm



MATERIAL AVAILABILITY												
FA	TT	V	R	HH	MXS	SXR	EPFA	GPFAX	SFA	SFAC	SFAHH	
	✓		✓			✓						

HONDA												
SXS 1000 M3 Pioneer (3 Seater)	16-20	F (Right)	SXS 1000 M5L Pioneer (5 Seater)	16-20	F (Right)							
SXS 1000 M3P Pioneer (3 Seater)	16-20	F (Right)	SXS 1000 M5P Pioneer (5 Seater)	16-20	F (Right)							
SXS 1000 M5D Pioneer (5 Seater)	16-20	F (Right)	SXS S2R Talon (2 Seater)	19-21	F (Right)							

FA703 82 x 38.5 x 10.5mm

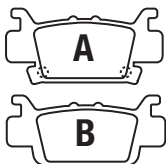

MATERIAL AVAILABILITY												
FA	TT	V	R	HH	MXS	SXR	EPFA	GPFAX	SFA	SFAC	SFAHH	
	✓		✓			✓						

HONDA												
SXS 1000 M3 Pioneer (3 Seater)	16-18	R (Left)	SXS 1000 M5L Pioneer (5 Seater)	17-18	R (Left)							
SXS 1000 M3P Pioneer (3 Seater)	16-18	R (Left)	SXS 1000 M5P Pioneer (5 Seater)	16-18	R (Left)							
SXS 1000 M5D Pioneer (5 Seater)	16-18	R (Left)	SXS S2R Talon (2 Seater)	19-21	R (Left)							

FA704 82 x 38.5 x 10.5mm

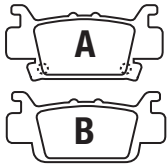

MATERIAL AVAILABILITY												
FA	TT	V	R	HH	MXS	SXR	EPFA	GPFA	SFA	SFAC	SFAHH	
	✓		✓			✓						

HONDA

SXS 1000 M3 Pioneer (3 Seater)	16-18 R (Right)	SXS 1000 M5L Pioneer (5 Seater)	17-18 R (Right)
SXS 1000 M3P Pioneer (3 Seater)	16-18 R (Right)	SXS 1000 M5P Pioneer (5 Seater)	16-18 R (Right)
SXS 1000 M5D Pioneer (5 Seater)	16-18 R (Right)	SXS S2R Talon (2 Seater)	19-21 R (Right)

SFA705 A. 113.5 x 55 x 8.5mm B. 98.5 x 44.5 x 8.5mm



MATERIAL AVAILABILITY												
FA	TT	V	R	HH	MXS	SXR	EPFA	GPFA	SFA	SFAC	SFAHH	
									✓	✓	✓	

YAMAHA

X-Max 125 ABS	18-20	F	X-Max 300 ABS	17-20	F
X-Max 125 ABS Tech Max	19-20	F	X-Max 300 ABS Tech Max	19-20	F

SFA706 A. 113.5 x 52 x 9.5mm B. 97.5 x 39.5 x 9.5mm



MATERIAL AVAILABILITY												
FA	TT	V	R	HH	MXS	SXR	EPFA	GPFA	SFA	SFAC	SFAHH	
									✓	✓	✓	

YAMAHA

X-Max 125 ABS	18-20	R	X-Max 300 ABS	17-20	R
X-Max 125 ABS Tech Max	19-20	R	X-Max 300 ABS Tech Max	19-20	R

FA707 A. 85 x 44 x 7mm B. 74.5 x 41 x 7mm

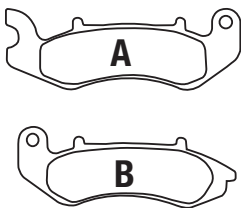

MATERIAL AVAILABILITY												
FA	TT	V	R	HH	MXS	SXR	EPFA	GPFA	SFA	SFAC	SFAHH	
✓		✓							✓			

FA707 - GENERIC/KSR

Demonio 50	17-18	F	TR 125 X	17-18	F
Classic 125	17-18	F	TW 125 SM	17-18	F
Code 125	17-20	F	SFA707 - GENERIC/KSR		
Demonio 125	17-18	F	Race 2 125 GT (4T)	18	F
GRS 125	17-20	F	Sirion 125 (4T/ Rear Disc Model)	18-20	F

SFA708 A. 124 x 43 x 9mm B. 115.5 x 43 x 9mm

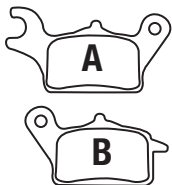

MATERIAL AVAILABILITY												
FA	TT	V	R	HH	MXS	SXR	EPFA	GPFA	SFA	SFAC	SFAHH	
									✓	✓		

HONDA

NCX 50 E/G/J - Dunk 50	14-17	F	NSC 110 CSD/CSE - Spacy 110	12-14	F
NSC 110 MPDH Vision (16 Inch Wheels)	17-18	F	NSC 1110 CBFF/CBFH - Dio 110	15-17	F
ACB 110 CBB/CSB - Vario 110	10	F	ACA 125 CBFE - Air Blade 125	14-16	F
ACD 110 CSB/SCB - Scoopy 110 Fi	11-16	F	LIFAN		
ACC 110 SCB/SCC - ANC 110 Icon	11-12	F	Lifan Electric LF 1200 DT E3	17-20	F
			Lifan Electric LF 1200 DT E3 Deluxe	17-20	F

SFA709 A. 111.5 x 43 x 8mm B. 109.5 x 43 x 8mm

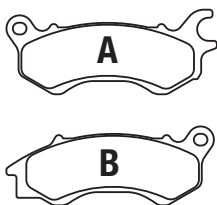

MATERIAL AVAILABILITY												
FA	TT	V	R	HH	MXS	SXR	EPFA	GPFA	SFA	SFAC	SFAHH	
									✓	✓	✓	

DAYTONA

DY 125 RS EURO4	17				
SILENCE Electric Scooters					
S01	21	F			
S02	21	F			
S02 LS	21	F			

DO NOT REFIT ANY SHIMS/INSULATORS TO EBC PADS FROM ORIGINAL PADS UNLESS INSTRUCTED ON NOTE ON PAD PACKAGING AND ON FA DRAWING ASSOCIATED WITH THAT PAD.

FA710 82 x 42 x 10mm



MATERIAL AVAILABILITY												
FA	TT	V	R	HH	MXS	SXR	EPFA	GPFAX	SFA	SFAC	SFAHH	
		✓		✓			✓					

HARLEY DAVIDSON												
FLFB Fat Boy					18	R	FXBR Breakout				18-20	R
FLFBS Fat boy 114					18	R	FXBRS Breakout 114				18-20	R
FLFBS Fat Boy Anniv					18	R	FLDE Deluxe				18-20	R
FLHC Heritage Classic					18	R	FXBB Street Bob				18-20	R
FLHCS Heritage Classic 114					18	R	FXFB Fat Bob				18-20	R
FLHCS Heritage Classic 114 Anniv.					18	R	FXBS Fat Bob				18-20	R
FLSL Softail Slim					18	R	FXLR Low Rider				18-20	R

FA711 A 124 x 43 x 9mm B 115.5 x 43 x 9mm

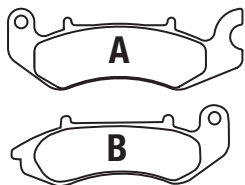

MATERIAL AVAILABILITY												
FA	TT	V	R	HH	MXS	SXR	EPFA	GPFAX	SFA	SFAC	SFAHH	
✓		✓										

BENELLI												
TNT 125 (Tornado Naked T 125cc)					17-21	F	Worx 125				17-18	F
TNT 135 (Tornado Naked T 135cc)					18	F	BN125				18-21	F

FA712 A 104 x 43.5 x 15mm B 104 x 43.5 x 15mm

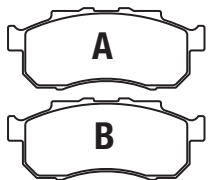

MATERIAL AVAILABILITY												
FA	TT	V	R	HH	MXS	SXR	EPFA	GPFAX	SFA	SFAC	SFAHH	
	✓	✓	✓									

HONDA												
SXS 500 M2 Pioneer (2 Seat)					15-17	F Left						
SXS 700 M2 Pioneer (2 Seat)					16-18	F Left						
							SXS 700 M4 Pioneer (4 Seat)				16-18	F Left

FA714 75.5 x 39.5 x 12mm



MATERIAL AVAILABILITY												
FA	TT	V	R	HH	MXS	SXR	EPFA	GPFAX	SFA	SFAC	SFAHH	
	✓	✓	✓									

HONDA												
SXS 500 M2 Pioneer (2 Seat)					15-17	R						
SXS700M2 Pioneer (2 Seat)					16-18	R						
							SXS700M4 Pioneer (4 Seat)				16-18	R

FA715 A. 109.5 x 39.5 x 7.5mm B. 95 x 39.5 x 7.5mm

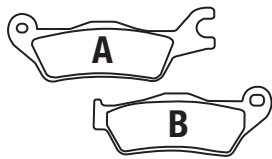

MATERIAL AVAILABILITY												
FA	TT	V	R	HH	MXS	SXR	EPFA	GPFAX	SFA	SFAC	SFAHH	
✓		✓		✓								

HONDA						SUZUKI						
CBF 125 6 Stunner					06	F	GSX-R 125 RLXL8/RLl8				18-21	F
CBF 125 M7 Stunner					07	F	GSX-S 125 MLXL8/MLL8				18-21	F
CBF 150 5					05	F	GSX 150 L6 Gixxer				16-20	F
CBF 150 M5 Unicorn					05	F	GSX 150 DZAL6/DEAL8/DZAL8/DXAL8					
CBF 150 6 (Spoke Wheels)					06	F	Gixxer				16-20	F
CBF 150 M6/M7 Unicorn (Spoke Wheels)					06-07	F	GSX-R 150 FRFAL7/FRZAL7				17-20	F
CBF 150 M7/M9/MA Unicorn (Cast Wheels)					07-10	F	GSX-R 150 RF-Q/RFX-Q				17-20	F
CBF 150 MB/MC Unicorn (Cast Wheels)					11-12	F	GSX-R 150 RFL8/RFXL8				18-20	F
							GSX-S 150 MFL8/MFXL8				18-20	F

FA716 A. 101.5 x 43.5 x 7.5mm B. 90.5 x 43.5 x 7.5mm



MATERIAL AVAILABILITY												
FA	TT	V	R	HH	MXS	SXR	EPFA	GPFAX	SFA	SFAC	SFAHH	
✓												

HONDA												
CB 125 F (GLR 125 1WHH)					17-21	F						







FA717 129.5 x 40 x 9mm

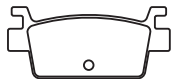
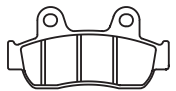

MATERIAL AVAILABILITY												
FA	TT	V	R	HH	MXS	SXR	EPFA	GPFAX	SFA	SFAC	SFAHH	
				✓								

HONDA												
GL 1800 B Goldwing J (Manual)					18-20	F	GL 1800 D Goldwing Tour J (DCT)				18-20	F
GL 1800 Goldwing Tour J (Manual)					18-20	F	GL 1800 DA Goldwing Tour Airbag J (DCT)				18-20	F
GL 1800 BD Goldwing J (DCT)					18-20	F						

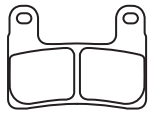
DO NOT REFIT ANY SHIMS/INSULATORS TO EBC PADS FROM ORIGINAL PADS UNLESS INSTRUCTED ON NOTE ON PAD PACKAGING AND ON FA DRAWING ASSOCIATED WITH THAT PAD.

SFA719 81.5 x 37.5 x 9mm 	MATERIAL AVAILABILITY											
	FA	TT	V	R	HH	MXS	SXR	EPFA	GPFA	SFA	SFAC	SFAHH
										✓	✓	✓
KYMCO AK550 17-21 R												
SFA721 85 x 43 x 9.5mm 	MATERIAL AVAILABILITY											
	FA	TT	V	R	HH	MXS	SXR	EPFA	GPFA	SFA	SFAC	SFAHH
										✓	✓	
HONDA CBF 125 Twister 18-20 F SC 125 Elite 08-14 F NSC 125 New Elite 125 scooter 18-20 F CB 190 R (CBF190WH) 16-18 F SCR 110 Spacey 08-14 F												
FA722 A 137.5 x 43 x 9mm B 118 x 43 x 9mm  	MATERIAL AVAILABILITY											
	FA	TT	V	R	HH	MXS	SXR	EPFA	GPFA	SFA	SFAC	SFAHH
	✓									✓		
AJS LEXMOTO Cadwell 125 19 F Viper SK125-22A 21 F Cadwell Clubman 125 19 F Tempest Roadster 125 19 F Tempest Scrambler 125 19 F												
SFA723 A 101.5 x 43.5 x 7.5mm B 98.5 x 43.5 x 7.5mm  	MATERIAL AVAILABILITY											
	FA	TT	V	R	HH	MXS	SXR	EPFA	GPFA	SFA	SFAC	SFAHH
	✓									✓		
HONDA PCX 125 18-21 F PCX 150 Hybrid 19-20 PCX 150 17-21 Zoomer 110 19-21												
FA724 73 x 54.5 x 8.5mm 	MATERIAL AVAILABILITY											
	FA	TT	V	R	HH	MXS	SXR	EPFA	GPFA	SFA	SFAC	SFAHH
					✓			✓	✓			
BMW R 1250 GS 19-20 F R 1250 RT 19-21 F R 1250 GS Edition 40 20-21 F R 1250 RT SE 19-21 F R 1250 GS Adventure 19-20 F R 1250 RT LE 19-21 R 1250 GS Adventure Edition 40 20-21 F S 1000 R Naked 20-21 R 1250 GS TE 19-20 F S 1000 XR 19-20 R 1250 GS Exclusive 19-20 F S 1000 XR 2019-2021 R 1250 GS Rallye 19-20 F S 1000 R 2018-2020 R 1250 GS Rally TE 19-20 F S 1000 RR Sport/RR M-Sport 2018-2020 R 1250 R 19-21 F												
FA726 101.5 x 36.5 x 11mm 	MATERIAL AVAILABILITY											
	FA	TT	V	R	HH	MXS	SXR	EPFA	GPFA	SFA	SFAC	SFAHH
		✓		✓			✓					
C F MOTO 400 C-Force 18-19 F 600 C-Force EPS 18-19 F 500 C-Force 17-19 F 950 Z-Force 20 F 1000 Z-Force 18-21 F 1000 U-Force 20 F 600 C-Force 20 F												

FA727 A 137.5 x 44 x 9mm
B 118 x 44 x 9mm

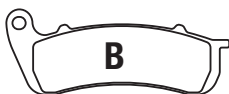

MATERIAL AVAILABILITY												
FA	TT	V	R	HH	MXS	SXR	EPFA	GPFAX	SFA	SFAC	SFAHH	
✓	✓								✓	✓		

ZONTES

ZT 125 Firefly	17-19	F
ZT 125 Mantis	17-19	F
ZT 125 Scorpion	17-19	F

FA728 163.5 x 50 x 9.5mm



MATERIAL AVAILABILITY												
FA	TT	V	R	HH	MXS	SXR	EPFA	GPFAX	SFA	SFAC	SFAHH	
✓	✓								✓	✓		

POLARIS

RZR XP4 Turbo	19-20	F
---------------	-------	---

FA730 49.5 x 36 x 8mm



MATERIAL AVAILABILITY												
FA	TT	V	R	HH	MXS	SXR	EPFA	GPFAX	SFA	SFAC	SFAHH	
				✓			✓	✓				

BMW

S 1000 RR HP4 Race	17-18	R
--------------------	-------	---

BREMBO

XA1J040 P2/30 Rear Caliper		
----------------------------	--	--

FA731 A 130.5 x 51 x 9mm
B 128 x 45.5 x 9mm



MATERIAL AVAILABILITY												
FA	TT	V	R	HH	MXS	SXR	EPFA	GPFAX	SFA	SFAC	SFAHH	
	✓		✓									

LEXMOTO

ZSX-F 125 ZS125-48E-E4	16-20	F
ZSX-R 125 ZS125-48F-E4	16-20	F

SINNIS

Hoodlum 125 ZS 125-79	17-20	F
-----------------------	-------	---

SFA732 A 109 x 41 x 7.5mm
B 94 x 37.5 x 7.5mm

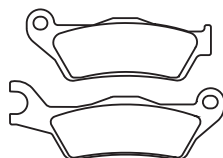

MATERIAL AVAILABILITY												
FA	TT	V	R	HH	MXS	SXR	EPFA	GPFAX	SFA	SFAC	SFAHH	
									✓	✓		

PIAGGIO

Typhoon 50 (2T) Euro 4	16-20	F
------------------------	-------	---

FA737 106.5 x 41 x 8mm



MATERIAL AVAILABILITY												
FA	TT	V	R	HH	MXS	SXR	EPFA	GPFAX	SFA	SFAC	SFAHH	
	✓		✓									

WILWOOD

Z15015190 Wilwood caliper	20	
---------------------------	----	--

FA738 114 x 40 x 9mm

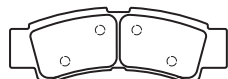

MATERIAL AVAILABILITY												
FA	TT	V	R	HH	MXS	SXR	EPFA	GPFAX	SFA	SFAC	SFAHH	
			✓			✓						

KAWASAKI

KRF 1000 Teryx	20	F
----------------	----	---

FA739 85 x 38 x 9mm



MATERIAL AVAILABILITY												
FA	TT	V	R	HH	MXS	SXR	EPFA	GPFAX	SFA	SFAC	SFAHH	
			✓			✓						

KAWASAKI

KRF 1000 Teryx	20	R
----------------	----	---

DO NOT REFIT ANY SHIMS/INSULATORS TO EBC PADS FROM ORIGINAL PADS UNLESS INSTRUCTED ON NOTE ON PAD PACKAGING AND ON FA DRAWING ASSOCIATED WITH THAT PAD.

FA740 122 x 55 x 8mm



MATERIAL AVAILABILITY											
FA	TT	V	R	HH	MXS	SXR	EPFA	GPFA	SFA	SFAC	SFAHH
	✓		✓								

ARCTIC CAT

Cushman Hauler 4X4 Diesel	19-20	F	Wildcat X,XT and LTD	19-20	F
Cushman Hauler 4X4 Crewe and EPS Diesel	19-20	F	Prowler Pro Crew and XT	19-20	F

FA741 120 x 51 x 7.5mm



MATERIAL AVAILABILITY											
FA	TT	V	R	HH	MXS	SXR	EPFA	GPFA	SFA	SFAC	SFAHH
	✓		✓								

ARCTIC CAT

Wildcat Sport 700	15	F	Wildcat Trail 700 XT inc LTD	15-19	F
Wildcat Sport XT 700	15	F	Cushman Hauler 800	12-18	F
Wildcat Sport LTD	16	F	Stampede 900 XT, XTR inc LTD	17-19	F
Wildcat Sport 700 XT inc LTD	18-19	F	Stampede 900 4 Inferno inc TT Kanati	18	F

FA742 122 x 48.5 x 8mm



MATERIAL AVAILABILITY											
FA	TT	V	R	HH	MXS	SXR	EPFA	GPFA	SFA	SFAC	SFAHH
	✓		✓								

ARCTIC CAT

Cushman Hauler 4X4 Diesel	19-20	R	Wildcat X,XT and LTD	19-20	R
Cushman Hauler 4X4 Crewe and EPS Diesel	19-20	R	Prowler Pro Crew and XT	19-20	R

FA743 50mm O/D x 8.7mm



MATERIAL AVAILABILITY											
FA	TT	V	R	HH	MXS	SXR	EPFA	GPFA	SFA	SFAC	SFAHH
								✓			

YAMAHA

TZ 250	80-90	F	TZ 350	70-81	F
--------	-------	---	--------	-------	---

**FA744 A 101.5 x 43 x 9.5mm
B 85 x 43 x 9.5mm**



MATERIAL AVAILABILITY											
FA	TT	V	R	HH	MXS	SXR	EPFA	GPFA	SFA	SFAC	SFAHH
		✓									

HONDA

CBF 150 SH	07-10	F			
------------	-------	---	--	--	--

FA747 89 x 37 x 11mm



MATERIAL AVAILABILITY											
FA	TT	V	R	HH	MXS	SXR	EPFA	GPFA	SFA	SFAC	SFAHH
	✓		✓								

CF MOTO

1000 Z-Force CF1000-US.2	18-21	R			
--------------------------	-------	---	--	--	--

FA748 92 x 55 x 8mm

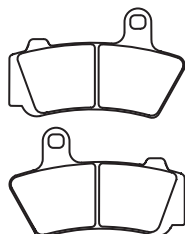

MATERIAL AVAILABILITY											
FA	TT	V	R	HH	MXS	SXR	EPFA	GPFA	SFA	SFAC	SFAHH
				✓							

BMW

R18 Classic 1800 cc	20-21	F			
---------------------	-------	---	--	--	--

FA749 92 x 55 x 8mm

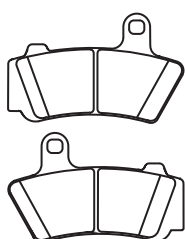

MATERIAL AVAILABILITY											
FA	TT	V	R	HH	MXS	SXR	EPFA	GPFA	SFA	SFAC	SFAHH
				✓							

BMW

R18 Classic 1800 cc	20-21	R			
---------------------	-------	---	--	--	--

FA754 88.6 x 42 x 9.7mm

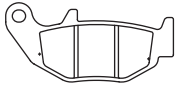

MATERIAL AVAILABILITY												
FA	TT	V	R	HH	MXS	SXR	EPFA	GPFA	SFA	SFAC	SFAHH	
✓									✓			

LEXMOTO

Venom

19-21 R

FA755 94 x 33.8 x 7.5mm

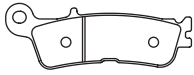

MATERIAL AVAILABILITY												
FA	TT	V	R	HH	MXS	SXR	EPFA	GPFA	SFA	SFAC	SFAHH	
✓	✓		✓		✓							

FANTIC

XE 125 2T
 XX 125 2T
 XX 250
 XEF 250
 XEX 250
 XEF 450
 XXF 450

21-22 F
 21-22 F
 21-22 F
 21-22 F
 21-22 F
 21-22 F
 21-22 F

YAMAHA

WRF 250
 YZF 250
 WRF 450
 YZF 450

20-22 F
 19-22 F
 19-22 F
 19-22 F

FA757 80 x 43 x 7.8mm

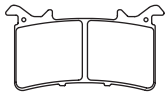

MATERIAL AVAILABILITY												
FA	TT	V	R	HH	MXS	SXR	EPFA	GPFA	SFA	SFAC	SFAHH	
✓				✓			✓	✓				

BMW

M 1000 RR

21-22 F

HONDA

CBR 1000 RR-R Fireblade Nissin front caliper

20-22 F

BRAKE PAD BUYERS GUIDE

DO NOT REFIT ANY SHIMS/INSULATORS TO EBC PADS FROM ORIGINAL PADS UNLESS INSTRUCTED ON NOTE ON PAD PACKAGING AND ON FA DRAWING ASSOCIATED WITH THAT PAD.

BRAKE SHOE BUYERS GUIDE

Part No.	Make/Model	Year		Part No.	Make/Model	Year	
H301	HONDA			H303 Contd. H303G	HONDA Contd.		
	CRF 50 F	04-21	F&R		XR 75 K4	75-78	R
	NB 50 ME Aero	84	F		XR 75 K5	79	F&R
	NB 50 MF/MG/TH 'Vision'	86-88	F		NH 80 MD-D/MD-G	83-86	F
	NE 50 MF/MG 'Vision'	86-87	F		NH 80 MDR	94-	F
	NC 50 K1/KZ 'Express'	79-82	F&R		NH 80 Lead 80	85	R
	NC 50 C 'Express 2'	82	F		C 90 (All models)	75-92	F&R
	NC 50 A/B 'Express 3 Delux'	82	F		EZ 90 'Cub'	91-95	F&R
	NP 50 D 'Melody Mini'	83	F		NH 90 M/P/R Yuppy	91-94	R
	NS 50 'Melody'/MSB 'Melody Delux'	82	F		SRX 90 Shadow T/W/X	97-99	R
	NT 50 F/G/H 'Melody Mini'	85-87	F&R		TRX 90 Fourtrax/Sportrax (all models)	93-06	F
	NX 50 A/B/MB 'Caren'	80-82	F		TRX 90 EX	07-08	F
	PC 50 K1	79	F&R		TRX 90 X9/XB/XC/	09-21	F
	QR 50 D/E/F	83-87	F		Astrea Supra NF100	99	R
	QR 50 M/R/V/W/Y	93-03	F		Astrea Grand/Supra	97-98	F&R
	XR 50 R1/R2/R3	01-03	F&R		H 100 A/SD/SG/SJ	82-92	F&R
	Z 50 R 'All models'	79-86	F&R		SH 100 T/W/X/Y/1 Scoopy	96-01	R
	HUSQVARNA				SJ 100 T 'Bali Ex'	96-99	R
	Husky Boy	00-02	F&R		CT 110 A/B/C/D/K/M	80-88	F
	Husky Boy Racing S	00	F&R		SL 125 'K1A'	76	F&R
	Husky Boy Racing J	00	F&R		CB 125 S	75-79	F&R
	SUZUKI				CG 125 K/B/C/E	77-84	F&R
	DR-Z 50	18-21	F&R		CG 125 BR-K/BR-T	85-97	R
	DR-Z 70 K8/K9/L0/L2/L4/L5/L6/L7	08-17	F&R		CH 125 D/E/G 'Spacy'	84-86	F&R
	YAMAHA				CH 125 J/L/M/N/P/R/T Spacy	88-96	F&R
	TT-R 50 E	06-15	F&R		NH 125 MD-D 'Lead'	83	F&R
					NH 125 "Lead 125"	86-87	R
			NS 125 FG/FH/RH	86-87	R		
H302	HONDA			NX 125 K/S/F Transcity	89-97	R	
H302G	NB 50 ME 'Aero'	82	R	Passing 125	93-97	R	
	NB 50 MF/MG/TH 'Vision'	86-88	R	TRX 125 J	88	F	
	NE 50 MF/MG 'Vision'	86-87	R	XL 125 K3/K4	79	F	
	NC 50 C 'Express 2'	82	R	XL 125 L Paris-Dakar	85	R	
	NC 50 A/B 'Express 3 Delux'	82	R	ATC 125 ME/MG	84-85	F	
	ND 50 C/ML 'Melody 2 Delux'	82	R	ATC 185 A/SB	80-81	F	
	NH 50 "Lead 50 SS"	84	R	ATC 200 B/ESE/ESF/SE	81-84	F	
	NH 50 "Lead AF01/D716"	84-85	R	XL 200 L/R	85	R	
	NP 50 D 'Melody Mini'	83	R	AEON			
	NS 50 'Melody'	82	R	OZ 125 (4T)	13	R	
	NU 50 MC 'Runaway'	82	R	OZ 150 (4T)	13	R	
	NV 50 MSD 'Stream'	84	F&R	CO IN ECO (Electric)	13	R	
	NX 50 A/B/MB 'Caren'	80-82	R	CO IN 125 (4T)	13	R	
	NH 80 MD-D/MD-G	83-86	R	ARCTIC CAT			
	NH 80 Lead 80	85	R	150 Utility 2x4	09-18	F	
	PX 50	82-83	R	BAOTIAN			
	QR 50 D/E/F	83-87	R	BT 49 QT-7	06-07	R	
	BAROSSA			BT 49 QT-9F3 Eagle 50	10-11	R	
	Mini 50/Python	03-05	R	BT 49 QT-9 (Speedy 50-4T)	10-11	R	
	KYMCO			BT 50 QT-11 (Retro 50-4T)	06-11	R	
	DJ 50 Refind		R	BT 49 QT-12 (Rebel-4T)	06-11	R	
	QUADZILLA			BT 49 QT-12 (Rocky-2T)	10-11	R	
	Buzz 50	03-06	R	BT 110-2	06-07	R	
	SYM			Eagle 50	10-11	R	
	Fiddle 50	99-05	R	CPI			
	H303	HONDA			50 Hussar	01	R
	H303G	C 50 (All Models)	75-93	F&R	50 Mars	01	R
C 50 N (Single seat model)		95	F	DAELIM			
C 50 P/S/N/X/Y/1/2		96-02	F	A-Four (50CC) (SJ 50 R)	06-09	R	
CF 50 'Chaly'		79	F&R	E-Five (SJ50A)	04-06	R	
PK 50 Wallaro All models		90-01	R	'S' Five (SJ50)	01-12	R	
SFX 50 S/T/V/X/Y/1		95-04	R	Delfino 100 (SH100)	01-04	R	
SGX 50 V/W/X/Y/1		97-03	R	Otello 125 (NS 125) DLX	00-02	R	
SH 50 E/H/K/M/P/DP 'City Express'		85-96	F	History 125 (SL 125) Parking brake	01-06		
SH 50 T 'Fifty/Scoopy W/X/Y/1'		97-03	R	E-TON QUADS			
SJ 50 P/R/S/T/V/W/X 'Bali'		93-99	R	CXL 150 Challenger	02-07	F	
SRX 50 T/W/X Joker/Shadow		97-99	R	RXL 150 Viper R	05	F	
SS 50 ZK2		75-77	F&R	RXL 150 Viper	07	F	
SS 50 ZB2		77-80	R	YXL 150 Yukon	00-02	F	
ST 50 'Dax' J/K		78-93	F&R	GOCCIA (ELECTRIC SCOOTERS)			
SXR 50 W/S/X/SX		98-99	R	E-Gora (Li/Si)	12-15	R	
TC 50 M/P/V "Gyro Canopy"		96-00	F	Sunday	12-15	R	
C 70 (All models)		75-85	F&R	HONLEY			
CF 70/C		77-78	F&R	Classic 125	16-17	F&R	
NF 75		79	F&R	KM			
SA 75 Vision		89-	F	Badboy 50/100 CX	05	R	
SH 75 Scoopy H/K/M/P/DP/S/DS		87-95	F				

Part No.	Make/Model	Year		Part No.	Make/Model	Year	
H303 Contd. H303G	LEXMOTO			H303 Contd. H303G	KYMCO Contd.		
	FMR 50 (WY50QT-58R)	15-18	R		Agility RS 50 Naked (2T/12" wheels)	10-15	R
	Milano 50 (FT50QT-27)	16-18	R		Bet & Win 50/Dink Sports 50	02-06	R
	Molly 50 (DFE50QT-3)	15-18	R		Calypso 50/125	99	R
	FMR 125 (WY125T-74R)	14-18	R		Dink 50 (4T)	07-14	R
	FMR 125 EFI (WY125T-74R-E4)	14-18	R		Super 9 (A/C)	00-07	R
	Milano 125 (FT125T-27)	16-18	R		Cobra Racer	00-06	R
	Tommy 125 (ZN125T-E)	11-17	R		Cobra 50 Cross	00-06	R
	MOTO ROMA				Grand Dink 50 (2T)	04-15	R
	Wasp 50	99-03	F		Grand Dink 50 S	12-13	R
	PEUGEOT				DJ 50 S	12-15	R
	Django 50 Allure (2T/4T)	14-18	R		Kymcosenti 50i	13	R
	Django 50 Heritage (2T/4T)	14-18	R		Newsento 50i	13	R
	Django 50 S (2T/4T)	14-18	R		SJ 125 S	12-13	R
	Django 50 S (2T)	14-18	R		Like 50 (2T)	09-15	R
	Django 50 S (4T)	14-18	R		Like 50 LX (4T)	09-20	R
	Blaster 50 RS12 (2T)	09-10	R		Sento 50	08-15	R
	Kisbee 50 (2T/4T)	10-14	R		Vitality 50 (2T/4T)	04-09	R
	Kisbee RS 50 (2T/4T)	10-14	R		Cobra 100 Racer	99-03	R
	Looxor 50	01-06	R		Fever ZX 50/Scout	99-03	R
	Ludix 50cc One	04-10	F&R		Dink 50/Spacer 50/Yager 50	98-06	R
	Ludix Snake 50cc	04-09	R		Dink 50 (4T)	07-12	R
	Ludix Bullet 50cc	04	R		Dink Classic Euro 2 50	03	R
	Ludix Trend 50cc	04-07	R		DJW 50 World	95-97	F
	Ludix Elegance 50cc	04-09	R		DJX 50	91-92	F
	Ludix Ambition 125cc	04	R		DJY 50 Refined	93-06	F
	Ludix Classic (14" wheels)	04-05	F&R		K12 Sport 50	95-00	R
	Ludix Urban Track	06-07	R		KB 50	95-00	R
	Ludix Red Zone	06	R		Sniper 50	93	R
	Ludix Acid	06	R		CX 50	93	F
	Ludix Blaster (10" wheels)	05-09	R		Heroism 50	95-97	R
	Ludix 2 Trend 50cc (2T)	07-12	R		Grand King 125/150		F&R
	Ludix 2 Biposto 50cc (2T)	07-09	F&R		Filly 50	98-00	F&R
	Ludix 2-One Biposto (2T) (10" wheels)	10-12	F&R		Filly LX 50	00-06	R
	Ludix 2-One Monoposto (10" wheels)	10-11	F&R		KB 50 Scout	97	R
	TRK 50 (2T) (10" wheels)	09-12	R		Looping 50	98	R
	TRK 50 (2T/12" wheels)	09-12	R		Maxxer 50 (2T)	05-14	F
	New Vivacity 50 (4T)	08-11	R		MXU 50 (2T)	05-14	F
	Sixties Vivacity (Old model) 50 (4T)	10-11	R		Mxer 50/150 (Quad)	00-07	F
	Vivacity 50/100	04-07	R		Spacer 50	99-06	R
	Vivacity 2 (50cc) (10" wheels/190mm disc)	08-11	R		Top Boy 50	97-06	R
	Vivacity 50 12" wheels/190mm disc	92-07	R		Yager 50	07	R
	New Vivacity (50cc/2T) (12" wheels/200mm dia disc)	08-14	R		Agility 50 Basic	07	F&R
	New Vivacity Sixties (50cc/4T) (12" wheels/200mm disc)	10-14	R		Yup 50	01-09	R
	E-Vivacity (Electric)	11-14	R		ZX 50 Super Fever/Scout	99-06	R
	Metal X 50	02-03	R		Cobra 100 Racer	99-03	R
	SV 50 J (Front drum model)	91-95	F&R		KB 100 Manboy	97-00	R
	Elyseo 50/100	98-02	R		Top Boy 100	97	R
	Jet Force 50 H2i (2T/Air Cooled)	11-12	R		Activ 50/110/125	04-06	R
	V-Clic 50 (4T)	08-11	R		Visa R 50	11-15	R
	SV 50/80/125	91-95	R		Visa R 110	11-15	R
	Trekker 50 (2T) AJP Caliper	98-00	R		Agility 125 Carry (4T)	11-12	R
	Trekker 50 (2T) Heng Tong Caliper	98-00	R		Heroism 125	95-99	R
	Tweet 50	10	R		Visa R 125	11-15	R
	Trekker 100 (2T)	98	R		MXU 150 Quad	05-12	F
	TRK2 WRC 50 (2T)	04-06	R		LIFAN		
	Buxy/M/RM	94-97	R		LF 50 QGY		R
	Speedake	95-97	R		LF 50 QGY 1/2		F&R
	Speedfight 3 50cc (AC)	09-14	R		MASH		
	Speedfight 3 (A/C-4T)	09-14	R		Scrambler 125	14-16	R
	Streetzone 12 (50"/2T)	14	R		Seventy 125	14-16	R
	Squab	95-97	R		NIPPONIA		
	Zenith LS	96-99	R		Miro 125 (4T)	14-15	R
	Zenith M/N	96-00	F&R		SINNIS		
	Vivacity 50/100 (All models)	99-07	R		WY 50 QT-39A Ghost	06-10	R
	SV 100 L		R		Falcon 50 QM 50 QT-2T	08-10	R
	Fox/Fox L 50	94-98	F&R		Jet 50 QM 50 QT-6A	08-10	R
	V-Clic 50 (4T)	08-11	R		LJ 50 QT-H Phoenix 50 (Rear drum model)		R
	E-Vivacity (Electric)	11	R		ZN 50 QT-51 Flair 50	12-14	R
	Ludix Pro (14" wheels/4T)	11	R		ZN 50 QT-30A Strada 50	12-14	R
	Vox 110	12-13	R		SUPERBYKE		
	KYMCO				SB 125-4		R
	Active SR 50cc	08-11	R		SYM		
	Agility 50	05-08	R		E-Virid (Electric) Deluxe	12-15	R
	Agility 50 Carry (4T)	11-15	R		E-Virid (Electric)	12-15	F&R
	Agility 50 R10 (4T)	06-14	R		Orbit II 50 Naked (4T)	12-15	R
	Agility 50 R12 (4T)	06-21	R		Cinderella 50/100	99-00	R
					Red Devil	99-09	R

Part No.	Make/Model	Year		Part No.	Make/Model	Year	
H303 Contd. H303G	SYM Contd.			H304 Contd. H304G	HONDA Contd.		
	Jungle 50	99-02	R		MBX 125 FE	84-86	R
	Jet Sport 50	14-15	R		MTX 125 RWD	83-84	F&R
	Jet Sport 50 S	14-15	R		MTX 125 RWE/RWF/RWH/RWL	85-95	R
	Jet 4 (50cc 4T)	10-15	R		SL 125 K1D/E/F/G/K2A	76-80	F&R
	Jet 4 R 50 (2T)	11-15	R		TL 125	76	F&R
	Jet 4 R Naked (50/4T)	13-15	R		XL 125 K2	78	F&R
	Jet 50/Euro XS	99-05	R		XL 125 K3/K4	79	R
	Jet 50 Basix 50	06-09	R		XL 125 SZ/SA/SB/SC/RC	79-82	F&R
	Jet Euro X 50	06-14	R		XL 125 RF/RH	85-86	R
	Jet Evo 50 (2T)	13-15	R		XLR 125 RW	98-99	R
	Mio 50	05-15	R		XR 125 L3/L4/L5/L6/L7/L8	03-08	R
	Fiddle 50	99-05	F		CRF 150 F	03-20	R
	Fiddle II 50	08-15	R		XL 185 SZ/SA/SB	80-82	F&R
	Fiddle III 50 (4T)	14-21	R		CTX 200/CTA 200 A Bushlander	04-16	R
	City Hopper 50	99-02	R		MTX 200 RWD	83-84	F&R
	Mask 50	00-05	R		MTX 200 RWF	85	R
	Orbit 50	08-09	R		TL 200 J/Y 'Colin Seeley'	76-78	F&R
	Orbit II 50 (4T)	12-15	R		TLR 200 G/H	86-87	F
	Orbit II 50 Naked (4T)	12-15	R		XR 200 R	81-02	F&R
	Orbit II 50 TS (4T)	12-15	R		XR 200	80-84	F&R
	Super Fancy 50	96-02	R		TLM 220 R	88-92	R
	Simply 50	07-08	R		CRF 230 F	04-20	R
	Symply II 50	09-14	R		CBX 250	84-98	R
	Tonik 50 (4T)	11-15	R		RTL 250 SG	86	F&R
	X-Pro 50	13-15	R		TL 250 K1	79	F&R
	Jet 100 (G100P-6)	99-00	R		TLM 250 RJ	89	F&R
	Mio 100	05-15	R		TLR 250 F	85	F&R
	Symba 100	11-12	F&R		XR 250 RE/RF/RG/RH/RJ/RK	84-89	R
	Evie (Electric Scooter)	10	F&R		XR 350 RD/RE	83-84	R
	Symmetry-Electric	11	F&R		XR 500 RD/RE	84-85	R
	E W00 Elettrico	11	R		XR 600 RF/RG/RH/RJ/RK/RL	85-90	R
	Orbit 11/Symply 125 (4T)	09-14	R		HARTFORD		
	TAMORETTI				VR 125 Z Velo Sport	00-03	R
	Retro 50		R		VR 125 X/H Velo Cross	00-03	R
Retro 125		R	HERO				
			CD Dawn 100cc 4T	08	R		
			CD Deluxe 100cc	08	R		
			Passion Plus 100cc	08	R		
			Splendor NXG 100cc	08	R		
			Splendor Plus	08	R		
			Super Splendor 125cc	08	R		
			Glamour PGM Fi 125cc	08	R		
			Glamour 125cc	08	R		
			HONDA HM (ITALY)				
			CRF 230 F Easy Trial (All models)	04-07	R		
			HONGDOU				
			GY 125	06-08	R		
			LIFAN				
			LF 50 QGY		R		
			LF 50 QGY 1/2		F&R		
			Smart 50/125		R		
			LF 100 A		R		
H304 H304G	HONDA			H306 H306G	HONDA		
	C 50 N (Single seat model)	95	R		TRX 90 Fourtrax/Sportrax (All models)	93-06	R
	C 50 P/S/N/X/Y/1/2 (Single seat)	96-02	R		TRX 90 EX	07-08	R
	CB 50 J	81	R		TRX 90 X9/XB/XC	09-21	R
	CD 50 ST/SV/SW/SX Benley 50 S	96-99	F&R		ATC 110 (All models)	79-84	R
	CL 50 V/X Benley CL50	97-99			CRF 110 FD/FE/FF/FG/FH/FJ/FK	13-19	F&R
	CRM 50 RN/RP/RR/RT	93-96	R		TRX 125 J	88	R
	MB 5 S	80-82	R		ATC 125 ME/MG	84-85	R
	MBX 50 SD/SF	83-85	R		Wolf 125/150 Scooter	00	F
	MG 50 S/X/1/3 Magna 50	95-03	R		CD 175 (All models)	67-79	F
	MP 50 3/DX3 (AC17) Solo	03	F&R		ATC 185 A/SB	80-81	R
	MRX 50	88-	R		ATC 200 B/ESE/ESF/SE	81-84	R
	MT 50 SA/SE/SG/SJ/SL	80-93	F&R		TRX 200 L/M/DM/DN	90-93	R
	MTX 50 SC	83-84	F&R		TRX 200 D	91-97	R
	NSR 50 FP/FR/FS	93-95	R		TRX 200 L/M Fourtrax	90-91	R
	NSR 50 SK/SP/SR/SS	89-95	R		TRX 200 SX	86-87	R
	TC 50 Y/2 Gyro Canopy	00-02	F		ATC 250 RB/RC	81-82	R
	XZ 50 1/2 APE-AC16	01-02	F&R		ATC 250 ESF/ESG/ESH/ESJ	85-88	F
	CRM 75 RK/RL/RM/RP/RR	89-94	R		FL 250 Odyssey	77-84	R
	XR 75 K4	75-78	F&R		KEEWAY		
	CR 80 RA/RB	80-81	F&R		Goccia 50 (2T/4T)	08-14	R
	CR 80 RC	82	F		POLARIS		
	CR 80 R2F/R2G	85-86	F&R		200 Phoenix (AA/AB Model /rear drum model)	05	R
	MB 80 (MB8)	80-	R				
	MBX 80 FWDD/FEDF	83-86	R				
	MCX 80	82-	R				
	MTX 80 RFD/RFF	83-84	F&R				
	NSR 80	86	R				
	XR 80 Z/A/B	80-81	F&R				
	C 90 All models	93-03	F&R				
	CB 100 N	78-80	R				
	XL 100 (All Models)	78-82	F&R				
	XZ 100 2 APE-HC07	02	F&R				
	CT 1100 A/B/C/D/K/M	80-88	R				
	CT 110 X	05-09	F				
	CB 125 J	79	R				
	CBX 125 Custom	88-	R				
	CG 125 S/T/W/M1	98-02	R				
	CLR 125 W 'City Fly'	98-02	R				
	CLR 125 X/W/Y	99-	R				
	CR 125 M2/M4	76-78	F&R				
	CT 125 C	85	F&R				

Part No.	Make/Model	Year		Part No.	Make/Model	Year		
H306 Contd. H306G	POLARIS			H309	HONDA Contd. SL 350 K1/K2 XL 500 SB	70-73	R	
	200 Phoenix (AC/AD Model and following/rear drum model)	06-09	R			81	R	
	200 Phoenix (Rear drum model)	10-14	R					
	200 Sawtooth (Rear drum model)	06-08	R	H310	HONDA			
H307 H307G	HONDA			H310G	ATC 70 (All models)	78-85	R	
	Wolf 125/150 Scooter	00	R		CB 125 K1 to K5	72-76	R	
	CD 175 (All models)	67-79	R		CB 125 K6/S2	76	R	
	APACHE				CB 125 T/T2	78-79	R	
	Mini Tomahawk 50 (4T)	08-09	R		CB 125 RS	83	R	
	ARCTIC CAT				CB 125 TDC/TDE/TDJ	83-89	R	
	50 Y-6 Youths (2x4)	04-05	F		CBX 125 TS Custom	82-	R	
	ARCTIC CAT Contd.				CD 125 TC	78	R	
	90 Y-12 Youths (2T & 4T Models)	02-05	F		CM 125 CC/CF	82-85	R	
	90 2x4 (4T) Youth				CD 185 T	78	R	
	Rear Drum Model	04-05	R		CD 200 TA/TB	79-80	R	
	90 2x4 (2T) Youth	02-04	R		CM 200 TA/TB	79-80	R	
	CAN-AM				CD 250 UJ	89-92	R	
	DS 70	08-15	R		CB 250 N/T/W/X/Y/1/4 'Two fifty'	92-05	R	
	DS 90 (2X4/4T)	07-15	R		DAELIM			
	KYMCO				VL 125/L Daystar	03-14	R	
	Maxxer 50 (2T)	05-14	R		VS 125 Evolution R	01-04	R	
	CK 1 125 (4T/KT25AA)	14-15	R		KYMCO			
	CK 125 Pulsar 11 (KE25RF)	08-10	R		CK 125 Pulsar	99-00	R	
	CK 125 Pulsar S	11-15	R		SYM			
	PEUGEOT				XS 125 K	07-15	R	
	New Tweet Evo 50 (4T/Rear drum model)	14-20	R		SINNIS			
	Kisbee 100 (4T)	12-15	R		QM125 GY-2XR Retro Star 125	12-14	R	
	Streetzone 100 (4T)	14-15	R		QM125 GY-2X Cafe 125	12-14	R	
	POLARIS				Trackstar 125 (4T)	10-12	R	
	50 Outlaw	08-14	R					
	Predator 50 (2 stroke)	04-06	R		H311	HONDA		
	Scrambler 50	01-03	R		XL 250 K3/K4	78-79	F	
	90 Outlaw	07-14	R					
	Predator 90	03-06	R		H312	HONDA		
	Scrambler 90 X	01-03	R		H312G	CD 125 TC	78	F
	Sportsman 90	01-14	R			CM 125 CC/CF	82-85	F
	QUADZILLA					CD 185 T	78	F
	4-Cross 200cc		F			CD 200 TA/TB	79-80	F
	ROXON					CM 200 TA/TB	79-80	F
	Fox 50 (Quad)	04-06	R			CL 250 SC	81	F
	SYM					XL 250 S/SZ/SA/SB	78-82	F
	X'Pro 50	13-15	R			XR 250 SZ/SA	79-80	F
	Symphony 50 (4T)	09-10	R			XL 250 K3/K4	78-79	R
	Tonik 110 (4T)	11-13	R			XL 500 SZ	80	F
	Fiddle II 125	08-15	R			H313	HONDA	
	Fiddle III 125 (4T)	14-21	R		H313	CB 250 T/N/NA/NB/ND/NDB/NDC	78-82	R
	Jet 4 (125cc 4T)	10-15	R			CM 250 TB	81	R
	Simply 125	07-08	R			CB 350 SG/SJ	86-90	R
	Symply II 125	09-13	R			CB 400 A 'Honda-matic'	79	R
	Symphony 125 (4T)	09	R			CB 400 T	78	R
	125 Attila	99-00	R			CB 400 N/NA/NB/NC	78-82	R
	Super Duke 125/150	99-02	R			CB 450 SG/SJ	86-88	R
	X'Pro 125	11-15	R			CMX 450 CH/CJ Rebel	87-88	R
	Jet 4 150cc	13-15	R	VT 500 ED/EF		83-85	R	
Fiddle II 151	08-15	R	H314	HONDA				
TAMORETTI			H314	CB 250 K3-K5	73-75	F		
Stealth 125		R		CB 350 K4	74	F		
TOMOS				SL 350 K0	69-70	F		
Twister 50		R	H315	HONDA				
Twister 125		R	H315G	ATC 250 ESF/ESG/ESH/ESJ	85-88	R		
YAMAHA				CB 250 K3-K5	73-75	R		
YFM 09 RYXG/H (Raptor)	16-18	R		CB 250 G5	75	R		
YZF 50 Y	17-18	R		CJ 250 T	77	R		
H308	HONDA			MXV 250 F (MC92)	83-88	R		
CB 125 K1 to K5	72-76	F		TRX 250 F/G/H	85-87	R		
CB 175 (All models)	74-76	F		TRX 300 FWJ/K/L/T/N/W/X/Y	88-00	R		
SL 350 K1/K2	70-73	F		TRX 300 J/K/L/T/N/W/X	88-99	R		
H309	HONDA			CB 350 K4	74	R		
CB 175 (All models)	74-76	R		SL 350 K0	69-70	R		
CB 200 B	76-79	R		CB 360 G5	75	R		
CB 250 RSA/RSD	81-84	R		CJ 360 T	78	R		
CL 250 SC	81	R		CB 400 F/F1/F2	75-79	R		
CBR 250 FG/FGYA (MC14)	86	R						
VT 250 FD	83	R						
VTZ 250 H/J/K	86-88	R						

Part No.	Make/Model	Year		Part No.	Make/Model	Year	
H316	HONDA CB 500 T CB 500 K1/K2/F CB 550 F/F1/F2/K3	75-77 75-77 78-80	R R R	H322 Contd.	PUCH Maxi 50 (N/NK) Spoke wheels 1 Speed Automatic Solid Rear Frame Maxi 50 (SW/SKW) Spoke Wheels/1 Speed Automatic With Rear Suspension Maxi 50 (Spoke Wheels /2 Speed Automatic With Rear Suspension Maxi 50 Executive Cast Wheel With Screwed In Hub/1 Speed Automatic Maxi S 50 Sport Cast Wheel With Screwed In Hub/ 1 Speed Automatic Maxi 50 Super Cast Wheel With Screwed In Hub/ 2 Speed Automatic	73-80 73-80 73-80 F&R F&R	F&R F&R F&R F&R
H318 H318G	HONDA CA 125 S/T/V/W/X/1 CBX 125 F NES 125 Y (@ 125 Scooter) VT 125 CX-C8 'Shadow' XL 250 SB CBX 250 RSE CMX 250 CT/CV/CW/CX 'Rebel' GB 250 E/H Clubman GB 250 J/L/P/S/V "Clubman" XL 400 R XL 500 SZ XL 500 RC XR 500 SZ/SA XR 500 RB XL 600 RD/LD/RE/LE/RF/RG/RH XL 600 LMF/RMG/LMH XL 600 VH/VJ/VK 'Transalp'	95-01 84- 00-01 99-08 82 84 96-00 84-87 88-97 82 80 82 79-80 81 83-87 85-87 87-90	R R R R R R R R R R R R R R R R R R R	H323 H323G	HONDA NX 250 J/K/L/M/P/2P XL 250 Degree (MD26) XL 250 S/SZ/SA XL 250 RC XL 250 RE/RF XLR 250 Baja MK1 (MD22) XR 250 SZ/SA XR 250 RB/RC/RD	87-93 78-81 82 84-85 79-80 81-83	R R R R R R R
H319 H319G	HONDA CR 125 RC CR 450 RB	82 81	F R	H324 H324G	HONDA CR 125 RZ/RA/RB CR 250 RZ/RA XR 500 SZ/SA	79-81 79-80 79-80	F F F
H320	HONDA CB 650 Z/B CB 650 SCC 'Night Hawk' CB 750 K0-K6 CB 750 K7 CB 750 KZ	79-81 82 69-77 78 80	R R R R R	H325 H325G	HONDA CR 250 RZ/RA XL 500 SB	79-80 81	R F
H321	HONDA VT 250 CR/CT/CV "Magna" NV 400 CJ/CK "Steed" NV 400 CS/CV Steed CB 500 R/T CX 500 CA/CB/Z/A/B CX 500 CC GL 500 DC VT 600 CN/CR/CS/CT/CV/CW Shadow Custom GL 650 D2-E VF 750 SC (V45 Sabre) KYMCO Venox 250 (R 20010/RA50AA /Carb Model) Venox 250 (RFBR20011/ RA50AD/Carb Model) Venox 250 (R20012/ EFI Model)	95-97 92-93 95-97 94-96 79-81 82 82 93-99 84 82 00-03 04-06 07-14	R R R R R R R R R R R R R	H327 H327G	HONDA CR 250 RB XR 250 RB/RC/RD CR 450 RB CR 480 RC XR 500 RB	81- 81-83 81 82 81	F F F F F
H322	HONDA PA 50 Camino (Spoke wheel) PF 50 M 'Novio PX 50 KREIDLER 50 MF2 50 MF4 later models 50 Flory MF 20/22 50 MP1 later models KTM 50 SX/SXR Pro Junior/Senior /Adventure 50 SX Mini Adventure 50 SX Pro Senior LC 50 SX Pro Senior LC 50 SX Senior Adventure MOTOBECANE 50 all mod. Atom hub 50 all mod. Leleu hub 51 VLM PEUGEOT Most Mofas/Mopeds 103 Pro, SP 3	79-86 75 82-84 96-03 04-07 02-03 02-07 02-07 88- 88-	F&R F&R F F&R F&R F&R F&R F&R F F R R F F F&R F&R	H328 H328G	HONDA CR 250 RC/RD CR 480 RD	82-83 83	F F
				H330 H330G	HONDA CG 125 BR-K/BR-T/95/ S/T/W/M1/1 CR 125 RZ/RA/RB/RC CR 250 RB XL 250 RC XL 250 RE/RF CR 480 RC CAN AM DS 90 Mini 4 stroke (3C7A) DERBI DFW 50 Quad KAZUMA Falcon 110 Quad LAVERDA Quasar 50/100 Quasar 50 Quasar 100 Quasar 125 HP Grip Quasar 125 HP Quasar 180 HP Grip Quasar 180 HP MOTO ROMA Sport 90 Quad Blazer 50/100/110 Quad Quad Roadrunner 100 E-TON IXL 40 Rascal RXL-40E Viper Junior	85-03 79-82 81- 82 84-85 82 07-11 04-05 R 04 02-04 02-04 02-04 02-04 02-04 01-03 99-04 04 98-01 01-06	F F R F F R R R R R R R R R R R R R R

Part No.	Make/Model	Year		Part No.	Make/Model	Year	
H353 Contd.	PEUGEOT Contd.			Y503 Contd. Y503G	YAMAHA Contd.		
	Streetzone 50 (2T)	14-18	R		YFM 80 WP/WR/WS/RT/RV /RW/RX Raptor	02-08	F
	New Vivacity (50cc/2T)				YFM 80 GT/GV/GW/GX Grizzly	05-08	F
	(12" wheels/200mm dia disc)	08-15	R		TT-R 90 M/N/P/R/ES/S/T/ET/EV/EW	00-07	R
	New Vivacity Sixties (50cc/4T)				AG 100 J (3HAA)	82	F
	(12" wheels/200mm disc)	10-15	R		AG 100 E 'Farm Bike'	93	F
	Speedfight 3 (A/C-2T)	09-15	R		RT 100 E/F/K	93-03	F&R
	Speedfight 3 Darkside (A/C-2T)	14-15	R		YB 100	82-86	R
	Speedfight 3 Iceblade (A/C-2T)	14-15	R		YB 100	87-92	F&R
	Streetzone 12 (50"/2T)	14-18	R		YZ 100 J/K	82-83	F
	Speedfight 4 Classic (A/C-2T & 4T)	15-19	R		TT-R 110 E	08-21	R
	Speedfight 4 Darkside (A/C-2T & 4T)	14-18	R		RX 115 (5FS3)	99	R
	Speedfight 4 Iceblade (A/C-2T & 4T)	14-18	R		YFM 125 S/GT/GV/GW/GX/GY /GZ/GA/GB/GD Grizzly	04-14	F
	Speedfight 4 Pure (A/C-2T & 4T)	14-18	R		SR 125 (3MW2)	89-91	R
	Speedfight 4 20 Ans Edition (50cc/AC/2T)	18	R		SR 125 SE	82	R
	SUZUKI				SR 125	97-02	R
FL 125 SDWK7/SDWK9 Address /Underbone	07-10	R	TT-R 125 M/N/P/R/ES/S/T/ET /EV/EW/EX/EY	00-09	F&R		
Y501	YAMAHA			TT-R 125 LWM/LWN/LWP/LWR/LWES /LWS/LWET/LWT/LV/LEV/LEW/LEX /LWX/LEY/LWEZ/LWEA/LWED/LWEE	00-14	R	
	CG 50 'Jog'	88-92	F	TW 125 (5EK)	99-02	R	
	CA 50 'Salient'	83-85	F	XC 125 T	95-98	R	
	MA 50 M 'QT50'	80-86	F&R	XC 125 TR 'Cygnus'	96-03	R	
	MJ 50 M 'Towny'	82	F&R	XT 125	82	R	
	MS 50	85-86	F	AG 200 E (3GX6)	93	F	
	PW 50 H/J/K/S/U/90/93-18	80-21	F&R	TW 200 (2JL/4CS1/2/3/5)	91-98	R	
	SA 50 M/ME 'Passola'	80-84	F	TW 200 E (4CS4/6/5LB1/2)	98-01	R	
QT 50	93	F&R	YTM 200 EL/DX	89	F		
Y502 Y502G	SUZUKI			YFS 200 B/F/G/H/J/K/L/M/N/P 'Blaster'	91-02	F	
	RM 80 XZ/XD/XE/XF/XG/XH/XJ/XK	81-89	R	YFM 200 N	85	F	
	YAMAHA			YFM 200 DXW/DX/DXA	89-90	F	
	YZ 50 G/H/J/K	80-83	F&R	ST 225 (5BT) Bronco	97	R	
	TY 80	77-	F	TW 225 E (5VC1/2)	02-03	R	
	YZ 80 D/E/F	77-79	F	XT 225 (2LN) Serrow (1KH 20101-)	86-87	R	
	YZ 80 G/H/J/K/L/N	80-85	F&R	XT 225 (3RW1-5 Serrow) (1KH 034101-132000)	89-93	R	
	YZ 80 S/T/U/W	86-89	R	XT 225 S (3RW3) (1KH 102101-109000)	92	R	
	PW 80 K/S/91	83-91	F	YTM 225 DRN	85	F	
	PW 80	93-13	F	YFM 225 S/T/U	86-89	F	
	TT-R 90 M/N/P/R/ES/S/T/ET/EV/EW	00-07	F	YFAI W/A/B//F/G/H/J/K/L /M/N/P/R Breeze	89-03	F	
	TT-R 110 E	08-21	F	YFB 250 D/E/F Timberwolf	92-94	F	
Y503 Y503G	YAMAHA			ADLY			
	BWS 50 Next Generation	99-07	R	Jet 50/100		R	
	BW's 50 (5WW1)	04	R	SF 50 Silver Fox 50	06-09	R	
	BW's R 50 (5SX1)	01	R	City Bird		R	
	BW's 50 Naked (1D11/2B71)	03-04	R	Predator 50/100		R	
	CR-Z 50 (3WN)	91-95	R	Fox 50		R	
	CS 50 Jog R	02-05	R	Panther 50/P50	02-09	R	
	CS 50 Z (Jog RR)	03-05	R	Cosy 50/80	02-06	R	
	CT 50 S (3NT6)	90-95	F&R	Road Tracer 50/90/100	04-06	R	
	CT 50 SS (3NTC)	92-95	F&R	SS 50 1/11 Supersonic	04-05	R	
	CW 50	02	R	SS 100 1/11 Supersonic	04-05	R	
	CW 50 RS	96-05	R	APACHE			
	CW 50 RSP	97-98	R	RLX 150 S		F	
	DT 50 MX	92-95	F&R	BAROSSA			
	EW 50 "Slider"	00-05	R	100 Sport/Python	03-05	F	
	YSR 50 T	87	R	170 Cheetah	03-06	F	
	CY 50 RS 'Jog R'	96-	R	250 Cheetah	03-06	F	
	DT 50 R	97-01	R	Veloce 50	08-10	R	
	DT 50 LC	99	R	Veloce GT 50	08-10	R	
	RZ 50 (5FC1/2)	02	R	BENELLI			
	TT-R 50 EV/EW/EX	06-08	R	Pepe LX 50 (2T) (7 spoke cast wheel)	03-09	R	
	YA 50 R Axis (4PC)	95-96	R	Pepe Classic 50 (2T) (7 spoke cast wheel)	07-14	R	
	YA 50 ZA Jg Z (4SC1)	95	R	Quattro Nove X (50cc) (All rear drum models)	08-12	R	
	YH 50 'Why'	98-09	R	BSM			
	FIZ	97-	R	TB 100		R	
	YM 50 Breeze (4KH)	94-95	R	CPI			
	YJ 50 R (5AU1-3) Vino	98	R	Aragon GP Paddock	08-12	R	
	YN 50 R Neos (5AD/5MR/5RN3)	97-02	R	Aragon Club 50	07-12	R	
	YN 50 Neos (5RN/1P9)	02-06	R	Aragon S-Line 50/125	07-12	R	
	YV 50 (5BM2) Jog Space Innovation	97-	R	Baby J 50	02	R	
	YFM 50 S/T/RV/RW/RX Raptor	04-09	F				
	PW 80	93-13	R				
	CV 80 Beluga	81-83	F&R				
	TY 80	83	R				
	YFM 80 D/E/F/G/H/J/K/L/M/N Badger	92-01	F				

Part No.	Make/Model	Year		Part No.	Make/Model	Year	
Y503 Contd.	CPI			Y503 Contd.	KREIDLER		
Y503G	Bravo 50	12	R	Y503G	50 Flory Classic (50CC/4T/A-C)	14-15	R
	Formula 50 R	07-12	R		50 Florett City (50cc/2T/A-C)	14-15	R
	Freaky 50	07	R		50 Florett 2.1 RS (50cc/2T/A-C)	14-15	R
	Oliver 50 (All models)	03-12	R		MALAGUTI		
	Popcorn 50	02	R		Malbo Line - DVD 50 (2T)	10-11	R
	50 Hussar	01-05	R		MBK		
	Aragon 50	07-09	R		CR 50 Z Target	91-95	R
	Aragon GP50	07-12	R		CS 50 Mach G AC (Air cooled)	02-05	R
	Aragon S Line 125	07-12	R		CS 50 Mach G LC		
	Bravo 125	12	R		(Liquid Cooled)	03-05	R
	DAELIM				CT 50 S 50RR 150	91-92	F&R
	M 50 D/MD Millenium	03	R		CT 50 SS Sorriso	93-95	F&R
	DX 50 D Camper	03	R		CV 50 Evolis	97	R
	ST 90 Pro Monkey	03	R		CW 50 Booster Naked		
	DERBI				(10" wheels)	06-10	R
	DXR 200 Quad	04-05	F		CW 50 Booster 10" wheels	09-10	R
	DXR 250 Quad	04-05	F		CW 50 RS 'Booster' 'Spirit'	99-06	R
	DINLI				CW 50 RSP "Rocket"	97-98	R
	QZ 125 CUV		F		CW 50 Fizz 50	93-97	R
	GARELLI				CW 50 RS Booster NG	95-06	R
	Queenie	95-	R		CW 50 RSX Booster Track	96-98	R
	Grinta	95-	R		CW 50 Booster	90-91	F&R
	FX 50		R		CW 50 Booster	92-94	F&R
	XO 50	09-	R		CW 50 Booster (12" wheels)	06-10	R
	GENERIC/KSR				CW 50 Power Rocket	06	R
	Vionis (Electric)	18	R		CW 50 Booster Spirit	96-98	R
	Classic 50	17-18	R		CW 50 Booster Spirit	09	R
	Cracker 50 (2T/4T)	09-18	R		CW 50 Naked Booster 12" wheels	09-10	R
	50 GT Race Explorer	09	R		CY 50 Forte/Forte Mufa	96-97	R
	Epico 50 (2T)	10-18	R		EW 50 'Stunt'	00-06	R
	Pandora 50 (2T/4T)	13-18	R		EW 50 Stunt Naked	05-10	R
	Onyx 50 (2T/4T)	10-18	R		YA 50 R Forte	94-95	R
	XOR 50	05-14	R		YA 50 TA Sorriso	95-96	F&R
	Ideo 50	05-14	R		YE 50 Evolis	92-95	R
	Jump 50 (2T)	12-18	R		YH 50 'Flipper'	98-10	R
	Race 2 50 (2T/4T)	10-14	R		YM 50 Fizz	94-95	R
	Roc 50	08-11	R		YN 50 Ovetto (4T)	09-10	R
	Sirion 50 (2T/4T)	12-18	R		YN 50 R Ovetto (2T)	98-10	R
	Toxic 50 Sport	12-18	R		CV 80 Evolis	97	R
	Vertigo 50 (4T)	12-14	R		XC 125 Flame 125	96-03	R
	Race 2 125 (4T)	10-14	R		XC 125 T Flame	95-96	R
	Sirion 125 (4T/Rear Drum Model)	12-18	R		MOTO ROMA		
	Vertigo 125 (4T)	12-18	R		G10 (50cc/2T)	11-12	R
	HERCULES (SACHS)				Go-Go 50	97-05	R
	80 CV		F&R		Stinger 50	99-05	R
	JORDAN				Wasp 50	99-05	R
	Easy 50/100	03-04	R		Grand Prix 50/110	99-03	R
	KEEWAY				Roadrunner 50/100	01-02	R
	Agora 50 (4T)	10-15	R		Scrambler 50	01	R
	ARN 50 (25/45)	10-11	R		Lambros 125 (4T)	11-12	R
	Flash 50 Electric	09-10	R		MUZ		
	Goccia 50 (2T/4T)	08-15	R		Moskito FB 50	97-03	R
	Hurricane 50	07-14	R		Moskito SX UP50	00-03	R
	Hurricane 50-Base	07	R		POLARIS		
	RY6 50 (25/45)	10-14	R		250 Cyclone X	87	F
	RY8 (50 All models)	07-09	R		Scrambler (3 wheeler)	85-86	F
	RY8 SP 50 (25/45)	10-11	R		Trail Boss 2x4	85-87	F
	Focus 50	06-09	R		QUADZILLA		
	Matrix 50	06-12	R		Black Max M100 (SE)	06	F
	Easy Hurricane 50 (25/45)	07-12	R		Pro Shark (Double A Arms)		F
	F-Act 50	07-10	R		X 100 E (XLC)	06	F
	F-Act 50 RS	10-11	R		Pro Shark	06	F
	F-Act Evo 50 City (2T)	09-15	R		Pro Shark 100 R MX	07	F
	F-Act-NKD 50	09-11	R		Stinger R 170 E	06	F
	F-Act Racing 50 (25/45)	10-12	R		ST 200 E (Automatic)	06	F
	Flash 50	07-10	R		PGO		
	Hacker 50	08-09	R		My Bubú 50	03	R
	Pixel 50	08-12	R		WK BIKES		
	Swan 50 (25/45)	10-11	R		Bellisimo 50 (4T)	13-15	R
	50 Zahara (2T/4T)	13-14	R		Mii 50 (4T)	13-15	R
	F-Act 100	08-10	R		WK One 50 (2T)	10-11	R
	Matrix Electric	09-10	R		WK GP2 (50/2T)	10-13	R
	Matrix V4 50 (25/50)	10-11	R		WK GO 50 (4T)	11-15	R
	Matrix 50	06-11	R		Bellisimo 125 (4T)	13-15	R
	ARN 125	06-12	R				
	F-Act 125	07-11	R				
	125 Zahara (2T/4T)	13-14	R				

Part No.	Make/Model	Year		Part No.	Make/Model	Year	
Y504	CPI			Y506	CPI		
Y504G	Popcorn 50	03-06	R	Y506G	Oliver 125	06-12	R
	YAMAHA			Contd.	KEEWAY		
	DT 50 M/MX	78-86	F&R		110 Kee	12-14	R
	FS1E	74-76	F&R		110 Target	13-15	R
	FS1E 'DX'	77-79	R		Arn 125	07-10	R
	FS1 'DX'	79-80	R		F-act 125	07-09	R
	FS1 'SE'	81-82	F&R		Focus 125	07	R
	RD 50 M	78-80	R		Matrix 125	06-10	R
	RD 50 MX/RD 50 M	81-87	R		125 New Strike	13-14	F&R
	TY 50/50 M	77-80	F&R		RKS 125	10-14	R
	V 50 M/P	74-82	F&R		125 Strike	13-14	R
	V 70 A	76	F&R		125 Target	13-15	R
	V 75 A	77	F&R		Arn 150	06-10	R
	DT 80 MX	81-83	F&R		F-Act 150	07-10	R
	LB 2/80 'Bop 2'	80	F&R		Matrix 150	07-10	R
	RD 80 (Air Cooled) (LC)	82	R		150 New Strike	13-14	F&R
	TY 80	77	R		RKS 150	12-14	R
	V 80	79-82	F&R		150 Strike	13-14	R
	YZ 80 D/E/F	77-79	R		200 New Strike	13-14	F&R
	V 90	78	F&R		RKS 200	12-14	R
	DT 100	76-80	F		PEUGEOT		
	RS 100	75-80	F&R		Tweet 50 (4T/Rear drum model)	10-12	R
	RS 100 (IY8 Europe)	77-78	R		Sum Up 125	10-11	R
	RS 100 (IY8 Europe)	80-82	R		Tweet 125 (4T/Rear drum model)	10-12	R
	RS 100 (IY9 UK)	79-81	F&R		Vivacity Sixties 125 (4T)	11-12	R
	RS 100 DX	77-80	R		Vivacity 125 (4T)	10-15	R
	RS 100 DX (IY8 Europe)	79	R		Tweet 151 (4T/Rear drum model)	10-12	R
	RS 100 S (IY8 UK)	77-78	F		SACHS		
	YB 100	78-81	F&R		Bee 125	08-09	R
	YB 100	82-86	F		Roadster 125	00-03	R
	YZ 100 E/F/G/H	78-81	F		SINNIS		
	IT 125 G/H/J	80-82	F		Eagle 125 QM125T-10R	10	R
	TY 125	82	F		JS 125-6H ST125	13-14	R
	TY 175	77-80	F		JS 125-6C SC125	12-14	R
	TY 250 D/E	77-78	F		QM 125 T-Matrix	10	R
	TY 250 S/R	84-92	R		QM 125-2V2 Max II 125	12-14	R
					Max 125 QM125-2V	08-09	R
					Nitro 125 (WY125T-56A)	09-10	R
					YN 125 T-30A Strada 125		R
					ZN 125 T-22 Harrier 125	12-14	R
Y506	YAMAHA			Y507	YAMAHA		
Y506G	DT 80 LC (37A)	81-84	R	Y507G	YZ 125 C/D/E/F/G/H/J/K	76-83	F
	DT 80 LC-2 (53V)	85-92	R		IT 175 G/H/J	80-82	F
	YFM 80 S	87	R		IT 250 G/H/J	80-82	F
	DT 100	76-80	R		TY 250 H	81	F
	YZ 100 E/F/G/H/J/K	78-83	R		YZ 250 D/E/F/G	76-80	F
	AS3 125	71-72	R		YZ 400 D/E/F	77-79	F
	BL 125	85	R		IT 425 G	80	F
	DT 125 E/MX/LC	74-85	F&R		IT 500 G/H	80-81	F
	DT 125 LC	86-87	R				
	IT 125 G/H/J	80-82	R	Y508	YAMAHA		
	RD 125	73-74	R	Y508G	YZ 125 L	84	F
	RD 125 DX	75-77	R		YZ 250 J/K/L	81-84	F
	RD 125 LC (All models)	82-87	R		IT 250 L	84	F
	RS 125/125 DX	75-81	R		IT 465 H/J	81-82	F
	RZ 125 (1GV 030101-)	85	R		YZ 465 G/H	80-81	F
	SR 125 SE	82	F		IT 490 L	84	F
	TY 125	82	F&R		YZ 490 H/J/K/L	81-84	F
	SR 125 (3MW2)	89-91	F		TT 600 L	84	F
	TZR 125	87-89	F	Y510	YAMAHA		
	XC 125	92	R	Y510G	RD 125 DX	78-81	R
	XT 125	82	F		RS 125	75	F
	YBA 125 Enticer (3P01/3P41)	05-06	R		RD 200 DX	75-80	R
	YZ 125 C/D/E/F/G/H/J	76-82	R		RS 200	79	F&R
	YZ 125 T	87	R		DT 250 'All models'	75-80	R
	RX 135 (13X)	81	R		IT 250 H/J	81-82	R
	DT 175 (All models)	74-83	F&R		IT 250 L	84	R
	IT 175 G/H/J	80-82	R		SRX 250		R
	TY 175	77-80	R		TY 250 H	81	R
	DT 200 (2LR)	87	R		DT 400 All models	75-77	R
	SR 250 SE Special (3Y8)	81-83	R		SR 400 (3HT1)	88	R
	TY 250 D/E	77-78	R		SR 400 (2RD)	14-17	R
	XT 250	80	F&R		IT 465 H/J	81-82	R
	YZ 250 G/J/K/L/N/S/T	80-87	R		YZ 465 H	81	R
	XT 350	85-90	R		YZ 490 H/J/L/N/S/T/U	81-88	R
	YZ 490 K	83	R		IT 490 L	84	R
	TT 600 L	84	R				
	YFA1W/A/B Breeze	89-91	R				
	BAOTAIN						
	BT 125 T-7	06-07	R				

Part No.	Make/Model	Year		Part No.	Make/Model	Year	
Y510 Contd.	YAMAHA Contd. SR 500 SR 500 (3GW1/3/4/5/6/7) XT 500 XT 550 XT 600 XT 600 Z Tenere	78-82 96-98 76-80 82-83 84-86 84-88	R R R F&R R R	Y516 Contd. Y516G	MBK YP 250 Skyliner SINNIS Vista 125 QM 125 2C	96-98 08-10	R R
Y512	YAMAHA TX 500/XS 500 B XJ 550 XJ 550 H/J/K "Maxim" XZ 550 YX 600 S/SC/T/TC/U/UC/W/WC A/AC Radian XJ 650 G/H/J/K "Maxim" XJ 650 LH "Midnight" XV 750 SE XV 750 Virago	75-77 81-84 81-83 82-84 86-90 80-83 81 81 92-93	R R R R R R R R R	Y517 Y517G	YAMAHA YZ 125 K/L/N/S IT 200 L TY 250 S/R	83-86 84 84-90	R F&R F
Y513	YAMAHA RD 250/A YDS-7 250cc XS 250 C R5/5A/5B 350cc	73-74 72 81 70-72	F F F F	Y518 Y518G	YAMAHA FS1 T 50 'Townmate' V 50 M CW 50 T 'BWS' 'Bi-Wizz' CY 50 'Jog-in' DT 50 MX YZ 50 Zest YT 60 'Tri Zinger' YF 60 S DT 80 MX '36N type' MXS PW 80 K/S/91 T 80 'Townmate' V 80 DL RXS 100 T 105/105 E Crypton T 105 (5ER1/2) Crypton-R T 105 SE (SER3) Crypton-R New 110cc V 110 ZE/ZK/ZHE/ZHK 'FIZR/FIZR Sporty' RX 115 (5FS3) SR 125 SE SR 125 (3MW2)	87-90 86 83 90-94 91-95 87-91 93-95 83 88 83-85 83-91 83-97 83 83-97 96 99 02 04 96 99 92-96 89-91	F&R F&R F&R R F&R R R R R F&R F&R F&R R R R R R R R R
Y514	YAMAHA RD 250/A RD 250 B/C RD 250 LC RZ 250 (4L3) R5/5A/5B 350cc RD 350/A/B RD 350 LC XS 360 B XS 650 XS 650 SE YDS-7 250cc	73-74 75-76 80-83 70-72 73-75 80-82 75 75-81 81 72	R R R R R R R R R R R	Y519 Y519G	YAMAHA CG 50 'Jog' CY 50 'Jog-in' CA 50 'Salient' LC 50 M 'Bop' MS 50 SA 50 M/ME 'Passola' YJ 50 R (5AU1-3) Vino YV 50 (5BM2) Jog Space Innovation EC 03	88-92 91-95 83-85 80 85-86 80-84 98- 97- 11-15	R F R F&R R R F F F
Y515	YAMAHA XVS 400 XV 535 'Virago' XV 535 S 'Virago' XJ 650 XJ 650 'Turbo' XJ 650 RJ "Seca" XJ 650 LK "Seca" XVS 650 'Drag Star' XVS 650 A "Dragstar Classic" XJ 750 XJ 750 RF/RJ/RK "Seca" XV 750 Virago XV 1000 TRI XV 1000/1000 SE 'Virago' XV 1100 'Virago' XVS 1100 Dragstar	96 88-94 95-03 80-84 82 82 83 97-04 98-07 82-84 81-83 94-97 81 86-88 89-99 99-00	R R R R R R R R R R R R R R R R	Y520 Y520G	YAMAHA YFM 350 FWT/FWU Big Bear	87-88	F
Y516 Y516G	YAMAHA XS 250 D/E XS 250 SE/SF XS 250 C YP 250 Majesty YFM 350 FWH/FWJ/FWK 'Big Bear' YFM 350 L 'Big Bear' XS 400 YFM 400 FWE/FWF/FWG/FWH /FWJ/FWK Kodiak YFM 400 FWP/FPR/FPS Big Bear 4x4 YFM 400 FAR/FAS XJ 550 RH/RJ/RK "Seca" YFM 600 FWAK/FWAM/FWAN 'Grizzly' YFM 600 HM "Grizzly Hunting" HONGDOU CTM 125 Chituma KEEWAY Superlight Ltd 125 Superlight 150	79-81 79-81 81 96-99 96-98 99 79-82 93-98 02-04 03-04 81-83 98-01 00 04 07-15 07-12	R R R R R R R R R R R R R R R R R R	Y521	YAMAHA BL 125 XC 125	85 92-95	F F
				Y522	YAMAHA AS3 125 RD 125 SR 250 (3Y8) US Custom SR 250 (4GR1/2/3/4) SR 250 SE Special (3Y8)	71-72 73-74 80-81 94-96 81-83	F F F F F
				Y523 Y523G	YAMAHA YFUI1/TW Pro Hauler Pro 4 (230cc)	89	F
				Y524 Y524G	YAMAHA YFM 350 (All models) YFM 400 FWE/F/G/H /J/K/L/M Kodiak	89-98 93-00	F F
				Y525	YAMAHA Yammy 50 (2T)	86-	F&R
				Y526	YAMAHA SR 400 (3HT1) SR 500 (3GW1/3/4/6/7)	88 96-98	F F

Part No.	Make/Model	Year		Part No.	Make/Model	Year		
Y527 Y527G	YAMAHA YFM 50 S/T/RV/RV/RW/RX Raptor YFM 80 D/E/F/G/H/J/K/L/M /N Badger YFM 80 WP/WR/WS/RT/RV /RW/RX Raptor YFM 80 GT/GV/GW/GX Grizzly AG 100 J (3HAA) AG 100 E 'Farm Bike' YN 100 "Neos 100" YQ 100 "Aerox 100" DT 125 (3TT4) SR 125 (3MW2) XC 125 XC 125 T Cygnus XN 125 Teo's XTZ 125 (5RM) YBR 125 ED (3D91) YBR 125 E/K (Brasil) YBR 125 ED (Brasil) YFM 125 S/GT/GV/GW/GX /GY/GZ/GA/GB/GD Grizzly YP 125 'Majesty' YP 125 Majesty DX (Taiwan Production) YFA1D/F/G/H/J/K/L/M/N/P/R Breeze XTZ 125 K/E XV 125 Virago XVS 125 Dragstar DT 175 (3TS4) AG 200 E (3GX6) XT 225 SR 250 (4GR1/2/3/4) SR 250 Classic (2IL) SRV 250 'Soulful Twin/Renaissa' XV 250 Virago XV 250 'S' Virago XVS 250 Dragstar TT 350 A (3GJ) TT 350 (ITJ) XT 350 'S' TT 600 N (59X) TT 600 W (2JT/3SW1) AJS Exactly 125 Scooter (4T) APRILIA Scarabeo 100 (2T) BENELLI K2 100 CPI Argon GP125 ITALJET Millennium 100/125/150 MBK YN 100 Ovetto YQ 100 Nitro YW 100 T Booster 100 XC 125 T Flame XN 125/150 Doo Do YP 125 D Skyliner XC 150 Vertex NIPPONIA Miro 125 (4T) QUADZILLA R50 (Rear drum model) R100 (Rear drum model) GENERIC/KSR Soho 125/150 XOR 125 Zion 125/150 SFM SFM 125 A8 Roadster	04-09 R 92-01 R 02-08 R 05-08 F 82 R 93 R 99-03 R 00-04 R 96 F&R 89-91 F 93-95 R 95-98 F 00-03 R 03-10 R 05-06 R 00-08 F&R 06-08 R 04-14 R 98-00 R 02 R 92-03 R 05-10 R 97-00 R 00-04 R 96 F&R 93 R 97-06 R 94-96 R 96-00 R 92-97 R 89-94 R 95-00 R 01-04 R 90-95 R 85-89 R 91-95 R 85-88 R 89-92 R 08-15 R 00 R 99-01 R 07-12 R 00-04 R 99-03 R 01-02 R 96 R 95-96 F 00-05 R 98-00 R 97 R 14-15 R R R 06-14 R 05-11 R 08-09 R 13-15 R			Y528 Y528G	YAMAHA Contd. YFB 250 FWF/FWG/FWH/FWJ /FWK/FWL/FWM Timberwolf YFM 250 XLC/XL/X Bear Tracker YFM 250 W/A/B YFM 250 XN/XP/XR/XS YFUI1/TW Pro Hauler Pro 4 (230cc) YFM 350 ERD/ERE/ERF/ERG YFM 350 UH/UJ/UK YZ 250 D/E/F DT 400 All models YZ 400 D/E/F IT 425 G YZ 465 G IT 500 G/H XT 500	94-00 F&R 99-00 F&R 90-92 F 01-04 R 89 F 92-95 F 96-98 R 77-79 R 75-77 F 77-79 R 80 R 80 R 80-81 R 76-80 F	
				Y530	MBK CS 50 Mach G AC (Air cooled) CS 50 Mach G LC (Liquid Cooled) XF 50 X Booster XC 125 WAAP RIEJU Urban Blast (50) YAMAHA BA 50 S/V (UA03J) BW's 50 (5WW4/6/8/9/B/D/F/H/K/M/P) BW's 50 Naked (2B7B/D/F/H) BW's Easy (2DW) CS 50 Jog R CS 50 Z (Jog RR) CV 50 ZR (5PT1) CV 50 (5KN1/2) CV 50 A/R Jog (5SU1/2/SA165) CW 50 (5WW4/BWS) BA 50 C (4KNH) Gear-C XC 50 X Vino Classic (SA26J) XF 50 Giggle/Vox YN 50 F Neos (4T) (5C3) YN 50 Neos (2T) (1F5C2/1H5C2) YN 50 Neo's Easy (2T) T90 D (4NM4/5/7) T90 D 4NM8/UB02J T90 N (4NM1/2/3/6) T90 N 4NM9/UB02J XC 125 Vity (4P7)	06-10 R 06-10 R 07-10 F&R 08-10 R 13-14 R 08 R 05-15 R 09-14 R 13-15 F&R 06-15 R 06-12 R 01-02 R 00-02 R 03-08 R 04-07 R 04 R 08 F&R 07-12 F&R 09-18 R 07-16 R 13-15 F&R 97-99 F&R 00-08 F&R 94-99 F&R 00-08 F&R 08-13 R		
				Y531	YAMAHA YB-1 (50cc) 5JE1/3 BA 50 C (4KNH) Gear-C BA 50 S/N (UA03JO) AT 115 (2B81/2/3) Neo (Brasil) AT 115 (1S51) (Neo CVT/Brasil) XC 115 S-D'elight D'Light 125 TW 125 (5RS) YBR 125 (3D92) T 135 HC/S (2S61) T135-SE (1S71) TW 225 E (5VC1/2) YBR 250 YS 250 Fazer (Brasil) (1S41/2/3)	01-02 F&R 04 R 08 F 05-07 R 08 R 14-16 R 03-04 R 07-09 R 06-08 R 06-08 R 03 R 07-08 R 06-08 R		
				Y532 Y532G	YAMAHA YFM 250 BT/BV Bruin YFM 250 BW/BX/BY Big Bear YFM 350 FAS/FAT/FAV Bruin 4x4 YFM 350 ANS/ANT/ANV Bruin 2x4 YFM 350 XV/XW/XX/XY 2WD Wolverine YFM 350 FWA Grizzly 4WD YFM 350 GW/GX/GY/GZ Grizzly 2WD YFM 400 AR 2WD Kodiak MBK YX 125 Z X-Over	05-06 R 07-10 R 04-06 R 04-06 R 06-09 R 04-14 R 08-10 R 03 R 10 R		
Y528 Y528G	YAMAHA DT 250 All models IT 250 G YFB 250 D/E/F Timberwolf YFB 250 G/H/UH/J/UJ/UK/K Timberwolf	75-80 F 80 R 92-94 R 95-98 F&R		Y533	YAMAHA NXC 125 - Cygnus X - (5ML) NXC 125 - Cygnus X - (4P9)	04-06 R 07-13 R		

Part No.	Make/Model	Year		Part No.	Make/Model	Year	
Y533 Contd.	YAMAHA			S602 Contd. S602G	SUZUKI Contd.		
	NCX 125 K Cygnus X Cab (4C6-1)	07-10	R		TS 100 ERZ/ERH	82-87	F
	NCX 125 L Cygnus X Injection (4C6-2)	07-10	R		B 120	71-77	F&R
	HW 125 Xenter 125	12-18	R		DF 125		R
	YW 125 (BW's 125)	10-13	R		DR 125 SZ/SD/SE	82-84	F&R
	YW 125 X (1DN1/2)	10-13	R		DR 125 SF/SH/SJ	85-94	R
	HW 150 Xenter 150	12-16	R		DR 125 SEX/SEY	99-01	R
	MBK				EN 125-2/125-2A	05	R
	NXC 125 Flame X	04-12	R		GN 125 R/V/W/X/Y/K1	94-01	R
					GN 125 Z/D/K Gold coloured cast wheels/Aisin caliper	82-90	R
Y534 Y534G	YAMAHA			GN 125 HS (LC6PCJB1) (Chinese Production)	00-11	R	
	YXP 700 AS/AV Pro Hauler 700 Side x Side	04-06	R	GN 125 ER/EV/EW/EX/EY/EK1 (NF41A/Black Cast Wheel)	94-01	R	
	YXP 1000 AS/AT Pro Hauler 1000 Side x Side	04-05	F&R	GP 125 C/N/X/D	78-84	R	
	HONLEY			GS 125 Z/D	82-84	F&R	
	HD1 125	14-15	R	GS 125 ESZ/ESD/ESF/ESK/ ESM/ESR/ESX	82-00	R	
	HD2 125	16-17	R	GT 125 L/M/A/B/C/EC/EN	74-78	R	
	HD3 125	16-17	R	GX 125 (SJ125)	03	R	
	HD3 SE 125	16-17	R	GZ 125 W/X/Y/K1-K9 'Marauder'	98-11	R	
Y535	YAMAHA			RG 125 CG/CH/J (NF12A) Gamma	86-90	R	
	YBR 125 Custom	08-16	R	RG 125 UCG/UCH/UJ/UAJ/BUJ (NF12B) Gamma	86-90	R	
	YBR 125 (3D92/9)	07-13	R	RM 125 M/A/B/C	75-78	F&R	
	YBR 125 (51D1/2)	10-16	R	RM 125 N/T/X/Z/D	79-83	F	
	YS 125	17-21	R	RV 125 K	73	R	
	YBR 250 (5D11/3/4)	08-11	R	RV 125 L/M/A	74-76	F&R	
	HONLEY			'Stinger' T 125/125 II/125 R	69-71	F&R	
	HD1 125	14-15	R	TF 125 Farm Bike (All models)	78-05	F&R	
	HD2 125	16-17	R	TS 125 K	72	R	
	HD3 125	16-17	R	TS 125 L/M/A/B/C/CZ/ERN/ERT/ERX	73-81	F&R	
Y536 Y536G	YAMAHA			TS 125 ERZ	82	F	
	YFM 90 RY/RZ/RA/RB/RD Raptor	09-13	F	TS 125 N	84	F&R	
Y537	YAMAHA			TS 125 XE	84	F	
	XC 180 Riva Scooter	83-85	F	TU 125 X/XTUX/XTX	99	R	
	XC 200 Riva Scooter	87-91	F	UH 125 K2-K6 (Parking brake)	02-06		
S601	SUZUKI			VL 125 Y/K1-K7 "Intruder"	00-08	R	
	FZ 50 N/X/Z/G/K/L/P 'Suzy'	80-96	F&R	X4 125		R	
	RG 50 EW		R	PE 175 C/N	78-79	F&R	
	TS 50 X XKE/XKG/XKH/XKJ /XKM/XKR	84-02	R	PE 175 T/X	80-81	F	
	TS 50 W		R	GT 185 K/L/M/A/B/C/EC	73-79	R	
	CS 80 CD	83	F&R	TS 185K	73	R	
S602 S602G	KAWASAKI			TS 185 L/M/B/C/ERN/ERT/ERX	74-81	F&R	
	KH 100 A2/A3/A4	78-81	F	DF 200 EV/EW/EY (SH42A)	98-00	R	
	KH 100 G5-G8 (EX)	84-87	F	DR 200 SEP/SER/SES/SEV/SEW /SEX/SEY (SH42A) Djebel	93-00	R	
	KLF 110 B1/B2 'Mojave'	87-88	R	DR 200 G/H/J	86-89	R	
	.AR 125 A1-A7/B1-B8	82-94	R	DR 200 SE Trojan	96-13	R	
	BN 125 A1-A5/A6F/A7F Eliminator	98-07	R	DR 200 SEK1-SEK9	01-09	R	
	KE 125 A4 to A12	76-85	R	GT 200 EN/EX 'X5'	79-82	R	
	KH 125 K1-K10	83-98	R	SB 200 N/X	79-81	R	
	KH 125 L1 (EX)	84	R	GN 250 F/J/M/R/T	87-97	R	
	KX 125 A3-A7	74-80	R	GZ 250 X/Y/K1	99-01	R	
	KX 125 B1	82	R	GZ 250 K2-K8 Marauder	02-08	R	
	KDX 175 A1-A3	80-82	R	RL 250 L/M	74-75	R	
	KE 175 B1-B3	76-78	R	RL 250 Beamish Model Reed Valve Engine	78-82	R	
	Z 200 A1-A6	77-83	R	RM 250 A/B/C	76-78	F	
	KT 250 A/A2	75-76	R	RM 250 E/F/G	84-86	R	
	KX 250	74	F	TU 250 XV/XW	97-00	R	
	KX 250 B1/C1/C2/D1	82-85	R	TU 250 GY/GBK1 Grass Tracker /Big Boy (NJ47A-117/123)	00-01	R	
	KDX 250 B2/B3	80-84	R	TU 250 S/T/XS/XT/X-ST/XSV/ XT-W (NJ47A 100001-115972)	92-97	R	
	Z 250 C1/C2/G1/G2	81-83	R	TU 250 XTX/X/XTY (NJ47A-115)			
	KX 500 A1/A2/B1	83-85	R	Volty	99-00	R	
	KLR 600 A1/A2/B1-B4/B6-B9	84-94	R	VL 250 Y/K1/K5/K6/K7 Intruder	00-01/05	R	
	SUZUKI			RL 325 Beamish Model Reed Valve Engine	78-82	R	
	RM 80 HD/HF	83-85	F	RM 400 C	78-07	F	
	FB 90 K1	01	F&R	RM 465 X/Z	81-82	R	
	TS 90 R/J	71-73	R	DR 500 X/Z/D	81-83	F	
	ASS 100	69-71	F	RM 500 D/E	83-84	R	
	ACC 100	70-72	F&R	DR 600 RG/RH/RJ (SN41A)	86-88	R	
	GP 100 UN/UX/UD/UL	79-92	F	DR 600 SF/SG/SH/SJ/SK (SN41A)	85-89	R	
	RM 100 A/B/C	76-78	R	BSM			
	TS 100 K/L/M	73-75	R	FT 125		R	
TS 100 A/B/C/ERN/ERT/ERX	76-81	F&R					

Part No.	Make/Model	Year		Part No.	Make/Model	Year	
S606 S606G Contd.	SUZUKI Contd. GS 250 TT/TX/ET/EX/EZ GV 250 C GN 400 TT GSX 400 ET/EX/EZ GS 400 LX LT-A 400 FK2-FK7 Eiger 4WD LT-A 400 K2/K3/K4 Eiger LT-F 400 FK2-FK7 (Eiger 4WD) LT-F 400 K2-K7 Eiger (2WD) ST 400 Tempter V/W/X/Y/K1/K2/K3 GS 425 EN GS 450 ET/EG/EJ GR 650 D/XD "Tempter" LS 650 FG/PK/PM/PR/PG/PT/PV /PW/PX 'Savage' DR 750 SJ HYOSUNG GV 250 Aquilia GV 250 Classic	80-82 08-11 80 81-83 81 02-07 02-04 02-07 02-07 97-03 78-80 80-88 83 87-99 88 04-07 08-15	R R R R R R R R R R R R R	S615	SUZUKI RM 80 XZ/XD/XE/XF	82-85	F
				S616 S616G	SUZUKI RM 125 X/Z/D/E/F/G/H RM 250 X/Z/D	81-87 81-83	R R
				S617 S617G	SUZUKI TS 50 X (All models) TS 50 W RM 100 N/T/X RM 125 N/T	84-02 79-81 79-80	F F R R
				S618 S618G	SUZUKI LT 80 L/M/N/P/R/S/T/V/W/X/Y/K1-K6 LT-Z 90 K7/K8/K9/L0/L4/L5/L6/L7 QuadSport RM 125 X/Z/D PE 175 Z RM 250 T RM 400 T KAWASAKI KFX 80 (KSF 80 A1/A2/A3/A6F)	87-06 07-17 81-83 82 80 80 03-06	R R F F F F R
S608	SUZUKI T 20 Super Six T 250 11/R/J T 350 1/11/R/J GT 380 J	66-68 70-72 69-72 72	F F F F	S619 S619G	SUZUKI PE 175 T/X/Z	80-82	R
S609	SUZUKI GT 250 K/L/M/N/A/B/C T 20 Super Six T 250 11/R/J T 350 1/11/R/J GT 380 J/K/L/M/A/B GS 400 B/C GS 400 TX T 500 1/2/3/R/J/K/L/M GT 500 A/B GT 550 J/K/L/M	73-78 66-68 70-72 69-72 72-77 77-78 81 68-75 76-77 72-75	R R R R R R R R R R	S620 S620G	SUZUKI RM 250 N/T RM 400 N/T	79-80 79-80	R R
				S621 S621G	SUZUKI LT 125 D LT 125 F/G/H RM 250 X/Z RM 465 X/Z	83 85-87 81-82 81-82	R R F F
S611	SUZUKI GT 550 A/B GS 550 DB/DC	76-77 77-78	R R	S622 S622G	SUZUKI RM 250 D/E RM 500 D/E	83-84 83-84	F F
S612	SUZUKI T 500 1/2/3/R/J/K/L/M KAWASAKI BJ 250 D1-D7 Estrella-RS Custom	68-74 96-02	F F	S624 S624G	SUZUKI AH 50 N 'Address' AH 50 N 'Address' (Ciga front drum model) AJ 50 ZZ/RS Sepia AP 50 R/S/T/V/W AY 50 V/W/W/WW/WRW /K1/K2 'Katana' Progress 50 AZ 50 X/LX/UX/Y/UY/LY/K2 /UK (LETS II) AZ 50 7/8 Let 4/G (CA45A) UF 50 Y UR 50 W/Y/K1/K2/K3 Verde 50 WX/WY Zillion CP 50 CHF WRS 50 Scooter AH 80 Address CP 80 CHF AH 100 Address AH 100 P Address UK 110 L5/L6/L7/L8 Address AN 125 S/T/V/W/X AN 125 HKK5 UE 125 CTK1 UE 150 CTK1 LT 160 EK/EL/EM/EN LT 160 K3/K4 QuadSport LT-F 160 L/M/N/P/R/S/T/V/W/X/Y/K1-K3 CAGIVA Cucciolo 50 DERBI Atlantis 50 (AC/2T) Atlantis 50 LC (2T) Paddock 50 (AC/2T) Predator 50 (AC/2T) Vamos/Vamos FL Vamos 50 Red Bullet 50	92-95 92-95 92- 94-02 97-03 97-99 07-08 00-02 99-03 99-02 85 98-00 92-94 85-93 92-94 95-96 15-21 95-00 06-08 01-03 01 89-92 03-04 90-03 98-99 99-01 99-01 98-99 98-01 96- 93-95 04-05	R F&R R R R R R RUX R F&R R R F&R R R R R R R R R R R R R R R R R R
S613 S613G	SUZUKI LT 50 G/H/J/K/L/X/Y/K1 JR 50 All models CL 50 D 'Suzi/Love' CS 50 Z/D 'Roadie' KAWASAKI KDX 50 A1/A2/A3	86-02 78-07 83 83-84 03-05	R F&R R F&R F&R				
S614 S614G	SUZUKI CX 50 DF (CA15A) LT-A 50 K2-K5 Quadmaster CL 50 D 'Suzi/Love' FS 50 T/X 'Snip' LT-Z 50 K6/K7/K8/K9/L0/L4/L5/L6 /L7/L8 QuadSport LT 80 L/M/N/P/R/S/T/V/W/X/Y/K1-K6 E-TON DXL-90 Sierra EXL 150 Eukon ST QUADZILLA WK 50 (White knuckle pit bikes) WK 70 (White knuckle pit bikes) WK 50 (Front disc model) (White knuckle pit bikes) R 50 (Rear disc model) R 50 (Rear drum model) R 100 (Rear disc model) R 100 (Rear drum model) KAWASAKI KFX 50 (KSF 50 A1/A2/A3) KFX 80 (KSF 80 A1/A2/A3/A6F)	85 02-05 83 81-82 06-22 87-06 99-03 05-07 06-08 06-09 06-09 03-06 06-09 06-09 03-05 03-06	F&R F F F&R F F F F F F&R F&R R F F F F F F F F F F F				

Part No.	Make/Model	Year		Part No.	Make/Model	Year	
S624	DERBI Contd.			S631	SUZUKI		
S624G	Hunter	96-99	R		CP 50 C		R
Contd.	Atlantis 100 (AC/2T)	00-01	R	S632	SUZUKI		
	GARELLI				AE 50 L/N/T 'Style'	90-96	F&R
	KRS 50		R		AD 50 T/Tune/V-Tune	88	R
	Freeland 125/150		R		AE 50 R		R
	ITALJET				AZ 50 X/LX/UX/Y/LY/UY/K2		F
	Formula Air 50	99-03	R		/UK2 (LETS II)		F
	ITALJET Contd.				AZ 50 7/8 Let 4/G (CA45A)	07-08	F
	Velocifero 50	98-00	R		CR 50 DC		R
	Torpedo 50	98-03	R		X5 K3/BK3/DK3/DBK3 Choinori	03	R
	Torpedo 125/150	07-09	R		UR 50 W/Y/K1/K2/K3 Verde	99-03	F
	ATALA			S633	SUZUKI		
	Hacker LC	97	R	S633G	LT-F 4WD H/J/K/L/M/N/P/R/S/T/V/W	87-98	F
	Hacker Racing	97	R		LT-F 300 FX/FY/FK1	99-01	F
	Byte 'AT10'	97	R				
	Hacker	97	R	S634	SUZUKI		
	PIAGGIO			S634G	LT-F 300 FX/FY/FK1	99-01	R
	Diesis 100	01-03	R		LT-F 4WDX H/J/K/L/M/N/P/R/S/T/V/W	87-98	R
	PGO				LT 250 EFF/EFB	85-86	R
	Charge 125 A/B	01-02	R		LT-F 300 FK2	02	R
	Ligero 125	06-08	R		RE 5 M/A	75-77	R
	Ligero 125 (4T)	08-12	R		LT-A 500 FY/FK1	00-01	R
					LT-F 500 FW/FX/FY/FK1/FK2	98-02	R
					GT 750 J/K/L/M/A/B	72-77	R
S625	SUZUKI			S635	SUZUKI		
S625G	LT-F 230 G/H	86-87	F		UC 125 X/Y Epicuro	99-02	R
	LT 230 GEF/GEG	85-86	F		KAWASAKI		
	LT 250 EFF/EFB	85-86	F		SC 150 A1 (Epsilon 150)	02-03	R
	LT-F 300 J/K	88-89	F				
S626	SUZUKI			S636	SUZUKI		
	LT-A 400 FK8/FK9/FLO/FL1	08-12	R	S636G	LT-F 250 K2-K9/L2/L3/L4 Quark	02-14	R
	King Quad 4WD/Auto 4WD	08-10	R		LT-Z 250 K4-K9/L0 Quadsport	04-12	R
	LT-F 400 FK8 King Quad						
	VS 400 VR/FR/VTR/FTR/V-T/F-T			K701	KAWASAKI		
	'Intruder'	94-	R	K701G	KX 80 B1/B2/D1/D2	79-83	F&R
	VS 600 GLS/GLT/GLV	95-97	R				
	VS 700 GLEFG/GLEPG/GLEFH/GLEPH	86-87	R	K702	KAWASAKI		
	VS 700 GLFH/GLPH	86-87	R	K702G	KH 125 A1-A4	77-81	R
	VS 700 GLFG/GLPG	86-87	R		KX 125 B2/C1/D1	83-85	R
	VS 750 All models	85-91	R		KDX 200 A1/A2/A3/C1-C3	83-88	R
	C 800 (VL 800 K5-K9/L0/L1/L3/L5)			K703	KAWASAKI		
	(C 800 Intruder) (Spoke wheel)	05-15	R	K703G	KE 175 D2/D3/D4/D5	79-83	R
	C 800 C (VL 800 CK7/CK8/CK9				KDX 200 A1/A2/A3	83-85	F
	/CLO/CL1/CL2/CL3) Intruder				KL 250 A3/A4/C1/C2	80-84	R
	(Cast wheel model)	07-15	R		KLR 250 D2-D22	84-05	R
	M 800 (VZ 800 K5-K9/L0/L1/L3			K704	KAWASAKI		
	Intruder M800)	05-13	R	K704G	KE 125 A4-A12	76-85	F
	M 800 Z (VZ 800 K9Z Intruder)	09-12	R		KX 125 A3-A7	74-80	F
	VL 800 K1-K5 'Intruder Volusia'	01-05	R		KDX 175 A1-A3	80-82	F
	VL 800 BTL4 - C 800 Intruder				KE 175 B1-B3/D2-D5	76-83	F
	Inc C 50 Boulevard	14-21	R		KT 250 A/A2	75-76	F
	VS 800 GLN/GLP/GLR/GLT				KL 250 A3/A4/C1/C2	80-84	F
	/GLS/GLV/GLW/GLX	92-99	R	K705	KAWASAKI		
	VZ 800 V/W/X/Y/K1/K2 'Marauder'	97-03	R	K705G	KLT 200 C1/C2/A1/A4A	81-84	R
	VZ 800 L4/L5 Intruder M800/T	14-15	R		KLF 200 A1-A10	88-97	F
	SACHS				KLF 220 A1-A15	88-02	F
	Roadster 800	01-04	R		KX 250 (A Series)	74-81	F
	B-805	03-04	R		KDX 250 B1-B3	79-84	F
					KL 250 A1-A2	78-79	F
					KLF 250 A1/A2/A3/A6F/A7F		
S627	SUZUKI				A8F/A9F/AAF/ABF Bayou	03-11	F
	TS 125 XE/XUF/XUG/XUH/XUJ	84-90	R		KLT 250 C1/C2/C3 'Prairie'	83-85	R
	TS 250 XE/XG/XH/XJ/XK	85-89	R		KTX 250 A1 'Tecate'	84	F
S628	SUZUKI				KX 250 A/A3/A4/A5/A6/A7	75-81	F
S628G	LT-F 250 J/K/L/M/N/P/R/S/T/V/W/X/Y/K1	88-01	F		KX 420 A1/A2	80-81	F
	LT-F 250 FX/FY/FK1/FK2	99-02	F				
	LT-F 4WD H/J/K/L/M/N/P/R/S/T/V/W	87-98	F	K706	KAWASAKI		
	KAWASAKI			K706G	KLF 185 A1	87	R
	KAF 300 A1/B1/B2 (Mule 500)		F		KLF A1-A10	88-97	R
	KAF 300 C1/C2/C3/C4/C6/C7/D1		F		KLF 220 A1-A15	88-02	R
	(Mule 550)		F		BJ 250 E1-E4A Estrella-RS Custom	96-99	R
					BJ 250 D1-D7 Estrella Custom	96-02	R
S629	SUZUKI						
S629G	LT-F 250 J/K/L/M/N/P/R/S/T/V/W/X/Y/K1	88-01	R				
	LT-F 250 FX/FY/FK1/FK2	99-02	R				
	LT-F 4WD H/J/K/L/M/N/P/R/S/T/V/W	87-98	R				

Part No.	Make/Model	Year		Part No.	Make/Model	Year		
K706 K706G Contd.	KAWASAKI Contd.			K713	KAWASAKI			
	BJ 250 F1/F2 (250 TR)	02-03	R		H2/H2-A Mach IV (750cc)	72-73	R	
	BJ 250 F1/F2 (250 TR)	02	R		H2-B/H2-C Mach IV (750cc)	74-75	R	
	EL 250 D1-D5	90-94	R		Z 900 Z1A/Z1B	74-76	R	
	EL 250 Eliminator	87-89	R		Z 900 A4	77	R	
	ER 250 B1/B2/B3 (Z 250 T Scorpion)	83-88	R					
	KLF 250 A1/A2/A3/A6F/A7F				K714	KAWASAKI		
	/A8F/A9F/AAF/ABF Bayou	03-11	R		K714G	KX 80 E1	83	F
	Z 250 B1/B2	80-83	R					
	EL 252 F2/F53/F5/F6	96-03	R		K715	KAWASAKI		
	KLF 300 A1/A2/B1-B17 'Bayou'	86-04	R		K715G	KX 60 A1/A2/B1-B19	83-03	F&R
	GPZ 305 A1/B1-B10	83-96	R			KX 80 E1-E3/J1/J2/G1/G2	83-87	R
	Z 400 B1/B2	78-80	R			KLX 110 R	02-21	F
	Z 400 G1	79	R			SUZUKI		
	ZR 400 A1/B1 (Z 400 F)	83-84	R			RM 60 K3	03	F&R
	Z 440 A2/C1	79-80	R			DR-Z 110 K3/K4/K5	03-05	F
	Z 440 C2	81	R		K717	KAWASAKI		
	Z 440 D4/D5/D6 (LTD)	82-84	R		K717G	KLF 300 A1/A2 'Bayou'	86-87	F
	Z 440 H1/H2	82-83	R					
	GPZ 500 S (EX 500 A1-A6)	87-93	R		K718	KAWASAKI		
	GPZ 500 S (EX 500 B1-B5)	88-93	R			KAF 300 A1/B1/B2 (Mule 500)		R
	ER-5 (ER 500 A1/A2/A3/A4/C1-C5P)	97-07	R			KAF 300 C1/C2/C3/C4/C6		R
	ZR 550 A1/A2 (Z 550 F)	83-84	R			/C7/D1 (Mule 550)		
	W 650 (EJ 650 -A1/C3-C7)	99-05	R			KAF 400 A6F/A7F/A8F/A9F/AAF	06-10	F&R
	EJ 800 ABF/ACF					(Mule 610 4x4)		
	(W 800/Solid F/disc)	11-12	R			KAF 400 ABF/ACF/ADF/AEF	11-14	F
	EJ 800 ADF/AEF/AFF/AGF (W 800)	13-16	R			(Mule 610 4x4)		
	EJ 800 ADFA/AEFA/AFFA/AGFA					KAF 400 B6F/B7F/B8F/B9F/BAF	06-14	F&R
	(W 800 Special Edition)	13-16	R			/BBF/BCF/BDF/BEF (Mule 600)		
	EJ 800 (W 800 Cafe Style/ Cockpit fairing)	11-16	R			KAF 400 JHF (Mule SX)	17	F&R
				KAF 400 HHF (Mule SX 4X4)	17	F&R		
K708	KAWASAKI			KAF 400 NHF (Mule SX 4X4 SE)	17	F&R		
250 S1B	75	R		KAF 400 KHf (Mule SX 4X4 XC)	17	F&R		
KH 250 B1-B5	77-82	R		KAF 400 LHF (Mule SX 4X4 XC Camo)	17	F&R		
S1-A/B/C (250cc)	73-75	R		KAF 400 MHF (Mule SX 4X4 XC SE)	17	F&R		
S2 (350cc)	72-73	R						
S2-A (350cc)	72-73	R		K719	KAWASAKI			
S3/S3-A (400cc)	74-75	R		KAF 400 ABF/ACF/ADF/AEF	11-14	R		
KH 400 A3/A4/A5	76-78	R		(Mule 610 4x4)		F		
				KAF 450 B1 (Mule 1000)		F		
K709	KAWASAKI			KAF 540 C1 (Mule 2010)		F		
ZL 400 A 'Eliminator'	86-87	R		KAF 540 D1 (Mule 2020)		F		
ZL 400 B 'Eliminator' 400 SE	88	R		KAF 540 E1 (Mule 2030)		F		
ZL 400 D1/D2	94-95	R		KAF 620 A1/A2 (Mule 2510)		F		
Z 400 J1/J2/J3	80-83	R		KAF 620 B1/B2/B6 (Mule 2520)		F		
LTD 454 (EN 450 A1-A5)	86-89	R		KAF 620 C1/C2/C3/C6 (Mule 2530)		F		
EN 500 A1-A3/B1-B2/C1-C9	90-04	R		KAF 620 E1-E5 Mule 3010		F		
Z 550 A1	80	R		KAF 620 F1/F2 Mule 3020		F		
Z 550 A2/A3/C1/C2/LTD	81-84	R		KAF 620 G1-G5 Mule 3000		F		
GT 550 G1-G9	83-01	R		KAF 620 H1-H3 (Mule 3010 4x4)		F		
ZL 600 B1 Eliminator	95-97	R		KAF 620 J1/K1/K6F/K7F		F		
Z 650 B1-B3	77-79	R		(Mule 3010 Trans 4x4)	05-07	F		
Z 650 F1/F2/F3/F4	80-83	R		KAF 620 M9F/MAF/MBF/MCF/MDF				
VN 700 A1 'Vulcan'	85	R		/MEF/MFF/MGF/MHF				
VN 750 A2-A5/A10	86-94	R		(Mule 4010 4x4)	09-17	F		
Z 750 Y1 (LTD)	82	R		KAF 620 N9F (Mule 4010				
VN 800 A1/A2/A3	95-99	R		4x4 Hardwoods Green)	09	F		
VN 800 B1-B10/B6F 'Classic'	96-06	R		KAF 620 P9F/PAF/PBF/PCF/PDF				
				/PEF/PFF/PGF/PHF (Mule 4000)	09-17	F		
K710 K710G	KAWASAKI			KAF 620 R9F/RAF/RBF/RCF/RDF/REF				
KLF 300 C1-C17 "Bayou"	89-05	R		/RFF/RFFA/RGF/RHF				
KVF 300 A1-A4 (Prairie 4x4)	99-02	R		(Mule 4010 Trans 4x4)	09-17	F		
KVF 300 B1-B4 (Prairie 2x4)	99-02	R		KAF 620 S9F/SAF/SBF/SCF/SDF/SEF				
KVF 400 C1-C4 (Prairie 4x4)	99-02	R		/SFF/SGF/SHF (Mule 4010 Trans	09-17	F		
KVF 400 D1-D4 (Prairie 2x4)	99-02	R		4x4 Hardwoods Green HD)	16-17	F		
KLF 400 B1-B7 Bayou	93-99	R		KAF 620 TGF/TGF (Mule 4010 4x4 SE)				
KVF 400 A1/A2/B1 'Prairie'	97-98	R		KAF 620 VGF/VHF				
H1 500 Mach III	69-72	R		(Mule 4010 Trans 4x4 SE)	16-17	F		
HI-D/E/F 500	73-75	R		KAF 950 A1/A2/A3 Mule 2510 Diesel		F		
KH 500 A8	76	R		KAF 950 B1-B3 (Mule 3010 Diesel)		F		
				KAF 950 D8F Mule 2010 Diesel 4x4	08	F		
K711	KAWASAKI			KAF 950 E8F Mule 3010 Trans Diesel	08	F		
250 S1B	75	F		KAF 950 F9F/FAF/FBF/FCF/FDF				
S1-A/B/C (250cc)	73-75	F		(Mule 4010 Diesel 4x4)	09-13	F		
S2 (350cc)	72-73	F		KAF 950 G9F/GAF/GBF/GCF/GDF				
Z 250 B1/B2/C1/C2/G1/G2	80-83	F		(Mule 4010 Trans 4x4 Diesel)	09-13	F		
				QUV 620 FK5 Side x Side	05	F		

Part No.	Make/Model	Year		Part No.	Make/Model	Year		
K720	KAWASAKI			802G	HUSQVARNA			
	KAF 450 B1 (Mule 1000)		R		CR 125	85-86	R	
	KAF 540 C1 (Mule 2010)		R		WR 125	80-81	F&R	
	KAF 540 D1 (Mule 2020)		R		WR 125	82-84/87-88	R	
	KAF 540 E1 (Mule 2030)		R		XC 125	82-84	R	
	KAF 620 A1/A2 (Mule 2510)		R		CR 240	80-81	F	
	KAF 620 B1/B2/B6 (Mule 2520)		R		CR 240	85-86	R	
	KAF 620 C1/C2/C3/C6 (Mule 2530)		R		CR 240	87-88	R	
	KAF 620 E1/E2/E3/E4 Mule 3010		R		WR 240	80-81	F&R	
	KAF 620 F1/F2 Mule 3020		R		WR 240	82-84	R	
	KAF 620 G1/G2/G3/G4 Mule 3000		R		WR 240	87-88	R	
	KAF 620 H1/H2 (Mule 3010 4x4)		R		CR 250	80-81	F	
	KAF 620 J1/K1/K6F/K7F (Mule 3010 Trans 4x4)	05-07	R		CR 250	85-86	R	
	KAF 620 M9F/MAF/MBF/MCF/MDF/MEF /MFF/MGF/MHF (Mule 4010 4x4)	09-17	R		CR 250	87-88	R	
	KAF 620 N9F (Mule 4010 4x4 Hardwoods Green)	09	R		WR 250	80-81	F&R	
	KAF 620 P9F/PAF/PBF/PCF/PDF /PEF/PFF/PGF/PHF (Mule 4000)	09-17	R		WR 250	82-84	R	
	KAF 620 R9F/RAF/RBF/RCF/RDF /REF/RFF/RFFA/RGF/RHF (Mule 4010 Trans 4x4)	09-17	R		WR 250	87-88	R	
	KAF 620 S9F/SAF/SBF/SCF/SDF /SEF/SFF/SGF/SHF (Mule 4010 Trans 4x4 Hardwoods Green HD)	09-17	R		XC 250	80-81	F&R	
	KAF 620 TGF/TGF (Mule 4010 4x4 SE)	16-17	R		XC 250	82-84	R	
	KAF 620 VGF/VHF (Mule 4010 Trans 4x4 SE)	16-17	R		XC 250	87-88	R	
	KAF 950 A1/A2/A3 Mule 2510 Diesel		R		WR 400	87-88	R	
	KAF 950 B1/B2 (Mule 3010 Diesel)		R		430 Automatic	87-88	R	
	KAF 950 D8F Mule 2010 Diesel 4x4	08	R		CR 430	80-81	F	
	KAF 950 E8F Mule 3010 Trans Diesel	08	R		CR 430	87-88	R	
	KAF 950 F9F/FAF/FBF/FCF/FDF (Mule 4010 Diesel 4x4)	09-13	R		WR 430	80-81	F&R	
	KAF 950 G9F/GAF/GBF/GCF/GDF (Mule 4010 Trans 4x4 Diesel)	09-13	R		WRE 430	87-88	R	
					WRU 430	82-84	R	
	SUZUKI				XC 430	80-81	F&R	
	QUV 620 FK5 Side x Side	05	R		XC 430	87-88	R	
					AE 500	82-84	R	
					CR 500	85-86	R	
					CR 500	87-88	R	
					XC 500	82-84	R	
			XC 500	87-88	R			
801G	HUSQVARNA			803G	HUSQVARNA			
	CR 125	78	F		CR 125	82-84	F	
	CR 125	79-81	F&R		WR 125	82-84	F	
	CR 125	82-84	R		XC 125	82-84	F	
	WR 125	79	F&R		CR 240	82-84	F	
	XC 125	85-86	R		CR 250	82-84	F	
	CR 240	80-81	R		WR 240	82-84	F	
	CR 240	82-84	R		WR 250	82-84	F	
	WR 240	78	F&R		XC 250	82-84	F	
	CR 250	71-74	R		WRE 430	82-84	F	
	CR 250	75-79	F&R		WRU 430	82-84	F	
	CR 250	80-81	R		AE 500	82-84	F	
	CR 250	82-84	R		CR 500	82-84	F	
	WR 250	71-74	R		XC 500	82-84	F	
	WR 250	75-78	F&R					
	XC 250	85-86	R		804	CZ/JAWA		
	360 Automatic	75-77	R			Mope		F
	CR 360	75-78	F&R		805	APRILIA		
	WR 360	75-78	F&R			Scarabeo	93-97	F
	ACC 390	80-81	F&R		806	GILERA		
	ACCE 390	80-81	F&R			Storm 50	94-95	R
	CR 390	75-79	F&R			Easy moving 50	95-96	R
	CR 390	80-81	F&R			MASH		
	CR 390 Automatic	78	F&R			Bibop 50	14-16	R
	WR 390	78	F&R			Bibop Racing 50	14-16	R
	CR 400	71-74	F&R			PIAGGIO		
	WR 400	75-78	F&R			Sefera Base 50	91-93	R
	CR 430	80-81	R			Sefera 50 RST	95-97	R
	CR 450	71-74	F&R			Free 50	92-00	R
	WR 450	71-72	F&R			Zip 50 Base (Drum Model)	92-96	R
	CR 500	82-84	R			Zip Fast Raider	93-97	R
	XC 500	85-86	R			Sefera 50 Maquillage 2	94	R
	TC 510	87-88	R			NRG 50	94-96	R
TC 510	89	R	Zip & Zip 50 Bimodale	94-97		R		
TX 510	87-88	R	NTT 50	95-96		R		
TE 510	87-88	R	Typhoon 50	94-97		R		
TE 510	89	R	PIAGGIO					
WMX 510	89	R	Typhoon 50 X	98-99		R		
WXE 510	89	R	Zip 50 Base (Disc Model)	95-96		R		
			Zip 50 Elettrico	02		R		

Part No.	Make/Model	Year		Part No.	Make/Model	Year		
806 Contd.	Free 50 (Disc Model)	95-00	R	816 Contd.	DERBI Contd.			
	NRG 50 RST (DT/DD) "MC2"	96-97	R		Atlantis 100 (4T)		04-06	R
	SKR 80 City	99	R		(13"/3 spoke wheels)			
807	MALAGUTI Crosser CR1	97-01	R	Boulevard 125		03-07	R	
808	PIAGGIO S1 Mix 50 Zip 50 RST Ciao Mix Teen 50	96-99	F	Boulevard 125 (4T)		08-12	R	
		96-99	F	Sonar 125 (4T)		09-11	R	
		96-01	F	Boulevard 150		03-07	R	
809	PIAGGIO Velofax 50	96-99	R	Variant Sport 125 (4T)		12	R	
811G	KTM MX 125 125 GS 250 MX Leleu 250 XC/GS 495 MX Leleu	83	F	Sonar 150 (4T)		09-10	R	
		83	F	Boulevard 200		05	R	
		82	F	GILERA				
		83	F	FX/FXR 125/180 Runner		97-02	R	
		82	F	ITALJET				
812G	KTM MX 125 125/175 125 GS 250/350 420 GS 495	83	R	Jetset 50		02-03	R	
		-84	F&R	Dragster 125/180 LC		99	R	
		83	R	Torpedo 125 T		99-02	R	
		-82	F	Jet Set 125/150 2T		02-03	R	
		85	F&R	MALAGUTI				
		-82	F	Centro 50/SL (4T)		08-11	R	
813G	KTM 250 250 MX Leleu 250 XC/GS 350 350 Four Stroke 495 495 MX Leleu	-82	R	Ciak 50 (4T) Master		04-08	R	
		82	R	PIAGGIO				
		83	R	Fly 50 (2T/4T)		05-18	R	
		-82	R	Liberty 50 2T/4T		97-08	R	
		83	R	Liberty 50 (2T/4T) (10 spoke cast wheels)				
		-82	R	Liberty 50 (2T/4T) (10 spoke cast wheels)		09-15	R	
		83	R	Liberty i-get 50 (3V/4T)		15-21	R	
		-82	R	Liberty S 50 (2T/4T)		07-08	R	
814G	KTM 80 MX MX 125 MX/MXC 125 GSXC/GS 125 MX/MXC/GS 250 MX/MXC 250 GSXC/GS 250 MX/MXC 300 GSXC/GS 300 MX/MXC/XC-GS 500	86-92	R	Typhoon 50 (2T) (12" wheels)		10-18	R	
		84	F&R	Free 100		02	R	
		85	R	Fly 100 (4T)		07-15	R	
		85	R	Fly 125 (4T/2V)		05-11	R	
		84	F&R	Fly 125 ie (3V/4T)		12-15	R	
		85	R	Liberty 125 (2V/4T) 10 spoke cast wheels				
		85	R	Liberty 125 (3V/4T) 10 spoke cast wheels		09-12	R	
		85	R	Liberty 125 Full optional (4T/3V//10 spoke wheel)		13-15	R	
		85	R	Liberty i-get 125 (3V/4T)		15-21	R	
		85	R	Fly 150 (4T)		05-12	R	
		85	R	Liberty 150 (2V/4T) 10 spoke cast wheels				
816	APRILIA Scarabeo 50 Street (2T) Scarabeo 50 (4T) Scarabeo 50 (4T) Sport City One 50 (2T) Sport City 50 (4T) SR 50 Motard (2T) Scarabeo 100 (4T) Sport City One 125cc SR 125/150 SR 125 Motard (4T) Habana 125 (All models) Mojito/Mojito Custom 125 BENELLI Pepe 50 2T (5 spoke cast wheel) Pepe 50 4T (7 spoke cast wheel) Adiva 125/150 12" front wheel CAGIVA Nuvola 125 Cucciolo 125 DERBI Atlantis 50 (4T) (13"/3 spoke wheels) Atlantis 50 (4T) Boulevard 50 (2T) Boulevard 50 (4T) Sonar 50 (4T) Variant Sport 50 (2T)	86-92	R	Liberty 150 (3V/4T) 10 spoke cast wheels		13-15	R	
		84	F&R	Liberty 150 Full optional (4T/3V//10 spoke wheel)		13-15	R	
		85	R	Liberty i-get 150 (3V/4T)		15-21	R	
		85	R	Hexagon LX 180		98-99	R	
		85	R	Hexagon LXT 180		98-99	R	
		85	R	Hexagon LX4 125		98-99	R	
		85	R	Skipper LX 125/150		98-99	R	
		85	R	Liberty 125		98-08	R	
		85	R	Liberty Elettrico		11-12	R	
		85	R	Skipper ST 125/150 4T		00-04	R	
		85	R	Typhoon 125		99-03	R	
		85	R	Typhoon 125 (4T) (12" wheels)		10-15	R	
		85	R	Liberty i-get 125 (3V/4T)		15-16	E	
		85	R	Liberty S 125		07-08	R	
		85	R	X8 125/Street		06-07	R	
		85	R	Liberty 150 (Full optional/ 10 spoke wheel)				
		85	R	Liberty 150		13-14	R	
		85	R	Liberty i-get 150 (3V/4T)		08	R	
		85	R	Liberty 200		15-16	R	
		85	R	Liberty S 200		98-07	R	
		85	R	SCARABEO		07-08	R	
		85	R	50 (2T) (Street)				
		85	R	50 (4T/4V)		10-15	R	
		85	R	50 Net (4T/4V)		10-15	R	
		85	R	50 Yourz (4T)		10-13	R	
		85	R	100 (4T)		12	R	
		85	R	VESPA		10-15	R	
85	R	Elettrica models						
85	R	Primavera 50 (2T)		19-21	R			
85	R	Primavera Touring 50 (2T)		13-15	R			
85	R	Primavera 50 (4T/4V)		15-21	R			
85	R	Primavera Touring 50 (4T/4V)		13-15	R			
85	R	Sprint 50 (2T)		15	R			
85	R	Sprint 50 (4T/4V)		14-15	R			
85	R			14-15	R			

Part No.	Make/Model	Year		Part No.	Make/Model	Year				
816 Contd.	VESPA Contd.			820 Contd.	TGB					
	Sprint S 50 (2T)	15	R		Delivery Express (125cc)	04-11	R			
	Primavera 125 (4T/3V/ABS)	13-21	R		303R Hawk/Laser 125/150	04-11	R			
	Primavera 125 Touring (4T/3V/ABS)	15-21	R							
	Primavera 125 Touring (4T/3V/ABS)	15	R		821G	GARELLI				
	Primavera 125 Touring (4T/3V/Non ABS)	15	R			RSX 125	81-	F&R		
	Sprint 125 (4T/3V)	14-15	R			GILERA				
	Sprint 125 (4T/3V/ABS)	14-15	R			98 Giubileo		F		
	Sprint S 125 (4T/3V/ABS)	15-21	R			124 Giubileo		F		
	Primavera 150 (4T/3V)	13-15	R			MAICO				
	Primavera 150 (4T/3V/ABS)	13-15	R			All Models	-84	F		
	Primavera 150 Touring (4T/3V/ABS)	15	R			MOTO MORINO				
	Primavera 150 Touring (4T/3V/Non ABS)	15	R			125 Monocilindro	79-	R		
Sprint S 150 (4T/3V/ABS)	15	R	125 KJ/T/KT/Kanguro	84-		R				
			NTV							
			125/175 'Rambler'			R				
817	APRILIA			822G		MAICO				
	Habana 50 (All models)	99-02	R		All Models	-85	R			
	Mojito Custom 50 (120mmØ rear drum)	99-03	R							
	Mojito Retro 50 (120mmØ rear drum)	99-03	R							
	SR 50 H20 (Ditech)	00-03	R							
818	KYMCO			824	USE H307					
	Agility 50 R16 16" wheels (2T)	08-15	R		831G	BULTACO				
	Agility 50 R16 16" wheels (4T)	08-15	R			Lobito 125 and 250cc		F&R		
	Looker 50	07-08	R			Sherpa 250/350 N/A/I		F&R		
	People 50 (2T)	99-15	R			Sherpa (91-250cc. and 92-350cc.)		F		
	People S 50 (4T)	06-14	R			Sherpa (124-250cc, 125-350cc) (150-250cc, 151)		F		
	Super 8 50 2T	07-15	R			Sherpa (198-250cc & 199-350cc)		F&R		
	Super 8 50cc (4T)	07-20	R			Pursang MK6 125/175/200/250/350		F		
	Movie XL 125/150	97-09	R			Pursang MK7 & 8 125/250/360		F		
	Super 8 (125cc) (4T)	08-15	R			Pursang MK9 125/200		F&R		
	Agility 125 Carry (4T)	11-15	R			Pursang MK10 250cc		F		
	Agility RS 125 (4T) (12" wheels)					Pursang MK11 250cc		F		
	/5 Spoke Wheels					Pursang MK12 250cc		F		
	Agility 125 062000/1 12"	09-15	R							
	3 spoke wheels	06-14	R			833G	BULTACO			
	Looker 125 S	07-08	R				Sherpa (124-250cc, 125-350cc) (150-250cc 151)		R	
	People 125	99-11	R				Fronter 250/360/370			
	People One 125i	13-15	R				All Models		F&R	
	People S 125	05-06	R				Pursang MK7 & 8 125/250/360		R	
	Super 8 150 X	19-21	R				Pursang MK9 250/370		F&R	
	Vivio 125/150	00-03	R				Pursang MK10 250cc		R	
	People 150	99-04	R				Pursang MK10 370cc		F&R	
	People S 200	05-06	R				Pursang MK11 250cc		R	
	MALAGUTI						Pursang MK11 370cc		F&R	
	Ciak 125/150/200	01-08	R				Pursang MK12 250cc		R	
							Pursang MK12 370cc		F&R	
	819	SYM						841G	ACCOSSATO	
		CT 125	03-04			R	50/80 Cross/Enduro		83-	F&R
Huskey 125/150		99-05	R	CR 50 Cross/Enduro/Compet.		84-	F&R			
				CE 80/125 Cross/Enduro H 20	84-	R				
820	BAROSSA			831G	ANCILLOTTI					
	XS 125 T-13	07-10	R		PS 80/PST 125 MX/GS	83-	F&R			
	PIZZA PEDS				PSV 250 MX	83-	F			
	125cc 4T Pizza Delivery Scooter	13-15	R		ASPES					
	SYM				CS 75 Navajo/125 Juma/Hopi		F			
	Allo 50 (4T)	11-15	R		CM1 80		F&R			
	Allo GT 50 (4T)	13-15	R		APRILIA					
	Crox 50 (4T)	15-21	R		250	86	R			
	Allo 125 (4T)	11-15	R		TX 125/240/311	86-88	R			
	Combiz 125	11-15	R		ARMSTRONG					
	Crox 125 (4T)	15-21	R		250 Trial/320 Trial		F&R			
	Euro MX 125 (Rear drum models) (HF12 W6 Euro 1)	02-07	R		BETA					
	HD 125/200	04-07	R		124 TR	80-83	F&R			
	HS 125 S Evo	07	R		TR 125	80-83	F&R			
	Shark 125/150	99-02	R		125 TR 32/33	86-87	R			
	Megalo 125	00-07	R		240 TR	80-83	F&R			
	Orbit 125	08-09	R		240 TR 32	84-85	R			
	Tonik 125 (4T)	11-15	R		240 TR 33	86	R			
	VS 125	06-14	R		CAGIVA					
	Allo 150 (4T)	11-15	R		SXT 125	82	R			
	Crox 150 (4T)	15	R		WMX 125 (Rimoldi Hub)	-85	R			
	Jet 4 (150cc/4T)	13-15	R		WMX 250	-85	R			
	VS 150	06-15	R		FANTIC					
					50 Strada	-82	F&R			

Part No.	Make/Model	Year		Part No.	Make/Model	Year									
841G Contd.	FANTIC Contd.			853	TRIUMPH T 12 (650cc/Twin Leading Shoe)	66-70	R								
	50 Repl./Enduro Repl.	-85	F&R	854	TRIUMPH T 12 (650cc/Twin Leading Shoe)	66-70	F								
	50 Enduro Compet.	-82	F&R												
	50 Casa/Competition	75-	F&R	856	PUCH VS/DS/DZS/DSK 50 M2 50cc Sport M3 50cc Sport	74 75	F&R F&R F&R								
	50 Fast	88-	R												
	80 Enduro	80-	F												
	80 Cross Compet.	-81	F&R												
	80 Cross Compet.	81-	F												
	Trial 125		F&R												
	200		F&R												
	201 Monoshock	86	R												
	240		F&R												
	300 Trial		R												
	301 Monoshock	86	R	857	PEUGEOT Elyseo 125/150	99-01	R								
	GARELLI														
	Trial 320	-85	F&R												
	GILERA														
	125 E 1/E 1 Competition		R												
	MALANCA														
	125 Mark Enduro	85-	R												
SVM (SWM)															
50/80 MK/GS/RBS Enduro	83-	F&R													
50/80 MK/MC Cross	83-	F&R													
125/240/320/350 HM/MWTL Trial	-83	F&R	858	BSA Bantam D7 TRIUMPH Cub 500		F&R F&R									
125/250 S1/S2	83-	R													
323 Trial	85-	F&R													
350 XP Sahara	83-	R													
842G	CAGIVA							859	BMW R 80/R 80 RT R 80 GS R 80 PD/CH R 80 Mystic R 80 R R 850 GS R 100 GS R 100 PD R 100 RS R 100 RT R 100 Mystic R 100 R	09/88-95 87-95 90-95 94-95 91-94 96 86-94 89-96 09/09-92 09/89-95 93-96 91-95	R R R R R R R R R R R R				
	SST 250/350	80-82					R								
	SX 250/350	-82					F&R								
	SX 250	82					R								
843G	ANCILLOTTI											860	BMW R 45/45 N R 50/5 / 60/5 / 75/5 R 60/7 R 60 TIC R 75/6 / 75/7 R 80 R 80 TIC R 90 S R 90/6 R 100 R 100/7T R 100 S R 100 RS R 100 RT	78-80 69-76 76-80 78-82 73-79 77-09/80 78-08/80 73-76 73-76 76-77 77-09/80 76-80/80 76-09/80 78-09/80	R R R R R R R R R R R R
	PSV 250 MX	83-					R								
	ASPES														
	CS 75 Navaho/125 Juma/Hopi		R												
	125 Duma		R												
	FANTIC														
	50 Strada Super Six	73-	R												
	50 Strada	82-	R												
	80 Enduro	80-	R												
	80 Cross Compet.	81-	R												
	GILERA														
	80 TG 1/2/3		R												
	125 Arcore		F												
	125 GR 1		R												
	125 E 1/E 1 Competition		R												
	150 Arcore		R												
	GRIMECA HUBS														
	Various makes 140 x 25														
	KRAM-IT (KRAMER)														
	EP 250/EC 250		R												
MC 250/MC 250 LC		R													
MC 500		R													
PUCH M 50 Sport	73-74	F&R													
SVM (SWM)															
125/175/250/347/440 Enduro	-83	F&R													
125/250/440 Cross	-83	F&R													
XN 506 Enduro	84-	F&R													
844 844G	CAGIVA			861	BMW K 75/7-2 K 75 C R 45/45 N R 45 T R 65 R 65 GS R 65 RT R 65 T R 80 R 80/R 80 RT R 80 RT R 80/R 80 RT R 80 GS R 80 ST R 80 TIC R 100/7T R 100 RS R 100 RT	84-96 85-90 10/80-85 80-85 07/88-08/89 87-92 85-88 80-85 10/80-84 84-07/90 82-84 84-95 80-87 82-84 09/80-85 09/80-84 86-08/89 87-08/89	R R R R R R R R R R R R R R R R R R R								
		XSST 125	-82					R							
	SST 250	-80	R												
845	AGRALE							862	BMW R 65 LS	81-85	R				
	Elefantre 30.0		R												
	CAGIVA														
WSXT 125 Aletta Rossa	83-84	R													
GILERA															
50 Rally	87-	R													
851	NORTON											863	BMW K 75/75-S	84-08/88	R
	Commando	68-70	R												
852	NORTON			864	BMW R 50/5 / 60/5 / 60/6 / 75/5	69-76	F								
Commando	68-70	F													

Part No.	Make/Model	Year		Part No.	Make/Model	Year	
873	KTM 60 SX 65 SX MOTO BECANE 50 all mod. Atom hub 50 all mod. Leleu hub	98-99	R	893 Contd.	MALAGUTI Contd. F10 Jet Line WAP F10 Tribal F10 WAP Firefox F15 (Air cooled models) F15 RR Phantom F12 (A/C) Phantom F12R 50 A/C Phantom F69 (70cc) Yesterday 50 America 50 Raid PEUGEOT Django 50 Evasion (2T) Django 50 Evasion (4T) Django 50 Sport (2T) Django 50 Sport (4T)	06-10	R
		98-99	R			08-10	R
875	CASAL Mofas Boss		F&R			100-11	R
			F&R			99-08	R
877	GARELLI 50 Team Matic MOTO BECANE 51 SUE Rock/Rock A Magnum/A/racing	88-	F			99-00	R
			F&R			94-08	R
881	PIAGGIO Cosa CL/CLX 125 Cosa 2 125 Cosa CL/CLX 150 Cosa 2 50 Cosa CL/CLX 200 Cosa 2 200	88-91	R	894	CASAL Mofas drum dia. 110mm		F&R
			R				
882	PIAGGIO Cosa CL/CLX 125 Cosa 2 50/125 Cosa CL/CLX 150 Cosa CL/CLX 200 Cosa 2 200	88-91	F	895	CASAL 50 Ciclomotori		F&R
			F				
883	GILERA Bullit 50	90-	R	896	CASAL - Mofas drum dia. 140mm PIAGGIO Superbrand 50 Zip 7 Zip 50 Bimodale	85-90	F
							94-97
885	PIAGGIO Sefera Base 50 Sefera 50 Maquillage 2 SXR 80 City	91-93	F	897	ADLY RT 50/100 HYOSUNG Grand Prix 125 GPS 125 Grand Prix/Hyper PGO G-Max 50 Rodo Show 50 PMX 50 Mega 50 Big Max 50 Big Max 50 (Front wave disc) Big Max 50 Naked (Round disc /no cover on H/bars) EPS Tornado 50/125 Galaxy 50 G-Max 50 Naked (Wave disc) G-Max 50 (Wave disc) Ligero 50 (2T) PMX 50 Naked T-Rex 50 T-Rex 110 PMX 110 SINNIS Eagle 50 QM 50 T-10R Hawk 50 QM50 10A-(B) SUZUKI TR 50 SW/SX UG 110 W/SW/Y/SY/SK1 Address/Yokuto TGB Bullet 2 50 (2T) City 50cc (2T) City 50cc (4T) 101 R (50cc) 303 Revolution (50/125cc) 309 RS50 F409 Cruise 50-125 Delivery/Express 50 202 Classic (50cc) 303R Hawk/Laser (50cc/125/150cc) Tapo RS 50 (2T) Tapo RR 50 2T Trigger 50 Akros Tec 50 High Wheel 50 X Race 50 (2T) 302 Sport (50cc) 304 Sport (125cc) 309 RS 50		R
			94			F	
886	PIAGGIO Quartz 50	92-96	R			99-04	R
							05-07
889	MONTESA Old models		R			00-09	R
890	PIAGGIO Scatto 50	92-93	F&R			00-07	R
							00-07
893	APRILIA Amico 'All models' Rally Scooter 'All air cooled models' Gulliver 'All models' Sonic (All models) Scarabeo 50 (2T) SR 50 WWW (LYH00) (A/C) SR 50 GP/LB/LF (A/C) SR 50 (L/C) SR 50 Stealth/Racing (LC) BETA Tempo Quadra 50 Ark (Air Cooled) BENELLI K2 Scooter 50 Naked 50 Naked 100 Pepe 50 2T (7 spoke cast wheel) Pepe 50 2T (5 spoke cast wheel) Pepe 50 4T (7 spoke cast wheel) 491 (All drum rear models) Pepe 100 LX CAGIVA City 50 MALAGUTI Ciak 50/100 Centro SL/SL Cat Centro Base 50 F10 Jet Line	96-98	R			07-09	R
		95-02	R			97	R
		95-98	R			93-00	R
		98-08	R			09	R
		93-05	R			08-12	R
		97-01	R			08-12	R
		93-96	R				R
		94-96	R				R
		97-99	R				R
		94-02	R				R
		97-00	R				R
		96-14	R				R
		98-01	R				R
		02-03	R				R
		02	R				R
		99-01	R				R
		10-14	R				R
		12-14	R				R
		98-04	R				R
		99-02	R				R
		91-94	R				R
		00-04	R				R
		94-00	R				R
		93-94	R				R
		96-07	R				R



Part No.	Make/Model	Year		Part No.	Make/Model	Year		
897 Contd.	TGB Contd. F409 Cruise 50/125	02-05	R	V902	PIAGGIO (VESPA) 150 Super (VBC1)	74	R	
899	PIAGGIO			V903	BAJAJ			
	Diesis 50	01-05	R		Boxer 150	12-15	F&R	
	Free 50	02	R		Platina 100 ES	2016	F&R	
	NRG 50 RST (DD/DT) "MC2"	98	R		CT 100	2016	F&R	
	NRG 50 DT "MC3"	01-06	R		LML			
	NRG 50 Power DT	05-15	R		Star 125 (2T)	10-14	R	
	Zip 50 RST	96-99	R		Star 125 Deluxe (2T)	01-03	F	
	Zip 50 RST	96-99	R		Star 125i (4T)	10-15	R	
	Typhoon 50 (2T) (Grimeca)	00-04	R		Star 150 (2T)	10-14	R	
	Zip 50 (2T)	00-15	R		Star 150 Deluxe (2T)	01-03	F	
	Zip 50 (4T)	00-15	R		Star 151i (4T)	10-15	R	
	Zip 50 SP (L/C)	96-15	R		Star 200i (4T)	10-15	R	
	Vespa ET2 50	97-05	R		PIAGGIO (VESPA)			
	Vespa ET4 50 Grimeca Caliper	00-04	R		PK 50	82-85	R	
	Vespa ET4 50 Heng Tong Caliper	00-04	R		PK 50 S	82-85	R	
	Vespa LX 50 (2T & 4T)	05-08	R		PK 50 SS	83-85	R	
	Vespa LX 125/150 (4T)	05-09	R		PK 50 XL	85-88	R	
	NRG 50 Extreme	99-01	R		PK 50 XL	88-89	F&R	
	Typhoon 50 XR	00	R		50 N	89-90	F&R	
	Typhoon 50 (2T) Heng Tong				FL 50	90	F&R	
	Caliper/10" wheels	01-09	R		FL2 Automatica	90-91	F	
	Typhoon 50 (2T) Grimeca Caliper/10" wheels	00-04	R		FL2 50 HP	91-97	F&R	
	Zip 50 A/C (4T)	00-09	R		LX 60 (Special Anniversary Model)	06	R	
	Free Delivery 50	00-01	R		PX 125 E/EFL	81-97	F&R	
	Zip 100	06-10	R		PK 125	82-85	F&R	
	Hexagon 125/150	94-97	R		PK 125 S	82-85	F&R	
	Skipper 125/150	94-97	R		PK 125 S Automatica	84-89	F	
	Sefera 125	95-97	R		PX 125 T5	85-00	F&R	
	Zip 125	00-01	R		FL 125	89-00	F&R	
	APRILIA				PX 150 E/EFL	81-87	F&R	
	Mojito Custom 50 (110mmØ rear drum)	04-12	R		PX 200 E/EFL	81-97	F&R	
	DERBI				Rally 200 (V5E1)			
	Atlantis 50 Bullet (AC/2T)	03-05	R		125 GTR	74	R	
	Atlantis 50 City (AC/2T)	03-06	R		150 Sprint Veloce (VLB1)	74	R	
	Atlantis 50 Red Bullet (AC/2T)	03	R		VESPA			
	Atlantis 50 Two Chic (AC/2T)	05	R		PX 125 (Disc brake model/2T)	98-15	R	
	Atlantis 50 (AC/2T)	02	R		PX 125 Touring (Disc brake model)	15	R	
	Atlantis 50 (2T) Up to Ref No 8G253171 12"/5 spoke wheels /190mm disc 3 bolt	07	R		PX 150 (Disc brake model)	98-15	R	
	Atlantis 50 (2T/AC) 12"/5 spoke wheels 5 bolt/200mm disc From Ref no. 8G253172	07-11	R		PX 150 Touring (Disc brake model)	15	R	
	Ice 50	01-03	R		PX 200 (Disc brake model)	98-07	R	
	Runner 50	98	R		V904	PIAGGIO (VESPA)		
	SKP 50	98	R		50 S	75-83	R	
	GILERA				125 Primavera	67-83	R	
	Stalker 50 (Rear drum models)	97-11	R		125 ET3	76-83	R	
Typhoon 125	95-98	R	V905	PIAGGIO (VESPA)				
Typhoon 125 X-XR	99-00	R	50 R	70-83	F			
VESPA			50 S	68/75-83	F			
LX 50 (4T/2T)	05-13	R	50 Special Revival	91	F			
LXV 50	07-09	R	PK 50/50 S	82-85	F			
S 50 (2T)	07-13	R	PK 50 SS	83-85	F			
S 50 (4T/4V)	08-13	R	PK 50 S Automatica	84-89	F			
S 50 Sport (2T)	11-13	R	50 XL	85-88	F			
S 50 Sport (4T/4V)	11-13	R	125 Primavera	67-83	F			
ET4 125	96-99	R	125 ET3	76-83	F			
ET4 125/150	99-05	R	PK 100 XL	78-83	F			
LX 125 (4T)	05-13	R	150 Super (VBC1)	74	F			
LX 125 (4T/Serie Speciali)	12	R	V906	PIAGGIO (VESPA)				
LXV 125	07-13	R	50 R	70-83	R			
S 125 (4T)	07-13	R	50 Special Revival	91	R			
S 125 Sport (4T)	11-13	R	50 S	68	R			
LX 150 (4T)	05-13	R	PK 100 XL	78-83	R			
LX 150 (4T/Serie Special)	12	R	V907	GILERA				
S 150 Sport (4T)	11-12	R	CBA 50		R			
S 150 (4T)	07-12	R	ec1 50		R			
			ECO 50		R			
V901	PIAGGIO (VESPA)		50 CBA/ECO/EC 1		R			
125 GTR (VNL2)	74	F	PIAGGIO (VESPA)					
150 Sprint Veloce (VLB1)	74	F	Ciao All models	71-99	R			
Rally 200 (VSE1)	74	F	Bravo 50 Alloy Wheels	73-81	R			
			Bravo 50 Spoke Wheels	73-81	R			
			Boss 50	88-89	R			
			Ciao Mix Teen 50	96-01	R			

Part No.	Make/Model	Year		Part No.	Make/Model	Year										
V907 Contd.	PIAGGIO (VESPA) Contd. Ciao 50 Catalitico Grillo 50 S1 50 Alloy Wheels S1 50 Spoke Wheels S1 50 FL2 S1 Mix 50 Superbrand 50	99-05	R	921 Contd.	GILERA RV 125 125 Cougar Strada/Sport 125 125 TG 1/2/3 TSR 125 TSR 125 200 T4/T4 C/T4 S HERCULES (SACHS) 50 Ultra, RS Ultra 80 Ultra, F Ultra, RS Ultra 80 Ultra Chopper LAVERDA LB 125 Custom/Sarbia LZ 125 Sport LZ 125 Sport MOTO MORINI 250 all models 350 Sport 350 FT/Turismo	88	R									
		89-93	R			88-99-02	R									
		79-88	R				R									
		79-88	R				R									
		91-97	R			-83	R									
		96-99	R			83-	R									
		85-90	R				R									
908	BENELLI Motorella GARELLI Eureka, Gulp 50 Vip/Noi/Basic spoke wheel GILERA CBA 50 ec1 50 ECO 50 50 CBA/ECO/EC 1 KREIDLER 50 MF4 Early models 50 MP1 Early models MALAGUTI Chopper 25/40 50 LX Sport 50 Ronco RCW VA Olympique Chopper 80 NVT Easyrider PIAGGIO Free TOMOS Moped with spoked wheels	78-	F&R	922 922G	FANTIC 50 Trial 50 Enduro 50 Caballero 80 Trial GILERA 50 GR 2 98 Giubileo 124 Giubileo 125 Arcore HERCULES (SACHS) 50 Supra Enduro 80 Ultra AC 80 Ultra AC Chopper MALAGUTI 50 MDX Gold Enduro 50 Enduro MEX 50 Enduro MEX 50 Enduro MGX 50 Enduro MLX 50 Enduro MXS 50 RGT Sport 50 Fifty HF/NL 4 gears	-83	R									
			F&R			83-	F&R									
			F&R			-83	F&R									
			F			-83	F&R									
			F				F									
			F				R									
			F				R									
			F				R									
			F				R									
			F				R									
		F&R			F&R											
		92-00	F		92-00	R										
			F&R			R										
						R										
						R										
						R										
						R										
						R										
						R										
						R										
						R										
						R										
909	FANTIC 50 Sprinter/3V.R GARELLI Junior Turismo GILERA 50 GSA/Vale 50 Trend 50 Trial/Enduro PIAGGIO (VESPA) Ciao All Models Ciao 50 Catalitico Bravo 50 Alloy Wheels Free 50 Zip 50 Base (Drum Model) Grillo 50 S1 50 Alloy Wheels S1 50 FL2 Bravo 3 Boss 50 TOMOS Hip Hop Luxe EX 25 Revival TS Streetmate R Pack'r Ex Quadra Quadra EX Racing Flexer XL Flexer EX 25 Standard Standard XL Luxe 25 Alpino (Front disc) Alpino 45 (Drum brakes) APN6 Classic XL Funsport R 25 Fantastic 25		83-	F&R	924	GILERA 50 GSA/Vale		R								
		F&R		925			GILERA 150 Arcore		F							
		F						926 926G	ACCOSSATO 50 Cross Mini ASPES 50 Navaho FANTIC 50 Trial GARELLI 50 Ciclone/KL 50 SV Gran Turismo MALAGUTI Centro Base 50 50 Fifty HF 50 Watercooled 50 Fifty Full/CX 50 Fifty Top SWM (SWM) 50/80 TR/TL Trial	82-	F&R					
		F&R									F&R					
		F								-83	F					
		F&R									F&R					
		F&R				F&R										
		F	93-94	F												
		F&R	-82	R												
		F&R	-82	R												
		F&R	83-	R												
		F&R	85-	R												
		F&R		R												
		F&R	-83	F&R												
		71-99	F	927G		MOTO MORINI 350 Kanguro 350 Kanguro	-83	F&R								
			F				-84-86	R								
			F													
			F													
			F													
			F													
		99-05	99-05	F		928	DUCATI 250/350/450 Desmo	-76	F							
								929	BENELLI 124/125 2C/125 2T/2CSE 125 2C twin brake 125 T Adiva 125 12" front wheel 250 C/TS, 250/4 254/304 500-4	76-	R					
										-76	R					
										83	R					
										00	R					
										76-	R					
										83	R					
										76-	R					
										95-01	R					
										87	R					
										74-77	R					

Part No.	Make/Model	Year		Part No.	Make/Model	Year	
929 Contd.	BENELLI Contd. 250/350/450 Desmo	-76	R	940G	ACCOSSATO CE 80/120 Cross/Enduro H 20	84-	F
930G	FANTIC 50/50.1 Raider 50.1 Oasis KS/Rally 50.1 Trial Trial 50 Junior 80 Trial GARELLI Trial 323 MALAGUTI 50 Enduro RCW-X/Sahib	81- 86- 86- 87- 83-	R R R F&R F&R	941	ASPES RCL 80		F&R
931 931G	TOMOS Moped with cast wheels BENELLI 50 G2 Elle GARELLI 50 Vip/Noi/Basic Alu wheel Formuno 50 50 Team Matic MALAGUTI 50 RGT Strada 50 Custom Fox 50 Dribbling 50 Fifty RV 50 Ranocchio 3 wheels Grizzly 10 CE (50cc) Grizzly 10 (50cc) Grizzly 12 CE Grizzly 12 Grizzly Quad Grizzly RCW4 Grizzly RCX 10 Grizzly RCX 12 PUCH Maxi 50 Executive Cast Wheels /1 Speed Automotive Maxi S 50 Sport Cast Wheel 1 Speed Automatic Maxi 50 Super Cast Wheel /2 Speed Automatic Magnum 50 Automatic Kids Bike	79- 87- 88- 83- 87- 87- 87- 87- 08-09 01-07 08-09 01-07 87- 90-94 90-00 90-00	F&R F&R F&R R F&R F&R F&R F&R R R F&R F&R F&R R R R R F F F F&R	V942	PIAGGIO (VESPA) Vespa PK 50 S Automatica Vespa FL2 Automatica Vespa PK 125 S Automatica	84-89 90-91 84-89	R R R
				944G	WMX 125 (Rimoldi Hub) HRD RP 50 Cross RP 80 Cross	-85 83-	F&R F&R
				945	BENELLI S 50 Scooter FANTIC 50 Issimo spoke wheel 50 Joy PUCH Maxi 50 Executive Cast Wheels /1 Speed Automotive Maxi S 50 Sport Cast wheel /1 Speed Automatic Maxi 50 Super Cast wheel /2 Speed Automatic	81- 92-	F F&R F&R R R R
				946	BENELLI 125 2C twin brake	-76	F
				949	CAGIVA Roadster 125 (521 1A Model) Roadster 125 (1AA Model) CZ / JAWA 125/175/250/350 125/175/250/350 350 New Classic 350 Classic	92-94 95-99 -74 75- 13-14	R R F&R R R R
				950	CZ / JAWA Scrambler Cross 125 x 300 Jawa 250/400 Cross 250/380 (Models 513/514)	65-76 65-76 77-79	F&R F&R R
932	KREIDLER 50 Flory MF 12/13 50 Flory MF 23/24/25 50 LH/LF/LFF 50 RMC/RMC-BG Mustang 125 125 125 RS PUCH Monza 4 SL/GP Imola X/GX Cobra 80/80-6/80-6 GT/GTL		F&R F&R F&R F&R R R R R F&R R R	951	CZ / JAWA 125/175/250/350	75-	F
933G	MONTESA/HONDA Cota 123/290/349 Cota 123/200/242/349 348 Trial Enduro	-83 84	F&R R F&R	953	CAGIVA 125 Elefant RE	87	R
934G	OSSA Pre 1980 Models 125 Cross 250 Cross/Fuego/Super Pioneer	74- 74-	F&R F F	954	GILERA 125 RX RX 200/Arizona/Enduro 200 Arizona Hawk 200 RTX 200 ER RX 125 Arizona	84- 85- 85- 85- 87- 88	R R R R R R
935G	OSSA 81 Onwards		F	958	LAMBRETTA 175 TV-1 125/150/175 L1		R F&R
936G	OSSA 81 Onwards FB MINARELLI (SPAIN) MR 80		R R	959	LAMBRETTA 125/150/200 DL		F&R
937G	MONTESA/HONDA Cota 123/200/242/349	84	F	965	ITALJET (All Models 125cc) BENELLI S 50 Scooter	81-	F&R R
938	HYOSUNG TE 50 TE 90 TE 100	05-07 05-07 05-07	F F F	966	KREIDLER 50 RM 80 E/L Florett		F&R R
				970	PUCH MS 50/50 L		F&R
				972	PUCH 50 KA/K2/K25/K3T/MSP		F&R

Part No.	Make/Model	Year		Part No.	Make/Model	Year	
975	ZUNDAPP KS 50 Sport/Supersport KS 100	All years All years	R R				
976	ZUNDAPP CS 25 Mofa BJ (Type 448-140) CS 25 Mofa BJ (Type 448-141) CX 25 Mofa BJ (Type 448-151) CX 25 Mofa BJ CS 50 Mokick BJ (Type 448-010) CS 50 Mokick BJ (Type 448-011) CS 50 Mokick BJ (Type 448-013) Hai 25 25 Mofa BJ (Type 448-150) Hai 50 50 Mokick Enduro (Type 448-150) Hai 50 50 Mokick Enduro (Type 448-111)	80-82 82 82 83-84 79-80 80 80-82 80-82 80 80-82	F&R F&R F&R F&R F&R F&R F&R F&R F&R F&R				
977G	CAGIVA WMX 125 WM 125 WMX 250	86 87-88 86-88	R R R				
978	MZ TS 125/150 TS 250 ETZ 250/300 251 Fun Saxon 'Tour' 251/301 Saxon 500 'All models'	85-92 95-96 93-98 93-98	F F&R R R R R				
979	MZ Saxon 125 Saxon 150 TS 125/150 ETZ 125/150	93-97 95 85-92	R R R R				
980	MZ Simpson	80-94	F&R				
982G	CAGIVA WMX 500	84-86	R				
983	GARELLI GTA 125	85	R				
984	HUSQVARNA Husky Boy J Husky Boy R Husky Boy S	01-02 01 01-02	R R R				
985	FB MINARELLI (SPAIN) Rieju Marathon	74-	F&R				
987	GILERA 350 Dakota ER 350 500 Dakota ER 500	85- 87- 87- 87-	R R R R				
990G	OSSA 125 Cross 250 Cross/Fuego/Super Pioneer	74- 74-	R R				
995	APRILIA Classic 50 FANTIC 50.1 Oasis Kick 50.1 Trial H 20	92-01 87- 87-	R R R				

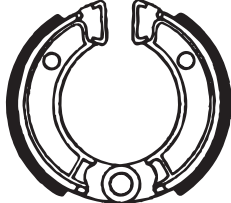
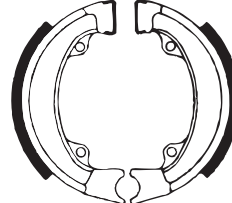
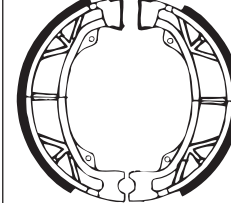
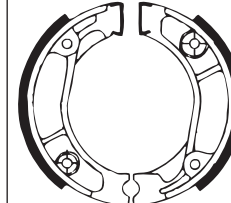
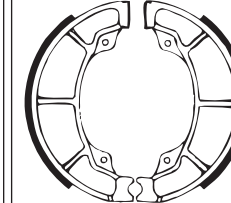
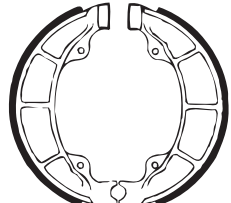
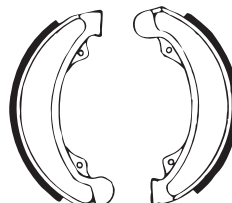
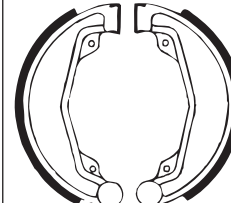
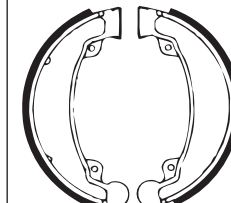
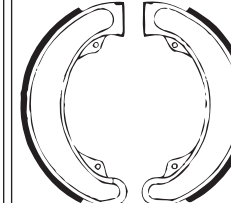
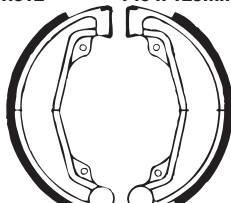
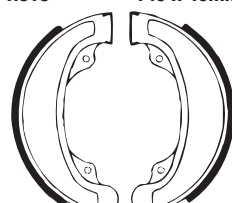
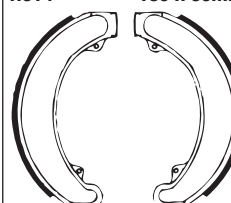
BRAKE SHOE ILLUSTRATIONS

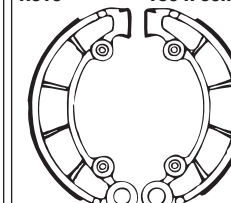
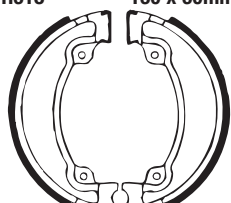
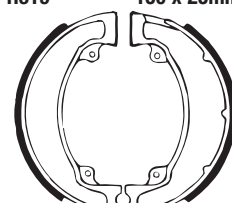
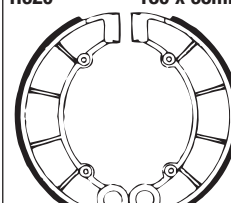
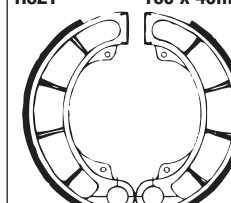
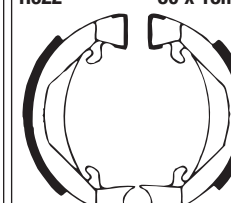
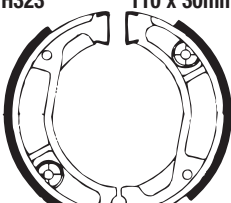
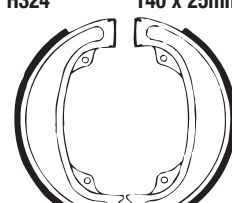
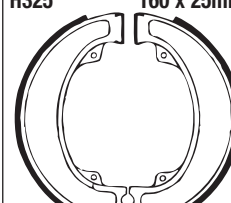
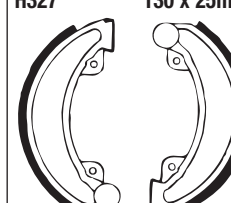
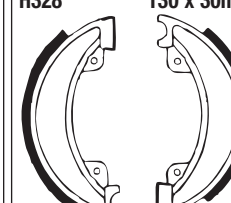
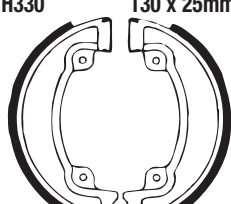
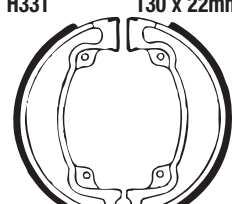
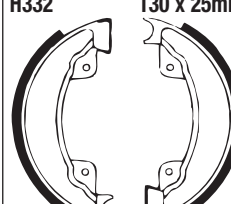
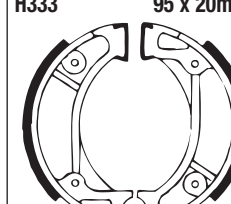
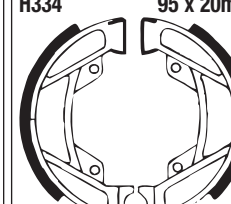
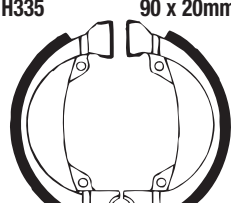
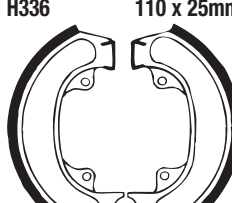
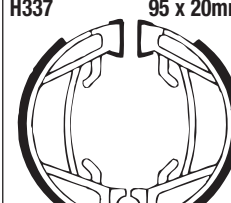
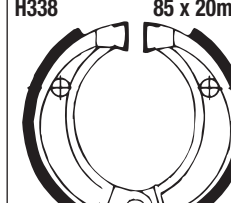
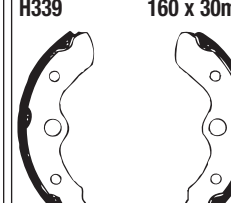
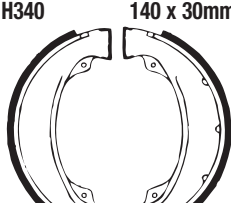
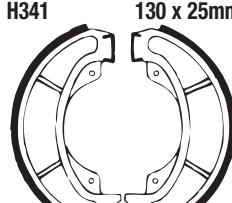
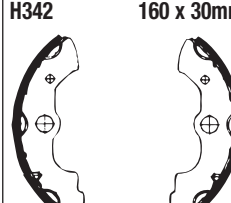
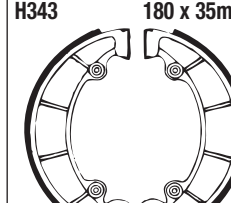
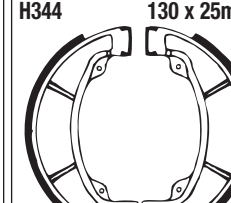
H301 80 x 18mm 	H302 95 x 20mm 	H303 110 x 25mm 	H304 110 X 25mm 	H306 140 x 28mm 
H307 130 x 28mm 	H308 160 x 30mm 	H309 140 x 30mm 	H310 130 x 30mm 	H311 160 x 25mm 
H312 140 x 125mm 	H313 140 x 40mm 	H314 180 x 30mm 	H315 160 x 30mm 	H316 180 x 30mm 
H318 130 x 30mm 	H319 150 x 25mm 	H320 180 x 38mm 	H321 160 x 40mm 	H322 80 x 18mm 
H323 110 x 30mm 	H324 140 x 25mm 	H325 160 x 25mm 	H327 130 x 25mm 	H328 130 x 30mm 
H330 130 x 25mm 	H331 130 x 22mm 	H332 130 x 25mm 	H333 95 x 20mm 	H334 95 x 20mm 
H335 90 x 20mm 	H336 110 x 25mm 	H337 95 x 20mm 	H338 85 x 20mm 	H339 160 x 30mm 
H340 140 x 30mm 	H341 130 x 25mm 	H342 160 x 30mm 	H343 180 x 35mm 	H344 130 x 25mm 

BRAKE SHOE ILLUSTRATIONS

H345 130 x 25mm 	H346 87 x 20mm 	H347 160 x 20mm 	H347S 160 x 20mm 	H350 130 x 25mm
H351 160 x 30mm 	H352 130 x 25mm 	H353 110 x 25mm 	Y501 80 x 17mm 	Y502 95 x 20mm
Y503 110 x 25mm 	Y504 110 x 25mm 	Y506 130 x 28mm 	Y507 130 x 22mm 	Y508 130 x 22mm
Y510 150 x 25mm 	Y512 180 x 40mm 	Y513 180 x 30mm 	Y514 180 x 30mm 	Y515 200 x 40mm
Y516 160 x 30mm 	Y517 130 x 22mm 	Y518 110 x 25mm 	Y519 95 x 20mm 	Y520 165 x 30mm
Y521 130 x 28mm 	Y522 150 x 25mm 	Y523 165 x 27mm 	Y524 165 x 25mm 	Y525 100 x 20mm
Y526 200 x 35mm 	Y527 130 x 28mm 	Y528 159 x 25mm 	Y530 110 x 25mm 	Y531 130 x 28mm
Y532 160 x 30mm 	Y533 150 x 28mm 	Y534 160 x 32mm 	Y535 130 x 28mm 	Y536 100 x 20mm

BRAKE SHOE ILLUSTRATIONS

SHOE
BUYERS GUIDE

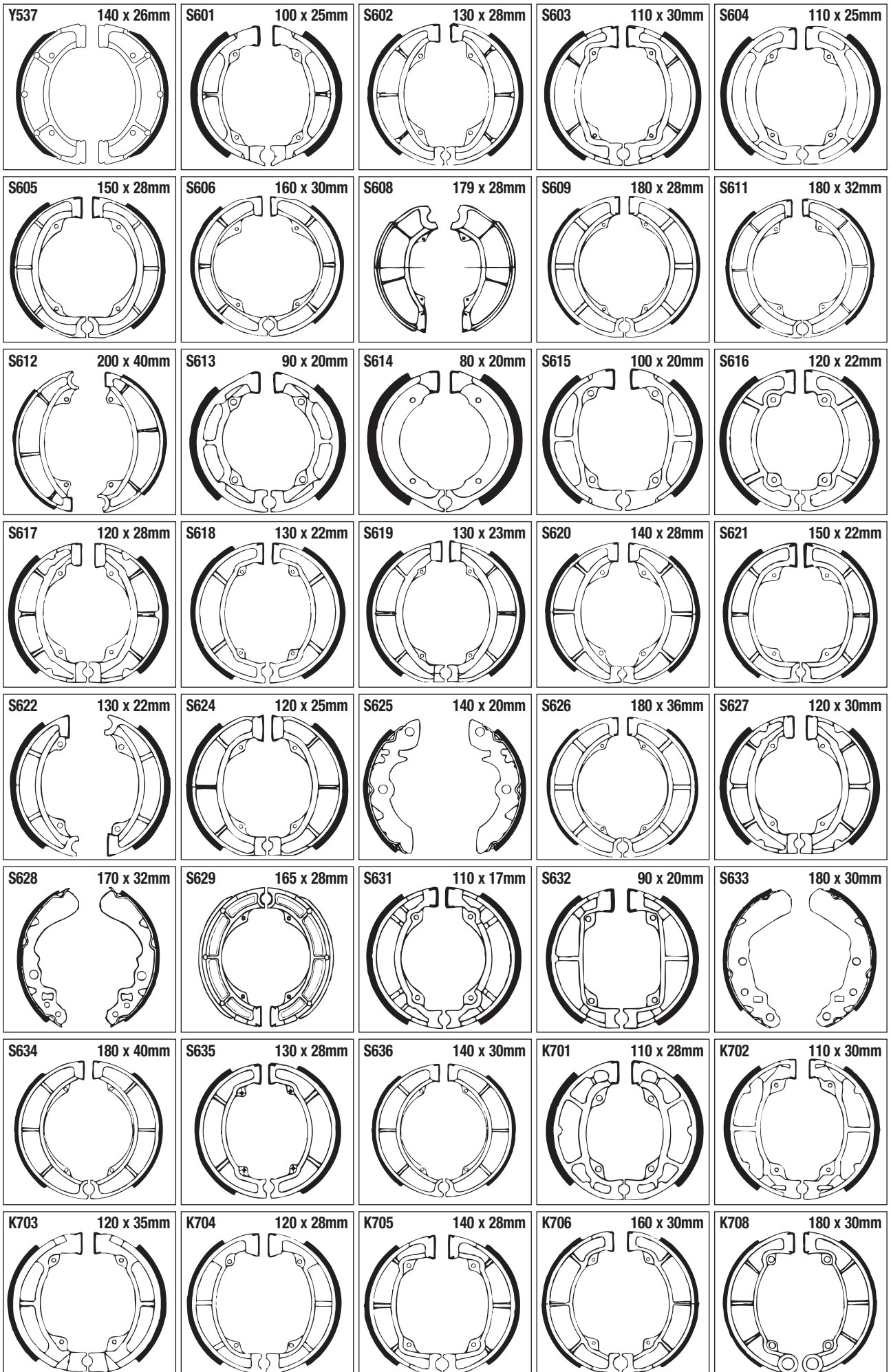

BRAKE SHOE ILLUSTRATIONS

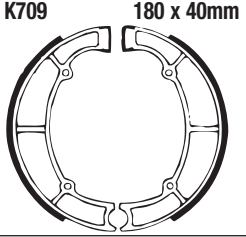
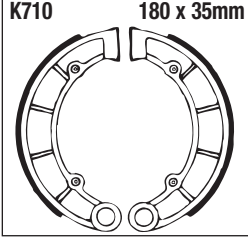
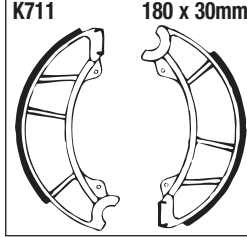
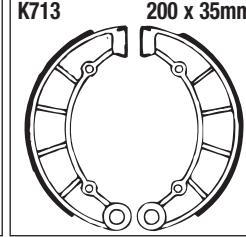
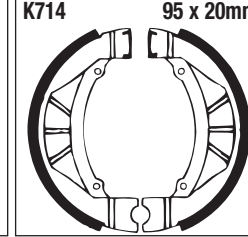
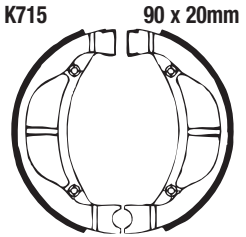
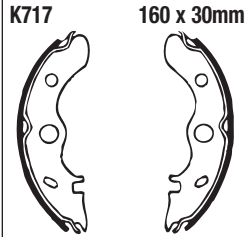
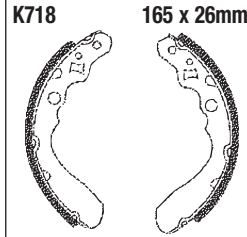
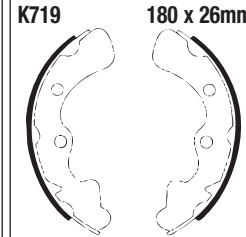
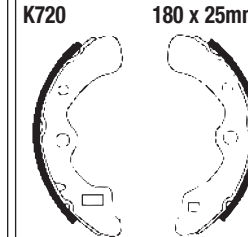
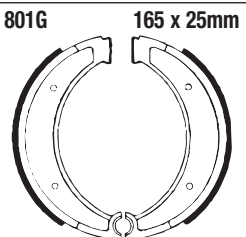
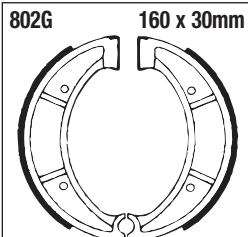
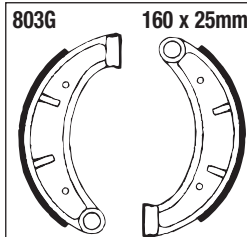
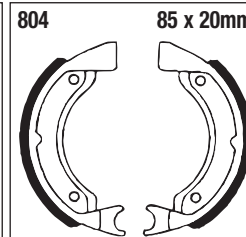
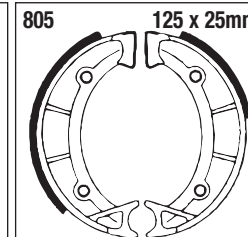
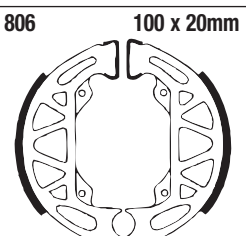
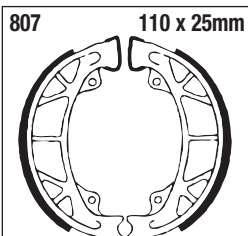
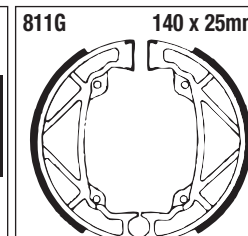
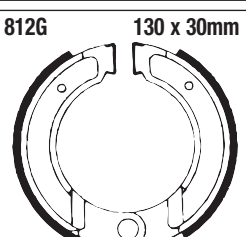
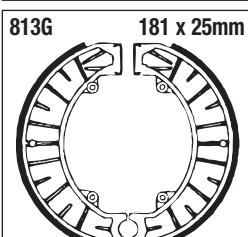
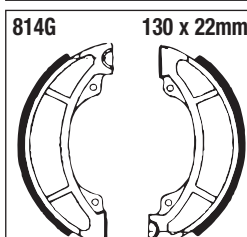
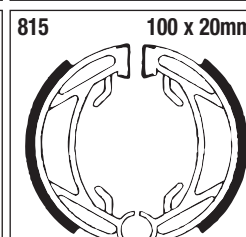
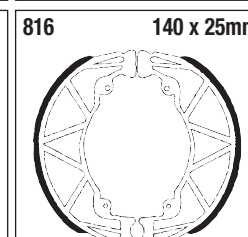
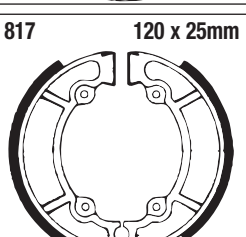
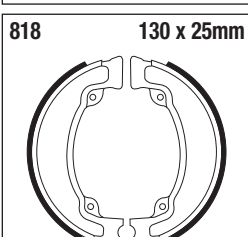
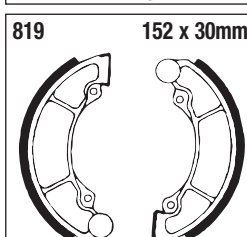
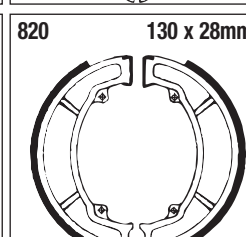
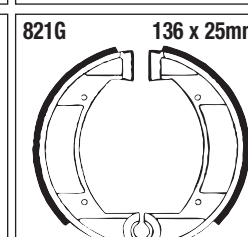
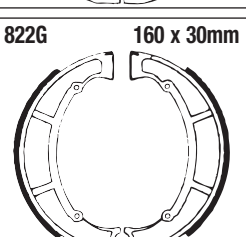
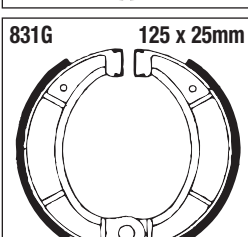
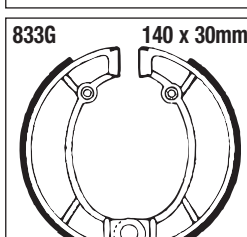
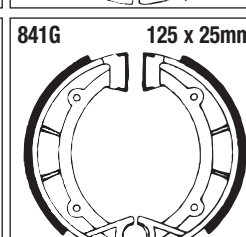
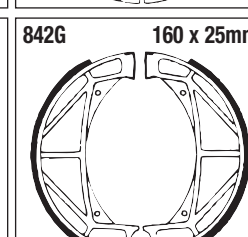
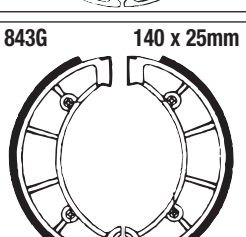
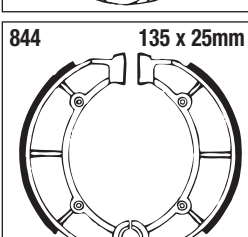
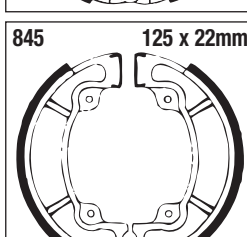
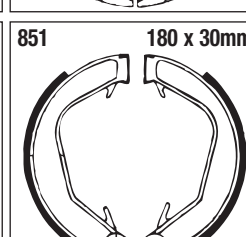
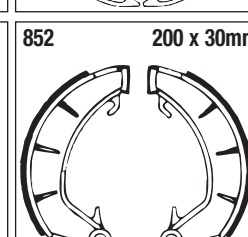
K709 180 x 40mm 	K710 180 x 35mm 	K711 180 x 30mm 	K713 200 x 35mm 	K714 95 x 20mm 
K715 90 x 20mm 	K717 160 x 30mm 	K718 165 x 26mm 	K719 180 x 26mm 	K720 180 x 25mm 
801G 165 x 25mm 	802G 160 x 30mm 	803G 160 x 25mm 	804 85 x 20mm 	805 125 x 25mm 
806 100 x 20mm 	807 110 x 25mm 	808 100 x 22mm PIC NOT AVAILABLE	809 150 x 24mm PIC NOT AVAILABLE	811G 140 x 25mm 
812G 130 x 30mm 	813G 181 x 25mm 	814G 130 x 22mm 	815 100 x 20mm 	816 140 x 25mm 
817 120 x 25mm 	818 130 x 25mm 	819 152 x 30mm 	820 130 x 28mm 	821G 136 x 25mm 
822G 160 x 30mm 	831G 125 x 25mm 	833G 140 x 30mm 	841G 125 x 25mm 	842G 160 x 25mm 
843G 140 x 25mm 	844 135 x 25mm 	845 125 x 22mm 	851 180 x 30mm 	852 200 x 30mm 

BRAKE SHOE ILLUSTRATIONS

SHOE
BUYERS GUIDE

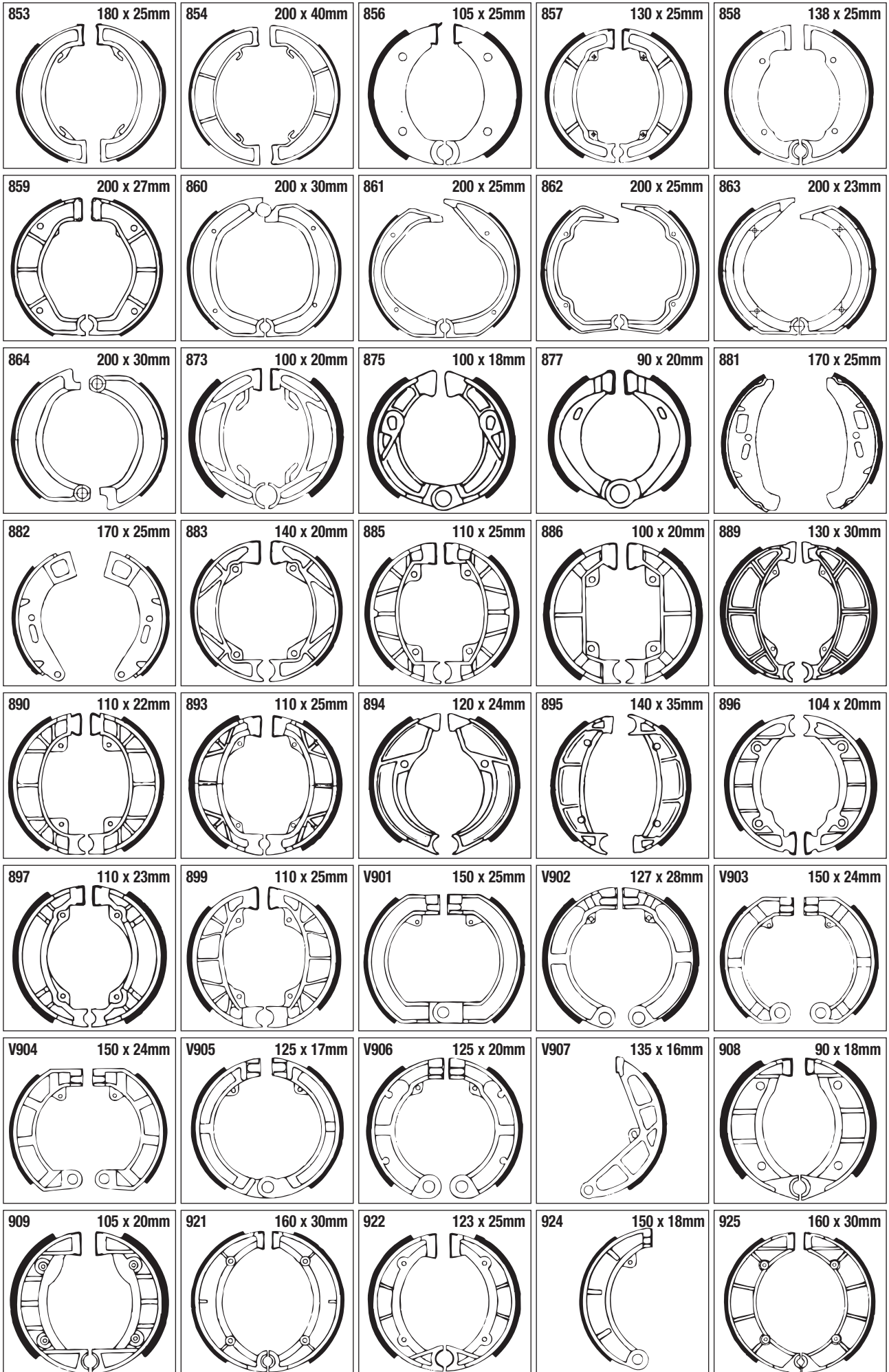

BRAKE SHOE ILLUSTRATIONS

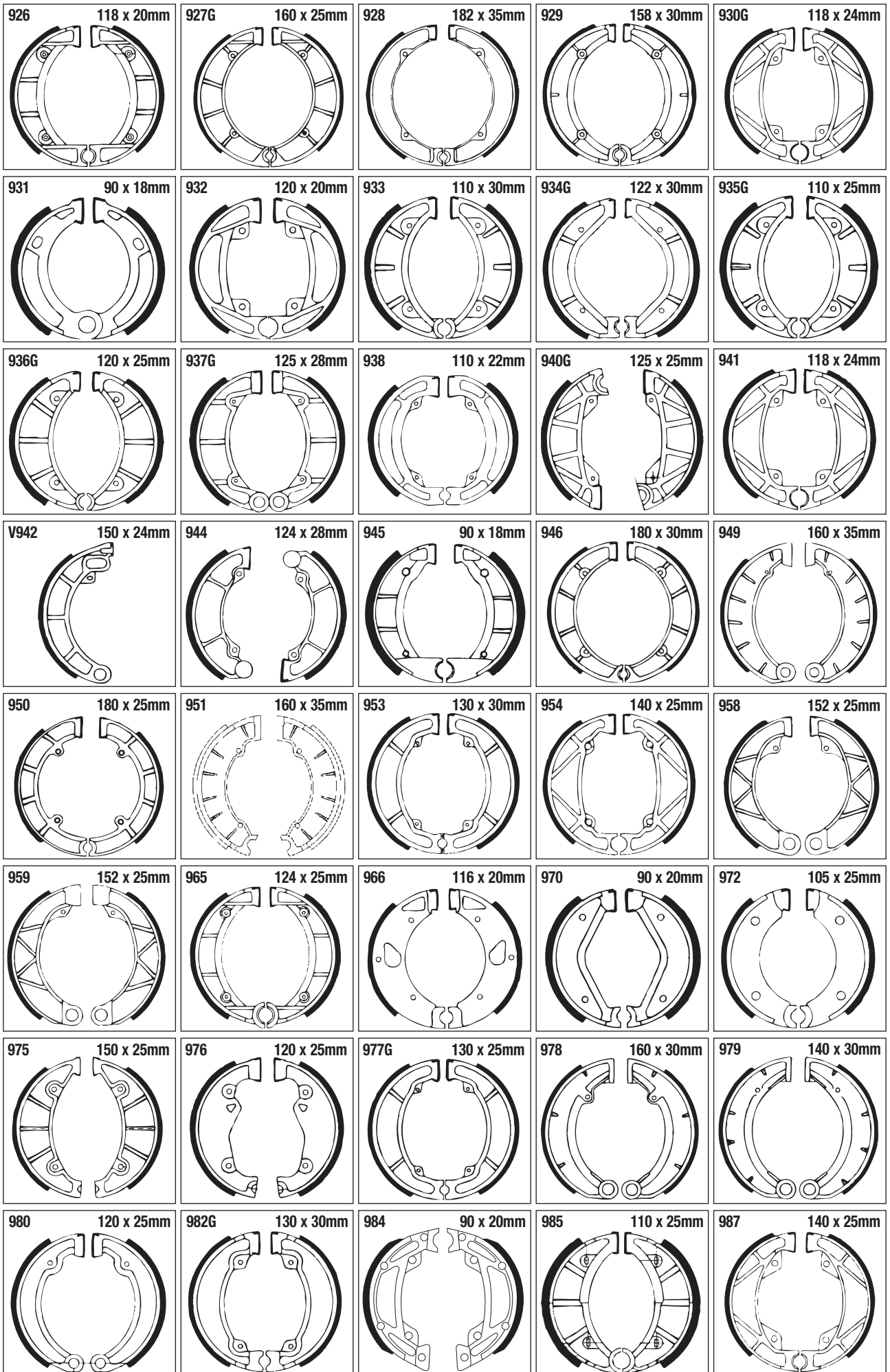

BRAKE SHOE ILLUSTRATIONS

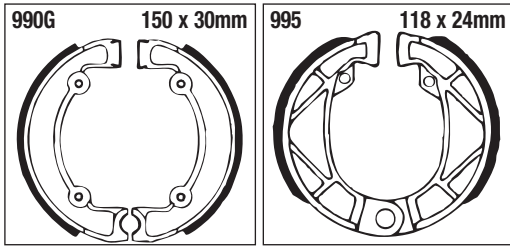

BRAKE SHOE DIAMETER CHART
(in mm)

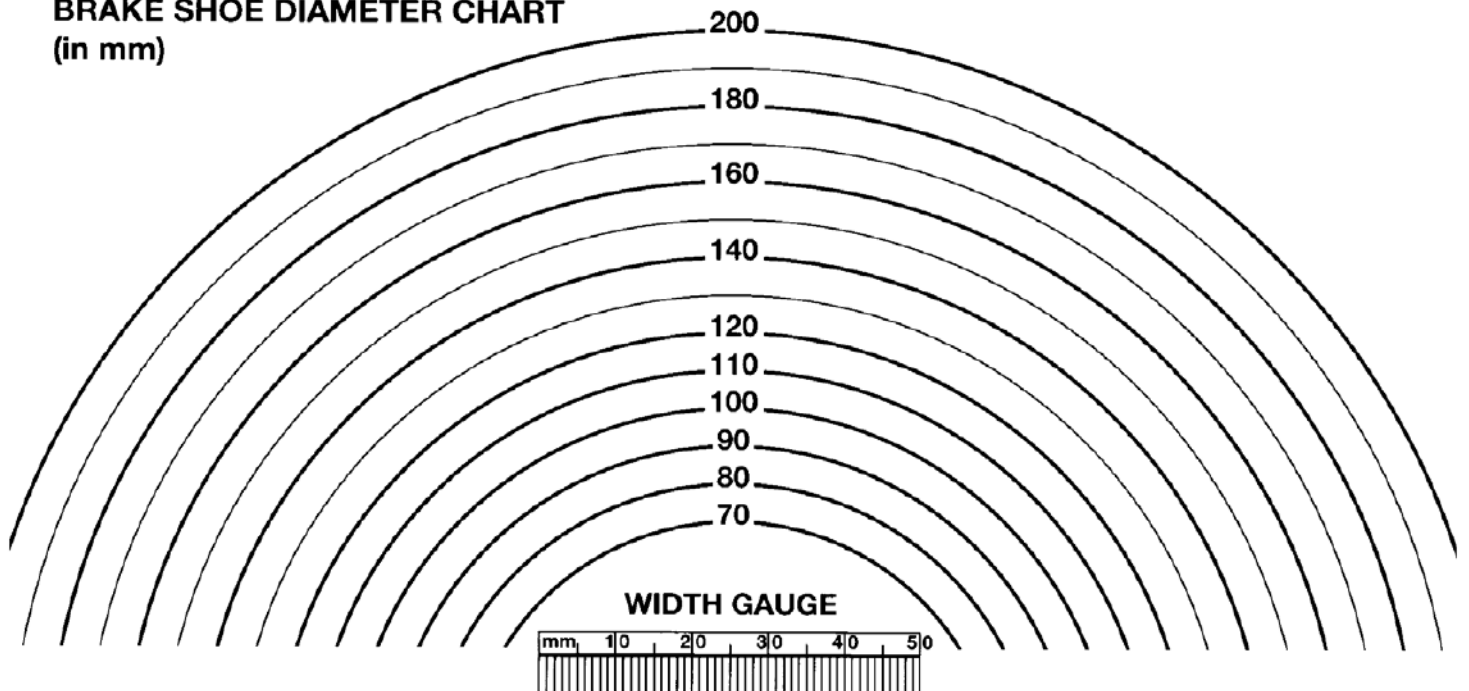

STREETBIKE DISC BUYERS GUIDE

Disc No.	F/R	Type	Dia. (mm)	Hub Color	Profile	Bobbins	Left Bracket	Right Bracket	Model	Year
Disc Group 001 FSD008	Front	Solid	290	N/A	Plain	N/A			HARLEY DAVIDSON® All models, 2000 onwards (Check main catalogue for model fitments)	
FSD010	Front	Floating	290	Polished	Plain	5				
FSD010BLK	Front	Floating	290	Black	Plain	5				
FSD012C	Front	Floating	290	Polished	Contour	5				
FSD012CBLK	Front	Floating	290	Black	Contour	5				
FSD023	Front	Floating	290	Polished	Plain	10				
FSD023BLK	Front	Floating	290	Black	Plain	10				
FSD027C	Front	Floating	290	Polished	Contour	10				
FSD027CBLK	Front	Floating	290	Black	Contour	10				
VR009	Front	Solid	290	N/A	Vee	N/A				
VR010BLK	Front	Floating	290	Black	Vee	5				
VR023BLK	Front	Floating	290	Black	Vee	10				
OSMD004-14BLK	Front	Floating	355	Black	Plain	5	BRK703	BRK704		
OSMD004-15BLK	Front	Floating	381	Black	Plain	5	BRK707	BRK708		
OSMD004-15/6BLK	Front	Floating	381	Black	Plain	5	BRK707	BRK708		
OSVR004-14BLK	Front	Floating	355	Black	Vee	5	BRK703	BRK704		
OSVR004-15BLK	Front	Floating	381	Black	Vee	5	BRK707	BRK708		
OSVR004-15/6BLK	Front	Floating	381	Black	Vee	5	BRK707	BRK708		
Disc Group 002 FSD007	Front	Solid	290	N/A	Plain	N/A			HARLEY DAVIDSON® 11 1/2" Front Floating Disc Conversion. (Sportsters & Big Twins with speedo notch) See main catalogue listing for full fitment info.	
FSD009	Front	Floating	290	Chrome	Plain	5				
FSD009BLK	Front	Floating	290	Black	Plain	5				
FSD011C	Front	Floating	290	Chrome	Contour	5				
FSD011CBLK	Front	Floating	290	Black	Contour	5				
FSD022	Front	Floating	290	Chrome	Plain	10				
FSD022BLK	Front	Floating	290	Black	Plain	10				
FSD026C	Front	Floating	290	Chrome	Contour	10				
FSD026CBLK	Front	Floating	290	Black	Contour	10				
VR007	Front	Solid	290	N/A	Vee	N/A				
VR011BLK	Front	Floating	290	Black	Vee	5				
Disc Group 003 RSD008	Rear	Solid	290	N/A	Plain	N/A				HARLEY DAVIDSON® All models, 2000 onwards (Check main catalogue for model fitments)
RSD020	Rear	Floating	290	Chrome	Plain	10				
RSD018C	Rear	Floating	290	Chrome	Contour	10				
RSD020BLK	Rear	Floating	290	Black	Plain	10				
RSD018CBLK	Rear	Floating	290	Black	Contour	10				
VR008	Rear	Solid	290	N/A	Vee	N/A				
VR020BLK	Rear	Floating	290	Black	Vee	10				
Disc Group 004 RSD007	Rear	Solid	290	N/A	Plain	N/A			HARLEY DAVIDSON® 11 1/2" Front Floating Disc Conversion. (Sportsters & Big Twins with speedo notch) See main catalogue listing for full fitment info. RSD007A - INDIAN Chief/Deluxe/Springfield/Road Master/Vintage/Scout/Spirit	
RSD007A	Rear	Solid	290	N/A	Plain	N/A				
RSD019	Rear	Floating	290	Chrome	Plain	10				
RSD019C	Rear	Floating	290	Chrome	Contour	10				
RSD019BLK	Rear	Floating	290	Black	Plain	10				
RSD017CBLK	Rear	Floating	290	Black	Contour	10				
VR019BLK	Rear	Floating	290	Black	Vee	10				
MD509SR Billet	Rear	Solid	290	N/A	Plain	N/A			HARLEY DAVIDSON® FLT, FLHT, FLHTCI FLHR, FLHRCI	86-99 94-99
Disc Group 005 MD511	Rear	Solid	240	N/A	Plain	N/A			BUELL All Model	94-02
Disc Group 006 MD514LS/RS VR514	Front Front	Solid Solid	292 292	N/A N/A	Plain Vee	N/A N/A			HARLEY DAVIDSON® VRSCA V-Rod	02-05
MD515	Rear	Solid	292	N/A	Plain	N/A			HARLEY DAVIDSON® VRSCA V-Rod	02-05
Disc Group 007 MD516 MD516X VR516	Front Front Front	Solid Floating Solid	300 300 300	N/A Chrome N/A	Plain Plain Vee	N/A 5 N/A			HARLEY DAVIDSON® V-Rod Models	06-17

STREETBIKE DISC BUYERS GUIDE

Disc No.	F/R	Type	Dia. (mm)	Hub Color	Profile	Bobbins	Left Bracket	Right Bracket	Model	Year	
Disc Group 007 Contd.											
VR516BLK	Front	Floating	300	Black	Vee	5			HARLEY DAVIDSON®		
OSMD516-14	Front	Floating	355	Polished	Plain	5	BRK703	BRK704			
OSMD516-14BLK	Front	Floating	355	Black	Plain	5	BRK703	BRK704			
OSVR516-14	Front	Floating	355	Black	Vee	5	BRK703	BRK704			
OSMD516-15	Front	Floating	381	Polished	Plain	5	BRK711	BRK712			
OSMD516-15BLK	Front	Floating	381	Black	Plain	5	BRK711	BRK712			
OSVR516-15	Front	Floating	381	Black	Vee	5	BRK711	BRK712			
Disc Group 008											
MD517	Rear	Solid	300	N/A	Plain	N/A			HARLEY DAVIDSON® V-Rod Models	06-17	
VR517	Rear	Solid	300	N/A	Vee	N/A					
VR517BLK	Rear	Floating	300	Black	Vee	9					
Disc Group 010											
MD520	Front	Floating	300	Polished	Plain	5			HARLEY DAVIDSON® Touring Series Models	08-13	
VR520	Front	Solid	300	N/A	Vee	N/A				FLHTCUTG Tri Glide Ultra Classic Trike	09-13
VR520BLK	Front	Floating	300	Black	Vee	5				FLHXXX Street Glide Trike	10-11
MD541	Front	Solid	300	N/A	Plain	N/A					
Disc Group 011											
MD521	Rear	Floating	300	Polished	Plain	10			HARLEY DAVIDSON® Touring Series Models	08-14	
MD521C	Rear	Floating	300	Polished	Contour	10				FLHRC Road King Classic	14-20
MD521BLK	Rear	Floating	300	Black	Plain	10				FLHTCU Ultra Classic Electra Glide	14-20
VR521	Rear	Solid	300	N/A	Vee	N/A				FLHTCHL Ultra Classic Electra Glide LOW	15
VR521BLK	Rear	Floating	300	Black	Vee	10				FLHTK Ultra LTD	15-20
										FLHTKL Ultra LTD LOW	15-20
										FLHX Street Glide	14-20
										FLHXS Street Glide Special	14-20
										FLTRX Road Glide	15-20
										FLTRXS Road Glide Special	15-17
										FLHR Road King (Cast Wheel Type)	15-20
									FLTRXS Road Glide Special	15-17	
									FLTRU Road Glide Ultra	16-20	
MD522											
	Rear	Solid	240	N/A	Plain	N/A			BUELL	04-10	
										XB12R Firebolt	09-10
										XB12 SS Lightning	02-07
										Firebolt XB9R	03-04
										XB9S Lightning	04-08
										XB12S Lightning	05-09
										XB9SX Lightning City/X	06-10
										XB12X Ulysses	08-10
										XB12XT Ulysses	06-08
										XB12SCG Lightning	06-08
										XB12SS Lightning Long	06-08
										XB12STT Lightning	08
										XB12STT Lightning	08
										XB12SCG Lightning	09-10
										XB9 SX Lightning	08-10
Disc Group 012											
MD523	Front	Solid	290	N/A	Plain	N/A			HARLEY DAVIDSON®	10-12	
FSD523	Front	Floating	290	Polished	Plain	5				XR 1200 X	08-10
MD523X	Front	Floating	290	Gold	Plain	5				XR 1200	
VR523BLK	Front	Floating	290	Black	Vee	5					
Disc Group 013											
MD524	Rear	Solid	260	N/A	Plain	N/A			HARLEY DAVIDSON®	11-13	
RSD524	Rear	Floating	260	Polished	Plain	10				XL 883 L Superlow	14-20
MD524X	Rear	Floating	260	Gold	Plain	10				XL 883 L Superlow (Cast wheel)	11-15
VR524BLK	Rear	Floating	260	Black	Vee	10				XL 883 R Roadster (Cast wheel)	11-15
										XL 883 N Iron (Cast wheel)	11-15
										XL 883 N	16-20
										XL 1200 C Custom	11-20
										XL 1200 L Sportster Low	07-11
										XL 1200 T Superlow	14-20
										XL 1200 V Seven Two	14-15
										XL 1200 X Forty Eight	14-17
									XR 1200	08-10	
									XR 1200 X	10-12	
Disc Group 014											
MD525	Rear	Floating	300	Polished	Plain	9			HARLEY DAVIDSON®	14-17	
VR525BLK	Rear	Floating	300	Black	Vee	9					VRSCF V-Rod Muscle

STREETBIKE DISC BUYERS GUIDE

Disc No.	F/R	Type	Dia. (mm)	Hub Color	Profile	Bobbins	Left Bracket	Right Bracket	Model	Year
Disc Group 015									HARLEY DAVIDSON®	
MD526	Front	Solid	300	N/A	Plain	N/A			XL 883 L (Superlow/Cast wheel)	14-20
MD526X	Front	Floating	300	Polished	Plain	5			XL 883 R Roadster (Cast wheel)	14-15
MD526XBLK	Front	Floating	300	Black	Plain	5			XL 883 N Iron (Cast wheel)	14-17
VR526	Front	Solid	300	N/A	Vee	N/A			XL 1200 C Custom (Spoke wheel)	14-20
VR526BLK	Front	Floating	300	Black	Vee	5			XL 1200 T Superlow	14-20
									XL 1200 V Seven Two	14-15
									XL 1200 X Forty Eight	14-17
									FXST Softail Standard	15
									FLS Softail Slim	15-17
									FLSL Softail Slim	18
									FLSTC Heritage Softail Classic	15-17
									FLHC Heritage Classic	18
									FLHCS Heritage Classic 114	18
									FLHCS Heritage Classic 114 Anniv.	18
									FLSTN Softail Deluxe	15
									FLDE Deluxe	18-20
									FXBB Street Bob	18-20
									FXLR Low Rider	18-20
MD527									USE MD530	
Disc Group 016									HARLEY DAVIDSON®	
MD528	Rear	Floating	290	Polished	Plain	10			FXSB Breakout	13-17
MD528C	Rear	Floating	290	Polished	Contour	10			FLFB Fat Boy	18
VR528	Rear	Solid	290	N/A	Vee	N/A			FLFBS Fat Boy 114	18
VR528BLK	Rear	Floating	290	Black	Vee	10			FLFBS Fat Boy 114 Anniv	18
									FXBR Breakout	18-20
									FXBRS Breakout 114	18-20
									FXBRS Breakout 114 Anniv.	18-20
									FXFB Fat Bob	18-20
									FXBS Fat Bob	18-20
									FLDE Deluxe	18-20
									FXBB Street Bob	18-20
									FXLR Low Rider	18-20
Disc Group 017									HARLEY DAVIDSON®	
MD529	Front	Solid	300	N/A	Plain	N/A			FLHRC Road King Classic	14-17
VR529	Front	Solid	300	N/A	Vee	N/A			FLHTCU Ultra Classic Electra Glide	14-20
OSMD529-14	Front	Solid	355	N/A	Plain	N/A	BRK705	BRK706	FLHTCUL Ultra Classic Electra Glide LOW	15
OSVR529-14	Front	Solid	355	N/A	Vee	N/A	BRK705	BRK706	FLHTK Ultra LTD	15-20
									FLHTKL Ultra LTD LOW	15-20
									FLHX Street Glide	14-20
									FLHXS Street Glide Special	15-20
									FLTRX Road Glide	15-20
									FLTRXS Road Glide Special	15-17
									FLHR Road King (Cast Wheel Type)	15-20
									FLTRX Road Glide Custom	15-17
									FLTRU Road Glide Ultra	16-20
Disc Group 018									HARLEY DAVIDSON®	
MD530	Front	Floating	300	Polished	Plain	5			FLHTCUTG Trike Tri Glide Ultra	14-20
MD530BLK	Front	Floating	300	Black	Plain	5			FLRT Freewheel Trike	15-20
VR530	Front	Solid	300	N/A	Vee	N/A			FLSTF Fatboy	15-17
VR530BLK	Front	Floating	300	Black	Vee	5			FLSTFB Fatboy LO	15-17
									FLFB Fat Boy	18
									FLFBS Fat Boy 114	18
									FLFBS Fat Boy 114 Anniv	18
									FXSB Breakout	15-17
									FXBR Breakout	18-20
									FXBRS Breakout 114	18-20
									FXBRS Breakout 114 Anniv.	18-20
									FXFB Fat Bob	18-20
									FXBS Fat Bob	18-20
MD531	Front	Solid	292	N/A	Plain	N/A			HARLEY DAVIDSON®	
									XG 500 STREET	16-20
									XG 750 STREET	16-20
MD532	Rear	Solid	260	N/A	Plain	N/A			HARLEY DAVIDSON®	
									XG 500 STREET	16-20
									XG 750 STREET	16-20

STREETBIKE DISC BUYERS GUIDE

Disc No.	F/R	Type	Dia. (mm)	Hub Color	Profile	Bobbins	Left Bracket	Right Bracket	Model	Year
Disc Group 019 MD533	F/R	Solid	299	Black	Plain	N/A			POLARIS Slingshot Slingshot S Slingshot SL Slingshot SL SE	15-17 18 15-18 15-18
MD533BSDF	Front	Solid	299	Black	Plain	N/A			POLARIS Slingshot Slingshot S Slingshot SL Slingshot SL SE	15-17 18 15-18 15-18
MD533BSDR	Rear	Solid	299	Black	Plain	N/A			POLARIS Slingshot Slingshot S Slingshot SL Slingshot SL SE	15-17 18 15-18 15-18
Complete Brake Upgrade Kit MDK533STD Standard Pads & Discs									POLARIS Slingshot	15-17
MDK533BSD Yellowstuff Pads & BSD Discs									Slingshot S Slingshot SL Slingshot SL SE	18 15-18 15-18
Disc Group 020 MD534 MD534X MD534XBLK VR534BLK	F/R F/R F/R F/R	Solid Floating Floating Floating	298 298 298 298	N/A Gold Black Black	Plain Plain Plain Vee	N/A 5 5 10			INDIAN Scout (Cast Wheel/Toso Calipers) Scout Scout Bobber Scout Sixty (Cast Wheel/Toso Calipers) Scout Sixty VICTORY Octane 1200cc	15-16 17-20 18-20 16 17-20 17
Disc Group 021 MD535 MD535BLK VR535BLK	F/R F/R F/R	Floating Floating Floating	292 292 292	Polished Black Black	Plain Plain Vee	5 5 5			INDIAN Chief Blackhawk (Brembo Calipers) Chief Blackhawk Dark (Brembo Calipers) Chief Classic (Brembo Calipers) Chief Standard (Brembo Calipers) Chief Deluxe (Brembo Calipers) Chief Roadmaster (Brembo Calipers) Chief Vintage (Brembo Calipers) Bomber (Brembo Calipers) Dark Horse (Brembo Calipers)	11 11 11-13 09-11 09 09-11 09-13 10-11 10-13
Disc Group 022 MD536 MD536X MD536XBLK VR536	Front Front Front Front	Solid Floating Floating Solid	300 300 300 300	N/A Polished Black N/A	Plain Plain Plain Vee	N/A 5 5 N/A			HARLEY DAVIDSON® XG 500 Street (300mm Discs) XG 750 Street (300mm Discs)	16-20 16-20
Disc Group 023 MD537 MD537X MD537XBLK VR537	Rear Rear Rear Rear	Solid Floating Floating Solid	300 300 300 300	N/A Polished Black N/A	Plain Plain Plain Vee	N/A 5 5 N/A			HARLEY DAVIDSON® XG 500 Street (300mm Discs) XG 750 Street (300mm Discs)	16-20 16-20
MD538	Rear	Solid	270.5	N/A	Plain	N/A			HARLEY DAVIDSON® FLRT Freewheeler Trike FLHTCUTG Tri Glide Ultra Trike	15-20 14-20
MD540	Rear	Solid	233	N/A	Plain	N/A			HARLEY DAVIDSON® FLHTCUTG Tri Glide Ultra Classic Trike FLHXXX Street Glide Trike	09-13 10-11
MD541	Front	Solid	300	N/A	Plain	N/A			HARLEY DAVIDSON® FLHR Road King (Spoke Wheel Type) FLHRC Road King Classic FLTR Road Glide FLTRX Road Glide Custom FLTRU Road Glide Ultra FLHTC Electra Glide Classic FLHTCU Ultra Classic Electra Glide	08-16 08-20 08-09 10-12 11-12 08-12 08-13

STREETBIKE DISC BUYERS GUIDE

Disc No.	F/R	Type	Dia. (mm)	Hub Color	Profile	Bobbins	Left Bracket	Right Bracket	Model	Year
MD541 Contd.									HARLEY DAVIDSON® Contd. FLHT Electra Glide Standard FLHTK Electra Glide Ultra LTD FLHX Street Glide FLHTCUTG Tri Glide Ultra Classic Trike FLHXXX Street Glide Trike	08-10 10-13 08-13 09-13 10-11
MD601LS	Front	Floating	310	Silver	Plain	9			CBR 600 FM/FN/FP/FR	91-94
MD601RS Ⓢ Oversize floating conversion	Front	Floating	310	Silver	Plain	9			TRIUMPH Ⓢ Bonneville 800 Ⓢ Bonneville T100 Ⓢ Bonneville America Ⓢ Speedmaster (865cc) Ⓢ Thunderbird Sport Ⓢ Tiger 900 885cc Ⓢ Tiger 955cc Spoke wheel	01-05 02-05 02-05 05 98-00 97-99 99-04
MD602LS MD602RS (35.8mm offset)	F/R F/R	Floating Floating	260 260	Silver Silver	Plain Plain	9 9			BMW R 60/7 R 60 TIC R 75/6/75/7 R 80 R 80 RT R 80 TIC R 90 S R 90/6 R 100 R 100/7T R 100 S R 100 RS R 100 RT	76-80 78-82 73-79 77-84 82-84 78-85 73-76 73-76 76-77 77-87 76-80 76-84 78-84
MD603LS MD603RS	Front Front	Floating Floating	285 285	Silver Silver	Plain Plain	9 9			BMW K75/K75-2 (Non ABS) K75/75-S (ABS Model) K75 RT (ABS Model) K75 S (ABS Model) K100/2 (ABS 8 Valve Model) K100 LT (ABS 8 Valve Model) K100 RS (ABS Model 8 Valve) K 100 RT (ABS 8 Valve)	84-07/90 08/90-96 89-96 85-95 87-90 86-91 83-89 83-89
MD604LS MD604RS (31.5mm offset)	Front Front	Floating Floating	285 285	Silver Silver	Plain Plain	9 9			BMW K 75/75-S K 75/75-2 K 75 C K 75 RT K 75 S K 1000 K 100/2 K 100 LT K 100 RS K 100 RT	84-88 88-96 85-90 89-96 85-95 82-88 87-90 86-91 83-89 83-89
MD605LS MD605RS (23.3mm offset)	Front Front	Floating Floating	285 285	Silver Silver	Plain Plain	9 9			BMW R 65 R 65 RT R 65 LS R 80/R 80 RT R 80 Mystic R 80 R R 850 GS R 80 GS/PD/CH/ST R 100 GS/PD R 100 RS R 100 RT R 100 Mystic R 100 R	07/88-07/89 85-88 81-85 84-95 94-95 91-94 96 80-95 89-96 86-92 87-95 93-96 91-95
MD606LS MD606RS (47.8mm offset)	Front Front	Floating Floating	260 260	Silver Silver	Plain Plain	9 9			BMW R 45 All models R 65 GS R 65 T R 65 LS (Brembo Caliper) R 100/7T	78-85 87-92 80-85 81-85 80-84

STREETBIKE DISC BUYERS GUIDE

Disc No.	F/R	Type	Dia. (mm)	Hub Color	Profile	Bobbins	Left Bracket	Right Bracket	Model	Year
MD607LS MD607RS	Front Front	Floating Floating	305 305	Silver Silver	Plain Plain	12 12			BMW K100 RS K1 K 1100 LT K 1100 RS R 850 RT R 1100 R R 1100 RS R 1100 RT	89-92 88-93 89-99 92-96 96-01 93-01 92-01 94-01
MD608LS/RS									USE MD607LS/RS	
MD609LS MD609RS 6 bolt fixing 27.2mm Offset	F/R F/R	Floating Floating	280 280	Gold Gold	Plain Plain	9 9			DUCATI 900 Hailwood Replica 900 SD Darmah (6 bolt front disc fixing/ 4 bolt rear disc fixing) 900 SD Darmah (6 bolt front & rear disc fixing) 1000 R1 Hailwood Replica (6 bolt disc) LAVERDA 750 SF2 750 SFC 750 SF3 1000 3C 1000 3CL 1000 RGS 1000 RGA/RGS Exec 1200 1200 TS/Mirage	79 78 78 84 74 74 76-77 74-75 76-81 82 83 78-79 81
MD609ALS MD609ARS 6 bolt fixing 26mm off set	F/R F/R	Floating Floating	280 280	Gold Gold	Plain Plain	9 9			LAVERDA 1000 RGS Corsa	84
MD611	Rear	Floating	285	Silver	Plain	9			BMW K 75/75-S K 75 RT K 100 K 100/2 K 100 LT K 100 RS K 100 RT K 100 RS K1 K 1100 LT	90-96 89-96 82-88 87-90 86-91 83-89 83-88 89-92 88-93 89-93
MD612RS	Front	Floating	320	Silver	Plain				APRILIA AF 125	90-91
MD613 MD613C VR613	Rear Rear Rear	Solid Solid Solid	220 220 220	N/A N/A N/A	Plain Contour Vee	N/A N/A N/A			APRILIA Dorsoduro 900 (ABS) Shiver 900 (ABS) SL 1000 Falco RSV 1000 Mille (All models) RSV4 RF 1000 RSV4 RR 1000 RSV4 R RSV4 R APRC RSV4 R APRC ABS RSV4 Factory RSV4 Factory APRC RSV4 Factory APRC ABS Tuono 1000 (All models) Tuono R Factory 1000 RSV4 1100 Factory RSV4 1100 RR Tuono V4R Tuono V4R - APRC Tuono V4R - APRC ABS Tuono 1100 RR V4 LAVERDA SFC 1000	17-21 17-21 00-04 98-08 15-18 15-18 10 11-13 13-14 09-10 11-13 13-14 02-10 06-10 19-21 19-21 11-12 11-13 14 15-16 03-04

STREETBIKE DISC BUYERS GUIDE

Disc No.	F/R	Type	Dia. (mm)	Hub Color	Profile	Bobbins	Left Bracket	Right Bracket	Model	Year
MD614X	Front	Floating	320	Gold	Plain	6			BENELLI	
MD614XC	Front	Floating	320	Gold	Contour	6			TRE-K 1130	06-17
VR614BLK	Front	Floating	320	Black	Vee	6			TRE-K 899	07-16
VR614BLU	Front	Floating	320	Blue	Vee	6			2UE 750	08-09
VR614RED	Front	Floating	320	Red	Vee	6			TNT 899 S Tornado Naked Tre	07-11
VR614GLD	Front	Floating	320	Gold	Vee	6			TNT 899 Tornado Naked Tre	07-16
VR614ORG	Front	Floating	320	Orange	Vee	6			BRAMMO (Electric Bikes)	
									Empulse R	12-13
									CAGIVA	
									Mito 125 (SP525)	91-10
									N1 125	97
									Planet 125 (3 spoke wheels)	98-03
									Planet 125 (6 spoke wheels)	98-03
									Raptor 125	03-10
									Supercity 125	92-00
									Mito 500	07-08
									River 600	94-
									DUCATI	
									Monster Dark ie 400	05-06
									Monster 400	00-04
									600 Monster City/City Dark	99
									600 Monster	00-01
									620 IE Monster	02-04
									620 Monster Dark	03-04
									696 Monster	08-14
									696 + Monster (inc ABS)	09-12
									Monster 696 20th Anniversary Model	13
									748 Testa Bassa	01
									748 Biposto	99-02
									748 SP/Monoposto	99-02
									750 Supersport IE	00-02
									750 Sport	01-02
									750 Monster	00-01
									Monster ie750	02
									Monster 800	03-04
									Supersport 800	03-05
									900 Supersport IE	00-01
									900 IE Monster	00-01
									900 MH Evoluzione	00-01
									900 Sport	02
									ST2 (944cc)	00-03
									ST4 (916cc)	01-02
									GT 1000 (992cc)	07-10
									GT 1000 Touring (992cc)	09
									Monster 1000 Dark	03
									Monster 1000 ie (992cc)	04-05
									Monster 1000 S ie (992cc)	03-05
									Monster S2R 1000 (992cc)	06-08
									Paul Smart 1000 LE (992cc)	06
									Sport Classic 1000 (992cc)	06-08
									Sport 1000 S	07-08
									GENERIC	
									GRS 600	13
									KTM	
									690 Duke	08-12
									690 Duke R	10-11
									MOTO GUZZI	
									750 Brevia ie (3 spoke cast wheels)	03-07
									750 Nevada Classic ie (spoke wheels)	04-15
									750 Nevada	02-11
									750 V7 Classic	08-12
									750 V7 Cafe Classic	09-12
									750 V7 Racer	10-14
									750 V7 Special	12-14
									750 V7 Stone	12-14
									750 V7 III Special	17-21
									750 V7 III Stone	17-21
									750 V7 III Carbon	17-21
									750 V7 III Limited	17-21
									750 V7 III Racer	17-21
									750 V7 III Rough	17-21
									V 85 TT	18-21
									940 Bellagio	07-13
									V9 Bobber	16-21
									V9 Bobber Sport	16-21
									V9 Roamer	16-21

STREETBIKE DISC BUYERS GUIDE

Disc No.	F/R	Type	Dia. (mm)	Hub Color	Profile	Bobbins	Left Bracket	Right Bracket	Model	Year
MD614X MD614XC VR614BLK VR614BLU VR614RED VR614GLD VR614ORG Contd.	Front Front Front Front Front Front Front	Floating Floating Floating Floating Floating Floating Floating	320 320 320 320 320 320 320	Gold Gold Black Blue Red Gold Orange	Plain Contour Vee Vee Vee Vee Vee	6 6 6 6 6 6 6			MOTO GUZZI Contd. 1000 V10 Centauro GT 1000 V10 Centauro Sport 1100 California Aluminium 1100 California Titanium (with top fairing) 1100 California Aquila Nera 1100 California Classic Touring 1100 California EV (Up to KD115426/Single pin pad fixing) 1100 California EV (From KD115427/2 pin pad fixing) 1100 California EV Touring 1100 California Jackal 1100 California Special 1100 California Sport 1100 California Stone 1100 California Stone Metal 1100 California Vintage 1100 Sport Carbs 1100 Sport EFI 1100 Sport Corsa 1100 - V11 Ballabio 1100 - V11 Le Mans 1100 - V11 Sport 1100 - V11 Scura 1100 - V11 Naked 1200 Griso 8V (Standard/Cast Wheel/Radial Caliper) 1200 Griso 8v (Special Edition/Spoke Wheel/Radial Caliper) NORTON 961 Commando Sport 961 Commando Cafe Racer 961 Commando Dominator SS 961 Commando SE 961 Commando 961 SF VOXAN Black Magic Street Scrambler VB1-Evo Cafe Racer 1000 Roadster 1000	97-99 97-99 02-05 04-05 09-11 06-08 97-00 97-02 03-05 94-01 99-00 01-02 01-05 02-03 06-12 94-96 96-99 98-99 03-05 01-05 99-01 01-03 02-03 07-12 07-15 10-15 10-20 15-20 10-11 13-15 04-08 03-06 03-04 02-08 02-08
MD615 Billet SILVER	Rear	Floating	285	Natural	Plain	9			BMW K 1200 LT K 1200 LT (Evo integral ABS/disc has fixed bobbins) R 1200 CL	97-09 08-09 02-04
MD616 Loose bobbins	Front	Solid	320	N/A	Plain	N/A			BMW R 850 R R 1100 S R 1150 R R 1150 RS R 1150 R Rockster K 1200 LT R 850 R R 1100 S R 1150 R R 1150 RS R 1150 R Rockster K 1200 LT K 1200 R (K27/0378) Tokico Caliper Disc with loose buttons K 1200 R	04-06 00-06 01-06 01-04 03-06 00-07 04-06 00-06 01-06 01-04 03-06 00-07 11/05-11/07 05-08
MD617	Rear	Solid	220	N/A	Plain	N/A			CAGIVA 650 Raptor 1000 Raptor/V-Raptor 1000 Raptor/V-Raptor	01-07 00-06 00-05
MD618 MD618C VR618	Rear Rear Rear	Solid Solid Solid	240 240 240	N/A N/A N/A	Plain Contour Vee	N/A N/A N/A			DUCATI 749 Dark 749 R 749 S 749 Monoposto/Biposto Desmosedici RR (D16RR/989cc) 999 S 999 999 R 999 R Fila	04-06 04-06 03-06 03-06 08 03-04 03-06 03-06 03

STREETBIKE DISC BUYERS GUIDE

Disc No.	F/R	Type	Dia. (mm)	Hub Color	Profile	Bobbins	Left Bracket	Right Bracket	Model	Year
MD618 MD618C VR618 Contd.	Rear Rear Rear	Solid Solid Solid	240 240 240	N/A N/A N/A	Plain Contour Vee	N/A N/A N/A			DUCATI Contd. 999 R Xerox	06
MD619RS SILVER	Front	Floating	315	Natural	Plain	9			MZ/MUZ Skorpion Tour/Traveller Skorpion Sport/Cup SACHS (HERCULES) XTX 125 Supersport XTX 125 N	95-02 95-01 00-07 00-07
MD620 Loose bobbins	Front	Solid	320	N/A	Plain	N/A			BMW R 850 RT K 1200 RS K 1200 S (K40) R 1150 RT K 1200 GT (K41)	06 01-04 05-08 00-06 03-06
MD621X MD621XC VR621BLK VR621BLU VR621RED VR621GLD	Front Front Front Front Front Front	Floating Floating Floating Floating Floating Floating	320 320 320 320 320 320	Gold Gold Black Blue Red Gold	Plain Contour Vee Vee Vee Vee	6 6 6 6 6 6			APRILIA RS 125 (Radial Caliper) 2T Pegaso Strada 650 Pegaso 650 Pegaso 650 Factory Shiver 750 Shiver 750 (RAE00/STD & RAG 00/ ABS) Shiver 750 GT Shiver 750 GT ABS Mana 850 Mana 850 ABS Mana 850 GT ABS Model RSV 1000 Mille RSV 1000 R Mille Tuono R Factory 1000 Tuono R 1000 BENELLI 2 UE 756 Tornado Tre Novecento LE/RS Cafe Racer 899 Century 1130 Racer Tornado TRE 1130 TNT 1130 Cafe Racer TNT 1130 Titanium TNT 1130 Sport/Sport Evo Tornado Naked TRE Tornado Tre 1130 BIMOTA SB8K Santamonica BMW G 650 X Moto MONDIAL Piega 1000 Evo LAVERDA SFC 1000 MOTO GUZZI 850 Griso 940 Bellagio 1000 MGS-01 Corsa 1100 Griso 1100 California 1000 190	06-14 05-06 07-08 06-08 07-10 10-14 09-10 10-12 08-11 08-13 09-14 01-08 01-08 06-10 02-10 09-10 03-05 10-12 11-12 06 06-12 06 04-09 06-07 06-10 07-09 03-04 04 03-04 06-07 07-12 04-07 05-08 12
MD622X MD622XC VR622BLK VR622BLU VR622RED VR622GLD	Front Front Front Front Front Front	Floating Floating Floating Floating Floating Floating	320 320 320 320 320 320	Gold Gold Black Blue Red Gold	Plain Contour Vee Vee Vee Vee	6 6 6 6 6 6			DUCATI 749 Dark 749 R 749 S 999 S 999 999 R 999 R Flla 999 R Xerox 1100 S Monster	04-06 04-06 03-06 03-06 03-06 03-06 03 06 09-10
MD623RS	Front	Solid	280	N/A	Plain	N/A			MZ/MUZ Saxon 125 Saxon 150 251 Fun	93-97 95 95-96

STREETBIKE DISC BUYERS GUIDE

Disc No.	F/R	Type	Dia. (mm)	Hub Color	Profile	Bobbins	Left Bracket	Right Bracket	Model	Year
MD623RS Contd.	Front	Solid	280	N/A	Plain	N/A			MZ/MUZ Contd. Saxon "Tour" 251/301 Saxon 500 All models	93-98 93-98
MD624 VR624BLK VR624BLU VR624RED VR624GLD	Front Front Front Front Front	Floating Floating Floating Floating Floating	320 320 320 320 320	Gold Black Blue Red Gold	Plain Vee Vee Vee Vee	6 6 6 6 6			DUCATI 748 R 996 S Monster S4R (994cc) Monster S4 Foggy (916cc) Monster S4 (916cc) ST3S (ABS Model) ST4S (ABS) ST4S (Non ABS) 996 SPS 996 Monoposto/Biposto MOTO GUZZI 1100 Brevia (ABS models) Brevia 1200 Norge 1200 (ABS) All models 1200 Sport (ABS) Stelvio 1200/ABS 1200 Stelvio NTX ABS	00-02 01 03-06 02 01-02 06-07 03-05 01-05 99 99-01 05-07 08-09 06-09 06-07 08-10 09-10
MD625LS	Front	Solid	290	N/A	Plain	N/A			APRILIA Europa 50 AF1 Futura 50	90-92 90-92
MD626X MD626XC VR626BLK VR626BLU VR626RED VR626GLD GOLD	Front Front Front Front Front Front	Floating Floating Floating Floating Floating Floating	300 300 300 300 300 300	Gold Gold Black Blue Red Gold	Plain Contour Vee Vee Vee Vee	6 6 6 6 6 6			DUCATI Monster S2R (803cc) Monster S2R Dark (803cc) Monster 400 ie Monster 620 Monster Dark 620 620 Multistrada 695 Monster ROYAL ENFIELD 535cc Continental GT (Non ABS) 535cc Continental GT (ABS)	05-07 05-06 07-08 05-06 05-06 06 07-08 13-16 17-18
MD627 MD627C VR627	Rear Rear Rear	Solid Solid Solid	245 245 245	N/A N/A N/A	Plain Contour Vee	N/A N/A N/A			DUCATI 796 Hypermotard 796 Monster (Non ABS Models) Monster 796 20th Anniversary Model (Non ABS Models) Monster S2R Dark (803cc) Hypermotard (821cc) Hypermotard SP (821cc) Hyperstrada (821cc) 848 (Radial 2 pad Caliper) 848 Evo (Monobloc front Calipers) 848 Evo Corse SE 848 Evo Dark 848 Streetfighter 939 Hypermotard 939 Hyperstrada 939 Hypermotard SP S4RS Monster (998cc) S4R Monster Testastretta (998cc) S4RS Monster Testastretta (998cc) S4RS Tricolore/Monster Testastretta Monster S4R (994cc) Monster S2R 1000 (992cc) Multistrada 1000 DS Multistrada S DS 1000 1100 Evo Hypermotard 1100 Evo SP Hypermotard Hypermotard 1100 Hypermotard 1100 S Multistrada 1100 (1078c) Multistrada 1100 S (1078cc) 1100 Monster (Non ABS Models) 1100 Monster Evo 1100 S Monster (Non ABS Models) Monster Diesel 1100 939 Hypermotard 939 Hyperstrada 939 Hypermotard S	10-13 10-13 13 05-06 13-15 13-15 13-15 08-10 10-13 12-13 12 11-15 16 16 16 06 07-08 07 08 03-06 06-08 03-06 05-06 10-12 10-12 07-09 07-09 07-09 07-09 09-10 11-13 09-10 13 16 16 16

STREETBIKE DISC BUYERS GUIDE

Disc No.	F/R	Type	Dia. (mm)	Hub Color	Profile	Bobbins	Left Bracket	Right Bracket	Model	Year
MD628RS	Front	Solid	260	N/A	Plain	N/A			APRILIA Classic 125 Red Rose 125 (Spoke wheel)	95-01 88-94
MD629X MD629XC MD629XBLK VR629BLK VR629BLU VR629RED VR629GLD	Front Front Front Front Front Front Front	Floating Floating Floating Floating Floating Floating Floating	320 320 320 320 320 320 320	Silver Silver Black Black Blue Red Gold	Plain Contour Plain Vee Vee Vee Vee	6 6 6 6 6 6 6			TRIUMPH Thrupton 900 Thrupton Ace 900	04-16 15-16
MD630LS MD630RS	Front Front	Solid Solid	280 280	N/A N/A	Plain Plain	N/A N/A			DUCATI 750 Paso 750 Sport	87-90 88
MD631	Rear	Solid	270	N/A	Plain	N/A			DUCATI 750 Paso 750 Sport 906 Paso	87-90 88 88-89
MD632 MD632C VR632	Rear Rear Rear	Solid Solid Solid	220 220 220	N.A N.A N.A	Plain Contour Vee	N/A N/A N/A			DUCATI 748 Biposto 748 SP 748 S Biposto 748 S Monoposto 748 SPS 748 Testa Bassa 748 R 900 MH Evoluzione 916 SPS (996cc) 916 Biposto 916 Senna 916 SP 996 SPS (996cc) 996 (996cc) 996 R/S 998 R 998 Matrix 998 S Bayliss/Bostrom 998 S (998cc) 998 (998cc) Monoposto/Biposto	95-98 95-98 00-02 00-02 98-99 01 00-02 00-01 97-98 94-98 94-98 94-96 99 99-01 01 02 04 02 02-04 02-03
MD633X MD633XC VR633ORG With Counterbore	Front Front Front	Floating Floating Floating	320 320 320	Gold Gold Orange	Plain Contour Vee	6 6 6			DUCATI 400 Monster 600 Monster 600 Monster Dark 748 Biposto 748 SP 748 SPS 750 Supersport 750 Monster 750 Monster City/City Dark 750 Monster/Monster Dark Supersport 750 851 Superbike Biposto 888 Superbike Strada 900 Supersport/Superlight 900 Supersport 900 Supersport CR USA 900 Supersport FE 907 IE 916 Biposto 916 SP ST2 (944cc) ST4 (916cc) STS3 ABS 998 Matrix 998 S Bayliss/Bostrom 998 S (998cc) 998 (998cc) Monoposto/Biposto 900 Monster 900 Monster Cromo/Special 900 Monster City/City Dark KTM Duke 11 640 (2 Pin pad fixing/Disc with offset)	95-97 93-99 98-99 95-98 98 98-99 91-99 96-98 99 99 91-98 89-92 94-95 91-97 98-99 98 98 92-93 94-98 94-96 97-99 99-00 06-07 04 02 02-04 02-03 93-99 98 99 03-07

DISC BUYERS GUIDE

STREETBIKE DISC BUYERS GUIDE

Disc No.	F/R	Type	Dia. (mm)	Hub Color	Profile	Bobbins	Left Bracket	Right Bracket	Model	Year
MD633X MD633XC VR6330RG With Counterbore Contd.	Front Front Front	Floating Floating Floating	320 320 320	Gold Gold Orange	Plain Contour Vee	6 6 6			KTM Contd. 990 Adventure R 990 Adventure (ABS) 990 Superduke 990 Superduke R RC8/Track (1190cc) RC8 R (1190cc) MOTO GUZZI V 1100 Brevia MOTO MORINI 9 1/2 (1200cc) Corsaro 1200 Corsaro 1200 Veloce Corsaro Avio 1200 Sport	09-10 07-10 05-11 07-13 08-15 09-12 04-05 06-10 05-10 07-09 08-09 08-10
MD634LS MD634RS 4 bolt fixing 32.4mm offset	F & R F & R	Floating Floating	280 280	Gold Gold	Plain Plain	9 9			DUCATI 250/350/450 Desmo 750 Sport 750 SS (4 bolt disc fixing) 860 GT/GTS 900 GTS 900 SS Desmo (4 bolt fixing front disc) 900 SD Darmah (4 bolt front and rear disc fixing) 900 SD Darmah (6 bolt front disc fixing 4 bolt rear disc fixing)	74-77 74 75-76 75-76 75-76 76 77 78
MD635RS	Front	Floating	320	Silver	Plain	9			APRILIA AF1 125	87-89
MD636X MD636XC	Front Front	Floating Floating	320 320	Gold Gold	Plain Contour	6 6			DUCATI 996 R MOTO MORINI 9 1/2 (998cc) MM3 (1187cc) Corsaro 1200 Corsaro 1200 Veloce Corsaro Avio 1200 Sport	01 06-10 07 05-10 07-09 08-09 08-10
MD637	Rear	Solid	240	N/A	Plain	N/A			MZ Skorpion Tour/Traveller Skorpion Sport/Cup Skorpion Replica	95-02 95-01 95-01
MD638 (6 bolt fixing)	Rear	Solid	230	N/A	Plain	N/A			Raptor 125 Super City 125 Mito 125 (SP525) Planet 125 (3 spoke wheels/6 Bolt Disc) Planet 125 (6 spoke wheel/6 Bolt Disc 2nd series) Mito 500	03-10 92-00 91-10 98-03 98-03 07-08
MD639LS	Front	Solid	290	N/A	Plain	N/A			RS 50 (6 bolt fixing)	93-98
MD640 VR640BLK VR640BLU VR640RED VR640GLD	Front Front Front Front Front	Floating Floating Floating Floating Floating	310 310 310 310 310	Silver Black Blue Red Gold	Plain Vee Vee Vee Vee	6 6 6 6 6			TRIUMPH Daytona 750 Daytona 900 Daytona Super 3 Speed Triple 750/900 (Carb model) Sprint 900 Trophy 900 Daytona 1000 Trophy 1200 Daytona 1200	92 93-96 94-97 94-96 94-98 94-01 92 94-01 93-98
MD641 VR641	Rear Rear	Solid Solid	255 255	N/A N/A	Plain Vee	N/A N/A			TRIUMPH Daytona 750 Trident 750 Tiger 885cc Daytona 900 Daytona Super 3 Speed Triple 750/900 (Carb model) Sprint 900 Trident 900 Trophy 900 Daytona 1000 Trophy 1200	92 92-98 92-96 93-96 94-97 94-96 93-98 92-98 92-01 92 92-02

STREETBIKE DISC BUYERS GUIDE

Disc No.	F/R	Type	Dia. (mm)	Hub Color	Profile	Bobbins	Left Bracket	Right Bracket	Model	Year
MD641 VR641 Contd.	Rear Rear	Solid Solid	255 255	N/A N/A	Plain Vee	N/A N/A			TRIUMPH Contd. Daytona 1200	93-98
MD642LS Note: Floating conversion available see MD629X	Front	Solid	320	N/A	Plain	N/A			TRIUMPH Adventurer Thunderbird Legend TT	96-01 95-02 98-01
MD643 VR643	Rear Rear	Solid Solid	285 285	N/A N/A	Plain Vee	N/A N/A			TRIUMPH America (6 Spoke Cast wheel) America (12 Spoke Cast wheel 865cc) America LT (12 Spoke Cast wheel 865cc) Bonneville America Adventurer Thunderbird Thunderbird Sport Legend TT Speedmaster (790cc/Carb) Speedmaster (865cc/EFi) Tiger 885i (From VIN 71699) Tiger 900 885cc Tiger 955cc (Spoke wheel)	07-09 10-17 14-17 02-06 96-01 95-02 98-00 98-01 03-04 05-16 98-99 97-99 99-04
MD644	Front	Solid	276	N/A	Plain	N/A			AJS Regal Raptor CR3-125 TRIUMPH Tiger 900 885cc HONDA CBR 125 R4/R5/RS5/RWS/RW6/RW7/RW8/RW9/RWA CBR 150 R CB 400 SS (SS2-NC41)	06 92-97 04-10 00-03 01-05
MD645	Rear	Solid	255	N/A	Plain	N/A			TRIUMPH Tiger 900 885cc	92-97
MD646LS MD646RS VR646BLK VR646BLU VR646RED VR646GLD	Front Front Front Front Front Front	Floating Floating Floating Floating Floating Floating	296 296 296 296 296 296	Silver Silver Black Blue Red Gold	Plain Plain Vee Vee Vee Vee	6 6 6 6 6 6			TRIUMPH Trident 750 Sprint 900 Trident 900 Trophy 900 Trophy 1200	92-98 93 92-98 92-93 92-93
MD647X MD647XC VR647BLK VR647BLU VR647RED VR647GLD	Front Front Front Front Front Front	Floating Floating Floating Floating Floating Floating	320 320 320 320 320 320	Gold Gold Black Blue Red Gold	Plain Contour Vee Vee Vee Vee	6 6 6 6 6 6			TRIUMPH Sprint ST T509 Speed Triple (EFi 885cc) T595 Daytona/955i Sprint RS Speed Triple (EFi 955cc) 6 bolt fitting	99-04 97-98 97-00 99-04 99-04
MD648 MD648C VR648	Rear Rear Rear	Solid Solid Solid	220 220 220	N/A N/A N/A	Plain Contour Vee	N/A N/A N/A			TRIUMPH Daytona 600 TT 600 Speed Four 600 Daytona 650 Daytona 675 Daytona 675 R (Brembo Calipers) Street Triple 675 (Naked) Street Triple R 675 T509 Speed Triple (EFi 885cc) Speed Triple (EFi 955cc) T595 Daytona/955i Daytona 955i Speed Triple 1050 (Non ABS)- To VIN 461331 Speed Triple 1050 (ABS)- To VIN 461331	03-04 00-03 02-05 05 06-12 11-12 07-12 09-12 97-98 98-04 97-00 01-06 05-11 07-11
MD649 MD649CX Note: Floating conversion available see MD601LS/RS	Front Front	Solid Solid	310 310	N/A N/A	Plain Contour	N/A N/A			TRIUMPH America (Cast wheels) Bonneville 800 Bonneville T100 Bonneville America Bonneville/Bonneville Black Scrambler (865cc) Speedmaster (790cc) (Carb) Speedmaster (865cc) Thunderbird Sport Tiger 885i (From VIN 71699) Tiger 900 885cc	07-09 01-06 02-09 02-06 07-08 06-09 03-04 05-07 98-00 98-99 97-99

STREETBIKE DISC BUYERS GUIDE

Disc No.	F/R	Type	Dia. (mm)	Hub Color	Profile	Bobbins	Left Bracket	Right Bracket	Model	Year
MD649 / MD649CX Contd.									TRIUMPH Contd. Tiger 955cc Spoke wheel	99-04
MD650	Front	Solid	300	N/A	Plain	N/A			BMW F 650 (E169/0161)/Standard F 650 (E169/0162) (Funduro/HighScreen) (19" front wheel) F 650 ST (E169/0163/168) Strada (18" front wheel/low screen)	09/93-96 97-00 97-00
MD651	Rear	Solid	240	N/A	Plain	N/A			BMW F 650 (E169/0161)/Standard F 650 (E169/0162) (Funduro/HighScreen) (19" front wheel) F 650 CS Scarver (K14/0174/0184 Belt Drive) F 650 CS Scarver (K17/0177/0187 Belt Drive) F 650 GS (R13/0172/0182) (19" front wheel) F 650 GS Dakar (R13/0173/0183) (21" front wheel) F 650 ST (E169/0163/168) Strada (18" front wheel/low screen) F 650 GS Dakar (R13/0173/0183) (21" front wheel) F 650 GS Dakar (R13/0176/0186) F 650 GS (R13/0175/0185) G 650 GS (R131) G 650 GS Sertao BENELLI TNT 899 Tornado Naked Tre TNT 899 S Tornado Naked Tre TRE-K 899 TRE-K 1130 TNT 1130 Cafe Racer TNT 1130 Sport/Sport Evo TNT 1130 Titanium Tornado TRE 1130 (Radial Caliper) Tornado Naked Tre TNT 1130 HUSQVARNA TR 650 Terra (Spoke Wheel) TR 650 Strada (Cast Wheel) ROYAL ENFIELD 535cc Continental GT (Non ABS) Himalayan	09/93-96 97-00 00-03 04-07 99-03 99-03 97-00 99-03 04-07 04-07 09-15 12-14 07-16 07-11 07-16 06-17 05-12 04-09 05-06 06-10 06-07 12-13 12-13 13-16 16-18
MD652 MD652C	Front Front	Solid Solid	305 305	N/A N/A	Plain Contour	N/A N/A			BMW K 1200 RS K 1200 LT R 850 C R 850 GS R 850 R R 850 RT R 1100 GS R 1100 R R 1100 S (ABS) R 1100 RT R 1150 GS (Evo - R21/0415/0495) R 1150 GS (R21/0415/0495) R 1150 GS Adventure R 1200 R 1200 C R 1200 CL	96-00 97-00 97-00 96-00 94-96 96-01 93-99 93-96 96-00 94-01 11-01-03 98-10/01 07/01-06 00-02 96-04 02-04
MD653 MD653C	Rear Rear	Solid Solid	276 276	N/A N/A	Plain Contour	N/A N/A			BMW R 850 GS R 850 R R 850 RT R 850 RT R 1100 GS R 1100 R R 1100 S R 1100 RT R 1150 GS (Evo - R21/0415/0495) R 1150 GS (R21/0415/0495) R 1150 GS Adventure R 1150 R R 1150 RS R 1150 RT R 1150 R Rockster	96-00 94-02/06 96-01 06 93-99 93-01 96-06 94-01 11-01-03 98-10/01 07/01-06 01-06 01-06 00-06 03-06

STREETBIKE DISC BUYERS GUIDE

Disc No.	F/R	Type	Dia. (mm)	Hub Color	Profile	Bobbins	Left Bracket	Right Bracket	Model	Year
MD656 VMD656 4 bolt fixing	F & R F & R	Floating Floating	250 250	Gold Black	Plain Plain	9 9			TRIUMPH T 140 V Bonneville Drum Rear Brake/5 Speed Gearbox T 140 V Bonneville Disc All Round/5 Speed Gearbox T 140 Silver Jubilee Bonneville T 140 E Bonneville T 140 D Bonneville (Lester Alloy wheels) T 140 ES (750cc) (Electric Start) TSS 750 (8 valve) TSX 750	73-74 75-78 77 78-83 79-81 80-81 83 83
MD657LS MD657RS	Front Front	Floating Floating	260 260	Gold Gold	Plain Plain	9 9			CAGIVA 500 Pantah DUCATI 500 Pantah 600 Pantah DUCATI 500 Pantah	79 79 81 79
MD658 Billet	Rear	Solid	240	N/A	Plain	N/A			APRILIA AF1 125	87-91
MD659 (6 bolt fixing)	Rear	Solid	220	N/A	Plain	N/A			APRILIA RS 125 CAGIVA W8 125 SACHS Roadster 650 Roadster 650	92-95 93-98 01-04 05
MD660LS MD660RS	Front Front	Floating Floating	298 298	Silver Silver	Plain Plain	9 9			APRILIA RS 250 All models CAGIVA 650 Raptor 1000 Raptor	95-02 00-07 00-05
MD661	Rear	Floating	285	Silver	Plain	9			BMW K 75 S ABS K 75 RT (ABS) R 1100 RS K 100/2 (ABS 8 valve model) K 100 LT (ABS 8 valve model) K 100 RS (ABS 8 valve model) K 100 RT (non-ABS 8 valve) K 100 RT (ABS 8 valve) K 100 RS (16 valve ABS) K1 (16 valve ABS model) KL 1100 LT (ABS) KL 1100 LT (Non ABS) KL 1100 (ABS Model) K 1100 RS (All models) K 1200 RS (All models) K 1200 GT	85-95 89-96 92-01 87-90 86-91 83-89 10/88-89 83-89 89-92 88-93 89-07/93 08/93-99 08/93-99 92-96 96-04 03-06
MD662X MD662XC VR662BLK VR662BLU VR662RED VR662GLD GOLD	Front Front Front Front Front Front	Floating Floating Floating Floating Floating Floating	310 310 310 310 310 310	Gold Gold Black Blue Red Gold	Plain Contour Vee Vee Vee Vee	6 6 6 6 6 6			TRIUMPH Daytona 600 TT 600 Speed Four 600 Daytona 650	03-04 00-03 02-05 05
MD663 MD663C VR663	Rear Rear Rear	Solid Solid Solid	255 255 255	N/A N/A N/A	Plain Contour Vee	N/A N/A N/A			TRIUMPH Daytona 650 Bonneville 800 Bonneville 865cc (Cast wheels) Bonneville Newchurch (865cc/Cast wheels) Bonneville SE 865cc (Cast wheels) Bonneville Spirit (Spoke wheels/865cc) Bonneville T214 (Spoke wheels/865cc) Bonneville T100 (790cc) Bonneville T100 (865cc) Bonneville T100 (865cc/Spoke wheel) Bonneville T100 Black (865cc/Spoke wheel) Bonneville/Bonneville Black	05 01-06 09-15 15 09-13 15 15 02-04 05-09 10-16 14-16 07-08

DISC BUYERS GUIDE

STREETBIKE DISC BUYERS GUIDE

Disc No.	F/R	Type	Dia. (mm)	Hub Color	Profile	Bobbins	Left Bracket	Right Bracket	Model	Year
MD663 MD663C VR663 Contd.									TRIUMPH Contd. Bonneville Steve McQueen SE Scrambler (865cc) Sprint RS Tiger 800 Tiger 800 XC Thrupton 900 Thrupton Ace 900 Speed Triple 1050 (4 Pad Caliper/Non ABS) - From VIN 461332 Speed Triple R 1050 (2 Pad Caliper/Non ABS/5 Spoke wheels) Speed Triple R 1050 (2 Pad Caliper/Non ABS/10 Spoke wheels) Sprint 1050 ST Tiger 1050 (Radial F/cal)	12 06-15 99-04 11-14 11-14 04-16 15-16 11-16 12-13 14-15 05-10 07-12
MD664 MD664C (6 bolt fixing)	Rear Rear	Solid Solid	220 220	N/A N/A	Plain Contour	N/A N/A			APRILIA RS 50 Tuono 50 RS 125 (2T) Tuono 125	99-06 03-04 96-14 03-04
MD665	Rear	Solid	220	N/A	Plain	N/A			APRILIA RS 250	95-02
MD666X MD666XC GOLD	Front Front	Floating Floating	320 320	Gold Gold	Plain Contour	6 6			APRILIA RSV 1000 Mille RSV 1000 Mille R SL 1000 'Falco' CAGIVA Raptor X3 1000	98-00 00 00-04 03-04
MD667 SILVER	Front	Floating	300	Silver	Plain	9			MOTO GUZZI 1000 Daytona	92-95
MD668LS MD668RS	Front Front	Floating Floating	299 299	Gold Gold	Plain Plain	9 9			LAVERDA 1000 SFC	85-86
MD669X MD669XC VR669BLK VR669BLU VR669RED VR669GLD	Front Front Front Front Front Front	Floating Floating Floating Floating Floating Floating	320 320 320 320 320 320	Gold Gold Black Blue Red Gold	Plain Contour Vee Vee Vee Vee	6 6 6 6 6 6			TRIUMPH Speed Triple Daytona 955i Sprint 1050 ST Rocket III 2300 Rocket III Classic Rocket III Roadster - ABS Rocket X	02-04 01-04 05-10 04-09 07-09 10-18 15-16
MD670	F & R	Solid	280	N/A	Plain	N/A			LAVERDA Bolt On - Ring Only	
MD671	Rear	Solid	265	N/A	Plain	N/A			BMW C 400 X C 400 GT F 650 GS (K72/0218/0228) (798cc twin cylinder/cast wheels) F 650 GS (30 Years GS) F 700 GS F 750 GS F 750 GS Edition 40 F 800 GS F 800 GS Adventure F 800 GS (30 Years GS) F 800 GS Triple Black F 800 GS Trophy F 800 GT F 800 R (Disc has fixed bobbins) F 800 R Chris Pfeiffer Edition F 800 ST (Full fairing) F 800 ST Touring F 800 S (Half fairing) F 850 GS F 850 GS Edition 40 F 850 GS Adventure F 850 GS Adventure Edition 40 S 1000 XR HP 2 Enduro	18-20 18-20 07-12 11 13-18 16-20 20-21 08-18 12-18 11 12 12 13-18 09-18 09-11 06-18 10-17 06-17 16-18 20-21 16-18 20-21 19-21 05-08

STREETBIKE DISC BUYERS GUIDE

Disc No.	F/R	Type	Dia. (mm)	Hub Color	Profile	Bobbins	Left Bracket	Right Bracket	Model	Year									
MD671 Contd.	Rear	Solid	265	N/A	Plain	N/A			BMW Contd.										
									HP2 Megamoto (K25) (Disc has fixed bobbins)	07-10									
									HP2 Sport (K29) (Disc has fixed bobbins)	08-11									
									R Nine T (K21 1170cc)	14-18									
									R Nine T/5 (K21 1170cc)	20-21									
									R Nine T Pure (K22/1170cc)	16-21									
									R Nine T Scrambler (K21/1170cc)	16-21									
									R Nine T Café Racer (K32/1170cc)	16-18									
									R Nine T Urban GS (K33/1170cc)	17-21									
									K 1200 S (K40)	05-08									
									K 1200 R Sport	07-08									
									K 1200 R (K27/0378) Tokico Caliper Disc with fixed buttons	12/07-10									
									K 1200 R (K27/0378) Tokico Caliper Disc with loose buttons	11/05-11/07									
									R 1200 GS (K25/0307/Cast/Spoke wheel) Disc with loose bobbins	02-11/07									
									R 1200 GS/M (K25/0303/Cast/Spoke wheel) Disc has fixed bobbins	06-09									
									R 1200 GS Adventure (K25/0382/Spoke wheel) Disc has loose bobbins	05-11/07									
									R 1200 GS Adventure/M (K25/0380/Spoke wheel) Disc has fixed bobbins	06-09									
									R 1200 GS Adventure (Spoke wheels) (Disc has fixed bobbins)	10-12									
									R 1200 GS (Cast wheels) (Disc has fixed bobbins)	10-12									
									R 1200 GS Adventure (30 Years GS) (Disc has fixed bobbins)	11									
									R 1200 GS Triple Black	11-13									
									R 1200 GS (30 Years GS)	11									
									R 1200 GS Rallye (Spoke wheels)	12									
									R 1200 GS Adventure Triple Black	12									
									R 1200 RSE (Disc has fixed bobbins)	10-11									
									R 1200 RT K26/0368 Brembo Caliper Disc has loose bobbins	05-11/07									
									R 1200 RT (Disc has fixed bobbins)	10-13									
									R 1200 RT-SE (Disc has fixed bobbins)	10-13									
									R 1200 R Classic	11-14									
									R 1200 R	12/07-14									
									R 1200 ST K28/0328 Disc has loose bobbins	03-11/07									
									R 1200 S K29/0366 - Brembo Caliper Disc with loose bobbins	06-11/07									
									R 1200 S K29/0366 - Brembo Caliper Disc with fixed bobbins	12/07-08									
									R 1200 RT K26/0368 Brembo Caliper Disc has fixed bobbins	12/07-09									
									R 1200 ST K28/0328 (Disc has fixed bobbins)	12/07-08									
									R1250 GS (Disc has fixed bobbins)	19-21									
									R 1250 GS TE (Disc has fixed bobbins)	19-21									
									R 1250 GS Exclusive TE (Disc has fixed bobbins)	19-21									
									R 1250 GS Rallye (Disc has fixed bobbins)	19-21									
									R 1250 GS Rallye TE (Disc has fixed bobbins)	19-21									
									R 1250 RT (Disc has fixed bobbins)	19-21									
									R 1250 RT SE (Disc has fixed bobbins)	19-21									
									R 1250 RT LE (Disc has fixed bobbins)	19-21									
									K 1300 R	09-12									
									K 1300 R Dynamic	11-15									
									K 1300 R Carbon	12									
									K 1300 S (Non & ABS Models)	09-15									
									K 1300 S Sport	12-15									
									K 1300 S HP	12									
									HUSQVARNA										
									Nuda 900 (inc ABS)	12-13									
									Nuda 900 R (inc ABS)	12-14									
									MD672LS	Front	Solid	280	N/A	Plain	N/A			APRILIA	
																		RS 50 (5 bolt fixing)	99-06
																		Tuono 50	04
																		MBK	
TZR 50 X Power	03-10																		
YAMAHA																			
TZR 50	03-16																		
MD673LS GOLD	Front	Floating	298	Gold	Plain				APRILIA Moto 6.5	95-01									

DISC BUYERS GUIDE

STREETBIKE DISC BUYERS GUIDE

Disc No.	F/R	Type	Dia. (mm)	Hub Color	Profile	Bobbins	Left Bracket	Right Bracket	Model	Year
MD674 GOLD	Rear	Solid	220	N/A	Plain	N/A			APRILIA Moto 6.5	95-01
MD675 SILVER	Front	Floating	310	Silver	Plain	9			MV AGUSTA 750 F4S (Mono Posto)	99-04
MD676 Black Hub	Front	Floating	310	Gold	Plain	6			TRIUMPH Tiger 955 From VIN 198875	04-06
MD677	Rear	Solid	285	N/A	Plain	N/A			TRIUMPH Tiger 955 From VIN 198875	04-06
MD678 MD678BLK VR678BLK	F/R F/R F/R	Floating Floating Floating	299 299 299	Natural Black Black	Plain Plain Vee	10 10 10			VICTORY Arlen Ness Victory Vision Cross Country 8- Ball Cross Country Tour Cory Ness Cross Country Cross Roads Cory Ness Jackpot Ness Signature Series Hammer Hammer Hammer 8 Ball Hammer S Hammer S Hard Ball Jackpot Judge King Pin King Pin King Pin Tour King Pin Tour King Pin 8 Ball King Pin-Low Magnum Vegas Vegas 8 Ball Vegas 8 Ball Vegas Jackpot Vegas Zach Ness Vegas Vegas Low Vegas Jackpot Vision 8 Ball Vision Street Vision Tour (All models)	10-12 15 13-17 11-12 10-12 08-10 05-07 05-07 08-11 10-16 07 08-17 12-13 10-16 13-17 04-07 08-12 04-07 08-09 08-11 09 15 03-07 05-07 08-17 06-07 08-17 08-12 08-09 08-09 10-11 08-09 08-17
MD679X MD679XC VR679BLK VR679BLU	Front Front Front Front	Floating Floating Floating Floating	320 320 320 320	Gold Gold Black Blue	Plain Contour Vee Vee	6 6 6 6			TRIUMPH Speed Triple EFI 955cc 5 bolt front disc Speed Triple 1050cc Speed Triple R 1050 (2 Pad Caliper/Non ABS/5 Spoke wheels)	99-04 05-06 12-13
VR679RED VR679GLD	Front Front	Floating Floating	320 320	Red Gold	Vee Vee	6 6			Tiger 1050 Tiger 1050 SE Tiger Sport (ABS) 1050cc	07-11 10-13 13-18
MD680 MD680C GOLD	Front Front	Floating Floating	305 305	Gold Gold	Plain Contour	9 9			KTM 950 Supermoto 990 Supermoto T (SM-T) 990 Supermoto R SM-R	05-07 08-13 08-13
MD681 MD681C VR681	Rear Rear Rear	Solid Solid Solid	240 240 240	N/A N/A N/A	Plain Contour Vee	N/A N/A N/A			KTM 690 Duke 690 Duke R 790 Duke 950 Supermoto 990 Superduke 990 Superduke R 990 Supermoto T (SM-T) 990 SM-R Supermoto R	08-12 10-11 20-21 05-07 05-11 07-13 08-13 08-13
MD682	Front	Solid	320	N/A	Plain	N/A			DUCATI Multistrada 1000 DS Multistrada S DS 1000 Multistrada 1100 (1078cc) Multistrada 1100 S (1078cc)	03-06 05-06 07-09 07-09

STREETBIKE DISC BUYERS GUIDE

Disc No.	F/R	Type	Dia. (mm)	Hub Color	Profile	Bobbins	Left Bracket	Right Bracket	Model	Year
MD683RS	Front	Floating	316	Silver	Plain	9			SACHS HERCULES Roadster 650	01-05
MD684	Front	Floating	320	Gold	Plain	9			NORTON F1 (Rotary) P55 Model F1 (Rotary) P55 B Model	90 90-91
MD685LS	Front	Solid	300	N/A	Plain	N/A			APRILIA RS 50 (Radial Caliper) RS4 50 (4T/AJP Caliper) RS4 50 (4T) (J. Juan Calipers) RS4 125 (4T/AJP Caliper) RS4 125 (4T/J Juan Caliper) RS 125 (4T) RS 125 (4T) GP Replica Tuono 125 DERBI GPR 50 Nude GPR 50 (2T) GPR 50 Racing GPR 50 GPR 125 Nude GPR 125 Racing GPR 125 (4T) 4V Mulhacen 125 Cafe Cast Wheel/Radial Caliper GILERA SC 125	06-11 11-14 11-14 11-15 11-15 17-18 18 17-18 04-09 09-12 08-10 04-07 04-08 04-07 09-14 08-10 06-07
MD686	Rear	Solid	180	N/A	Plain	N/A			APRILIA RS 50 (Radial Caliper) DERBI GPR 50 (40mm Forks/180mm Rear Disc/Radial Caliper) GPR 50 Racing (40mm Forks/180mm Rear Disc/ Radial Caliper) GPR 50 2T (41mm Forks/218mm Rear Disc/ Radial Caliper) GPR 50 Nude (Radial Caliper) GPR 125 Racing (Radial Caliper) (2T) GPR 125 Nude (Radial Caliper) (2T) GILERA SC 125	06-11 04-07 08-10 09-11 04-07 04-09 04-08 06-07
MD687	Front	Solid	305	N/A	Plain	N/A			F 750 GS F 750 GS Edition 40 F 850 GS F 850 GS Edition 40 F 850 GS Adventure F 850 GS Adventure Edition 40 HP2 Enduro R1200 GS K25 R1200 GS K25 Adventure R1200 GS K25 Adventure M R1200 GS K25 M R1200 GS R1200 GS 30 Years R1200 GS Triple Black R1200 GS Adventure R1200 GS Adventure Triple Black R1200 GS Rallye R1200 GS K50 LC/ Radial Calipers R1200 GS Adventure K51 LC/ Radial Calipers R1200 GS R1200 RS R1200 RS Sport R 1250 GS R 1250 GS Edition 40 R 1250 GS Adventure R 1250 GS Adventure Edition 40 R 1250 GS TE R 1250 GS Exclusive TE R 1250 GS Rallye R 1250 GS Rallye TE R 1250 RS R 1250 R R 1250 RT	16-20 20-21 16-20 20-21 16-20 20-21 05-09 02-07 05-07 06-09 06-09 10-11 2011 11-13 10-13 2011 2012 2012 13-18 14-18 15-18 15-18 19-21 20-21 19-21 20-21 19-21 19-21 19-21 19-21 19-21 19-20 19-20 19-20

DISC BUYERS GUIDE

STREETBIKE DISC BUYERS GUIDE

Disc No.	F/R	Type	Dia. (mm)	Hub Color	Profile	Bobbins	Left Bracket	Right Bracket	Model	Year
MD687 Contd.									R 1250 RT SE R 1250 RT LE	19-21 19-21
MD688	Rear	Solid	294	N/A	Plain	N/A			K 1200 GT (K44) K 1300 GT K 1300 GT EE (Disc has fixed bobbins) K 1300 GT SE (Disc has fixed bobbins)	06-08 09-11 10-11 10-11
MD689 MD689C	Rear Rear	Solid Solid	220 220	N/A N/A	Plain Contour	N/A N/A			HYOSUNG Comet GT 125 (Naked) GT 125 Naked GT 125 i Naked GT 125 R GD 250 i Naked Comet GT 250 (Naked) GT 250 (Naked) GT 250 R (Carbs) GT 250 i R GT 250 i R (Efi) Comet GT 650 (Naked) GT 650 Naked GT 650 i Naked GT 650 R GT 650 i R GT 650 S GT 650 X SUPERBYKE R-SR 250	04-06 06-12 13-15 06-14 13-15 04-05 06-12 05-07 08-13 14-15 04-08 09-11 12-15 07-08 14-15 05-08 07
MD690 MD690C	Front Front	Floating Floating	300 300	Gold Gold	Plain Contour	9 9			HYOSUNG Comet GT 125 (Naked) GT 125 Naked GT 125 i Naked GT 125 R Comet GT 250 (Naked) GT 250 (Naked) GT 250 R (Carbs) GT 250 i R GT 250 i R (Efi) Comet GT 250 GT 650 Naked GT 650 i Naked GT 650 R GT 650 i R GT 650 S GT 650 X SUPERBYKE R-SR 250	04-06 06-12 13-15 06-14 04-05 06-12 05-07 08-13 14-15 04-05 09-11 12-15 07-08 09-15 05-08 07
MD691	Front	Floating	300	Gold	Plain	6			HYOSUNG GV 650 (Efi) GV 650 i Pro Naked GV 700 C ST 7 (ST 700 i) ST 7 Deluxe (ST 700 i)	07-12 12-15 06-09 10-15 12-15
MD692 MD692C	Rear Rear	Solid Solid	282 282	N/A N/A	Plain Contour	N/A N/A			MOTO GUZZI 1000 Daytona RS 1000 V10 Centauro GT 1000 V10 Centauro Sport California 1100 Aluminium California 1100 Classic California 1100 EV California 1100 Jackall California 1100 Metal California 1100 Special California 1100 Sport California 1100 Stone California 1100 Titanium California 1100 Touring California 1100 Vintage 1100 California Aquila Nera 1100 California Classic Touring 1100 California EV 1100 California EV Touring 1100 California Jackal	97-98 97-99 97-99 02-05 06-09 01- 99-01 02-03 99-00 01-02 01-05 04-05 06-07 06-10 09-11 06-08 97-02 03-05 94-01

STREETBIKE DISC BUYERS GUIDE

Disc No.	F/R	Type	Dia. (mm)	Hub Color	Profile	Bobbins	Left Bracket	Right Bracket	Model	Year
MD692 MD692C Contd.									1100 California Special 1100 California Sport 1100 California Stone 1100 California Stone Metal 1100 California Vintage 1100 California 1100 190 1100 V11 Ballabio 1100 V11 Le Mans 1100 V11 Sport 1100 V11 Scura 1100 V11 Naked V11 (All models) Le Mans (All models) Brevia 1200 Norge 1200 (ABS) All models Stelvio 1200 Stelvio NTX 1200 (4 Valve) (Radial Caliper/ABS)	99-00 01-02 01-05 02-03 06-12 12 03-05 01-05 99-01 01-03 02-03 99-06 01-04 08-09 06-09 08-11 09-11
MD693LS MD693RS	Front Front	Floating Floating	272 272	Silver Silver	Plain Plain	6 6			MOTO GUZZI 750 SP 750 Nevada 1000-1000 SP111 (No spoke cast wheels/flat floating front discs) 1000 - California III - Carbs (VY Chassis Code/ Full fairing/Cast & spoke wheels 1000 - California III - Carbs (VW Chassis Code/ Screen only) 1000 - California III - EFi (VY Chassis Code/Full fairing/ cast & spoke wheels) 1000 - Le Mans 1V/V (10 spoke cast wheel) 1100 - California - Carbs (KC/KD Chassis codes)	90-92 91-01 89-94 88-90 87-93 90-93 84-93 94-97
MD694X MD694XC VR694BLK VR694BLU VR694RED VR694GLD	Front Front Front Front Front	Floating Floating Floating Floating Floating	330 330 330 330 330	Gold Gold Black Blue Red Gold	Plain Contour Vee Vee Vee	6 6 6 6 6 6			DUCATI Desmosedici RR (D16RR/989cc) 1098 1098 S 1098 S Tricolore	08 07-08 07-08 07
MD695 MD695C VR695	Rear Rear Rear	Solid Solid Solid	245 245 245	N/A N/A N/A	Plain Contour Vee	N/A N/A N/A			DUCATI 1098 1098 S 1098 R Monster 1100 Evo 20th Anniversary Model Streetfighter 1100 (1099cc) Streetfighter 1100 S (1099cc) 1198 1198 S 1198 R Corse 1198 S Corse 1198 SP Corse	07-08 07-08 08-09 13 09-11 09-13 09-11 09-10 10 10 11
MD696	Rear	Solid	210	N/A	Plain	N/A			MV (AUGUSTA) 750 Brutale S F4 750 Brutale Oro F4 750 F4S (Mono Posto) 750 F4S 1+1 (Bi-Posto) 750 F4 SPR 750 F4 SPR Senna 910 Brutale S/R 920 Brutale 990 Brutale R 998 Freccie Tricolori 998 F4 998 F4RR 998 F4R 998 F4 RR Corsa Corta 1000 Brutale 1000 F4 Ago 1000 F4 S (Mono Posto) 1000 F4 S 1+1 (Bi Posto) 1000 F4 Tamburini 1000 F4 R 1000 F4R 312 1000 F4R 312 1+1 1078 F4 RR 312	03-05 03-05 99-04 01-04 01-04 01-03 06-08 11-12 10-11 10 10-15 10-15 12-15 12 19-21 05 04-06 04-06 05 06-07 07-09 07-08 09

STREETBIKE DISC BUYERS GUIDE

Disc No.	F/R	Type	Dia. (mm)	Hub Color	Profile	Bobbins	Left Bracket	Right Bracket	Model	Year
MD696 Contd.									MV (AUGUSTA) Contd. 1078 Brutale RR 1078 F4100 cc Claudio Castiglioni 1090 Brutale 1090 Brutale Corsa 1090 Brutale R 1090 Brutale RR	08-09 07-08 13-15 13-15 12-15 10-14
MD697 MD697C	Rear Rear	Solid Solid	255 255	N/A N/A	Plain Contour	N/A N/A			APRILIA RST Futura 1000	01-04
MD698LS	Front	Solid	300	N/A	Plain	N/A			DERBI Senda 125 Baja SM (4T) (300mm disc) Senda 125 SM (Twin headlight) Senda R 125	06-12 04-07 04
MD699 Billet	Rear	Solid	316	N/A	Plain	N/A			TRIUMPH Rocket III Rocket III Classic Rocket III Touring Rocket III Roadster - ABS Rocket X	04-09 08-09 08-17 10-18 15-16
MD711LD MD711RD	Front Front	Floating Floating	282 282	Gold Gold	Plain Plain	10 10			YAMAHA TZ 125 TZ 250	94-97 89-96
MD713	Rear	Solid	185	N/A	Plain	N/A			HONDA RS 125 MD 250 H MD 250 S	88-07 08-11 08-11
MD714X MD714XC	Front Front	Floating Floating	280 280	Gold Gold	Plain Contour	6 6			KAWASAKI EX 500 A1-A7 EX 500 D1/D2/D3/D4/D5/D6	
MD719RS GOLD	Front	Floating	340	Natural	Plain	9			BUELL (Countersunk fixing) M2 Cyclone®, S1 Lightning®, S2 Thunderbolt®, S3 Thunderbolt® M2 Cyclone®, S1 Lightning®, S1 Whitelighting®, S3 Thunderbolt®, S3T Thunderbolt®, X1 Lightning	94-97 98-00
MD724	Rear	Solid	198	N/A	Plain	N/A			HONDA RS 250	88-02
MD727 VR727BLK	Front Front	Floating Floating	300 300	Gold Black	Plain Vee	9 9			VICTORY Victory Models	98-04
MD730LD MD730RD	Front Front	Floating Floating	298 298	Golf Golf	Plain Plain	10 10			YAMAHA TZ 250 TZ 250 (Radial Calipers)	97-01 02-10
MD732	Rear	Solid	185	N/A	Plain	N/A			YAMAHA TZ 125 TZ 250 TZ 250 (Radial Calipers)	94-97 89-90/92-01 02-10
MD734RS	Front	Floating	340	Silver	Plain	9			BUELL (Counterbored fixing) M2 Cyclone, X1 Lightning	00-05
MD735RS	Front	Solid	375	N/A	Plain	N/A			BUELL Firebolt XB9R XB9S Lightning XB12 S Lightning XB9SX Lightning CityX XB9 SX Lightning XB12 X Ulysses XB12 XT Ulysses XB12 SCG Lightning XB12 Ss Lightning Long XB12 Ss Lightning Long XB12 STT Lightning XB12 SCG Lightning XB12 R Firebolt XB12 R Firebolt 1125 R	02-07 03-04 04-08 05-09 08-10 06-10 08-10 06-08 06-08 09-10 08 09-10 04-08 09-10 08-10

STREETBIKE DISC BUYERS GUIDE

Disc No.	F/R	Type	Dia. (mm)	Hub Color	Profile	Bobbins	Left Bracket	Right Bracket	Model	Year
MD735RS Contd.									EBR 1125 CR 1190RX 1190SX	09-10 14-15 14-15
MD737	Front	Solid	320	N/A	Plain	N/A			BUELL Blast	00-07
MD738	Front	Solid	220	N/A	Plain	N/A			BUELL Blast	00-07
MD800X MD800XC VR800BLK VR800BLU VR800RED VR800GLD	Front Front Front Front Front Front	Floating Floating Floating Floating Floating Floating	308 308 308 308 308 308	Gold Gold Black Blue Red Gold	Plain Contour Vee Vee Vee Vee	6 6 6 6 6 6			TRIUMPH Daytona 675 Daytona 675 Daytona 675 R Street Triple 675 (Naked) Street Triple R 675	06-12 13-17 13-19 07-12 09-12
MD801 VR801	Front Front	Solid Solid	250 250	N/A N/A	Plain Vee	N/A N/A			CAN-AM Spyder RS SE5 Spyder RS SM5 Spyder RS Phantom Black Spyder RS-S Spyder RS Spyder RT-S Spyder RT Spyder RT Ltd	08-09 08-09 09 10-12 10-12 10-12 10-12 10-12
MD802 VR802	Rear Rear	Solid Solid	250 250	N/A N/A	Plain Vee	N/A N/A			CAN-AM Spyder RS SE5 Spyder RS SM5 Spyder RS Phantom Black Spyder RS-S Spyder RS Spyder RT-S Spyder RT Spyder RT Ltd	08-09 08-09 09 10-12 10-12 10-12 10-12 10-12
MD803 Loose bobbins	Front	Solid	320	N/A	Plain	N/A			BMW F 800 ST (Full fairing) (Disc has loose bobbins) F 800 S (Half fairing) (Disc has loose bobbins) R 1100 S (Non ABS) R 1200 RT K26/0368 Brembo Caliper Disc has loose bobbins R 1200 ST K28/0328 Disc has loose bobbins R 1200 S K29/0366 - Brembo Caliper Disc with loose bobbins INDIAN FTR 1200 FTR 1200 S FTR 1200 S Race Replica FTR Rally	06-08 06-08 12/00-03 05-11/07 03-11/07 06-11/07 18-20 19-20 19-20 20
MD804 Loose bobbins	Front	Solid	320	N/A	Plain	N/A			BMW F 800 R Disc fitting kit required F 800 R K73 Disc fitting kit required F 800 R Sport K73 Disc fitting kit required F 800 R Christen Pfeiffer edition - disc fitting kit required F 800 S Half fairing - Disc fitting kit required F 800 ST Full fairing - Disc fitting kit required F 800 ST Touring - Disc fitting kit required F 900 R K83 - Disc fitting kit required F 900 XR K84 - Disc fitting kit required HP2 Megamoto - Disc fitting kit required HP2 Sport - Disc fitting kit required K1200 GT K44 - Disc fitting kit required K1300 GT 4.5m thick disc-check disc thickness - Disc fitting kit required K1300 GT SE - Disc fitting kit required K1300 R - Disc fitting kit required K1300 R Carbon - Disc fitting kit required K1300 R Dynamic - Disc fitting kit required K1300 S - Disc fitting kit required K1300 S HP - Disc fitting kit required R Nine T K21/1170cc - Fitting kit required R Nine T /5 K21/1170cc - Fitting kit required	09-13 14-20 15 09-11 08-17 08-12 10-17 20 20 07-10 08-11 06-08 09-11 10-11 09-12 12 11-15 09-15 12 14-20 20-21

STREETBIKE DISC BUYERS GUIDE

Disc No.	F/R	Type	Dia. (mm)	Hub Color	Profile	Bobbins	Left Bracket	Right Bracket	Model	Year
MD804 Loose bobbins	Front	Solid	320	N/A	Plain	N/A			BMW R Nine T Pure K22/1170cc - Fitting kit required R Nine T Scrambler K21/1170cc - Fitting kit required R Nine T Café Racer K32/1170cc - Fitting kit required R Nine T Urban GS K33/1170cc - Fitting kit required R1200 RS K54 - Fitting kit required R1200 RS Sport K54 - Fitting kit required R1200 RT K26/0328 Dec 07-08 - Fitting kit required R1200 RT K52 - Fitting kit required R1200 RTSE K52 - Fitting kit required R1200 RT K52 LC-Radial calipers - Fitting kit required R1200 ST K28/0328-Dec 07-08 - Fitting kit required R1200 S K29/0366 Dec07-08 - Fitting kit required R1200 R K27/0378 - Fitting kit required R1200 R K27/0378-Dec 07-08 - Fitting kit required R1200 R Classic - Fitting kit required R1200 R K53 - Fitting kit required R1200 R Sport K53 - Fitting kit required R1200 RS R1200 RS Sport R 1250 RS - Fitting kit required R 1250 R - Fitting kit required R 1250 RT - Fitting kit required R 1250 RT SE - Fitting kit required R 1250 RT LE - Fitting kit required S 1000 R Naked K47 - Fitting kit required S 1000 R Naked - Fitting kit required S 1000 RR K46 - Fitting kit required S 1000 XR K49 - Fitting kit required S 1000 XR K69 - Fitting kit required	16-21 16-21 16-20 17-21 15-18 15-18 07-09 10-13 10-13 14-18 07-08 07-08 06-07 07-13 11-13 14-18 15-18 15-18 15-18 19-21 19-21 19-21 19-21 19-21 14-18 20-21 10-18 15-18 19-20
MD805 MD805C	Rear Rear	Solid Solid	220 220	N/A N/A	Plain Contour	N/A N/A			CAGIVA Super City 50/80 Prima 50 Mito 50 DERBI GPR 50 Replica Racing GPR 50 R Senda DRD Racing 50 R (Spoke wheel) Senda DRD Racing 50 SM (Cast wheel) Senda DRD X-treme 50 R (Spoke wheel/21" front wheel) Senda DRD X-treme 50 SM (Cast wheel/17" front wheel)	93-95 92-94 98-99 99-03 97-01 11-12 11-12 11-12 11-12
MD806LS	Front	Solid	260	N/A	Plain	N/A			CAGIVA Mito 50 DERBI GPR 50 Replica Racing GPR 50 R SACHS (HERCULES) Madass 50 (2 stroke) (Hydraulic rear brake) Madass 50 (4 stroke mechanical rear brake) Madass 50 (4T) Madass 125 Madass 125 (4T)	98-99 99-03 97-01 04-05 04-05 06-09 05 06-09
MD807LS	Front	Floating	280	Silver	Plain	6			DERBI Cross City 125 Mulhacen 125 (4T) Up to Ref No.7N001790 Spoke wheel/2 pin pad fixing Mulhacen 125 (4T) From Ref No.7N001791 Spoke wheel/single pin fixing Terra 125 Adventure Terra 125 Euro (Single pin pad fixing)	07-14 07 07-11 09-14 07-11
MD808	Rear	Solid	218	N/A	Plain	N/A			DERBI Senda DRD Racing 50 SM (300mm disc/std mounted caliper) Senda DRD Racing 50 R (300mm disc/std mounted caliper) Senda DRD Racing 50 SM (300mm disc/radial caliper) Cross City 125 Mulhacen 125 (4T) Up to Ref No. 7N001790 Spoke wheel /2 pin pad fixing Mulhacen 125 (4T) From Ref No. 7N001791 Spoke wheel/single pin fixing Senda 125 Baja R (4T) (260mm disc)	04-11 04-11 05-14 07-14 07 07-11 06-12

STREETBIKE DISC BUYERS GUIDE

Disc No.	F/R	Type	Dia. (mm)	Hub Color	Profile	Bobbins	Left Bracket	Right Bracket	Model	Year
MD808 Contd.	Rear	Solid	218	N/A	Plain	N/A			DERBI Contd. Senda 125 Baja SM (4T) (300mm disc) Senda 125 SM (Twin headlight) Senda R 125 Terra 125 Euro (Single pin pad fixing) Terra 125 Adventure	06-12 04-07 04 07-11 07-14
MD809 MD809C	Front Front	Solid Solid	300 300	N/A N/A	Plain Contour	N/A N/A			BMW G 650 Xchallenge G 650 Xcountry	07-09 07-09
MD810 MD810C	Rear Rear	Solid Solid	240 240	N/A N/A	Plain Contour	N/A N/A			BMW G 650 Xchallenge G 650 Xcountry	07-09 07-09
MD811	Front	F	300						APRILIA RX 50 SX 50 SX 50 Limited Edition DERBI Senda DRD Racing 50 SM (300mm disc/std mounted caliper) Senda DRD Racing 50 R (300mm disc/std mounted caliper) Senda DRD Racing 50 SM (300mm disc/radial caliper)	06-14 06-14 14-16 04-11 04-11 05-14
MD812	Rear	Solid	220	N/A	Plain	N/A			KTM RC8 (1190cc) RC8 R/Track (1190cc)	08-11 09-15
MD813	Front	Floating	300	Gold	Plain	N/A			CCM CR 40 Cafe Racer (Handlebar fairing)	07-08
MD814	Rear	Solid	220	N/A	Plain	N/A			DAELIM History 125 (SL 125)	01-06
MD815	Rear	Solid	220	N/A	Plain	N/A			SACHS (HERCULES) XTC 125 Supersport XTC 125	00-07 08
MD816	Rear	Solid	230	N/A	Plain	N/A			NORTON F1 (Rotary) P55 Model F1 (Rotary) P55 B Model	90 90-91
MD817X MD817XC VR817BLK VR817BLU VR817RED VR817GLD	Front Front Front Front Front	Floating Floating Floating Floating Floating	320 320 320 320 320	Gold Gold Black Blue Red Gold	Plain Contour Vee Vee Vee Vee	6 6 6 6 6 6			TRIUMPH Speed Triple (1050cc) 4 pad Brembo/Non ABS/220mm R/Disc Speed Triple (1050cc) 4 pad Brembo/ABS/220mm R/Disc Speed Triple (1050cc) 4 pad Brembo /Non ABS Speed Triple (1050cc) 4 pad Brembo/ABS Speed Triple R 1050 (2 Pad Caliper/Non ABS/10 Spoke wheels) Speed Triple R 1050 (2 Pad Caliper/ABS/10 Spoke wheels) Speed Triple R (1050cc/ABS) Speed Triple S (1050cc/ABS) Sprint GT 1050/SE (ABS) Trophy 1215cc Trophy 1215cc SE Sprint ST 1050i (Non ABS/Front Disc With Zero Offset/5 Bolt Fixing) Sprint ST 1050i (ABS/Front Disc With Zero Offset/5 Bolt Fixing)	07-20 07-20 09-16 09-16 14-16 14-16 17-20 17-20 10-20 12-16 12-17 11-12 11-12
MD819	Front	Floating	320	Silver	Plain	6			SACHS HERCULES Roadster 800 B-805	02-05 03-04
MD820 MD820C VR820	Rear Rear Rear	Solid Solid Solid	255 255 255	N/A N/A N/A	Plain Contour Vee	N/A N/A N/A			Tiger 800 ABS Tiger 800 XC ABS Tiger 800 XCa ABS Tiger 800 XCx ABS Tiger 800 XR ABS Tiger 800 XRt ABS Tiger 800 XRx (ABS) Tiger 900 Tiger 900 GT Tiger 900 GT low	11-14 11-19 15-19 15-19 15-19 15-19 15-19 20 20 20

DISC BUYERS GUIDE

STREETBIKE DISC BUYERS GUIDE

Disc No.	F/R	Type	Dia. (mm)	Hub Color	Profile	Bobbins	Left Bracket	Right Bracket	Model	Year
MD820 MD820C VR820 Contd.	Rear Rear Rear	Solid Solid Solid	255 255 255	N/A N/A N/A	Plain Contour Vee	N/A N/A N/A			Tiger 900 GT Pro Tiger 900 Rally Tiger 900 Rally Pro Speed Triple 1050 (ABS model) - From VIN 461332 Speed Triple R 1050 (2 Pad Caliper/ABS/10 Spoke wheels model) Sprint GT 1050 SE (ABS) Sprint 1050 ST Tiger Sport (ABS) 1050cc Tiger 1050 SE-ABS (1050cc)	20 20 20 11-16 14-16 10-20 05-10 13-18 10-13
MD821 MD821X* MD821XC* *Floating conversion with stainless steel centre	Front Front Front	Solid Floating Floating	310 310 310	N/A Stainless Stainless	Plain Plain Contour	N/A 5 5			TRIUMPH Bonneville (865cc/Cast wheels) Bonneville Newchurch (865cc/Cast wheels) Bonneville SE 865cc (Cast wheels) Speedmaster (865cc/EFi)	09-15 15 09-13 11-16
MD822 MD822X* MD822XC* *Floating conversion with stainless steel centre	Front Front Front	Solid Floating Floating	310 310 310	N/A Stainless Stainless	Plain Plain Contour	N/A 5 5			America (12 spoke Cast Wheel 865cc) America LT (12 spoke Cast Wheel 865cc) Bonneville Spirit (Spoke wheel/865cc) Bonneville T214 (Spoke wheel/865cc) Bonneville T100 (865cc/Spoke wheel) Bonneville T100 Black (865cc/Spoke wheel) Bonneville Steve McQueen SE Scrambler (865cc) Speedmaster (865cc/EFi)	10-17 14-17 15 10-16 14-16 12 10-15 08-09
MD825	Front	Floating	310	Gold	Plain	6			Thunderbird (1597cc) Thunderbird Commander (1699cc) Thunderbird LT (1699cc) Thunderbird Storm (1699cc) Thunderbird Nightstorm	09-18 14-18 14-18 11-18 15-18
MD827	Rear	Solid	240	N/A	Plain	N/A			SINNIS Stealth 125 QM125-2D	08-10
MD828	Front	Solid	276	N/A	Plain	N/A			SINNIS Vista 125 QM125 2C	08-10
MD829	Front	Solid	267	N/A	Plain	N/A			SINNIS JS 125-6C-SC125 Max 125 QM125-2V	12-14 08-09
MD831	Rear	Solid	310	N/A	Plain	N/A			Thunderbird (1597cc) Thunderbird Commander (1699cc) Thunderbird LT (1699cc) Thunderbird Storm (1699cc) Thunderbird Nightstorm	09-18 14-18 14-18 11-18 15-18
MD832	Rear	Solid	220	N/A	Plain	N/A			HP4 HP4 Carbon S 1000 R Naked (K47) S 1000 RR (K46)(Disc has fixed bobbins) S1000 R/RR (Models fitted with Forged race wheels - 7 Spoke type) S1000 R S1000 RR/RR Sport/RR M Sport	13-14 13-14 14-18 10-18 10-18 18-19 18-19
MD833	Rear	Solid	218	N/A	Plain	N/A			GPR 50 (2T) RS4 50 (4T/AJP Caliper) RS4 50 (4T) (J. Juan Calipers) SX 50 Limited Edition GPR 125 4T/4V RS4 125 (4T/AJP Caliper) RS4 125 (4T/J.Juan Caliper) RS 125 (4T) RS 125 (4T) GP Replica Tuono 125	09-11 11-14 11-14 14-16 09-14 11-15 11-15 17-18 18 17-18
MD834	Front	Solid	300	N/A	Plain	N/A			F 650 GS Scarver (K14/0174/0184 Belt Drive) F 650 GS Scarver (K17/0177/0187 Belt Drive) F 650 GS (R13/0172/0182) (19" front wheel) F 650 GS Dakar (R13/0173/0183) (21" front wheel) F 650 GS Dakar (R13/0176/0186) F 650 GS (R13/0175/0185) F 650 GS (K72/0218/0228) (798cc twin cylinder/cast wheels)	00-03 04-07 99-03 99-03 04-07 04-07 07-12

STREETBIKE DISC BUYERS GUIDE

Disc No.	F/R	Type	Dia. (mm)	Hub Color	Profile	Bobbins	Left Bracket	Right Bracket	Model	Year
MD834 Contd.	Front	Solid	300	N/A	Plain	N/A			F 650 GS (30 Years GS) G 650 GS (R131) G 650 GS Sertao HUSQVARNA TR 650 Terra (Spoke Wheel) TR 650 Strada (Cast Wheel)	11 09-14 12-14 12-13 12-13
MD834X	Front	Floating	300	Gold	Plain	6			F 650 GS (K72/0218/0228/Twin cylinder 798cc/ Cast wheel) F 700 GS F 800 GS F 800 GS Adventure F 800 GS (30 Years GS) F 800 GS Triple Black F 800 GS Trophy G 650 GS Sertao (Single cylinder/chain drive/ Spoke Wheels)	07-12 13-18 08-18 12-18 11 12 12-17 12-14
MD835 billet	Front	Floating	300	Gold	Plain	6			1000 - California III - Carbs 1000 - California III - EFI 1100 - California Carbs	88-90 90-93 94-97
MD836C	Front	Solid	240	N/A	Contour	N/A			Senda SM DRD Racing Ltd (SR2A2B Model/Cast Wheels)	
MD837	Front	Solid	300	N/A	Plain	N/A			750 SEi (6 Cyl) 900 SEi (6 Cyl)	75-83
MD838	F & R	Floating	250	Gold	Plain	6			Various Meriden Triumphs 6 bolt fixing. See application pages	
MD839	Front	Solid	230	N/A	Plain	N/A			Planet 125 (6 spoke wheels/3 Bolt Disc)	98-03
MD840 MD840C	Rear Rear	Solid Solid	282 282	N/A N/A	Plain Contour	N/A N/A			850 Brevia ie 850 Griso 940 Bellagio 1100 Brevia (STD/ABS Models) 1100 Griso 1200 Brevia 1200 Griso 8V (Standard/Cast Wheel/Radial Caliper) 1200 Griso 8V (Special Edition/Spoke Wheel/Radial Caliper) 1200 Norge 1200 Norge GT 8V (ABS) 1200 Sport 4V 1200 Sport 8V 1200 Stelvio 1200 Stelvio 8V (ABS) 1200 Stelvio NTX ABS 1200 Stelvio 8V NTX (ABS) 1400 California Touring 1400 California Touring SE 1400 Audace 1400 Audace Carbon 1400 Eldorado MGX 21 1400	06-07 06-07 07-13 05-07 05-08 08-09 07-12 07-15 06-07 08-15 06-07 08-13 08-11 11-15 09-10 11-15 13-16 15-17 15-16 16-17 15-17 16-19
MD841X MD841XC VR841BLK VR841BLU VR841RED VR841GLD	Front Front Front Front Front Front	Floating Floating Floating Floating Floating Floating	320 320 320 320 320 320	Gold Gold Black Blue Red Gold	Plain Contour Vee Vee Vee Vee	6 6 6 6 6 6			DUCATI 796 Monster 796 Monster 796 Monster 20th Anniversary Non ABS 796 Monster 20th Anniversary ABS 797 Monster 797+ Monster 821 Hypermotard 821 Hypermotard SP 821 Hyperstrada 821 Monster 821 Monster Dark 821 Monster Strip 821 Monster Stealth Supersport 950 Supersport 950 S Monster 937cc NewMonster Monster 937cc Plus New Monster 939 Hypermotard SP 939 Hyperstrada 950 Hypermotard 950	10-13 10-14 13 13 17-21 18-20 13-16 13-16 13-16 15-21 15-20 15-20 21 17-21 17-21 21 21 16-20 16-17 17-21

STREETBIKE DISC BUYERS GUIDE

Disc No.	F/R	Type	Dia. (mm)	Hub Color	Profile	Bobbins	Left Bracket	Right Bracket	Model	Year
MD841X									950 Hypermotard 950 RVE	17-21
MD841XC									950 Multistrada	17-21
VR841BLK									950 Multistrada S	19-21
VR841BLU									1100 Monster Non ABS	09-10
VR841RED									1100 Monster ABS	09-10
VR841GLD									1100 Monster Evo	11-13
Contd.									1100 Monster Evo 20th Anniversary	13
									1100 Monster Diesel	13
									1100 Scrambler	18-20
									1100 Scrambler Special	18-20
									1100 Scrambler Sport	18-20
									1100 Scrambler Pro	18-21
									1100 Scrambler Sport Pro	18-21
									1100 Scrambler Dark Pro	18-21
									1200 Multistrada Standard Edition	10-11
									1200 Multistrada ABS	10-14
									1200 Multistrada ABS - Single Pin front caliper	15-18
									1200 Multistrada Granturismo	13
									1200 Multistrada DVT	15-17
									1200 Multistrada Enduro	16
									1200 Multistrada Enduro	17-18
									1200 Multistrada Enduro Pro	18-19
									1200 Monster	14-21
									1200 S Monster	14-21
									1200 R Monster	16-18
									Diavel	11-21
									Diavel S	20-21
									Diavel AMG	11-12
									Diavel Carbon	11-19
									Diavel Chromo	12
									Diavel Dark	13-14
									Diavel Diesel 1200cc	17-18
									Diavel Strada	13-14
									Diavel Diesel (1262cc)	17-18
									1262 XDiavel	16-21
									1262 Xdiavel S	16-21
									1262 Xdiavel Dark	21
									1262 Xdiavel Dark Star	21
MD842X	Front	Floating	305	Gold	Plain	6			TRIUMPH	
MD842XC	Front	Floating	305	Gold	Contour	6			Tiger 800 (Non ABS)	11-14
VR842BLK	Front	Floating	305	Black	Vee	6			Tiger 800 (ABS)	11-14
VR842BLU	Front	Floating	305	Blue	Vee	6			Tiger 800 XC (Non ABS)	11-14
VR842RED	Front	Floating	305	Red	Vee	6			Tiger 800 XC (With ABS)	11-20
VR842GLD	Front	Floating	305	Gold	Vee	6			Tiger 800 XCa (ABS) up to VIN 855531	15-20
									Tiger 800 XCx (ABS) up to VIN 855531	15-20
									Tiger 800 XR (ABS)	15-18
									Tiger 800 XRt (ABS) up to VIN 855531	15-20
									Tiger 800 XRx (ABS) up to VIN 855531	15-20
									Tiger 900	20
									Tiger 900 GT	20
									Tiger 900 GT low	20
									Tiger 900 GT Pro	20
									Tiger 900 Rally	20
									Tiger 900 Rally Pro	20
									Tiger Explorer 1200	12-15
									Tiger Explorer 1200 XC	13-15
									Tiger 1200 XR	18-20
									Tiger 1200 XRx	18-20
									Tiger 1200 XRx Low	18-20
									Tiger 1200 XRt	18-20
									Tiger 1200 Xca	18-20
									Tiger 1200 XCx	18-20
									Tiger Explorer XC (1215cc)	16-17
									Tiger Explorer XCx/XCx Low (1215cc)	16-17
									Tiger Explorer XCa (1215cc)	16-17
									Tiger Explorer XR(1215cc)	16-17
									Tiger Explorer XRx/XRx Low (1215cc)	16-17
									Tiger Explorer XRt (1215cc)	16-17

DISC BUYERS GUIDE

STREETBIKE DISC BUYERS GUIDE

Disc No.	F/R	Type	Dia. (mm)	Hub Color	Profile	Bobbins	Left Bracket	Right Bracket	Model	Year
MD843X MD843XC MD843XBLK VR843BLK VR843BLU VR843RED VR843GLD	Front Front Front Front Front Front Front	Floating Floating Floating Floating Floating Floating Floating	320 320 320 320 320 320 320	Gold Gold Black Black Blue Red Gold	Plain Contour Plain Vee Vee Vee Vee	6 6 6 6 6 6 6			DUCATI 848 (Radial 2 pad caliper) 848 Evo (Monobloc front calipers) 848 Evo Dark 848 Streetfighter 899 Panigale 959 Panigale (ABS) 959 Panigale Corse (ABS) S4RS Monster (998cc) (Radial 4 pad caliper) S4R Testastretta Monster (998cc) (Radial 4 pad caliper) S4RS Testastretta Monster (998cc) (Radial 4 pad caliper) S4RS (Tricolore Monster/Testastretta) (998cc) (Radial 4 pad caliper) 1100 S Monster (ABS) 1100 S Monster (Non ABS)	08-10 10-13 12 11-15 14-15 16-20 18-20 06 07-08 07- 07-08 09-10 09-10
MD844X MD844XC	Front Front	Floating Floating	300 300	Gold Gold	Plain Contour	6 6			KTM 690 Enduro R (ABS) 990 Adventure (ABS Model) 990 Adventure Dakar Edition (ABS Model) HUSQVARNA 701 Enduro	14-20 07-12 11 16-21
MD845	Rear	Solid	240	N/A	Plain	N/A			BMW G650 Xmoto (Cast wheel)	07-09
MD846X	Front	Floating	296		Plain	6			MOTO GUZZI 1000- Quota 1000 Efi	92-97
MD847	Front	Solid	280	N/A	Plain	N/A			ROYAL ENFIELD Bullet 500 (Efi/Dual Seat) Bullet Electra X (All disc models/Dual Seat) Bullet Classic 500 (Efi/Single Seat) Bullet Classic Chrome 500 (Efi/Single Seat) Bullet Battle Green 500 (Efi/Single Seat) Bullet Desert Storm 500 (Efi/Single Seat) Clubman 500 EFI Electra 500 EFI Fury 500 (Efi) Trials 500 EFI Woodsmen 500 EFI	09-15 05-14 09-15 09-15 09-15 09-15 09-12 09-14 11-12 09-12 09-12
MD848X MD848XC	Front Front	Floating Floating	300 300	Gold Gold	Plain Contour	6 6			KTM 990 Adventure (ABS Model) 990 Adventure Dakar Edition (ABS Model)	07-12 11
MD849	Front	Solid	280	N/A	Plain	N/A			KTM 125 Duke 200 Duke	11-12 12
MD850	Rear	Solid	230	N/A	Plain	6			KTM Duke 125 RC 125 Duke 200 RC 200 Duke 250 Duke 390 RC 390 390 Duke (4T) RC 390 (4T)	11-20 14-15 12-15 14-15 15-20 13-20 14-20 15 15
MD851 MD851C	Rear Rear	Solid Solid	220 220	N/A N/A	Plain Contour	N/A N/A			TRIUMPH Street Triple 675 Street Triple S 660 Street Triple S 765 Street Triple RX 675 Street Triple 675R Street Triple R 765 Street Triple RS 765 Daytona 675 Daytona 675 R Thruxton 1200 (Liquid Cooled) Thruxton R 1200 (Liquid Cooled) Thruxton TFC 1200 (Liquid Cooled)	13-16 17-20 17-20 15 13-16 17-20 17-20 13-17 13-17 16-20 16-20 19-20

DISC BUYERS GUIDE

STREETBIKE DISC BUYERS GUIDE

Disc No.	F/R	Type	Dia. (mm)	Hub Color	Profile	Bobbins	Left Bracket	Right Bracket	Model	Year
MD852X MD852XC	Front Front	Floating Floating	310 310	Gold Gold	Plain Contour	6 6			TRIUMPH Daytona 675 R Street Triple 675 Street Triple S 660 Street Triple R 675 Street Triple R 675 Street Triple RX 675 Street Triple S 765 Street Triple R 765 Street Triple R 765 Street Triple RS 765	11-12 13-16 17-20 13-16 17-20 15-16 17-20 18-19 20-22 18-20
MD853 VR853	Front Front	Solid Solid	270 270	N/A N/A	Plain Vee	N/A N/A			CAN-AM Spyder F3 LTD Spyder F3 (SE6/SM6) Spyder F3-S (SE6/SM6) Spyder F3-S (Special Series) Spyder F3-S Daytona 500 Spyder F3-T Spyder RT (3 cyl Eng/6 speed) Spyder RT Ltd (3 cyl eng/6 speed) Spyder RT-S (3 cyl eng/6 speed) Spyder RT-S (Special Series) Spyder ST Brembo Calipers Spyder ST-S Brembo Calipers Spyder ST Ltd Brembo Calipers Spyder RS Brembo Calipers Spyder RS-S Brembo Calipers	16-21 15-21 15-21 16-21 17 16-21 13-21 13-21 13-17 16-17 13-16 13-16 13-15 13-16 13-16
MD854 VR854	Rear Rear	Solid Solid	270 270	N/A N/A	Plain Vee	N/A N/A			CAN-AM Spyder F3 LTD Spyder F3 (SE6/SM6) Spyder F3-S (SE6/SM6) Spyder F3-S (Special Series) Spyder F3-S Daytona 500 Spyder F3-T Spyder RT (3 cyl Eng/6 speed) Spyder RT Ltd (3 cyl eng/6 speed) Spyder RT-S (3 cyl eng/6 speed) Spyder RT-S (Special Series) Spyder ST Brembo Calipers Spyder ST-S Brembo Calipers Spyder ST Ltd Brembo Calipers Spyder RS Brembo Calipers Spyder RS-S Brembo Calipers	16-21 15-21 15-21 16-21 17 16-21 13-21 13-21 13-17 16-17 13-16 13-16 13-15 13-16 13-16
MD855X MD855XC	Front Front	Floating Floating	320 320	Gold Gold	Plain Contour	6 6			MZ/MUZ 1000 S 1000 SF 1000 SFX 1000 ST	03-07 05-07 07 07
MD856X MD856XC VR856ORG	Front Front Front	Floating Floating Floating	320 320 320	Gold Gold Orange	Plain Contour Vee	6 6 6			KTM Duke 690 (2 pin pad fixing/multi spoke cast wheel) Duke 690 R (Multi spoke cast wheels) 890 Duke R	13-18 13-18 20-21
MD857 MD857C	Rear Rear	Solid Solid	240 240	N/A N/A	Plain Contour	N/A N/A			KTM Duke 690 (2 pin pad fixing/multi spoke cast wheel) Duke 690 R (Multi spoke cast wheels)	13-20 13-18
MD858 MD858C VR858	Rear Rear Rear	Solid Solid Solid	260 260 260	N/A N/A N/A	Plain Contour Vee	N/A N/A N/A			APRILIA NA850 Mana (Non ABS)	08-11
MD859	Front	Floating	320	Gold	Plain	5			MOTO GUZZI 850 Brevia ie (Non ABS Models) 850 Norge (Non ABS Model) V9 Bobber V9 Bobber Sport V9 Roamer 1100 Brevia (Non ABS models)	06-07 07 16-20 19-20 16-20 05-07
MD860	Rear	Solid	220	N/A	Plain	N/A			SACHS (HERCULES) X Road 125 XTC 125 Supersport XTC 125 N	06-07 00-07 00-07

STREETBIKE DISC BUYERS GUIDE

Disc No.	F/R	Type	Dia. (mm)	Hub Color	Profile	Bobbins	Left Bracket	Right Bracket	Model	Year
MD861	Rear	Solid	220	N/A	Plain	N/A			CAGIVA Tamanaco 125 Elefant	88-89 88-90
MD862X	Front	Floating	320	Gold	Plain	6			BMW HP4 HP4 Carbon S1000 R/RR (Models fitted with Forged race wheels - 7 Spoke type) S 1000 XR K69 Carbon wheels KTM 690 SM 2 pin pad fixing 690 SMC 4 pad type caliper	13-14 13-14 10-18 18-20 07-09 08-10
MD863	Rear	Solid	282	N/A	Plain	N/A			TRIUMPH Explorer 1200 Explorer XC 1200 Tiger 1200 XR Tiger 1200 XRx Tiger 1200 XRx Low Tiger 1200 XRt Tiger 1200 Xca Tiger 1200 XCx Tiger Explorer XC (1215cc) Tiger Explorer XCx/XCx Low (1215cc) Tiger Explorer XCa (1215cc) Tiger Explorer XR(1215cc) Tiger Explorer XRx/XRx Low (1215cc) Tiger Explorer XRt (1215cc) Trophy 1215cc Trophy 1215cc SE	12-15 13-15 18-20 18-20 18-20 18-20 18-20 18-20 18-20 16-17 16-17 16-17 16-17 16-17 16-17 16-17 12-16 12-17
MD864 MD864X MD864XC	Front Front Front	Solid Floating Floating	300 300 300	N/A Gold Gold	Plain Plain Contour	N/A 6 6			KTM Duke 125 Duke 200 Duke 250 Duke 390 RC 125/200/390	13-20 13-15 15-20 13-17 14-19
MD865X MD865XC	Front Front	Floating Floating	305 305	Gold Gold	Plain Contour	6 6			DUCATI 796 Hypermotard 1100 Hypermotard 1100 S Hypermotard 1100 EVO Hypermotard 1100 EVO SP Hypermotard	10-13 07-09 07-09 10-12 10-12
MD866	Front	Solid	190	N/A	Plain	N/A			PUCH M 50 SDP Spoke Wheel/Grand Prix Special M 50 SDP Cast Wheel/Grand Prix Supreme	75-77 75-77
MD868X MD868XC	Front Front	Floating Floating	330 330	Gold Gold	Plain Contour	6 6			DUCATI 803 Scrambler Café Racer 803 Scrambler Classic 803 Scrambler Desert Sled 803 Scrambler Flat Track Pro 803 Scrambler Full Throttle 803 Scrambler Icon 803 Scrambler Icon Dark 803 Scrambler Mach 2 803 Scrambler Nightshift 803 Scrambler Street Classic 803 Scrambler Urban Enduro	17-21 15-20 17-21 16 15-21 15-21 15-21 18-20 20-21 18-20 15-16
MD869	Front	Solid	270	N/A	Plain	N/A			GILERA Nordwest 600	90-
MD870XC	Front	Floating	320	Gold	Contour	6			APRILIA Dorsodura 750 (ABS) Dorsodura Factory 750 Dorsodura Factory 750 (ABS) Shiver 750 (RAE00/STD & ABS)	08-16 10-13 10-12 10-16
MD871	Rear	Solid	260	N/A	Plain	N/A			MOTO GUZZI 750 Brevia ie (3 Spoke Cast Wheel) V9 Bobber V9 Bobber Sport V9 Roamer	03-11 16-21 19-21 16-21

STREETBIKE DISC BUYERS GUIDE

Disc No.	F/R	Type	Dia. (mm)	Hub Color	Profile	Bobbins	Left Bracket	Right Bracket	Model	Year
MD872 MD872C VR872	Rear Rear Rear	Solid Solid Solid	256 256 256	N/A N/A N/A	Plain Contour Vee	N/A N/A N/A			APRILIA NA 850 Mana (ABS) NA 850 Mana GT (ABS Model)	08-13 09-16
MD873 MD873X	Front Front	Solid Floating	310 310	N/A Gold	Plain Plain	N/A 5			TRIUMPH Street Scrambler (900cc Liquid Cooled) Street Twin (900cc Liquid Cooled) Thruxton 1200 (Liquid Cooled) Bonneville Bobber (1200cc Liquid Cooled) Bonneville Bobber Black (1200cc Liquid Cooled) Bonneville Speedmaster (1200cc Liquid Cooled) Bonneville T120 (1200cc Liquid Cooled) Bonneville T120 Black (1200cc Liquid Cooled)	16-20 16-21 16-20 17-21 18-21 18-21 16-21 16-21
MD874	Rear	Solid	255	N/A	Plain	N/A			TRIUMPH Street Scrambler (900cc Liquid Cooled) Street Twin (900cc Liquid Cooled) Street Cup (900cc Liquid Cooled) Bonneville T100 (900cc/Liquid Cooled/Spoke Wheel) Bonneville T100 Black (900cc/Liquid Cooled/Spoke Wheel) Bonneville Bobber (1200cc Liquid Cooled) Bonneville Bobber Black (1200cc Liquid Cooled) Bonneville Speedmaster (1200cc Liquid Cooled) Speed Triple S (1050cc/ABS) Speed Triple R (1050cc/ABS) Bonneville T120 (1200cc Liquid Cooled) Bonneville T120 Black (1200cc Liquid Cooled)	16-20 16-21 16-20 16-21 16-21 17-21 18-21 18-21 17-21 17-21 16-21 16-21
MD876	Front	Floating	270	Gold	Plain	6			MOTO GUZZI 1000 Le-Mans Disc mount with 8.5mm bolts	84-93
MD877	Rear	Solid	240	N/A	Plain	N/A			ROYAL ENFIELD 535cc Continental GT (ABS)	17-18
MD878 MD878C VR878	Rear Rear Rear	Solid Solid Solid	245 245 245	N/A N/A N/A	Plain Contour Vee	N/A N/A N/A			DUCATI 796 Monster (ABS Models) 796 Monster 20th Anniversary Model (ABS Models) 821 Hypermotard 821 Hypermotard SP 821 Hyperstrada 848 Streetfighter 939 Hypermotard 939 Hypermotard SP Panigale V4 R 1100 Monster ABS 1100 Monster S ABS 1100 Monster EVO 1100 Monster EVO 20th Anniversary 1100 Monster Diesel Panigale V4 Panigale V4 S Panigale V4 SP Streetfighter V4 Streetfighter V4	10-14 13 13-16 13-16 13-16 11-15 16-18 16-18 21 09-10 09-10 11-13 13 13 18-21 18-21 21 19-21 19-21
MD879	Rear	Solid	265	N/A	Plain	N/A			DUCATI 1200 Multistrada ABS (Single Pin F/Caliper) 1200 S Multistrada Pikes Peak 1200 S Multistrada 1200 S Multistrada D air 1200 S Multistrada D air DVT Diavel ABS Diavel Carbon ABS Diavel Diesel (1262cc) 1260 Multistrada 1260 S Multistrada 1260 S Multistrada Touring 1260 S Multistrada D air 1260 Multistrada Pikes Peak 1260 Multistrada S Grand tour Diavel Chromo ABS Diavel Dark Diavel Diesel 1200cc Diavel Strada Xdiavel 1260cc XDiavel S 1260cc	15-18 16-17 15-18 15-17 15-17 11-20 15-20 17-18 18-21 18-20 18 18 18-20 19-21 12 13-14 17-18 13-14 11-21 20-21

STREETBIKE DISC BUYERS GUIDE

Disc No.	F/R	Type	Dia. (mm)	Hub Color	Profile	Bobbins	Left Bracket	Right Bracket	Model	Year
MD879 Contd.	Rear	Solid	265	N/A	Plain	N/A			DUCATI Contd. 1262 XDiavel 1262 Xdiavel S 1262 Xdiavel Dark 1262 Xdiavel Dark Star	16-21 16-21 21 21
MD880 MD880C VR880	Rear Rear Rear	Solid Solid Solid	245 245 245	N/A N/A N/A	Plain Contour Vee	N/A N/A N/A			DUCATI Supersport 950 937cc Supersport 950 S 937cc 950 Hypermotard 950 950 Hypermotard 950 RVE 950 Hypermotard 950 SP 959 Panigale 959 Panigale Corse Panigale V2 955cc 998 Panigale Superleggera 1103 Panigale V4 R 1103 Panigale V4 1103 Panigale V4 S 1103 Panigale V4 SP 1199 Panigale 1199 Panigale ABS 1199 Panigale S ABS 1199 Panigale S Tricolore 1199 Panigale R 1199 Superleggra Panigale 1200 Multistrada Standard Edition 1200 Multistrada ABS 1200 Multistrada Granturismo 1200 Multistrada DVT 1200 Monster 1200 S Monster 1200 R Monster 1299 Panigale 1299 Panigale S 1299 Panigale R 1299 Panigale R Final Edition 1299 Superleggera 1299 Panigale V4 Corse/Speciale	17-21 17-21 17-21 17-21 17-21 16-19 16-19 19-21 21 21 18-21 18-21 21 12-13 12-15 12-15 12-13 12-16 2014 10-11 10-14 13 15-17 14-21 14-21 16-18 15-18 15-18 15-17 18 17 18-19
MD881	Front	Solid	300	N/A	Plain	N/A			BMW G 310 R G 310 GS G 310 GS Edition 40	17-21 17-21 20-21
MD882	Rear	Solid	240	N/A	Plain	N/A			BMW G 310 R G 310 GS G 310 GS Edition 40	17-21 17-21 20-21
MD883X MD883XC	Front Front	Floating Floating	310 310	Gold Gold	Plain Contour	6 6			TRIUMPH Thrupton R 1200 (Liquid Cooled) Thrupton TFC 1200 (Liquid Cooled)	16-20 19-20
MD884X MD884XC	Front Front	Floating Floating	320 320	Gold Gold	Plain Contour	6 6			MV 675 Brutale 675 F3 675 F3 Serie Oro 675 F3 RC 800 Brutale 800 Brutale Dragster 800 Dragster RC 800 Dragster RR 800 Brutale RR 800 Brutale RR SCS 800 Brutale Rosso 800 Dragster RR SCS 800 Dragster Rosso 800 F3 800 F3 Ago 800 F3 RC 800 Stradale 800 Turismo Veloce 800 Turismo Veloce Lusso 800 Turismo Veloce RC 800 Turismo Veloce Lusso SCS	12-17 12-20 12-13 15-18 12-18 14-15 17-21 15-21 19-21 19-21 19-21 19-21 19-21 19-21 13-20 14-15 15-20 15 14-21 15-21 17-21 19-21

STREETBIKE DISC BUYERS GUIDE

Disc No.	F/R	Type	Dia. (mm)	Hub Color	Profile	Bobbins	Left Bracket	Right Bracket	Model	Year
MD884X MD884XC (Contd.)	Front	Floating	320	Gold	Plain	6			MV Contd. Rivale 800 1000 Brutale 1000 F4 Ago 1000 F4 S Mono Posto 1000 F4 Ss 1+1 Bi Posto 1000 F4 Tamburini 1000 F4 R 1000 F4 R 312 Brembo 4 pad caliper up to Vin # 008064 1000 F4 R 312 Brembo 4 pad caliper up to Vin # 008065 1078 Brutale RR 1078 F4 100 CC Claudio Castiglione 1078 F4 RR 312 1090 Brutale 1090 Brutale R 1090 Brutale RR	14-18 19-21 05 04-06 04-06 2005 06-07 2007 08-09 08-09 07-08 2009 13-15 12-15 10-15
MD885 MD885C	Rear Rear	Solid Solid	220 220	N/A N/A	Plain Contour	N/A N/A			MV 675 Brutale 675 F3 675 F3 Serie Oro 675 F3 RC 800 Brutale 800 Brutale Dragster 800 Dragster RC 800 Dragster RR 800 Brutale RR 800 Brutale RR SCS 800 Brutale Rosso 800 Dragster RR SCS 800 Dragster Rosso 800 F3 800 F3 Ago 800 F3 RC 800 Stradale 800 Turismo Veloce 800 Turismo Veloce Lusso 800 Turismo Veloce RC 800 Turismo Veloce Lusso SCS Rivale 800	12-17 12-20 12-13 15-18 12-18 14-15 17-21 15-21 19-21 19-21 19-21 19-21 19-21 13-20 14-15 15-20 15 14-21 15-21 17-21 19-21 14-18
MD886X	Front	Floating	310	Gold	Plain	6			TRIUMPH Bonneville T100 (900cc/Liquid Cooled/Spoke Wheel) Bonneville T100 Black (900cc/Liquid Cooled/Spoke Wheel) Street Cup (900cc Liquid Cooled)	16-21 16-21 16-20
MD887BLK VR887BLK	Rear Rear	Floating Floating	299 299	Black Black	Plain Vee	9 9			INDIAN Chief Classic (Spoke Wheel/Nissin Calipers) Chief Vintage (Spoke Wheel/Nissin Calipers) Chieftain (Cast Wheel/Nissin Calipers) Chieftain Dark Horse (Cast Wheel/Nissin Calipers) Chieftain Limited (Cast Wheel/Nissin Calipers) Chief Dark Horse Roadmaster (Cast Wheel/Nissin Calipers) Roadmaster Classic (Nissin Calipers) Roadmaster Elite (Nissin Calipers) Springfield Springfield Dark Horse	14-18 14-20 14-20 16-20 17-20 14-20 15-20 17-18 17-20 16-20 18
MD890BLK VR890BLK	Front Front	Floating Floating	299 299	Black Black	Plain Vee	10 10			INDIAN Chief Classic (Spoke Wheel/Nissin Calipers) Chief Vintage (Spoke Wheel/Nissin Calipers) Chieftain (Cast Wheel/Nissin Calipers) Chieftain Dark Horse (Cast Wheel/Nissin Calipers) Chieftain Limited (Cast Wheel/Nissin Calipers) Chief Dark Horse Roadmaster (Cast Wheel/Nissin Calipers) Roadmaster Classic (Nissin Calipers) Roadmaster Elite (Nissin Calipers) Springfield Springfield Dark Horse	14-18 14-20 14-20 16-20 17-20 14-20 15-20 17-18 17-20 16-20 18
MD891	Front	Floating	300	Silver	Plain	9			MOTO GUZZI G5 V1000	78-83

STREETBIKE DISC BUYERS GUIDE

Disc No.	F/R	Type	Dia. (mm)	Hub Color	Profile	Bobbins	Left Bracket	Right Bracket	Model	Year
MD893	Front	Solid	300	N/A	Plain	N/A			ROYAL ENFIELD Himalayan	16-20
MD894 MD894C	Rear Rear	Solid Solid	240 240	N/A N/A	Plain Contour	N/A N/A			ROYAL ENFIELD Himalayan	16-20
MD896X	Front	Floating	320	Black	Plain	6			KTM 1090 Adventure R 1190 Adventure Inc R model 1290 Super Adventure R,S and T models	17-19 14-16 15-20
MD898X MD898XC	Front Front	Floating Floating	320 320	Gold Gold	Plain Contour	6 6			ROYAL ENFIELD 650 interceptor	2019
MD899	Rear	Solid	245	N/A	Plain	N/A			DUCATI 400 Scrambler Sixty2 797 Monster 797+ Monster 803 Scrambler Café Racer 803 Scrambler Classic 803 Scrambler Desert Sled 803 Scrambler Flat Track Pro 803 Scrambler Full Throttle 803 Scrambler Icon 803 Scrambler Icon Dark 803 Scrambler Mach 2 803 Scrambler Night Shift 803 Scrambler Street Classic 803 Scrambler Urban Enduro 821 Monster 821 Monster Dark 821 Monster Stripe 821 Monster Stealth 899 Panigale Monster 937cc Monster 937cc Plus GT 1000 (992cc) GT 1000 (992cc) Touring 1100 Scrambler 1100 Scrambler Special 1100 Scrambler Sport 1100 Scrambler Pro 1100 Scrambler Sport Pro 1100 Scrambler Dark Pro	16-21 17-21 18-20 17-21 15-20 17-21 2016 15-21 15-21 15-21 18-20 20-21 18-20 15-16 15-21 15-20 15-20 21 14-15 21 21 07-10 09 18-20 18-20 18-20 18-21 18-21 18-21
MD8001	Rear	Solid	275	N/A	Plain	N/A			BMW R1200 GS K50 LC/Radial Calipers R1200 GS K51 Adventure LC/Radial Calipers R1200 RS R1200 RS Sport R1200 RT K52 R1200 R R1200 R Sport R 1250 GS R 1250 GS Edition 40 R 1250 GS Adventure R 1250 GS Adventure Edition 40 R 1250 GS TE R 1250 GS Exclusive R 1250 GS Rallye R 1250 GS Rallye TE R 1250 RS R 1250 R R 1250 RT R 1250 RT SE R 1250 RT LE	13-18 14-18 15-18 15-18 14-18 15-18 15-18 19-20 20-21 19-20 20-21 19-20 19-20 19-20 19-20 19-20 19-20 19-21 19-21 19-21 19-21 19-21
MD8002	Front	Solid	300	N/A	Plain	N/A			APRILIA RX 50 Racing	03-06
MD8003X ABS sensor disc	Front	Floating	305	Gold	Plain	6			KTM 990 Supermoto T (SM-T) 990 Supermoto R (SM-R) 990 Supermoto R (SM-R)	09-13 08-09 10-13

STREETBIKE DISC BUYERS GUIDE

Disc No.	F/R	Type	Dia. (mm)	Hub Color	Profile	Bobbins	Left Bracket	Right Bracket	Model	Year
MD8004X	Front	Floating	330	Gold	Plain	6			APRILIA RSV4 1100 Factory RSV4 1100 RR Tuono 1100 V4 Tuono 1100 V4 RR 1100 Tuono 1100 V4 Factory 1100	19-21 19-21 17-18 17-21 19-21
MD8005	Front	Solid	230	N/A	Plain	N/A			BOOM TRIKE Various Models	10-18
MD8006 MD8006C	Rear Rear	Solid Solid	265 265	N/A N/A	Plain Contour	N/A N/A			DUCATI 1200 Multistrada Enduro 1200 Multistrada Enduro 1200 Multistrada Enduro Pro	16 17-18 18-19
MD8007	Rear	Solid	260	N/A	Plain	N/A			INDIAN FTR 1200 FTR 1200 S FTR 1200 S Race Rep FTR 1200 Rally	19-21 19-21 19-21 19-21
MD8008XC	Front	Floating	320	Gold	Contour	6			TRIUMPH Scrambler 1200 XC Scrambler 1200 XE Speed Triple S Speed Triple RS Rocket 3 GT Rocket 3 R Tiger 900 Tiger 900 GT Tiger 900 Rally Tiger 900 GT Pro Tiger 900 Rally Pro	19-20 19-20 17-21 18-21 19-21 19-21 20-21 20-21 20-21 20-21 20-21 20-21
MD8009	Front	Solid	300	N/A	Plain	N/A			KTM 125 Duke 200 Duke	17-21 17-21
MD8010	Front	Solid	300	N/A	Plain	N/A			KTM RC 390	17-21
MD8011X	Front	Floating	330	Gold	Plain	6			DUCATI 1200 S Multistrada DVT 1200 S Multistrada Sports Edition 1200 S Multistrada Touring Edition 1200 Multistrada Touring 1200 S Multistrada Touring Edition 1200 S Multistrada 1200 S Multistrada D air 1200 S Multistrada D air DVT 1200 S Multistrada Pikes Peaks 1200 S Multistrada Pikes Peaks 1260 Multistrada 1260 Multistrada Touring 1260 S Multistrada 1260 S Multistrada D Air 1260 S Multistrada Pikes Peak 1260 Multistrada Enduro 1260 Multistrada S Grand Tour Multistrada V4 Multistrada V4 S Multistrada V4 Sport Diavel S	15-17 10-12 10-14 15-17 15-18 15-18 15-17 15-17 11-14 16-17 18-20 18 18-20 18-20 18-20 18-20 18-20 19-20 21 21 21 20-21
MD901D VR901 With counter sunk bolt holes	F & R F & R	Solid Solid	190 190	N/A N/A	Plain Vee	N/A N/A			ATALA Hacker (LC) Hacker (Racing) Hacker BETA Eickon 50 Quadra 50 Tempo 50 ARK LC/AC (All models) GOVECS (Electric Scooters) GO S 1.2 GO T 1.2 GO S 1.4 GO T 1.4	97 97 97 99-06 97-00 98-02 97-14 11-14 11-14 11-14 13-14

STREETBIKE DISC BUYERS GUIDE

Disc No.	F/R	Type	Dia. (mm)	Hub Color	Profile	Bobbins	Left Bracket	Right Bracket	Model	Year
MD901D VR901 With counter sunk bolt holes Contd.	F & R	Solid	190	N/A	Plain	N/A			BETA Contd. GO S 2.4	11-14
	F & R	Solid	190	N/A	Vee	N/A			GO T 2.4 GO S 3.4 GO T 3.4 MALAGUTI Ciak 50 Twin Disc Ciak 100 Ciak 50/100 Phantom F12 50 (LC) F12 50 Phantom Firefox F15 Crosser CR1 F15 RR F15 Firefox (LC) F15 Firefox Kat PEUGEOT Scooters with Grimeca Wheels Disc attached with countersunk bolts Elyseo 50 Looxor 50 TSDi Ludix Elegance 50cc Ludix Pro (14" wheels/4T) Metal-X 50 TRK 50 (2T) (10" wheels) TRK 50 (2T/12" wheels) Trekker 50 (2T) AJP Caliper Trekker 50 (2T) Heng Tong Caliper Vivacity 50 (12" wheels) Vivacity 2 (50cc) (10" wheels) Vivacity 50/100 (All models) SV 100 L Looxor 100 Trekker 100 (2T) Ludix Ambition 125cc PIAGGIO Quartz 50 TAMORETTI Retro 50 Retro 125 Stealth 125	11-14 11-14 11-14 11-14 00-03 99-01 00-03 94-08 98 96-03 97-01 99-01 01-08 98-00 98-02 06 04 11 02-03 09-12 09-12 98-00 98-00 92-07 08-11 99-07 01-04 98 04-05 92-96
MD902D VR902	Front	Solid	200	N/A	Plain	N/A			PIAGGIO Skipper 125/150	94-97
	Front	Solid	200	N/A	Vee	N/A			MALAGUTI Centro SL/SL CAT Centro Base	94-00
MD903D MD903C VR903	Front	Solid	245	N/A	Plain	N/A			YAMAHA YP 250 DX/A 'Majesty'	98-00
	Front	Solid	245	N/A	Vee	N/A			YP 250 Majesty YP 250 Skyliner YP 250 Skyliner 250 (+ABS) MBK YP 250 Skyliner	96-02 96-98 00-03 96-00
MD904D VR904	Front	Solid	155	N/A	Plain	N/A			ADLY Road Tracker 50/90/100	04-06
	Front	Solid	155	N/A	Vee	N/A			APRILIA Amico (All models) GARELLI Queenie Grinta GILERA Easy Moving 50 HYOSUNG 50 Newtee Up (4T) JORDAN Easy 50/100 LEXMOTO Molly 50 (DFE50QT-3) MALAGUTI Malbo Line - DVD 50 (2T) MBK CR 50 Z Target CW 50 R Booster Road CV 50 Evolis	93- 95- 95- 95-96 14-15 03-04 15-18 10-11 91-95 94-95 97

STREETBIKE DISC BUYERS GUIDE

Disc No.	F/R	Type	Dia. (mm)	Hub Color	Profile	Bobbins	Left Bracket	Right Bracket	Model	Year
MD904D VR904 Contd.									MBK Contd. CY 50 Forte/Forte Mufa YA 50 R Forte YE 50 Evolis YM 50 Fizz CV 80 Evolis MOTO-ROMA Go-Go 50 Stinger 50 Scrambler 50 Roadrunner 50/100 MUZ Mosquito FB50 Mosquito SX JP50 OHVALE GP-0 110,160 PIAGGIO Zip Fast Raider Zip 50 Base Zip 50 RST Zip 50 Elettrico PEUGEOT Scooters with Leleu wheels disc attached with counterbored bolts Ludix Snake/Bullet/Trend 50cc P.G.O. Big max 50 EPS Tornado 50/125 SINNIS Jet 50 QM50QT-6A M-Ped 50 Road Classic SUPERBYKE Falcon 50 QM50QT-2T YAMAHA CR-Z 50 (3WN) YA 50 R Axis (4pc) YE 50 Zest YM 50 Breeze (4KH) Jog 'R'	96-97 94-95 92-95 94-95 97 97-05 99-05 01 01-02 97-03 00-03 19-20 93-97 95-96 96-99 02 04 94-06 97 97 08-10 08-10 91-95 95-96 93-95 94-95 91-
MD905D	Front	Solid	175	N/A	Plain	N/A			PIAGGIO Hexagon 125/150	94-97
MD906D VR906	Front Front	Solid Solid	160 220	N/A N/A	Plain Vee	N/A N/A			HONDA SFX 50 'S/T/V/W/X/Y/1' SXR 50 W/SW/X/SX	95-04 98-99
MD907D MD907C VR907	Front Front	Solid Solid	220 220	N/A N/A	Plain Vee	N/A N/A			YAMAHA YP 125 Majesty XN 125 N Teo's MBK XN 125/150 Doo Do YP 125 D Skyliner	98-09 00-03 00-05 98-09
MD908D VR908	Front Front	Solid Solid	186 186	N/A N/A	Plain Vee	N/A N/A			HONDA CN 250 H/J/L/M/P/R/S/T/V/X SPAZIO/Helix CN 250 3 Fusion/Fusion X/Fusion X Special	87-98 03
MD909D With counterbored holes	Rear	Solid	190	N/A	Plain	N/A			BENELLI 491 K2 50/100 Naked 50/100 PEUGEOT Scooter with Leleu wheels discs attached with counterbored bolts Ludix Elegance 50cc Ludix Ambition 125cc	98-04 98-01 02-03 04 04
MD910D VR910	Front Front Front	Solid Solid Solid	200 200 200	N/A N/A N/A	Plain Vee Vee	N/A N/A N/A			PIAGGIO Fly 50 (2T) Fly 50 (4T) Free 50 LX 50 (4T) Sfera 50 RST Zip 50 SP (L/C)	05-18 05-18 95-02 05-10 95-97 96-13

STREETBIKE DISC BUYERS GUIDE

Disc No.	F/R	Type	Dia. (mm)	Hub Color	Profile	Bobbins	Left Bracket	Right Bracket	Model	Year	
MD910D VR910 Contd.	Front	Solid	200	N/A	Plain	N/A			PIAGGIO Contd. Free Delivery 50 Fly 100 (4T) Free 100 Fly 125 (4T/2V) Fly 125 ie (3V/4T) Sfera 125 Vespa ET4 125 Fly 150 (4T) LX 150 (4T) Hexagon LX 180 Hexagon LXT 180 Hexagon LX4 125 Super Hexagon GTX 125/180 Zip 125 Hexagon GT 250 Super Hexagon GTX 250 GILERA Ice 50 DERBI Atlantis 50 (4T) Atlantis 50 (2T/AC) 12"/5 spoke wheels/200mm disc/ 5 bolt From ref. 8G253172 Boulevard 50 (2T) Boulevard 50 (4T) Boulevard 125 (4T) LML Star 125 (2T) Star 125i (4T) Star 125 Deluxe (2T) (Front disc) Star 150 (2T) Star 150 Deluxe (2T) (Front disc) Star 151i (4T) Star 200i (4T) VESPA LX 50 (2T/4T) Primavera 50 (2T) Primavera 50 Touring (2t) Primavera 50 (4T/4V) Primavera 50 Touring (4T/4V) S 50 (2T) S 50 (4T/4V) S 50 Sport (2T) S 50 Sport (4T/4V) Sprint 50 (2T) Sprint 50 (4T/4V) Sprint S 50 (2T) ET2 50 ET4 50 LX 60 (Special Anniversary Model) LX 125 (4T) LX 125 (4T/Serie Speciali) S 125 (4T) S 125 Sport (4T) ET4 125/150 Primavera 125 (4T/3V) Primavera 125 (4T/3V/Non ABS) PX 125 (Disc brake model/2T) PX 125 Touring (Disc brake model) Sprint 125 (4T/3V/Non ABS) Sprint S 125 (4T/3V/ABS) Sprint S 125 (4T/3V/Non ABS) LX 150 (4T/Serie Speciali) Primavera 150 (4T/3V) Primavera 150(4T/3V/Non ABS) PX 150 (Disc brake model) PX 150 Touring (Disc brake model) S 150 Sport (4T) S 150 (4T) Sprint S 150 (4T/3V/ABS) PX 200 (Disc brake model) GILERA DNA 50 Runner VX 125/180 PIAGGIO Super Hexagon GTX 125/180	00-02 07-15 02 05-11 12-15 95-97 96-99 05-09 05-09 98-99 98-99 98-99 00 00-01 98-99 00-02	
	Rear	Solid	200	N/A	Plain	N/A					
	Rear	Solid	200	N/A	Plain	N/A					

DISC BUYERS GUIDE

STREETBIKE DISC BUYERS GUIDE

Disc No.	F/R	Type	Dia. (mm)	Hub Color	Profile	Bobbins	Left Bracket	Right Bracket	Model	Year
MD911D MD911C VR911	Front Front	Solid Solid	180 180	N/A N/A	Plain Vee	N/A N/A			SUZUKI TR 50 SW/SX UG 110 W/SW/Y/SY/SK1 Hokuto/Address AN 125 S/T/V/W/X AN 125 HKK5 UE 125 CTK1	98-00 98-02 95-00 06-08 01-03
MD912D	Front	Solid	161	N/A	Plain	N/A			SUZUKI AH 100 P Address	95-96
MD913D	Front	Solid	170	N/A	Plain	N/A			HONDA CH 250 F/G Spacy	85-86
MD914D MD915D VR915	Front Front Front	Solid Solid Solid	155 155 155	N/A N/A N/A	Plain Plain Vee	N/A N/A N/A			PEUGEOT Scooter with Grimeca wheels discs attached with countersunk bolts Ludix Snake/Bullet/Trend 50cc MALAGUTI F10 Jet Line F10 Jet Line WAP F10 Tribal Yesterday	04 96-07 06-10 08-10 98-03
MD916D	Front	Solid	180	N/A	Plain	N/A			YAMAHA BWS 50 Original BW's 50 Naked (1D11/2B71) BW's 50 Naked (2B7B/D/F/H) BW's 50 (5WW1) BW's 50 (5WW4/6/8/9/B/D/F/H/K/M/P) BWs 50 (5WWB-K) CW 50 RS (4YA1/2/BWS) CW 50 RS (4YA4/BWS NG) CW 50 (5WW4/BWS) CW 50 RSP (5CC1/3/4YA BWS Spy) GARELLI FLO 50 MBK CW 50 RS Booster (All models) CW 50 Booster Naked (10" wheels) CW 50 Booster 10" wheels CW 50 Fizz 50 CW 50 Booster (12" wheels) CW 50 Booster Spirit MBK CW 50 Naked Booster (12" wheels) CW 50 Power Rocket	99-02 03-04 09-15 04 05-15 08-11 96-97 98 04-07 97-98 95-06 06-10 09-10 93-97 06-10 09 09-10 06
MD917D	Front	Solid	220	N/A	Plain	N/A			APRILIA Scarabeo 50	93-97
MD918D	Front	Solid	220	N/A	Plain	N/A			HONDA SH 50 T/X/W/X/Y/1 'Fifty /Scoopy' SH 100 T/W/X/Y/1 Scoopy UX 125 K8/K9 SIXteen UX 150 K8/K9 SIXteen	97-03 96-01 08-10 08-10
MD919D	Front	Solid	160	N/A	Plain	N/A			HONDA SK 50 MM-II/MM-YD/MN-II/MP-II (AF28) Dio SR SK 50 MN-III/MP-III/MP-IV (AF28) Dio ZX SK 50 MMR-II/MMT-II (AF28) Dio XR	
MD920D VR920	Front Front	Solid Solid	220 220	N/A N/A	Plain Vee	N/A N/A			HONDA SZX 50 Super Sport Scooter X8R-SW/SX/SY/S1 SZX 50 XW Cross Sport X8R-XW/XX/XY/X1	98-04 98-04
MD921D VR921	Rear Rear	Solid Solid	190 190	N/A N/A	Plain Vee	N/A N/A			HONDA SZX 50 SW X8R-SW/SX/SY/S1 'Super Sport Scooter' SZX 50 XW X8R-XW/XX/XY/X1 'Cross Sport'	98-04 98-04
MD922D VR922	F & R F & R	Solid Solid	240 240	N/A N/A	Plain Vee	N/A N/A			HONDA FES 125W/Y/1-5 'Pantheon' FES 125 7/9/A/B S-Wing (Non ABS) FES 125 A7/A9/AA/AB S-Wing (ABS) SH 125 1/3 Carb SH 125i 9 A/B Fuel Injection SH 125i D9 Fuel Injection SH 125i R8 Fuel Injection SH 125i RA	98-06 07-13 07-15 01-03 09-12 09 08 10-14

STREETBIKE DISC BUYERS GUIDE

Disc No.	F/R	Type	Dia. (mm)	Hub Color	Profile	Bobbins	Left Bracket	Right Bracket	Model	Year
MD922D VR922 Contd.	F & R F & R	Solid Solid	240 240	N/A N/A	Plain Vee	N/A N/A			HONDA Contd. SH 125i S7/S8 Fuel Injection SH 125i (2 piston caliper/ABS) SH 125i (3 Piston Caliper/ABS) FES 150 W/Y/1/2/3/4/5 Pantheon FES 150 A7/A9/A (S-Wing) ABS FES 150 7/9/AA S-Wing SH 150 1/3 Carb SH 150i 9/A/B Fuel Injection SH 150i D9 Fuel Injection SH 150i R8 Fuel Injection SH 150i S7/S8 Fuel Injection SH 150 RA SH 150i (2 piston caliper/ABS) SH 150i (3 Piston Caliper/ABS) FES 250 W/X/Y/1/2/5 'Foresight' NSS 250 Y/AY/1/A1/A3/3 Forza/Forza-S/Forza-T/Forza-ST/Jazz/Reflex (MF04/MF06) NSS 250 EX5/EX6/EX8 Forza EX (ABS) NSS 250 AX5/AX6 (Forza Z) (ABS) NSS 250 X5/X7/X8 Forza PS 250 5/6 Big Ruckus PEUGEOT SV 250	07-08 14-21 14-16 98-06 07-13 07-13 01-03 09-12 09 08 07-08 10-14 14-20 14-16 98-05 00-04 05-06 05-08 05-08 05-06 01-02
MD923D VR923	F & R F & R	Solid Solid	190 190	N/A N/A	Plain Vee	N/A N/A			YAMAHA Aerox 50 2T All Models CW 50 RS CW 50 RS CW 50 RS CW 50 NS 50 Aerox (2T) NS 50 N Aerox Naked (2T) NS 50 F Aerox 4 (4T) YQ 50 Aerox R/Aerox Aerox 4 (NS 50 F) YQ 100 "Aerox 100" EW 50 "Slider" BWS 50 Next Generation ADLY Thunderbike 125 Predator 50/100 ADLY SS 50/100 Supersonic SS 125 B/D Supersonic BEELINE Veloce 50 Veloce GT 50 BRANSON BS 50 Cuba BS 50 Sting BSM TB 100 TB 125 FT 125 CPI Baby J 50 Popcorn 50 Oliver 50 (All models) Mars 50 Hussar 50 GARELLI FX 50 KRS 50 Freeland 125/150 GENERIC/KSR Cracker 50 (2T/4T) Roc50 XOR 50 (2T) Ideo 50 Sirion 50 (2T/4T) Sirion 125 (4T) XOR 125 HONDA NCX 50 E/G/J - Dunk 50 SJ 50 P/R/S/T/W/X 'Bali'	97-16 99 00 01-05 02 13-16 13-16 13-18 97-12 14-16 00-04 00-05 99-07 04-05 04-05 08-10 08-10 08 08 02 02-06 03-12 01-02 01-06 09-18 08-11 05-14 05-14 12-18 12-18 05-11 14-17 93-99

STREETBIKE DISC BUYERS GUIDE

Disc No.	F/R	Type	Dia. (mm)	Hub Color	Profile	Bobbins	Left Bracket	Right Bracket	Model	Year
MD923D VR923 Contd.	F & R	Solid	190	N/A	Plain	N/A			HONDA	
	F & R	Solid	190	N/A	Vee	N/A			SJ 100 T/W/X 'Bali Ex' SCV 110 Lead (NHX 110 WH8 3 bolt disc fixing)	96-99 08-09
									MASH	
									Bibop 50	14-16
									Bibop Racing 50	14-16
									Sixty Five 125	13-15
									MBK	
									Nitro	98-01
									CW 50 RS Booster NG	01-06
									EW 50 Stunt	00-06
									EW 50 Stunt Naked	05-10
									YQ 50 Nitro	97-09
									YQ 50 Nitro Naked	06-09
									YQ 100 Nitro	01-03
									MOTOROMA	
									Grand Prix 50/100	99-03
									Grand Prix 125	02
									PGO	
									PMX 50	00-07
									T-Rex 50	99-12
									Bubu 100/125	03-08
									PMX 110	00-07
									T-Rex 110	99-06
									Charge 125 A/B	01-02
									Ligero 125	06-08
									T/Rex 125	99-07
									SINNIS	
									LJ 50 QT-H	12-14
									WY 50 QT-39A Ghost	06-10
									SYM	
									Fiddle II 50	08-15
									Fiddle III 50	14-21
									Orbit 50	08-09
									Symply 50	07-08
									Symply II 50	09-14
									Allo 125 (4T)	11-15
									Fiddle II 125	08-15
									Symply 125	07-08
									Symply II 125	09-14
									Orbit 11/Symply 125 (4T)	09-15
									TGB	
									City 50cc (2T)	07-08
									City 50cc (4T)	07-11
									Delivery 50 Scooter	04-06
									Delivery/Express 50	06-12
									TGB	
									Akros Tec -50	03-04
									High Wheel 50	02-03
									Trigger 50	02-03
									101R (50cc)	04-09
									202 Classic (50cc)	03-14
									303R Hawk/Laser (50cc)	04-14
									303 Revolution (50/125cc)	02-03
									F409 Cruise 50/125	02-05
									309RS 50	02-03
MD924D MD924C VR924	Front	Solid	220	N/A	Plain	N/A			PIAGGIO	
	Front	Solid	220	N/A	Vee	N/A			NRG 50 Extreme NRG 50 DT MC3 NRG 50 MC3 DD Skipper LX 125/150 Skipper ST 125/150 4T	99-01 01-05 01-05 98-99 00-04
									BENELLI	
									Adiva 125/150	00
									APRILIA	
									Sport City One 50 (4T)	08-09
									Sport City One 50 (2T)	08-11
									SR 50 Motard (2T)	12-15
									SR 50 Motard (4T/4V)	13-15
									Sport City One 125cc	08-11
									SR 125 Motard (4T)	12-15
									DERBI	
									Vibrant Sport 50 (2T)	12
									Boulevard 125	03-07
									Vibrant Sport 125 (4T)	12

STREETBIKE DISC BUYERS GUIDE

Disc No.	F/R	Type	Dia. (mm)	Hub Color	Profile	Bobbins	Left Bracket	Right Bracket	Model	Year
MD924D MD924C VR924 Contd.	Front Front	Solid Solid	220 220	N/A N/A	Plain Vee	N/A N/A			DERBI Contd. Boulevard 150 Boulevard 200 GILERA 50 DD/SP Runner/Purejet 125 VX 4T/180 VXR 4T FX/FXR 125/180 Runner VXR 200 Runner (4T) BETA Eikon 125/150	03-07 05 98-05 01-04 97-02 02-04 00-06
MD925D MD925C VR925	F & R F & R F & R	Solid Solid Solid	180 180 180	N/A N/A N/A	Plain Contour Vee	N/A N/A N/A			LEXMOTO FMR 50 (WY50QT-58R) FMR 125 (WY125T-74R) FMR 125 EFI (WY125T-74R-E4) Matador 125 (ZS125T-40) PEUGEOT Elyseo 50 Elystar 50 Advantage Speedfight 50 1/2 (L/C) Speedfight 50 1/2 (Air Cooled) Elyseo 100 Speedfight 100 1/2 (L/C)	15-18 14-18 14-18 13-17 03 02-07 97-08 97-08 03 97-09
MD926D	Rear	Solid	160	N/A	Plain	N/A			KYMCO Sniper 50 DD Heroism 150 (SE30AD)	94-96 95-97
MD927D VR927	Rear Rear	Solid Solid	230 230	N/A N/A	Plain Vee	N/A N/A			YAMAHA YP 250 Majesty MBK YP 250 Skyliner	98-99 98-99
MD928D	Front	Solid	220	N/A	Plain	N/A			YAMAHA YH 50 'Why' MBK YH 50 Flipper	99-09 98-10
MD929D MD929C VR929	Front Front	Solid Solid	260 260	N/A N/A	Plain Vee	N/A N/A			SUZUKI AN 250 K1/K2 Burgman/Skywave AN 250 W/X/Y Burgman/Skywave AN 400 X/Y/K1/K2 Burgman/Skywave KAWASAKI SC 250 A1 (Epsilon 250)	01-02 98-02 99-02 02
MD930D VR930	Rear Rear	Solid Solid	210 210	N/A N/A	Plain Vee	N/A N/A			SUZUKI AN 250 K1/K2 Burgman/Skywave AN 250 W/X/Y Burgman/Skywave AN 400 X/Y/K1/K2 Burgman/Skywave SC 250 A1 (Epsilon 250)	01-02 98-02 99-02 02
MD931D VR931	Front Front	Solid Solid	190 190	N/A N/A	Plain Vee	N/A N/A			HONDA SGX 50 V/W/X/Y/1 'Sky' SRX 50 T/W/X	97-03 97-99
MD932D MD932C VR932	F & R F & R	Solid Solid	175 175	N/A N/A	Plain Vee	N/A N/A			GILERA 50 DD/SP 'Runner/Purejet' Runner 50 PJ/SP Stalker 50 DERBI GP1 50 Open GP1 50cc PIAGGIO NRG 50 RST (DD/DT) MC2 NRG 50 Extreme NRG 50 MC3 DD NRG 50 Power DD NRG 50 Pure Jet NRG 50 Silver Bullet Zip 50 (2T) Zip 50 (4T) Zip 100 Zip 125	98-05 06-14 97-06 06-11 01-03 98 99-01 01-05 05-21 06-09 10 00-15 00-15 06-10 02-04

STREETBIKE DISC BUYERS GUIDE

Disc No.	F/R	Type	Dia. (mm)	Hub Color	Profile	Bobbins	Left Bracket	Right Bracket	Model	Year
MD933D VR933	Front Front	Solid Solid	160 160	N/A N/A	Plain Vee	N/A N/A			CAGIVA City 50 KYMCO Agility 50 R10 (4T) CX 50 Super (PR 50 AC) DJW 50 World (PR50AD) Heroism 50 KB 50 (SE10CA) K12 Sport 50 (SE10CA) Sniper 50 (PR 50 B) Sniper 50 DD (PR 50 BB) KB 100 Manboy Heroism 125 (SE25BA) Heroism 150 (SE30AD) SYM Cinderella 50/100 City Hopper 50 Mio 50/100 Super Fancy 50 Attila 125 Megalo 125 Super Duke 125/150 E-Virid (Electric) Deluxe E W00 Elettrico E-Symmetry (Electric)	91-94 06-07 94-97 95-97 95-00 95-00 95-00 93 94-96 97-00 95-97 95-97 99-00 96-06 05-20 96-06 99-00 00-07 99-02 12-15 11 12-13
MD934D	Front	Solid	220	N/A	Plain	N/A			SUZUKI UC 125 KAWASAKI SC 150 A1 (Epsilon 150)	99-02 02
MD935D	Front	Solid	155	N/A	Plain	N/A			APRILIA Sonic (All models)	98-08
MD936D VR936	Front Front	Solid Solid	190	N/A N/A	Plain Vee	N/A N/A			APRILIA Area 51 F69 Phantom 70cc	98-02 98
MD937D	Front	Solid	180	N/A	Plain	N/A			SUZUKI AP 50 R/S/T/W/W	96-02
MD938D VR938	Front Front	Solid Solid	180 180	N/A N/A	Plain Vee	N/A N/A			SUZUKI AY 50 V/W/WV/WX/WY/WRW/WRX/WRY/WRK1/ WRK2/WRK3/K1/K2/K3/K4/WRK4/AK5 'Katana' UF 50 Y UX 50 WX/WY	97-05 00-02 99-02
MD939D	Front	Solid	146	N/A	Plain	N/A			SUZUKI AH 80 Address AH 100 Address PGO Galaxy 50	92-94 92-94 94-
MD940D VR940	Rear Rear	Solid Solid	190 190	N/A N/A	Plain Vee	N/A N/A			SUZUKI AY 50 WRX/WX/WRY/WY/WRK1/WRK3/WRK4/AK5 'Katana'	99-05
MD941D VR941	Front Front	Solid Solid	175 175	N/A N/A	Plain Vee	N/A N/A			ITALJET Dragster 50LC Formula 50 LC Formula Air 50 Dragster 125/180 LC Dragster 250 Formula 125 LC (2T/Twin Cyl)	98-12 96-03 99-03 99-12 07-09 96-03
MD942D VR942	Front Front	Solid Solid	220 220	N/A N/A	Plain Vee	N/A N/A			APRILIA Leonardo 125/150 ST/SP Leonardo 125 Leonardo 250 ST/SP Scarabeo 125/150/GT Leonardo 300	96-04 05-06 00-04 99-04 05-06
MD942D VR942	Rear Rear	Solid Solid	220 220	N/A N/A	Plain Vee	N/A N/A			APRILIA Scarabeo 125/250/GT Scarabeo 125/200 Scarabeo 125/150 Sport City 125	04-06 03 99-02 04-08

STREETBIKE DISC BUYERS GUIDE

Disc No.	F/R	Type	Dia. (mm)	Hub Color	Profile	Bobbins	Left Bracket	Right Bracket	Model	Year
MD942D VR942 Contd.	Rear Rear	Solid Solid	220 220	N/A N/A	Plain Vee	N/A N/A			APRILIA Contd. Sport City Cube 125 Sport City 200 Sport City Cube 200 Sport City 250 ie Sport City Cube 250 Sport City Cube 300 Sport City Cube 300 Blackline DERBI Boulevard S125 Rambla 125 Rambla 250 i Rambla 300i	08-12 04-08 08-09 06-08 08-09 08-12 11 07 08-12 08-09 10-12
MD943D MD943C VR943	Front Front Front	Solid Solid Solid	190 190 190	N/A N/A N/A	Plain Contour Vee	N/A N/A N/A			APRILIA Rally A/C & L/C Gulliver (All models) Habana 50 (All models) Mojito Custom 50 Mojito Retro 50 SR 50 Ditech (LC) (RLD100) SR 50 WWW (A/C) (LYHoo) SR 50 Street (LC/2T) (TE00/TEA00) SR 50 R/Factory (LC/2T) SR 50 H20 (Ditech) SR 50 (A/C/L/C) SR 50 Stealth/Racing (LC) SR 50 R (SBK Alitalia (Replica) (LC) Habana 125 (All models) SR 125/150 Mojito/Mojito Custom 125 GILERA SKP 50 Storm 50 KREIDLER 50 Florett City (50cc/2T/A-C) 50 Florett 2.1 RS (50cc/2T/A-C) MBK CS 50 Mach G AC (Air cooled) CS 50 Mach G LC (Liquid cooled) YN 50 R Ovetto (2T) YN 50 Ovetto (4T) YN 100 Ovetto PIAGGIO Diesis 50 NRG 50 NTT 50 NRG 50 RST (DT/DD) MC2 Diesis 100 YAMAHA CS 50 Jog R CS 50 Z Jog RR YN 50 Neos YN 50 F Neos (4T) (5C3) YN 50 Neos (2T) (IF5C2/IH5C2) YN 50 R Neos YN 100 "Neos 100"	95-02 95-98 99-02 99-12 99-03 02-03 97-01 03-15 04-18 00-03 93-96 97-99 10-11 00-02 99-02 03-12 98-01 94-95 14-15 14-15 02-10 03-10 98-10 09-10 99-03 01-05 94-96 95-96 96-98 01-03 02-15 03-12 02-06 09-16 07-16 97-02 99-03
MD943D MD943C VR943	Rear Rear Rear	Solid Solid Solid	190 190 190	N/A N/A N/A	Plain Contour Vee	N/A N/A N/A			APRILIA SR 50 Ditech (LC) (RLD100) SR 50 H20 (Ditech) Scarabeo 50 (2T) Scarabeo Classic (2T) Scarabeo 50 (Ditech) (2T) (SCA00) Area 51 Rally 50 L/C SR 50 Stealth/Racing (LC) Leonardo 125/150 ST/SP BENELLI 491 (All rear disc models) 50cc	02-03 00-03 98-05 98-99 02-06 98-02 96-00 97-99 96-04 99-04
MD944D VR944	Front Front	Solid Solid	240 240	N/A N/A	Plain Vee	N/A N/A			GILERA DNA 50 DNA 125/180	01-06 01-05

STREETBIKE DISC BUYERS GUIDE

Disc No.	F/R	Type	Dia. (mm)	Hub Color	Profile	Bobbins	Left Bracket	Right Bracket	Model	Year
MD944D VR944	Rear Rear	Solid Solid	240 240	N/A N/A	Plain Vee	N/A N/A			GILERA Runner 125/180 All models DNA 125/180 DERBI GP1 125cc Scooter Full height seat/5 bolt fixing front disc GP2 250cc Scooter	99-02 01-03 06 06-07
MD945D VR945	Front Front	Solid Solid	220 220	N/A N/A	Plain Vee	N/A N/A			APRILIA Scarabeo 50 (2T) Scarabeo 50 Street (2T) Scarabeo 50 (Ditech) (2T) (SCA00) Scarabeo 50 (4T/4V) Scarabeo 50 (4T) Scarabeo 100 (2T) Scarabeo 100 (4T) 50 Street (2T) 50 Net (4T/4V) 50 (4T/4V) 50 YourZ (4T) 100 (4T)	98-05 05-10 02-06 02-09 14-17 00 01-09 10-15 10-11 10-15 10-11 10-15
MD946D	Front	Solid	200	N/A	Plain	N/A			MALAGUTI Phantom F12 (L/C) F12 50 Phantom F12 Phantom (Air cooled) F15 Firefox (L/C) Firefox F15 (Air cooled) CIAK (Electric Power)	00-08 99-03 02-08 01-08 99-08 00-05
MD946D	Rear	Solid	200	N/A	Plain	N/A			MALAGUTI F18 Warrior 125/150	00-03
MD947D VR947	Front Front	Solid Solid	226 226	N/A N/A	Plain Vee	N/A N/A			PEUGEOT Elystar 50 TDSI Elystar 50 Advantage Elyseo 100 Elyseo 125/150	02-07 02-07 98-03 98-01
MD948D	Rear	Solid	190	N/A	Plain	N/A			ITALJET Dragster 50 LC	98-12
MD949D	Rear	Solid	240	N/A	Plain	N/A			ITALJET Dragster 125/180 LC Dragster 250	00-12 07-09
MD950D	Rear	Solid	175	N/A	Plain	N/A			ITALJET Formula 50 Formula 125 LC (2T/Twin Cyl)	96-03 96-03
MD951D	Front	Solid	220	N/A	Plain	N/A			ITALJET Torpedo 50 All models Torpedo 125 4T	98-03 99-09
MD952D VR952	Front Front	Solid Solid	260 260	N/A N/A	Plain Vee	N/A N/A			APRILIA Scarabeo 125/150/GT Scarabeo 125/150/200 Sport City 125/200 Sport City Cube 125 Sport City Cube 200 Scarabeo 250 Scarabeo 250 ie Sport City 250 ie Sport City Cube 250 Sport City Cube 300 Sport City Cube 300 Blackline Scarabeo 400 ie Atlantic 500 Scarabeo 500/500 ABS Scarabeo 500 Light Scarabeo 500 ie DERBI Boulevard S125 Rambla 125 Rambla 250 i Rambla 300i	04-06 99-10 04-08 08-12 08-09 06 07-10 06-08 08-09 08-12 11 07-08 02-07 03-06 06 07-09 07 08-12 08-09 10-12

STREETBIKE DISC BUYERS GUIDE

Disc No.	F/R	Type	Dia. (mm)	Hub Color	Profile	Bobbins	Left Bracket	Right Bracket	Model	Year
MD952D VR952	Front Front	Solid Solid	260 260	N/A N/A	Plain Vee	N/A N/A			SCARABEO 300 S ie 500 ie	09-12 10-12
MD953D VR953	Rear Rear	Solid Solid	230 230	N/A N/A	Plain Vee	N/A N/A			ITALJET Jupiter 125/150/250 MBK YP 250 Skyliner YAMAHA YP 250 Majesty	02-03 00-02 00-03
MD954D VR954	Front Front	Solid Solid	226 226	N/A N/A	Plain Vee	N/A N/A			PEUGEOT LooXoR 50 LooXoR 100 (All models) LooXoR 125/150	01-06 01-04 03-06
MD955D	Front	Solid	230	N/A	Plain	N/A			MALAGUTI Ciak 50 Ciak 50 (4T) Master Ciak 100 Ciak 125/150 Ciak 200	00-04 04-08 99-03 01-08 06-08
MD956D VR956	Front Front	Solid Solid	220 220	N/A N/A	Plain Vee	N/A N/A			PIAGGIO Liberty Elettrico Liberty 50 2T/50 4T Liberty S 50 (2T/4T) NRG 50 DD Power NRG 50 DT Power NRG 50 Purejet NRG 50 Silver Bullet Liberty 125 (5 spoke wheel) Liberty S 125 Liberty 150 Liberty 200 Liberty S 200 BENELLI Pepe 50 2T (7 Spoke Cast Wheel) Pepe 50 2T (5 spoke cast wheel) Pepe 50 4T (7 spoke cast wheel) Pepe LX 50 (2T) (7 spoke cast wheel) Pepe Classic 50 (2T) (7 spoke cast wheel) DERBI GP1 50 Open GILERA Runner 50 PJ/SP VESPA LXV 50 GT 125 Granturismo GTS 125 GTS 125 Super ie (Inc ABS Models) VESPA GTS 125 Supersport ie (Inc ABS Models) GTV 125 LXV 125 GT 200 L Granturismo GTS 250 iE/ABS GT 60 (Special Anniversary Model) (GTV 250) GTV 250 ie GTS 300 ie (Non ABS Models) GTS 300 ie (ABS Models) GTS 300 ie Super (Non ABS Models) GTS 300 ie Super (ABS Models) GTS 300 ie Super Sport (Non ABS Models) GTS 300 ie Super Sport (ABS Models) GTS 300 ie Touring (Non ABS Models) GTS 300 ie Touring (ABS Models) GTV 300	11-12 97-08 07-08 05-21 05-13 04-10 10 98-08 07-08 08 98-07 07-08 99-01 10-14 12-16 03-09 07-14 06-11 06-14 07-09 03-06 07-11 10-21 13-15 07-09 07-12 03-06 05-11 06 07-09 08-15 08-21 08-15 08-21 08-15 08-21 11-16 11-21 10-13
MD956D	Rear	Solid	220	N/A	Plain	N/A			PIAGGIO Super Hexagon GTX 125/180 (12" wheels) New Fly 125 ie (3V) Fly 125 (4T/3V) Rear Disc Model DERBI GP1 125cc Racing Low seat/radial caliper/6 bolt disc fixing GP1 250icc Racing Low seat/radial caliper/6 bolt disc fixing	01-03 12-13 12-15 07-09 07-09

DISC BUYERS GUIDE

STREETBIKE DISC BUYERS GUIDE

Disc No.	F/R	Type	Dia. (mm)	Hub Color	Profile	Bobbins	Left Bracket	Right Bracket	Model	Year
MD956D Contd.	Rear	Solid	220	N/A	Plain	N/A			GILERA VX 125 Runner/ST (4T) VX 200 Runner (4T) VX 200 Runner/ST (4T) VESPA GT 125 Granturismo GTS 125 GTS 125 Super ie GTS 125 Supersport GTV 125 GT 200 L Granturismo GTS 250 ie/ABS GT 60 (Special Anniversary Model) (GTV 250) GTV 250 ie GTS 300 ie (Non ABS Models) GTS 300 ie (ABS Models) GTS 300 ie Super (Non ABS Models) GTS 300 ie Super (ABS Models) GTS 300 ie Super Sport (Non ABS Models) GTS 300 ie Super Sport (ABS Models) GTS 300 ie Touring (Non ABS Models) GTS 300 ie Touring (ABS Models) GTV 300	05-14 02-04 05-11 03-06 07-11 10-20 13-15 07-09 03-06 05-11 06 07-09 08-15 08-20 08-15 08-20 08-15 08-18 11-16 11-17 10-13
MD957D VR957	Front Front	Solid Solid	245 245	N/A N/A	Plain Vee	N/A N/A			MBK XQ 125/150 Thunder YAMAHA XQ 125/150 Maxster	01-03 01-03
MD958D VR958	Rear Rear	Solid Solid	220 220	N/A N/A	Plain Vee	N/A N/A			MBK XQ 125/150 Thunder YAMAHA XQ 125/150 Maxster	01-03 01-03
MD959D VR959	Front Front	Solid Solid	240 240	N/A N/A	Plain Vee	N/A N/A			PIAGGIO Liberty 125 (4T) 10 Spoke Cast Wheel X9 125 X9 125 Evolution Liberty 50 (2T/4T) X9 200 X9 200 Evolution X9 250/250 SL X9 250 X9 180 Amalfi Xevo 400 ie	09-12 00-02 03-07 09-14 02-03 03-04 00-04 05-06 00-03 07-10
MD959D VR959	Rear Rear	Solid Solid	240 240	N/A N/A	Plain Vee	N/A N/A			X9 125 X9 125 Evolution X9 200 X9 200 Evolution X9 250/250 SL X9 250 X9 180 Amalfi Beverley Tourer 400 ie	00-02 03-07 02-03 03-04 00-04 05-06 00-03 08-09
MD960D VR960	F & R F & R	Solid Solid	240 240	N/A N/A	Plain Vee	N/A N/A			PIAGGIO 125 ie MP3 Yourban MP3 125 (Carb models) MP3 Hybrid (125cc) MP3 125 ie (EFI Models) X7 125cc X7 Evo 125 ie (EFI) X8 125 X8 125 ie Xevo 125 X8 200 MP3 250 MIC/EFI MP3 250cc (EFI) MP3 LT 250 ie (EFI) Xevo 250 ie X7 250 ie X8 250 ie X9 250 300 ie MP3 Yourban MP3 Yourban Sport 300ie MP3 Yourban LT RL 300	11-12 06-08 09-12 08-11 08-09 09-12 04-06 07 07-16 04-05 08-09 06-08 06-08 09 07-10 08-09 05-07 04 11-16 11-16 17-18

DISC BUYERS GUIDE

STREETBIKE DISC BUYERS GUIDE

Disc No.	F/R	Type	Dia. (mm)	Hub Color	Profile	Bobbins	Left Bracket	Right Bracket	Model	Year
MD960D VR960	F & R	Solid	240	N/A	Plain	N/A			PIAGGIO Contd.	
	F & R	Solid	240	N/A	Vee	N/A			MP3 LT 300 ie	10
									MP3 Hybrid 300 ie	11-15
									MP3 Hybrid LT 300 ie	11-12
									MP3 Business LT 300 ie	13
									MP3 Touring 300 ie	11-12
									MP3 Touring LT 300 ie	11-12
									MP3 Sport LT 300 ie	13
									MP3 Sport LT 300 ie ABS (13" Front Wheel/ 14" Rear Wheel)	14-18
									MP3 Business LT 300 ie ABS (13" Front Wheel/ 14" Rear Wheel)	14-18
									X7 300 Evo	10-12
									Beverly 400 ie	07
									MP3 400 ie	07-10
									MP3 LT 400 ie	09-10
									MP3 Touring 400 ie	11-12
									MP3 Touring LT 400 ie	11-12
									Xevo 400 ie	07-10
									X8 400 ie	06-08
									Beverly 500 ie	12
									MP3 500 EFI	09-10
									MP3 500 LT Business	11-15
									MP3 Touring Business 500 ie	11-12
									MP3 500 LT Business ABS (13" Front Wheel/ 14" Rear Wheel)	14-20
									MP3 500 LT Sport ABS (13" Front Wheel/ 14" Rear Wheel)	14-21
									MP3 Touring Sport 500 ie	11-12
									MP3 500 LT Sport	11-15
									X9 500/500 SL	00-02
									X9 500cc Evolution	03-06
									X9 500 ie	07
									Super Hexagon GTX 125/180 (12" wheels)	01-03
									Beverly B 500	02-05
									Beverly 500	06
									Beverly Cruiser 500 ie	07-11
									GILERA	
									Nexus 125	07-12
									Nexus 250 ie	07
									Nexus 300 i	08-12
									Fuoco 500 RC/ie	07-13
									Fuoco 500 LT (4V/4T)	13-15
									Nexus 500 / SP	03-12
									SCARABEO	
									125 ie	10-15
									125 Net	10-11
									200 ie	10-15
									200 Net	10-11
									APRILIA	
									SR 125 Max (4T)	11-15
								SR 300 Max (4T)	11-15	
MD961D VR961	Front	Solid	260	N/A	Plain	N/A			PIAGGIO	
	Front	Solid	260	N/A	Vee	N/A			Beverly B125/200	02-06
									Beverly 125	07
									Beverly S 125	07
									Beverly Tourer 125	08
									Carnaby 125	07-09
									X8 125 ie/Street	07
									X8 150 Street	07
									Carnaby 200	07-09
									Beverly Cruiser 250 ie	07-08
									Beverly 250 (Carb)	04-07
									Beverly 250 ie	06-07
									Beverly S 250 ie	07
									Beverly Tourer 250 ie	08
									Carnaby 250 ie	08-09
									X8 250 ie	07
									Carnaby 300 ie	12
									Carnaby Cruiser 300	08-11
									Beverly 400 ie	07
									Beverly Tourer 400 ie	08
									X8 400 ie	06-08
								X9 500/500 SL	00-02	
								X9 500 ie	07	

STREETBIKE DISC BUYERS GUIDE

Disc No.	F/R	Type	Dia. (mm)	Hub Color	Profile	Bobbins	Left Bracket	Right Bracket	Model	Year
MD961D VR961	Rear Rear	Solid Solid	260 260	N/A N/A	Plain Vee	N/A N/A			Beverley B500 Beverley 500 Beverly 500 ie Beverley Cruiser 500 ie Beverley B125/200 Beverley 125 Beverley S 125 Beverley Tourer 125 Carnaby 125 Carnaby 200 Beverley Cruiser 250 ie Beverley 250 (Carb) Beverley 250 ie Beverley S 250 ie Beverley Tourer 250 ie Carnaby 250 ie Carnaby 300 ie Carnaby Cruiser 300 MP3 Touring 300 ie MP3 Touring LT 300 ie MP3 Yourban LT 300 ie Beverley 400 ie MP3 Touring 400 ie MP3 Touring 400 ie LT MP3 Touring Business 500 ie MP3 Touring Business LT 500 ie MP3 Touring Sport 500 ie MP3 Touring Sport LT 500 ie GILERA Nexus 250 ie	02-05 06 12 07-11 02-05 07 07 08-09 07-09 07-09 07-08 04-07 06-07 07 08-09 08-09 12 08-11 11-12 11-12 11-12 11-12 11-12 11-12 11-12 11-12 11-12 11-12 11-12 07-08
MD962D VR962	Rear Rear	Solid Solid	190 190	N/A N/A	Plain Vee	N/A N/A			MBK YP 125 D Skyliner YAMAHA YP 125 Majesty	01-10 01-09
MD963D	Front	Solid	220	N/A	Plain	N/A			YAMAHA T 105 E (5ER 1/2) Crypton-R T 105 SE V 110 ZE/ZK/ZHE/ZHK/FIZR/FIZR Sporty AT 115 T 135 HC/S T 135-SE	99 02 05-08 06-08 06-08
MD964D	Front	Solid	190	N/A	Plain	N/A			DERBI Hunter Atlantis 50 (AC/2T) Atlantis 50 (AC/2T) Atlantis 50 Bullet (AC/2T) DERBI Atlantis 50 City (AC/2T) Atlantis 50 Red Bullet (AC/2T) Atlantis 50 Two Chic (AC/2T) Atlantis 50 (2T) Up to Ref No 8G253171 12"/5 spoke wheels/190mm disc/3 bolt Atlantis 50 LC (2T) Paddock 50 (AC/2T) Predator 50 (LC/2T) (3 bolt front disc/USD Showa Forks) Predator 50 (AC/2T) Red Bullet 50 Atlantis 100 (AC/2T) HUSQVARNA WRS 50 Scooter	96-99 99-01 02 03-05 03-06 03 05 07 99-01 98-99 98-03 98-01 04-05 00-01 98-00
MD964D	Rear	Solid	190	N/A	Plain	N/A			DERBI Predator 50 (LC/2T) (5 bolt front disc/STD Paioli Forks)	98-03
MD965D	Front	Solid	155	N/A	Plain	N/A			YAMAHA CV 50 ZR (5PT1) Evolution CV 50 (5KN1/2) Jog-Cool Style CV 50 A/R Jog (SSU2/1/SA165)	01-02 00-02 03-08

STREETBIKE DISC BUYERS GUIDE

Disc No.	F/R	Type	Dia. (mm)	Hub Color	Profile	Bobbins	Left Bracket	Right Bracket	Model	Year
MD966D VR966	Front Front	Solid Solid	220 220	N/A N/A	Plain Vee	N/A N/A			MALAGUTI 125/150/180 Phantom Max 125/200 R 125 Madison Madison S 200 250 Madison Phantom Max 250	99-02 04-08 03-07 04 04-07 04-08
MD966D VR966	Rear Rear	Solid Solid	220 220	N/A N/A	Plain Vee	N/A N/A			BENELLI Velvet 125/150/250 MALAGUTI 250 S Phantom Max 125/200 R 125 Madison Madison S 200 250 Madison Phantom Max 250	99-12 99-03 04-08 03-07 04 05-07 04-08
MD967D	F & R	Solid	240	N/A	Plain	N/A			MALAGUTI Madison S 250 Madison K400	99-03 02-06
MD968D VR968	F & R F & R	Solid Solid	220 220	N/A N/A	Plain Vee	N/A N/A			BMW C1 125/200	99-03
MD969D	Front	Solid	270	N/A	Plain	N/A			MALAGUTI K 400 Madison	02-06
MD970D VR970	Front Front	Solid Solid	220 220	N/A N/A	Plain Vee	N/A N/A			HONDA NES 125 Y/1/2/3/4/5/6 PES 125 6/7/8/9/A (PS 125) PES 125 R8/R9/RA (PS 125) SES 125 2/3/4 Dylan SH 125i 4/5/6/7/8 Fuel Injection (Rear drum) NES 150 Y/1/2/3/4/5/6 PES 150 6/7/8/9 (PS 150) PES 150 R8/R9 (PS 150) SES 150 2/3/4 Dylan SH 150i 4/5/6/7/8 SH 150i R8	00-06 06-10 08-12 02-07 04-08 00-06 06-09 08-09 02-06 04-08 08
MD971D VR971	F & R F & R	Solid Solid	180 180	N/A N/A	Plain Vee	N/A N/A			GENERIC/KSR 50 GT Race Explorer KYMCO Agility 50 (KG 105A) Agility 50 R10 (4T) Agility 50 R12 (4T) Agility City+ 50 (4T) Agility RS 50 (2T/12" wheels) Cobra 50 Cross/Racer Dink 50/Spacer 50/Yager 50 Super 9 50 (L/C) Top Boy 50 (On road/off road models) Vitality 50 (2T/4T) Yager 50 Yup 50 ZX 50 Super Fever/Scout (SC10AS) Maxxer 90 Agility 125 Grand Dink 125/150 Dink Classic 125/150 Dink LX 125/150 Dink 125/150/Spacer Spike 125 R Yager 125 SINNIS Nitro 125 (WY 125 T-56A)	09 05-08 06-14 06-20 18-20 10-15 00-06 98-06 00-06 97-05 04-09 07 02-09 99-06 05-06 06-10 01-02 02 98-00 97-04 04-06 00 09-10
MD972D	Front	Solid	200	N/A	Plain	N/A			KYMCO Movie XL 125/150 Vivio 125/150	99-00 00-03
MD973D VR973	Front Front	Solid Solid	220 220	N/A N/A	Plain Vee	N/A N/A			KYMCO Bet & Win 50/Dink Sport 50 Grand Dink 50 (2T) Bet & Win 125/150 Grand Dink/Miler 125/150	02-06 04-15 00-06 01-07

STREETBIKE DISC BUYERS GUIDE

Disc No.	F/R	Type	Dia. (mm)	Hub Color	Profile	Bobbins	Left Bracket	Right Bracket	Model	Year
MD973D VR973 Contd.	Front Front	Solid Solid	220 220	N/A N/A	Plain Vee	N/A N/A			KYMCO Contd. Dink Classic 125/150 Dink Classic Euro 2 50 Grand Dink 250 Bet & Win 250 Yup 250 Grand Dink 300i	02 03 01-06 00-06 03-06 12-20
MD974D VR974	Rear Rear	Solid Solid	200 200	N/A N/A	Plain Vee	N/A N/A			KYMCO Bet & Win 125/150 Dink 125i Grand Dink/Miler 125/150 Yager GT 125 Dink 200 i Yager 200 i	00-06 06-15 01-07 07-13 06-15 07-13
MD974D VR974	Rear Rear	Solid Solid	200 200	N/A N/A	Plain Vee	N/A N/A			KYMCO Grand Dink 250 Bet & Win 250 Yup 250	01-06 00-06 03-06
MD975D VR975	Rear Rear	Solid Solid	220 220	N/A N/A	Plain Vee	N/A N/A			SUZUKI UH 125 K2-K6 Burgman	02-06
MD976D MD976C VR976	Front Front	Solid Solid	220 220	N/A N/A	Plain Vee	N/A N/A			SUZUKI UH 125 K2-K6 Burgman	02-06
MD977D	Front	Solid	226	N/A	Plain	N/A			PEUGEOT Elyseo 125/150 Rear Disc Model Elystar 125/150 (3 bolt fixing - front disc)	03 02-05
MD978D VR978	Rear Rear	Solid Solid	210 210	N/A N/A	Plain Vee	N/A N/A			PEUGEOT Elyseo 125/150 Rear Disc Model Elystar 50 TDSI Elystar 125/150 (All models) Elystar 125/150 (3 bolt fixing - front disc) Elystar 125/150 (5 bolt fixing - front disc) Jet Force 125 (All models) Satelis 125 4V Executive/Premium/City Satelis 125 Compressor (4T) Satelis 125 RS Satelis 125 Avenue (Nissin calipers) Satelis 125 Blacksat (AJP Calipers) Satelis RS 125 (AJP Calipers) Satelis Urban 125 (AJP Calipers/ABS)	03 02-07 02-07 02-05 06-07 03-07 06-09 06-11 07-11 08-09 10-11 07-11 07-11
MD979D	Front	Solid	245	N/A	Plain	N/A			YAMAHA YP 125 Majesty DX Taiwan Production	02
MD980D	Front	Solid	226	N/A	Plain	N/A			PEUGEOT Jet Force 125 (All models) Elystar 125/150 (5 bolt fixing - front disc)	03-07 06-07
MD981D VR981	Front Front	Solid Solid	210 210	N/A N/A	Plain Vee	N/A N/A			KYMCO Super 9 50 (AC/LC)	00-07
MD982D	Rear	Solid	165	N/A	Plain	N/A			ADLY 125 Thunderbike	
MD983D VR983	F & R F & R	Solid Solid	260 260	N/A N/A	Plain Vee	N/A N/A			GILERA Coguar 125 Nexus 125 Nexus 300 i Nexus 500 APRILIA SR 125 Max SR 300 Max PIAGGIO X7 125cc X7 Evo 125 ie (EFi) X8 125 Xevo 125 X8 200 Xevo 250 ie X7 250 ie X8 250 ie	99-02 07-12 08-12 03-12 11-15 11-15 08-09 09-12 04-06 07-16 04-05 07-10 08-09 05-06

STREETBIKE DISC BUYERS GUIDE

Disc No.	F/R	Type	Dia. (mm)	Hub Color	Profile	Bobbins	Left Bracket	Right Bracket	Model	Year
MD983D Contd.	F & R	Solid	260	N/A	Plain	N/A			PIAGGIO Contd. X9 250 X7 300 Evo X9 500cc Evolution	04 09-12 03-06
MD984D VR984	Rear Rear	Solid Solid	190 190	N/A N/A	Plain Vee	N/A N/A			PEUGEOT Jet C Tech 50 Jet Darkside 50 (2T) Jet Iceblade 50 (2T) Jet Force 50/Jet-C (All models) TRK2 WRC 50 (2T) Satelis 125 Whitesat (AJP Caliper)	11-12 11 11 03-10 04-06 10-11
MD985D VR985	Front Front	Solid Solid	226 226	N/A N/A	Plain Vee	N/A N/A			PEUGEOT Jet C Tech 50 Jet Darkside 50 (2T) Jet Iceblade 50 (2T) JetForce 50/Jet-C (All models)	11-12 11 11 03-10
MD986D VR986	Front Front	Solid Solid	220 220	N/A N/A	Plain Vee	N/A N/A			NXC 125 Flame X NXC 125 Cygnus X - (5ML) YW 125 (BW's 125) YW 125 Z X-Over	04-06 04-06 10-13 10
MD987D VR987	Front Front	Solid Solid	260 260	N/A N/A	Plain Vee	N/A N/A			SUZUKI AN 650 K3 Burgman/Skywave	03
MD988D VR988	Rear Rear	Solid Solid	250 250	N/A N/A	Plain Vee	N/A N/A			SUZUKI AN 650 K3 Burgman/Skywave	03
MD989D	Front	Solid	226	N/A	Plain	N/A			KYMCO Looker 50 People 50 (2T) Looker 125 S People 125 People 150	07-08 99-14 07-08 99-20 99-04
MD990D VR990	Rear Rear	Solid Solid	220 220	N/A N/A	Plain Vee	N/A N/A			APRILIA Scarabeo 50 (2T) Scarabeo 50 Classic (2T) Leonardo 125 Leonardo 250 Leonardo 300 Atlantic 400 Atlantic Sprint 400 Atlantic 500 Atlantic Sprint 500 Scarabeo 500	93-97 98-99 05-06 99-04 05-06 07 05-08 01-06 05-08 03-05
MD991D	Fron	Solid	190	N/A	Plain	N/A			PEUGEOT Ludix Bullet Ludix Trend DERBI Atlantis 50 (4T) (13"/3 spoke wheels) GP1 50cc Predator 50 (LC/2T) (5 bolt front disc/STD Paioli Forks) Atlantis 100 (4T) (13"/3 spoke wheels)	04-07 04-07 04-06 01-03 98-03 04-06
MD992D VR992	Front Front	Solid Solid	155 155	N/A N/A	Plain Vee	N/A N/A			PEUGEOT Ludix Snake Ludix Acid Ludix Red Zone Ludix Urban Track	04-09 06 06 06-07
MD993D	Front	Solid	190	N/A	Plain	N/A			PEUGEOT Ludix Elegance	04-09
MD994D VR994	Front Front	Solid Solid	260 260	N/A N/A	Plain Vee	N/A N/A			SUZUKI AN 250 Skywave Type M/S AN 250 8 Skywave SS SN 250 K3-K6 Burgman (CJ43A) AN 400 K7/ZK7/K8/ZK8/K9/L0/L1/L2/L3/L4 Burgman/ Non ABS/Skywave AN 400 Skywave/Burgman/ABS AN 650 K4/K5/K6/K7/K8/K9/L0/L1/L2 Burgman/Non ABS AN 650 AK4/AK5/AK6/AK7/AZK8/AK8/AK9//AL0/AL1/ AL2 Burgman/ABS	07-08 08 03-06 07-15 09-20 04-11 04-12

STREETBIKE DISC BUYERS GUIDE

Disc No.	F/R	Type	Dia. (mm)	Hub Color	Profile	Bobbins	Left Bracket	Right Bracket	Model	Year
MD995D VR995	Front Front	Solid Solid	270 270	N/A N/A	Plain Vee	N/A N/A			YAMAHA VP 300 Versity XC 300 Versity XC 300 V Versity VECTRIX XX-1 (Li/NiMh)	03-05 06 06 07-14
MD996D VR996	Rear Rear	Solid Solid	190 190	N/A N/A	Plain Vee	N/A N/A			APRILIA SR 50 Street (LC/2T) SR 50 R/Factory (LC/2T) Atlantic 125 Atlantic 200 Atlantic 250 Atlantic 250 ie Atlantic 300	03-15 04-18 03-08/10 03-05 03-05 06-08 10-11
MD997D VR997	Front Front	Solid Solid	240 240	N/A N/A	Plain Vee	N/A N/A			APRILIA Atlantic 125 Atlantic 200 Atlantic 250 Atlantic 250 ie Atlantic 300 BENELLI Velvet 250	03-08/10 03-05 03-05 06-08 10-11 99-12
MD998D VR998	Rear Rear	Solid Solid	250 250	N/A N/A	Plain Vee	N/A N/A			SUZUKI AN 650 K4/K5/K6/K7/K8/K9/L0/L1 /L2/L3/L4/L5/L6 Burgman/Non ABS AN 650 AK4/AK5/AK6/AK7/AZK8/AK8/AK9/AL0/AL1/ AL2/AL3/AL4/AL5 Burgman/ABS AN 650 ZL3/ZL4/ZL5/ZL6/ZL7/ZL8 Burgman ABS Executive	04-16 04-15 13-18
MD999D	Front	Solid	250	N/A	Plain	N/A			ITALJET Jupiter 125/150 Jupiter 250	02 02-03
MD9100D VR9100	F & R F & R	Solid Solid	260 260	N/A N/A	Plain Vee	N/A N/A			KYMGCO Agility 50 R16 (4T/16" wheels) People S 50 2T (5 bolt fixing) People S 50 (4T) Agility 125 R16 (C20000) (16" wheels) Agility City 125 Agility City+ 125 People S 125 DD Agility 200i R16 People S 200 People S 200i DD People 250 S People 250 (BC 50 AA) People S 300 i	08-15 05-15 06-20 08-15 18-20 18-20 07-20 10-12 05-06 07-15 06-08 03-06 08-10
MD9101D	Front	Solid	220	N/A	Plain	N/A			BENELLI Adiva 125/150 (13" front wheel) Velvet 125/150 Velvet 125/150 (Touring)	01-04 99-07 08-12
MD9102D VR9102	Front Front	Solid Solid	267 267	N/A N/A	Plain Vee	N/A N/A			YAMAHA YP 125 R X-Max YP 125 RA X-MAX ABS (39D2/Nissin F/Caliper) YP 125 R (X-Max Non ABS) (39D1/5) YP 125 X-Max Business (ABS) YP 125 R X-Max Sport YP 125 R X-MAX (2DEM/Brembo R/Caliper) YP 125 R X-MAX (3DM/Heng Tong R/Caliper) X-MAX (2DEM/Brembo R/Caliper) -See YP 125 R X-MAX X-MAX (3DM/Heng Tong R/Caliper) -See YP 125 R X-MAX XP 125 RA X-MAX - IRON MAX (ABS) X-Max 125 Momo Design inc ABS YP 250 R XMax Sport YP 250 R XMax ABS YP 250 R XMax (2PL1) Non ABS Nissin Fr/Brembo R YP250 R X-MAX (Non ABS/Heng Tong R/Caliper/2DL) XP 250 R XMax (ICO) Non ABS XP 250 R XMax (37P) Non ABS X-Max 250 Momo Design X-MAX 250 (2DL/Non ABS/Heng Tong R/Caliper)	06-10 11-17 10-15 11 11-12 14-16 14 14-16 14 16 15 11-12 11-16 14 14-16 05-09 10-13 15

STREETBIKE DISC BUYERS GUIDE

Disc No.	F/R	Type	Dia. (mm)	Hub Color	Profile	Bobbins	Left Bracket	Right Bracket	Model	Year
MD9102D R9102 Contd.	Front Front	Solid Solid	267 267	N/A N/A	Plain Vee	N/A N/A			YAMAHA Contd. -See YP250 R X-MAX XP 250 RA X-MAX - IRON MAX (ABS) YP 400 Majesty MBK YP 125 Skycruiser YP 400 Skyliner	14-16 16 04 06-10 04
MD9103D VR9103	Rear Rear	Solid Solid	267 267	N/A N/A	Plain Vee	N/A N/A			MBK YP 400 Skyliner YAMAHA YP 400 Majesty (Non ABS) YP 400 Majesty (ABS)	04 04-13 07-13
MD9104D VR9104	Rear Rear	Solid Solid	240 240	N/A N/A	Plain Vee	N/A N/A			YAMAHA YP 125 R X-Max YP 125 R (X-Max Non ABS) (39D1/5) VP 125 X-City (16P) YP 125 R X-Max Sport VP 250 X-City (5B2) YP 250 R XMax Sport XP 250 R XMax (ICO) Non ABS XP 250 R XMax (37P) Non ABS VP 300 R/S/T Versity XC 300 Versity MBK VP 300 R Kilibre YP 125 Skycruiser VP 125 City Liner	06-09 10-15 08-15 11-12 07-16 11 05-09 10-13 03-05 06 03-04 06-10 08-10
VR9105	Front	Solid	170	N/A	Vee	N/A			PEUGEOT Ludix Blaster (10" wheels) Ludix 2 Trend 50 (2T/12" wheels) Blaster Ice Blade 50 (2T/12" wheels)	05-09 07-12 10-12
MD9106D	Rear	Solid	220	N/A	Plain	N/A			BENELLI Adiva 125/150	01-04
MD9107D	Front	Solid	245	N/A	Plain	N/A			CP 250 V (IB71) Maxam/Morphus	05-08
MD9108D	Rear	Solid	245	N/A	Plain	N/A			X-Max 125 Momo Design inc ABS YP 125 RA X-MAX ABS (39D2/Nissin F/Caliper) YP 125 X-Max Business (ABS) XP 125 RA X-MAX - IRON MAX (ABS) CP 250 V (IB71) Maxam/Morphus YP 250 R XMax ABS XP 250 RA X-MAX - IRON MAX (ABS)	15 11-17 11 16 05-08 11-16 16
MD9109D VR9109	Rear Rear	Solid Solid	210 210	N/A N/A	Plain Vee	N/A N/A			AN 250 Skywave Type M/S AN 250 8 Skywave SS AN 400 K7/ZK7/K8/ZK8/K9/L0/L1/L2/L3/L4Burgman/ Non ABS/Skywave AN 400 Skywave/Burgman/ABS	07-08 08 07-15 09-20
MD9110D VR9110	Front Front	Solid Solid	240 240	N/A N/A	Plain Vee	N/A N/A			Cucciolo 125	00
MD9111D VR9111	Front Front	Solid Solid	263 263	N/A N/A	Plain Vee	N/A N/A			PEUGEOT Geopolis 125 Executive/Non ABS (AJP Calipers) Geopolis 125 Premium/Non ABS (Nissin Calipers) Geopolis 125 Urban/ABS (AJP Calipers) Geo RS 125 (Nissin Calipers) Satelis 125 Compressor Satelis 125 RS Geo RS 250 (Nissin Caliper) Geopolis 250 (Premium/Nissin Calipers/Non ABS) Geopolis 250 (Urban/AJP Calipers/ABS) Geopolis 250 (Executive/AJP Calipers/Non ABS) Geopolis 300 (Premium/Nissin Calipers/Non ABS) Geopolis 300 (Premium) Geo RS 300 (Nissin Calipers) Geopolis 400 (Premium/Nissin Calipers/Non ABS) Geopolis 400 (Urban/AJP Calipers/ABS) Geo RS 400 (Nissin Calipers) Geopolis 500	07-11 07-11 07-11 07-11 06-11 07-11 07-11 07-11 07-10 07-10 10-11 10-15 10-11 07-11 07-11 07-11 08-11 08-11

STREETBIKE DISC BUYERS GUIDE

Disc No.	F/R	Type	Dia. (mm)	Hub Color	Profile	Bobbins	Left Bracket	Right Bracket	Model	Year
MD9112D VR9112 VR9175	Front Front Front	Solid Solid Solid	240 240 250	N/A N/A N/A	Plain Vee Vee	N/A N/A N/A			GILERA VX 125 Runner ST (4T) VX 200 Runner ST (4T) Fuoco 500 RC/ie Fuoco 500 LT (4V/4T) PIAGGIO 125 ie MP3 Yourban MP3 125 (Carb models) MP3 125 ie (EFI Models) P3 Hybrid (125cc) MP3 250 MIC/EFI MP3 250cc (EFI) MP3 250 LT (EFI) MP3 Business LT 300 ie MP3 Yourban Sport 300 ie MP3 Sport LT 300 ie MP3 300 LT (EFI) MP3 300 ie (Hybrid) MP3 300 ie (Hybrid LT) MP3 Yourban LT 300 ie MP3 Yourban Sport 300ie MP3 Touring 300 ie MP3 Touring LT 300 ie MP3 400 ie MP3 LT 400 IE MP3 Touring 400 ie MP3 Touring LT 400 ie MP3 500 EFI MP3 Touring Business 500 ie MP3 500 LT Business MP3 Touring Sport 500 ie MP3 500 LT Sport	05-14 05-11 07-13 13-15 11-12 06-08 08-11 09-12 08-09 06-08 09 13 13-15 13 10 11-15 11-12 11-16 11-16 11-12 11-12 07-11 09-10 11-12 11-12 09-10 11-12 11-15 11-12 11-12 11-15 11-12 11-15
MD9113D	Front	Solid	245	N/A	Plain	N/A			DERBI GP1 50 Euro 2 Chain driven/radial caliper/5 bolt fixing front disc GP1 50 Race Chain driven/radial caliper/5 bolt fixing front disc GP1 125cc Scooter Full height seat/5 bolt fixing front disc GP1 250cc Scooter	05 05-07 06 06-07
MD9114D	Front	Solid	218	N/A	Plain	N/A			ITALJET Millenium M100/125/150 LC	00-04
MD9115D	F & R	Solid	220	N/A	Plain	N/A			TGB Delivery/Express (125cc) R 50 X Bullet R 125 X Bullet 302 Sport (50cc) 303 R Hawk/Laser (125/150cc) 304 Sport (125cc)	04-14 06-10 08-09 03-09 04-08 03-09
MD9116D VR9116	Front Front	Solid Solid	190 190	N/A N/A	Plain Vee	N/A N/A			SYM Jet Basix 50 Jet 50/Euro X S Jet Euro X 50 Jungle 50/100 Mask 50 Red Devil 50 Jet 100 G100P-6)	06-09 99-05 06-14 99-02 00-05 99-09 99-00
MD9117D VR9117	F & R F & R	Solid Solid	240 240	N/A N/A	Plain Vee	N/A N/A			SUZUKI UH 125 K7/K8/K9/L0/L1/L3 UH 200 K7/K8/K9/L0/L1/L3	07-13 07-13
MD9118D VR9118	Front Front	Solid Solid	256 256	N/A N/A	Plain Vee	N/A N/A			HONDA NSS 125 Forza 2 Piston caliper SH 300 i 7/8/9/A/B/AB (Non ABS) SH 300 i A7/A8/A9/AA/AB/AC (ABS) SH 300 i R8/R9/RA (Non ABS) SH 300 i AR8/AR9/ARA (ABS) SH 300 i 2 piston caliper/ABS SH 350 i 2 piston caliper/ABS	15-21 07-12 07-13 08-10 08-10 16-21 20-21

STREETBIKE DISC BUYERS GUIDE

Disc No.	F/R	Type	Dia. (mm)	Hub Color	Profile	Bobbins	Left Bracket	Right Bracket	Model	Year
MD9119D VR9119	Rear Rear	Solid Solid	256 256	N/A N/A	Plain Vee	N/A N/A			HONDA SH 300 i 7/8/9/A/B (Non ABS) SH 300 i A7/A8/A9/AA/AB/AC (ABS) SH 300 i R8/R9/RA (Non ABS) SH 300 i AR8/AR9/ARA (ABS) NSS 300 AD Forza ABS NSS 300 D Forza Non ABS NSS 300 AD Forza ABS NSS 350 AM Forza ABS SH 350 i 2 piston caliper/ABS	07-12 07-13 08-10 08-10 13-17 13-15 18-21 21-22 20-21
MD9120D	Front	Solid	220	N/A	Plain	N/A			SUZUKI FL 125 SDWK7/SDWK8 Address/Underbone	07-10
MD9121D	Rear	Solid	198	N/A	Plain	N/A			PEUGEOT LooXor 125/150	03-06
MD9122D	Front	Solid	245	N/A	Plain	N/A			DERBI GP1 125cc Racing Low seat/Radial caliper/6 bolt disc fixing GP1 250icc Racing Low seat/Radial caliper/6 bolt disc fixing	07-09 07-09
MD9123D	Rear	Solid	180	N/A	Plain	N/A			DERBI GP1 50 Euro 2 Chain driven/radial caliper/5 bolt fixing front disc GP1 50 Race Chain driven/radial caliper/5 bolt fixing front disc	05 05-07
MD9124D	Rear	Solid	280	N/A	Plain	N/A			GILERA GP 800 (Chain drive) APRILIA SRV 850	08-14 12-14
MD9125D	Front	Solid	300	N/A	Plain	N/A			GILERA GP 800 (Chain drive) APRILIA SRV 850	08-14 12-14
MD9126D	Front	Solid	190	N/A	Plain	N/A			GILERA Typhoon 50 Typhoon 50 X Typhoon 125 Typhoon 125 X-XR PIAGGIO New Fly 50 (4T/4V) Stalker 50 (All models) Typhoon 50 (2T) Heng Tong Caliper/10" wheels Typhoon 50 (2T) Grimeca Caliper/10" wheels Typhoon 50 (4T/12" Wheels) New Fly 125 ie (3V) Typhoon 125 Typhoon 125 (4T/12" Wheels)	94-97 98-99 95-03 99-00 12-13 97-11 01-09 00-04 10-15 12-13 99-03 10-15
MD9127D VR9127	Front Front	Solid Solid	180 180	N/A N/A	Plain Vee	N/A N/A			YAMAHA XC 125 Vity MBK XC 125 WAAP	08-13 08-10
VR9128	Front	Floating	260	Black	Vee	5			KYMCO Downtown/Superdink 125i (V21000) Downtown 125 i/Super Dink (V21000) New Downtown 125i K-XCT 125i Super 8 4T (125cc) X Town 125i ABS Downtown 200i Downtown/Superdink 300i (V20000) Downtown 300i (ABS) Downtown 350i (ABS) K-XCT 300i KAWASAKI J 125 ABS J 125 SE ABS J 300 Non ABS and ABS Models J 300 Special Edition non ABS and ABS models	09-15 09-15 15-19 12-15 08-15 16-20 10-15 09-12 10-20 15-20 12-15 16-18 16-18 14-20 14-20

STREETBIKE DISC BUYERS GUIDE

Disc No.	F/R	Type	Dia. (mm)	Hub Color	Profile	Bobbins	Left Bracket	Right Bracket	Model	Year
MD9129D VR9129	Rear Rear	Solid Solid	240 240	N/A N/A	Plain Vee	N/A N/A			KYMCO Downtown/Superdink 125i (V21000) X Town 125 Downtown 200i Downtown/Superdink 300i (V20000) Downtown 300i (ABS) X Town 300i New Downtown 350i KAWASAKI J 125 ABS (SC125 AGF/BGF/CGF/CHF/CJF) J 125 SE/ABS (SC125 AGFA/BGFA/CGFA/CHFA/CJFA) J300 AEF/AFF/AGF (Non ABS) J300 AEFA/AFFA/AGFA Special Edition (Non ABS) J300 ABS J300 Special Edition ABS	09-20 16-20 10-15 09-14 10-20 17-20 15-18 16-18 16-21 14-16 14-16 14-20 14-20
MD9130D	Front	Solid	270	N/A	Plain	N/A			YAMAHA VP 125 X-City (16P) VP 250 X-City (5B2) MBK VP 125 Cylinder	08-15 07-16 08-10
MD9131D	Front	Solid	186	N/A	Plain	N/A			YAMAHA VP 125 X-City (16P)	08-09
MD9132D	Rear	Solid	195	N/A	Plain	N/A			SINNIS Ecocity 125 (125T-8G)	07-09
MD9133D VR9133 VR9133BLK	Front Front Front	Solid Solid Floating	240 240 240	N/A N/A Black	Plain Vee Vee	N/A N/A 5			MBK NXC 125 Flame X YAMAHA NXC 125 Cygnus X (4P9) NCX 125 K Cygnus X Cab (4C6-1) NCX 125 L Cygnus X Injection (4C6-2) YW 125 X (1DN1/2) XC 125 R Majesty S 125 Majesty S 125 - See XC 125 R XC 155 F/G SMAX	07-12 07-13 07-10 07-10 10-13 15 15 15-16
MD9134D VR9134	F & R F & R	Solid Solid	220 220	N/A N/A	Plain Vee	N/A N/A			HONDA NSC 50 WHC/T2E/F Vision 50 (4T) (14" wheels) NSC 50 MPDC/E/F/G/H/J Vision 50 (4T) (16" wheels) NSC 50 R (14" wheels) ACB 110 CBB/CSB - Vario 110 ACD 110 CSB/SCB - Scoopy 110 Fi ACC 110 SCB/SCC - ANC 110 Icon AFS 110 2SHC/CSFF Wave NSC 110 CSD/CSE - Spacy 110 NSC 1110 CBFF/CBFH - Dio 110 NSC 110 WHB/E-Vision 110 (4T) (14" wheels) NSC 110 MPDC/E Vision (16" Wheels) NSC 110 MPDH Vision (16 Inch Wheels) ACA 125 CBFE - Air Blade 125 PCX 125 (WW125EX2 C/D/F/H/J) SH 125i Mode (ANC 125 E) PCX 150 (WW 150 EX2 C/D/F/H/J)	12-16 12-18 13-16 10 11-16 11-12 12-16 12-14 15-17 11-16 12-14 17-18 14-16 09-15 14-18 09-15
MD9135D VR9135	Rear Rear	Solid Solid	220 220	N/A N/A	Plain Vee	N/A N/A			FES 125 3/4/5 Pantheon FES 125 7/9/A/B S-Wing (Non ABS Model) FES 125 A7/A9/AA/AB S-Wing (ABS Model) NSS 125 Forza 2 Piston Caliper FES 150 3/4/5 Pantheon FES 150 7/9 S-Wing (Non ABS Model) FES 150 A7/A9 S-Wing (ABS Model) FES 250 Y/1/2/5 NSS 250 Y/AY/1/A1/A3/3 Forza/Forza-S/Forza-T/Forza-ST/ Jazz/Reflex (MF04/MF06)	03-06 07-13 07-15 15-21 03-06 07-13 07-13 00-04
MD9136D VR9136	Front Front	Solid Solid	267 267	N/A N/A	Plain Vee	N/A N/A			YAMAHA YP 400 Majesty (Non ABS) YP 400 Majesty (ABS)	05-13 07-13
MD9137D VR9137	Front Front	Solid Solid	225 225	N/A N/A	Plain Vee	N/A N/A			SYM Jet 4 R 50 (2T) Symphony S 50 (4T/Rear disc model) Jet 4 125(4T) Jet V 125 (4T) Symphony S 125 (4T/Rear disc model)	11-15 10-21 10-15 12-13 10-21

STREETBIKE DISC BUYERS GUIDE

Disc No.	F/R	Type	Dia. (mm)	Hub Color	Profile	Bobbins	Left Bracket	Right Bracket	Model	Year
MD9137D VR9137	Front Front	Solid Solid	225 225	N/A N/A	Plain Vee	N/A N/A			SYM Contd. Symphony S 151 (4T/Rear disc model) PEUGEOT Tweet 50 (4T/Rear drum model) Tweet 125 (4T/Rear drum model) Tweet 125 (Rear disc) Tweet 151 (4T/Rear drum model)	10-15 10-12 10-12 12-13 10-12
MD9138D VR9138	Front Front	Solid Solid	160 160	N/A N/A	Plain Vee	N/A N/A			SYM DD 50 (2T)	02-12
MD9139D VR9139	Rear Rear	Solid Solid	240 240	N/A N/A	Plain Vee	N/A N/A			HONDA SH 125i 9/A/B SH 125i RA SH 125i 9/A/B SH 125i (2 Piston Caliper/ABS) SH 125i (3 Piston Caliper/ABS) SH 150i RA SH 150i (2 Piston Caliper/ABS) SH 150i (3 Piston Caliper/ABS) VECTRIX VX-1 (Li/NiMh)	09-12 10-14 09-12 14-21 14-16 10-14 14-21 14-16 07-14
MD9140D VR9140	Front Front	Solid Solid	190 190	N/A N/A	Plain Vee	N/A N/A			HONDA SCV 110 (NHX 110 WHA 4 bolt lead disc fixing)	10-12
MD9141D VR9141	Front Front	Solid Solid	200 200	N/A N/A	Plain Vee	N/A N/A			PEUGEOT New Vivacity (50cc/2T) (12" wheels) New Vivacity Sixties (50cc/4T) (12" wheels) E-Vivacity (Electric) Django 50 Allure (2T) Django 50 Allure (4T) Django 50 Evasion (2T) Django 50 Evasion (4T) Django 50 Heritage (2T) Django 50 Heritage (4T) Django 50 Sport (2T) Django 50 Sport (4T) Django 50 S (2T) Django 50 S (4T) Django 125 Allure (4T/190mm Rear Disc) Django 125 Evasion (4T/190mm Rear Disc) Django 125 Heritage (4T/196mm Rear Disc) Django 125 Sport (4T/190mm Rear Disc) Django 125 Allure SBC (4T/190mm Rear Disc) Django 125 Evasion SBC (4T/190mm Rear Disc) Django 125 Heritage SBC (4T/190mm Rear Disc) Django 125 S (4T/190mm Rear Disc) Django 125 Sport SBC (4T/190mm Rear Disc) Vivacity 125 (4T) Django 150 Allure (4T/190mm Rear Disc) Django 150 Evasion (4T/190mm Rear Disc) Django 150 Heritage (4T/196mm Rear Disc) Django 150 S (4T) (4T/190mm Rear Disc) Django 150 Sport (4T/190mm Rear Disc)	08-15 10-15 11-15 14-18 14-18 14-21 14-18 14-18 14-18 14-18 14-18 14-18 14-21 14-21 14-21 14-21 14-21 14-21 14-21 14-21 14-20 14-20 10-15 14-21 14-21 14-21 14-21 14-21 14-21 14-21
MD9142D	F & R	Solid	220	N/A	Plain	N/A			SUZUKI UX 125 K8/K9/L0/L1 Sixteen UX 150 K8/K9/L0/L1 Sixteen	08-14 08-14
MD9143D VR9143	Rear Rear	Solid Solid	282 282	N/A N/A	Plain Verr	N/A N/A			YAMAHA T-Max 500 (530cc engine/Non ABS models) XP 500 A T-Max (530cc Engine/ ABS Models) XP 500 Black/Bronze Max (59CE) XP 530 A (530cc Engine - Iron Max - ABS Model) XP 500 A T-MAX - LUX MAX (ABS) XP 530E-A T-Max (530cc Engine - ABS Model) XP 530-A T-Max SX (530cc Engine - ABS Model) XP 530D-A T-Max DX (530cc Engine - ABS Model)	12-16 12-16 13-14 15-16 16 17-18 17-18 17-18
MD9144D VR9144BLK	Front Front	Floating Floating	260 260	Silver Black	Plain Vee	5 5			SUZUKI AN 650 L3/L4/L5/L6 Burgman Non ABS AN 650 ZL3/ZL4/ZL5/ZL6/ZL7/ZL8 Burgman ABS Executive	13-16 13-18

STREETBIKE DISC BUYERS GUIDE

Disc No.	F/R	Type	Dia. (mm)	Hub Color	Profile	Bobbins	Left Bracket	Right Bracket	Model	Year
MD9145D VR9145BLK VR9145	Front Front Front	Floating Floating Solid	267 267 267	Black Black N/A	Plain Vee Vee	5 5 N/A			YAMAHA XC 125 R Majesty S 125 Majesty S 125 - See XC 125 R XC 155 F/G SMAX	15 15 15-16
MD9146D	Front	Solid	220	N/A	Plain	N/A			PIAGGIO Medley 125 (ABS) Medley S 125 (ABS) YAMAHA 125 Tricity Scooter ABS (three wheeler)	16-20 16-21 14-21
MD9147D	Rear	Solid	230	N/A	Plain	N/A			YAMAHA TW 125 Tricity Scooter	14-16
MD9148D VR9148	Front Front	Solid Solid	226 226	N/A N/A	Plain Vee	N/A N/A			PEUGEOT Tweet 50 (4T/Rear Drum Model) Tweet 125 (4T) New Tweet Evo 50 (4T/Rear Drum Model) New Tweet Evo 125 (4T) New Tweet Evo 150 (4T)	10-13 12-13 14-19 14-20 14-20
MD9149D VR9149	Rear Rear	Solid Solid	226 226	N/A N/A	Plain Vee	N/A N/A			PEUGEOT Tweet 125 (4T) New Tweet Evo 125 (4T) New Tweet Evo 150 (4T) Symphony 50 SR (4T/Rear disc model) Symphony 125 SR (4T/Rear disc model) Symphony 151 SR (4T/Rear disc model)	12-13 14-20 14-20 10-15 10-15 10-15
MD9150D	Rear	Solid		N/A	Plain	N/A			YAMAHA YW 125 G Zuma	16-21
MD9151D VR9151	Front Front	Solid Solid	220 220	N/A N/A	Plain Vee	N/A N/A			PIAGGIO New Fly 50 (4T/4V) Fly 125i (3v/4T) New Fly 125ie (3V) Fly 125 (4T/3V) Rear Disc Model Typhoon 125 (4T/12" Wheels) Typhoon 50 (2T/12" Wheels)	12-13 12-15 12-13 12-15 10-15 10-18
MD9152D	Front	Solid	240	N/A	Plain	N/A			HYOSUNG MS3 125cc MS3 250i	07-09 07-09
MD9153D	Rear	Solid	240	N/A	Plain	N/A			YAMAHA YP 125 R X-MAX (2DEM/Brembo R/Caliper) YP 125 R X-MAX (3DM/Heng Tong R/Caliper) X-MAX (2DEM/Brembo R/Caliper): See YP 125 R X-MAX X-MAX (3DM/Heng Tong R/Caliper): See YP 125 R X-MAX	14-16 14 14-16 14
MD9154D	Front	Solid	267	N/A	Plain	N/A			YAMAHA HW 125 Xenter 125 HW 150 Xenter 150	12-18 12-16
MD9155D VR9155	Rear Rear	Solid Solid	240 240	N/A N/A	Plain Vee	N/A N/A			PIAGGIO Beverly 125 (Multi Spoke cast Type Wheels/4T) Beverly 125 ie S Beverly 300 (278cc/4T/Multi Spoke Wheel) Beverly 300 ie S	11-14 14-15 10-18 14-21
MD9156D	Front	Solid	230	N/A	Plain	N/A			YAMAHA GPD 125 A - N-MAX/2DS1 N-MAX 125 -See GPD125 A GPD 150 A - N-MAX/2DP4 N-MAX 150 -See GPD150 A	15-18 15-21 15-17 15-17
MD9157D	Rear	Solid	230	N/A	Plain	N/A			YAMAHA GPD 125 A - N-MAX/2DS1 N-MAX 125 -See GPD125 A GPD 150 A - N-MAX/2DP4 N-MAX 150 -See GPD150 A	15-18 15-21 15-17 15-17
MD9158D	Front	Solid	258	N/A	Plain	N/A			PIAGGIO MP3 Business LT 300 ie ABS (13" Front Wheel/ 14" Rear Wheel) MP3 Sport LT 300 ie ABS (13" Front Wheel/ 14" Rear Wheel)	14-18 14-18

STREETBIKE DISC BUYERS GUIDE

Disc No.	F/R	Type	Dia. (mm)	Hub Color	Profile	Bobbins	Left Bracket	Right Bracket	Model	Year
MD9158D Contd.	Front	Solid	258	N/A	Plain	N/A			PIAGGIO Contd. MP3 Yourban LT RL 300 MP3 500 LT Business ABS (13" Front Wheel/ 14" Rear Wheel) MP3 500 LT Sport ABS (13" Front Wheel/ 14" Rear Wheel)	17-18 14-20 14-21
VR9160	Front	Solid	245	N/A	Vee	N/A			PGO Tigra 125	2012
VR9161	Rear	Solid	220	N/A	Vee	N/A			PGO Tigra 125	2012
MD9162D VR9162 MD9163D VR9163	Front Front Rear Rear	Solid Solid Solid Solid	205 205 162 162	N/A N/A N/A N/A	Plain Vee Plain Vee	N/A N/A N/A N/A			GOGORO (E SCOOTER) SMART SCOOTER GOGORO (E SCOOTER) SMART SCOOTER	15-17 15-17
MD9164D VR9164	Rear Rear	Solid Solid	240 240	N/A N/A	Plain Vee	N/A N/A			PIAGGIO Medley 125 (ABS) Medley S 125 (ABS) Medley 150 (ABS) Medley S 150 (ABS) Beverly 350 ie Sport Touring Non (330cc/4T) Beverly 350 ie Sport Touring ABS (330cc/4T) Beverly 350 ie Sport Touring ABS (330cc/4T)	16-18 16-21 16-18 16-21 11-15 11-15 16-21
MD9165D	Front	Solid	240	N/A	Plain	N/A			PIAGGIO Liberty i-get 50 (3v/4T) Liberty i-get 125 (3v/4T) Liberty i-get 150 (3v/4T)	15-21 15-21 15-21
VR9166	Front	Solid	240	N/A	Plain	N/A			SYM Symphony 125 ST	17-20
MD9167D VR9167	Rear Rear	Solid Solid	190 190	N/A N/A	Plain Vee	N/A N/A			PEUGEOT Django 125 Allure (4T/190mm Rear Disc) Django 125 Evasion (4T/190mm Rear Disc) Django 125 Heritage (4T/190mm Rear Disc) Django 125 Sport (4T/190mm Rear Disc) Django 125 Allure SBC (4T/190mm Rear Disc) Django 125 Evasion SBC (4T/190mm Rear Disc) Django 125 Heritage SBC (4T/190mm Rear Disc) Django 125 S (4T/190mm Rear Disc) Django 125 Sport SBC (4T/190mm Rear Disc) Django 150 Allure (4T/190mm Rear Disc) Django 150 Evasion (4T/190mm Rear Disc) Django 150 S (4T) (4T/190mm Rear Disc) Django 150 Sport (4T/190mm Rear Disc)	14-21 14-21 14-21 14-21 14-21 14-21 14-21 14-21 14-21 14-21 14-21 14-21 14-21
MD9168D	Rear	Solid	245	N/A	Plain	N/A			YAMAHA X-Max 125/YP 125 RA X-Max 300 (CZD300A) X-Max 300 Tech Max(CZD300A)	18 17-18 19-22
MD9169D	Front	Solid	267	N/A	Plain	N/A			YAMAHA X-Max 125/YP 125 RA X-Max 300 (CZD300A)	18 17-18
MD9170D VR9170	Rear Rear	Solid Solid	196 196	N/A N/A	Plain Vee	N/A N/A			PEUGEOT Django 125 Heritage (4T/196mm Rear Disc) Django 150 Heritage (4T/196mm Rear Disc) Speedfight3 Darkside 125 (4T/ 196mm Rear Disc) Speedfight3 Iceblade 125 (4T/ 196mm Rear Disc)	14-21 14-21 14-15 14-16
MD9172D VR9172	Front Front	Solid Solid	300 300	N/A N/A	Plain Vee	N/A N/A			PIAGGIO Beverly 125 (Multi Spoke cast Type Wheels/4T) Beverly 125 ie S Beverly 300 (278cc/4T/Multi Spoke Wheel) Beverly 300 ie S Beverly 350 ie Sport Touring Non (330cc/4T) Beverly 350 ie Sport Touring ABS (330cc/4T) Beverly 350 ie Sport Touring ABS (330cc/4T)	11-14 14-15 10-20 14-21 11-15 11-15 16-21
MD9173D	Rear	Solid	260	N/A	Plain	N/A			KYMCO AK 550	17-21

STREETBIKE DISC BUYERS GUIDE

Disc No.	F/R	Type	Dia. (mm)	Hub Color	Profile	Bobbins	Left Bracket	Right Bracket	Model	Year
MD9174D	Front	Floating	270	Silver	Plain	6			KYMGCO AK 550	17-21
MD9176D	Front	Solid	240	N/A	Plain	N/A			SUZUKI UH 125 Burgman Non ABS UH 125 Burgman ABS UH 200 Burgman Non ABS UH 200 Burgman ABS	14-16 14-21 14-16 14-21
MD9177D	Front	Solid	220	N/A	Plain	N/A			HONDA PCX 125 PCX 150	16-21 16-21
MD9178D	Rear	Solid	240	N/A	Plain	N/A			PIAGGIO Medley 125 ABS Medley 150 ABS	20 20-21
MD9179D	Front	Solid	260	N/A	Plain	N/A			PIAGGIO Medley 125 ABS Medley 150 ABS	20-21 20-21
VR9180	Front	Solid	215	N/A	Vee	N/A			PEUGEOT Speedfight 50 Iceblade A/C 2T Speedfight 50 Iceblade L/C 2T Speedfight 50 4 Classic AC 2/4T Speedfight 50 4 Classic LC 2/4T Speedfight 50 4 Darkside AC 2/4T Speedfight 50 4 Darkside LC 2/4T Speedfight 50 4 Iceblade AC 2/4T Speedfight 50 4 Iceblade LC 2/4T Speedfight 50 4 Pure AC 2/4T Speedfight 50 4 Pure LC 2/4T Speedfight 50 4 R-Cup LC 2/4T Speedfight 50 4 20th Anniversary Edition AC 2T Speedfight 50 Air Speedfight 50 Darkside Air Speedfight 50 R-Cup Speedfight 50 Sportline Speedfight 4 125 4T Speedfight 4 125 I R-Cup SBC Speedfight 4 125 SBC	13-15 13-15 15-20 15-20 15-18 15-18 15-18 15-18 15-18 15-18 15-18 18-20 18 20 20 20 20 17-19 18-20 18-20
MD9182D	F & R	Solid	270	N/A	Plain	N/A			BMW C 600 Sport Scooter C 600 Sport Highline Scooter C Evolution Scooter C 650 GT Scooter C 650 GT Highline Scooter C 650 Sport Scooter	12-15 13-15 14-20 12-20 13-18 16-20
MD9183D	Front	Solid	180	N/A	Plain	N/A			OHVALE GP-O 110 160	19-20
MD1001	Front	Solid	276	N/A	Plain	N/A			HONDA CBR 400 RG/RH-YA (NC23) VFR 400 RH2/RJ (NC24) XBR 500 F/G/H/SJ CBR 600 FH/FJ/FK/FLFM/FN/FP/FR CBX 750 FE CBR 750 FH Superaero VF 750 SC (V45 Sabre) VFR 750 FG/FH CBR 400 RG/RH-YA (NC23) PC 800 Pacific Coast VF 1000 FE/FF/F2F/FG /F2G CBR 1000 FH/FJ "X4"-CB 1300 DCV/DCW/DCX/DCY (SC38)	86-87 87-88 85-89 87-94 84 87 82 86-87 86-87 89-97 84-86 87-88 97-00
MD1002	Rear	Solid	220	N/A	Plain	N/A			HONDA CBR 250 RH (MC17) CBR 250 RJ/RK/RK2 (MC19) NSR 250 RG (MC16-100) NSR 250 R2J (MC18-100)/R4J (MC18-100) NSR 250 RSP/RSK/RSP (MC18) NSR 250 RL/RN/RSP (MC21) NSR 250 R5K/R5K-2 (MC18-110) NSR 250 R6K/R6K-2 (MC18-110)	87 88-89 86 88 95- 89 89

STREETBIKE DISC BUYERS GUIDE

Disc No.	F/R	Type	Dia. (mm)	Hub Color	Profile	Bobbins	Left Bracket	Right Bracket	Model	Year
MD1002	Rear	Solid	220	N/A	Plain	N/A			HONDA Contd. NSR 250 R7L (MC21-100)/R7N (MC21-106) NSR 250 R8L-3 (MC21-100)/R9L (MC21-102)/R8N/ R8N-3 (MC21-106) NSR 250 R9N (MC21-106) NS 250 FE (MCII) NS 250 RE/RG (MCII) NS 250 FE/RE (MC11-100) NS 250 RG (MC11-102) VT 250 FL Spada/Castec CBR 400 RG/RGYA (NC23) CBR 400 RRJ/RRK (NC23 Tri arm) NS 400 RF/RG VFR 400 ZG/ZH/RG/RH-YA (NC21) CBR 600 FH/FJ/FK/FL	90 90 92 84 84-86 84 86 88-90 86 92-93 85-87 85-87 87-90
MD1003X MD1003XC MD1003CC VR1003BLK VR1003BLU VR1003RED	Front Front Front Front Front Front	Floating Floating Floating Floating Floating Floating	296 296 296 296 296 296	Gold Gold Chrome Black Blue Red	Plain Contour Contour Vee Vee Vee	6 6 6 6 6 6			APRILIA RS 125 MD 250 H MD 250 S RS 250 HONDA CBR 400 RRJ/RRK (NC23) Tri-Arm CBR 400 RRL/RRN/RRR (NC30) Gull-Arm RVF 400 RR/RR-II/RT/RT-II (NC35) VFR 400 R3K/R3N (NC30) VFR 400 R3L/R3M (NC30) CBR 600 FS/FT/FV/FW VFR 750 FR/FS/FT/FV/ CBR 900 RRR/RRS/RRT/RRV VTR 1000 FV/FW/FX/FY/F1/F2/F3/F4/F5/F6 Firestorm	90-07 08-11 08-11 90-02 81-89 90-94 94-96 89/92 90-91 95-98 94-97 94-97 97-06
MD1004 MD1004C VR1004	Rear Rear Rear	Solid Solid Solid	220 220 220	N/A N/A N/A	Plain Contour Vee	N/A N/A N/A			HONDA CBR 250 RRL/RRN/RRR CBR 250 RB/RC (Non ABS) CB 250 FT/FV/FX/FY/F1 'Hornet' VTR 250 W/Y/1-7 (MC33) CBR 400 RRL/RRN/RRR (NC29) Gull-Arm NX 4 Falcon CB 600 'Hornet' FW/FX/FY/F2Y/F1/F2Y/F2/F3/F4/F5/F6 CBR 600 FM/FN/FP/FR//FS/FT/FV/FW/FX/FY/F1/FS1/ F2/FS2/F3/RR3/F3/F4/RR4/F5/F6 CBR 600 RR (Radial Caliper) CBR 600 RR Hannspree CBR 600 RR CBR 900 RRN/RRP/RRR/RRS/RRT/RRV/RRW/RRX/RRY/ RR1/RR2/RR3 CB 1000 R8 CBR 1000 RR4/RR5/RR6/RR7 Fireblade CBR 1000 RR SPE Fireblade VTR 1000 SPY/SP1 VTR 1000 SP2/SP3/SP4/SP5/SP6 VTR 1000 FV/FW/FX/FY/F1/F2/F3/F4/F5/F6 Firestorm PEUGEOT SV 250	90-94 11-13 96-01 98-07 90-94 02-05 98-06 91-06 05-20 08 17-21 92-03 08-09 04-07 14 00-01 02-07 97-06 01-02
MD1005LS MD1005RS	Front Front	Solid Solid	256 256	N/A N/A	Plain Plain	N/A N/A			HONDA CB 350 SG/SJ CB 450 SG/SJ	86-90 86-88
MD1006 MD1006C VR1006	Front Front Front	Solid Solid Solid	256 256 256	N/A N/A N/A	Plain Contour Vee	N/A N/A N/A			HONDA CBR 250 FG/FGYA/RH NS 250 FE/RE (MC11-100) NSS 300 Forza non ABS FJS 400 Silverwing D6/D7/D8 NS 400 RF/RG VFR 400 ZG/ZH/RG/RG-YA (NC21) VF 500 FE/F2E/FF/F2F FJS 600 1/2/D3/D4/D5/D6 Silverwing	86-87 84 14-16 06-08 85-87 85-87 84-85 01-06
MD1006 MD1006C VR1006	Rear Rear Rear	Solid Solid Solid	256 256 256	N/A N/A N/A	Plain Contour Vee	N/A N/A N/A			HONDA VF 500 FE/F2E/FF/F2F CBR 750 FH/FJ Superaero VFR 750 FG/FH/FJ/FK CBR 1000 FP/FR/FS/FT/FV/FW/FX XL 1000 V3/V4/V5/V6/V7/V8/V9/VA/VB Vardero	84-85 87-88 86-89 93-98 03-11

DISC BUYERS GUIDE

STREETBIKE DISC BUYERS GUIDE

Disc No.	F/R	Type	Dia. (mm)	Hub Color	Profile	Bobbins	Left Bracket	Right Bracket	Model	Year
MD1006 MD1006C VR1006 Contd.	Rear Rear Rear	Solid Solid Solid	256 256 256	N/A N/A N/A	Plain Contour Vee	N/A N/A N/A			HONDA Contd. XL 1000 VA4/VA5/VA6/VA7/VA8/VA9/VAA/VAB Varadero - ABS CB 1100 SFY/SF1 "XII" CBR 1100 XXV/XXW/XXX/XXY/XX1/XX2/XX3/XX4/XX5/ XX6 Blackbird CB 1300 F3/F13	04-11 00-03 97-08 03-04
MD1007 MD1007C	Rear Rear	Solid Solid	256 256	N/A N/A	Plain Contour	N/A N/A			VFR 750 FL/FM/FN/FP/FR/FS/FT/FV	94-97
MD1008	Front	Solid	296	N/A	Plain	N/A			NV 400 DCY/DC1/DC2 (NC40) CB 500 R/T/V/W/SW/X/SX/Y/SY/2/S2 CBF 600 N4/N5/N6 (Non ABS) CBF 600 NA4/NA5/NA6 (ABS) CBF 600 S4/S5/S6 (Non ABS) CBF 600 SA4/SA5/SA6 (ABS) NT 650 VW/VX/VY/V1 Deauville NT 650 V2-V5 Deauville NT 700 V6/V7/V8/VA Deauville NT 700 VA6/VA7/VA8/VAA CB 750 F2N/F2R/F2S/F2T/F2V/F2W/F2X/F2Y/F21 CB 'Seven Fifty' VFR 750 FJ/FK/FL/FM/FN/FP CBR 1000 FH/FJ/FK/FL/FM/FN/FP/FR/FS/FT/FV/FW/FX ST 1100 AT/AV/AW/AX/AY/A1/A2 Pan European (ABS)	94-02 04-06 04-06 04-06 04-06 98-01 02-05 06-12 07-13 92-02 88-93 87-99 96-02
MD1010LS MD1010RS	Front Front	Floating Floating	310 310	Silver Silver	Plain Plain	6 6			VFR 750 RJ/RK/RL (RC30)	88-90
MD1011	Rear	Solid	220	N/A	Plain	N/A			VFR 750 RJ/RK/RL (RC30)	88-90
MD1012LS MD1012RS	Front Front	Floating Floating	310 310	Silver Silver	Plain Plain	6 6			RVF 750 RR/RS (RC45)	94-98
MD1013 BILLET	Rear	Solid	220	N/A	Plain	N/A			RVF 750 RR/RS (RC45)	94-98
MD1014X MD1014XC MD1014CC VR1014BLK VR1014BLU VR1014RED GOLD	Front Front Front Front Front Front	Floating Floating Floating Floating Floating Floating	296 296 296 296 296 296	Gold Gold Chrome Black Blue Red	Plain Contour Contour Vee Vee Vee	6 6 6 6 6 6			CBR 600 FX/FY VFR 800 FIW/FIX VFR 800 FIY/FI1/2/3/4/5 CBR 900 RRN/RRP XL 1000 VX/VY/V1/V2 Varadero Non ABS Model XL 1000 V3/V4/V5/V6/V7/V8/V9/VA/VB Varadero - Non ABS GL 1500 CV/CW/CX/CY/C1/C2 (F6C) GL 1800 6/7/8/9/A/C/D/E/F/G/H Goldwing GL 1800 A1-A5	99-00 98-99 00-05 92-93 99-02 03-11 97-03 06-17 01-05
MD1016	Rear	Solid	276	N/A	Plain	N/A			NT 650 VW/VX/VY/V1-V5 'Deauville' NT 700 V6/V7/V8/VAA Deauville NT 700 VA6/VA7/VA8/VAA CB 1000 FP/FR/FS/FT/FV CBR 1000 FK/FL/FM/FN VT 1100 C2 (W/X/Y/1/2/3/4/5) VT 1100 C2 (S/T/V) VT 1100 C3 (W/X/Y) CB 1300 FW/FX/FY (SC40) CB 1300 F1 (SC40)	98-05 06-12 07-13 93-97 89-92 98-05 95-97 98-00 98-00 01
MD1020 MD1020C VR1020	Rear Rear Rear	Solid Solid Solid	240 240 240	N/A N/A N/A	Plain Contour Vee	N/A N/A N/A			NSS 250 EX5/EX7/EX8 (ABS) Forza EX NSS 250 AX5/AX6 (Forza Z) (ABS) NSS 250 X5/X7/X8 Forza CB-1 (CB 400 F) CB 400 SF (F2N/F2R/F2V/F3T/F3V) Superfour (NC31) CB 500 V/W/SW/X/SX/Y/SY/2/S2 CB 750 F2N/F2R/F2S/F2T/F2V/F2W/F2X/F2Y/F21 'CB Seven Fifty' CB 900 F2/F3/F4/F5/F6/F7 CAGIVA E 750 Elephant E 900 C Elephant (282mm front discs/USD forks/ Brembo front calipers/rear) E 900 C ie Lucky Explorer (282mm front discs)	05-08 05-06 05-08 89-90 92-97 97-03 92-02 02-07 93-95 93-97 95-97

STREETBIKE DISC BUYERS GUIDE

Disc No.	F/R	Type	Dia. (mm)	Hub Color	Profile	Bobbins	Left Bracket	Right Bracket	Model	Year
MD1021LS MD1021RS	Front Front	Floating Floating	316 316	Silver Silver	Plain Plain	6 6			HONDA VT 250 CR/CT/CV 'Magna' NTV 600 J/K/M Revere NTV 650 J/K/L/M/P/S/T/V VF 750 CP/CR/CS/CT/CV VT 1100 C2 (S/T/V)	95-97 88-92 88-97 93-97 95-97
MD1022	Rear	Solid	240	N/A	Plain	N/A			VFR 400 RH2/RJ (NC24) NT 400 'Bros' NC25 NT 650 J/K/L (Bros) (NC31)	87-88 88-92
MD1024LS/RS									USE MD1001LS/RS	
MD1025	Rear	Solid	276	N/A	Plain	N/A			NTV 600 J/K/M Revere NTV 650 J/K/L/M/P/S/T/V	89-92 88-97
MD1030	Front	Solid	240	N/A	Plain	N/A			CA 125 S/T/V/W/X Rebel CB 125 F (GLR 125 1WHF) CB 125 F (GLR 125 1WHH) CBF 125 6 Stunner CBF 125 M7 Stunner CBF 125 M9/MA/MB/MD/ME VT 125 CX-C8 'Shadow' CBF 150 6 (Spoke Wheels) CBF 150 M6/M7 Unicorn (Spoke Wheels) CBF 150 M7/M9/MA Unicorn (Cast Wheels) CBF 150 MB/MC Unicorn (Cast Wheels) CBX 250 CMX 250 CT/CV/CW 'Rebel' TA 200 (TA 200 Shadow) HERO Glamour 125 (PGM F1) Hunk 150	95-00 15-16 17-21 06 07 09-15 99-08 06 06-07 07-10 11-12 84-98 96-00 02-05 11-12 11-12
MD1036LS MD1036RS VMD1036	Front Front Front	Floater Floater Floater	276 276 276	Silver Silver Black	Plain Plain Plain	6 6 6			HONDA CB 250 N/NA/NB/NDB/NDC CM 250 TB CX 500 EC CB 650 SCC Nighthawk CX 650 ED CB 750 KZ CB 750 FZ/FA/FB/FC/F2C/FD/F2D CB 900 FZ/FA/FB/F2B CB 900 FC/F2C/FD/F2D CBX 1000 Z GL 1000 K3/KZ Goldwing GL 1000 Z GL 1100 A/DA/B/DB Goldwing GL 1100 1A/1B Interstate Goldwing GL 1100 C/DC	78-82 81 82 82 83 80 78-84 80-83 84-85 79-80 77-78 79 80-81 80-81 82
MD1038RS	Front	Floating	310	Gold	Plain	6			CB-1 (CB 400 F)	89-90
MD1040LS MD1040RS	Front Front	Solid Solid	276 276	N/A N/A	Plain Plain	N/A N/A			CB 450 SC Nighthawk CM 450 A Hondamatic GL 650 Silverwing/GL 650 Silverwing Interstate VF 700 C Magna VF 700 C Magna VT 700 C Shadow VF 750 C V45 Magna VT 750 C Shadow CB 1000 C Custom VF 1100 C V65 Magna VT 1100 C Shadow	83-86 83 83 84 85-86 84-85 82-83 83 83 83-86 85-86
MD1041LS	Front	Solid	276	N/A	Plain	N/A			CMX 450 CH/CJ Rebel	87-88
VMD1042	Front	Floating	276	Black	Plain	6			HONDA CB 500 K1/K2/F CB 550 F/F1/F2/K3	75-77 78-80
MD1046									USE MD1082	
MD1047LS	Front	Solid	296	N/A	Plain	N/A			FT 500 C VT 600 CN/CR/CS/CT/CV/CW/CX 'Shadow custom' VF 750 C Shadow	82 93-00 83

STREETBIKE DISC BUYERS GUIDE

Disc No.	F/R	Type	Dia. (mm)	Hub Color	Profile	Bobbins	Left Bracket	Right Bracket	Model	Year
MD1048 SILVER	Rear	Floating	276	Silver	Plain	9			FT 500 C	82
MD1051LS									USE MD1047LS	
MD1052LS MD1052RS VMD1052	Front Front Front	Floating Floating Floating	296 296 296	Gold Gold Black	Plain Plain Plain	9 9 9			HONDA CB 750 C Custom CB 750 L "Ltd Edition" CB 750 K	80 79 79-82
MD1056	Front	Floating	310	Silver	Plain	9			CB 1000 FP/FR/FS/FT/FV	93-97
MD1059LS	Front	Solid	316	N/A	Plain	N/A			VF 750 CH	87
MD1062LS VMD1062	Front Front	Floating Floating	296 296	Silver Black	Plain Plain	9 9			CB 750 K6-K7 CB 750 KZ	76-78 80
MD1064	Rear	Floating	296	Silver	Plain	9			CB 750 F/F1/F2 GL 1000 2 Goldwing GL 1000 K/K1/K2/K3 Goldwing	76-78 79 75-
MD1065									USE MD1071	
MD1068	Rear	Solid	296	N/A	Plain	N/A			VF 750 FD/FE	83-84
MD1071 VMD1071	Rear Rear	Floating Floating	296 296	Silver Black	Plain Plain	9 9			CB 750 FZ/FA/FB CB 900 FZ/FA CBX 1000 Z CBX 1000 B/C GL 1000 K/K1-K3/KZ GL 1100 A/DA/B/DB Goldwing GL 1100 1A/1B Interstate Goldwing GL 1100 C/DC	78-82 80-81 79-80 81-82 75-79 80-81 80-81 82
MD1074LS MD1074RS	Front Front	Floating Floating	276 276	Silver Silver	Plain Plain	9 9			GL 1000 K/K1/K2	75-77
MD1076LS/RS									USE MD1036LS/RS	
MD1077 BILLET	Rear	Solid	316	N/A	Plain	N/A			ST 1100 AN/AP/AR/AS Pan European ABS ST 1100 L/M/N/P/R/S/T/V/W/X/Y/1/2 Pan European Non ABS GL 1500 L/SEM/SEN/SEP/SER/SES/SEV/SEW/SEX/SEY Goldwing GL 1500 CV/CW/CX	92-95 90-02 88-00 97-99
MD1079 BILLET	Rear	Solid	276	N/A	Plain	N/A			CBX 750 FE VF 1000 FE/FF/F2F/FG/F2G	84 84-86
MD1080RS	Front	Floating	336	Silver	Plain	9			VT 1100 CH/CJ/CN/CP Shadow	87-93
MD1082	Rear	Floating	296	Silver	Plain	9			CB 750 FC/F2C/FD/F2D CB 900 FB/F2B/FC/F2C/FD/F2D CBX 1000 B/C GL 1100 AD GL 1100 C/DC/1C Interstate Goldwing GL 1100 AC/AD Aspencade Goldwing GL 1200 DE/DF/DG/AE/AF/AG	83-84 84-85 80-82 83 82 82-83 84-86
MD1083LS MD1083RS	Front Front	Floating Floating	276 276	Silver Silver	Plain Plain	9 9			VF 750 FD/FE GL 1200 DE/DF/DG	83-84 84-86
MD1084LS	Front	Solid	240	N/A	Plain	N/A			NS 125 FG/FH/RH	86-87
MD1088LS	Front	Floating	316	Silver	Plain	9			NSR 125 FM/RK/RL/RM/RN NSR 125 FJ/K/FL/FM/FN NSR 125 RK/RL/RM/RN	91-92 88-92 89-92
MD1089LS	Front	Solid	240	N/A	Plain	N/A			CB 250 N/T/W/X/Y/1/4 (CB Two Fifty)	92-05
MD1090LS	Front	Solid	240	N/A	Plain	N/A			CBX 250 RSE CD 250 UJ	84 88-92
MD1092LS/RS									USE MD1003X	
MD1093LS/RS									USE MD1003X	
MD1095LS/RS									USE MD1083LS/RS	

STREETBIKE DISC BUYERS GUIDE

Disc No.	F/R	Type	Dia. (mm)	Hub Color	Profile	Bobbins	Left Bracket	Right Bracket	Model	Year
MD1100LS/RS									USE MD1133X	
MD1101	Front	Solid	316	N/A	Plain	N/A			HONDA ST 1100 AN/AP/AR/AS Pan European (ABS) ST 1100 L/M/N/P/R/S/T/V/W/X/Y/1/2 Pan European (Non ABS) KYMCO Venox 250 (R20010/RA50AA/Carb Model) Venox 250 (RFBR20011/RA50AD/Carb Model) Venox 250 (R20012/EFI Model)	92-95 90-02 00-03 04-06 07-14
MD1102									USE MD1077	
MD1103LS									USE MD1047LS	
MD1109LS SILVER	Front	Floating	316	Silver	Plain	9			HONDA NSR 125 FP/PP/RR/RV/RW/RX/R1 NSR 125 RR/RS/RV/RW/RX/R1	93-04 93-01
MD1111	Rear	Solid	220	N/A	Plain	N/A			NSR 250 R2R/R3R/ (MC28-110) R2T/R3T (MC28-120) NSR 250 RR (MC28-100) VFR 400 RK3/R3L/R3M/R3N (NC30) RVF 400 RR/RR-II/RT/RT-II (NC35)	94 94 89-92 94-96
MD1114LS MD1116 SILVER	Rear	Floating	296	Silver	Plain	9			USE MD1001 CB 1100 RB11/RC11/RD11	80-83
MD1117LS	Front	Floating	276	Silver	Plain	9			NSR 250 R6K/R6K-2	89
MD1117RS	Front	Floating	276	Silver	Plain	9			NSR 250 R7L (MC21-100)/R7N (MC21-106) NSR 250 R8L-3 (MC21-101)/R9L (MC21-102)/R8N/ R8N-3 (MC21-106) NSR 250 R9N (MC21-106) NSR 250 RR (MC28-100) NSR 250 R2R/R3R (MC28-110) /R2T/R3T (MC28-120) NSR 250 R2J (MC18-100)/R4J(MC18-100) NSR 250 R5K/R5K-2 (MC18-110)	90 90-92 92 94 94 88 89
MD1118									USE MD1077	
MD1120X MD1120XC VR1120BLK VR1120BLU VR1120RED	Front Front Front Front Front	Floating Floating Floating Floating Floating	310 310 310 310 310	Silver Silver Black Blue Red	Plain Contour Vee Vee Vee	6 6 6 6 6			CBR 1100 XXV/XXW Blackbird	97-98
MD1124LS	Front	Floating	320	Gold	Plain	9			NT 400 BROS NC25 NT 650 J/K/L (Bros) (NC31)	88-92
MD1125 BILLET	Front	Floating	276	Silver	Plain	9			GL 1200 AE/AF/AG Goldwing	84-86
MD1126 BILLET	Front	Solid	296	N/A	Plain	N/A			GL 1500 J/K/L/SEM/SEN/SEP/SER /SES/SEV/SEW/SEX/SEY Goldwing	88-00
MD1127 BILLET	Rear	Solid	296	N/A	Plain	N/A			GL 1500 J/K Goldwing	88-89
MD1129LS MD1129RS	Front Front	Floating Floating	256 256	Silver Silver	Plain Plain	6 6			NSR 250 RG (MC16-100)	86
MD1131LS	Front	Floating	296	Silver	Plain	9			FT 500 C	82
MD1132 MD1132C	Front Front	Floating Floating	296 296	Silver Silver	Plain Contour	9 9			CB 400 SF (F2N/F2R/F2V/F3T/F3V) Superfour (NC31) CB 600 FW/FX	92-97 98-99
MD1133 BILLET	Front	Floating	296	Silver	Plain	9			GL 1100 AD GL 1100 AC Aspencade Goldwing	83 82
MD1134X MD1134XC MD1134CC VR1134BLK VR1134BLU VR1134RED	Front Front Front Front Front Front	Floating Floating Floating Floating Floating Floating	310 310 310 310 310 310	Gold Gold Chrome Black Blue Red	Plain Contour Contour Vee Vee Vee	6 6 6 6 6 6			CBR 900 RRW/RRX	98-99

STREETBIKE DISC BUYERS GUIDE

Disc No.	F/R	Type	Dia. (mm)	Hub Color	Profile	Bobbins	Left Bracket	Right Bracket	Model	Year
MD1135	Rear	Solid	296	N/A	Plain	N/A			ST 1100 AT/AV/AW/AX/AY/A1/A2 Pan European (ABS)	96-02
MD1136X MD1136XC VR1136BLK VR1136BLU VR1136RED	Front Front Front Front Front	Floating Floating Floating Floating Floating	310 310 310 310 310	Gold Gold Black Blue Red	Plain Contour Vee Vee Vee	6 6 6 6 6			CBR 1100 XXX/XXY/XX1-XX6 Blackbird CB 1100 SFY/SF1 "XII"	99-08 00-03
MD1137X MD1137XC MD1137CC VR1137BLK VR1137BLU VR1137RED	Front Front Front Front Front Front	Floating Floating Floating Floating Floating Floating	330 330 330 330 330 330	Gold Gold Chrome Black Blue Red	Plain Contour Contour Vee Vee Vee	6 6 6 6 6 6			CBR 900 RRY/RR1 "929cc Fireblade" CBR 900 RR2/RR3 954cc	00-01 02-03
MD1138X MD1138XC MD1138CC									USE MD1161X USE MD1161XC USE MD1161CC	
MD1139 MD1139C	Front Front	Floating Floating	296 296	Gold Gold	Plain Contour	9 9			CB 600 FY/F2Y/F1/F21/F22/F2/F3/F4/F5/F6	00-06
MD1140RS GOLD	Front	Floating	310	Gold	Plain	9			CBR 250 RJ/RK/R2K MC19	88-89
MD1141X MD1141XC MD1141CC VR1141BLK VR1141BLU VR1141RED VR1141CHRD	Front Front Front Front Front Front Front	Floating Floating Floating Floating Floating Floating Floating	296 296 296 296 296 296 296	Gold Gold Chrome Black Blue Red Red	Plain Contour Contour Vee Vee Vee Vee	6 6 6 6 6 6 6			CBR 600 F1/F2/F3/F4/F5/F6 CBR 600 FS1/FS2 'Sport' CB 900 F2-F7 Hornet VTX 1800 C2/C3/C4/C15/C16/C17	01-06 01-02 02-07 02-08
MD1142RS	Front	Solid	256	N/A	Plain	N/A			NSR 75 N/P/R/X/Y (NS-1)	92-00
MD1143	Rear	Solid	220	N/A	Plain	N/A			NSR 75 N/P/R/X/Y (NS-1)	92-00
MD1144RS	Front	Floating	296	Gold	Plain	9			CB 250 FT/FV/FX/FY/F1 Hornet VTR 250 W/Y/1-7 (MC33)	96-01 98-07
MD1145LS MD1145RS	Front Front	Floating Floating	276 276	Gold Gold	Plain Plain	9 9			CBR 250 RRL/RRN/RRR (MC22)	90-94
MD1146	Front	Solid	276	N/A	Plain	N/A			VF 1000 RE/RF/RG	84-86
MD1147LS	Front	Solid	240	N/A	Plain	N/A			CLR 125 W 'City Fly' NX 125 K/S/T CRM 125 RL/RM/RP/RR/RV/RX	99-03 89-97 90-99
MD1148	Rear	Solid	316	N/A	Plain	N/A			GL 1500 CY/C1/C2 (F6C) VTX 1800 C2/C3/C4/C15/C16/C17	00-03 02-08
MD1149 MD1149C	Rear Rear	Solid Solid	240 240	N/A N/A	Plain Contour	N/A N/A			NSS 300 Forza non ABS FJS 400 Silverwing D6/D7/D8 SW-T 400 (FJS 400 D9) SW-T 400 (FJS 400 A9/AB) (ABS) FJS 600 1/2/D3/D4/D5/D6 Silverwing FJS 600 A3-A7/D7 Silverwing SW-T 600 (FJS 600 AB) (ABS)	14-21 06-08 09 09-16 01-06 03-09 11-16
MD1150RS	Front	Solid	276	N/A	Plain	N/A			XL 125 V1-VA Varadero	01-16
MD1151	Rear	Solid	220	N/A	Plain	N/A			XL 125 V1-VA Varadero CBR 125 R4/R5/RS5/RWS/RW6/RW7/RW8/RW9/RWA/ RWB/RC/RD/RF/RG CBF 150 MB/MC Unicorn (Cast Wheels) CBR 150 R	01-16 04-16 11-12 00-03

STREETBIKE DISC BUYERS GUIDE

Disc No.	F/R	Type	Dia. (mm)	Hub Color	Profile	Bobbins	Left Bracket	Right Bracket	Model	Year
MD1152X	Front	Floating	310	Gold	Plain	6			CBR 600 RR3/RR4/RR5/RR6/RR7/RR8/RR9/RRR/RRB/RRC/RRD/RRE/RRF/RRG (RADIAL CALIPER)	03-17
MD1152XC	Front	Floating	310	Gold	Contour	6			CBR 600 RR Hannspree	08
MD1152CC	Front	Floating	310	Chrome	Contour	6			CBR 600 R (C-ABS)	09-18
VR1152BLK	Front	Floating	310	Black	Vee	6			CBR 600 RR	17-21
VR1152BLU	Front	Floating	310	Blue	Vee	6			CB 1000 R (Non ABS)	09-15
VR1152RED	Front	Floating	310	Red	Vee	6			CB 1000 RA9/RAA/RAB/RAC/RAE (ABS Model)	09-16
VR1152CHRD	Front	Floating	310	Red	Vee	6			CB 1300 5/6/7/8/9 (Superfour)	05-09
									CB 1300 A5-A9 (Superfour ABS)	05-09
									CB 1300 S5/S6/S7/S8/S9	05-09
									CB 1300 SA5/SA6/SA7/SA8/SA9/SAA	05-12
MD1153X	Front	Floating	310	Gold	Plain	6			CBR 1000 RR4/RR5	04-05
MD1153XC	Front	Floating	310	Gold	Contour	6				
MD1153CC	Front	Floating	310	Chrome	Contour	6				
VR1153BLK	Front	Floating	310	Black	Vee	6				
VR1153BLU	Front	Floating	310	Blue	Vee	6				
VR1153RED	Front	Floating	310	Red	Vee	6				
MD1154X	Front	Floating	310	Gold	Plain	6			CTX 1300 AE	14-17
MD1154XC	Front	Floating	310	Gold	Contour	6			ST 1300 2/3/4/6 Pan European (Non ABS)	02-07
									S 1300 A2/A3/A4/A6/A8/A9/AA-AE Pan European (ABS Model)	02-17
									ST 1300 8/9 Pan European (Non ABS)	08-09
MD1155RS	Front	Solid	296	N/A	Plain	N/A			CBF 500 4 (Non ABS Model)	04
									CBF 500 A4/A5/A6/A7 ABS Model	04-07
MD1156	Rear	Solid	240	N/A	Plain	N/A			CBF 500 4 (Non ABS Model)	04-05
									CBF 500 A4/A5/A6/A7 ABS Model	04-07
									CB 500 F (Non ABS)	13-20
									CB 500 FA (ABS)	13-21
									CB 500 X (Non ABS)	13-20
									CB 500 XA (ABS)	13-21
									CBR 500 R (Non ABS)	13-20
									CBR 500 RA (ABS)	13-21
									CB 600 F7/F8/F9/FA/FB/FC Hornet	07-13
									CB 600 FA7/FA8/FA9/FAA/FAB/FAC Hornet (ABS)	07-13
									CBF 600 N4/N5/N6/N8/N9/NA (Non ABS)	04-06/08-11
									CBF 600 NA4/NA5/NA6/NA8/NA9 (ABS)	04-06/08-09
									CBF 600 S4/S5/S6/S8/S9 (Non ABS)	04-06/08-09
									CBF 600 SA4/SA5/SA6/SA8/SA9/SAA (ABS)	04-06/08-12
									CBR 600 FB/FC (Non ABS Model)	11-13
									CBR 600 FAB/FAC (ABS Model)	11-13
									CB 650 R	19-21
									CBR 650 R	19-21
									ADV 750 H (ADV X DCT)	17-21
									CBF 1000 6/7/8/9/A (Non ABS)	06-11
									CBF 1000 F (FA) (Non ABS)	10-11
									PEUGEOT	
									Metropolis 400 RS 3 wheel model/ Nissin caliper	14-21
									Metropolis 400 RX-R wheel model/ Nissin caliper	17-21
									Metropolis 400 Allure 3 wheel model/ Nissin caliper	17-21
MD1157X	Front	Floating	296	Gold	Plain	6			HONDA	
MD1157XC	Front	Floating	296	Gold	Contour	6			VFR 800 A2/A3/A4/A5 (ABS)	02-05
									VFR 800 6/8/9	06-09
									VFR 800 A6/A7/A8/A9 (ABS)	06-13
									VFR 800 XB/XC/XD (Crossrunner/ABS)	11-14
									XL 1000 VA4/VA5/VA6/VA7/VA8/VA9/VAA/VAB Varadero - ABS	04-11
MD1158RS	Front	Solid	336	Gold	Plain	9			VTX 1300 (Spoke wheel models only)	03-08
MD1159	Front	Solid	296	N/A	Plain	N/A			NV 400 DCY/DC1/DC2 (NC40) Shadow Slasher	00-02
									VT 750 CV/C2V/CW/C2W/CX/C2X/CY/C2Y/C1/C21/C4/C5/C6/C7/C8 Shadow	97-09
									VT 750 DC1/DC2 'Black Widow'	01-04
									VT 750 DC7/DC8 Shadow Spirit	07-09
									VT 750 C2BA/C2BB/C2BC/C2BE Shadow Black Spirit	10-16
									VT 750 S (VT750SA/SB)	10-12
MD1159	Rear	Solid	296	N/A	Plain	N/A			VTX 1300 S3/S4/S5/S6/S7/S8	03-08

STREETBIKE DISC BUYERS GUIDE

Disc No.	F/R	Type	Dia. (mm)	Hub Color	Profile	Bobbins	Left Bracket	Right Bracket	Model	Year
MD1160	Front	Floating	296	Silver	Plain	9			CBF 600 N8/N9/NA (Non ABS) CBF 600 NA8/NA9/NAA (ABS) CBF 600 S8/S9 (Non ABS) CBF 600 SA8/SA9/SAA (ABS) CBF 1000 6/7/8/9/A (Non ABS) CBF 1000 A6/A7/A8/A9/AA (ABS) CBF 1000 F (FA) (Non ABS) CBF 1000 FA (FAA/FAB) (ABS) CBF 1000 FS (FSA) (ABS) CBF 1000 FT (FTA) (ABS) CBF 1000 S (S7/S8/S9/SA) (ABS) CBF 1000 T (T7/T8/T9/TA) GT (ABS)	08-11 08-11 08-09 08-12 06-10 06-10 10-15 10-13 10-11 10-11 07-11 07-16
MD1161X MD1161XC MD1161CC VR1161BLK VR1161BLU VR1161RED	Front Front Front Front Front	Floating Floating Floating Floating Floating	320 320 320 320 320	Gold Gold Chrome Black Blue Red	Plain Contour Contour Vee Vee Vee	6 6 6 6 6 6			CBR 1000 RR6/RR7 VTR 1000 SPY/SP1 (SC45) VTR 1000 SP2/SP3/SP4/SP5/SP6	06-07 00-01 02-07
MD1162LS MD1162RS	Front Front	Floating Floating	296 296	Gold Gold	Plain Plain	9 9			CBR 750 FJ	88
MD1163	Rear	Solid	316	N/A	Plain	N/A			CTX 1300 AE ST 1300 2/3/4/6 Pan European (Non ABS) S 1300 A2/A3/A4/A6/A8/A9/AA-AE Pan European (ABS Model) ST 1300 8/9 Pan European (Non ABS)	14-17 02-07 02-17 08-09
MD1164 MD1164C	Rear Rear	Solid Solid	256 256	N/A N/A	Plain Contour	N/A N/A			VFR 800 A2/A3/A4/A5 (ABS) VFR 800 A6/A7/A8/A9 (ABS)	02-05 06-13
MD1165 MD1165C	Rear Rear	Solid Solid	256 256	N/A N/A	Plain Contour	N/A N/A			VFR 800 FIW/FIX VFR 800 FIY/FI1/2/3/4/5 VFR 800 6/8/9	98-99 00-05 06-09
MD1166RS	Front	Solid	276	N/A	Plain	N/A			CBR 125 RWB/RC/RD/RF/RG CBF 250 4/6 CB 300 R10	11-16 04-06 10
MD1167RS	Front	Solid	336	N/A	Plain	N/A			VT 1100 CR/CS/CT/CV/CW Shadow	94-98
MD1168X	Front	Floating	296	Gold	Plain	6			CB 600 F7/F8/F9/FA/FB/FC Hornet	07-13
MD1168XC	Front	Floating	296	Gold	Plain	6			CB 600 FA7/FA8/FA9/FAA/FAB/FAC Hornet (ABS) CBR 600 FB/FC/FAB/FAC (ABS Model)	07-13 11-13
MD1169C MD1169CF	Front Front	Solid Floating	220 220	N/A Gold	Contour Contour	N/A 6			NSR 50 V (AC10-180) NSR 50 X (AC10-190) NSR 80 V (HC06-170) NSR 80 X (HC06-180)	97 99 97 99
MD1170C	Rear	Solid	160	N/A	Contour	N/A			NSR 50 V (AC10-180) NSR 50 X (AC10-190) NSR 80 V (HC06-170) NSR 80 X (HC06-180)	97 99 97 99
MD1171X	Front	Floating	320	Gold	Plain	5			CBR 1000 RR8/RR9/RAA/RRB/RRC/RRD/RRE/RRF/RRG/RAF/RAG Fireblade	08-20
MD1171XC VR1171BLK VR1171BLU VR1171RED	Front Front Front Front	Floating Floating Floating Floating	320 320 320 320	Gold Black Blue Red	Contour Vee Vee Vee	5 5 5 5			CBR 1000 RA9/RAA/RAB/RAC/RAD/RAE Fireblade (ABS) CBR 1000 RAH/RAJ Fireblade (C-ABS/ Tokico Front Caliper) CBR 1000 RR-SP ABS Fireblade (CBR 1000 SAE/SAF/SAG/SAH/SAJ/SAK- Brembo Front Caliper) CBR 1000 RR-SP Non ABS Fireblade (CBR 1000 SE/SF/SG)	09-20 17-20 14-20 14-16
MD1172LS	Front	Solid	276	N/A	Plain	N/A			SW-T 400 (FJS 400 D9) SW-T 400 (FJS 400 A9/AB) (ABS) FJS 600 Silverwing A3-A7/D7 SW-T 600 (FJS 600 AB) (ABS)	09 09-16 03-09 11-16

STREETBIKE DISC BUYERS GUIDE

Disc No.	F/R	Type	Dia. (mm)	Hub Color	Profile	Bobbins	Left Bracket	Right Bracket	Model	Year
MD1173 MD1173C VR1173	Rear Rear Rear	Solid Solid Solid	220 220 220	N/A N/A N/A	Plain Contour Vee	N/A N/A N/A			CBR 600 RA9/RAA/RAB/RAC/RAD/RAG (C-ABS) CBR 1000 RR8/RR9/RAA/RRB/RRC/RRD/RRE/RA9/RAA/ RAB/RAC/RAD/RAE/RRF/RRG/RAF/RAG Fireblade CBR 1000 RA9/RAA/RAB/RAC/RAD/RAE/RAF/RAG Fireblade (C-ABS) CRB 1000 RR-SP Fireblade ABS -Brembo F/Caliper CRB 1000 RR-SP ABS-TT Edition CRB 1000 C-ABS FirebladeNissin F/Caliper	09-16 08-16 09-16 14-21 16 17-20
MD1174 MD1174C	Rear Rear	Solid Solid	256 256	N/A N/A	Plain Contour	N/A N/A			CB 1100 RS CB 1300 5/6/7/8/9 (Superfour) CB 1300 A5/A6/A7/A8/A9 (Superfour ABS) CB 1300 SA5/SA6/SA76/SA8/SA9/SAA	17-21 05-09 05-09 05-12
MD1175	Rear	Solid	276	N/A	Plain	N/A			VFR 1200 FA VFR 1200 FAD DCT VFR 1200 FA - GT VFR 1200 FAD - GT/DCT VFR 1200 XDC/XDCD/XDE/XDF/XDG/XDH/XDJ DCT Crosstourer VFR 1200 XAC/XAD/XAE/XAF/XAH/XAJ Crosstourer (Manual G/Box)	10-16 10-17 14-15 14-15 12-18 12-18
MD1176X	Front	Floating	320	Gold	Plain	6			CBR 1000 RR Fireblade SP2 VFR 1200 FA VFR 1200 FAD -DCT VFR 1200 FA - GT VFR 1200 FAD - GT/DCT	17-18 10-16 10-17 14-15 14-15
MD1177 MD1177C	Rear Rear	Solid Solid	256 256	N/A N/A	Plain Contour	N/A N/A			CB 1000 R (Non ABS) CB 1000 RA (ABS) CB 1000 R	09-15 09-16 17-21
MD1178	Rear	Solid	240	N/A	Plain	N/A			CBF 1000 A6/A7/A8/A9/AA (ABS) CBF 1000 (FAA/FAB) (ABS) CBF 1000 FS (FSA) (ABS) CBF 1000 FT (FTA) (ABS) CBF 1000 S (S7/S8/S9/SA) (ABS) CBF 1000 T (T7/T8/T9/TA)-GT (ABS)	06-10 10-13 10-11 10-11 07-11 07-16
MD1179	Front	Solid	316	N/A	Plain	N/A			VT 1100 C2 (W/X/Y/1/2/3/4/5) VT 1100 C3 (W/X/Y)	98-05 98-00
MD1180X MD1180XC	Front Front	Floating Floating	296 296	Gold Gold	Plain Contour	6 6			CBR 250 RB/RC (Non ABS) CBR 250 RAB/RAC (ABS) CB 300 FAF/FAG (ABS) CB 300 R CB 300 F ABS CB 300 R CBR 300 RA (ABS) CBR 300 R (Non ABS Model) DN-01 NSA700 A8/A9	11-13 11-13 15-17 18-20 18-21 18-21 14-21 18-20 08-11
MD1181 MD1181C	Rear Rear	Solid Solid	220 220	N/A N/A	Plain Contour	N/A N/A			CB 125 R CBR 250 RAB/RAC (ABS) CBR 300 RA (ABS) CB 300 FAF/FAG (ABS)	18-19 11-13 14-15 15-17
MD1182RS	Front	Solid	336	N/A	Plain	N/A			VTX 1300 C/T Cast wheel models VTX 1300 S (Spoke wheel models only)	03-08 03-08
MD1183 MD1183C VR1183 OSX1183	Front Front Front Front	Solid Solid Solid Floating	220 220 220 280	N/A N/A N/A Black	Plain Contour Vee Contour	N/A N/A N/A 6		BRK037	MSX 125 Grom (Non ABS)	13-21
MD1184 MD1184C VR1184	Rear Rear Rear	Solid Solid Solid	190 190 190	N/A N/A N/A	Plain Contour Vee	N/A N/A N/A			Monkey 125 MSX 125 D/E/F/G/H Grom (Non ABS) MSX 125 AH Grom (ABS)	18-21 13-21 18-21
MD1185C	Rear	Solid	240	N/A	Contour	N/A			CTX 700 DE-DCT CTX 700 N-DCT NC 700 DC- 700 Integra Scooter NC 700 SA (ABS) NC 700 SD (ABS/DCT) NC 700 S (Non ABS) NC 700 XA - (ABS)	14-21 14-21 12-14 12-13 12-14 12-13 12-13

STREETBIKE DISC BUYERS GUIDE

Disc No.	F/R	Type	Dia. (mm)	Hub Color	Profile	Bobbins	Left Bracket	Right Bracket	Model	Year
MD1185C Contd.	Rear	Solid	240	N/A	Contour	N/A			NC 700 XD - (ABS/DCT) NC 700 X (Non ABS) NC 750 S (NC 750 SE/NON ABS) NC 750 S (NC 750 SAE/ ABS) NC 750 S (NC 750 SDE/DCT ABS) NC 750 X (NC 750 XE/NON ABS) NC 750 X (NC 750 XAE/ ABS) NC 750 X (NC 750 XDE/DCT ABS) NC 750 D Integra Scooter - DCT	12-14 12-13 14-15 14-18 14-18 14-15 14-21 14-21 14-21
MD1186C	Front	Solid	320	N/A	Contour	N/A			CTX 700 N-DCT NC 700 S (Non ABS) NC 700 X (Non ABS) NC 750 X (NC 750 XE/NON ABS) NC 750 S (NC 750 SE/NON ABS)	14-21 12-13 12-13 14-15 14-15
MD1187C	Front	Solid	320	N/A	Contour	N/A			HONDA CB 500 F (Non ABS) CB 500 FA (ABS) CB 500 X (Non ABS) CB 500 XA (ABS) CBR 500 R (Non ABS) CBR 500 RA (ABS) CB 650 FAE/FAF/FAG/FAH/FAJ (ABS) CBR 650 FAE/FAF/FAG/FAH/FAJ (ABS) CTX 700 DE-DCT NC 700 DC- 700 Integra Scooter NC 700 SA (ABS) NC 700 SD (ABS/DCT) NC 700 XA - (ABS) NC 700 XD - (ABS/DCT) NC 750 S (NC 750 SAE/ ABS) NC 750 S (NC 750 SDE/DCT ABS) NC 750 X (NC 750 XAE/ ABS) NC 750 X (NC 750 XDE/DCT ABS) NC 750 D Integra Scooter - DCT ZERO Zero DS ZF13.0 Zero DS ZF6.0/ZF9.0 Zero DS II ZF14.4 Zero DS II ZF7.2 Zero DSR ZF13.0 Zero DSR ZF14.4.0 Zero DSR Black Forest Edition - ZF14.4.0 Zero FXS ZF3.3/ZF6.5 Zero S ZF14.4 Zero S ZF6.0 Zero S ZF7.2 Zero S ZF8.5/ZF11.4 Zero S ZF8.5/ZF11.4 Zero S ZF9.4/ZF12.5 Zero S ZF9.8/ZF13.0 Zero SR ZF11.4 Zero SR ZF12.5 Zero SR ZF13.0 Zero SR/F ZF13.0 Zero SR/S ZF13.0	13-20 13-20 13-20 13-20 13-20 13-20 14-18 14-18 14-21 12-14 12-13 12-14 12-13 12-14 14-18 14-18 14-21 14-21 14-21 16-19 10-12 19-20 19-20 17-19 19-20 19-20 19-20 17-20 19-20 10-12 19-20 13 14 15 16-19 14 15 16-20 19-20 19-20
MD1188X	Front	Floating	310	Gold	Plain	6			VFR 800 F (ABS Model) VFR 800 XF/XG/XH/XJ (Crossrunner) VFR 800 XH/XJ (Crossrunner) CTX 1300 AE	14-18 15-18 17-18 14-19
MD1189	Rear	Solid	256	N/A	Plain	N/A			VFR 800 XB/XC/XD (Crossrunner/ABS)	11-13
MD1190	Rear	Solid	256	N/A	Plain	N/A			VFR 800 XF/XG/XH/XJ (Crossrunner/ABS) VFR 800 F (ABS Model)	15-18 14-18
MD1191 MD1191C VR1191 OSX1191	Front Front Front Front	Solid Solid Solid Floating	220 220 220 250	N/A N/A N/A Floating	Plain Contour Vee Contour	N/A N/A N/A 5		BRK048	MSX 125 AH Grom (ABS) Monkey 125	18-20 18-20
MD1193X	Front	Floating	310	Gold	Plain	6			HONDA CB 1000 R ABS	17-21

STREETBIKE DISC BUYERS GUIDE

Disc No.	F/R	Type	Dia. (mm)	Hub Color	Profile	Bobbins	Left Bracket	Right Bracket	Model	Year
MD1194X MD1194XC	Front	Floating	310	Gold	Plain	6			HONDA CB 650 R (Non ABS) CB 650 RA (ABS) CBR 650 R (Non ABS) CBR 650 RA (ABS)	19-20 19-21 19-20 19-21
MD1195	Rear	Solid	190	N/A	Plain	N/A			TRX 420 All Models TRX 500 All Models	14-21 14-19
MD1196	Rear	Solid	256	N/A	Plain	N/A			HONDA CRF 1000 Africa Twin ABS CRF 1000 Africa Twin ABS DCT CRF 1000 Africa Twin ABS DCT CRF 1100 Africa Twin Adventure Sport ES ABS (Manual) CRF 1100 Africa Twin Adventure Sport ES ABS (DCT)	16-17 16-17 18-19 19-21 19-21
MD1197 Fitting Kit Required	Front	Solid	310	N/A	Plain	N/A			HONDA VFR 1200 XAC/XAD/XAE/XAF/XAH/XAJ Crosstourer (Manual G/Box) VFR 1200 XDC/XDCD/XDE/XDF/XDG/XDH/XDJ DCT Crosstourer VFR 1200 Crosstourer Highlander T/DCT	12-18 12-18 15-16
MD1198X	Front	Floating	310	Gold	Plain	6			HONDA CRF 1000 Africa Twin ABS CRF 1000 Africa Twin ABS DCT CRF 1000 Africa Twin ABS DCT CRF 1100 Africa Twin Adventure Sport ES ABS (Manual) CRF 1100 Africa Twin Adventure Sport ES ABS (DCT)	16-17 16-17 18-19 19-21 19-21
MD1199X	Front	Floating	320	Gold	Plain	6			HONDA CBR 1000 RR-SP C-ABS Nissin F/Caliper CBR 1000 RR-SP TT Edition ABS	17-20 16
MD1200C	Front	Solid	320	N/A	Contour	N/A			HONDA CB 650 F (Non ABS) CB 650 FA (ABS) CBR 650 F (Non ABS) CBR 650 FA (ABS) CB 500 F (Non ABS) CB 500 FA (ABS) CB 500 X (Non ABS) CB 500 XA (ABS) CBR 500 R (Non ABS) CBR 500 RA (ABS)	14-16 14-18 14-16 14-18 13-16 13-16 13-16 13-18 13-16 13-20
MD1201C	Front	Solid	320	N/A	Contour	N/A			HONDA CB 650 F (Non ABS) CB 650 FA (ABS) CBR 650 F (Non ABS) CBR 650 FA (ABS)	14-16 14-18 14-16 14-18
MD1202	Front	Floating	330	Gold	Plain	6			HONDA CBR 1000 RR-SP ABS Brembo F/Caliper (AC, 2AC)	20-21
MD1203	Rear	Solid	256	N/A	Plain	N/A			HONDA CB 1100 AD CB 1100 AE CB 1100 EX	13 14 14-21
MD2001X MD2001XC MD2001CC VR2001BLK VR2001BLU VR2001RED VR2001GOLD	Front Front Front Front Front Front	Floating Floating Floating Floating Floating Floating	299 299 299 299 299 299	Gold Gold Chrome Black Blue Red	Plain Contour Contour Vee Vee Vee	6 6 6 6 6 6			TZR 250 (3MA1 Reverse Cylinders) FZR 400 RR (4DX) FZ 400 (4YR1) FZR 400 (3TJI/2/6/7) FZR 400 (3ENZ) XJR 400 4HM1/4HM2/4HM4/4HM7 XJR 400 4HM3/4HM5/4HM6/4HM9/4HMA/4HMB FZR 600 FZR 600 R FZS 600 Fazer FZ 750 TDM 850 TRX 850 FJ 1200 (3CV/3XW Type) APRILIA RST Futura 1000	89 92 96 89 93-96 95-99 89-93 94-95 98-03 89-91 91-01 96-99 88-95 01-04

STREETBIKE DISC BUYERS GUIDE

Disc No.	F/R	Type	Dia. (mm)	Hub Color	Profile	Bobbins	Left Bracket	Right Bracket	Model	Year
MD2001X/XC/CC VR2001BLK/BLU/ RED/GOLD Contd.									DUCATI 900 Supersport 907 IE	89-90 90-91
MD2002 MD2002C VR2002	Rear Rear Rear	Solid Solid Solid	245 245 245	Gold Gold Gold	Plain Contour Vee	N/A N/A N/A			YAMAHA FZ 400 (4YR1) FZ 400 N (1FK/33M/46X) SRX 400 (1JL/3VN1/3VN2/3VN5) XJR 400 4HM1/4HM2/4HM4/4HM7 XJR 400 4HM3/4HM5/4HM6/4HM9/4HMA/4HMB FZ 600 FZR 600 FZR 600 R FZS 600 'Fazer' SRX 600 (1JK)/3SX) SRX 600 XJ 600 N XJ 600 S Diversion YZF 600 R Thundercat YZF 750 R/SP TDM 850 TRX 850 TDM 900 (5PS Non ABS) TDM 900 (2BO) (ABS) YZF 1000 R Thunderace DUCATI Supersport 400 400 Monster/Dark Monster 400 ie Monster 400 Monster Dark ie 400 600 Monster 600 Monster Dark 600 Monster City/City Dark 600 Supersport 620 IE Monster Monster 620 Dark Monster 620 620 Multistrada 620 Multistrada Dark Monster 696 20th Anniversary Model 750 Supersport 750 Supersport IE 750 Sport 750 Monster Monster ie 750 750 Monster City/City Dark 750 Monster/Monster Dark 750 Monster Supersport 750 Monster 800 800 Supersport 851 Superbike Biposto 888 SP4/SP5 888 Superbike Strada 900 Supersport 900 Supersport/Superlight 900 Supersport 900 Supersport CR USA 900 Supersport FE 900 Supersport IE 900 Sport 900 Monster 900 Monster Cromo/Special 900 Monster City/City Dark 900 IE Monster 907 IE ST2 (944cc) ST3 (Non ABS) (992cc) ST3 S (ABS Model) Monster 1000 Dark Monster 1000 ie (992cc) Monster 1000 S ie (992cc) Monster S4 Foggy Monster S4 916cc ST4 (916cc)	85/90-96 93-96 95-99 87-88 89-93 94-95 98-03 85/90-91 86-87 95-03 92-03 96-03 93-97 91-01 96-99 02-14 05-13 96-02 93-97 95-97/00-04 07-08 00-04 05-06 93-01 98-99 99 91-97 02-04 03-06 05-06 06 06 13 91-99 00-02 01-02 96-98 02 99 99 00-01 91-98 03-04 03-05 89-92 92-93 94-95 89-90 91-97 98-99 98 98 00-01 02 93-99 98 99 00-01 90-93 97-03 04-07 06-07 03 04-05 03-05 02 01-02 99-02

STREETBIKE DISC BUYERS GUIDE

Disc No.	F/R	Type	Dia. (mm)	Hub Color	Profile	Bobbins	Left Bracket	Right Bracket	Model	Year
MD2002 MD2002C VR2002 Contd.	Rear Rear Rear	Solid Solid Solid	245 245 245	Gold Gold Gold	Plain Contour Vee	N/A N/A N/A			YAMAHA Contd. Paul Smart 1000 LE Sport 1000 S Sport Classic 1000 (992cc) Supersport 1000 DS (992cc) LAVERDA 650 All models 668/750 All models TTS 800 VOXAN Black Magic Street Scrambler VB1-Evo Cafe Racer 1000 Roadster 1000	06 07-09 06-08 03-06 94-95 97-01 99-01 04-08 03-06 03-04 02-08 02-08
MD2003X MD2003XC MD2003CC VR2003BLK VR2003BLU VR2003RED	Front Front Front Front Front Front	Floating Floating Floating Floating Floating Floating	320 320 320 320 320 320	Gold Gold Chrome Black Blue Red	Plain Contour Contour Vee Vee Vee	6 6 6 6 6 6			TDR 125 3HS1/3XD1/3SH3/3XD1 TDR 125 R Lightburner (3SH2/3XE2) TZR 125 R Brembo Caliper (4DL1/4DL2) TZR 250 TDR 250 (3CK1/3CK2 Europe) TZR 250 (2MA/2XW1/2XW2 Europe) TZR 250 (1KT/2AW Japan) TZR 250 (2XT1 Japan) SRX 400 (3VN1/3VN2/3VN5) SRX 600 (3SX) SZR 660 FZR 750 Genesis YZF 750 R/SP FZR 1000 Genesis FZR 1000 EX-UP XJR 1200 XJR 1300 5EA1/5EA7 APRILIA MX 125 RS 125 Tuono 125 RS 660 8V ABS RS 660 8V Tuono ABS Dorsoduro 900 ABS Shiver 900 ABS RSV4R RSV4R APRC RSV4R APRC ABS RSV4 Factory RSV4 Factory APRC RSV4 Factory APRC ABS RSV4 RF 1000 RSV4 RR 1000 Tuono V4R Tuono V4R APRC Tuono V4R APRC ABS Tuono Factory 1100 V4 Tuono RR 1100 V4 Caponord 1200 cast wheels Dorsoduro 1200 Dorsoduro 1200 ATC/ABS BENELLI 302 R 302 S BN 302 TNT 300 Tornado Naked T 300 402 S BN 600 GT Tornado Naked TRE R 1130 Tornado Naked TRE TNT R 1130 TRE-K 1130 Amazonas BIMOTA DB 5 All models DB 6 Delirio 922cc Ducati Engine SB8K Gobert (Suzuki Engine) (996cc) DB6R Delirio (1100cc) DUCATI Supersport 400 600 Supersport 620 Multistrada Dark	89-93 93-94 91-93 87- 88-92 87-92 87 88 90-96 90-91 96-97 87 93-97 87-88 89-95 95-98 98-99 04-06 92-05 03-04 20-21 20-21 17-21 17-21 10 11-13 11-14 09-10 11-13 11-14 15-18 15-18 11-12 11-13 13-14 15-16 15-16 13-16 11-12 11-14 17-20 18-20 15-16 16-18 2018 14-17 09-12 13-16 07-15 06-07 07 06 08 93-97 91-97 06

STREETBIKE DISC BUYERS GUIDE

Disc No.	F/R	Type	Dia. (mm)	Hub Color	Profile	Bobbins	Left Bracket	Right Bracket	Model	Year
MD2003X/XC/CC VR2003BLK/BLU/ RED Contd.									DUCATI Contd. 748 SP 916 SPS (996cc) LAVERDA 650 All models 668/750 All models	95-97 97-98 94-95 97-01
MD2008 MD2009LS MD2009RS	Rear Front Front	Solid Floating Floating	210 320 320	N/A Silver Silver	Plain Plain Plain	N/A 9 9			YAMAHA FZR 750 R 'OWO1' FZR 750 R 'OWO1'	89-90 89-90
MD2011 MD2011C VR2011	Front Front Front	Solid Solid Solid	267 267 267	N/A N/A N/A	Plain Contour Vee	N/A N/A N/A			RZ 250 R (1AR/1XG/2GL) RZ 250 RR (5K) RD 350 YPVS RD 350 F/F2 R 350 N RD 350 R FZ 400 N (IFK/33M/46X) SRX 400 (1J6) XS 400 XZ 550 FZ 600 SRX 600 (1JK) SRX 600 XJ 600 XX 600 S/SC/T/TC/U/UC/W/WC/A/AC 'Radian' XJ 650 Turbo XJ 650 LX 'Seca' FZX 700 S/SC/T/TC 'Fazer' FZ 750 FZX 750 XV 750 Virago XJ 900 F XV 1000 Virago XV 1000 SE Virago XV 1100 Virago NORTON Commander (Rotary)	83-84 85-92 85 92-95 85- 85 82 82-84 87-88 85 86-87 84-91 86-90 82 83 86-87 87-88 87 92-93 87-92 86 88 89-93 90
MD2011 MD2011C VR2011	Rear Rear Rear	Solid Solid Solid	267 267 267	N/A N/A N/A	Plain Contour Vee	N/A N/A N/A			YAMAHA RZ 250 R (1AR/1XG/29L) RZ 250 RR (51C) RD 350 YPVS RD 350 F/F2 RD 350 N RD 350 R XP 500 N/P/R T-Max XP 500 S/T/V T-Max (5VU1/2) XP 500 T-Max (Non ABS models) XP 500 T-Max (ABS Models) XJ 600 FZ 750 FZR 750 Genesis XJ 900 S 'Diversion' FZR 1000 Genesis FZR 1000 EX-UP FZS 1000 Fazer BT 1100 Bulldog P/R/S/T/V XV 1100 XVS 1100 Dragstar XVS 1100 A Dragstar Classic XJR 1200 FJR 1300 N/P/R/AR/S/AS XJR 1300 5EA1/5EA7 XJR 1300 C/Racer XJR 1300 L 5EA2/5EA3/5EA4 XJR 1300 M 5EAA/5EAB/5EAC XJR 1300 (5EA9/5EAG) XJR 1300 N/P (5EAP/5EAR/5EAS/5EAT/5EAW/5EAW/5EAY) XJR 1300 R/S 5WM1/5WM3/5WM5/5WM6/5WM7/5WM9 XJR 1300 T/V/W/X/Y 5WMA/5WMC/5WMD/5WMMF XJR 1300 SP (L) 5EA5/5EA6/5EA8 XJR 1300 SP (M) 5EAD/5EAE/5EAF XJR 1300 SP (N) 5EAL/5EAM/5EAN MT-01 (1670 cc) MT-01S (5YUR)	83-84 85-92 85 92-95 01-03 04-07 08-11 08-11 84-91 87-91 87 95-03 87-88 89-95 01-05 02-06 99 99-01 00-01 95-98 01-10 98-99 15-16 99 00 00 01-02 03-04 05-14 99 00 01 05-10 09

STREETBIKE DISC BUYERS GUIDE

Disc No.	F/R	Type	Dia. (mm)	Hub Color	Profile	Bobbins	Left Bracket	Right Bracket	Model	Year
MD2012	Front	Solid	320	N/A	Plain	N/A			XJ 900 S Diversion	95-03
MD2019LS MD2019RS	Front Front	Floating Floating	266 266	Silver Silver	Plain Plain	9 9			RD 250/350 LC RZ 250 (4L3) SR 250 Classic (21L) XS 250 C XS 250 D/E XS 250 SE/SF XV 250 Virago RD 350 LC XS 360 C XS 400 C XS 400 XS 400 SE XJ 550 XJ 650 RJ 'Seca' XJ 650 XV 1000 Tri	80-83 96-00 78 79-81 79-81 89-94 80-82 76 78 79 80-81 81-84 82 80-84 81
MD2019RS	Rear	Floating	266	Silver	Plain	9			XS 250 C XS 360 C XS 400 C	78 76 78
MD2020LS / RS	Front	Floating	282	Silver	Plain	9			FZR 400 Genesis (1WG)	86
MD2021 MD2021C VR2021	Rear Rear Rear	Solid Solid Solid	210 210 210	N/A N/A N/A	Plain Contour Vee	N/A N/A N/A			TZR 125 TZR 125 R TDR 125 R Lightburner (3SH2/3XE2) TZR 125 R Brembo Caliper (4DL1/4DL2) TZR 150 R SDR 200 (2TV) FX 250 Zeal (3YX1/2/4) FZR 250 R TZ 250 TDR 250 (3CK1/3CK2 Europe) TZ 250 TZR 250 (2MA/2XW1/2XW2 Europe) TZR 250 (1KT/2AW Japan) TZR 250 (2XT1 Japan) TZR 250 (3MA1 Reverse Cylinders) TZR 250 (3MA3/3MA5 Reverse Cylinder) TZR 250 SP (3MA4) TZR 250 R (3XV1/3X4/3XV6) V-Twin TZR 250 RS (3XV8/3XV9/3XVA) V-Twin TZR 250SPR (3XVC) V-Twin FZR 250 FZR 400 Genesis (1WG) FZR 400 RSP (2TK EX-UP) FZR 400 (3EN1/2) FZR 400 RR (3TJ1/2/6/7) FZR 400 RR (4DX) SZR 660	90-92 93- 93-94 91-93 00 87-89 91-92 91 88-92 91 87-92 87 88 89 90 90 91-93 92-94 95 86 87 88-89 92 96-97
MD2022LS MD2022RS	Front Front	Floating Floating	282 282	Gold Gold	Plain Plain	9 9			TZR 125 R FZR 250 R (3LN) R1-Z (250cc/3XC) FZR 400 RSP (2TK EX-UP) FZR 400 (3EN1)	93- 90-92 87 88
MD2023LS MD2023RS VMD2023	Front Front Front	Floating Floating Floating	299 299 299	Silver Silver Black	Plain Plain Plain	9 9 9			SR 500 XV 535 Virago XJ 550 H/J/K 'Maxim' XJ 550 RH/RJ/RK 'Seca' XJ 650 G/H/J/K 'Maxim' XJ 650 LH 'Midnight' XJ 750	78-82 88-94 81-83 81-83 80-83 81 81-84
MD2024 VMD2024	Front Front	Floating Floating	299 299	Silver Black	Plain Plain	9 9			XS 500 C/D XS 650 SE XV 750 SE XS 850 XS 1100 XS 1100 S XS 1100 SG	78-79 79- 81 80 78-80 81 80

DISC BUYERS GUIDE

STREETBIKE DISC BUYERS GUIDE

Disc No.	F/R	Type	Dia. (mm)	Hub Color	Profile	Bobbins	Left Bracket	Right Bracket	Model	Year
MD2024 VMD2024	Rear Rear	Floating Floating	298 298	Silver Black	Plain Plain	9 9			XS 1100 XS 1100 S XS 1100 SG	78-80 81 80
MD2025LS MD2025RS VMD2025 SILVER	Front Front Front	Floating Floating Floating	266 266 266	Silver Silver Black	Plain Plain Plain	9 9 9			RD 250 E/F RD 400 E/F XS 650 XS 650 SE XS 750 XS 750 SE	78-79 78-79 77-81 79-80 77-79 79-80
MD2025 VMD2025	Rear Rear	Floating Floating	266 266	Silver Black	Plain Plain	9 9			RD 250 E/F RD 400 E/F XS 500 C/D XS 750 XS 750 SE	78-79 78-79 78-79 77-79 79-80
MD2031LS	Front	Solid	320	N/A	Plain	N/A			XJ 600 N XJ 600 S Diversion	95-97 92-97
MD2033LS/RS									USE MD2011	
MD2044LS/RS									USE MD2024LS/RS	
MD2044									USE MD2024	
MD2046 MD2047	Front	Floating	299	Silver	Plain	9			FJ 1200 A (ABS model) USE MD2074	91-95
MD2053RS	Front	Solid	245	N/A	Plain	N/A			RD 125 LC (MK2/3) RG 125 (1GV 030101-) TZR 125	85-87 85 87-89
MD2055RS									USE MD2053RS	
MD2056RS	Front	Solid	267	N/A	Plain	N/A			TZR 125 SDR 200 (2TV) SRX 250 (51Y/52E/1JA)	90-92 87-89
MD2057									USE MD2021	
MD2058LS/RS									USE MD2011	
MD2058									USE MD2011	
MD2067	Front	Solid	280	N/A	Plain	N/A			TZR 50 'Thunderkid' (SDU1/3) TZR 50 X-Power XV 125 Virago XVS 125 Dragstar SRV 250 "Soulful/twin/Renaissa" XV 250 S Virago XVS 250 Dragstar XV 750 Virago XV 1100 Virago MASH 400 Roadstar (Five Hundred)	97-00 00 97-00 00-04 92-97 95-00 01-04 94-97 94-99 14-18
MD2068 Billet	Front	Solid	282	N/A	Plain	N/A			FJ 1100 FJ 1200 (ITX)	84-85 86-87
MD2068 Billet	Rear	Solid	282	N/A	Plain	N/A			FJ 1100 FJ 1200 (ITX/3CV/3XW) FJ 1200 A (ABS Model) V MAX 12 'All models'	84-85 86-95 91-95 91-02
MD2069 Billet	Front	Solid	267	N/A	Plain	N/A			RD 500 LC RZV 500 R (SIX) FZ 750 XJ 900/900F	84-86 85 85-86 83-86
MD2069 Billet	Rear	Solid	267	N/A	Plain	N/A			FZX 700 S/SC/T/TC 'Fazer' FZ 750 FZX 750 NORTON Commander (Rotary)	86-87 85-86 87 90
MD2070 Billet	Rear	Solid	245	N/A	Plain	N/A			RD 500 LC RZV 500 R (SIX)	84-86 85
MD2073RS									USE MD2022RS	

STREETBIKE DISC BUYERS GUIDE

Disc No.	F/R	Type	Dia. (mm)	Hub Color	Profile	Bobbins	Left Bracket	Right Bracket	Model	Year
MD2074X	Front	Floating	299	Gold	Plain	6			YZF 600 R Thunder Cat	96-03
MD2074XC	Front	Floating	299	Gold	Contour	6			XJ 600 S 'Diversion'	98-03
MD2074CC	Front	Floating	299	Chrome	Contour	6			XJ 600 N	98-03
VR2074BLK	Front	Floating	299	Black	Vee	6			YZF 600 R 'R6'	99-02
VR2074BLU	Front	Floating	299	Blue	Vee	6			TDM 900 (SPS) (Non ABS)	02-14
VR2074RED	Front	Floating	299	Red	Vee	6			TDM 900 (2B0) (ABS)	05-13
VR2074CHBL	Front	Floating	299	Blue	Vee	6			XV 950 R - XVS 950 R (2DE/Remote Reservoir Rear Shocks)	14-18
									FZS 1000 Fazer	01-04
									YZF 1000 R Thunder Ace	96-02
									YZF 1000 R1	98-03
									BT 1100 P/R/S/T/V Bulldog	02-06
									FJR 1300 (Non ABS) (5JW)	01-02
									XJR 1300 C/Racer	15-16
									XJR 1300 L 5EA2/5EA3/5EA4	99
									XJR 1300 M 5EAA/5EAB/5EAC	00
									XJR 1300 (5EA9/5EAG)	00
									XJR 1300 N/P (5EAP/5EAR/5EAS/5EAT/5EAW/5EAW/5EAY)	01-02
									XJR 1300 R/S 5WM1/5WM3/5WM5/5WM6/5WM7/5WM9	03-04
									XJR 1300 T/V/W/X/Y 5WMA/5WMC/5WMD/5WMF	05-14
									XJR 1300 SP (L) 5EA5/5EA6/5EA8	99
									XJR 1300 SP (M) 5EAD/5EAE/5EAF	00
									XJR 1300 SP (N) 5EAL/5EAM/5EAN	01
									XVS 1300 A Midnight Star	07-16
									XVS 1300 ACFD Midnight Star/Casual Full Dresser (With Handbar Fairing)	14-16
									XV 1700 PCR Road Star Warrior	03-05
									XV 1900 A	06-08
MD2075 Billet	Rear	Solid	280	N/A	Plain	N/A			GTS 1000	93-99
MD2076	Front	Solid	298	N/A	Plain	N/A			XVS 400	96
									SR_400 (2RD)	14-17
									XV 535/535 S Virago	95-03
									XVS 650 Drag star	97-04
									XVS 650 A Dragstar Classic	98-07
									XVS 1100 Dragstar	99-04
									XVS 1100 A Dragstar Classic	00-07
									XVZ 13 AH/ATH Royal Star	96-00
									XVZ 1300 TF 'Venture Star'	99-01
									XV 1600 A 'Wildstar'	99-04
MD2077	Rear	Solid	203	N/A	Plain	N/A			TZR 50 'Thunderkid' (5DU1/3)	97-00
									TZR 50 X-Power	00
MD2078 Billet	Rear	Solid	320	N/A	Plain	N/A			XVZ 13 AH/ATH Royal Star	96-00
									XVZ 1300 TF 'Venture Star'	99-01
MD2081 Billet	F & R	Solid	298	N/A	Plain	N/A			XVZ 12 TD	85
									XVZ 12 TD	85
MD2082X	Front	Floating	299	Gold	Plain	6			YZF R6	03-04
MD2082XC	Front	Floating	299	Gold	Contour	6			MT-03 (660cc)	06-12
MD2082CC	Front	Floating	299	Chrome	Contour	6			FZ6 Naked/Non ABS 2 Piston Caliper (IB3/IB3D)	04-07
VR2082BLK	Front	Floating	299	Black	Vee	6			FZ6-NS Naked/Non ABS/2 Piston Caliper (IB35/6)	05-06
VR2082BLU	Front	Floating	299	Blue	Vee	6			FZ6-Fazer (Half Fairing/Non ABS/2 Piston Caliper) (5VX/5VXL)	04-07
VR2082RED	Front	Floating	299	Red	Vee	6			FZ6 Fazer (ABS/Half Fairing/2 Piston Caliper)	06-07
									FZ6 Fazer S2 (ABS/Half Fairing/4 Piston Caliper)	08
									FZ6 Fazer S2 (Non ABS/Half Fairing/4 Piston Caliper) (4S81/4S8)	07-09
									FZ6 S2 (Non ABS/Half Fairing/4 Piston Caliper) (5S51/5S5)	07-09
									XJ6-N (600cc) (Naked - 20S ABS/Non ABS)	09-12
									XJ6-N Diversion 6 (Naked Diversion Non ABS & ABS Models)	13-15
									XJ6-S Diversion (600cc) (Top Fairing ABS/NonABS)	09-15
									XJ6-SP	13
									XJ6-F Diversion (600cc) (Full Fairing ABS/NonABS)	10-15
MD2083	Front	Floating	320	Gold	Plain	9			YZF-R7 750 'OW02'	99-00
MD2084	Rear	Solid	220	N/A	Plain	N/A			YZF 600 R 'R6'	99-02
MD2084C	Rear	Solid	220	N/A	Contour	N/A			YZR 1000 R1	02-03
VR2084	Rear	Solid	220	N/A	Vee	N/A				
MD2085LS	Front	Solid	267	N/A	Plain	N/A			SR 125	97-03
	Front	Solid	267	N/A	Vee	N/A				

STREETBIKE DISC BUYERS GUIDE

Disc No.	F/R	Type	Dia. (mm)	Hub Color	Profile	Bobbins	Left Bracket	Right Bracket	Model	Year
MD2086 MD2086C VR2086	Rear Rear Rear	Solid Solid Solid	245 245 245	N/A N/A N/A	Plain Contour Vee	N/A N/A N/A			YZF R7 OW02 (Road version) YZF R1	99-01 98-01
MD2087LS	Front Front	Solid Solid	282 282	N/A N/A	Plain Vee	N/A N/A			XP 500 N/P/R/S T-Max	01-04
MD2088 Billet	Rear	Solid	320	N/A	Plain	N/A			XV 1600 A Wildstar	99-04
MD2089X MD2089XC MD2089CC VR2089BLK VR2089BLU VR2089RED	Front Front Front Front Front Front	Floating Floating Floating Floating Floating Floating	320 320 320 320 320 320	Gold Gold Chrome Black Blue Red	Plain Contour Contour Vee Vee Vee	6 6 6 6 6 6			XVS 950 A Midnight Star FJR 1300 (Non ABS/5JW) FJR 1300 A (ABS) (3P6 Model) FJR 1300 A (ABS) (ICY) FJR 1300 A (ABS) (5VS) FJR 1300 A (1MC/ABS/Manual G/Shift) FJR 1300 AE (Electronic Suspension Adjustment/USD Forks) FJR 1300 AS (ABS/Electric Shift)	09-12 03-04 06-09 10-12 03-05 13-19 14-21 06-18
MD2090LS/RS									USE MD2074	
MD2091 MD2091C VR2091	Rear Rear Rear	Solid Solid Solid	220 220 220	N/A N/A N/A	Plain Contour Vee	N/A N/A N/A			YZF R6 YZF R1 MT-10 (MTN 1000/998cc) MT-10 Tourer Edition (998cc) MT-10 SP (MTN 1000D/998cc)	03-21 04-14 16-20 18-20 17-21
MD2092 MD2092C VR2092	Rear Rear Rear	Solid Solid Solid	282 282 282	N/A N/A N/A	Plain Contour Vee	N/A N/A N/A			XVS 1100 Dragstar XVS 1100 A Dragstar Classic FJR 1300 A (ABS) (5VS) FJR 1300 (Non ABS) (5JW) XV 1700 PCR Road Star Warrior	99-04 00-07 03-05 01-04 03-05
MD2093 MD2093C VR2093	First First First	Solid Solid Solid	245 245 245	N/A N/A N/A	Plain Contour Vee	N/A N/A N/A			FZ1 (2D1) (Naked) Non ABS FZ1 Fazer (3C3) (Half fairing) FZ1 Fazer (Half Fairing - ABS - 5D0) FZ1 N/NA Naked (Non ABS/ABS) FZ6 Naked/Non ABS 2 Piston Caliper (IB3/IB3D) FZ6-NS Naked/Non ABS/2 Piston Caliper (IB35/6)	06-09 06-15 08-15 10-15 04-07 05-06
MD2093 MD2093C VR2093	Rear Rear Rear	Solid Solid Solid	245 245 245	N/A N/A N/A	Plain Contour Vee	N/A N/A N/A			FZ6-Fazer (Half Fairing/Non ABS/2 Piston Caliper) (5VX/5VXL) FZ6 Fazer (ABS/Half Fairing/2 Piston Caliper) FZ6 Fazer S2 (ABS/Half Fairing/4 Piston Caliper) FZ6 Fazer S2 (Non ABS/Half Fairing/4 Piston Caliper) (4S81/4S8) FZ6 S2 (Non ABS/Half Fairing/4 Piston Caliper) (5S51/5S5) MT-03 (660cc)	04-07 06-07 08 07-09 07-09 06-12
MD2094X MD2094XC MD2094CC VR2094BLK VR2094BLU VR2094RED MD2095X MD2095XC MD2095CC VR2095BLK VR2095BLU VR2095RED	Front Front Front Front Front Front Front Front Front Front Front Front	Floating Floating Floating Floating Floating Floating Floating Floating Floating Floating Floating Floating	320 320 320 320 320 320 310 310 310 310 310 310	Gold Gold Chrome Black Blue Red Gold Gold Chrome Black Blue Red	Plain Contour Contour Vee Vee Vee Plain Contour Contour Vee Vee Vee	6 6 6 6 6 6 6 6 6 6 6 6			YZF R1 YZF R6 FZ 8 N-800cc (Naked/Single Headlight/Non ABS) FZ 8 NA-800cc (Naked/Single Headlight/ABS) Fazer 8 S-800cc (Top Fairing/Twin Headlight/Non ABS) XT 1200 Z Super Tenere (ABS/UBS Brake System) XT 1200 ZE Super Tenere (ABS/UBS Brake System) XT 1200 ZE Super Tenere Raid Edition (ABS/UBS Brake System)	04-06 05-07 11-15 11-15 11-15 10-17 14-17 18
MD2097RS	Front	Solid	245	N/A	Plain	N/A			YBR 125 ED (3D91)	05-06
MD2098 MD2098C 5 Bolt Fixing	Front	Floating	267	Gold	Plain	5			T-Max XP 500 XP 500 - T-Max 500 (530cc Engine Non ABS Models) XP 500 A T-Max (530cc Engine/ ABS Models) XP 530 Black/Bronze Max (59CE) XP 530 A (530cc Engine - Iron Max - ABS Model) XP 500 A T-MAX - LUX MAX (ABS) XP 530E-A T-Max (530cc Engine - ABS Model) XP 530-A T-Max SX (530cc Engine - ABS Model) XP 530D-A T-Max DX (530cc Engine - ABS Model)	04-07 12-15 12-16 13-14 15-16 16 17-18 17-18 17-18
MD2099	Rear	Solid	320	N/A	Plain	N/A			XV 1900 A Midnight Star XV 1900 ACFD Midnight Star/Casual Full Dresser (With Handlebar Fairing) /Handlebar Fairing	06-16 14-16 13-15

STREETBIKE DISC BUYERS GUIDE

Disc No.	F/R	Type	Dia. (mm)	Hub Color	Profile	Bobbins	Left Bracket	Right Bracket	Model	Year
MD2100 MD2100C VR2100	Rear Rear Rear	Solid Solid Solid	282 282 282	N/A N/A N/A	Plain Contour Vee	N/A N/A N/A			FJR 1300 A (ABS) (3P6 Model) FJR 1300 A (ABS) (ICY) FJR 1300 A (1MC/ABS/Manual G/Shift) FJR 1300 AE (Electronic Suspension Adjustment/USD Forks) FJR 1300 AS (ABS/Electric Shift)	06-09 10-12 13-19 14-21 06-18
MD2101X MD2101XC VR2101BLK VR2101BLU VR2101RED	Front Front Front Front Front	Floating Floating Floating Floating Floating	320 320 320 320 320	Gold Gold Black Blue Red	Plain Contour Vee Vee Vee	6 6 6 6 6			FZ1 (2D1) (Naked) FZ1 Fazer (3C3) Half fairing (Non ABS) FZ1 Fazer (Half Fairing - ABS - 5D0) FZ1 N/NA Naked (Non ABS/ABS)	06-09 06-15 08-15 10-15
MD2102X MD2102XC MD2102CC VR2102BLK VR2102BLU VR2102RED	Front Front Front Front Front Front	Floating Floating Floating Floating Floating Floating	310 310 310 310 310 310	Gold Gold Chrome Black Blue Red	Plain Contour Contour Vee Vee Vee	6 6 6 6 6 6			YZF R1	07-14
MD2103 MD2103C VR2103	Rear Rear Rear	Solid Solid Solid	298 298 298	N/A N/A N/A	Plain Contour Vee	N/A N/A N/A			XVS 950 A Midnight Star XVS 1300 A Midnight Star XVS 1300 CU Custom XVS 1300 ACFD Midnight Star/Casual Full Dresser (With Handbar Fairing)	09-13 07-16 14-17 14-16
MD2104RS	Front	Solid	245	N/A	Plain	N/A			YBR 125 Custom YBR 125 (3D92/9) YBR 125 (51D1/2) YS 125 HONLEY HD1 125 HD2 125 HD3 125 HD3 SE 125	07-16 07-09 10-16 17-21 14-15 16-17 16-17 16-17
MD2105X MD2105XC VR2105BLK VR2105BLU VR2105RED	Front Front Front Front Front	Floating Floating Floating Floating Floating	310 310 310 310 310	Gold Gold Gold Gold Gold	Plain Plain Plain Plain Plain	6 6 6 6 6			YAMAHA YZF R1 YZF R6	09-14 08-16
MD2106RS	Front	Solid	280	N/A	Plain	N/A			YBR 250 (5D11/3/4)	07-11
MD2107 MD2107C	Front Front	Floating Floating	267 267	Black Black	Plain Contour	6 6			XP 500 T-Max (Non ABS Models) XP 500 T-Max (ABS Models)	08-11 08-11
MD2108C	Rear	Floating	298	Gold	Contour	6			XV 1700 V-Max	09-21
MD2109XC	Front	Floating	320	Gold	Contour	6			XV 1700 V-Max	09-21
MD2110LS	Front	Solid	290	N/A	Plain	N/A			YZF-R 125	08-13
MD2111	Rear	Solid	230	N/A	Plain	N/A			YZF-R 125	08-13
MD2112X	Front	Floating	320	Black	Plain	6			YZF-R1 SP (4B1) KTM 1290 Super Duke GT 1290 Super Duke R 1290 Super Duke R SE	06 16-21 14-21 16-21
MD2113	Rear	Solid	220	N/A	Plain	N/A			YAMAHA TZR 50 X Power TZR 50	03-10 03-16
MD2114									USA ONLY	
MD2115C	Rear	Solid	280	N/A	Contour	N/A			YAMAHA XT 1200 Z Super Tenere (ABS/UBS Brake System) XT 1200 ZE Super Tenere (ABS/UBS Brake System) XT 1200 ZE Super Tenere Raid Edition (ABS/UBS Brake System)	10-17 14-17 18
MD2116 MD2116C VR2116	Rear Rear Rear	Solid Solid Solid	267 267 267	N/A N/A N/A	Plain Contour Vee	N/A N/A N/A			FZ 8 N-800cc (Naked/Single Headlight/Non ABS) FZ 8 NA-800cc (Naked/Single Headlight/ABS) Fazer 8 S-800cc (Top Fairing/Twin Headlight/Non ABS) Fazer 8 S-800cc (Top Fairing/Twin Headlight/ABS)	11-15 11-15 11-15 11-15

STREETBIKE DISC BUYERS GUIDE

Disc No.	F/R	Type	Dia. (mm)	Hub Color	Profile	Bobbins	Left Bracket	Right Bracket	Model	Year
MD2117	Rear	Solid	245	N/A	Plain	N/A			XJ6-N Diversion 600 (Naked Diversion - Non ABS & ABS Models - 20S)	09-12
VR2117	Rear	Solid	245	N/A	Vee	N/A			XJ6-N Diversion 600 (Naked Diversion - Non ABS/ ABS Models) XJ6-F Diversion 600 (Full Fairing Diversion - Non ABS & ABS Models) XJ6-S Diversion 600 (Top Fairing Diversion - Non ABS & ABS Models) XJ6-SP	13-15 10-15 09-15 13
MD2118	Rear	Solid	220	N/A	Plain	N/A			YZF-R1SP	06
MD2119X MD2119XC VR2119BLK R2119BLU VR2119RED	Front Front Front Front Front	Floating Floating Floating Floating Floating	298 298 298 298 298	Gold Gold Black Blue Red	Plain Contour Vee Vee Vee	6 6 6 6 6			MTN 320 A (MT-03 321cc) YZF-R3 (321cc/ABS) YZF-R7 MT-09 (1RC/Non ABS 847cc/3 Cyl Engine) MT-09 (2DR/ABS 847cc/3 Cyl Engine) MT-09 Sport Tracker ABS (847cc/3 Cyl Engine) MT-09 Street Rally ABS (847cc/3 Cyl Engine) MT-09 ABS (MT850-A 847cc/3 Cyl Engine) MT-09 SP ABS (MT850-D 847cc/3 Cyl Engine) MT-09 Tracer 900 ABS (847cc/3 Cyl Engine) MT-09 Tracer 900 GT ABS (847cc/3 Cyl Engine) XSR 900 ABS (MTM 850) XSR 900 Abarth ABS (MTM 850)	16-21 15-21 2022 14-16 14-16 14-16 14-16 17-21 18-21 15-21 18-21 16-21 17-18
MD2120 MD2120C VR2120	Rear Rear Rear	Solid Solid Solid	245 245 245	N/A N/A N/A	Plain Contour Vee	N/A N/A N/A			MT-07 (Non ABS/689cc/ 2 Cyl) MT-07A (ABS/689cc/ 2 Cyl) MT-07 Motocage (ABS/689cc/ 2 Cyl) MT-07A Moto Cage (Non ABS) Tracer 700 (MTT 690) XSR 700 ABS (MTM 690-U) XT 700 Z Tenere MT-09 (1RC/Non ABS 847cc/3 Cyl Engine) MT-09 (2DR/ABS 847cc/3 Cyl Engine) MT-09 Sport Tracker ABS (847cc/3 Cyl Engine) MT-09 Street Rally ABS (847cc/3 Cyl Engine) MT-09 ABS (MT850-A 847cc/3 Cyl Engine) MT-09 SP ABS (MT850-D 847cc/3 Cyl Engine) Tracer 900 ABS (847cc/3 Cyl Engine) Tracer 900 GT ABS (847cc/3 Cyl Engine) XSR 900 ABS (MTM 850) XSR 900 Abarth ABS (MTM 850)	14-16 14-21 15-17 14-16 16-21 16-21 18-21 14-16 14-16 14-16 14-16 14-16 17-20 18-20 15-21 18-21 16-21 17-20
MD2121X	Front	Floating	290	Gold	Plain	6			YZF-R 125 (Radial F/Caliper/Non ABS) YZF-R 125 A (Radial F/Caliper/ABS) MT -125 (Non ABS) MT -125 A (ABS)	14-16 14-21 14-16 14-21
MD2122	Rear	Solid	230	N/A	Plain	N/A			YZF-R 125 (Radial F/Caliper/Non ABS) YZF-R 125 A (Radial F/Caliper/ABS) MT -125 (Non ABS) MT -125 A (ABS)	14-16 14-21 14-16 14-21
MD2123 MD2123C VR2123	Rear Rear Rear	Solid Solid Solid	220 220 220	N/A N/A N/A	Plain Contour Vee	N/A N/A N/A			YZF-R3 (321cc/ABS) MTN 320 A (MT-03 321cc)	15-21 16-21
MD2124X MD2124XC VR2124BLK VR2124BLU VR2124RED	Front Front Front Front Front	Floating Floating Floating Floating Floating	320 320 320 320 320	Gold Gold Black Blue Red	Plain Contour Vee Vee Vee	6 6 6 6 6			YZF-R6 YZF- R1 YZF- R1M YZF-R1 (60th Anniversary Edition) MT-10 (MTN 1000/998cc) MT-10 Tourer Edition (998cc) MT-10 SP (MTN 1000D/998cc)	17-21 15-21 15-21 16 16-20 18-20 17-21
MD2125 MD2125C VR2125	Rear Rear Rear	Solid Solid Solid	220 220 220	N/A N/A N/A	Plain Contour Vee	N/A N/A N/A			YZF- R1 YZF- R1M YZF-R1 (60th Anniversary Edition)	15-21 15-21 16
MD2126X MD2126XC VR2126BLK VR2126BLU VR2126RED	Front Front Front Front Front	Floating Floating Floating Floating Floating	320 320 320 320 320	Gold Gold Black Blue Red	Plain Contour Vee Vee Vee	6 6 6 6 6			MT-01 (1670cc) (4 piston caliper)	05-06

STREETBIKE DISC BUYERS GUIDE

Disc No.	F/R	Type	Dia. (mm)	Hub Color	Profile	Bobbins	Left Bracket	Right Bracket	Model	Year
MD2127X MD2127XC VR2127BLK VR2127BLU VR2127RED	Front Front Front Front Front	Floating Floating Floating Floating Floating	282 282 282 282 282	Gold Gold Black Blue Red	Plain Contour Vee Vee Vee	6 6 6 6 6			MT-07 (Non ABS/689cc/ 2 Cyl) MT-07A (ABS/689cc/ 2 Cyl) MT-07 Motocage (ABS/689cc/ 2 Cyl) MT-07 Motocage (Non ABS/689cc/ 2 Cyl) Tracer 700 (MTT 690) XSR 700 ABS (MTM 690-U) XT 700 Z Tenere	14-16 14-21 15-18 15-16 16-21 16-18 19-21
MD2128X MD2128XC VR2128BLK VR2128BLU VR2128RED	Front Front Front Front Front	Floating Floating Floating Floating Floating	282 282 282 282 282	Gold Gold Black Blue Red	Plain Contour Vee Vee Vee	6 6 6 6 6			MT-01 (6 piston radial caliper) MT-01 S (6 piston radial caliper/5YUR)	07-09 09
MD2129X MD2129XC	Front Front	Floating Floating	298 298	Gold Gold	Plain Contour	6 6			V-Max 12	93-03
MD2133	Front	Floating	260	Silver	Plain	9			TZ250	97-01
MD2130C	Rear	Solid	298	N/A	Contour	N/A			SCR 950 (XVS 950XR-A) XV 950 - XVS 950 (Non ABS/Standard Rear Shocks) XV 950 CU - XVS 950 (1XC1/ABS/Standard Rear Shocks) XV 950 R - XVS 950 R (2DE/Remote Reservoir Rear Shocks) XV 950 Racer (Remote Reservoir Rear Shocks)	17-18 14 14-16 14-18 15-16
MD3001	Front	Solid	290	N/A	Plain	N/A			SUZUKI GSXR 400 H GSX 400 RS (GK71F) GSX 400 X/XA/XS GSX 600 FJ	87 88
MD3002 MD3002C VR3002	Rear Rear Rear	Solid Solid Solid	250 250 250	N/A N/A N/A	Plain Contour Vee	N/A N/A N/A			GSF 250 N/ZM/P/NP/ZP/R/NR GSX 250 SSM Katana GSX 250 FL/FM/FN/FP/FR/FS/FT/FV/FW Across GSF 400 M/N/P Bandit GSX 400 FJ/FK/FAK/FL (GK74A) GSX 400 R/S/T/X/ZR/ZS/ZT Impulse Type S GSX 400 SSN Katana GSF 400 K/NK/Z/NM/ZM/P/NP/VP/VZP/VR Bandit (GK75A) GS 500 EK/EL/EM/EN/EP/ER/ES/ET/EV/EW/EX/EY/K1/ K2/K3/K4/FK4/FK5/K5/K6/FK6/K7/FK7/K8/FK8 GSX 600 FJ/FK/FL/FM/FN/FP/FR/FS/FT/FV GSX 750 FK/FL/FM/FN/FP/FR/FS/FT/FV	92-96 91 90-98 91-95 88-90 94-99 92 89-94 89-08 88-97 89-96
MD3003X MD3003XC MD3003CC VR3003BLK VR3003BLU VR3003RED VR3003CHBR	Front Front Front Front Front Front Front	Floating Floating Floating Floating Floating Floating Floating	290 290 290 290 290 290 290	Gold Gold Chrome Black Blue Red Blue	Plain Contour Contour Vee Vee Vee Vee	6 6 6 6 6 6 6			RGV 250 J/K/L GSXR 250 RK (GJ73A) GSX 400 FJ/FK/FAK/FL (GK74A) GSX 400 R/S/T/ZR/ZS/ZT Impulse type GSX 400 X GSX 400 FSV/FSK1 (GK7B) Inazuma GSX 400 SSN Katana GSF 400 K/NK/Z/NM/ZM/P/NP/VP/VZP/VR Bandit (GK75A) GSF 400 S/V/S/V-V/VZ-V Bandit GSXR 400 J/RR/RAK (GK73A) RF 400 RP/RR/VR/RT/RVT/RV-V SV 400 X/Y/K1/K2 SV 400 SX/SY/SK1/SK2 RF 600 RP/RR/RS/RT/RV GSF 600 Y/K1/K2/K3/K4 (Naked Bandit) GSF 600 SY/SK1/SK2/SK3/SK4 (Faired Bandit) GSX 600 FK/FL/FM/FN/FP/FR/FS/FT/FV GSX 600 FW/FX/FY/FK1/FK2 GSF 650 S/T/V/W/X Naked Bandit GSX 650 ST/SV/SW/SX Faired Bandit SV 650 X/Y/K1/K2 Naked - Non ABS SV 650 SX/SY/SK1/SK2 Top Fairing - Non ABS GSX 750 FK/FL/FM/FN/FP/FR/FS/FT/FV GSX 750 FW/FX/FY/FK1/FK2	88-90 -89 88-90 94-96 99 00 92 89-94 95-97 88-90 93-97 00-02 00-02 93-97 00-04 00-04 89-97 95-99 96-99 99-02 99-02 89-97 98-02
MD3004	Front	Floating	310	Silver	Plain	6			GSXR 1100 G/H/J	86-88
MD3005	Front	Floating	300	Silver	Plain	6			GSXR 750 F/G/H/RG	85-87

STREETBIKE DISC BUYERS GUIDE

Disc No.	F/R	Type	Dia. (mm)	Hub Color	Profile	Bobbins	Left Bracket	Right Bracket	Model	Year
MD3006X	Front	Floating	310	Gold	Plain	6			GSF 250 N/ZM/P/NP/ZP/R/NR	92-96
MD3006XC	Front	Floating	310	Gold	Contour	6			GSF 250 VS/VT/VV/VZ/VW/VX/VY (GJ77) Bandit	95-00
MD3006CC	Front	Floating	310	Chrome	Contour	6			GSX 250 SSM Katana	91
VR3006BLK	Front	Floating	310	Black	Vee	6			GSX 250 FL/FM/FN/FP/FR/FS/FT/FV/FW Across	90-98
VR3006BLU	Front	Floating	310	Blue	Vee	6			GSF 400 M/N/P Bandit	91-95
VR3006RED	Front	Floating	310	Red	Vee	6			GSR 400 K6	06
VR3006CHBR	Front	Floating	310	Blue	Vee	6			SV 400 N (VK53A)	98
									SV 400 SN (VK53A)	98
									GS 500 EK/EL/EM/EN/EP/ER/ES/ET/EV/EW/EX/EY/K1/K2/K3/K4/FK4/FK5/K5/K6/FK6/K7/FK7/K8/FK8	89-08
									GSR 600 K6/K7/K8	06-08
									RF 900 RR/RS/RS2/RT/RV/RW	94-98
									GSF 1200 T/V/W/X/Y (Naked Bandit) 4 Piston Caliper	96-00
									GSF 1200 ST/SV/SW/SX/SY (Faired Bandit) 4 Piston Caliper	96-00
									GSF 1200 K1-K5 (Naked Bandit - 6 Piston Caliper)	01-05
									GSF 1200 SK1-SK5 (Faired Bandit - 6 Piston Caliper)	01-05
									GSX 1200 FSW/FSX 'Inazuma'	98-99
MD3007X	Front	Floating	310	Gold	Plain	6			TV 250 J/K/AK/L Wolf	88-90
MD3007XC	Front	Floating	310	Gold	Contour	6			GSXR 750 J/K/L/M/WN/WP/WR/WS	88-95
VR3007BLK	Front	Floating	310	Black	Vee	6			GSXR 1100 K/L/M/N/WP/WR/WS/WT	89-96
VR3007BLU	Front	Floating	310	Blue	Vee	6				
VR3007RED	Front	Floating	310	Red	Vee	6				
MD3008	Rear	Solid	240	N/A	Plain	N/A			RF 400 RP/RR/VR/RT/RVT/RV-V	93-97
MD3008C	Rear	Solid	240	N/A	Contour	N/A			GSX 400 FSV/FSK1 Inazuma	00
VR3008	Rear	Solid	240	N/A	Vee	N/A			SV 400 N (VK53A)	98
									SV 400 SN (VK53A)	98
									SV 400 X/Y/K1/K2	00-02
									SV 400 SX/SY/SK1/SK2	00-02
									GSF 600 Y/K1/K2/K3/K4 (Naked Bandit)	00-04
									GSF 600 SY/SK1/SK2/SK3/SK4 (Faired Bandit)	00-04
									RF 600 RP/RR/RS/RT/RV	93-97
									GSX 600 FW/FX/FY/FK1/FK2/FK3/FK4	98-04
									GSF 650 K5/K6 Naked Bandit - Non ABS	05-06
									GSF 650 SK5/SK6 Faired Bandit Non ABS	05-06
									GSF 650 S/T/V/W/X Naked Bandit	95-99
									GSX 650 ST/SV/SW/SX Faired Bandit	96-99
									SV 650 X/Y/K1/K2 Naked - Non ABS	99-02
									SV 650 SX/SY/SK1/SK2 Top Fairing - Non ABS	99-02
									GSX 750 FW/FX/FY/FK1/FK2/FK3/FK4/FK5/FK6	98-06
									GSXR 750 J/K/L/M/WN/WP/WR/WS	88-95
									GSX 750 W/X/Y/K1	98-03
									GSX 750 FK3/FK4/FK5/FK6	03-06
									RF 900 RR/RS/RS2/RT/RV/RW	94-99
									GSXR 1100 K/L/M/N/WP/WR/WS/WT	89-96
									GSF 1200 FSW/FSX 'Inazuma'	98-99
									GS 1200 SSK1/ZK1	01
									GSF 1200 T/V/W/X/Y (Naked Bandit) 4 Piston Caliper	96-00
									GSF 1200 ST/SV/SW/SX/SY (Faired Bandit) 4 Piston Caliper	96-00
									GSF 1200 K1-K5 (Naked Bandit - 6 Piston Caliper)	01-05
									GSF 1200 SK1-SK5 (Faired Bandit - 6 Piston Caliper)	01-05
									GSX 1300 RX/RV/RK1/RK2/RK3/RK4/RK5/K6	99-06
MD3009	Rear	Solid	220	N/A	Plain	N/A			GSXR 750 F/G/H/RG	85-87
									GSXR 1100 G/H/J	86-88
MD3010LS	Front	Solid	162	N/A	Plain	N/A			RB 50 H 'GSXR 50'	87
MD3014LS	Front	Floating	276	Silver	Plain	6			GN 250 F/J/M/R/T	87-97
MD3014RS	Front	Floating	276	Silver	Plain	6			GT 250 K/L/M/N/A/B/C	73-78
VMD3014	Front	Floating	276	Black	Plain	9			GSX 250 ET/EX/EZ	80-82
									GS 250 TT/TX	80-81
									RG 250 WD/WE	83-84
									GT 380 K/L/M/A/B	73-77
									GS 400 B/C	77-78
									GSX 400 ET/EX/EZ	81-83
									GN 400 TT	80
									GSX 400 LX/TX	81
									GS 425 EN	78-80
									GS 450 ET/EG/EJ	80-88
									GS 550 DB/DC/EC/EN	77-79
									GS 650 GTX/GTZ/GTD/GX/GZ	81-83
									GR 650 D/XD Tempter	83
									GS 750 DB/DC/EC/EN	77-80
									GSX 750 ET/EX	80-81
									GSX 750 SE Katana	85

STREETBIKE DISC BUYERS GUIDE

Disc No.	F/R	Type	Dia. (mm)	Hub Color	Profile	Bobbins	Left Bracket	Right Bracket	Model	Year
MD3010LS	Front	Solid	162	N/A	Plain	N/A			GSX 750 SE	85
MD3014LS	Front	Floating	276	Silver	Plain	6			GS 850 GN/GT/GX	79-81
MD3014RS	Front	Floating	276	Silver	Plain	6			GS 850 GZ/GE/GG	82-85
VMD3014	Front	Floating	276	Black	Plain	9			GS 1000 HC/EC/EN/SN/ET	78-81
									GS 1000 GT/GX	81-82
									GSX 1000 SZ Katana	82
									GS 1100 GZ	82
									GSX 1100 ET/EX/EZ/ESD	80-83
									GSX 1100 SZ/SD	82-83
MD3014RS	Rear	Floating	276	Silver	Plain	6			GS 550 EC/EN/ET/EX/EZ/LT/LX/MX/MZ	78-84
VMD3014	Rear	Floating	276	Black	Plain	9			XN 85 Turbo	83
									GS 750 B/DB/DC/EC/EN	77-80
									GSX 750 ET/EX	80-81
									GSX 750 S/SS Katana	84
									GSX 750 S-2/S-2C Katana	84
									GS 850 GN/GT/GX	79-81
									GS 1000 GT/GX	81-82
									GS 1000 HC/EC/EN/SN/ET	78-81
									GSX 1000 SZ Katana	82
									GSX 1100 ET/EX/EZ/ESD	80-83
									GSX 1100 SZ/SD 'Katana'	82-83
MD3015LS									USE MD3014LS/RS	
MD3015									USE MD3014	
MD3017LS	Front	Solid	260	N/A	Plain	N/A			LS 650 FG/PK/PM/PR/PG/PT/PV/PW/PX Savage	87-99
MD3019LS	Front	Floating	276	Silver	Plain	6			GT 500 A/B	75-78
MD3019RS	Front	Floating	276	Silver	Plain	6			RE5 M/A	75-77
VMD3019	Front	Floating	276	Black	Plain	9			GT 550 K/L/M/A/B	73-77
Billet									GT 750 K/L/M/A/B	73-77
									GS 750 B	77
MD3023LS/RS									Use MD3014LS/RS	
MD3024LS	Front	Floating	260	Silver	Plain	6			GSX 400 FW/FWS/FWS-2	
MD3024RS	Front	Floating	260	Silver	Plain	6			GSX 550 ESD/ESE/EFE/ESH/ESG/EGG	84-87
MD3025	Rear	Solid	250	N/A	Plain	N/A			GSX 400 FW/FWS/FWS-2	84-87
									GSX 550 ESD/ESE/EFE/ESH/ESG/EGG	81-83
									GSX 400 FX/FZ/FD	
MD3027	Rear	Solid	276	N/A	Plain	N/A			GS 650 GTX/GTZ/GTD//GX/GZ	81-83
									GS 850 GZ/GE/GG	82-85
									GS 1100 GZ	82
MD3028LS	Front	Floating	260	Silver	Plain	6			XN 85 Turbo	83
MD3028RS	Front	Floating	260	Silver	Plain	6			GS 700 EF/ESF	85
									GSX 750 ESD/ESE/EFE/ESH/ESG/EGG	82-86
									GSX 750 S/SS Katana	84
									GSX 750 S-2/S-2C Katana	84
MD3029	Rear	Floating	260	Silver	Plain	6			GS 700 EF/ESF	85
									GSX 750 SE Katana	85
									GSX 750 ESD/ESE/EFE/ESH/ESG/EGG	82-86
MD3030LS / RS	Front	Solid	276	N/A	Plain	N/A			GV 1200 GLF/GLF2/GLG Madura	85-86
MD3031LS	Front	Solid	296	N/A	Plain	N/A			VS 700 GLFG/GLPG	86-87
									VS 750 GLF/GLPG/GLFG	85-90
MD3032LS	Front	Floating	296	Silver	Plain	6			VS 400 VR/FR/VTR/FTR/ V-T/F-T Intruder	94-
MD3032RS	Front	Floating	296	Silver	Plain	6			VS 600 GLS/GLT/GLV	95-97
									VS 700 GLFH/GLPH	86-87
									VS 750 GLFH/GLPH 'Intruder' Spoke Wheel	87
									VS 750 GLPK/GLPL/GLPM 'Intruder' 'Spoke Wheel'	88-91
									VS 800 GLN/GLP/GLR/GLS/GLT/GLV/GLW/GLX 'Intruder'	92-99
									VS 1400 GLPH/GLFH/GLPJ/GLFJ/GLPR/GLPT/GLPV/ GLPW/GLPX/GLPY/GLPK1 Intruder	87-02
MD3033LS	Front	Solid	310	N/A	Plain	N/A			VX 800 L/M/N/P/R/T	90-96
MD3034LS/RS									USE MD3014LS/RS	
MD3036	Rear	Solid	275	N/A	Plain	N/A			GSX 1100 FJ/FK/FL/FN/FM/FP/FR	89-94
Billet										

DISC
BUYERS GUIDE

STREETBIKE DISC BUYERS GUIDE

Disc No.	F/R	Type	Dia. (mm)	Hub Color	Profile	Bobbins	Left Bracket	Right Bracket	Model	Year
MD3037LS MD3037RS	Front Front	Solid Solid	310 310	N/A N/A	Plain Plain	N/A N/A			GSX 1100 GM/GN	91-94
MD3038	Rear	Solid	295	N/A	Plain	N/A			GSX 1100 GM/GN	91-94
MD3039LS MD3039RS	Front Front	Floating Floating	276 276	Silver Silver	Plain Plain	6 6			GSX 1100 EFE/EFF/ESE GSX 1100 FJ/FK/FL/FN/FM/FP/FR	84-86 89-94
MD3039	Rear	Floating	276	Silver	Plain	6			GSX 1100 EFE/EFF/ESE	84-86
MD3041 BILLET	Rear	Floating	275	Gold	Plain	6			GV 1200 GLF/GLF2/GLG Madura	85-86
MD3042	Front	Solid	275	N/A	Plain	N/A			GV 1400 Cavalcade All models	85-88
MD3043	Rear	Solid	296	N/A	Plain	N/A			GV 1400 Cavalcade All models	85-88
MD3044	Rear	Solid	275	N/A	Plain	N/A			VS 1400 GLPH/GLFH/GLPJ/GLFJ/GLPR/GLPT/GLPV/ GLPW/GLPX/GLPY/GLPK1/GLPK2 Intruder	87-03
MD3045	Front	Floating	300	Gold	Plain	6			RG 125 FN/FP/FR (NF13A) Gamma RG 125 FUN/FUP/FUR (NF13B) Gamma RG 125 UN Wolf (NF13E) Naked RGV 250 M/N/P/R/S GSXR 400 RL/RM/RN/RP/RS (GK76A) GSX 750 W/X/Y/K1 VZ 800 V/W/X/Y/K1/K2 'Marauder'	92-94 92-94 92-94 91-95 90-95 98-03 97-03
MD3048LS	Front	Solid	260	N/A	Plain	N/A			RG 125 CG/CH/J Gamma (NF12A) RG 125 UCG/UCH/UJ/UAJ/BUJ (NF12B) Gamma	86-90 86-90
MD3051									USE MD3059	
MD3058X MD3058XC MD3058CC VR3058BLK VR3058BLU VR3058RED VR3058CHBR	Front Front Front Front Front Front Front	Floating Floating Floating Floating Floating Floating Floating	320 320 320 320 320 320 320	Gold Gold Chrome Black Blue Red Blue	Plain Contour Contour Vee Vee Vee Vee	6 6 6 6 6 6 6			GSXR 600 V/W/X/Y/SY/K1-K3/ZK3 GSXR 750 T/V/W/X/Y/K1-K3 GSXR 1000 K1/K2 TL 1000 SV/SW/RW/SX/RX/R/Y/K1/SK1 GS 1200 SSK1/ZK1 GSX 1300 RX/RY/RK1/RK3/RZK3/RK3/RK4/RK5/K6 'Hayabusa' GSX 1400 K1-K7/FE	97-03 96-03 01-02 97-02 01 99-06 01-07
MD3059	Rear	Solid	210	N/A	Plain	N/A			RG 125 FN/FP/FR (NF13A) Gamma RG 125 FUN/FUP/FUR (NF13B) Gamma RG 125 UN Wolf (NF13E) Naked RGV 250 M/N/P/R/S/T GSXR 250 J (GJ72A) GSXR 250 CK	92-94 92-94 92-94 91-96
MD3060 MD3060C VR3060	Rear Rear Rear	Solid Solid Solid	220 220 220	N/A N/A N/A	Plain Contour Vee	N/A N/A N/A			SV 400 K3/K4/K5 SV 400 SK3/SK4/SK5 GSXR 600 Inc 100th Anniversary SV 650 K3-K9/L0 Naked Non ABS SV 650 SK3-SK9/SLO Top Fairing Non ABS GSXR 750 Inc 100th Anniversary GSXR 1000 Inc 100th Anniversary GSX-S 1000 AL5 (ABS) GSX-S 1000 FAL5 (ABS) SV 1000 K3/K4/K5/K6/K7 Naked SV 1000 SK3-SK7 Faired Model TL 1000 SV/SW/RW/SX/RX/SY/R/Y/RK1/SK1 VX 800 L/M/N/P/R/T	03-05 03-05 97-21 03-10 03-15 96-21 01-21 15-21 15-21 03-07 03-07 97-02 90-96
MD3061	Rear	Solid	250	N/A	Plain	N/A				
MD3063									USE MD3059	
MD3064	Rear	Solid	210	N/A	Plain	N/A			RG 250 WD/WE RG 250 FG/CH/FCH/FH Gamma GSX 250 R CH/H (GJ72A) GSX 400 R2 (GK71B) GSX 400 R3 (GK71F) GSX 400 X/XA/XS Impulse RG 400 EWF/EW-2G/EWH Walter Wolf RG 500 G/CH GSXR 400 H	83-84 85-88 85-87 85-87 87
MD3066LS MD3066RS	Front Front	Floating Floating	276 276	Silver Silver	Plain Plain	9 9			GSX 400 FX/FZ/FD	81-83

STREETBIKE DISC BUYERS GUIDE

Disc No.	F/R	Type	Dia. (mm)	Hub Color	Profile	Bobbins	Left Bracket	Right Bracket	Model	Year
MD3067									USE MD3025	
MD3068LS/RS									USE MD3001LS/RS	
MD3069									USE MD3064	
MD3070LS MD3070RS	Front Front	Floating Floating	260 260	Silver Silver	Plain Plain	9 9			RG 500 G/CH RG 400 EWF/EW-2G/EWH Walter Wolf	85-87 85-87
MD3071									USE MD3064	
MD3072RS									USE MD3045	
MD3073LS	Front	Floating	296	Gold	Plain	6			VS 700 GLEFG/GLEPG/GLEFH/GLEPH VS 750 GLEFH/GLEPH 'Intruder' 'Cast wheel'	86-87 87
MD3074	Front	Solid	275	N/A	Plain	N/A			GSX 250 R CH/H (GJ72A) GSXR 250 CJ GSX 250 R CK (GJ72A)	80-82 02-05 17-21
MD3075LS MD3075RS	Front Front	Floating Floating	310 310	Silver Silver	Plain Plain	6 6			GSF 1200 SAV ABS Bandit	97
MD3076	Rear	Solid	276	N/A	Plain	N/A			GSF 1200 SAV ABS Bandit	97
MD3077LS/RS									USE MD3045	
MD3078RS	Front	Solid	300	N/A	Plain	N/A			VL 1500 W/X/Y/K1 'Intruder Legendary Classic'	98-01
MD3079 Billet	Rear	Floating	276	Gold	Plain	6			VL 1500 W/X 'Intruder Legendary Classic'	98-99
MD3080RS SILVER	Front	Floating	299	Silver	Plain	9			SG 350 N 'Goose'	92
MD3081	Rear	Solid	210	N/A	Plain	N/A			GSX 250 R CJ (GJ72A) RGV 250 J/K/L TV 250 J/K/AK/L Wolf SG 350 N 'Goose' GSXR 400 RL/RM/RN/RS (GK76A) GSXR 400 J/RR/RAK (GK73A)	17-21 88-90 88-90 92 90-95 88-90
MD3082LS MD3082RS	Front Front	Floating Floating	290 290	Silver Silver	Plain Plain	9 9			RGV 250 T (RGVR 250 SP)	96
MD3083 MD3083C	Rear Rear	Solid Solid	260 260	N/A N/A	Plain Contour	N/A N/A			GSX 1400 K1-K7/FE	01-07
MD3084	Rear	Solid	240	N/A	Plain	N/A			GSF 250 VS/VT/VW/VVZ/VW/VX/VY (GJ77) Bandit GSF 400 S/VS/V-V/VZ-V Bandit	95-00 95-97
MD3086 Billet	Rear	Floating	276	Gold	Plain	6			VL 1500 Y/K1/K2/K3/K5-K8 Intruder Legendary Classic	00-03 /05-08
MD3087LS MD3087RS	Front Front	Solid Solid	290 290	N/A N/A	Plain Plain	N/A N/A			VL 1500 K2/K3/K5/K6/K7/K8 Intruder Legendary Classic	02-03/05-08
MD3088X MD3088XC MD3088CC VR3088BLK VR3088BLU VR3088RED	Front Front Front Front Front Front	Floating Floating Floating Floating Floating Floating	310 310 310 310 310 310	Gold Gold Chrome Black Blue Red	Plain Contour Contour Vee Vee Vee	6 6 6 6 6 6			DL 650 K4/K5/K6 DL 1000 K2-K9/L0 SV 1000 K3-K8 Naked SV 1000 SK3-SK7 Faired Model	04-06 02-10 03-07 03-07
MD3089X MD3089XC MD3089CC VR3089BLK VR3089BLU VR3089RED	Front Front Front Front Front Front	Floating Floating Floating Floating Floating Floating	300 300 300 300 300 300	Gold Gold Chrome Black Blue Red	Plain Contour Contour Vee Vee Vee	6 6 6 6 6 6			GSXR 1000 K3	03

STREETBIKE DISC BUYERS GUIDE

Disc No.	F/R	Type	Dia. (mm)	Hub Color	Profile	Bobbins	Left Bracket	Right Bracket	Model	Year
MD3090X	Front	Floating	290	Gold	Plain	6			SV 400 K3/K4/K5	03-05
MD3090XC	Front	Floating	290	Gold	Contour	6			SV 400 SK3/SK4/SK5	03-05
MD3090CC	Front	Floating	290	Chrome	Contour	6			GSX 600 FK3/FK4/FK5/FK6	03-06
VR3090BLK	Front	Floating	290	Black	Vee	6			GSF 650 K5/K6 Naked Bandit - Non ABS	05-06
VR3090BLU	Front	Floating	290	Blue	Vee	6			GSF 650 SK5/SK6 Faired Bandit Non ABS	05-06
VR3090RED	Front	Floating	290	Red	Vee	6			SV 650 K3-K9/L0 Naked - Non ABS	03-10
									SV 650 SK3-SK9/SLO Top Fairing - Non ABS	03-15
									GSX 750 FK3/FK4/FK5/FK6	03-06
									M 1500 (VZ 1500 K9/L0 - Intruder)	09-13
									C 1800 R (VLR 1800 K8/K9/L0/L1) (C 1800 R Intruder)	08-13
									(C 1800 RT) VLR 1800 K8RT/K9RT - Touring Intruder	08-10
MD3091X	Front	Floating	310	Gold	Plain	6			GSXR 600 K6/K7	06-07
MD3091XC	Front	Floating	310	Gold	Contour	6			GSXR 750 K6/K7	06-07
MD3091CC	Front	Floating	310	Chrome	Contour	6			GSXR 1000 K5/K6/K7/K8	05-08
VR3091BLK	Front	Floating	310	Black	Vee	6			M 1800 R (VZR 1800 K6/K7/K8/K9 Intruder Handlebar Cowling)	06-09
VR3091BLU	Front	Floating	310	Blue	Vee	6			M 1800 R2 (VZR 1800 NK8/NK9 Intruder - No Handlebar Cowling)	08-09
VR3091RED	Front	Floating	310	Red	Vee	6			M 1800 RZ (VZR 1800 ZK7/ZK8/ZL1/ZL2 Intruder - With Handlebar Cowling with central tape strip)	07-13
VR3091CHBR	Front	Floating	310	Blue	Vee	6			VZR 1800 BZL4/BZL5/BZL6/BZL7/BZL8 - M1800 RB	14-18
MD3092X	Front	Floating	310	Gold	Plain	6			GSR 400 K6/K7/K8	06-10
MD3092XC	Front	Floating	310	Gold	Contour	6			GSR 600 K6/K7/K8	06-09
MD3092CC	Front	Floating	310	Chrome	Contour	6			DL 650 XK7/XK8/XK9/XL0 V-Strom X	07-11
VR3092BLK	Front	Floating	310	Black	Vee	6			DL 650 AK7/AK8/AK9/AL0 V-Strom ABS	07-11
VR3092BLU	Front	Floating	310	Blue	Vee	6			DL 650 AL1XP V-Strom Xpedition	11
VR3092RED	Front	Floating	310	Red	Vee	6			DL 650 AK9 GT V-Strom Traveller ABS	09-11
									DL 650 V-Strom ABS	12-21
									DL 650 XT V-Strom ABS	15-21
									GSF 650 AK7/AK8/AK9/AL0/AL1/AL2 Naked Bandit - ABS	07-12
									GSF 650 SAK7/SAK8/SAK9/SAL0/SAL1/SAL2 Faired Bandit - ABS	07-15
									GSF 650 SK7/SK8/SK9/SLO/SL1/SL2 (Faired Bandit/Non ABS)	07-12
									GSF 650 K7/K8/K9/L0/L1/L2 (Naked Bandit/Non ABS)	07-12
									GSX 650 FK8/FK9/FL0/FL1/FL2 Non ABS	08-14
									GSX 650 FAK8/FAK9/FAL0/FAL1/FAL2 (ABS Model)	08-15
									GSR 750 L1/L2/L3/L4/L5/L6 (Non ABS)	11-16
									GSR 750 AL2/AL/AL4/AL5/AL6 (ABS)	11-16
									GSX-S 750 A AL8 ABS	18-20
									GSX-S 750 Y AZL8 ABS	18-21
									GSX-S 750 Z L8	18-21
									GSX-S 750 ZL	18-21
									DL 1000 V-Strom (ABS)	14-20
									DL 1000 XT V-Strom (ABS)	14-20
									DL 1050 V-Strom (ABS)	14-21
									DL 1050 XT V-Strom (ABS)	14-21
									DL 1050 XT Tour V-Strom (ABS)	14-21
									GSF 1250 K6/AK6 Naked Bandit ABS & Non ABS 4 Piston	06
									GSF 1250 AK7/AK8 Naked Bandit ABS 4 Piston	07-08
									GSF 1250 K7/K8/K9/OL0 Naked Bandit Non ABS 4 Piston	07-11
									GSF 1250 SK6/SAK6 Faired Bandit ABS & Non ABS 4 Piston	06
									GSF 1250 SK7/SK8/SK9/SLO Faired Bandit Non ABS 4 Piston	07-12
									GSF 1250 SAK7/SAK8/SAK9/SAZK9/SAL0/SAL1/SAL2/SAL4/SAL5/SAL6 (Faired Bandit - ABS Model - 4 Piston Caliper)	07-16
									GSX 1250 FAL0/FAL1/FAL2/FAL4/FAL5/FAL6	10-16
									GSX 1250 FAL0ST/FAL1ST Sports Touring	10-14
MD3093	Rear	Solid	240	N/A	Plain	N/A			GW 250 L3/ZL5 Inazuma	11-15
MD3093C	Rear	Solid	240	N/A	Contour	N/A			GW 250 FL5 Inazuma	15
VR3093	Rear	Solid	240	N/A	Vee	N/A			GSR 400 K6/K7/K8	06-08
									GSR 600 K6/K7/K8	06-09
									GSF 650 SAK5/SAK6 Faired Bandit - ABS	05-06
									GSF 650 K7/K8/K9/OL0 Naked Bandit - Non ABS	07-11
									GSF 650 SK7/SK8 Faired Bandit - Non ABS	07-08
									GSF 650 AK5/AK6 Naked Bandit - ABS	05-06
									GSF 650 AK7/AK8/AK9/AL0/AL1/AL2 Naked Bandit - ABS	07-09
									GSF 650 SAK7/SAK8/SAK9/SAL0/SAL1/SAL2 Faired Bandit - ABS	07-15
									GSF 650 SK7/SK8/SK9/SLO/SL1/SL2 (Faired Bandit/Non ABS)	07-12
									GSF 650 K7/K8/K9/L0/L1/L2 (Naked Bandit/Non ABS)	07-12
									GSX 650 FK8/FK9/FL0/FL1/FL2 Non ABS	08-14

STREETBIKE DISC BUYERS GUIDE

Disc No.	F/R	Type	Dia. (mm)	Hub Color	Profile	Bobbins	Left Bracket	Right Bracket	Model	Year
MD3093 MD3093C VR3093	Rear Rear Rear	Solid Solid Solid	240 240 240	N/A N/A N/A	Plain Contour Vee	N/A N/A N/A			GSX 650 FAK8/FAK9/FAL0/FAL1/FAL2 (ABS Model) SFV 650 K9/L0/L1/L2/L3/L4/L5 Gladius SFV 650 AK9/AL0/AL1/AL2/AL3/AL4/AL5 (ABS) SV 650 AK7/AK8/AK9/AL0 Naked - ABS SV 650 SAK7/SAK8/SAK9/SAL0 SV 650 AL7/AL8/AL9 (ABS) SV 650 X AL8/AL9 (ABS) GSR 750 L1/L2/L3/L4/L5/L6 (Non ABS) GSR 750 AL2/AL4/AL5/AL6 (ABS) GSX-S 750 Y Z and ZL GSF 1250 K6/AK6 Naked Bandit ABS & Non ABS 4 Piston GSF 1250 AK7/AK8 Naked Bandit ABS 4 Piston GSF 1250 K7/K8/K9/OLO Naked Bandit Non ABS 4 Piston GSF 1250 SK6/SAK6 Faired Bandit ABS & Non ABS 4 Piston GSF 1250 SAK7/SAK8/SAK9/SAZK9/SAL0/SAL1/SAL2/SAL4/SAL5/SAL6 (Faired Bandit - ABS Model - 4 Piston Caliper) GSF 1250 SK7/SK8/SK9/SLO Faired Bandit Non ABS 4 Piston GSX 1250 FAL0/FAL1/FAL2/FAL4/FAL5/FAL6 GSX 1250 FAL0ST/FAL1ST Sports Touring	08-15 09-15 09-15 07-10 07-15 16-21 18-21 11-16 11-16 18-21 06 07-08 07-11 06 07-16 07-10 10-16 10-14
MD3094X MD3094XC									USE MD3101X USE MD3101XC	
MD3095RS	Front	Solid	300	N/A	Plain	N/A			Intruder Volusia VL 800 K1-K5 VL 800 K6/K7/K8/K9/L0/L1/L2/L3/L5 C 800 C (VL 800 CK7/CK8/CK9/CL0/CL1/CL2/CL3) Intruder (Cast wheel) VL 800 BTL4 C800 Intruder Inc C 50 Boulevard	01-05 06-15 07-15 14-21
MD3096RS	Front	Solid	300	N/A	Plain	N/A			M 800 (VZ 800 K5-K9/L0/L1/L3 Intruder M800) M 800 L4/L5 Intruder M 800/T M 800 Z (VZ 800 K9Z - Intruder)	05-13 14-15 09-10
MD3097 Billet	Rear	Floating	275	Silver	Plain	6			VL 1500 K5/K6/K7/K8 (C 1500 Intruder) M 1500 (VZ 1500 K9/L0 - Intruder) C 1800 R (VLR 1800 K8/K9/L0/L1) (C 1800 R Intruder) (C 1800 RT) VLR 1800 K8RT/K9RT - Touring Intruder M 1800 R (VZR 1800 K6/K7/K8/K9 Intruder Handlebar Cowling) M 1800 R2 (VZR 1800 NK8/NK9 Intruder - No Handlebar Cowling) M 1800 RZ (VZR 1800 ZK7/ZK8/ZL1/ZL2/ZL3 Intruder - With Handlebar Cowling VZR 1800 BZL4/BZL5BZL6/BZL7/BZL8 - M1800 RB	05-08 09-13 08-13 08-10 06-09 08-09 07-13 14-18
MD3098X MD3098XC MD3098CC VR3098BLK VR3098BLU VR3098RED	Front Front Front Front Front Front	Floating Floating Floating Floating Floating Floating	310 310 310 310 310 310	Gold Gold Chrome Black Blue Red	Plain Contour Contour Vee Vee Vee	6 6 6 6 6 6			GSX 1300 RK8/RK9/RL0/RL1/RL2 GSX 1300 RAL3/RAL4/RAL5/RAL6/RAL7/RAL8 Hayabusa GSX 1300 BKK8/BKK9/BKL0/BKL1 B-King	08-12 13-18 08-12
MD3099 MD3099C VR3099	Rear Rear Rear	Solid Solid Solid	260 260 260	N/A N/A N/A	Plain Contour Vee	N/A N/A N/A			GSX 1300 RK8/RK9/RL0/RL1/RL2 GSX 1300 RAL3/RAL4/RAL5/RAL6/RAL7/RAL8 Hayabusa GSX 1300 Hayabusa GSX 1300 BKK8/BKK9/BKL0/BKL1 B-King	08-12 13-18 21 08-12
MD3100X MD3100XC VR3100BLK VR3100BLU VR3100RED	Front Front Front Front Front	Floating Floating Floating Floating Floating	310 310 310 310 310	Gold Gold Black Blue Red	Plain Contour Vee Vee Vee	6 6 6 6 6			GSXR 600 Inc 100th Anniversary GSXR 750 Inc 100th Anniversary GSX-S 750 Y GSX-S 750 Z and ZL	08-21 08-21 18-20 18-20
MD3101X MD3101XC	Front Front	Floating Floating	290 290	Gold Gold	Plain Contour	6 6			GSF 650 AK5/AK6 GSF 650 SAK5/SAK6	05-06 05-06
MD3102X MD3102XC VR3102BLK VR3102BLU VR3102RED	Front Front Front Front Front	Floating Floating Floating Floating Floating	310 310 310 310 310	Gold Gold Black Blue Red	Plain Contour Vee Vee Vee	6 6 6 6 6			GSXR 1000 K9/L0/L1 GSXR 1000 L2/L3/ZL3/L4/ZL4/L5/AL5/AL6	09-11 12-16

STREETBIKE DISC BUYERS GUIDE

Disc No.	F/R	Type	Dia. (mm)	Hub Color	Profile	Bobbins	Left Bracket	Right Bracket	Model	Year
MD3103X MD3103XC	Front Front	Floating Floating	290 290	Gold Gold	Plain Contour	6 6			SFV 650 K9/L0/L1/L2/L3/L4/L5 Gladius SFV 650 AK9/AL0/AL1/AL2/AL3/AL4/AL5 (ABS) SV 650 AK7/AK8/AK9/AL0 Naked - ABS SV 650 SAK7/SAK8/SAK9/SAL0 SV 650 ABS SV 650 X ABS	09-15 09-15 07-10 07-15 16-21 18-21
MD3104X MD3104XC VR3104BLK VR3104BLU VR3104RED	Front Front Front Front Front	Floating Floating Floating Floating Floating	300 300 300 300 300	Gold Gold Black Blue Red	Plain Contour Vee Vee Vee	6 6 6 6 6			GSXR 600 K4/K5 GSXR 750 K4/K5 GSXR 1000 K4	04-05 04-05 04
MD3105LS	Front	Solid	290	N/A	Plain	N/A			GW 250 L3/ZL5 Inazuma GW 250 FL5 Inazuma	13-15 15
MD3106 MD3106C VR3106	Rear Rear Rear	Solid Solid Solid	220 220 220	N/A N/A N/A	Plain Contour Vee	N/A N/A N/A			GSXR 1000 (Brembo Caliper/320mm Disc ABS) GSXR 1000 R Inc 100th Anniversary (Brembo Caliper/320mm Disc ABS)	15-21 17-21
MD3107X MD3107XC VR3107BLK VR3107RED VR3107BLU	Front Front Front Front Front	Floating Floating Floating Floating Floating	320 320 320 320 320	Gold Gold Black Blue Red	Plain Contour Vee Vee Vee	6 6 6 6 6			GSXR 1000 (Brembo Caliper/320mm Disc ABS) GSXR 1000 R Inc 100th Anniversary (Brembo Caliper/320mm Disc ABS)	17-21 17-21
MD3108 MD3108C VR3108	Rear Rear Rear	Solid Solid Solid	250 250 250	N/A N/A N/A	Plain Contour Vee	N/A N/A N/A			GSX-S 1000 (Naked/Non ABS) GSX-S 1000 (Naked/ABS) GSX-S 1000 F (Faired/Non ABS) GSX-S 1000 F (Faired/ABS) GSX 1000 Katana	16-20 16-21 16-20 16-21 20-20
MD3109X MD3109XC VR3109BLK VR3109BLU VR3109RED	Front Front Front Front Front	Floating Floating Floating Floating Floating	310 310 310 310 310	Gold Gold Black Blue Red	Plain Contour Vee Vee Vee	6 6 6 6 6			GSX-S 1000 (Naked/Non ABS) GSX-S 1000 (Naked/ABS) GSX-S 1000 F (Faired/Non ABS) GSX-S 1000 F (Faired/ABS) GSX 1000 Katana	16-20 16-21 16-20 16-21 20-21
MD3110C	Front	Solid	290	N/A	Contour	N/A			GSX-R 125 GSX-S 125 GSX-R 150 GSX-S 150	18-21 18-21 18-20 18-20
MD3111 MD3111C	Rear Rear	Solid Solid	190 190	N/A N/A	Plain Contour	N/A N/A			GSX-R 125 GSX-S 125 GSX-R 150 GSX-S 150	18-21 18-21 18-20 18-20
MD3112C	Front	Solid	290	N/A	Contour	N/A			DL 250 V-Strom (ABS) GSX 250 RL7/RL8	18-21 17-18
MD3113C	Rear	Solid	240	N/A	Contour	N/A			DL 250 V-Strom (ABS) GSX 250 RL7/RL8	18-21 17-18
MD3114X MD3114XC									USE MD3092X USE MD3092XC	
MD4001	Rear	Solid	260	N/A	Plain	N/A			KAWASAKI Z 400 C2/C3 (Z 400 F2) GPZ 550 A1-A4	85-87 84-87
MD4002LS MD4002RS	Front Front	Solid Solid	260 260	N/A N/A	Plain Plain	N/A N/A			EL 252 F2 (EL 250 F2/F5/F6) EL 250 D1-D5 EL 250 'Eliminator' GPX 250 R (EX 250 E) GPZ 550 A1-A4	96-03 90-94 87-89 86 84-87
MD4004LS/RS									USE MD4099LS/RS	
MD4005	Front	Floating	310	Silver	Plain	9			ZXR 400 L1-L9 ZXR 400 R (ZX 400 M1-M4)	91-03 91-94
MD4006LS MD4006RS	Front Front	Solid Solid	270 270	N/A N/A	Plain Plain	N/A N/A			EN 450 A1-A5 (LTD 454) EN 500 A1-A3 GT 550 G1-G9 Z 1000 J1/J2 Z 1000 K1/K2 LTD	86-89 90-93 83-01 81-82 81-82

STREETBIKE DISC BUYERS GUIDE

Disc No.	F/R	Type	Dia. (mm)	Hub Color	Profile	Bobbins	Left Bracket	Right Bracket	Model	Year
MD4006LS MD4006RS Contd.									Z 1000 K1 'Ltd' GPZ 1100 B1 Z 1100 D1/D2 'Spectre' Z 1100 A1-A3	83 82 82-83 81-83
MD4007 MD4007C VR4007	Rear Rear Rear	Solid Solid Solid	230 230 230	N/A N/A N/A	Plain Contour Vee	N/A N/A N/A			ZZR 400 (ZX 400 K1/2/3) ZZR 600 D1-D3 GPX 750 R F1-F3 ZR 750 C1-C5/D1 Zephyr	90-92 90-93 87-89 91-98
MD4008X MD4008XC VR4008BLK VR4008GRN MD4008CC	Front Front Front Front Front	Floating Floating Floating Floating Floating	300 300 300 300 300	Gold Gold Chrome Black Green	Plain Contour Contour Vee Vee	6 6 6 6 6			GSX 250 FXK2/K3-K5 (ZR 250 C) KR-1S (KR 250 C2/C3) ZR 250 A1-A5 ZR 250 B6 (Balius-II) ZXR 250 A1/A2/B1/B2 ZZR 250 (EX 250 H1-H13) ZL 400 D1/D2 ZRX 400 (ZR 400 E1-E7) ZXR 400 H1/H2 ZXR 400 J1/J2 ZZR 400 (ZX 400 K1-K3/N1-N7) ZR 550 B2-B6 ZX6-R F1-F3 ZL 600 B1 EJ 650 A1/C3-C7 (E650) ZR 750 C1-C5/D1 Zephyr W 800 (EJ 800) Cafe Style/Cockpit Fairing EJ 800 (W 800 Cafe Style/Cockpit Fairing) EJ 800 ACFA (W 800 Special Edition Black Exhaust/ Gold Rims) W 800 (EJ 800 ADF/AEF/AFF/AGF) W 800 Special Edition (EJ 800 ADFA/AEFA/AFFA/AGFA) GPZ 900 A7/A8 GPZ 900 R (ZX 900 A11) ZG 1000 A9-A18 GPZ 1100 E1/E2/F1	02-05 90-92 91-95 02 89-90 90-03 94-95 94-01 89-90 89-90 90-99 91-99 95-97 95-97 00-05 92-95 11-21 11 12 13-16 13-16 90-96 98 94-03 95-98
MD4009 MD4009C VR4009	Rear Rear Rear	Solid Solid Solid	240 240 240	N/A N/A N/A	Plain Contour Vee	N/A N/A N/A			ZXR 400 L1-L9 ZXR 400 H1/H2 ZXR 400 J1/J2 ZXR 400 (M1-M4) ZX-4 (ZX 400 G1/G1A/G1B) ZR 400 Zephyr ZR 400 Zephyr (G2/G3/G3A/G4/G5) ZZR 400 (ZX 400 N1-N7) ZR 550 B2-B6 ZZR 600 E1-E13 ZZR 600 (ZX 600 E6F)	91-03 89-90 89-90 91-94 88 97-01 97-01 93-99 91-98 93-05 06-07
MD4010LS MD4010RS	Front Front	Solid Solid	260 260	N/A N/A	Plain Plain	N/A N/A			Z 250 A3 Z 400 J2-J3 Z 440 D5-D6 'Ltd' Z 440 C2/H1-H2 Z 550 A2-A3 Z 550 C1-C2 Ltd GPZ 550 D1 Z 650 F2-F4 VN 700 A1 'Vulcan' Z 700 A1 Ltd Z 750 E1 GPZ 750 R1 GT 750 P1-P9 Z 750 H1-H2 Ltd Z 750 N1/N2 Spectre Z 750 L1-L4 VN 750 A2-A5/10	81 81-83 83-84 81-83 81-82 82-84 82 81-83 85 84 80 82 82-96 80-81 82-83 81-84 86-94
MD4012X MD4012XC MD4012CC VR4012BLK VR4012GRN	Front Front Front Front Front	Floating Floating Floating Floating Floating	310 310 310 310 310	Gold Gold Chrome Black Green	Plain Contour Contour Vee Vee	6 6 6 6 6			ZXR 750 H1-H2 ZX9R (ZX 900 E1/E2) ZR 1100 A1-A4 'Zephyr' ZR 1100 B1 'Zephyr' ZZR 1100 C1-C3 ZRX 1100 C1-C4 ZR 1100 B5 ZX 1200 A1-A5/A6F/B1-B3	89-90 00-01 92-95 96-97 90-92 97-00 02 01-08

STREETBIKE DISC BUYERS GUIDE

Disc No.	F/R	Type	Dia. (mm)	Hub Color	Profile	Bobbins	Left Bracket	Right Bracket	Model	Year
MD4013 MD4013C VR4013	Rear Rear Rear	Solid Solid Solid	230 230 230	N/A N/A N/A	Plain Contour Vee	N/A N/A N/A			ZXR 750 H1/H2/K1/K2/J1/J2/M1/M2/L1-L3/P1-P7/N1/N2 ZX 9R (ZX 900 B1-B4)	89-03 94-97
MD4014 MD4014C VR4014	Rear Rear Rear	Solid Solid Solid	250 250 250	N/A N/A N/A	Plain Contour Vee	N/A N/A N/A			ZZR 1100 D1-D9	93-01
MD4015 MD4015C VR4015	Rear Rear Rear	Solid Solid Solid	250 250 250	N/A N/A N/A	Plain Contour Vee	N/A N/A N/A			FX 400 R (ZX 400 E1-E3) GPZ 400 R (ZX 400 D1/D3/D3A) GPZ 600 R A1-A5A GPZ 900 A7-A8 GPZ 900 R (ZX 900 A11-15) ZX 1000 B1-B3 (ZX10) ZZR 1100 C1-C3	86-88 85-87 85-89 90-96 98-02 88-90 90-92
MD4016 Floating disc available, see MD714	Front	Solid	280	N/A	Plain	N/A			ZL 400 A 'Eliminator' ER-5 (ER 500 A1/A2/A3/A4/C1-C5P) GPZ 500 'S' (EX 500 A1-A6) GPZ 500 'S' (EX 500 D1-D9) GPZ 750 R G2-G3 GPZ 750 E1/E2 Turbo GPZ 900 R A1-A6 ZL 900 A1/A2 'Eliminator' GPZ 1000 RX (A1-A3) ZL 1000 A1 GPZ 1100 A1-A3	86-87 97-07 87-93 94-02 85-86 84-87 84-89 85-86 86-88 87 83-85
MD4017 Billet	Rear	Solid	270	N/A	Plain	N/A			GPZ 750 E1/E2 Turbo GPZ 750 R G2-G3 GPZ 900 R A1-A6 ZL 900 A1/A2 'Eliminator' ZL 1000 A1 GPZ 1100 A1-A3	84-87 85-86 84-89 85-86 87 83-85
MD4018LS/RS									USE MD4016	
MD4019 Billet	Rear	Solid	260	N/A	Plain	N/A			GPZ 750 A1-A5 GPZ 1000 RX A1-A3	83-87 86-88
MD4020LS/RS									USE MD4016	
MD4021	Front	Solid	300	N/A	Plain	N/A			ZX 1000 B1-B3 (ZX10)	88-90
MD4022X MD4022XC MD4022CC VR4022BLK VR4022GRN	Front Front Front Front Front	Floating Floating Floating Floating Floating	320 320 320 320 320	Gold Gold Chrome Black Green	Plain Contour Contour Vee Vee	6 6 6 6 6			ZXR 750 K1/K2/J1/J2/M1/M2/L1-L3/P1-P7/N1/N2 ZX-9R B1-B4 ZX9R (ZX 900 F1/F2) ZZR 1100 D1-D9 ZX12R (A1/A2/B1/B2/B3) ZZR 1200 C1H/C2H VN 1500 P1/P2 Mean Streak M 1600 (VZ 1600 K4/K5 Intruder) VN 1600 B1/B2/B2H/B6F/B7F Mean Streak	91-03 94-97 02-04 93-01 00-04 02-04 02-04 04-05 04-08
MD4023 MD4023C VR4023	Rear Rear Rear	Solid Solid Solid	230 230 230	N/A N/A N/A	Plain Contour Vee	N/A N/A N/A			ZX-6R F1-F3 ZX12R (A1/A2/B1/B2/B3/B4/B6F)	95-97 00-06
MD4024	Rear	Solid	260	N/A	Plain	N/A			GPZ 550 H1-H2	82-83
MD4026LS MD4026RS	Front Front	Solid Solid	260 260	N/A N/A	Plain Plain	N/A N/A			GPX 600 R C1-C7	88-96
MD4027 MD4027C VR4027	Rear Rear Rear	Solid Solid Solid	240 240 240	N/A N/A N/A	Plain Contour Vee	N/A N/A N/A			GPX 400 R (ZX 400 F1) GPX 600 R C1-C7 ZR 1100 A1-A4 Zephyr ZR 1100 B1 ZR 1100 B5	87 88-96 92-95 96-97 02
MD4028	Rear	Solid	270	N/A	Plain	N/A			Z 400 C2/C3 (Z 400 F2) GPZ 600 R A1-A5A GPZ 750 A1-A5A ZG 1000 A1-A7	85-87 85-89 83-87 86-93
MD4029									USE MD4015	
MD4031LS									USE MD4002LS	

STREETBIKE DISC BUYERS GUIDE

Disc No.	F/R	Type	Dia. (mm)	Hub Color	Profile	Bobbins	Left Bracket	Right Bracket	Model	Year
MD4032	Rear	Solid	240	N/A	Plain	N/A			GPX 250 R (EX 250 E)	86
MD4033LS/RS									USE MD4028LS/RS	
MD4034									USE MD4019	
MD4035LS/RS									USE MD4016	
MD4036									USE MD4017	
MD4038	Front	Solid	280	N/A	Plain	N/A			Z 1000 J3 Z 1000 R1/R2 (Eddie Lawson Replica) GPZ 1100 B2 Z 1100 R1	83 82-83 83 84
MD4040LS	Front	Solid	210	N/A	Plain	N/A			AR 50 A1/C2-C10 AR 80 A1/C1-C8	81-97 81-91
MD4041RS	Front	Solid	260	N/A	Plain	N/A			GPX 250 R (EX250 F) GPX 250 R	87 88-95
MD4042	Rear	Solid	230	N/A	Plain	N/A			GPX 250 R GPX 250 R (EX 250 F/G)	88-95 87-88
MD4043LS MD4043RS	Front Front	Floating Floating	260 260	Gold Gold	Plain Plain	6 6			Z 750 Y1 Ltd	82
MD4047LS MD4047RS	Front Front	Floating Floating	278 278	Gold Gold	Plain Plain	6 6			Z 400 J1 Z 440 A2 'Ltd' Z 440 D4 'Ltd' Z 500 B1-B2 Z 550 A1	80 79 82 79-80 80
MD4051 MD4051C	Rear Rear	Solid Solid	230 230	N/A N/A	Plain Contour	N/A N/A			GSX 250 FXK2/K3-K5 (ZR 250 C) ZXR 250 A1/A2/B1/B2 ZR 250 A1-A5 ZR 250 B6 Balius-II ZXR 250 C1-C3/D1 GPZ 500 'S' (EX 500 D1-D7) GPZ 500 S (EX 500 E1-E10)	02-05 89-90 91-95 02 91-95 94-01 94-04
MD4052LS MD4052RS VMD4052	Front Front Front	Floating Floating Floating	295 295 295	Gold Gold Black	Plain Plain Plain	6 6 9			Z 650 B1/B2/B3 Z 650 F1 Z 900 A4	79-81 80 77
MD4054 Billet	Rear	Solid	270	N/A	Plain	N/A			Z 1000 J1-J3 Z 1000 R1/R2 (Eddie Lawson Replica) Z 1000 K1/K2 LTD GPZ 1100 B1-B2 Z 1100 A1-A3 Z 1100 D1/D2 'Spectre' Z 1100 R1 VN 1500 A6 VN 1500 B2-B6	81-83 82-83 81-82 82-83 81-83 82-83 84 92 88-92
MD4056									USE MD4009	
MD4059LS MD4059RS VMD4059	Front Front Front	Floating Floating Floating	278 278 278	Silver Silver Black	Plain Plain Plain	6 6 9			Z 650 C1/C2/C3 Z 650 D2/D3	77-79 79-80
MD4060LS/RS									USE MD4006LS/RS	
MD4062 Billet	Rear	Floating	276	Silver	Plain	6			Z 650 C1/C2	77-78
MD4063 VMD4063	Rear Rear	Floating Floating	295 295	Silver Black	Plain Plain	6 9			Z 650 (D2/D3-SR)	79-80
MD4064LS MD4064RS VMD4064	Front Front Front	Floating Floating Floating	295 295 295	Silver Silver Black	Plain Plain Plain	6 6 9			Z 1000 A1-A4 Z 1000 H1	77-80 80
MD4067LS MD4067RS	Front Front	Solid Solid	270 270	N/A N/A	Plain Plain	N/A N/A			ZN 700 A1/A2 'Ltd'	84-85
MD4068	Rear	Solid	260	N/A	Plain	N/A			ZN 700 A1/A2 'Ltd'	84-85

STREETBIKE DISC BUYERS GUIDE

Disc No.	F/R	Type	Dia. (mm)	Hub Color	Profile	Bobbins	Left Bracket	Right Bracket	Model	Year
MD4069LS	Front	Floating	296	Silver	Plain	6			Z 900 Z1A/Z1B	74-76
MD4069RS	Front	Floating	296	Silver	Plain	6			H2/H2-A Mach IV (750cc)	72-73
VMD4069 Billet	Front	Floating	296	Black	Plain	9			H2-B/H2C Mach IV (750cc)	74-75
MD4071LS	Front	Solid	270	N/A	Plain	N/A			HI D/E/F 500	73-75
MD4071RS	Front	Solid	270	N/A	Plain	N/A			GPX 750 R F1-F3	87-89
MD4075									USE MD4077	
MD4076LS	Front	Floating	296	Silver	Plain	6			Z 1000 D1-D3 (ZIR)	78-79
MD4076RS	Front	Floating	296	Silver	Plain	6				
VMD4076	Front	Floating	296	Black	Plain	9				
MD4077	Rear	Floating	290	Silver	Plain	6			Z 1000 D1-D3 (ZIR)	78-79
VMD4077	Rear	Floating	290	Black	Plain	9			Z 1000 A1-A4	77-80
									Z 1000 H1	80
MD4078LS	Front	Floating	286	Gold	Plain	6			Z 1000 ST E1-E2	79-82
MD4078RS	Front	Floating	286	Gold	Plain	6				
VMD4078	Front	Floating	286	Black	Plain	9				
MD4082	Rear	Solid	280	N/A	Plain	N/A			ZG 1000 A1-A7	86-93
									ZG 1000 A9-A18	94-03
MD4085	Rear	Solid	270	N/A	Plain	N/A			VN 900 A6F Classic	06
									VN 900 Vulcan Classic (Spoke wheel)	07-21
									VN 900 Vulcan Custom (Cast wheel)	07-21
									VN 900 Vulcan Classic Special Edition (Spoke wheel)	11-20
MD4089LS	Front	Floating	299	Silver	Plain	6			Z 1300 A1-A5	79-83
MD4089RS	Front	Floating	299	Silver	Plain	6			ZG 1300 A1-A3	84-86
VMD4089	Front	Floating	299	Black	Plain	9				
MD4090	Rear	Solid	290	N/A	Plain	N/A			Z 1000 ST E1-E2	79-82
									Z 1300 A1-A5	79-83
									ZG 1300 A1-A3	84-86
MD4093LS									USE MD4124LS	
MD4094LS SILVER	Front	Floating	300	Silver	Plain	6			VN 1500 B2-B6	88-92
MD4095X GOLD	Front	Floating	280	Gold	Plain	6			KR-1 (KR 250 B2)	89
MD4096	Rear	Solid	210	N/A	Plain	N/A			KR-1 (KR 250 B2)	89
									KR-1S (KR 250 C2-C3)	90-92
MD4099	Front	Solid	260	N/A	Plain	N/A			AR 125 A1-A7/B1-B8	82-94
									ER 250 B1-B3	83-88
									GPZ 550 H1-H2	82-83
MD4105LS	Front	Solid	240	N/A	Plain	N/A			KH 100 G5-G8 (EX)	84-87
MD4105RS	Front	Solid	240	N/A	Plain	N/A			KH 125 L1 (EX)	84
									GPZ 305 A1/B1-B10	83-96
MD4108LS	Front	Solid	270	N/A	Plain	N/A			ZR 400 A1/B1	83-84
MD4108RS	Front	Solid	270	N/A	Plain	N/A			ZR 550 A1-A2 (Z 550 F)	83-84
MD4115LS									USE MD4124LS	
MD4117	Rear	Solid	220	N/A	Plain	N/A			ZZR 250 (EX 250 H1-H13)	90-03
MD4122LS									USE MD4008	
MD4122RS									USE MD4008	
VMD4123	Front	Floating	278	Black	Plain	9			KH 400 A3/A4/A5	76-78
MD4124LS	Front	Floating	300	Silver	Plain	6			EN 500 B1-B2/C1-C9	94-04
									VN 800 A1-A3	95-99
									VN 1500 C1-C2	94-95
									VN 1500 A6	92
									VN 1500 N1/N2/N3	00-02
MD4125LS	Front	Solid	300	N/A	Plain	N/A			VN 800 B1-B10/B6F Classic	96-06
									VN 800 C1/C2/E1/E2/E3 Drifter	99-04
									VN 1500 J1/J2/R1/R2/R3/N1/N2/N3	99-04

STREETBIKE DISC BUYERS GUIDE

Disc No.	F/R	Type	Dia. (mm)	Hub Color	Profile	Bobbins	Left Bracket	Right Bracket	Model	Year
MD4126LS/RS									USE MD4038	
MD4127									USE MD4054	
MD4128 BILLET	Rear	Solid	270	N/A	Plain	N/A			VN 1500 C1-C2 VN 1500 D1/D2/E1/F2	94-95 96-99
MD4129LS/RS									USE MD4008	
MD4130 MD4130C VR4130	Rear Rear Rear	Solid Solid Solid	250 250 250	N/A N/A N/A	Plain Contour Vee	N/A N/A N/A			GPZ 1100 E1/E2/F1	95-98
MD4131LS SILVER	Front	Floating	299	Silver	Plain	9			VN 1500 D1/D2/E1/E2	96-99
MD4132X MD4132XC VR4132BLK VR4132GRN	Front Front Front Front	Floating Floating Floating Floating	300 300 300 300	Gold Gold Black Green	Plain Contour Vee Vee	6 6 6 6			GPZ 1100 F1	96-98
MD4133 MD4133C VR4133	Rear Rear Rear	Solid Solid Solid	250 250 250	N/A N/A N/A	Plain Contour Vee	N/A N/A N/A			ZRX 1100 C1/C2/C3/C4 ZRX 1200 A1-A5/A6F ZRX 1200 B1-B3 ZZR 1200 C1H/C2H	97-00 01-07 01-03 02-04
MD4134 SILVER	Front	Floating	300	Silver	Plain	9			ZX-4 (ZX 400 G1/G1A/G1B)	88
MD4135LS MD4135RS	Front Front	Solid Solid	270 270	N/A N/A	Plain Plain	N/A N/A			GPZ 400 R (ZX 400 D/D3/D3A) ZL 400 B 'Eliminator 400 SE' FX 400 R (ZX 400 E1-E3)	85-87 88 86-88
MD4136X MD4136XC MD4136CC VR4136BLK VR4136GRN	Front Front Front Front Front	Floating Floating Floating Floating Floating	300 300 300 300 300	Gold Gold Chrome Black Green	Plain Contour Contour Vee Vee	6 6 6 6 6			ZX6R (ZX 600 G1/G2/J1/J2) ZX6R (ZX 636 A1P) 636cc ZX9R (ZX 900 C1/C2)	98-01 02 98-99
MD4137RS	Front	Solid	260	N/A	Plain	N/A			BENELLI BN 125 A1-A5/A6F/A7F Eliminator	98-07
MD4138 MD4138C VR4138	Rear Rear Rear	Solid Solid Solid	250 250 250	N/A N/A N/A	Plain Contour Vee	N/A N/A N/A			KAWASAKI ZX6R (ZX 600 G1/G2/J1/J2) ZX6R (ZX 636 A1P/B1/B2) 636cc ZX-6R (ZX 636 C1/C6F) ZX6R (ZX 600 P7F/P8F) ZX6R (ZX 600 R9F/RAF/RBF/RCF/RDF/REF/RFF/RGF (599cc)) ZX6RR (ZX 600 K1/M1) ZX-6RR (ER6-f ZX 600 N1/N6F) ER-6f (ECF/EDS/EEF/EFF/EGF) Non ABS ER-6n (ER 650 A6F/A7F/A8F/C9F/CAF/CBF) ER-6n (ECF/EDF/EEF/EFF/EGF) (Non ABS) KLE 650 A7F/A8F/A9F/CAF Versys Z 650 (ER650) 650 (KLE 650 CBF/CCF/CDF) Versys Non ABS Z 750 (ZR 750 J1/J2/J6F) Z 750 S (ZR 750 K1/K6F) ZX9R (ZX 900 E1/E2) ZX9R (ZX 900 F1/F2) ZX10R (ZX 1000 C1/C2/D6F) ZX10R (ZX 1000 E8F/E9F/FAF) Z 1000 (ZR 1000 A1/A2/A3/A6F)	98-01 02-04 05-06 07-08 09-16 03-04 05-06 12-16 06-11 12-16 07-10 17-20 11 04-06 05-06 00-01 02-04 04-06 08-10 03-06
MD4140LS MD4140RS	Front Front	Solid Solid	270 270	N/A N/A	Plain Plain	N/A N/A			GPX 400 R (ZX 400 F1)	87
MD4141X MD4141XC MD4141CC SILVER	Front Front Front	Floating Floating Floating	300 300 300	Silver Silver Chrome	Plain Contour Contour	6 6 6			ZR-7 (ZR 750 F1/F3/F5) ZR-7S (ZR 750 H1/H3) ZZR 600 D1-D3 Z 750 S K1/K6F/J1/J2/J6F Naked	99-04 01-04 90-93
MD4142 MD4142C	Rear Rear	Solid Solid	240 240	N/A N/A	Plain Contour	N/A N/A			ZR-7 (ZR 750 F1/F3/F5) ZR-7S ZR 750 H1/H3	99-04 01-04

STREETBIKE DISC BUYERS GUIDE

Disc No.	F/R	Type	Dia. (mm)	Hub Color	Profile	Bobbins	Left Bracket	Right Bracket	Model	Year
MD4143LS MD4143RS MD4144	Front Front Front	Solid Solid Solid	280 280 270	N/A N/A N/A	Plain Plain Plain	N/A N/A N/A			GPZ 400 R D4 GPZ 500 S (EX 500 B1-B5) GPZ 500 S (EX 500 E1-E10)	88 88-93 94-04
MD4146	Rear	Solid	300	N/A	Plain	N/A			VN 1500 P1/P2 VN 1600 A1/A2/A3/A6F VN 1600 B1/B2H/B6F/B7F (Mean Streak) VN 1600 D1H/D6F Classic Tourer M 1600 (VZ 1600 K4/K5 Intruder)	03-04 03-08 04-08 05-08 04-05
MD4147	Rear	Solid	320	N/A	Plain	N/A			VN 1500 G1/G2/L1/L2/L3/L4	98-03
MD4148	Rear	Solid	270	N/A	Plain	N/A			VN 800 C1/C2/E1/E2/E3 VN 1500 J1/J2/R1/R2/R3/N1/N2/N3	99-04 99-04
MD4149LS MD4149RS	Front Front	Floating Floating	300 300	Silver Silver	Plain Plain	9 9			ZXR 250 C1/C2/C3/D1	91-95
MD4150	Front	Solid	280	N/A	Plain	N/A			VN 1500 G1/G2 VN 1500 L1/L2/L3/L4	98-99 00-03
MD4151X MD4151XC	Front Front	Floating Floating	280 280	Gold Gold	Plain Contour	6 6			ZX6RR (ZX 600 K1/M1) ZX6R (ZX 636 B1/B2) CF MOTO 650 NK 650 TR 650 TK 650 GT 650 MT	03-04 03-04 12-19 13-14 13-15 20 20-21
MD4152XC MD4152CC VR4152BLK VR4152GRN	Front Front Front Front	Floating Floating Floating Floating	300 300 300 300	Gold Gold Black Green	Contour Contour Vee Vee	6 6 6 6			ZX-6RR (ZX 600 N1/N6F) ZX-6R (ZX 636 C1/C6F) ZX-6R (ZX 600 P7F/P8F) ZX-6R (ZX 600 R9F/RAF/RBF/RCF/RDF/REF/RFF/RGF - 599cc) Z 750 R Non ABS (ZR 750 NBF/NCF) Z 750 R ABS (ZR 750 PBF/PCF) ZX10R (ZX 1000 C1/C2/D6F/D7F) Z 1000 (ZR 1000 B7F/B8F/B9F) Z 1000 ABS (ZR 1000 C7F/C8F/C9F) Z 1000 Black Edition (ZR 1000 DCFA/DDFA/FEFA) Z1000 (ZR 1000 DAF/DBF/DCF/DDF/FEF/FFF) Z 1000 Special Edition (ZR 1000 GEFA) Z 1000 SX (ZX 1000 HBF/HCF/HDF - ABS Model) Z 1000 SX (ZX 1000 GBF/GCF/GDF - Non ABS Model) Z 1000 SX (ZX 1000 MEF/MFF/MGF/WHF/WJF- ABS Model) Z 1000 SX (ZX 1000 LEF/LFF/LGF - Non ABS Model) Z 1000 DAF/DAS/DBF/DCF/DCFA/DDF/DDFA (Non ABS/ 300mm Discs) Z 1000 EAF/EBF/ECF/ECFA/EDF/EDFA (ABS/300mm Discs)	05-06 05-06 07-08 09-16 11-12 11-12 04-07 07-09 07-09 12-15 10-15 14 11-13 11-13 14-18 14-16 10-13 10-13
MD4153X MD4153XC MD4153CC VR4153BLK VR4153GRN	Front Front Front Front Front	Floating Floating Floating Floating Floating	300 300 300 300 300	Gold Gold Chrome Black Green	Plain Contour Contour Vee Vee	6 6 6 6 6			ZZR 600 E1-E13 ZZR 600 (ZX 600 E6F)	93-05 06-07
MD4154X MD4154XC MD4154CC VR4154BLK VR4154GRN	Front Front Front Front Front	Floating Floating Floating Floating Floating	300 300 300 300 300	Gold Gold Chrome Black Green	Plain Contour Contour Vee Vee	6 6 6 6 6			Z 1000 (ZR 1000 A1-A3/A6F) ZX12R B3/B4/B6F KAWASAKI Ninja ZX-6R (ZX 636 - Non ABS - 636cc) Ninja ZX-6R (ZX 636 - Non ABS/KRT Edition - 636cc)	03-06 04-06 13-20 16-20
MD4155X MD4155XC MD4155CC VR4155BLK VR4155GRN VR4155CHGR GOLD	Front Front Front Front Front Front	Floating Floating Floating Floating Floating Floating	310 310 310 310 310 310	Gold Gold Chrome Black Green Green	Plain Contour Contour Vee Vee Vee	6 6 6 6 6 6			Ninja ZX-6R (ZX 636 - ABS - 636cc) Ninja ZX-6R (ZX 636 - ABS/KRT Edition - 636cc) ZX 6R 30th Anniversary Edition Non ABS (ZX 636 EFFA) ZX 6R 30th Anniversary Edition ABS (ZX 636 FFFA) Z 800 ADS/AEF/AFF/AGF (Non ABS) Z 800 BDS/BEF/BFF/BGF (ABS Model) Z 800 E CDS/CEF/CFE/CGF (Non ABS) Z 800 E DDS/DEF/DFF/DGF (ABS Model) KLZ 1000 Versys KLZ 1000 Versys SE LT Inc LT+ KLZ 1000 Versys S Tourer and Grand Tourer Z 1000 FEF/FEFA/FFF/FGF Non ABS Z 1000 HLF ABS Z 1000 JHF/JJF ABS Plain Discs	13-20 16-20 15 15 13-16 13-16 13-16 13-16 15-18 18-20 20-21 14-16 14-21 17-21

STREETBIKE DISC BUYERS GUIDE

Disc No.	F/R	Type	Dia. (mm)	Hub Color	Profile	Bobbins	Left Bracket	Right Bracket	Model	Year
MD4155X/XC/CC VR4155BLK/GRN/ VR4155CHGR/ GOLD Contd.									GTR 1400 (ZG 1400) ZZR 1400 (ZX 1400 A6F/A7F) ZZR 1400 ABS (ZX 1400 B6F/B7F/D8F/D9F/DAF/DBF) ZZR 1400 ABS ZZR 1400 Special Edition (ZX 1400) ZZR 1400 Performance Sport (ZX1400)	08-18 06-07 06-11 12-20 12-20 16-20
MD4156XC GOLD	Front	Floating	300	Gold	Contour	6			ER-6f (ABS Model) (EX 650 B6F/B7F/B8F/D9F/DAF) ER-6n (ABS Model) (ER 650 B6F/B7F/B8F/D9F/DAF) ER-6F (FCF/FDS/FEF/FFF/FGF) (ABS) ER-6n (FCF/FDF/FEF/FFF/FGF) (ABS) KLE 650 B7F-B9F/DAF Versys ABS 650 Versys (KLE 650 ABS Model) Ninja 650 ABS (EX 650 J) Ninja 650 KRT (EX 650 KRT) Z 650 (ER 650 Inc Performance) ABS Z 750 ABS (ZR 750 M7F/M8F/M9F/MAF/MBF) KLZ 1000 Versys	06-10 06-10 12-16 12-16 07-10 11-21 17-21 18-20 17-21 07-11 12-14
MD4156AXC With ABS ring fitted	Front	Floating	300	Gold	Contour	6			ER-6F (ABS Model) (EX 650 B6F/B7F/B8F/D9F/DAF/DBF) ER-6F (FCF/FDS/FEF/FFF/FGF) (ABS) ER-6N (ABS Model) (ER 650 B6F/B7F/B8F/D9F/DAF/DBF) ER-6n (FCF/FDF/FEF/FFF/FGF) (ABS) KLE 650 B7F-B9F/DAF/DBF Versys ABS 650 Versys (KLE 650 ABS Model) Ninja 650 (EX 650 K) Ninja 650 ABS (EX 650 J) Ninja 650 KRT (EX 650 KRT)	06-11 12-16 06-11 12-16 07-11 15-21 17-20 17-21 18-20
MD4157C VR4157	Rear Rear	Solid Solid	250 250	N/A N/A	Contour Vee	N/A N/A			Z 750 (ZR 750 L7F/L8F/L9F/LAF/LBF) Z 750 ABS (ZR 750 M7F/M8F/M9F/MAF/MBF) Z 750 R Non ABS (ZR 750 NBF/NCF) Z 750 R ABS (ZR 750 PBF/PCF) Z 800 ADS/AEF/AFF/AGF (Non ABS) Z 800 BDS/BEF/BFF/BGF (ABS Model) Z 800 E CDS/CEF/CFE/CGF (Non ABS) Z 800 E DDS/DEF/DFF/DGF (ABS Model) KLZ 1000 ACF/ADF/AEF Versys KLZ 1000 Versys KLZ 1000 Versys SE LT Inc LT+ KLZ 1000 Versys S Tourer and Grand Tourer Z 1000 (ZR 1000 B7F/B8F/B9F) Z 1000 ABS (ZR 1000 C7F/C8F/C9F/CAF/CBF) Z 1000 SX (ZX 1000 GBF/GCF/GDF) Non ABS Model Z 1000 SX (ZX 1000 HBF/HCF/HDF) (ABS) Z 1000 SX (ZX 1000 LEF/LFF/LGF) Non ABS Z 1000 SX (ZX 1000 MEF/MFF/MGF/WHF/WJF) ABS Z 1000 SX Tourer Z 1000 Special Edition (ZR 1000 GEFA) Z 1000 Black Edition (ZR 1000 DCFA/DDFA/FEFA) Z 1000 (ZR 1000 GEF) Z 1000 (ZR 1000 DAF/DBF/DCF/DDF/FEF/FFF) Z 1000 ABS (ZR 1000 EAF/EBF/ECF/EDF/GEF/GFF) Z 1000 DAF/DAS/DBF/DCF/DCFA/DDF/DDFA (Non ABS/300mm Discs) Z 1000 EAF/EBF/ECF/ECFA/EDF/EDFA (ABS/300mm Discs) Z 1000 FEF/FEFA/FFF/FGF (Non ABS/310mm Discs) Z 1000 GEF/GEFA/GFF/GGF/HHF/HJF (ABS/310mm Contour Discs) Z 1000 JHF/JJF ABS 310mm Plain Discs ZZR 1400 (ZX 1400 A6F/A7F) ZZR 1400 ABS (ZX 1400 B6F/B7F/D8F/D9F/DAF/DBF/FCF) ZZR 1400 ABS ZZR 1400 Special Edition ZZR 1400 Performance Sport	07-11 07-11 11-12 11-12 13-16 13-16 13-16 13-16 13-16 12-14 15-18 18-21 20-21 07-09 07-11 11-13 11-13 14-16 14-18 14 14 12-14 14 10-15 10-15 10-13 10-13 14-16 14-21 17-21 06-07 06-12 12-20 13-20 16-20
MD4158	Front	Solid	300	N/A	Plain	N/A			EJ 800 ABF/ACF (W 800/Solid F Disc) W 800 ABF VN 900 A6F Classic VN 900 Vulcan Classic (Spoke wheel) VN 900 Vulcan Custom (Cast wheel) VN 900 Vulcan Classic Special Edition (Spoke wheel) VN 1600 A1/A2/A3/A6F VN 1600 D1H/D6F VN 1700 Voyager ABS	11-12 11 06 07-21 07-21 11-20 03-08 05-08 09-18

STREETBIKE DISC BUYERS GUIDE

Disc No.	F/R	Type	Dia. (mm)	Hub Color	Profile	Bobbins	Left Bracket	Right Bracket	Model	Year
MD4158 Contd.	Front	Solid	300	N/A	Plain	N/A			VN 1700 C9F Classic Tourer VN 1700 DAF/DBF/DCF/DDF/CEF Classic Tourer ABS VN 1700 KBF/KCF/KDF/KEF Voyager Custom VN 1700 E9F Classic VN 1700 FAF/FBF/FCF/FDF/FEF Classic ABS VN 2000 A1/A2/A6F VN 2000 H8F/H9F Classic	09 10-14 11-14 09 10-14 04-07 08-09
MD4159XC VR4159BLK VR4159GRN	Front Front Front	Floating Floating Floating	300 300 300	Gold Black Green	Contour Vee Vee	6 6 6			ER-6f (EX 650 A6F-A8F/C9F/CAF/CBF) ER-6f (ECF/EDS/EEF/EFF/EGF) (non ABS) ER-6n (ER 650 A6F-A8F/C9F/CAF/CBF) ER-6n (ECF/EDF/EEF/EFF/EGF) (non ABS) KLE 650 A7F-A9F/CAF Versys KLE 650 A7F/A8F/B8F/B9F Versys 650 (KLE 650 CBF/CCF/CD/CEF) Versys Non ABS Z 750 (ZR 750 L7F/L8F/L9F/LAF/LBF)	06-11 12-16 06-11 12-16 07-10 07-09 11-14 07-11
MD4160C VR4160	Rear Rear	Solid Solid	270 270	N/A N/A	Contour Vee	N/A N/A			GTR 1400 (ZG 1400)	08-18
MD4161X MD4161XC VR4161BLK VR4161GRN	Front Front Front Front	Floating Floating Floating Floating	310 310 310 310	Gold Gold Black Green	Plain Contour Vee Vee	6 6 6 6			ZX10R (ZX 1000 E8F/E9F/FAF) ZX10R ABS (ZX 1000 KBF/KCF/KDF/KEF/KFF) ZX10R (ZX 1000 JBF/JCF/JDF/JEF/JFF) ZX10R 30th Anniversary Edition Non ABS (ZX 1000 JFFA) ZX10R 30th Anniversary Edition ABS (ZX 1000 KFFA)	08-10 11-15 11-15 15 15
MD4162C MD4162XC	Front Front	Solid Floating	290 290	N/A Gold	Contour Contour	N/A 6			EX 250 K8F/K9F/KAF/KBF/KBFA/KCF Ninja 250 R	08-12
MD4163C VR4163	Rear Rear	Solid Solid	220 220	N/A N/A	Contour Vee	N/A N/A			Z 125 Performance ABS Z 250 SL (Naked Non ABS) (BR 250 EFF/EGF/FHF) Z 250 SL (Naked ABS) (BR 250 FFF/FGF) Ninja 250 SL (BX 250 AFF/AFS/AFSA KRT Edition Non ABS) EX 250 K8F/K9F/KAF/KBF/KBFA/KCF Ninja 250 R EX 300 ADF/AEF/AFF Ninja (Non ABS) EX 300 AEFA/AFFA/AGFA Ninja 300 Special Edition Non ABS Z 300 Non ABS (ER 300 AFF/AGF) Z 300 ABS (ER 300 BFF/BGF/BGFA) Ninja 300 (ABS)	16-21 15-17 15-16 15 08-12 13-15 14-16 15-16 15-16
MD4164AC (With ABS Ring)	Rear	Solid	220	N/A	Contour	N/A			ER-6f (ABS Model) (EX 650 B6F/B7F/B8F/D9F/DAF/DBF) ER-6f (FCF/FDS/FEF/FFF) (ABS) ER-6n (ABS Model) (ER 650 B6F/B7F/B8F/D9F/DAF) ER-6n (FCF/FDS/FEF) (ABS) KLE 650 B7F/B8F/B9F/DAF/DBF Versys ABS 650 (KLE 650 DBF/DCF/DDF/DEF) Versys ABS Model Ninja 650 (EX 650 J) ABS Z 650 (ER 650) Performance ABS	06-11 12-15 06-10 12-15 07-11 11-14 17-21 17-21
MD4165C MD4165 VR4165	Rear Rear Rear	Solid Solid Solid	220 220 220	N/A N/A N/A	Plain Contour Vee	N/A N/A N/A			EN 650 Vulcan S EN 650 Vulcan S ABS EN 650 Vulcan S Café ABS EN 650 Vulcan SE ABS Ninja ZX-6R (ZX 636 - Non ABS - 636cc) Ninja ZX-6R (ZX 636 - Non ABS/KRT Edition - 636cc) Ninja ZX-6R (ZX 636 - ABS - 636cc) Ninja ZX-6R (ZX 636 - ABS/KRT Edition - 636cc) ZX 6R 30th Anniversary Edition Non ABS (ZX 636 EFFA) ZX 6R 30th Anniversary Edition ABS (ZX 636 FFFA) ZX 10 R (ZX 1000 JBF/JCF/JDF/JEF/JFF) ZX 10 R ABS (ZX 1000 KBF/KCF/KDF/KEF/KFF) ZX10R 30th Anniversary Edition Non ABS (ZX 1000 JFFA) ZX10R 30th Anniversary Edition ABS (ZX 1000 KFFA) ZX 10 R ZX 10 R Winter Test Edition (ZX1000 SGFB) ZX 10 R Ninja KRT Replica ZX 10 R SE Ninja Ninja ZX-10RR	15-21 15-21 18-21 18-21 13-21 16-21 13-21 16-21 15 15 11-15 11-15 15 15 16-21 16 16-20 18-21 17-21

STREETBIKE DISC BUYERS GUIDE

Disc No.	F/R	Type	Dia. (mm)	Hub Color	Profile	Bobbins	Left Bracket	Right Bracket	Model	Year
MD4166C MD4166X MD4166XC VR4166BLK VR4166GRN	Front Front Front Front Front	Solid Floating Floating Floating Floating	290 290 290 290 290	N/A Gold Gold Black Green	Contour Plain Contour Vee Vee	N/A 6 6 6 6			Ninja 125 ABS Z 125 Performance ABS Z 250 SL (Naked Non ABS) (BR 250 EFF/EGF/FHF) Z 250 SL (Naked ABS) (BR 250 FFF/FGF) Ninja 250 SL (BX 250 AFF/AFS/AFSA KRT Edition Non ABS) Ninja 250 SL (BX 250 BFF/BFS/BGF/BGFS ABS) Ninja 250 SL (BX 250 BFSA/BGSA KRT/ABS Edition) EX 300 ADF/AEF/AFF Ninja (Non ABS) EX 300 BDF/BEF/BFF/BGF Ninja ABS Model EX 300 BEFA/BFFA/BGFA Ninja Special Edition with ABS EX 300 AEFA/AFFA/AGFA Ninja 300 Special Edition Non ABS KLE 300 VERSYS-X 300 ABS KLE 300 VERSYS-X 300 Non ABS Z 300 Non ABS (ER 300 AFF/AGF/AGFA) Z 300 ABS (ER 300 BFF/BGF/BGFA)	19-21 16-21 15-17 15-16 15 15-16 15-16 13-15 13-16 14-16 14-16 17-21 17-21 15-16 15-16
MD4167X MD4167XC	Front Front	Floating Floating	296 296	Gold Gold	Plain Contour	6 6			ZX9R (ZX 900 C1/C2)	98-99
MD4169 7mm Thickness	Rear	Solid	260	N/A	Plain	N/A			GPZ 550 D1 Z 700 A1 Ltd GPZ 750 R1 GT 750 P1-P9 Z 750 E1 Z 750 H1-H2 Ltd Z 750 N1/N2 Spectre Z 750 L1-L4	82 84 82 82-96 80 80-81 82-83 81-84
MD4170X VR4170CHGR	Front Front	Floating Floating	330 330	Gold Green	Plain Vee	6 6			ZX 10 R ZX 10 R Winter Test Edition (ZX1000 SGFB) ZX 10 R Ninja KRT Replica ZX 10 R SE Ninja	16-20 16 16-20 18-21
MD4171C OS4171C	Front Front	Solid Floating	200 250	N/A Black	Contour Contour	N/A 6			Z 125 (BR125 Auto G/Box) Z 125 PRO (BR125 Manual G/Box) Z 125 Pro SE (BR 125 Manual G/Box)	16-20 16-20 18-20
MD4172C	Rear	Solid	184	N/A	Contour	N/A			Z 125 (BR125 Auto G/Box) Z 125 PRO (BR125 Manual G/Box) Z 125 Pro SE (BR 125 Manual G/Box)	16-20 16-20 18-20
MD4174X MD4174XC VR4174GRN VR4174BLK	Front Front Front Front	Floating Floating Floating Floating	310 310 310 310	Gold Gold Black Green	Plain Contour Vee Vee	6 6 6 6			KAWASAKI Ninja 400 (EX 400 - ABS) Ninja 400 KRT (EX 400 - ABS KRT)	17-21 18-21
MD4175X	Front	Floating	330	Gold	Plain	6			KAWASAKI ZX 10 RR Ninja ZX 10 RR Ninja	17-18 19-21
MD4177XC	Front	Floating	300	Gold	Contour	6			KAWASAKI Z 900 ABS	17-21
MD4178AC	Rear	Solid	250	N/A	Contour	N/A			KAWASAKI KLE 650 Versys ABS	16-21
MD4179AC	Rear	Solid	220	N/A	Contour	N/A			KAWASAKI Ninja 125 ABS Ninja 250 SL (BX 250 BFF/BFS/BGF/BGFS ABS) Ninja 250 SL (BX 250 BFSA/BGSA KRT/ABS Edition) EX 300 Ninja ABS EX 300 Ninja ABS KLE 300 Versys-X Z 300 Ninja ABS Ninja 400 ABS Ninja 400 KRT Edition ABS	19-21 15-16 15-16 13-16 14-16 17-20 15-16 17-20 17-21
MD4180	Rear								KAWASAKI EN 650 Vulcan S	15-21
MD4181	Front	Floating	300	Black	Contour	6			KAWASAKI Ninja 650 EX 650 ER 650	17-18 17-21
MD-TZ350/500	Front	Floating	298	Silver	Plain	10			YAMAHA Yamaha TZ350 Yamaha TZ500	

OFF ROAD DISC BUYERS GUIDE

Disc No.	F/R	Type	Dia. (mm)	Hub Color	Profile	Bobbins	Left Bracket	Right Bracket	Model	Year
MD6001D	Front	Solid	240	N/A	Plain	N/A			HONDA	
MD6001CX	Front	Solid	240	N/A	Contour	N/A			CRM 50 RN/RP/RR/RT	93-96
OSX6001	Front	Floating	280	Silver	Contour	6	BRK008		CRM 75 RK/RL/RN/RP/RR	89-94
OSX6001E	Front	Floating	280	Silver	Contour	6	BRK004		CR 125 RN/RP/RR*	92-94
SMX6001	Front	Floating	320	Black	Contour	6	BRK009		XLR 125 RW	98-01
									CTX 200/CTX 200 A Bushlander	04-16
									CRF 230 F	04-20
									CRF 230 F Easy Trial	04-07
									CRF 230 L	08-10
									CRF 230 M	09-10
									SL 230 V/W/X/1	97-01
									CRM 250 ARV/ARW (MD32)	97-98
									CRM 250 R (RM) MK2 MD24 (1200001-1211634)	91-92
									CRM 250 R (RP/RP-II) MK2/2MD24 (1300001-)	93
									AX-1 (NX 250 J/K/R/R3)	89-94
									XLR 250 Baja Mk 1	
									XLR 250 Baja Mk 2	
									XL 250 Degree	
									CRM 250 RR/RRII MK 3 (MD24)	94-96
									CR 250 RN/RP/RR	92-94
									NX 250 L/2L/M/P/2P	90-93
									XLR 250 RM/R3N/RP/RR/R3R (MD22)	91-
									XR 250 RE/RF	84-85
									XR 250 RM/RN/RP/RR/RS/RT/RV/RW/RX/R/Y/R1/R2/R3/R4	96-04
									XR 250 Y/3 (MD30)	00-03
									XR 250 3/5 (MD30) Motard	03-05
									XR 250 III Y/3 Baja	00-03
									XL 250 RL	90
									CRE 260	95-98
									XR 400 RT/RV/RW/RX/R/Y/R1-R5	96-05
									CR 500 RN/RP/RR	92-94
									XR 500 RD/RE	84-85
									XR 600 RM/RP/RR/RS/RT/RV/RW/RX/R/Y	91-00
									XR 650 RY/R1-R7	00-07
									HONDA-DALL-ARA	
									XR 250 R/650 R	04
MD6002D	Rear	Solid	220	N/A	Plain	N/A			CR 125 RK/RL/RM/RN/RP/RR/RS/RT/RV	89-97
MD6002CX	Rear	Solid	220	N/A	Contour	N/A			CR 250 RK/RL/RM/RN/RP/RR/RS/RT	89-96
									CR 500 RK/RL/RM/RN/RP/RR/RS/RT/RV/RW/RX/R/Y	89-00
MD6003D	Front	Solid	240	N/A	Plain	N/A			CR 125 RL/RM	90-91
									CR 250 RL/RM	90-91
									XR 250 RL	90
									CR 500 RL/RM	90-91
									XR 600 RJ/RK/RL	88-90
MD6004D	Front	Solid	215	N/A	Plain	N/A			CR 80 RG/RH/RJ/RK/RL/RM/RN/RP/RR/RS	86-95
MD6005D	Rear	Solid	190	N/A	Plain	N/A			CR 80 RN/RP/RR/RS/RT/RBT/RV/RBV/RW/RBW/RX/RB	92-02
MD6005C	Rear	Solid	190	N/A	Contour	N/A			CR 85 R/R2	03-07
MD6005CX	Rear	Solid	190	N/A	Contour	N/A			CR 85 R3/RB3/R4/RB4/R5/RB5/R6/RB6/R7/RB7	03-07
MD6006D	Front	Solid	174	N/A	Plain	N/A			ATC 250 RF/RG	85-86
									TRX 250 RJ/RK	88-89
									TRX 250 EX1/2/3/4/5/6/7/8	01-08
									TRX 250 X9/XA/XB	09-11
									TRX 300 EX P/R/S/T/N/W/X/Y/1/2/3/4/5/6/7/8	93-08
									TRX 300 X9	09
									TRX 400 EXX/EXY/EX1-EX8	99-08
									TRX 400 X9	09
									TRX 450 R4/R5/R6/ER6/R7/ER7/R8/ER8/R9/ER9	04-09
									TRX 700 XX8/XX9/XXB	08-11
MD6007D	Rear	Solid	186	N/A	Plain	N/A			TRX 250 RG/RH/RJ/RK	86-89
MD6008D	Front	Solid	240	N/A	Plain	N/A			CR 125 RK	89
									CR 250 RK	89
									NX 250 J/K	87-89
									XR 250 RG/RH/RJ/RK/RL	86-90
									XLR 250 R	91-
									CR 500 RK	89
									XR 600 RJ/RK/RL	88-90

OFF ROAD DISC BUYERS GUIDE

Disc No.	F/R	Type	Dia. (mm)	Hub Color	Profile	Bobbins	Left Bracket	Right Bracket	Model	Year
MD6009D	Rear	Solid	220	N/A	Plain	N/A			CR 125 RH/RJ CR 250 RH/RJ CR 500 RH/RJ	87-88 87-88 87-88
MD6010D MD6010CX SMX6010	Front Front Front	Solid Solid Solid	256 256 320	N/A N/A Black	Plain Vee Contour	N/A N/A 6			XR 300 R10 NX 500 J/K/L/M/N/P/R/S/T/V/W/X XR 600 RF/RG/RH XL 600 W/VW/VX Transalp NX 650 J/K/L/M/N/P/R/S/T/V/W/X 'Dominator' XR 650 L	10 88-99 85-87 97-99 88-02 93-21
MD6011D	Rear	Solid	220	N/A	Plain	N/A			YZ 125 U/W/A/B/D/E/F/G/H/J YZ 250 U/W/WRW/A/WRA/B/D/E/F/G/H/J WR 250 ZB/ZD/ZE/ZF/ZG/ZH/ZJ YZ 400 FK/WR 400 FK WR 500 ZD	88-97 88-97 91-93 98 92
MD6012D	Front	Solid	245	N/A	Plain	N/A			YZ 125 A/B YZ 250 A/WRA/B WR 250 ZB	90-91 90-91 91
MD6013D MD6013C MD6013CX	Rear Rear Rear	Solid Solid Solid	220 220 220	N/A N/A N/A	Plain Contour Contour	N/A N/A N/A			CPI Sauel 125 HONDA CRF 230 L CRF 230 M XR 250 RL/RM/RN/RP/RR/RS/RT/RV/RW/RX/RY/R1-R4 XR 250 SM XL 250 RL XL 250 R/R3/R3J/RX/RL/R3L/R3M/RN (MD22) CRM 250 RR/RR-II (MK3) (MD24-140) CRM 250 ARW/ARW (MD32) CRM 250 R (RM) MK2 MD24 (1200001-1211634) CRM 250 R (RP/RP-II) MK2/2 MD24 (1300001-) SL 250 V/W/X/1 XLR 250 RM/R3N/RP/RR/R3R (MD22) XR 250 Y/3 (MD30) XR 250 3/5 (MD30) Motard XR 250 III Y/3 Baja XR 300 R10 XR 400 RT/RV/RW/RX/RY/R1-R5 XR 400/440 R XR 400/440 SM NX 500 J/K/L/M XR 600 RM/RP/RR/RS/RT/RV/RW/RX/RY NX 650 J/K/L/LII/M Dominator SLR 650 V/W HONDA-DALL-ARA XR 250 R/SM/400/440 R/SM	08-10 09-10 90-04 04 90 99-90 94-96 97-98 91-92 93 97-01 91- 00-03 03-05 00-03 10 96-05 04 04 88-91 91-00 88-91 97-98 04
MD6014D MD6014C MD6014CX	Rear Rear Rear	Solid Solid Solid	220 220 220	N/A N/A N/A	Plain Contour Vee	N/A N/A N/A			SUZUKI DR 125 SMK8/SMK9/SML0 RM 125 J/K/L/M/N/P/R/S/T/V/W RM 250 H/J/K/L/M/N/P/R/S/T/V RMX 250 P/R/S/T/V/W RMX 250 SN/SR/SS RMX 250 ST/SV/SW/SX (SJ14A) DR-Z 400 SEY/EY/Y/SEK1/EK1/K1/SK2/EK2/K2/SK3/ EK3/K/K4/SK4/EK4/SK5/EK5/K6/EK6/SK6/SK7/EK7/K7/ SK8/SK9 KLX 400 R (KLX 400 B1/B2)	08-12 88-98 87-98 94-98 95-97 96-99 00-21 03-04
MD6015D MD6015C MD6015CX OSX6015 SMX6015	Front Front Front Front Front	Solid Solid Solid Floating Floating	250 250 250 280 320	N/A N/A N/A Silver Black	Plain Plain Vee Contour Contour	N/A N/A N/A 6 6		BRK023 BRK024	KAWASAKI KX 125 G1/H1/H2/J1/J2/K1-K5/L1/L2/L3/L4 KDX 200 E5-E6 KLX 250 R D1-D2 KX 250 G1/H1/H2/J1/J2/K1-K5/L1/L2/L3/L4 KLX 300 A2-A10/A6F/A7F KX 500 E1-E16	89-02 93-94 93-94 89-02 97-07 89-04
MD6016D	Front	Solid	230	N/A	Plain	N/A			YAMAHA YZ 125 W YZ 250 W/WRW WR 500 ZD	89 89 92

OFF ROAD DISC BUYERS GUIDE

Disc No.	F/R	Type	Dia. (mm)	Hub Color	Profile	Bobbins	Left Bracket	Right Bracket	Model	Year
MD6017D MD6017C MD6017CX OSX6017 OSX6017E SMX6017	Front Front Front Front Front Front	Solid Solid Solid Floating Floating Floating	250 250 250 280 280 320	N/A N/A N/A Silver Silver Black	Plain Plain Vee Contour Contour Contour	N/A N/A N/A 6 6 6		BRK031 BRK038	SUZUKI DR 125 SMK8/SMK9/SML0 RM 125 K/L/M/N/P/R/S/T/V/W/X/Y/K1-K9 RM 125 XCK8 DR 250 RS/RLS/RT/RV/RLV/RW/RLW/RY DR 250 RXT/RXLT/RXV/RXLV/RXW/RXLW/RXGW/ RXGLW/RXY/RXGY (Djebel 250 XC/GPS SJ45A) DR-Z 250 K1-K7 (DJ43A) RM 250 K/L/M/N/P/R/S/T/V/W/X/Y/K1-K9 RM 250 XCK8 RMX 250 P/R/S/T/V/W RMX 250 ST/SV/SW/SX (SJ14A) RMX 250 SN/SR/SS DR 350 SEW/SEX Electric Start/6 bolt front disc (USA Only) DR-Z 400 S KAWASAKI KLX 400 R (KLX 400 B1/B2)	08-12 89-12 09 95-00 96-98 01-07 89-12 09 94-98 96-99 95-97 98-99 00-21 03-04
MD6018D MD6018C OSX6018	Front Front Front	Solid Solid Floating	200 200 250	N/A N/A Silver	Plain Plain Vee	N/A N/A N/A		BRK001	RM 80 XG/XH/XJ/XK/XL/XM/XN/XP/XR/XS/T/V/W/X/Y/K1 RM 85 K2/LK2/K3/LK3/LK4/K4	86-01 02-04
MD6019D									USE MD6025D	
MD6020D	Front	Solid	160	N/A	Plain	N/A			LT 250 RH/RJ/RK/RL	87-90
MD6021D	Rear	Solid	220	N/A	Plain	N/A			CAN AM DS 450 XXC/XMX, Offroad without handbrake SUZUKI LT 250 RH/RJ/RK/RL	08-15 87-90
MD6022D	Front	Solid	170	N/A	Plain	N/A			LT 500 RL	90
MD6023D	Rear	Solid	240	N/A	Plain	N/A			LT 500 RL	90
MD6024D MD6024C MD6024CX	Rear Rear Rear	Solid Solid Solid	220 220 220	N/A N/A N/A	Plain Contour Contour	N/A N/A N/A			KAWASAKI KX 125 G1/H1/H2/J1/J2/K1-K5/L1/L2/L3 KDX 200 E1-E6 KX 250 G1/H1/H2/J1/J2/K1-K5/L1/L2/L3 KX 500 E1-E16	89-01 89-94 89-01 89-04
MD6025D MD6025C	Rear Rear	Solid Solid	185 185	N/A N/A	Plain Contour	N/A N/A			KX 80 L1/L2/N2/L3/N3/R1/T1 KX 80 R2-R7/T2-T6/W1-W3 KX 100 A1/A2/B1-B7/C1-C3 SUZUKI RM 80 XL/XM/XN/XP/XR/XS/T/V/W/X/Y/K1 RM 85 K2/LK2/K3/LK3/LK4/K4	88-91 92-00 89-01 90-01 02-04
MD6026D	Front	Solid	220	N/A	Plain	N/A			KAWASAKI KX 80 R2-R7/T2-T6/W1-W3 KX 85/85 II A1/B1 KX 100 B2-B7/C1/C2/C3	92-00 01 91-01
MD6027D	Front	Solid	200	N/A	Plain	N/A			KX 80 E2/E3/G1/G2/J1/J2 KX 80 L1-L3/N2/N3/R1/T1 KX 100 A1/A2/B1	84-87 88-91 89-91
MD6028D MD6028C MD6028CX OSX6028 OSX6028E SMX6028	Front Front Front Front Front Front	Solid Solid Solid Floating Floating Floating	245 245 245 280 280 320	N/A N/A N/A Silver Silver Black	Plain Plain Plain Contour Contour Contour	N/A N/A N/A 6 6 6		BRK035	YAMAHA YZ 125 D/E/F/G/H/J/K/L/M YZ 250 D/E/F/G/H/J/K/L/M WR 250 ZD/ZE/ZF/ZG/ZH/ZJ/ZK WR 250 FP/FR/FS/FT/FV/FW/FX/FY WR 250 FW YZ 250 FW YZ 250 FN/FP/FR/FS/FT/FV/FW/FX YZ 250 X/Y WR 400 FL/FM/FN YZ 400 FK/FL/WR 400 FK/FL/FM WR 426 FN/FP YZ 426 FM/FN/FP YZ 450 FR/FS/FT/FV/FW/FX WR 450 FR/FS/FT/FV/FW/FX/FY	92-00 92-00 92-98 02-09 07 07 01-09 08-09 99-01 98-00 2001 00-02 03-09 03-09
MD6029D	Front	Solid	190	N/A	Plain	N/A			YAMAHA YZ 80	86-89

OFF ROAD DISC BUYERS GUIDE

Disc No.	F/R	Type	Dia. (mm)	Hub Color	Profile	Bobbins	Left Bracket	Right Bracket	Model	Year
MD6030D	Front	Solid	220	N/A	Plain	N/A			YAMAHA	
MD6030C	Front	Solid	220	N/A	Plain	N/A			YZ 80 S/T/U/W	05-20
MD6030CX	Front	Solid	220	N/A	Plain	N/A			YZ 85 (2T - Small Wheel F 17"/R 14")	02-22
OSY6030C	Front	Floating	250	Silver	Contour	6	BRK036		YZ 85 (2T - Big Wheel F 19"/R 16")	02-22
OSS6030C	Front	Floating	250	Silver	Contour	6	BRK029		SUZUKI	
									RM 85 Small Wheel 17"Front and 14"Rear	05-22
									RM 85 Big Wheel 19"Front and 16"Rear	05-21
MD6031D	Rear	Solid	190	N/A	Plain	N/A			YAMAHA	
									YZ 80 E/F/LWF/LWG/G/LWH/H/LWJ/J/LWK/K/L/LWL/M/LWM/N/LWN	93-01
MD6031C	Rear	Solid	190	N/A	Contour	N/A			YZ 85 (2T - Small Wheel F 17"/R 14")	02-21
MD6031CX	Rear	Solid	190	N/A	Contour	N/A			YZ 85 (2T - Big Wheel F 19"/R 16")	02-21
MD6032D	Front	Solid	260	N/A	Plain				BETA	
MD6032C	Front	Solid	260	N/A	Contour				RR 250 Enduro 2T	13-14
MD6032CX	Front	Solid	260	N/A	Contour				RR 250 Enduro 2T RC	18-20
OSX6032	Front	Floating	280	Silver	Contour	6	BRK011		Enduro RR 250 2T MY20	20-21
OSX6032E	Front	Floating	280	Silver	Contour	6	BRK015		RR 250 Racing	20
OSX6032ORG	Front	Floating	280	Orange	Contour	6	BRK011ORG		250 X-Trainer	20-21
OSX6032EORG	Front	Floating	280	Orange	Contour	6	BRK015ORG		Enduro RR 300 2T MY20	20-21
OSX6932ORG	Front	Floating	280	Orange	Contour	6	BRK013ORG		RR 300 Enduro 2T	13-14
SMX6032	Front	Floating	320	Black	Contour	6	BRK012		RR 300 Enduro 2T RC	18-20
SMX6932	Front	Floating	320	Black	Contour	6	BRK014		RR 300 Racing	15
SMX6032E	Front	Floating	320	Black	Contour	6	BRK016		300 X-Trainer	15-21
SMX6032ORG	Front	Floating	320	Orange	Contour	6	BRK012ORG		Enduro RR 3500 4T MY20	20-21
SMX6032EORG	Front	Floating	320	Orange	Contour	6	BRK016ORG		RR 350 Enduro 4T	12-14
									RR 350 Efi 4T	15
									RR 350 4T Enduro Racing	13-20
									RR 350 4T Racing	15
									Enduro RR 390 4T MY20	20-21
									Enduro RR-S 390	20-21
									RR 390 4T	15-20
									RR 400 4T Racing	12-14
									Enduro RR 430 4T MY20	20-21
									RR 430 4T	15
									RR 430 4T Racing	15-21
									RR 450 4T Enduro	12-14
									RR 450 4T Enduro Racing	13-20
									RR 450 4T Cross Country	12
									Enduro RR 450 4T MY20	20-21
									RR 480 4T	15
									RR 480 4T Racing	15-21
									RR 498 4T Enduro	12-20
									RR 498 4T Enduro Racing	13-14
									500 RR-S 4T	20-21
									GAS GAS (Pierer Mob)	
									MC 125cc 2T	21
									EC 250cc 2T	21
									EC 250cc F 4T	21
									MC 250cc F 4T	21
									EC 300cc 2T	21
									EC 350cc F 4T	21
									MC 450cc F 4T	21
									HUSABERG	
									All MX/Enduro Models	00-14
									TE 125 (2T)	12-14
									TE 250 (2T)	11-14
									TE 300 (2T)	11-14
									FE 250 (4T)	13-14
									FE 350 (4T)	13-14
									FE 390 (New 70° Engine)	10-12
									FE 450 E	06-08
									FE 450 (New 70° Engine)	09-13
									FX 450 (New 70° Engine)	10-11
									FE 501 (4T)	13-14
									FE 550 E	06-08
									FE 570 (New 70° Engine)	09-12
									FE 650 E	06-08
									TC 125 (2T)	14-22
									TE 125 (2T)	14-22
									TE 150 (2T)	18-22
									FC 250 (4T)	14-22
									FE 250 (4T)	14-22
									TC 250 (2T)	14-22

OFF ROAD DISC BUYERS GUIDE

Disc No.	F/R	Type	Dia. (mm)	Hub Color	Profile	Bobbins	Left Bracket	Right Bracket	Model	Year
MD6032D	Front	Solid	260	N/A	Plain				TE 250 (2T)	14-22
MD6032C	Front	Solid	260	N/A	Contour				TE 300 (2T)	14-22
MD6032CX	Front	Solid	260	N/A	Contour				TX 300 (2T)	18-22
OSX6032	Front	Floating	280	Silver	Contour	6	BRK011		FC 350 (4T)	14-22
OSX6032E	Front	Floating	280	Silver	Contour	6	BRK015		FX 350 (4T)	18-22
OSX6032ORG	Front	Floating	280	Orange	Contour	6	BRK011ORG		FC 450 (4T)	14-22
OSX6032EORG	Front	Floating	280	Orange	Contour	6	BRK015ORG		FE 450 (4T)	14-22
OSX6932ORG	Front	Floating	280	Orange	Contour	6	BRK013ORG		FR 450 (4T)	16-22
SMX6032	Front	Floating	320	Black	Contour	6	BRK012		FX 450 (4T)	17-22
SMX6932	Front	Floating	320	Black	Contour	6	BRK014		FE 501 (4T)	14-22
SMX6032E	Front	Floating	320	Black	Contour	6	BRK016		KTM	
SMX6032ORG	Front	Floating	320	Orange	Contour	6	BRK012ORG		EXC/EGS 125	94
SMX6032EORG	Front	Floating	320	Orange	Contour	6	BRK016ORG		EXC 125	95-99
Contd.									EXC 125	00-03
									EXC 125	04-08
									EXC 125	09-17
									EXC 125	11-17
									EXE 125	00
									LC2 125	96-98
									MX 125	92-93
									MX 125	92-93
									SX 125	94-99
									SX 125	00-03
									SX 125	04-08
									SX 125	09-22
									XC-W 125	17-19
									150 EXC Tpi	21-22
									SX 150	08
									SX 150	09-22
									XC 150	11-13
									XC-W 150	17-21
									EXC/EGS 200	98-99
									EXC/EGS 200	00-03
									EXC 200	04-08
									EXC 200	09-16
									D-XC/E-XC/T-XC/E-GS 250	92-93
									EXC/EGS 250	94
									EXC 250	95-99
									EXC 250	00-03
									EXC 250	04-08
									EXC 250	09-21
									EXC 250 Tpi	11-22
									EXC 250	06
									EXC-F 250	06-08
									EXC-F 250	11-22
									MX 250	92-93
									SX 250	94-99
									SX 250	00-02
									SX 250	03-08
									SX 250	09-22
									SX-F 250	06-08
									SX-F 250	09-22
									SX-F 250	20
									SX-F 250	12
									XC 250	11-17
									XC 250	19-21
									XC-F 250	11-20
									EXC 300	00-03
									EXC 300	04-08
									EXC 300	09-21
									EXC 300	11-20
									EXC 300 Tpi	20-22
									EXC-E 300	08-09
									XC 300	11-21
									EXC 350	94-95
									EXC 350	96-97
									EXC-F 350	12-22
									SX-F 350	11-22
									SX-F 350	12
									XC-F 350	12-21
									EXC 360	96-97
									SX 360	96-97
									EXC 380	98-99
									EXC 380	00-03
									SX 380	98-99
									SX 380	00-03

OFF ROAD DISC BUYERS GUIDE

Disc No.	F/R	Type	Dia. (mm)	Hub Color	Profile	Bobbins	Left Bracket	Right Bracket	Model	Year
MD6032D	Front	Solid	260	N/A	Plain				EXC 125	00-03
MD6032C	Front	Solid	260	N/A	Contour				EXC/EGS 400	00-03
MD6032CX	Front	Solid	260	N/A	Contour				EXC 400 Racing	00
OSX6032	Front	Floating	280	Silver	Contour	6	BRK011		EXC 400 Racing	04-07
OSX6032E	Front	Floating	280	Silver	Contour	6	BRK015		SC 400 Supercompetition LC4	96-99
OSX6032ORG	Front	Floating	280	Orange	Contour	6	BRK0110RG		SX 400	00-02
OSX6032EORG	Front	Floating	280	Orange	Contour	6	BRK0150RG		EXC 440	94-95
OSX69320RG	Front	Floating	280	Orange	Contour	6	BRK0130RG		SX 440	94-95
SMX6032	Front	Floating	320	Black	Contour	6	BRK012		EXC 450	03
SMX6932	Front	Floating	320	Black	Contour	6	BRK014		EXC 450	04-08
SMX6032E	Front	Floating	320	Black	Contour	6	BRK016		EXC-F 450	09-22
SMX60320RG	Front	Floating	320	Orange	Contour	6	BRK0120RG		EXC 450	06-07
SMX6032EORG	Front	Floating	320	Orange	Contour	6	BRK0160RG		EXC-R 450	08
Contd.									SX 450	03-06
									SX-F 450	07-08
									SX-F 450	09-22
									EXC-F 500	12-22
									EXC 500	12-21
									500 XCF-W	21
									SX-F 505	07-08
									SX-F 505	09
									EXC 520	01-03
									SX 520	01-03
									EXC 525	03
									EXC 525	04-05
									EXC 525	06
									MXC 525	03
									MXC 52504	
									SX 525	03-06
									XC 525	06-07
									EXC 530	09-10
									EXC 530	11
									EXC-R 530 (4T)	08
									MXC 550	96
									EGS-E 620 Adventure/Rallye	99
									SC 620 Supercompetition	96-00
									SX 620/EXC/EGS	94
									SX EXC/EGS 620	95
									SX 620	96-99
									LC4 625 SC	02
									SXC 625	03-06
MD6033D									USE MD6035	
MD6034D	Front	Solid	220	N/A	Plain	N/A			KTM	
									EXC 125	89
									D-XC/E-XC/E-GS 125	90-93
									EXC/EGS 250	89
									DXC/EXC 250	90
									DXC/EXC/EGS 250	91
									DXC/EXC/EGS 350	90-91
									EXC 350	89
									LC-4 MX/EXC 500	89
									LC-4 MX 500 (Brembo)	90-91
									LC-4 EXC 500 (Grimeca)	90-91
									LC-4 MX/EXC 600	89
									LC-4 EXC 600	90-93
MD6035D	Rear	Solid	220	N/A	Plain	N/A			GAS GAS (Pierer Mob)	
MD6035C	Rear	Solid	220	N/A	Contour	N/A			MC 125cc 2T	21
MD6035CE	Rear	Solid	220	N/A	Contour	N/A			EC 250cc 2T	21
MD6035CX	Rear	Solid	220	N/A	Contour	N/A			EC 250cc 2T	21
									EC 250cc F 4T	21
									MC 250cc F 4T	21
									EC 300cc 2T	21
									EC 350cc F 4T	21
									MC 450cc F 4T	21
									HUSABERG	
									TE 125 (2T)	12-14
									TE 250 (2T)	11-14
									TE 300 (2T)	11-14
									FE 250 (4T)	13-14
									FE 350 (4T)	13-14
									FE 390 (New 70° Engine)	10-12
									FE 450 E	06-08
									FE 450 (New 70° Engine)	09-13

DISC BUYERS GUIDE

OFF ROAD DISC BUYERS GUIDE

Disc No.	F/R	Type	Dia. (mm)	Hub Color	Profile	Bobbins	Left Bracket	Right Bracket	Model	Year
MD6035D	Rear	Solid	220	N/A	Plain	N/A			FS 450 C	06
MD6035C	Rear	Solid	220	N/A	Contour	N/A			FS 450 E	06-08
MD6035CE	Rear	Solid	220	N/A	Contour	N/A			FX 450 (New 70° Engine)	10-11
MD6035CX	Rear	Solid	220	N/A	Contour	N/A			FE 501 (4T)	13-14
Contd.									FE 570 (New 70° Engine)	09-12
									HUSQVARNA	
									TC 125	14-22
									TE 125	14-19
									TE 150	18-22
									FC 250 (4T)	14-22
									FE 250 (4T)	14-22
									TC 250	14-22
									TE 250	14-18
									TE 250	19-22
									TE 300	14-20
									TE 300	19-22
									TE 300	19-21
									TE 300	22
									TX 300	18-21
									FC 350	14-22
									FE 350	14-22
									FE 350	22
									FX 350 (4T)	14-21
									FC 450 (4T)	14-22
									FC 450 (4T)	19-22
									FE 450 (4T)	14-22
									FS 450 (4T)	15-20
									FX 450 (4T)	17-21
									FE 501	14-22
									KTM	94
									SX 125	95-17
									EXC/EGS 125	1994
									EXC 125	95-99
									EXC 125	00-03
									EXC 125	04-08
									EXC 125	09-17
									EXC 125	11-17
									EXE 125	00
									LC2 125	96-98
									SX 125	00-03
									SX 125	04-08
									SX 125	09-22
									XC-W 125	17-19
									150 EXC Tpi	21-22
									SX 150	08
									SX 150	09-22
									XC 150	11-13
									XC-W 150	17-21
									EXC/EGS 200	98-99
									EXC/EGS 200	00-03
									EXC 200	04-08
									EXC 200	09-16
									EXC/EGS 250	94
									EXC 250	95-99
									EXC 250	00-03
									EXC 250	04-08
									EXC 250	09-21
									EXC 250 Tpi 2T	11-22
									EXC 250 Tpi Six Days 2T	11-22
									EXC 250	06
									EXC-F 250	06-08
									EXC-F 250	09-21
									EXC-F 250 4T	11-22
									EXC-F 250 Six Days 4T	11-22
									SX 250	94-99
									SX 250	00-02
									SX 250	03-08
									SX 250	09-22
									SX-F 250	06-08
									SX-F 250	09-22
									SX-F 250	20
									SX-F 250	12
									XC 250	11-17
									XC 250	19-22
									XC-F 250	11-20
									XC 300	00-03

OFF ROAD DISC BUYERS GUIDE

Disc No.	F/R	Type	Dia. (mm)	Hub Color	Profile	Bobbins	Left Bracket	Right Bracket	Model	Year
MD6035D	Rear	Solid	220	N/A	Plain	N/A			EXC 300	04-08
MD6035C	Rear	Solid	220	N/A	Contour	N/A			EXC 300 Tpi 2T	09-22
MD6035CE	Rear	Solid	220	N/A	Contour	N/A			EXC 300 Tpi Six Days 2T	09-22
MD6035CX	Rear	Solid	220	N/A	Contour	N/A			EXC 300	11-20
Contd.									EXC 300	20-21
									EXC-E 300	08-09
									XC 300	11-21
									EXC 350	96-97
									EXC-F 350	11-21
									EXC-F 350 Six Days	12-21
									EXC-F 350 WESS	22
									SX-F 350	11-22
									SX-F 350	12
									XC-F 350	12-21
									EXC 360	96-97
									SX 360	96-97
									EXC 380	98-99
									EXC 380	00-03
									SX 380	98-99
									SX 380	00-03
									EXC 400 Racing	00
									EXC 400 Racing	04-07
									SX 400	00-02
									EXC 450	03
									EXC 450	04-08
									EXC 450	09-22
									EXC 450 Six Days	11-22
									EXC 450	06-07
									EXC-R 450	08
									SX 450	03-06
									SX-F 450	07-08
									SX-F 450	09-22
									EXC-F 500	12-22
									EXC-F 500 Six Days	12-22
									500 XCF-W	21
									SX-F 505	07-08
									SX-F 505	09
									EXC 520	01-03
									SX 520	01-03
									EXC 525	03
									EXC 525	04-05
									EXC 525	06
									MXC 525	03
									MXC 525	04
									SX 525	03-06
									XC 525	06-07
									EXC 530	09-10
									EXC 530	11
									EXC-R 530 (4T)	08
MD6036D	Front	Solid	250	N/A	Plain	N/A			KAWASAKI	
									KX 125 D1/E1/E2/F1	85-88
									KDX 200 C1-C3	86-88
									KDX 200 E1-E4	89-92
									KDX 200 SR (DX 200 G)	
									KX 250 D1-D2/E1/F1	85-88
									KX 500 B1-B2/C1/D1	85-88
MD6037D	Front	Solid	240	N/A	Plain	N/A			HONDA	
MD6037CX	Front	Solid	240	N/A	Contour	N/A			CR 125 RS/RT/RV/RW/RX/R1-R7	95-07
OS6037C	Front	Solid	280	Silver	Contour	6			CR 250 RS/RT/RV/RW/RX/R1-R7	95-07
OSX6037	Front	Floating	280	Silver	Contour	6			CRE F 250 R	08-09
SMX6037	Front	Floating	320	Black	Contour	6			CRE F 250 X	08-11
OSX6437	Front	Floating	280	Silver	contour	6			CRF 250 R4/R5/R6/R7/R8/R9/RA/RB/RC/RD/RE/RF/RG	04-16
									CRF 250 R	08-09
									CRF 250 X	04-20
									CRF 250 XRL (Road legal)	14-20
									CRE F 300 X	08-09
									CRF 450 R	02-20
									CRF 450 R	04-09
									CRF 450 X	05-22
									CRF 450 XRL (Road legal)	14-16
									CR 500 RS/RT/RV/RW/RX/R1	95-01
									CRE F500 X	08-09

OFF ROAD DISC BUYERS GUIDE

Disc No.	F/R	Type	Dia. (mm)	Hub Color	Profile	Bobbins	Left Bracket	Right Bracket	Model	Year
MD6038D MD6038CX	Rear Rear	Solid Solid	220 220	N/A N/A	Plain Contour	N/A N/A			SUZUKI TS 125 RK/RL/RM/RN/RP/RR TS 200 RK/RL/RM/RN/RP/RR DR 250 SL/SM/SN/SEP/SER/SES (SJ44A) DR 350 SL/SM/SN/SP 4 Bolt front disc/Kick start DR 350 SER/SES (Electric street/4 bolt front disc)	90-96 89-94 90-95 90-93 94-95
MD6039D	Front	Solid	230	N/A	Plain	N/A			YAMAHA DT 125 R DT 125 RE YZ 125/250 U TT 350 (ITJ) YZ 490 U TT 600 N (59X) Frame # 59X00101-59X007852 TT 600 W (2JT/3SW1) (Frame # 59X007853-)	88-03 04-07 88 85-89 88 85-88 89-92
MD6040D MD6040CX OSX6040	Front Front Front	Solid Solid Floating	250 250 280	N/A N/A Silver	Plain Contour Contour	N/A N/A 6			SUZUKI DR 250 SL/SM/SN/SEP/SER/SES (SJ44A) DR 350 SL/SM/SN/SP 4 bolt front disc/Kick start DR 350 SER/SES (Electric start/4 bolt front disc) DR 350 SET/SEV/SEW/SEX (Electric start/4 bolt front disc) (UK/Europe)	90-95 90-93 94-95 96-97
MD6041D									USE MD6082D	
MD6042D MD6042CX SMX6042	Front Front Front	Solid Solid Floating	260 260 320	N/A N/A Black	Plain Contour Contour			BRK017	KAWASAKI KLR 650 A1-A3	87-89
MD6043D									USE MD6067D	
MD6044D	Front	Solid	276	N/A	Plain	N/A			HONDA XL 600 VH/VJ/VK/VM/VN/VP/VR/VT Transalp FX 650 X/Y 'Vigor' SLR 650 V/W XLV 750 R (RD/RF)	87-96 99-03 97-98 83-88
MD6045D MD6045CX	Rear Rear	Solid Solid	220 220	N/A N/A	Plain Contour	N/A N/A			XR 650 L	93-21
MD6046D	Front	Solid	166	N/A	Plain	N/A			TRX 250 RG/RH	86-87
MD6047D	Front	Solid	203	N/A	Plain	N/A			YAMAHA YTZ 250 N/S TR1-Z	85-86
MD6050D	Rear	Solid	220	N/A	Plain	N/A			YFS 200 B/F/G/H/J/K/L/M/N/P Blaster	91-02
MD6051D	Front	Solid	161	N/A	Plain	N/A			YFZ 350 T/U/W	87-89
MD6053D	Rear	Solid	220	N/A	Plain	N/A			YFM 350 FXG/FXH/FXJ/FXK/FXL/FXM/FXN/FXP/FXR/ FXS Wolverine DERBI DXR 200 DXR 200 Quad (Front disc model) DXR 250	95-04 04-07 04-07 04-06
MD6054D	Front	Solid	161	N/A	Plain	N/A			YAMAHA YFS 200 R/S/T/V YFM 250 XN/XP/XR/XS YFM 250 BT/BV Bruin YFM 250 BW/BX/BY Big Bear YFM 250 RX/RV Raptor YFM 250 R (338) YFM 250 R (1BT) YFM 350 XD/XE/XF/XG/XH/XJ/XK/XL/XM/XN/XP/XR/XS YFM 350 S/T/V/R-WW/RW/RX/RV/RZ Raptor YFZ 350 A/D/E/F/G/H/J/K/L/M/N/P/R/S/T/V Banshee YFM 400 FGW/FGX Grizzly YFZ 450 S/T/W/X YFZ 450 RY/RZ (Quad) YFZ 450 RSEA/RSEB/RSED/RSE YFZ 450 B/D YFM 660 RN/RP/RR/RS/RT Raptor YFM 700 RV/RW/RA/RD/RE Raptor YFM 700 RSE DERBI DXR 200	03-06 01-04 05-06 07-10 08-09 09-11 12-13 92-04 04-10 90-09 07-08 04-08 09-10 11-14 13-14 01-05 06-14 13-18 04-07

OFF ROAD DISC BUYERS GUIDE

Disc No.	F/R	Type	Dia. (mm)	Hub Color	Profile	Bobbins	Left Bracket	Right Bracket	Model	Year
MD6054D Contd.	Front	Solid	161	N/A	Plain	N/A			DERBI Contd. DXR 250	04-07
MD6055D	Rear	Solid	245	N/A	Plain	N/A			YAMAHA YFM 350 XD/XE/XF/XG/XH/XJ/XK/XL/XM/XN/XP/XR/XS	92-04
MD6056D									USE MD6008D	
MD6057D	Front	Solid	240	N/A	Plain	N/A			KAWASAKI KMX 200 A2/A3 KLR 250 D2-D22	89-92 84-05
MD6058D MD6058C MD6058CX OSX6058	Front Front Front Front	Solid Solid Solid Floating	220 220 220 280	N/A N/A N/A Silver	Plain Contour Contour Contour	N/A N/A N/A 6		BRK026	HONDA CR 80 RT/RBT/RBV/RV/RBW/RW/RX/RBX/RV/RBY/R1/ RB1/R21/RB2 CR 85 R/R2 CR 85 R3/RB3/R4/RB4/R5/RB5/R6/RB6/R7/RB7	96-02 03-07 03-07
MD6059D	Front Rear	Solid Solid	206 206	N/A N/A	Plain Plain	N/A N/A			ATC 200 XD ATC 250 RD ATC 250 RF/RG ATC 200 XD ATC 250 RD	83 83-84 85-86 83 83-84
MD6060D	Front	Solid	156	N/A	Plain	N/A			ATC 250 RB/RC	81-82
MD6064D	Rear	Solid	220	N/A	Plain	N/A			TRX 300 EX P/R/S/T/V/W/X/Y/1-8 TRX 300 X9	93-08 09
MD6065D									USE MD6039	
MD6066D	Front	Solid	245	N/A	Plain	N/A			YAMAHA WR 200 D/E/F DT 200 WR DT 230 Lanza (LTP1/2) TT 250 R (4GY1 Japan) TT 250 R (4RR1/2 Japan) TT 250 RL (4PX5) TT 250 RM (4PX6) TT 250 R (4GY3/4GY5/4WA1) Raid	92-94 92-93 97-98 93-94 95-96 99 00 94-96
MD6067D	Front	Solid	220	N/A	Plain	N/A			DT 125 LC TW 125 (5EK/5RS) XYZ 125 (5RM) YZ 125/250 S/T DT 200 (2LR) TW 200 (2JL/4CS1/2/3/5) TW 200 E (4CS4/6/5LB1/2) ST 225 (5BT) Bronco TW 225 E (5VC1/2) XT 225 Serrow (4JG) MK1-2 XT 225 WE (4JG5/6) Serrow XT 225 (2LN) Serrow (1KH 020101-) XT 225 (3RW1-5 Serrow) (1KH 034101-13200) XT 225 XT 225 S (3RW3) (1KH 102101-109000) XG 250 Tricker (5TX1) YZ 490 N/S/T	86-87 99-04 03-10 86-87 87 91-98 98-01 97 02-03 97-98 86-87 89-93 97-06 92 04-06 85-87
MD6068D	Front	Solid	245	N/A	Plain	N/A			XT 250 Serrow (3C51/2) XT 350	05-08 85-95
MD6070D	Front	Solid	267	N/A	Plain	N/A			XT 600 XT 600 Z Tenere XT 600 E	84-87 84-90 92-94
MD6072D	Rear	Solid	220	N/A	Plain	N/A			XT 600 XT 600/600 Z Tenere XT 600 E XT 660 'Tenere'	87 88-90 92-03 91-98
MD6073D	Front	Solid	230	N/A	Plain	N/A			SUZUKI DF 125 DR 125 SF/SH/SJ DR 125 SEX/SEY TS 125 XUF/XUG/XUH/XUJ DF 200 EV/EW/EY (SH42A)	85-94 99-01 86-90

OFF ROAD DISC BUYERS GUIDE

Disc No.	F/R	Type	Dia. (mm)	Hub Color	Profile	Bobbins	Left Bracket	Right Bracket	Model	Year
MD6073D Contd.	Front	Solid	230	N/A	Plain	N/A			SUZUKI Contd. DR 200 G/H/J DR 200 SEP/SER/SES/SEV/SEW/SEX/SEY (SH42A) Djebel DR 200 SE Trojan DR 200 SEK1-SEK9	86-89 93-00 96-13 01-09
MD6075D	Front	Solid	240	N/A	Plain	N/A			TS 250 XE/XG/XH/XJ/XK DR 600 RG/RH/RJ (SN41A) DR 600 RK DR 600 SF/SG/SH/SJ/SK (SN41A)	85-89 86-88 89 85-89
MD6076D	Front	Solid	280	N/A	Plain	N/A			DR 650 RL/RM DR 650 RSL/RSM (SP42A)	90-91 90-91
MD6076D Contd.	Front	Solid	280	N/A	Plain	N/A			DR 750 SJ/SK DR 800 SL	88-89 90
MD6077D	Rear	Solid	250	N/A	Plain	N/A			DR 600 RK (SN41A) DR 650 RL/RM DR 650 RSL/RSM (SP42A) DR 650 RUN/RN/RUP/RP (SP44A/B) DR 650 RER/RES (SP45A/B) DR 650 RSEM/RSEN/RSEP (SP43A/B) DR 750 SK DR 800 SM/SN/SP/SR/SS (SR43B) DR 800 ST/SV (SR43B)	89 90-91 90-91 92-93 94-95 91-93 89 90-95 96-97
MD6078D	Front	Solid	300	N/A	Plain	N/A			DR 650 RUN/RN/RUP/RP (SP44A/B) DR 650 RER/RES (SP45A/B) DR 650 RSEM/RSEN/RSEP (SP43A/B)	92-93 94-95 91-93
MD6080D	Front	Solid	250	N/A	Plain	N/A			KAWASAKI KLR 600 A1/A3 B1-B4/B6-B9	84-94
MD6081D	Front	Solid	280	N/A	Plain	N/A			KL 650 B1-B3 'Tengai' KLR 650 C1-C10	89-92 95-04
MD6082D MD6082CX	Rear Rear	Solid Solid	230 230	N/A N/A	Plain Contour	N/A N/A			KLE 500 A1-A12/B1 KLE 500 B1P/B6F/B7F KL 650 B1-B3 'Tengai' KLR 650 A1-A3 KLR 650 C1-C10	91-05 05-07 89-92 87-89 95-04
MD6083D MD6083CX MD6083D MD6083CX	Front Front	Solid Solid	250 250	N/A N/A	Plain Contour	N/A N/A			KDX 125 A1/A2/B1/B2 KDX 200 H1/H2/H3/H4/H5 KDX 220 R A4-A12/A6F KDX 220 SR (DX220B) KDX 250 SR KDX 250 D1	90-94 95-99 97-06 91 91-93
MD6084D									USE MD6105D	
MD6085D	Rear	Solid	230	N/A	Plain	N/A			KLX 250 R D1-D2 KLX 250 G1 KLX 650 C1-C3	93-94 94- 93-97
MD6086D	Front	Floating	290	Gold	Plain	9			KLX 650 C1-C3	93-97
MD6087D	Front	Floating	240		Plain	9			HONDA CR 125 RE/RF/RG/RH/RJ MTX 125 RWE/RWF/RWH/RWL Sael 125 XL 125 RF/RH MTX 200 RWF CR 250 RE/RF/RG/RH/RJ CRM 250 R (RK) MK1 MD24 (10001-1008385) XR 250 RG/RH/RJ/RK/RL XLR 250 R XR 350 RE CR 500 RE/RF/RG/RH/RJ XR 500 RD/RE XL 600 RD/LD/RE/LE/RF/RG/RH XL 600 LMF XR 600 RF/RG/RH/RJ/RK/RL	84-88 85-95 85-86 85 84-88 89-90 86-90 88-90 84 84-88 84-85 83-87 85-90
MD6088D									USE MD6008D	
MD6089D									USE MD6083D	

OFF ROAD DISC BUYERS GUIDE

Disc No.	F/R	Type	Dia. (mm)	Hub Color	Profile	Bobbins	Left Bracket	Right Bracket	Model	Year
MD6090D									USE MD6105D	
MD6091D	Front	Solid	250	N/A	Plain	N/A			KAWASAKI KLX 250 G1	94
MD6092D									USE MD6085D	
MD6093D	Front	Solid	300	N/A	Plain	N/A			KLE 500 A1-A12/B1 KLE 500 B6F/B7F	91-05 05-07
MD6094D MD6094CX SMX6094 MD6095D MD6095CX	Front Front Front Rear Rear	Solid Solid Floating Solid Solid	290 290 320 240 240	N/A N/A Black N/A N/A	Plain Contour Contour Plain Contour	N/A N/A 6 N/A N/A	BRK003		SUZUKI DR 650 SET/SEV DR 650 SET/SEV XF 650 V/W/X/Y Freewind	96-21 96-21 97-02
MD6096D	Front	Solid	255	N/A	Plain	N/A			XL 600 LMF/RMG/LMH	85-87
MD6097D	Rear	Solid	240	N/A	Plain	N/A			XL 600 VM/VN/VP/VR/VT/VW/VV/WX Transalp XL 650 VY/V1-V7 Transalp XRV 650 J/K Africa Twin	91-99 00-07 88-89
MD6098D									USE MD6013D	
MD6099D	Rear	Solid	220	N/A	Plain	N/A			NX 500 N/P/R/S/T/V/W/X NX 650 N/P/R/S/T/V/W/X Dominator FMX 650 FX 650 X/Y "Vigor"	92-99 92-02 05-08 99-03
MD6100D									USE MD6010D	
MD6101D									USE MD6099D	
MD6102	Front	Solid	276	N/A	Plain	N/A			XRV 750 L/M/N/P/R/S/T/V/W/X/Y	90-03
MD6103D	Rear	Solid	256	N/A	Plain	N/A			XRV 750 L/M/N/P/R/S/T/V/W/X/Y XL 1000 VV/VY/V1/V2 Varadero - Non ABS Model	90-03 99-02
MD6104D									USE MD6083D	
MD6105D MD6105CX	Rear Rear	Solid Solid	220 220	N/A N/A	Plain Contour	N/A N/A			KAWASAKI KDX 125 A1/A2/B1/B2 KDX 200 H1/H2/H3/H4/H5 KDX 200 SR (DX 200 G) KDX 220 SR (DX 220 B) KDX 220 R A4-A12/A6F KDX 250 D1 KDX 250 SR (KDX 250 F1) KLX 250 J1-J6 D-Tracker KLX 250 H6/H7F KLX 300 A2-10/A6F/A7F	90-94 95-99 97-06 91-93 91 98-03 05-07 97-07
MD6106D	Front	Solid	230	N/A	Plain	N/A			KMX 125 A1-A5/B1-B12	86-03
MD6107D	Rear	Solid	210	N/A	Plain	N/A			KMX 125 A1-A5/B1-B12 KJ 250 J1-J3 KLX 250 G1/G1A/H1 Super Sherpa	86-03 00-02 97-00
MD6108D MD6109D	Rear Front	Solid Solid	210 240	N/A N/A	Plain Plain	N/A N/A			KMX 200 A2-A3 SUZUKI TS 125 RK/RL/RM/RN/RR/RR TS 200 RK/RL/RM/RN/RR/RR	89-92 90-96 89-94
MD6110D MD6110CX	Rear Rear	Solid Solid	220 220	N/A N/A	Plain Contour	N/A N/A			DR 250 RS/RLS/RT/RLV/RLW/RV/RW/RV (SJ45A/DOHC) DR 250 RXT/RXLT/RXV/RXLW/RXW/RXLW/RXGW/ RXGLW/RXY/RXGY (Djebel 250 XC/GPS SJ45A) DR-Z 250 K1-K7 (DJ43A) DR 350 SET/SEV (Electric start/4 bolt front disc) DR 350 SEW/SEX (Electric start/6 bolt front disc)	95-00 96-98 01-07 96-97 98-99
MD6111D									USE MD6094D	
MD6112D									USE MD6095D	
MD6113D	Front	Floating	300	Gold	Plain	6			XF 650 V/W/X/Y Freewind DR 800 SM/SN/SP/SR/SS (SR43B) DR 800 ST/SV (SR43B)	97-02 91-95 96-97

OFF ROAD DISC BUYERS GUIDE

Disc No.	F/R	Type	Dia. (mm)	Hub Color	Profile	Bobbins	Left Bracket	Right Bracket	Model	Year
MD6114D									USE MD6039	
MD6115D	Rear	Solid	220	N/A	Plain	N/A			DT 125 R/RE TDR 125	88-04 93-03
MD6116D	Front	Solid	280	N/A	Plain	N/A			TDR 125 XT 600 E XTZ 660 Tenere	93-03 95-03 91-98
MD6117D									USE MD6116D	
MD6118D	Front	Solid	245	N/A	Plain	N/A			XTZ 750 Super Tenere	89-95
MD6119D	Rear	Solid	245	N/A	Plain	N/A			XTZ 750 Super Tenere	89-95
MD6120D									USE MD6066D	
MD6121D MD6121C	Rear Rear	Solid Solid	220 220	N/A N/A	Plain Contour	N/A N/A			YAMAHA DT 125 RE DT 125 X WR 125 R WR 125 X (Supermoto) DT 200 WR WR 200 D/E/F DT 230 Lanza 4TP1/2 TT 250 R (4GY1 Japan) TT 250 R (4RR1/2 Japan) TT 250 RL (4PX5) TT 250 RM (4PX6) TT 250 R (4GY3/4GY5/4WA1) Raid	05-07 05-06 09-15 09-18 92-93 92-94 97-98 93-94 95-96 99 00 94-96
MD6123D	Front Front	Solid Solid	180 180	N/A N/A	Plain Plain	N/A N/A			YAMAHA YFM 350 FXG/FXH/FXJ/FXK/FXL/FXM/FXN/FX/FXRP/ FXS Wolverine YFM 400 FAM YFM 400 FWP/FPR/FPS Big Bear 4x4	96-04 00 02-04
MD6124D MD6124C MD6124CX	Rear Rear Rear	Solid Solid Solid	240 240 240	N/A N/A N/A	Plain Contour Contour	N/A N/A N/A			HONDA CR 125 RW/RX/RV/R1 CR 250 RV/RW/RX/RV/R1 LEXMOTO LSM 50 (STR50) Adrenaline 125 XFLM125GY-2B LSM 125 (STR125YB)	98-01 97-01 12-16 13-18 12-18
MD6125D OSX6125 SMX6125	Front Front Front	Solid Floating Floating	260 280 320	N/A Silver Black	Plain Contour Contour	N/A 6 6		BRK007	HUSABERG All Models HUSQVARNA CR 125 SM 125 WR 125 WRE 125 CR 250 WR 250 TE 350 CR 360 WR 360 TE 410 TE 610 TE 610/E TE 610 TE 610 E TE 610 E TC 610/E	93-99 92-94 98-99 93-94 93-99 92-99 92-99 92-97 92-94 92-99 95-99 92-94 92-99 95-99 00 00 03-04 95-99
MD6126D	Front	Solid	220	N/A	Plain	N/A			HUSQVARNA CR 125 WR 125 TC 610	95-99 95-99 92-94
MD6126D	Rear	Solid	220	N/A	Plain	N/A			HUSABERG All Models CR 125 SM 125 WR 125 WRE 125 WR 240	93-99 91-99 98-99 91/93-99 93-99 90-91

OFF ROAD DISC BUYERS GUIDE

Disc No.	F/R	Type	Dia. (mm)	Hub Color	Profile	Bobbins	Left Bracket	Right Bracket	Model	Year
MD6126D Contd.	Rear	Solid	220	N/A	Plain	N/A			HUSABERG Contd. CR 250 WR 250 WR 260 TE 350 CR 360 WR 360 TE 410 TE 410 E TE 510 TC 510 LT 610 SM 610 SM 610 R TE 610 TE 610/E TC 610 TC 610/E	91-99 90-99 90-91 90-97 92-94 92-99 95-99 00 90 90 00 98-00 00 91-94 95-00 91-94 95-99
MD6127D									USE MD6095D	
MD6128D	Rear	Solid	220	N/A	Plain	N/A			APRILIA Pegaso 650	91-00
MD6129D	Front	Solid	300	N/A	Plain	N/A			Pegaso 650/650 ie Pegaso 650 Trail	91-04 06-08
MD6130D MD6130CF MD6130DF MD6130CX	Front Front Front Front	Solid Floating Floating Solid	300 300 300 300	N/A Silver Silver N/A	Plain Contour Plain Contour	N/A 9 9 N/A			KTM EGS 400/EGS-E/LSE (LC4 Enduro) LC4-E 400 Enduro 450 Rally EGS/EGS-E/LSE 620 Enduro LC-E 640 Enduro	96-99 00-01 17-21 96-99 00-04
MD6131D	Front	Solid	200	N/A	Plain	N/A			KAWASAKI KLF 300 C1-C17 KVF 300 A1-A4/B1-B4 (Prairie 4x4) KLF 400 B1-B7 KVF 400 A1/A2/B1/C1-C4/D1-D4	89-05 99-02 93-99 97-02
MD6132D	Rear	Solid	220	N/A	Plain	N/A			KSF 250 A1-A18 KEF 300 B1/B2/B3	87-04 01-03
MD6133D	Front	Solid	170	N/A	Plain	N/A			KSF 250 A1-A18 KXF 250 A1/A2 KEF 300 B1/B2/B3 KLF 300 B1-B17 'Bayou'	87-04 87-88 01-03 88-04
MD6134D	Rear	Solid	220	N/A	Plain	N/A			KXT 250 B2 (Tecate - 3 wheel)	87
MD6135D MD6135C MD6135CX	Rear Rear Rear	Solid Solid Solid	240 240 240	N/A N/A N/A	Plain Contour Contour	N/A N/A N/A			YAMAHA YZ 125 N (2T) YZ 125 2T YZ 125 Monster Energy 2T WR 250 ZK (5EN1) WR 250 FN/FP (4T) YZ 250 N (2T) YZ 250 2T YZ 250 Monster Energy 2T YZ 250 FN (4T) YZ 400 FL WR 400 FL/FM/FN WR 426 FN (4T) YZ 426 FN (4T) YZ-F 450	01 21-22 22 98 01-02 01 21-22 22 01 99 99-01 01 01 19-21
MD6136D	Rear	Solid	230	N/A	Plain	N/A			KAWASAKI KXF 250 A1/A2	87-88
MD6137D	Front	Solid	163	N/A	Plain	N/A			KFX 450 R (KSF 450 B8F/B9F/BAF/BBF/BCS/BFD/BEF)	08-14
MD6138D	F/R	Solid	206	N/A	Plain	N/A			KXT 250 B1 (Tecate - 3 wheel) KXT 250 B2 (Tecate - 3 wheel)	86 87
MD6140D	Front	Solid	220	N/A	Plain	N/A			YAMAHA YFM 600 FWAK/FWAL/FWAM/FWAN 'Grizzly' YFM 600HM "Grizzly Hunting"	98-00 00

OFF ROAD DISC BUYERS GUIDE

Disc No.	F/R	Type	Dia. (mm)	Hub Color	Profile	Bobbins	Left Bracket	Right Bracket	Model	Year
MD6141D	Front	Solid	260	N/A	Plain	N/A			HUSABERG	
MD6142D	Rear	Solid	220	N/A	Plain	N/A			HUSABERG	
MD6144D Billet	Rear	Solid	256	N/A	Plain	N/A			HONDA FL 400 R Pilot RK/RL	89-90
MD6145D	Front	Solid	206	N/A	Plain	N/A			SUZUKI LT-F 500 FW/FX/FY/FK1/FK2	98-02
MD6147D	Front	Solid	165	N/A	Plain	N/A			POLARIS Big Boss 250 4x6 Trail Boss Trail Boss 4x4 Trail Boss 2x4/4x4 Trail Blazer	89-90 88-90 87 88-89 90
MD6148D									USE MD6214D	
MD6149D	Front	Solid	228	N/A	Plain	N/A			POLARIS Big Boss 250 4x6 Middle Axle Big Boss 250 6x6 Big Boss 350 L Big Boss 300 6x6 Middle Axle Big Boss 400 L 6x6 Big Boss 500 6x6 350 L 4x4 250 2x4/4x4 400 L 4x4 Magnum 330 (2x4/HDS) Magnum 425 4x4 Magnum 425 6x6 Magnum 500 4x4 Magnum 500 Magnum 500 (2x4/4x4 HDS) Sportsman 350 4x4 Sportsman 400 L 4x4 Sportsman 400 Sportsman 500 4x4 500 Sportsman HO/EFI Demand Drive Sportsman/Worker 500 4x4 EBS/500 RSE Sportsman/Worker 335 4x4 Sportsman 6x6 (500) Big Boss Trail Boss 350 L 4x4 Xpedition 425 (4x4) Xplorer 400 L 4x4 Xplorer 500 4x4 Xplorer 400 Diesel 455cc 4x4 EBS Diesel Ranger PPS LUH 6x6	89-92 91-92 93 94 94-97 98-99 90 90 94 03-04 95-98 96-97 99-00 01 02 93 94-97 01-04 96- 03-04 98-02 99-00 00-01 91 00 95-00 97 01-02 99-00 01 99 02
MD6150D	Front	Solid	175	N/A	Plain	N/A			POLARIS Big Boss 250 4x6 Big Boss 250 6x6 Big Boss 300 6x6 350 L 2x4 250 2x4/4x4 350 L 4x4 300 2x4/4x4 400 L 2x4 Magnum 425 2x4 Scrambler 400 L 4x4 Scrambler 500 4x4 Sport 400 L Sport 400 Sportsman 335 4x4 Trail Boss 250 Trail Boss 250 2x4/4x4 Trail Boss 350 L 2x4 Trail Blazer Trail Blazer 250 Xpedition 300/400 L Xpress 300 2x4 Xplorer 300 4x4	91-92 92-93 94 90 93 93 94-95 94-95 95-98 95-97 97 94-98 99-00 99-00 91-99 91-92 91-93 91-93 94-98 96-97 98-00 96-00

OFF ROAD DISC BUYERS GUIDE

Disc No.	F/R	Type	Dia. (mm)	Hub Color	Profile	Bobbins	Left Bracket	Right Bracket	Model	Year
MD6153D	Front	Solid	254	N/A	Plain	N/A			POLARIS Big Boss 400 L 6x6 Middle Axle Magnum 425 6x6 Middle Axle	96 96
MD6154D	Rear	Solid	150	N/A	Plain	N/A			POLARIS Sportsman 500	97
MD6155D	Front	Solid	182	N/A	Plain	N/A			POLARIS Magnum 325 4x4/2x4 Magnum 325 2X4/4X4 Moose Magnum 325 (2x4) HDS Magnum 325 4x4 Scrambler 400 (2x4/4x4) Scrambler 400 4x4/2x4 Scrambler 500 4x4 Scrambler 500 2x4/4x4 Trail Boss 325 Trail Blazer 250 Trail Blazer 250 Freedom Xpedition 325 Xplorer 250 4x4 Xplorer 4x4 400	00 01 02 02 00 98-02 98-00 01-02 00-02 99-00 01-02 00/02 00 01-02
MD6156D	Rear	Solid	178	N/A	Plain	N/A			POLARIS Magnum 325 (4x4) (2x4) Magnum 325 2X4/4X4 Moose Magnum 500 4x4 Magnum 500 Scrambler 400 (2x4/4x4) Scrambler 400 4x4 Scrambler 400 2x4 Scrambler 500 4x4 Scrambler 500 2x4/4x4 Sport 400 Trail Boss 325 Trail Blazer 250 Trail Blazer 250 Freedom Trail Boss 330 Xpedition 425 4x4 Xpedition 325 Xplorer 4x4 400	00 01 99-00 01 00 98-02 02 98-00 01-02 99-00 00-02 99-00 01-02 03-04 00 00 01-02
MD6157D MD6157C MD6157CX	Rear Rear Rear	Solid Solid Solid	240 240 240	N/A N/A N/A	Plain Contour Contour	N/A N/A N/A			SUZUKI RM 125/250 X/Y/K1-K5 DR-Z 400 SMK5/K6/K7/K8/K9	99-05 05-22
MD6158D MD6158C	Front Front	Solid Solid	220 220	N/A N/A	Plain Contour	N/A N/A			YAMAHA DT 50 LC TT-R 125	98- 00-21
MD6159D									USE MD6149D	
MD6160D	Rear	Solid	220	N/A	Plain	N/A			CAGIVA Canyon 500 900 IE Canyon/Gran Canyon E 900 Elephant Navigator 1000	96-00 98-00 90-99 00-05
MD6161D	Rear	Solid	220	N/A	Plain	N/A			KAWASAKI KX 125 E/E2/F1 KX 250 D2 KX 250 E1/F1 KX 500 B2/C1/D1	86-88 86- 87-88 86-88
MD6162D									USE MD6014D	
MD6163D	Front	Solid	240	N/A	Plain	N/A			SUZUKI RM 125/250 F/G/H/J	85-88
MD6164D	Rear	Solid	220	N/A	Plain	N/A			TRX 400 EXX/EXY/EX1-EX8 TRX 400 X9	99-08 09
MD6165D	Rear	Solid	220	N/A	Plain	N/A			HONDA CRM 250-1 (RK) M1/MD24 (10001-1008385)	89-90

OFF ROAD DISC BUYERS GUIDE

Disc No.	F/R	Type	Dia. (mm)	Hub Color	Profile	Bobbins	Left Bracket	Right Bracket	Model	Year
MD6166D MD6166CX	F & R F & R	Solid Solid	180 180	N/A N/A	Plain Contour	N/A N/A			KAWASAKI KX 65 SUZUKI RM 65 K3/K4/K5	00-22 03-05
MD6168D	Front	Solid	296	N/A	Plain	N/A			HONDA XRV 650 J Africa Twin CAGIVA Canyon 500 Canyon 600 E 750 Elephant 900 IE Canyon/Gran Canyon E 900 ie Lucky Explorer E 900 ie GT Navigator 1000 Canyon 500 Canyon 600	88-89 96-00 96-99 93-95 98-00 90-92 91-92 00-05 96-00 96-99
MD6169D	Rear	Solid	203	N/A	Plain	N/A			POLARIS Sportsman 6x6 Xplorer 400 L (4x4)	02-04 99-02
MD6170D	Rear	Solid	228	N/A	Plain	N/A			POLARIS Sportsman 6x6 (500) PPS LUH 6x6	00-04 02
MD6171D	Front	Solid	166	N/A	Plain	N/A			BOMBARDIER DS 650 CAN AM DS 650 X	00-04 07
MD6172D	Rear	Solid	196	N/A	Plain	N/A			BOMBARDIER DS 650 CAN AM DS 650 X	00-04 07
MD6173D UTVX6173	F & R F & R	Solid Solid	202 202	N/A N/A	Plain Vee	N/A N/A			MASSEY FERGUSON MF 250/300/400/500/650/700 (2WD/4WD) ARCTIC CAT Most models see application file KYMCO MXU 400 (A40000) Maxxer 450 i MXU 450i IRS MXU 500i (4x4 -IRS) MXU 550i (4x4 LoF) MXU 700i (4x4 Turf) LAVERDA Quasar 4x4 400 Quasar 4x4 500 C Quasar 4x4 500 PIAGGIO Trackmaster 400 Quad	04-09 98-14 08-11 10-18 11-12 09-15 13-20 13-21 04 04 04 06
MD6174D	Rear	Solid	220	N/A	Plain	N/A			YAMAHA YFM 400 FAM/FAN YFM 450 FAR/FAS YFM 450 FXV/FXW/FXX/FXY/FXZ Wolverine	00-01 03-04 06-10
MD6175D	Front	Solid	218	N/A	Plain	N/A			DERBI Senda-R	96-99
MD6176D									N/A	
MD6180D	Front	Solid	260	N/A	Plain	N/A			APRILIA Tuareg Wind 600	89
MD6181D MD6181C MD6181CX	Rear Rear Rear	Solid Solid Solid	240 240 240	N/A N/A N/A	Plain Contour Contour	N/A N/A N/A			HONDA-DALL'ARA XR 650 RY/R1-R7 XR 650 R	00-07 04
MD6182D	Front	Solid	267	N/A	Plain	N/A			YAMAHA TT 600 E (4LW3/4LW4/4GV4/4GV5) TT 600 E (4GV2) TT 600 K (4LW1/4GV1/4LW2) TT 600 R (5CH1/5CH2/5CH3) TT 600 RE (5CH5)	94-01 94-95 93-96 97-02 04

OFF ROAD DISC BUYERS GUIDE

Disc No.	F/R	Type	Dia. (mm)	Hub Color	Profile	Bobbins	Left Bracket	Right Bracket	Model	Year
MD6183D	Rear	Solid	220	N/A	Plain	N/A			TT 600 E (4LW3/4LW4/4GV4/4GV5) TT 600 E (4GV2) TT 600 K (4LW1/4GV1/4LW2) TT 600 R (5CH1/5CH2/5CH3) TT 600 RE (5CH5)	94-01 94-95 93-96 97-02 04
MD6184D MD6184C OSX6184 OSX6184K OSX6184K9 SMX6184K SMX6184H SMX6184K9	Front Front Front Front Front Front Front Front	Solid Solid Floating Floating Floating Floating Floating Floating	260 260 280 280 280 320 320 320	N/A N/A Silver Silver Silver Black Black Black	Plain Contour Contour Contour Contour Contour Contour Contour	N/A N/A 6 6 6 6 6 6			HUSQVARNA CR 125 SM 125 SM 125 S SMR 125 (4T) SMS 4-125cc (4T) TE 125 (4T) WR 125 WRE 125 WXE 125 CR 250 (4T) TC 250 TE 250 (4T) TE 250 Meo Replica (4T) TE 250 R (4T) WR 250 WR 300 (2T) TE 310 (4T) TE 310 R (4T) TZ 310 (4T) WR 360 TE 400 TE 410 TE 410 E SMR 449 TC 449 (4T) TE 449 (4T) TC 450 TE 450 TC 510 TE 510 TE 511 (4T) TC 570 TE 570 TC 610 TE 610/E TE 630 SWM RS 125 R FT 300 R (RS 300 R FLAT TRACK) RS 300 R (4T) RS 500 R (4T)	00-13 00 02-13 11-13 11 11-13 00-13 00/02-13 07 00-05 02-03/05-13 02-13 11 13 00-13 09-13 10-13 13 09-12 00-02 02 00/06 00 11 11-13 11-13 03-07 03-07 04-07 04-07 11-13 02-03 01-04 00 06-09 10-11 16-17 17 15-18 15-18
MD6186D MD6186C MD6186CX OSX6186	Front Front Front Front	Solid Solid Solid Floating	220 220 220 280	N/A N/A N/A Silver	Plain Contour Contour Contour	N/A N/A N/A 6		BRK025	KAWASAKI KX 85 I (17" Front/14" Rear Wheel) KX 85 II (19" Front/16" Rear Wheel) SUZUKI RM 100 K3	01-21 01-21 03
MD6187D MD6187C MD6187CX	Rear Rear Rear	Solid Solid Solid	185 185 185	N/A N/A N/A	Plain Contour Contour	N/A N/A N/A			KAWASAKI KX 85 I (17" Front/14" Rear Wheel) KX 85 II (19" Front/16" Rear Wheel) SUZUKI RM 100 K3	01-21 01-21 03
MD6188D UTVX6188	Front Front	Solid Solid	200 200	N/A N/A	Plain Vee	N/A N/A			KAWASAKI KVF 360 A1-A3/A6F/A7F/A8F/A9F/AAF/ABF/ACF/ADF KVF 360 B1-B3/B6F/B7F/B8F/B9F KVF 360 C1-C3/C6F/C7F/C8F Prairie All Models KVF 650 A1/A2 KVF 650 D1/D6F/D7F/D8F/D9F/DAF/DBF Brute Force 4x4 KVF 650 E1/E6F/E7F/E8F/E9F Brute Force 4x4 Hardwoods Green HD KVF 650 FCF/FCS/FDF/FEF KVF 650 F7F/F8F/H7F/H8F/G7F/G8F KVF 700 A1/B1/B6F/B7F/A2/B2/A6F/A7F/A8F 4x4 (Prairie) KVF 700 D1 Team Green KVF 750 D8F/D9F/DAF/DBF KVF 750 E8FA KVF 750 GCF/GDF/GEF/GFF/GGF/GHF Brute Force 4X4i EPS	03-13 03-09 03-08 02-03 05-11 05-09 12-14 07-08 04-08 05 08-11 08 12-17

DISC BUYERS GUIDE

OFF ROAD DISC BUYERS GUIDE

Disc No.	F/R	Type	Dia. (mm)	Hub Color	Profile	Bobbins	Left Bracket	Right Bracket	Model	Year
MD6188D UTVX6188 Contd.	Front Front	Solid Solid	200 200	N/A N/A	Plain Vee	N/A N/A			KVF 750 HCF/HDF/HEF/HFF/HGF/HHF Brute Force 4X4i EPS/Camo KVF 750 JCF/JDF/JEF/JFF/JGF/JHF Brute Force 4x4i EPS KVF 750 LCF/LDF/LEF/LFF/LGF/LHF Brute Force 4x4i	12-17 12-17 12-17
MD6189D	Front	Solid	220	N/A	Plain	N/A			YFM 660 FWAP/FWAR/FWAS/FWAT/FWAV/FGW/FGX Grizzly YFM 660 FR/FS/FT Grizzly	02-08 03-05
MD6190D MD6190C MD6190CE MD6190CX	Rear Rear Rear Rear	Solid Solid Solid Solid	245 245 245 245	N/A N/A N/A N/A	Plain Contour Contour Contour	N/A N/A N/A N/A			YAMAHA YZ 125 (2T) YZ 125 X 2T WR 250 F 4T WR-F 250 (4T/Reverse Cylinder) YZ 250 X 2T YZ 250 F 4T YZ-F 250 (270mm Disc) YZ 250 FGY (60th Anniversary Edition/270mm Disc) WR 426 FP (4T) YZ 426 FP (4T) WR 450 F 4T WR-F 450 (270mm F/Disc/4T) YZ 450 F 4T YZ-F 450 (270mm Disc) YZ 450 F 60th Anniversary Edition 270 F/Disc	02-21 21-22 03-13 15-21 17-22 02-15 16-21 16 02 02 03-15 16-21 03-15 16-21 16
MD6191D MD6191C MD6191CE MD6191CX	Rear Rear Rear Rear	Solid Solid Solid Solid	240 240 240 240	N/A N/A N/A N/A	Plain Contour Contour Contour	N/A N/A N/A N/A			HONDA CR 125 R2/R3/R4/R5/R6/R7 CR 250 R2/R3/R4/R5/R6/R7/R8/R9 CRE F 250 R CRE F 250 X CRF 250 R4-R9/RA/RB/RC/RD/RE/RF/RG CRF 250 R CRF 250 RE (Limited Road Use) CRF 250 R AC (260mm F/Disc) CRF 250 X CRF 250 RX CRF 250 XRL (Road legal) CRE F 300 X CRF 450 R AC CRF 450 R-S CRF 450 R CRF 450 RE (Limited Road Use) CRF 450 R inc RWE (260mm F/Disc) CRF 450 X CRF 450 XRL (Road Legal) CRF 450 RX (18" Rear Wheel) CRE F 500 X	02-07 02-09 08-09 08-11 04-16 08-09 16 15-21 04-20 08-20 14-20 08-09 02-22 22 04-09 16 15-22 05-22 14-16 17-22 08-09
MD6192D MD6192C	Front Front	Solid Solid	198 198	N/A N/A	Plain Contour	N/A N/A			KTM 60 SX 65 SX 65 SX	98-00 98-99 00-03
MD6195D	Front	Solid	190	N/A	Plain	N/A			SUZUKI LT-A 400 FK2/K2/FK3/K3/K4/FK4/FK5/FK6/FK7/FK8 Eiger 4WD LT-A 400 FK8/FK9/FL0/FL1 King Quad Auto 4WD LT-F 400 FK2/FK3/FK4/FK5/FK6/FK7 Eiger LT-F 400 FK8/FK9/FL0/FL1 LT-F 400 K2/K3/K4/K5/K6/K7 LT-A 500 FK2/FK3/FK4/FK5/FK6/FK7 Vinson 4WD LT-F 500 FK3/FK4/FK5/FK6/FK7 KYMC0 MXU 500 (L70000/Carb Model) MXU 500 4x4/Carb Model	02-09 08-12 02-10 08-12 02-07 02-07 03-07 05-09 05-13
MD6196D MD6197D Billet	Rear Rear	Solid Solid	216 150	N/A N/A	Plain Plain	N/A N/A			SUZUKI LT-A 500 FK2/FK3/FK4/FK5/FK6/FK7 Vinson 4WD LT-F 500 FK3/FK4/FK5/FK6/FK7 YAMAHA YFM 660 FWAP/FWAR/FWAS/FWAT/FWAV/FGW/FGX Grizzly YFM 660 FR/FS/FT Grizzly	02-07 03-07 02-08 03-05
MD6198D	Rear	Solid	220	N/A	Plain	N/A			HONDA AX-1 (NX 250 J/K/R/R3)	89-94

OFF ROAD DISC BUYERS GUIDE

Disc No.	F/R	Type	Dia. (mm)	Hub Color	Profile	Bobbins	Left Bracket	Right Bracket	Model	Year
MD6199D MD6199C	Front Front	Floating Floating	320 320	Gold Gold	Plain Contour	9 9			KTM Duke 400 LC4 Duke 620 LC4 LC4 620 SC Supermoto LC4 625 SC Supermoto SMC 625 Duke II 640 Duke-E 640 (Single pin pad fixing/zero offset disc) Duke II 640 (2 pin pad fixing/zero offset disc) LC4-E 640 Supermoto LC4-E 640 (Central single pin fixing) LC4-E 640 (2 pin fixing) LC4 640 Adventure R LC4 640 Adventure 690 SM 690 SMC 690 SM-LE (Limited Edition) 690 SMC-R	94-98 00 02 04-06 01-06 98 99-02 00-06 03 04-06 99-02 03 07-09 08-11 10-11 12-13
MD6200D	Rear	Solid	206	N/A	Plain	N/A			POLARIS Magnum 325 2x4 HDS Magnum 325 4x4 Magnum 325 4x4 HDS Magnum 330 (4x4/HDS) Magnum 500 (2x4/4x4 HDS) Xpedition 325 PPS/PTV 4x4/Series 10 PPS/PTV 6x6/Series 10	02 02 02 03-04 02-03 02
MD6201D	Rear	Solid	218	N/A	Plain	N/A			400 Sportsman Sportsman 500 X2 Sportsman 600 (4x4) Sportsman 700 4x4 Sportsman MV 700 Sportsman 800 PPS/Series 10 UTV 2x4/4x6 PPS/Series II UTV 1500 2x4 PPS/Series 11 2x4/4x4/6x6 Ranger 6x6 Ranger TM Ranger XP Ranger 2x4/4x4 Ranger Series 10 Ranger Series 10 500 6x6 Ranger Series 11	03-04 06 03-04 02-04 05 05 04-05 04-05 05 04-06
MD6202D UTVX6202	Front Front	Solid Solid	228 228	N/A N/A	Plain Vee	N/A N/A			POLARIS 325 Hawkeye 2x4 Magnum 325 4x4 HDS 325 Sportsman Ace 325 Sportsman Ace Efi 325 Sportsman Ace Euro 325 Sportsman Ace HD ATP 330 (4x4) Magnum 330 (4x4/HDS) 330 Trail Boss 330 Trail Blazer 400 Hawkeye H.O. (2x4) 400 Ranger 400 Sportsman (Code A04CH42 AQ/AR/AS/AT/AV) 400 Sportsman HO 4x4 ATP 500 HO (4x4) Magnum 500 HDS 500 Scrambler 4x4 Sportsman 500 HO 500 Sportsman HO 500 Sportsman HO 500 Sportsman Touring HO 500 Sportsman Forest 570 Sportsman Ace 570 Sportsman Ace Euro 570 Sportsman Efi (inc EPS) 570 Sportsman Touring Efi 570 Sportsman Touring Tractor Efi 570 Sportsman 6X6 Inc Tractor Efi 570 Ranger Crew	15 02 14 15 14-15 15 04 03-04 10-13 10-13 13-14 10-14 04 11-14 04 02-03 10-11 04-06 Up to 15/12/08 After 16/12/08 11-13 12 15 15 11-21 14-21 16-21 17-21 14-15

DISC BUYERS GUIDE

OFF ROAD DISC BUYERS GUIDE

Disc No.	F/R	Type	Dia. (mm)	Hub Color	Profile	Bobbins	Left Bracket	Right Bracket	Model	Year
MD6202D UTVX6202 Contd.									POLARIS Contd. Sportsman 700 (4x4) Sportsman MV 700 Sportsman 800 800 Sportsman Big Boss/6/6/EFI 800 Sportsman HO/EFI 800 Sportsman HO/EFI 800 Sportsman EFI 800 Sportsman 850 Sportsman Touring H.O. EPS PPS/PTV 4x4/Series 10 PPS/Series 10 UTV 2x4/4x6 PPS/Series II UTV 1500 2x4 PPS/Series 11 2x4/4x4/6x6 Ranger 6x6 Ranger TM Ranger XP Ranger 2x4/4x4 Ranger 500 (2x4/4x4/4x4 EFI) 500 Ranger Crew 500 Ranger 4x4 EFI Ranger 6x6 EFI 700 Ranger XP 700 4x4 Ranger EV (Electric) Ranger ETX	02-04 05 05 09-14 Up to 15/12/08 After 16/12/08 10-13 12-14 13-14 04-05 04-06 05 04-06 06 11-13 11-13 06 06 10-14 15
MD6203D									USE MD6188D	
MD6206D	Front	Solid	168	N/A	Plain	N/A			LT-F 300 FK2	02
MD6207D	Front	Solid	160	N/A	Plain	N/A			LT-F 250 K2-K9/L2/L3/L4 Ozark	02-14
MD6208D MD6208C MD6208CE MD6208CX	Rear Rear Rear Rear	Solid Solid Solid Solid	240 240 240 240	N/A N/A N/A N/A	Plain Contour Contour Contour	N/A N/A N/A N/A			KX 125 M1/M2/M3/M6F/M7F/M8F KX 250 F (KX 250 N1/N2) KX 250 M1/M2/R1/R6F/R7F/R8F KX 250 F (T6F/T7F/T8F) KX 250 F (KX 250 W9F/XAFB/YBF/YCF/ZDF/ZEF/ZFF/ ZGF) (4T) KX-F 250 KX-F 250 XC Enduro KX 450 F (D6F/D7F/D8F/E9F/EAF/EBF/FCF/FDF/FEF/ FFF/HGF/HHF/HJF) KX-F 450 XC Enduro KLX 450 R (A8F/A9F/AAF/ABF/ACF/ADF/AEF/AFF/AGF/ AHF/AJF) SUZUKI RM-Z 250 K4/K5/K6	03-08 04-05 03-08 06-08 09-16 15-22 21-22 06-18 21-22 08-18 04-06
MD6209D	Front	Floating	320	Gold	Plain	9			SM 125 (2T) 404 DS Supermoto SM 450 ER (4T) SM 515 FSR (4T) 604 E Supermoto 604 RS "Roadster" 644 DS Supermoto 644 DS R 30 (Spoke wheel)	03-06 03-04 07-08 07-08 99-03 00-03 04 04 02-04
MD6210D	Front	Solid	170	N/A	Plain	N/A			LT-Z 250 K4-K9/L0 Quadport LT-Z 400 K3-K9/L0/L1/L2/L3 KSF 400 A1/A2/A3 DVX 400 400 DVX (2x4) Sport	04-12 03-14 03-05 04-08 04-08
MD6211D	Rear	Solid	220	N/A	Plain	N/A			LT-Z 400 K3-K9/L0/L1/L2/L3 KSF 400 A1/A2/A3 DVX 400 400 DVX (2x4) Sport 400 DVX TS Sport	03-14 03-05 04-08 04-08 06-07
MD6212D	Front	Solid	220	N/A	Plain	N/A			DR-Z 125 LK3/LK4/LK5/LK6/LK7/LK8/LK9/LL0-LL9 KLX 125 L (B1/B2/B3/A6F)	03-21 03-06

OFF ROAD DISC BUYERS GUIDE

Disc No.	F/R	Type	Dia. (mm)	Hub Color	Profile	Bobbins	Left Bracket	Right Bracket	Model	Year
MD6213D	Front	Solid	250	N/A	Plain	N/A			KX 125 M1/M2/M3	03-04
MD6213C	Front	Solid	250	N/A	Plain	N/A			KX 250 N1/N2	04-05
MD6213CX	Front	Solid	250	N/A	Plain	N/A			KX 250 M1/M2/R1	03-05
OSX6213	Front	Floating	280	Silver	Plain	6			RM-Z 250 K4/K5/K6	04-06
SMX6213	Front	Floating	320	Black	Plain	6				
MD6214D	Front	Solid	230	N/A	Plain	N/A			DT 50 R-L MX 50 Pegaso 50 RX 3-5 Marce (M/N/P/R) RX 50 C/CD	97-03 03-05 92-94 91-94 95-04
MD6215D	Front	Solid	200	N/A	Plain	N/A			YFM 350 FAS/FAT/FAV Bruin 4x4 YFM 350 ANS/ANT Bruin 2x4 YFM 350 XV/XW/XX 2WD Wolverine IRS YFM 350 FWA Grizzly 4WD YFM 350 FGIW/FGIX/FGIY/FGIZ Grizzly 4WD IRS YFM 350 GW/GX/GY/GZ Grizzly 2WD YFM 400 FAR/FAS Kodiak Auto YFM 400 AR Kodiak (5VH3/4) YFM 400 FAT/FAV (Big Bear) YFM 450 FAR/FAS Kodiak (5ND3/4) YFM 450 FAT/FAHT/FAV (Kodiak) YFM 450 FXV/FXW/FXX/FXY/FXZ Wolverine YFM 450 FWAD Grizzly EPS (Power Steering) YFM 450 FWA Grizzly IRS	04-06 04-06 06-09 04-14 07-10 08-10 03-04 03 05-06 03-04 05-06 06-10 11-14 11-16
MD6216D	Rear	Solid	160	N/A	Plain	N/A			KTM 60/65 SX 65 SX	00-01 00-03
MD6217D Billet	Rear	Floating	170	Silver	Plain	N/A			HONDA TRX 420 FA9/FAA/FAB Fourtrax Auto 4WD TRX 420 FPAA/FPAA/FPAB Fourtrax Auto Power Steering TRX 650 FA3/FA4/FA5 Rincon 4x4 Auto TRX 680 FA6/FA7/FA8/FA9/FAA/FAB/FAC Rincon 4x4 Auto	09-11 09-11 03-05 06-21
MD6218D	Rear	Solid	196	N/A	Plain	N/A			Predator 500 POLARIS 525s Outlaw	03-04 08-10
MD6219D	Front	Solid	178	N/A	Plain	N/A			Predator 500 Phoenix 200 200 Phoenix (AA/AB Model/Rear drum model) 200 Phoenix Quadricycle Model (EA/EB/EC/ED Rear Disc Model)	03-04 05 05 05-09
MD6220D	Front	Solid	155	N/A	Plain	N/A			BOMBARDIER Rally 200 CAN AM Rally 200	03-06 07
MD6221D	Rear	Solid	155	N/A	Plain	N/A			BOMBARDIER Rally 200	03-04
MD6222D UTVX6222	Front Front	Solid Solid	205 205	N/A N/A	Plain Vee	N/A N/A			BOMBARDIER See main application pages for fitments CAN AM See main application pages for fitments	
MD6223D UTVX6223	Rear Rear	Solid Solid	180 180	N/A N/A	Plain Vee	N/A N/A			BOMBARDIER See main application pages for fitments CAN AM See main application pages for fitments	
MD6224D	F & R	Solid	203	N/A	Plain	N/A			BOMBARDIER Traxter Quest 500/650	01-04 02-04
MD6225D	F & R	Solid	218	N/A	Plain	N/A			BOMBARDIER Traxter Quest 500/650 Quest Max/XT/STD Traxter Max 650 Traxter Auto STD/XL Traxter Max STD/XT Traxter XL	01-04 02-04 04 04-05 04 04-05 04-05

OFF ROAD DISC BUYERS GUIDE

Disc No.	F/R	Type	Dia. (mm)	Hub Color	Profile	Bobbins	Left Bracket	Right Bracket	Model	Year
MD6225D Contd.	F & R	Solid	218	N/A	Plain	N/A			BOMBARDIER Traxter 5 Speed Traxter CVT (500/650/650 XT) Traxter Max CVT 650 Traxter XT JOHN DEERE ATV Trail Buck 500 Utility Trail Buck 650/650 EX/EXT Buck 500/500 EX/EXT	05 05 05 05 04-05 04-05 04-05
MD6226D GOLD	Front	Floating	320	Gold	Plain	9			YAMAHA XT 660 X Supermoto	04-16
MD6227D	Rear	Solid	220	N/A	Plain	N/A			KTM MX/MXC/GS 125 MX 125 EXC 125 MX/MXC 250 GS 250 MX 250 EXC/EGS 250 MX/MXC/GS 300 MX/MXC/GS 350 MX 350 EXC 350	86 86 88-89 88-89 86 86 88-89 88-89 86 86/88 89 89
MD6228D MD6229D	Front	Solid	205	N/A	Plain	N/A			Use MD6229D BOMBARDIER Traxter	99-04
MD6230D	Rear	Solid	220	N/A	Plain	N/A			BOMBARDIER Traxter	99-04
MD6231D									Use MD3088LS/RS	
MD6232D MD6232CX	Rear Rear	Solid Solid	260 260	N/A N/A	Plain Plain	N/A N/A			SUZUKI DL 650 XK7/XK8/XK9/XL0 V-Strom X DL 650 AK7/AK8/AK9/AL0 V-Strom ABS DL 650 AK9 GT V-Strom Traveller ABS DL 650 AL1XP V-Strom Xpedition DL 650 V-Strom ABS DL 650 XT V-Strom ABS DL 1000 K2-K9/L0 V-Strom DL 1000 V-Strom (ABS) DL 1000 XT V-Strom (ABS) DL 1050 V-Strom (ABS) DL 1050 V-Strom XT (ABS) DL 1050 V-Strom XT Tour (ABS) KAWASAKI KLV 1000 (LV 1000 A1H/A2H)	07-11 07-11 09-11 11 12-21 15-21 02-11 14-20 18-20 14-21 18-21 18-21 04-05
MD6233D	Rear	Solid	190	N/A	Plain	N/A			HONDA TRX 450 R4/R5/R6/ER6/R7/ER7/R8/ER8/R9/ER9	04-09
MD6234D	Rear	Solid	245	N/A	Plain	N/A			YAMAHA XT 660 X Supermoto XT 660 R XT 660 Z Tenere (Non ABS) XT 660 ZA Tenere (ABS)	04-16 04-16 08-16 11-16
MD6235D	Front	Floating	298	Gold	Plain	9			DT 125 X WR 125 X (Supermoto) XT 660 R XT 660 Z Tenere (Non ABS) XT 660 ZA Tenere (ABS)	04-06 09-18 04-15 08-16 11-16
MD6236D	Rear	Solid	200	N/A	Plain	N/A			YFM 250 RX/RV Raptor YFM 250 R (338) YFM 250 R (1BT) YFM 350 S/T/V/R-WV/RW/RX/RV/RZ Raptor YFZ 450 S/T YFM 700 RD/RE YFM 700 RSE	08-09 09-11 12-13 04-10 04-05 13-14 13-18
MD6237D	Rear	Solid	220	N/A	Plain	N/A			YFS 200 R/S/T/V YZF 350 U/B/D/E/F/G/H/J/K/L/M/N/P/R/S/T/V Banshee YFM 660 RN/RP/RR/RS/RT Raptor	03-06 88-09 01-05

OFF ROAD DISC BUYERS GUIDE

Disc No.	F/R	Type	Dia. (mm)	Hub Color	Profile	Bobbins	Left Bracket	Right Bracket	Model	Year
MD6238D									USE MD6215D	
MD6239D	Front	Solid	240	N/A	Plain	N/A			KAWASAKI KLX 250 G1/G1A/H1 Super Sherpa KL 250 J1-J3	97-00 00-02
MD6240D	Front	Solid	250	N/A	Plain	N/A			SUZUKI 250 SBK2 (LX 250 L)	02
MD6240C	Front	Solid	250	N/A	Contour	N/A			KAWASAKI KLX 250 J1-J6 D-Tracker	98-03
OSX6240	Front	Floating	280	N/A	Contour	N/A				
SMX6240	Front	Floating	320	N/A	Contour	N/A				
MD6241D	Front	Solid	200	N/A	Plain	N/A			YAMAHA YXR 66 FAS Rhino 4x4 Side x Side YXR 700 Rhino 4x4 SE YXR 700 FA/FB/FD Rhino Side x Side YXR 450 F Rhino 4WD Side x Side YXR 66 FAS Rhino 4x4 Side x Side	04 09 11-13 04-09 04
UTVX6241	Front	Solid	200	N/A	Vee	N/A				
MD6243D	Front	Solid	198	N/A	Plain	N/A			GAS GAS (Pierer Mob) MC 65 HUSQVARNA TC 65 KTM SX 65	21 19-22 04-22
MD6243C	Front	Solid	198	N/A	Contour	N/A				
MD6243CX	Front	Solid	198	N/A	Contour	N/A				
MD6244D	Rear	Solid	203	N/A	Plain	N/A			YAMAHA XT 225 WE (4JG5/6) Serrow XT 250 Tricker (5XT1) XT 250 Serrow (3C51/2) XTZ 250	97-98 04-06 05-08 07-08
MD6245D	Front	Solid	203	N/A	Plain	N/A			BOMBARDIER/BRP Quest Max/XT/STD Traxter Auto STD/XL Traxter Max STD/XT Traxter XL Traxter 5 Speed Traxter CVT (500/650/650 XT) Traxter Max CVT 650 Traxter XT JOHN DEERE ATV Trail Buck 500 Utility Trail Buck 650/650 EX/EXT Buck 500/500 EX/EXT	04 04 04-05 04-05 05 05 05 05 04-05 04-05 04-05
MD6246D	Rear	Solid	200	N/A	Plain	N/A			SUZUKI RM 85 Small Wheel - F 17"/R 14" RM 85Big Wheel - F 19"/R 16"	05-22 May-21
MD6246C	Rear	Solid	200	N/A	Contour	N/A				
MD6246CX	Rear	Solid	200	N/A	Contour	N/A				
MD6247D	Front	Floating	310	Gold	Plain	6			DRZ 400 SM	05-22
MD6247C	Front	Floating	310	Gold	Contour	6				
MD6248D	Rear	Solid	180	N/A	Plain	N/A			DERBI Senda X Race 50 R Senda X-treme 50 R Senda X-treme 50 SM Senda SM DRD 50 Senda SM DRD 50 APRILIA RX 50 SX 50 GILERA RCR 50 Enduro SMT 50 Supermotard SMT 50	05-11 03-11 03-11 02-03 05 06-14 06-14 03-06 03-06 07
MD6249C	Rear	Solid	160	N/A	Contour	N/A			GAS GAS (Pierer Mob) MC 65 HUSQVARNA TC 65 KTM SX 65 DERBI Senda X Race 50 R Senda X-treme 50 R	21 19-22 04-22 05-11 03-11
MD6249CX	Rear	Solid	160	N/A	Contour	N/A				
MD6249C	Rear	Solid	160	N/A	Contour	N/A				
MD6249CX	Rear	Solid	160	N/A	Contour	N/A				
MD6250D	Front	Solid	240	N/A	Plain	N/A				

OFF ROAD DISC BUYERS GUIDE

Disc No.	F/R	Type	Dia. (mm)	Hub Color	Profile	Bobbins	Left Bracket	Right Bracket	Model	Year
MD6251D	Front	Solid	180	N/A	Profile	N/A			HONDA TRX 500 FE5/FE6/FE7/FE8/FE9/FEA/FEB Fourtrax Foreman 4WD-ES TRX 500 FA5/FA6/FA7/FA8/FA9/FAA/FAB TRX 500 FM5/FM6/FM7/FM8/FM9/FMA/FMB Fourtrax Foreman 4WD TRX 500 FPE8/FPE9/FPEA/FPEB Fourtrax Foreman - Power Steering TRX 500 TM5/TM6 Fourtrax Foreman TRX 680 FA6/FA7/FA8/FA9/FAA/FAB/FAC Rincon 4x4 Auto	05-11 05-11 05-11 08-11 05-06 06-21
MD6252D	Rear	Solid	220	N/A	Profile	N/A			YAMAHA YFM 400 FAT/FAV (Big Bear) YFM 400 FGW/FGX Grizzly IRS YFM 450 FAT/FAHT/FAV (Kodiak)	05-06 07-08 05-06
MD6253D MD6253C	Rear Rear	Solid Solid	220 220	N/A N/A	Profile Contour	N/A N/A			GAS-GAS Enduro EC 200/250/300 EC 125/200/250/300 EC 200/250/300 (All models/2T) MC 125 MX 125/250 Pampera 125/450 SM 125/250 (4T) MX 200/250/300 SM 400 FSE (2T) SM 450	99-00 01-Sep 10-Dec 5 01-Apr 5 01-May 99-00 01-Feb 03-May
MD6254D MD6254C MD6254CX OSX6254 SMX6254	Front Front Front Front	Solid Solid Solid Solid	250 250 250 280 320	N/A N/A N/A Silver Black	Plain Contour Contour Contour Contour	N/A N/A N/A 6 6			SUZUKI RM-Z 250 RM-X 450 ZL0/ZL2 RM-Z 450 K5/K6/K7/L0/L1/L2/L3/L4/L5/L6/L7	08-21 10-15 05-17
MD6255D MD6255C MD6255CE MD6255CX	Rear Rear Rear Rear	Solid Solid Solid Solid	240 240 240 240	N/A N/A N/A N/A	Plain Contour Contour Contour	N/A N/A N/A N/A			RM-Z 250 RM-X 450 ZL0/ZL2 RM-Z 450	08-21 10-15 05-21
MD6256D UTVX6256	Rear Rear	Solid Solid	203 203	N/A N/A	Plain Contour	N/A N/A			POLARIS 330 Trail Boss 330 Trail Blazer FANTIC Scrambler 500	10-14 10-14 05
MD6257C	Rear	Solid	200	N/A	Contour	N/A			KTM SX85	03-10
MD6258C OSX6258 OSX6258ORG	Front Front Front	Solid Floating Floating	220 220 220	N/A Silver Silver	Contour Contour Contour	N/A 6 6	BRK028 BRK028ORG		KTM SX85 (17"/14" wheels) SX85 (19"/16" wheels) HUSQVARNA TC85 (17"/14" wheels)	03-15 03-12 14-15
MD6259D	Rear	Solid	240	N/A	Plain	N/A			CAGIVA 650 Elefant 750 Elefant	88-89 90-92
MD6260D	Front	Solid	260	N/A	Plain	N/A			CCM 404E 404 DS 604 E DS	03-04 03-04 98-03
MD6261D	Front	Solid	200	N/A	Plain	N/A			SUZUKI LT-A 700 XK5/XCK6/XK6/XK7 LT-A 750 XZK8/XK8/XK9/XZK9/XL0 King Quad	05-07 08-10
MD6262D	Front	Solid	182	N/A	Plain	N/A			POLARIS Trail Blazer 250 Trail Boss 330	05-06 05-06
MD6263D	Rear	Solid	200	N/A	Plain	N/A			YAMAHA YFZ 450 V/W/X	06-09

OFF ROAD DISC BUYERS GUIDE

Disc No.	F/R	Type	Dia. (mm)	Hub Color	Profile	Bobbins	Left Bracket	Right Bracket	Model	Year
MD6263C	Rear	Solid	200	N/A	Plain	N/A			YFZ 450 RY/RZ (Quad) YFZ 450 RSEA/RSEB/RSED/RSE YFZ 450 B/D YFM 700 RV/RW/RA/R Raptor	09-10 11-14 13-14 06-12
MD6264D MD6264C MD6264CX OSX6264 SMX6264	Front Front Front Front Front	Floating Floating Floating Floating Floating	250 250 250 250 250	Silver Silver Silver Silver Black	Plain Contour Contour Contour Contour	6 6 6 6 6			KAWASAKI KX 125 M6F/M7F/M8F KX 250 R6F/R7F/R8F KX 250 F (T6F/T7F/T8F) KX 250 F (KX 250 W9F/XAFB/YBF/YCF/ZDF/ZEF/ZFF/ZGF) (4T) KX 250 F (KX 250 W9F/XAFB/YBF/YCF/ZDF/ZEF/ZFF/ZGF) (4T) KX 450 F (D6F/D7F/D8F/E9F/EAF/EBF/FCF/FDF/FEF) KLX 450 R (A8F/A9F/AAF/ABF/ACF/ADF/AEF/AFF/AGF/AHF/AJF)	06-08 06-08 06-08 09-16 09-16 06-14 08-18
MD6265D	Front	Floating	260	Silver	Plain	6			CAGIVA 650 Elefant 750 Elefant	88-89 90-92
MD6266D	Front	Solid	300	N/A	Plain	N/A			ARCTIC CAT 250 DVX Sport KTM LC-4 640 Adventure R LC-4 640 Adventure 950 Adventure 950 Adventure S	06-08 04 05-07 02-06 03-06
MD6267D	F & R	Solid	180	N/A	Plain	N/A			ARCTIC CAT 50 DVX (4T) Sport 50 4x4 Auto Youth 90 2x4 (4T) Youth 90 DVX 90 DVX SE 90 (Reverse gear model) 90 SE 150 Utility 2x4 250 DVX Sport 300 2x4 Utility (Midsized) 300 DVX KYMC0 Mxer 50 (Quad) MXU 50 (2T) KXR 90/90 S Mongoose MXU 150 KXR 250 Maxxer 250 MXU 250 MXU 250 R Maxxer 300 MXU 300 MXU 300 R KAWASAKI KFX 50 (KSF 50 B7F/B8F/B9S/B9S/BDF/BEF/BFF/BGF/BHF) KFX 90 (KSF 90 A7F/A8F/A9F/AAF/ABF/ACF/ADF/AEF/AFF/AGF/AHF) KVF 300 CCF/CDF/CEF/CFE/CGF/CHF Brute Force	06/08 08 06 06-14 09 10-14 09 09-14 06-08 10-14 09-14 00-07 05-14 04-15 05-13 04-06 12-13 04-13 12-13 06-12 06-21 10-21 07-09/13-17 07-17 12-17
MD6268D	Rear	Solid	220	N/A	Plain	N/A			ARCTIC CAT 300 DVX KYMC0 Like 50 (2T) Like 50 (2T) Like 50 (4T) Like 50 LX (4T) KXR 250 Maxxer 250 MXU 250 MXU 250 R Maxxer 300	09-14 09 10-20 09 10-15 04-06 12-13 04-13 12-13 06-13
MD6269D MD6269C	Rear Rear	Solid Solid	240 240	N/A N/A	Plain Contour	N/A N/A			BETA RR 250 Enduro 2T RR 250 Enduro 2T RC Enduro RR 250 2T MY20 RR 250 Racing 250 X-Trainer Enduro RR 300 2T MY20	13-14 18-20 20-21 2015 20-21 20-21

DISC BUYERS GUIDE

OFF ROAD DISC BUYERS GUIDE

Disc No.	F/R	Type	Dia. (mm)	Hub Color	Profile	Bobbins	Left Bracket	Right Bracket	Model	Year
MD6269D MD6269C Contd.	Rear Rear	Solid Solid	240 240	N/A N/A	Plain Contour	N/A N/A			BETA Contd. RR 300 Enduro 2T RR 300 Enduro 2T RC RR 300 Racing 300 X-Trainer Enduro RR 350 4T MY20 RR 350 Enduro 4T RR 350 Efi 4T RR 350 4T Enduro Racing RR 350 4T Racing Enduro RR 390 4T MY20 Enduro RR-S 390 4T MY20 RR 390 4T RR 400 4T Racing Enduro RR 430 4T MY20 RR 430 4T RR 430 4T Racing 430 RR-S 4T RR 450 4T Enduro RR 450 4T Enduro Racing RR 450 4T Cross Country Enduro RR 480 4T MY20 RR 480 4T RR 480 4T Racing RR 498 4T Enduro RR 498 4T Enduro Racing 500 RR-S 4T KTM 450 Rally 690 Rally Factory Replica 690 SM 690 SM-LE (Limited Edition) 690 Enduro R 690 Enduro 950 Adventure 950 Adventure S	13-14 18-20 15 15-21 20-21 12-14 15 13-20 15 20-21 20-21 15-20 12-14 13-20 20 15 15 20-21 12-14 13-20 12 15-21 15 15-20 12-20 13-14 20-21 17-20 07-09 07-09 10-11 09-13 08-14 02-06 03-06
MD6270D MD6270C	Front Front	Floating Floating	310 310	Gold Gold	Plain Contour	9 9			KTM SMR 450/525 SMR 450 (Brembo F/Caliper) HUSABERG FS 650 E Supermoto	04-07 14 05-07
MD6271D UTVX6271	Front Front	Solid Solid	252 252	N/A N/A	Plain Vee	N/A N/A			ARCTIC CAT HDX 500 Prowler HDX 500 Prowler LTD HDX 500 Prowler XT 550 H1 EFI Prowler XT 550 XT 550 i Prowler XT 650 H1 Prowler 650 H1 Prowler 650 Prowler 4 x 4/M4 XTX 700 H1 LE Prowler XTX 700 H1 EFI Prowler XTX 700 XTX 700 i Prowler HDX 700 Prowler HDX 700 Prowler LTD Wildcat 1000i G.T. Wildcat 1000 Wildcat 1000 X Wildcat 1000 X Wildcat 1000 LTD Wildcat 1000 4 LTD XTZ 1000 H2 Prowler XTZ 1000	14 14 14-19 09 10-11 11-15 06-09 07 08 08 09 10-11 11-17 11-14 14 12 13-14 13 14-16 13-14 14-16 09 10-16
MD6271D	Rear	Solid	252	N/A	Plain	N/A			KAWASAKI KVF 300 CCF/CDF (2x4)	13
MD6272D	Front	Solid	198	N/A	Plain	N/A			POLARIS Hawkeye 300 2x4/4x4	06

OFF ROAD DISC BUYERS GUIDE

Disc No.	F/R	Type	Dia. (mm)	Hub Color	Profile	Bobbins	Left Bracket	Right Bracket	Model	Year
MD6273D	Rear	Solid	202	N/A	Plain	N/A			POLARIS Hawkeye 300 2x4/4x4 Prowler 700 HDX LTD	06 14
MD6274D	Front	Solid	173	N/A	Plain	N/A			200 Phoenix (AC/AD Model and following/rear drum model) 200 Phoenix (Rear drum model) 200 Phoenix Quadricycle Model (EC/ED models/rear disc model) 200 Sawtooth (Rear drum model) 200 Sawtooth Quadricycle (Rear disc model) Cobra 220 (Quad) Overland 300 (Quad) (AT20) Cobra 350 Cobra 400 (Quad)	06-09 10-14 05-09 06-08 06/08 06-11 06-07 10-11 10-13
MD6274D	Rear	Solid	173	N/A	Plain	N/A			400 Hawkeye HO (2x4)	13-14
MD6275D UTVX6275	Rear Rear	Solid Solid	218 218	N/A N/A	Plain Vee	N/A N/A			POLARIS Contd. 325 Hawkeye 2x4 325 Sportsman Ace 325 Sportsman Ace Efi 325 Sportsman Ace Euro 325 Sportsman Ace HD 400 Ranger 400 Sportsman HO 4x4 Sportsman 500 X2 500 Sportsman Touring HO Ranger 500 (2x4/4x4) Ranger 500 (4x4 EFI) 500 Ranger 4x4 EFI 500 Ranger Crew 500 Sportsman HO 500 Sportsman HO 500 Sportsman Forest RZR 570 570 Forest Tractoe Efi/EPS 570 Sportsman Ace 570 Sportsman Ace Euro 570 Sportsman Efi (inc EPS models) 570 Sportsman Touring Efi 570 Sportsman Touring Tractor Efi 570 Sportsman 6X6 inc Tractor Efi 570 Ranger Crew RANGER 570, FULL SIZE (R12) RANGER CREW 570FS (R08) RGR 570 EPS CREW MD (R04) RGR 570 EFI CREW (R10) RGR 570 CREW (R03) Ranger 6x6 Efi 700 Ranger XP 700 4x4 Ranger TM Ranger EV (Electric) 800 Ranger XP 800 Ranger 6x6 800 Ranger Crew RZR 800 Ranger RZR-4 800 Efi 800 Ranger RZR 4 EPS 800 Sportsman Big Boss/6/6/EFI 800 Sportsman HO/EFI 800 Sportsman HO/EFI 800 Sportsman Efi 800 Sportsman 900 D Crew Ranger Diesel 900 Ranger Crew 900 D Ranger Diesel 900 Ranger RZR XP 900 Ranger XP 1000 Ranger Diesel 1000 Ranger Diesel Crew Ranger ETX Brutus	15 14 15 14-15 15 10-14 11-14 06 11-13 06 09-10 11-13 11-13 Up to 15/12/08 After 16/12/08 12 12-19 15 15 15 11-21 14-21 16-21 17-21 14-15 17-19 17-19 18 17 18-19 06 06 06 10-14 10-12 10-14 10-14 08-14 10-14 12 09-14 Up to 15/12/08 After 16/12/08 10-13 12-14 13-14 11-14 12 15 15 15 15 13-14
MD6276D	Rear	Solid	220	N/A	Plain	N/A			CCM CR 40 S Cafe Racer (Full fairing) SR 40 Street Scrambler R 45	07-08 07-09 07-09

OFF ROAD DISC BUYERS GUIDE

Disc No.	F/R	Type	Dia. (mm)	Hub Color	Profile	Bobbins	Left Bracket	Right Bracket	Model	Year
MD6276D Contd.	Rear	Solid	220	N/A	Plain	N/A			CCM Contd. 404 E 404 DS/DS Supermoto 604 E DS 604 E Supermoto 604 RS 644 DS/SM FT 710 S Flat Tracker R30 (Spoke Wheel)	03-04 03-04 98-03 99-03 00-03 04 08-09 02-04
MD6277D	Front	Solid	160	N/A	Plain	N/A			SUZUKI LTR 450 K6/K7/K8/K9/L0/L1	06-12
MD6278D	Rear	Solid	190	N/A	Plain	N/A			LTR 450 K6/K7/K8/K9/L0/L1	06-12
MD6279D	Front	Solid	260	N/A	Plain	N/A			MALAGUTI XSM 50 Supermotard YAMAHA DT 50 X (Supermotard) XT 125 X	03-07 04-08 07-11
MD6280D	Rear	Solid	220	N/A	Plain	N/A			DT 50 R DT 50 X Supermotard XT 125 R (3D61/ED63) XT 125 R (13D1) XT 125 R (13D3/13D5) XT 125 X (3D62/3D64) XT 125 X (13D2/4/6) MBK X Limit Enduro 50cc X Limit Supermoto 50cc	02-08 02-08 05-06 07 07-12 05-06 07-11 03-09 03-09
MD6281D	Front	Solid	220	N/A	Plain	N/A			SUZUKI RV 125 K2-K9/L0/L3/L4/L5/L6/L7/L8/L9 Van-Van RV 200 K2/K3 RV 200 L6/L7/L8 Van-Van	02-19 02-03 16-18
MD6282D	Rear	Solid	190	N/A	Plain	N/A			CAN-AM DS 250 YAMAHA YFM 90 RY/RZ/RA/RB/RD Raptor	06-15 09-13
MD6283D	Front	Solid	175	N/A	Plain	N/A			CAN-AM DS 250 YAMAHA YFM 300 B/D Grizzly	06-15 12-14
MD6284D	Rear	Solid	245	N/A	Plain	N/A			MZ/MUZ Baghira Forest/Forest HR 21" front spoke wheel Baghira Street Moto 17" front spoke wheel Baghira 21" front spoke wheel Baghira Black Panther 17" front spoke wheel Mastiff 21" front spoke wheel	96-05 96-05 99-05 96-03 96-05
MD6285D	Rear	Solid	200	N/A	Plain	N/A			Rally 200	05-07
MD6286D	Rear	Solid	220	N/A	Plain	N/A			DT 50 R-L (SM) MX 50 Pegaso 50 RX 3-5 Marce (M/N/P/R) RX 50 C/CD RX 50 Racing	02-03 03-05 92-94 91-94 95-04 03-06
MD6287D	Rear	Solid	220	N/A	Plain	N/A			HUSQVARNA CR 125 SM 125 SM 125 S SMR 125 (4T) SMS 4-125cc (4T) TE 125 (4T) WR 125 WRE 125 CR 250 WR 360 TE 410 SM 570 R TE 570	00-01 00 02-13 11-13 11 11-13 00-01 00/02-13 00-01 00-01 00 01 01

OFF ROAD DISC BUYERS GUIDE

Disc No.	F/R	Type	Dia. (mm)	Hub Color	Profile	Bobbins	Left Bracket	Right Bracket	Model	Year
MD6288D MD6288C	Rear Rear	Solid Solid	240 240	N/A N/A	Plain Contour	N/A N/A			HUSQVARNA SM 610 S TC 610 TE 610 SMR 620 CR 125 WR 125 TC 250 TE 250 TE 250 (4T) WR 250 WR 250 TE 310 (4T) TE 410 EC 450 FSR Enduro (4T) Pampera 450 (4T) SM 450 R SMR 450 RR TC 450 TE 450 SM 510 R TC 510 TE 510 EC 515 FSR/FSE (4T) SM 610 S	02-06 00 00 10-12 06-08 06-08 05-08 06-08 09-10 00-01 06-08 10 06 05-08 07-08 07-10 06-07 05-10 06-10 06-10 05-08 06-08 05-08 06
MD6289D MD6289C	Front Front	Solid Solid	260 260	N/A N/A	Plain Contour	N/A N/A			EC 125/200/250/300 (Nissin) EC 125/200/250/300 (All models/2T) MX 125/250 (MC) EC 450 FSR (4T) Enduro/FSE Pampera 450 (4T) EC 515 FSR/FSE (4T) Enduro	00-10 11-13 01-09 05-09 07-08 05-09
MD6290D	Rear	Solid	228	N/A	Plain	N/A			450 Outlaw MXR 500 Outlaw 525 S Outlaw 525 Outlaw IRS	09-10 06-07 08-10 08-11
MD6291D	Front	Solid	220	N/A	Plain	N/A			YFM 550 FWAD Grizzly EPS (Power Steering) YFM 550 FWA Grizzly IRS YFM 700 FGPW/FGPX/FGPY/FGPZ/FGPA/FGPB/FGPD/ FWAD Grizzly	07-14 11-14 07-18
MD6292D	Rear	Solid	205	N/A	Plain	N/A			YFM 550 FWAD Grizzly EPS (Power Steering) YFM 550 FWA Grizzly IRS YFM 700 FGPW/FGPX/FGPY/FGPZ/FGPA/FGPB/FGPD/ FWAD Grizzly	11-14 11-14 07-18
MD6293D	Front	Floating	240	Gold	Plain	9			HUSQVARNA SM 400 R SM 450 R SM 450 RR SMR 450 R SM 510 R SM 550 RR SM 570 R SM 610/S SM 610 ie SMR 630 (4T) SMR 630 STR 650 CRC	02 03-10 07-10 06-07 06-10 08-10 01-04 02-06 07-09 10-11 06/10-12 07
MD6294D	Front	Floating	320	Gold	Plain	9			HUSQVARNA LT 610 SM 610 R SM 610	00 00 98-00
MD6295D	Rear	Solid	220	N/A	Plain	N/A			HUSQVARNA CR 125 WR 125 CR 250 TC 250 TE 250 WR 250 WR 300 WR 360	02-05 02-05 02-05 02-03 02-05 02-05 09-12 02

OFF ROAD DISC BUYERS GUIDE

Disc No.	F/R	Type	Dia. (mm)	Hub Color	Profile	Bobbins	Left Bracket	Right Bracket	Model	Year
MD6295D Contd.	Rear	Solid	220	N/A	Plain	N/A			HUSQVARNA Contd. SM 400 R TE 400 SM 450 R TC 450 TE 450 SM 510 R TC 510 TE 510 SM 570 R TC 570 TE 570 SM 610 ie TE 610/IE SMR 630 STR 650 CRC	02 02 03-06 03-04 03-05 06 04 04-05 02-04 02-03 02-04 07-09 06-09 06 07
MD6296D	Front	Solid	240	N/A	Plain	N/A			RK6	93-96
MD6297D	Front	Solid	240	N/A	Plain	N/A			YAMAHA DT 50 R XT 125 R (3D61/ED63) XT 125 R (13D1) XT 125 R (13D3/13D5) MBK X Limit Enduro 50cc X Limit Supermoto 50cc	02-08 05-06 07 07-10 03-09 03-09
MD6298D	Rear	Floating	240	Gold	Plain	9			KTM 690 SMC 690 SMC R 950 R Superenduro 990 Adventure S (Non ABS) 990 Adventure R (Non ABS) 990 Adventure (ABS) 990 Adventure Dakar Edition (ABS)	08-11 12-13 06-08 06-08 09-12 07-12 11
MD6299D MD6299C	Front Front	Floating Floating	300 300	Gold Gold	Plain Contour	9 9			HUSQVARNA 701 Enduro KTM 690 Enduro R 690 Enduro 690 Rally Factory Replica 950 R Superenduro 990 Adventure S (Non) 990 Adventure R (ABS)	16-21 09-13 08-14 07-09 06-08 06-08 09-12
MD6300D	Front	Solid	296	N/A	Plain	N/A			HONDA FMX 650 5/6	05-08
MD6301D	Rear	Solid	160	N/A	Plain	N/A			HYOSUNG TE 50 TE 90 TE 100	05-07 05-07 05-07
MD6302D MD6302CX	Front Front	Solid Solid	185 185	N/A N/A	Plain Contour	N/A N/A			HONDA TRX 420 FE7/FE8/FE9/FEA/FEB 4WD Fourtrax ES TRX 420 FA9/FAA/FAB Fourtrax Auto 4WD TRX 420 FM7/FM8/FM9/FMA/FMB 4WD Fourtrax TRX 420 FPA9/FPAA/FPAB Fourtrax Auto Power Steering TRX 420 FPM9/FPMA/FPMB Fourtrax 4WW - Power Steering TRX 420 TE7/TE8/TE9 Fourtrax ES - 2WD TRX 420 TM7/TM8/TM9/TMA/TMB 2WD Fourtrax TRX 420 All Models	07-11 09-11 07-11 09-11 09-11 07-09 07-11 14-21
MD6303D	Front	Solid	282	N/A	Plain	N/A			CAGIVA E 900 C Elefant E 900 C IE Lucky Explorer	93-97 95-97
MD6304C	Rear	Solid	200	N/A	Contour	N/A			KAWASAKI KSF 450 B8F/B9F/BAF/BBF/BCS/BFD/BEF (KFX 450 R)	08-14
MD6305D MD6305C MD6305CX	Rear Rear Rear	Solid Solid Solid	240 240 240	N/A N/A N/A	Plain Contour Contour	N/A N/A N/A			SUZUKI RM 125 K6/K7/K8/K9 RM 125 XCK8 RM 250 K6/K7/K8/K9 RM 250 XCK8	06-12 09 06-12 09

OFF ROAD DISC BUYERS GUIDE

Disc No.	F/R	Type	Dia. (mm)	Hub Color	Profile	Bobbins	Left Bracket	Right Bracket	Model	Year
MD6306D	Front	Floating	320	Silver	Plain	9			R30 (604/644) (Mag wheel)	02-04
MD6307D	Front	Solid	300	N/A	Plain	N/A			APRILIA ETV 1000 Caponord (Non ABS - Bolt fixing) ETV 1000 Caponord (Non ABS - Bolt fixing) ETV 1000 Caponord Rally (Non ABS - Bush fixing) ETV 1000 Caponord (ABS - Bush fixing)	01-03
MD6308D	Rear	Solid	270	N/A	Plain	N/A				03 04-07
MD6309C	Front	Solid	280	N/A	Contour	N/A			KAWASAKI KLR 650 (KL 650 E8F/E9F)	08-09
MD6309CX	Front	Solid	280	N/A	Contour	N/A				
SMX6309	Front	Floating	280	Black	Contour	6				
MD6310C	Rear	Solid	240	N/A	Contour	N/A			KLR 650 (KL 650 E8F/E9F)	08-09
MD6310CX	Rear	Solid	240	N/A	Contour	N/A				
MD6311D	Rear	Solid	220	N/A	Plain	N/A				
MD6312D	Front	Solid	235	N/A	Plain	N/A			RZR 570 800 Ranger RZR	12-13
UTVX6312	Front	Solid	235	N/A	Vee	N/A				08-14
MD6313C	Front	Solid	310	N/A	Contour	N/A			KTM SMR 450	07-13
MD6314D	Front	Solid	220	N/A	Contour	N/A			HONDA CRF 150 R Small wheel (FR16"/RR 14") CRF 150 RB Big wheel (FR19"/RR 16")	07-21 07-21
MD6314C	Front	Solid	220	N/A	Contour	N/A				
MD6314CX	Front	Solid	220	N/A	Contour	N/A				
OSX6314	Front	Floating	280	Silver	Contour	6				
SMX6314	Front	Floating	320	Black	Contour	6				
MD6315D	Rear	Solid	220	N/A	Plain	N/A			APRILIA RX 125 Tuareg Rally 125 Tuareg Rally 125 (L/M)	92-01 89 90-91
MD6316D	Rear	Solid	190	N/A	Plain	N/A			HONDA CRF 150 R Small wheel (FR16"/RR 14") CRF 150 RB Big wheel (FR19"/RR 16")	07-21 07-21
MD6316C	Rear	Solid	190	N/A	Contour	N/A				
MD6316CX	Rear	Solid	190	N/A	Contour	N/A				
MD6317D	Front	Solid	240	N/A	Plain	N/A			CRF 150 F	03-20
MD6317C	Front	Solid	240	N/A	Contour	N/A				
OSX6317	Front	Floating	280	Silver	Contour	6				
SMX6317	Front	Floating	320	Black	Contour	6				
MD6318D	Front	Solid	260	N/A	Plain	N/A			MOTORHISPANIA RX 50 Super Racing RYZ 50 Urban Bike XR6 (2T) 50	06-07 06-10 03-07
MD6319C	Rear	Solid	230	N/A	Contour	N/A			YAMAHA WR 250 RX/RV WR 250 XX/XY	08-18 08-15
MD6320C	Front	Floating	250	Gold	Contour	6			WR 250 RX/RV 298mm replacement disc when using WR 250 X wheel & caliper bracket (Disc only supplied by EBC)	08-18
MD6320CSPEC	Front	Floating	298	Gold	Contour	6				
MD6321C	Rear	Solid	198	N/A	Contour	N/A			CAN-AM DS 450 (2x4/EFi) DS 450 X (2x4/EFi) DS 450 XXC/XXM	08-15 08-09 10-15
MD6322C	Front	Solid	225.5	N/A	Contour	N/A			DS 450 (2x4/EFi) DS 450 X (2x4/EFi) DS 450 XXC/XXM	08-15 08-09 09-15
MD6323C	Front	Floating	298	Gold	Contour	6			YAMAHA WR 250 XX/XY	08-15
SMX6323	Front	Floating	320	Black	Contour	6				
MD6324D	Front	Solid	240	N/A	Plain	N/A			YZ 125/250/490 N	85
MD6325D	Front	Solid	220	N/A	Plain	N/A			KAWASAKI KRF 750 A8F/B8F Teryx 750 4x4 (RUV) KRF 750 C8F/D8F Teryx 750 4x4 LE (RUV) (RUV) KRF 750 F8F Teryx 750 4x4 NRA Outdoors KRF 750 TAF/PDF/RDF/VBP Teryx 750i 4x4 SGE	08 08 08 10-11
UTVX6325	Front	Solid	220	N/A	Vee	N/A				

OFF ROAD DISC BUYERS GUIDE

Disc No.	F/R	Type	Dia. (mm)	Hub Color	Profile	Bobbins	Left Bracket	Right Bracket	Model	Year
MD6325D UTVX6325 Contd.	Front Front	Solid Solid	220 220	N/A N/A	Plain Vee	N/A N/A			KAWASAKI Contd. KRF 750 G9F/NAF/NBF/NCS/NDF Teryx 750 Fi 4x4 KRF 750 J9FA/K9F/PAF/RAF/PBF/RBF/RCS Teryx 750 Fi 4x4 LE KRF 750 L9F Teryx 750 Fi 4x4 Le Sport KRF 750 M9F Teryx 750 Fi 4x4 NRA Outdoors KRF 750 SAF/SAFA/SBF/SBFA/SCS/SCSA/SDF Teryx 750 Fi 4x4 Sport LE	09-13 09-12 09 09 10-13
MD6326C	Rear	Solid	240	N/A	Contour	N/A			KLX 250 (KLX 250 S9F/SAF/SBF/SCF/SDF/SEF/SFF/SGF/SHF)	09-17
MD6327C	Rear	Solid	186	N/A	Contour	N/A			KAWASAKI KLX 140 (17" front/14" rear) KLX 140 L (19" front/16" rear)	08-20 08-20
MD6328C	Front	Solid	220	N/A	Contour	N/A			KAWASAKI KLX 140 (17" front/14" rear) KLX 140 L (19" front/16" rear)	08-20 08-20
MD6330D MD6330C MD6330CX OSX6330 SMX6330	Front Front Front Front Front	Floating Floating Floating Floating Floating	250 250 250 280 320	Silver Silver Silver Silver Black	Plain Contour Contour Contour Contour	6 6 6 6 6		BRK021 BRK022	KLX 250 H6F/H7F KLX 250 SF	06-07 09-20
MD6331D	Rear	Solid	200	N/A	Plain	N/A			HONDA TRX 700 XX8/XX9/XXB	08-11
MD6332D UTVX6332	Rear Rear	Solid Solid	185 185	N/A N/A	Plain Vee	N/A N/A			YAMAHA YXR 700 Rhino 4x4 SE YXR 700 FA/FB/FD Rhino Side x Side	09 11-13
MD6333D	Rear	Solid	165	N/A	Plain	N/A			YXR 700 Rhino 4x4 SE (Parking brake) YXR 700 FA/FB/FD Rhino Side x Side Parking brake	09 11-13
MD6334D	Rear	Solid	180	N/A	Plain	N/A			CAN-AM DS 90 X (2x4/4T)	08-15
MD6335D	Front	Solid	165	N/A	Plain	N/A			DS 90 X (2x4/4T)	08-15
MD6336C	Front	Floating	180	Gold	Contour	6			KTM 450 SX-F (Quad) 505 SX-F (Quad) XC 450 Quad XC 525 Quad	09-11 09-12 08-10 08-12
MD6337D	Rear	Solid	200	N/A	Plain	N/A			450 SX-F (Quad) 505 SX-F (Quad) XC 450 Quad XC 525 Quad	09-11 09-12 08-10 08-12
MD6338D UTVX6338	Front Front	Solid Solid	227 227	N/A N/A	Plain Vee	N/A N/A			POLARIS 500 Ranger (EFI) 4x4 RZR 570 Ranger 570, Full Size (R12) Ranger Crew 570FS (R08) Ranger 570 EPS Crew MD (R04) Ranger 570 EFI Crew (R10) Ranger 570 Crew (R03) 700 Ranger 4x4 EFI 800 Ranger RZR 4 EPS 800 Ranger Crew 800 Ranger XP 800 Ranger 6x6 RZR-4 800 EFI 900 D Crew Ranger Diesel 900 D Ranger Diesel 900 Ranger RZR XP 900 Ranger Crew 900 XP Ranger 1000 Ranger Diesel 1000 Ranger Diesel Crew RZR-4 XP900 Brutus RZR 900 "50 Inch All Options" RZR-S 900 "60 Inch All Options" 1000 General EPS (2 Seat)	09-10 14-19 17-19 17-19 18 17 18-19 09 12 10-14 10-12 10-14 10-14 13-14 11-14 12 13-15 15 15 12-14 13-14 15-19 15-19 16

OFF ROAD DISC BUYERS GUIDE

Disc No.	F/R	Type	Dia. (mm)	Hub Color	Profile	Bobbins	Left Bracket	Right Bracket	Model	Year
MD6338D UTVX6338 Contd.	Front Front	Solid Solid	227 227	N/A N/A	Plain Vee	N/A N/A			POLARIS Contd. RZR 1000 60 Inch 1000 General 4 EPS (4 Seat)	16-19 17-19
MD6339D	F & R	Solid	246	N/A	Plain	N/A			Sportsman 500 XP Sportsman 550 Sportsman 550 XP Sportsman 550 EPS Sportsman 550 FOREST Sportsman 550 XP EPS Sportsman 550 XP TOURING EPS Sportsman 550 X2 Sportsman 550 X2 EPS Sportsman 550 TOURING EPS Scrambler 850 Sportsman 850 TOURING EPS Sportsman 850 TOURING HO EPS Sportsman 850 FOREST Sportsman 850 XP Sportsman 850 SP Sportsman 850 TOURING SP Sportsman 850 XP EPS Sportsman 850 XP TOURING EPS Scrambler 1000 Scrambler 1000 XP Scrambler 1000 XP Sportsman 1000 XP Sportsman 1000 XP 55 Sportsman 1000 XP TRACTOR Sportsman 1000 TOURING XP Sportsman 1000 TOURING TRACTOR Sportsman 1000 XP HIGH LIFTER 550 SPORTMAN X2	09 11-13 09-13 10-14 10-14 09-14 12 10-14 14 10-14 13-18 10-14 13-15 12-15 09-15 15-18 15-18 09-14 12 14-18 14-21 19-20 15-19 20-21 16-21 15-20 16-21 19 10
MD6340D									USE MD6217D	
MD6341D Billet	F & R	Solid	200	N/A	Plain	N/A			MUV 700-9 Big Red Side x Side	09
MD6342D MD6342C	Rear Rear	Solid Solid	220 220	N/A N/A	Plain Contour	N/A N/A			G 450 X	08-11
MD6343C OSX6343 SMX6343	Front Front Front	Solid Floating Floating	260 280 320	N/A Silver Black	Contour Contour Contour	N/A 6 6			G 450 X	08-11
MD6344D UTVX6344	Rear Rear	Solid Solid	220 220	N/A N/A	Plain Vee	N/A N/A			Ranger RZR 170	09-14
MD6345D	Rear	Solid	240	N/A	Plain	N/A			XL 700 V8/V9/VA Transalp XL 700 VA8/VA9/VAA Transalp	08-11 08-11
MD6346D	Front	Solid	256	N/A	Plain	N/A			XL 650 VY/V1-V7 Transalp XL 700 V8/V9/VA Transalp XL 700 VA8/VA9/VAA Transalp	00-07 08-11 08-11
MD6347C	Front	Solid	240	N/A	Contour	N/A			WR 125 R	09-15
MD6348D	Rear	Solid	220	N/A	Plain	N/A			DL 450 RS (DL901) QZ 450 RS QZ 450 Sport	06-09 06-09 08-11
MD6349C	Front	Floating	270	Silver	Contour	6			TM Most models	01-09
MD6350C	Rear	Solid	240	N/A	Contour	N/A			TM Most models	01-09
MD6351C	Front	Floating	300	Gold	Contour	6			Kawasaki KLX 250	
MD6352C	Rear	Solid	240	N/A	Contour	N/A			Kawasaki KLX 250 SF W9F	
MD6353D UTVX6353	Front Front	Solid Solid	125 125	N/A N/A	Plain Vee	N/A N/A			POLARIS Ranger RZR 170	09-14

OFF ROAD DISC BUYERS GUIDE

Disc No.	F/R	Type	Dia. (mm)	Hub Color	Profile	Bobbins	Left Bracket	Right Bracket	Model	Year
MD6354D	Rear	Solid	200	N/A	Plain	N/A			ADLY GK 125 Buggy MOTOROMA Lazer 125 Buggy	03-07 03-07
MD6355D MD6356D MD6356C MD6356CX See OSX6028 & SMX6728 for oversized disc	Front Front Front Front	Solid Floating Floating Floating	190 250 250 250	N/A Gold Gold Gold	Plain Plain Contour Contour	N/A 6 6 6			LT-A 500 XPK9/XPZK9/XPL0-XPL5 LT-A 750 XPK9/XPZK9/XPL0-XPL5 YZ 125 N/P/R/S/T/V/W/X/Y/Z/A/B/D/E/F/G(2T) YZ 250 N/P/R/S/T/V/W/X/Y/Z/A/B/D/E/F/G (2T) YZ 250 FN/FP/FR/FS/FT/FV/FW/FX/FY/FZ/FA/FB/FD/FE/FF (4T) WR 250 FN/FP/FR/FS/FT/FV/FW/FX/FY/FZ/FA/FB/FD (4T) WR 250 FF/FG (4T/Reverse Cylinder) WR 400 FN (4T) WR 426 FN/FP YZ 426 FN/FP (4T) WR 450 FR/FS/FT/FV/FW/FX/FY/FA/FB/FD/FE/FF (4T) YZ 450 FR/FS/FT/FV/FW/FX/FY/FZ/FA/FB/FD/FE/FF (4T)	09-15 09-15 01-16 01-16 01-15 01-13 15-16 01 01-02 01-02 03-15 03-15
MD6357C	Front	Solid	240	N/A	Contour	N/A			SINNIS Apache 125 QM 125 GY-2B(A) Apache (Rear drum model)	09-10 09-10
MD6358C	Rear	Solid	210	N/A	Contour	N/A			SINNIS Apache 125 QM 125 GY-2B(A)	09-10
MD6359D	Front	Solid	240	N/A	Plain	N/A			RC 125 Rally	87-88
MD6360C MD6360COS	Rear	Solid	210	N/A	Contour	N/A			HUSQVARNA TC 85 (2T) (17/14" wheels) TC 85 (2T) (19/16" wheels) KTM SX 85 (17/14" wheels) SX 85 (19/16" wheels) SX 85 (220mm Oversize Rear disc for Aftermarket kit) 250 Freeride R (2T) 350 Freeride (4T)	14-21 14-21 11-21 11-21 03-17 14-15 12-15
MD6361D	Front	Solid	240	N/A	Plain	N/A			Senda SM DRD 50 Senda SM DRD 50 Senda 50 SM DRD Black Edition	02-03 05 05
MD6362C	Rear	Solid	190	N/A	Contour	N/A			KLX 125 CAF/CBF/CCF/CDF/CEF/CCS/CDS/CEF/CFF/CGF KLX 125 DAF/DBF/DCF/DDF/DEF (D-Tracker)	10-16 10-14
MD6363C	Front	Solid	240	N/A	Contour	N/A			KLX 125 CAF/CBF/CCF/CDF/CEF/CCS/CDS/CEF/CFF/CGF KLX 125 DAF/DBF/DCF/DDF/DEF (D-Tracker)	10-16 10-14
MD6364D	Rear	Solid	220	N/A	Plain	N/A			Quadzilla	
MD6365D	Front	Solid	196	N/A	Plain	N/A			TRX 500 FEC Fourtrax Foreman ES 2/4 WD TRX 500 FMC Fourtrax Foreman S 2/4WD TRX 500 FPEC Fourtrax Foreman 2/4 WD TRX 500 FAC Fourtrax Foreman AT 2/4 WD	12 12 12 12
MD6366D UTVX6366	F & R F & R	Solid Solid	215 215	N/A N/A	Contour Vee	N/A N/A			CAN AM See main application pages	
MD6367C	Front	Floating	260	Gold	Contour	6			HUSQVARNA TE 511 (4T) RR 250 4T Enduro RR 350 4T Enduro RR 400 4T Enduro RR 450 4T Enduro RR 520 4T Enduro RR 525 4T Enduro	11-12 05-07 11 05-11 05-11 05-11 05-09
MD6368C	Rear	Solid	240	N/A	Contour	N/A			RR 250 4T Enduro RR 350 4T Enduro RR 400 4T Enduro RR 450 4T Enduro RR 520 4T Enduro RR 525 4T Enduro	05-07 11 05-11 05-11 05-11 05-09
MD6369D	Rear	Solid	220	N/A	Plain	N/A			YFM 350 B/D Grizzly	12-14
MD6370D UTVX6370	F & R F & R	Solid Solid	215 215	N/A N/A	Contour Vee	N/A N/A			CAN AM See main application pages	

OFF ROAD DISC BUYERS GUIDE

Disc No.	F/R	Type	Dia. (mm)	Hub Color	Profile	Bobbins	Left Bracket	Right Bracket	Model	Year
MD6371D MD6371C	Rear Rear	Solid Solid	220 220	N/A N/A	Plain Contour	N/A N/A			KTM EXC 350 LC4 SC 400 EGS 400/EGS-E/LSE (LC4 Enduro) LC4-E 400 Enduro SX/EXC 440 LC4 MX 600 LC4 EXC 600 SX EXC/EGS 620 SX 620 SC 620 Supercompetition EGS/EGS-E/LSE 620 Enduro EGS-E 620 Adventure/Rallye LC4 620 SC Supermoto LC4 625 SC Supermoto LC4 625 SC Supercompetition SMC 625 SXC 625 Duke-E 640 (Single pin pad fixing/zero offset disc) Duke II 640 (2 pin pad fixing/zero offset) Duke II 640 (2 pin pad fixing/Disc with offset) LC4-E 640 Enduro LC4-E 640 Supermoto LC4-E 640 (Central single pin fixing) LC4 640 Adventure R LC4 640 Adventure LC4 640 Adventure R LC4 640 Adventure 640 LC4 Adventure SMC 660 Supermoto	94-95 96-99 96-99 00-01 94-95 90-91 90-93 95 96-99 96-00 96-99 99 00 02 02 04-06 03-04 98 99-02 03-07 00-04 00-04 03 99-02 03 04 05-07 03-07 03-04
MD6372C MD6372CX	Front Front	Solid Solid	256 256	N/A N/A	Contour Contour	N/A N/A			HONDA CRF 250 L CRF 250 L ABS CRF 300 L ABS	13-20 17-21 20-21
MD6373C MD6373CX	Rear Rear	Solid Solid	220 220	N/A N/A	Contour Contour	N/A N/A			HONDA CRF 250 L CRF 250 L ABS CRF 300 L ABS CRF 250 Rally CRF 250 Rally ABS CRF 300 Rally ABS CRF 250 ME Supermoto	13-20 17-21 20-21 17-20 17-21 20-21 14-15
MD6374D UTVX6374	Rear Rear	Solid Solid	218 218	N/A N/A	Contour Vee	N/A N/A			POLARIS RZR-4 XP 900 900 XP Ranger	12-14 13-14
MD6376D UTVX6376	Rear Rear	Solid Solid	200 200	N/A N/A	Plain Vee	N/A N/A			KYMCO UXV 500 (Side x Side) UXV 500 i (Side x Side)	08-09 10-14
MD6377C	Rear	Solid	240	N/A	Contour	N/A			HUSQVARNA TE 250 (4T) TE 250 R (4T) TE 250 Meo Replica (4T) TE 310 (4T) TE 310 R (4T) TE 511 (4T)	11-13 13 11 11-13 13 11-12
MD6378D	Front	Solid	250	N/A	Plain	N/A			GILERA RC 125 Top Rally	89-92
MD6379C	Front	Solid	240	N/A	Contour	N/A			HUSQVARNA TC 85 (2T) (17"/14" wheels) TC 85 (2T) (19"/16" wheels) KTM SX 85 (17"/14" wheels) SX 85 (19"/16" wheels)	14-22 14-22 16-22 16-22
MD6380D UTVX6380 UTVX6380UKR	F & R F & R F & R	Solid Solid Solid	245 245 233	N/A N/A N/A	Plain Vee Vee	N/A N/A N/A			RZR 1000 XP	14

OFF ROAD DISC BUYERS GUIDE

Disc No.	F/R	Type	Dia. (mm)	Hub Color	Profile	Bobbins	Left Bracket	Right Bracket	Model	Year
MD6381D	Rear	Solid	200	N/A	Plain	N/A			YAMAHA YZZ 1000 R EPS (Side X Side) YXZ10PXG YZZ 1000 R SE (Side X Side) YZZ 1000 R SS (Side x Side) YXM 700 E Viking EPS COMO (YXM70VPHG) (Parking Brake) YXM 700 E Wolverine R (YXE70WPHG) (Parking Brake) YXM 700 ES - Viking EPS SE (YXM700PSE) (Parking Brake) YXC 700 E Viking VI EP (YXC700PF/PXG/PXH/PXJ)	16 16 17-18 16 16 14-16 15-18
MD6382D UTVX6382	F & R F & R	Solid Solid	205 205	N/A N/A	Plain Vee	N/A N/A			YXM 700 E Viking EPS COMO YXM70VPHG) YXM 700 E Wolverine R (YXE70WPHG) YXR 1000 R EPS (Side X Side) YXZ10PXG YXR 1000 SE (Side X Side) YXM 700 ES - Viking EPS SE (YXM700PSE) YXC 700 E Viking VI EP (YXC700PF/PXG/PXH/PXJ)	16 16 16 16 14-16 15-18
MD6383D UTVX6383	F & R F & R	Solid Solid	203 203	N/A N/A	Plain Vee	N/A N/A			ARCTIC CAT 400 ATV (Core/Midsized) 450 ATV (Core/Midsized) 500 ATV (Midsized) 500 ATV XT (Midsized) 550 ATV (Midsized) 550 ATV LTD (Midsized) 550 ATV XT (Mid Size) 700 ATV Diesel 700 ATV LTD 700 ATV XT	13-14 13-14 13-14 13-14 13-14 13-14 13-14 12-14 12-14 13-14
MD6384D UTVX6384	F & R F & R	Solid Solid	252 252	N/A N/A	Plain Vee	N/A N/A			ARCTIC CAT Wildcat Trail 700 XT inc LTD Wildcat 1000 4X	15-19 14-16
MD6388C MD6388CX SMX6264	Front Front Front	Floating Floating Floating	270 270 320	Gold Gold Black	Contour Contour Contour	6 6 6			KAWASAKI KX-F 250 KX-F 250 XC Enduro KX 450 F KX-F 450 270mm Front 250mm Rear Rotor KX-F 450 XC Enduro	15-22 21-22 15-20 19-22 21-22
MD6389C MD6389CX OSX6389 SMX6389	Front Front Front Front	Floating Floating Floating Floating	270 270 280 320	Gold Gold Silver Black	Contour Contour Contour Contour	6 6 6 6			HONDA CRF250R AC (260mm F/DISC) CRF 250 RE (Limited Road Use) CRF 450 R inc RWE AC (260mm F/DISC) CRF 450 RE (Limited Road Use) CRF 450 RX (18" Rear Wheel)	15-21 16 15-21 16 17-21
MD6390D MD6390C	Front Front	Solid Solid	220 220	N/A N/A	Plain Contour	N/A N/A			HONDA CRF 125 F (Small wheel FR 17"/RR 14" Wheels) CRF 125 FB (Big wheel FR 19"/RR 16" Wheels)	14-21 14-21
MD6392C MD6392C MD6392CX OSX6392	Front Front Front Front	Floating Floating Floating Floating	270 270 270 280	Gold Gold Gold Silver	Contour Contour Contour Contour	6 6 6 6			FANTIC XE 125cc 2T XX 125cc 2T XX 250 XEF 250 XEX 250 XEF 450 XXF 450 YAMAHA YZ 125 YZ 125 Monster Energy YZ 125 X WR-F 250 (4T/Reverse Cylinder) YZ 250 2T 270 F/Disc, 245 R/Disc YZ 250 2T 270 F/Disc, 245 R/Disc Monster Energy YZ 250 X 2T 270 F/Disc, 245 R/Disc YZ 250 F (4T) YZ-F 250 (270mm Disc) YZ 250 FG 60th Anniversary (4T) WR-F 450 (270mm F/Disc/4T) YZ 450 FG (4T) YZ 450 FG 60th Anniversary (4T) YZ-F 450 (270mm Disc) YZ 450 FGY (60th Anniversary Edition/270mm Disc)	21 21 21 21 21 21 21 17-22 22 21-22 17-21 17-22 22 17-22 16-20 16-21 16 16-21 16 16 16-21 16

OFF ROAD DISC BUYERS GUIDE

Disc No.	F/R	Type	Dia. (mm)	Hub Color	Profile	Bobbins	Left Bracket	Right Bracket	Model	Year
MD6392C MD6392CX									WR-F 450 (270mm F/Disc/4T) YZ 450 FG (4T) YZ 450 FG 60th Anniversary (4T) YZ-F 450 (270mm Disc) YZ 450 FGY (60th Anniversary Edition/270mm Disc)	16-21 16 16 16-21 16
MD6394D	Rear	Solid	184	N/A	Plain	N/A			GILERA GSM 50 RK 50 CANNIBAL ZULU 50	99-01 96-98 01-02
MD6395D UTVX6395	F & R F & R	Solid Solid	245 245	N/A N/A	Plain Vee	N/A N/A			YAMAHA YZZ 1000 R EPS (Side X Side) YXZ10PXG YZZ 1000 R SE (Side X Side) YZZ 1000 R SS (Side x Side)	16 16 17-18
MD6396D UTVX6396	F & R F & R	Solid Solid	220 220	N/A N/A	Plain Vee	N/A N/A			CAN-AM (SIDE x SIDE) Defender HD5 500cc Defender 799cc Defender 976cc Defender DPS 799cc Defender DPS 976cc Defender XT 976cc Defender XT 799cc Defender XT Cab 976cc Defender XT Cab 799cc	17-19 16 16 16 16 16 16 16 16 16
MD6397D UTVX6397 OSUTVX6397	F & R F & R F & R	Solid Solid Solid	248 248 270	N/A N/A N/A	Plain Vee Vee	N/A N/A N/A			POLARIS (RZR MODELS) RZR XP Turbo RZR XP 4 Turbo RZR XP Pro Turbo	16-20 16-20 20-22
MD6398D UTVX6398	F & R F & R	Solid Solid	212 212	N/A N/A	Plain Vee	N/A N/A			KAWASAKI (Mule Models) KAF 820 AFF/AGF/AHF/AJF Mule Pro FXT KAF 820 BFF/BGF/BHF/BJF Mule Pro FXT/EPS KAF 820 CFF/CGF/CHF/CJF Mule Pro FXT/EPS LE KAF 820 DFF/DGF/DHF/DJF Mule Pro FXT/EPS Camo KAF 820 EGF/EHF/EJF Mule Pro FX KAF 820 FGF/FHF/FJF Mule Pro FX/EPS KAF 820 GGF/GHF/GJF Mule Pro FX/EPS LE KAF 820 HGF/HHF Mule PRO - FX/EPS Camo KAF 820 JGF/JHF Mule PRO - FXT Ranch Edition KAF 1000 AGF/AHF/AJF Mule Pro DXT/Diesel KAF 1000 BGF/BHF/BJF Mule Pro DXT/Diesel EPS KAF 1000 CGF/CHF - Mule Pro DXT EPS LE/Diesel KAF 1000 DGF/DHF - Mule Pro DX /Diesel KAF 1000 EGF/EHF/EJF Mule Pro DX EPS/Diesel KAF 1000 FGF/FHF - Mule Pro DX EPS LE/Diesel	15-18 15-18 15-18 15-18 16-18 16-18 16-18 16-17 16-17 16-18 16-18 16-17 16-17 16-18 16-17 16-17 16-18 16-17
MD6399D UTVX6399	F & R F & R	Solid Solid	200 200	N/A N/A	Plain Vee	N/A N/A			KAWASAKI (Tyrex Models) KRT 750 ACF/ADF (Tyrex 4 750 4X4) KRT 750 ACFA/ADFA (Tyrex 4 750 4X4 EPS) KRT 750 CCF/CDF (Tyrex 4 750 4X4 EPS LE) KRF 800 BEF/BFF/FGF/FHF/FJF (Teryx) KRF 800 CEF/CFE/GGF/GHF/GJF (Teryx LE) KRF 800 DEF/DFE/HGF/HFF/HJF (Teryx Camo) KRT 800 BEF/BFF/FGF/FHF/FJF (Teryx 4) KRT 800 CEF/CFE/GGF/GHF/GJF (Teryx 4 LE) KRT 800 DEF/DFE/HGF/HFF/HJF (Teryx 4 Camo)	12-13 12-13 12-13 14-18 14-18 14-18 14-18 14-18 14-18 14-18
MD6400D	Front	Solid	260	N/A	Plain	N/A			AJP PR3 125 Enduro PR3 125 Enduro Pro PR3 125 Extreme PR3 125 Supermoto	13-15 13-15 13-15 13-15
MD6401D	Rear	Solid	220	N/A	Plain	N/A			AJP PR3 125 Enduro PR3 125 Enduro Pro PR3 125 Extreme PR3 125 Supermoto PR3 200 Enduro PR3 200 Enduro Pro PR3 200 M/X Pro PR3 200 Supermoto	13-15 13-15 13-15 13-15 12-14 12-14 12-14 12-14

DISC BUYERS GUIDE

OFF ROAD DISC BUYERS GUIDE

DISC
BUYERS GUIDE

Disc No.	F/R	Type	Dia. (mm)	Hub Color	Profile	Bobbins	Left Bracket	Right Bracket	Model	Year
MD6402C	Front	Solid	260	N/A	Contour	N/A			AJP PR4 200 Enduro PR4 200 Enduro PR4 200 Enduro PR4 Enduro Pro 200 PR4 200 Enduro Pro PR4 200 Supermoto PR4 200 Supermoto PR4 200 Supermoto PR4 200 Supermoto Pro	04-09 10-11 12-14 10-11 12-14 04-09 10-11 12-14 10-11
MD6403C	Rear	Solid	220	N/A	Contour	N/A			AJP PR4 200 Enduro PR4 200 Enduro PR4 200 Enduro PR4 Enduro Pro 200 PR4 200 Enduro Pro PR4 200 Supermoto PR4 200 Supermoto PR4 200 Supermoto PR4 200 Supermoto Pro PR5 250 Enduro PR5 250 Enduro PR5 250 Supermoto PR5 250 Supermoto	04-09 10-11 12-14 10-11 12-14 04-09 10-11 12-14 10-11 10-11 09 10-15 09 10-15
MD6404C	Front	Solid	270	N/A	Contour	N/A			AJP PR4 200 Extreme PR4 240 Extreme PR5 250 Extreme	12-14 13-15 12-15
MD6405C	Rear	Solid	219	N/A	Contour	N/A			AJP PR4 200 Extreme PR4 240 Extreme PR5 250 Extreme	12-14 13-15 12-15
MD6406D	Front	Solid	300	N/A	Plain	N/A			APRILIA ETV 1000 Caponord Rally (Non ABS - Bush fixing) ETV 1000 Caponord (ABS - Bush fixing)	03 04-07
MD6407C OSX6407	Front Front Rear	Solid Floating	220 250	N/A Silver	Contour Contour	N/A 6			HUSQVARNA TC 85 - 2T/17 Inch/14 Inch Wheels, 220 f/disc, 210 r/disc TC 85 - 2T/19 Inch/14 Inch Wheels, 240 f/disc & 220 r/disc KTM SX 85 (17"/14" wheels) SX 85 (19"/16" wheels) SX 85 - 17 Inch/14 Inch wheels - 240mm Front Disc/Radial Caliper SX 85 - 19"/16" wheels - 240mm Front Disc/Radial Caliper	21-22 21-22 12-15 12 21-22 21-22
MD6408D UTVX6408	F & R Rear	Solid Solid	227 227	N/A N/A	Plain Contour	N/A N/A			POLARIS 1000 General EPS (2 Seat) 1000 General 4 EPS (4 Seat)	17-19 17-19
MD6409C	Front	Solid	296	N/A	Contour	N/A			HONDA CRF 250 Rally CRF 250 Rally ABS CRF 300 Rally ABS	17-20 17-20 20-21
MD6410D UTVX6410	F & R F & R	Solid Solid	210 210	N/A N/A	Plain Contour	N/A N/A			HONDA SXS 1000 M3 Pioneer (3 Seater) SXS 1000 M3P Pioneer (3 Seater) SXS 1000 M5D Pioneer (5 Seater) SXS 1000 M5L Pioneer (5 Seater) SXS 1000 M5P Pioneer (5 Seater)	16-18 16-18 16-18 17-18 16-18
MD6411D UTVX6411 OSUTVX6411 OSUTVXKIT6411 (Replacement Oversize Discs) (Same OS Discs used front and rear)	Front Front	Solid Solid	260 260	N/A N/A	Plain Vee	N/A N/A			CAN AM (SIDE X SIDE) Maverick X3 Maverick X3 Max Turbo Maverick X3 Turbo Maverick X3 Max Turbo Maverick X3 Turbo R Maverick X3 Max Turbo R	17 17 18 18 18 18

OFF ROAD DISC BUYERS GUIDE

Disc No.	F/R	Type	Dia. (mm)	Hub Color	Profile	Bobbins	Left Bracket	Right Bracket	Model	Year
MD6412D UTVX6412	Rear Rear	Solid Solid	247.5 247.5	N/A N/A	Plain Vee	N/A N/A			CAN AM (SIDE X SIDE) Maverick X3	17
OSKIT6411 (Oversize Disc & Bracket Kit) OSUTVX6411 (Replacement Oversize Discs) (Same OS Discs used front and rear)									Maverick X3 Max Turbo Maverick X3 Turbo Maverick X3 Max Turbo Maverick X3 Turbo R Maverick X3 Max Turbo R	17 18 18 18 18
MD6414D MD6414C	Front Front	Floating Floating	320 320	Gold Gold	Plain Contour	6 6			HUSQVARNA 701 Supermoto KTM 690 SMC R (ABS)	16-21 14-17
MD6415D MD6415C	Rear Rear	Solid Solid	240 240	N/A N/A	Plain Contour	N/A N/A			KTM 690 Enduro R (ABS) 690 SMC R (ABS)	09-20 14-17
MD6417C	Rear	Floating	240	Gold	Contour	6			HUSQVARNA 701 Enduro	16-21
MD6418D MD6418C MD6418CX	Front Front Front	Solid Solid Solid	197 197 197	N/A N/A N/A	Plain Contour Contour	N/A N/A N/A			YAMAHA YZ65J	18-21
MD6419D MD6419C MD6419CX	Rear Rear Rear	Solid Solid Solid	190 190 190	N/A N/A N/A	Plain Contour Contour	N/A N/A N/A			YAMAHA YZ65J	18-21
MD6420C									Use MD6388CX	
MD6421D MD6421C MD6421CX	Rear Rear Rear	Solid Solid Solid	250 250 250	N/A N/A N/A	Plain Contour Contour	N/A N/A N/A			KAWASAKI KX 450 F (4T) 270mm Front 250mm Rear Rotor	19-22
MD6422CX	Front Front	Solid Solid	260 260	N/A N/A	Contour Contour	N/A N/A			SUZUKI RMZ 250 RMZ 450	19-21 18-21
MD6423D MD6423C	Rear Rear	Solid Solid	240 240	N/A N/A	Plain Contour	N/A N/A			SUZUKI RMZ 450	18-21
MD6424D	Rear	Solid	240	N/A	Plain	N/A			KTM 1050 Adventure 1090 Adventure 1190 Adventure 1290 Adventure	15-16 17-19 13-16 16-18
MD6425D MD6425C	F & R F & R	Solid Solid	250 250	N/A N/A	Plain Contour	N/A N/A			HONDA SXS 1000 S2R Talon	19-21
MD6426C	Front	Solid	260	N/A	Plain	N/A			KTM Freeride 250 Free Ride 350	12-15 12-17
MD6427C	Front	Floating	280	Silver	Contour	6			METRAKIT XL 80 Mini GP	09
MD6428C	Rear	Solid	165	N/A	Plain	N/A			METRAKIT XL 80 Mini GP	09
MD6429D MD6429C	Front Front	Solid Solid	260 260	N/A N/A	Plain Contour	N/A N/A			SHERCO 250 SCF-Factory 250 SEF-R 250 SEF-Factory 300 SCF-Factory 300 SEF-R 300 SEF-Factory 450 SCF-Factory 450 SEF-Factory 500 SCF-Factory 500 SEF-R 500 SEF-Factory	19-20 19-20 19-20 19-20 19-20 19-20 19-20 19-20 19-20 19-20 19-20 19-20

OFF ROAD DISC BUYERS GUIDE

Disc No.	F/R	Type	Dia. (mm)	Hub Color	Profile	Bobbins	Left Bracket	Right Bracket	Model	Year
MD6430C	Rear	Solid	220	N/A	Plain	N/A			SHERCO 250 SCF-Factory 250 SEF-R 250 SEF-Factory 300 SCF-Factory 300 SEF-R 300 SEF-Factory 450 SCF-Factory 450 SEF-Factory 500 SCF-Factory 500 SEF-R 500 SEF-Factory	19-20 19-20 19-20 19-20 19-20 19-20 19-20 19-20 19-20 19-20 19-20 19-20
MD6431C									USE MD6373C	
MD6432CX									USE MD6372C	
MD6433CX	Front	Floating	260	Silver	Contour				KTM 125 EXC 250 EXC-F Six Days 250 EXC Six Days Inc Tpi (2T) 250 SXF Prado 300 EXC Six Days Inc Tpi 300 XC-W 350 EXC-F Six Days 350 XCF-W 450 EXC-F Six Days 450 SXF Factory Edition Inc Herlings and Cairoli Replicas 500 EXC-F Six Days	15-16 15-20 15-20 2020 15-20 15-18 15-20 15-16 15-20 18-20 15-20
MD6434D	F & R	Solid	260	N/A	Plain	N/A			KAWASAKI KRX 1000 Teryx	19-20
MD6435C	F & R	Solid	240	N/A	Plain	N/A			ZERO Zero DS ZF8.5/ZF11.4 Zero DS ZF8.5/ZF11.4 Zero DS ZF9.4/ZF12.5 Zero FX ZF2.8/ZF5.7 Zero FX ZF2.8/ZF5.7 Zero FX ZF2.8/ZF5.7 Zero FX ZF3.3/ZF6.5 Zero X Zero XU Zero XU ZF2.8/ZF5.7	13 14 15 15 13 14 16-20 10-12 10-12 13
MD6436CX	Rear	Solid	240	N/A	Contour	N/A			TM RACING MX 125 2S EN 125 2S Inc Tsi 2T EN 144 2S Inc Tsi MX 144 2S EN 250 Fi ES Twin Enduro 4T EN 250 Tsi ES Enduro MX 250 ES 2S 2T MX 250 Fi ES 4T EN 300 2S Inc Tsi 2T EN 300 Fi Es Twin Enduro MX 300 2S ES 2T MX 300 Fi ES 4T EN 450 Fi ES MX 450 Fi ES EN 530 Fi ES MX 530 Fi ES	10-21 10-21 10-21 10-21 10-21 10-21 10-21 10-21 10-21 10-21 10-21 10-21 10-21 10-21 10-21 10-21 10-21 10-21
MD6437CX	Front	Solid	270	N/A	Contour	N/A			TM RACING MX 125 2S EN 125 2S Inc Tsi 2T EN 144 2S Inc Tsi MX 144 2S EN 250 Fi ES Twin Enduro 4T EN 250 Tsi ES Enduro MX 250 ES 2S 2T MX 250 Fi ES 4T EN 300 2S Inc Tsi 2T EN 300 Fi Es Twin Enduro MX 300 2S ES 2T MX 300 Fi ES 4T	10-21 10-21 10-21 10-21 10-21 10-21 10-21 10-21 10-21 10-21 10-21 10-21 10-21 10-21 10-21 10-21 10-21

OFF ROAD DISC BUYERS GUIDE

Disc No.	F/R	Type	Dia. (mm)	Hub Color	Profile	Bobbins	Left Bracket	Right Bracket	Model	Year
MD6437CX Contd.	Front	Solid	270	N/A	Contour	N/A			TM RACING Contd. EN 450 Fi ES MX 450 Fi ES EN 530 Fi ES MX 530 Fi ES	10-21 10-21 10-21 10-21
SMX6728 OSX6728	Front Front	Floating Solid	320 280	Silver Siver		6 N/A			YAMAHA YZ 125 YZ 250 2T YZ 250 4T YZ 450	08-16 08-16 07-15 08-15
MD6438CX	Rear	Solid	220	N/A	Contour	N/A			DS 450 XXC/XXM	10-15

CLUTCH KITS FOR STREET / DIRT / ATV

STREET - 3 choices

1. Standard - CK Series

Almost identical to original equipment clutch plates, the CK series are a cork based product impregnated with aluminium particles to increase wear life and heat resistance. Material is highly compressed to avoid swell and clutch drag and is an ideal general purpose replacement material for all grades and sizes of motorcycle. Kit includes a complete "engine set" of friction plates only.

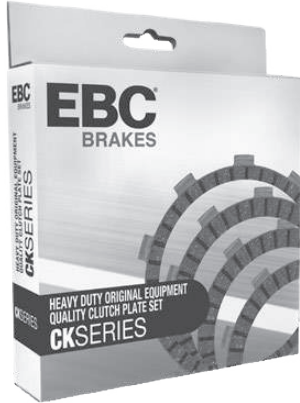

2. Race/Sport - SRC Series

A paper lined plate set complete with heavy duty clutch springs (for bikes fitted with diaphragm type springs we cannot supply a heavy duty spring kit), the SRC kit is ideal for heavy sport bikes, faster riders and production based race use. Advantages of the SRC series are longer life, higher heat resistance, although this clutch has a more aggressive / faster take up than the CK cork series.



3. Race/Sport - SRK Series

SRK complete kits include aramid fibre lined friction plates, steel separator plates and springs to provide a streetgoing kit for high performance street and road race use much similar to the DRC program for off road. Some of the kits will now feature new DIAPHRAGM springs bikes to provide a complete clutch rebuild kit for every sportbike possible.



CSK CLUTCH SPRING SETS



DIAPHRAGM TYPE SPRING



COIL TYPE SPRING



Always fit new springs which get tired after miles of heat and use. EBC spring kits are 8-10% stiffer than standard and are sold in engine sets.

As stated in general fitting/safety instructions, advise customers that lever will feel slightly 'heavier' when uprating springs, and to test ride/acquaint themselves with this change in control.

CLUTCH APPLICATIONS

DIRT/ATV - 2 choices



1. Full Kit - DRC Series. The US #1 selling off road clutch.

Why are these the best???

- Anti-swell, alloy impregnated heavy duty cork based facings provide smooth clutch take up and allow modulation, unlike paper clutches which tend to snatch
- Complete engine set of friction plates, HD springs and STEEL SEPARATOR PLATES prevent premature driven plate wear, oil muddying and loss of stack height
- EBC DRC kits are built with swaged aluminium carriers which spread the load on the clutch basket and prevent clutch basket "dogging".

2. Standard - CK Series

Cork based replacement clutch exactly the same as used on the street series CK clutch plates described above. A general all purpose replacement unit.

EBC only sell complete kits as replacing single plates is deemed unwise. The object is to reset the clutch to its original stack height and just replacing one plate will not achieve that and promote clutch slip.

Many off road clutches use aluminium separator plates which wear quickly and muddy the oil. If this has happened in your engine, flush the drive case, change the oil and rebuild the clutch with a complete DRC kit which includes STEEL separator plates that not only prevent wear but increase flywheel effect of the engine and improve performance.

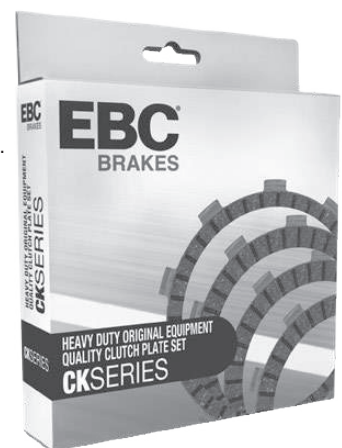

What makes EBC the BEST!!!

Unique wide ear soft alloy drive body eliminates basket damage and delivers smooth clutch operation.

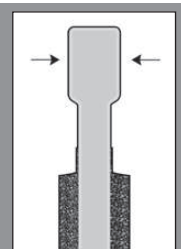

EBC Coil Spring Kits

Full engine sets of heat treated and tempered spring steel coil springs with a guaranteed tension of 15% above standard. Clutch springs are an extremely important part of a motorcycle transmission system and we take very seriously the accuracy of spring tension in the EBC range of CSK kits. See application pages for part numbers.



Spring Tension Measuring Machine



You simply cannot engineer coil springs correctly without such a device as shown here. EBC have one of these digital clutch spring tension calibration machines at each of its locations to guarantee the accuracy and consistency of spring batches.

The machine is calibrated based on the nominal spring deformation and then a tight tolerance of variation is achieved within the target and 15% upgrade range.

EBC have tested many original and aftermarket clutch springs and the variation in tension is enormous and varies so dramatically, that we took the decision to measure and calibrate every clutch spring in-house to be sure of their accuracy.

EBC Diaphragm Clutch Springs

EBC SRK clutch kits, shown on the following pages, include the new diaphragm spring range. Full engine sets of heat treated and tempered spring steel diaphragm springs with a guaranteed 15% tension upgrade.

The pictures below show a typical aftermarket billet clutch and how the assembly looks.

It is essential when replacing the diaphragm spring that the anti-scuff plate is in good condition. This is a rather flimsy steel pressing and can become bent or distorted in which case it must be replaced, this is a genuine part available from your main dealer only.

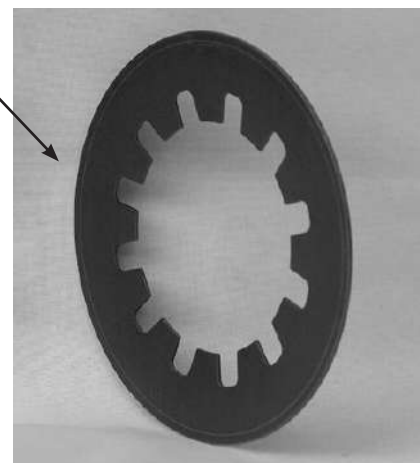
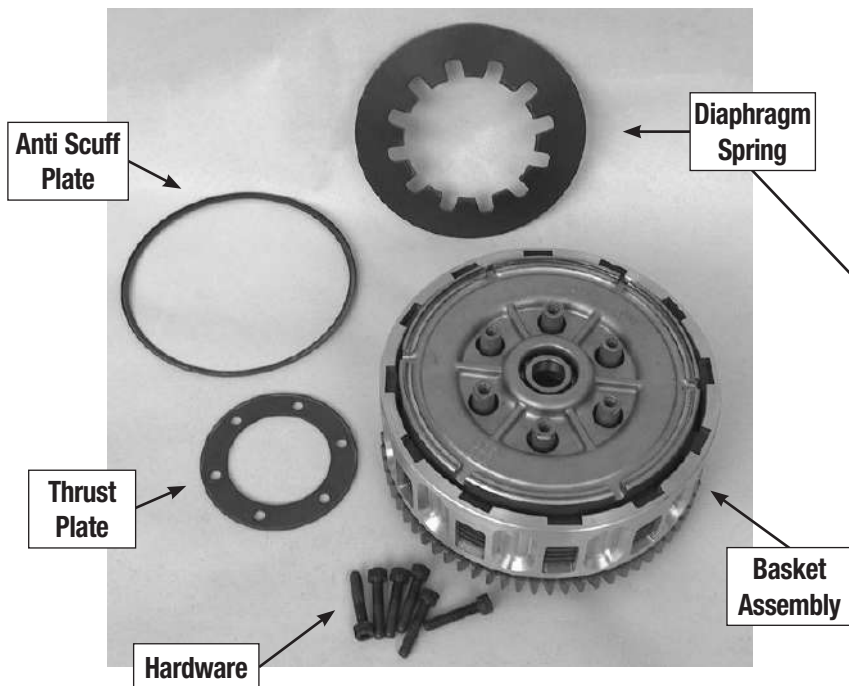

CLUTCH APPLICATIONS

CKF Clutch Kits



See application pages for availability and fitments.



CKF is the name of the new EBC carbon fibre impregnated for motocross ATV and now some street bikes. They are built tough to last longer, grip better, feel better and drive better than stock cork based units.

PLUS the high heat ability of these CKF Carbon Fiber clutch plates handles much higher stresses and temperatures encountered in racing yet feel gentle and smooth in everyday riding.

One day all motocross bikes and ATV will be built using a clutch like this, but for now the only way to get the best clutch in the game is to step up to an EBC CKF plate set or go the whole hog and invest in the DRCF clutch kits which are sold as an assembly with a stack height measured to precisely reset your bike to the original sizing.

DRCF Clutch Kits

The toughest off road clutch yet.

Tested for 12 months in the toughest moto-x applications, these new heavy duty kits are ideal for fast off road use especially on modern 4 stroke engines.

The ultimate moto-x and ATV heavy duty clutch kit designed for race use. These new kits feature carbon fibre lined clutch plates plus a full set of steel plates and heavy duty springs.

Available Part Numbers

DRCF025	DRCF054	DRCF101	DRCF123	DRCF158	DRCF201	DRCF255	DRCF287	DRCF313
DRCF033	DRCF058	DRCF105	DRCF128	DRCF159	DRCF208	DRCF256	DRCF288	DRCF315
DRCF042	DRCF070	DRCF107	DRCF129	DRCF163	DRCF227	DRCF259	DRCF298	
DRCF043	DRCF079	DRCF108	DRCF130	DRCF164	DRCF230	DRCF261	DRCF299	
DRCF044	DRCF085	DRCF109	DRCF131	DRCF182	DRCF240	DRCF262	DRCF301	
DRCF045	DRCF088	DRCF111	DRCF137	DRCF189	DRCF241	DRCF269	DRCF303	
DRCF046	DRCF098	DRCF113	DRCF148	DRCF195	DRCF244	DRCF276	DRCF304	
DRCF049	DRCF100	DRCF119	DRCF155	DRCF200	DRCF254	DRCF277	DRCF306	

See application pages for fitments.

CLUTCH APPLICATIONS

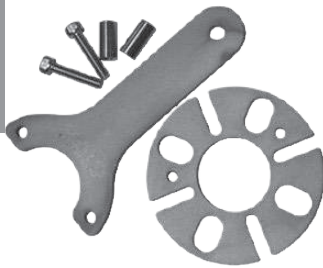

Clutch Removal Tools

A range of clutch tools to allow easy install of all EBC clutch kits. Range covers 95% of motorcycles and ATVs and allow positive holding of the clutch basket or centre boss to allow untightening and retightening of securing nuts.

Clutch application pages show appropriate tool and the table below is a list of the current available programme.

Part Numbers Available at Time of Print

CT001	CT010	CT017	CT027	CT037SP	CT048SP	CT059	CT075	CT086SP
CT002	CT010SP	CT018SP	CT028	CT038SP	CT049	CT060	CT076SP	CT087SP
CT003	CT011	CT019	CT029	CT039	CT050SP	CT061	CT077SP	CT088
CT004	CT012	CT020	CT029SP	CT040SP	CT051	CT066SP	CT078SP	CT090SP
CT005	CT012SP	CT021	CT030	CT041	CT052	CT068SP	CT079SP	CT091
CT006	CT013	CT022	CT031	CT042	CT053SP	CT069	CT080	CT092
CT007	CT013SP	CT023	CT032	CT043SP	CT054SP	CT070SP	CT081SP	
CT008	CT014	CT024	CT033SP	CT044	CT055SP	CT071SP	CT082SP	
CT008SP	CT014SP	CT024SP	CT034SP	CT045	CT056SP	CT072SP	CT083	
CT009	CT015	CT025	CT035SP	CT046	CT057SP	CT073	CT084SP	
CTw009SP	CT016	CT026	CT036SP	CT047SP	CT058	CT074	CT085	

Costing far less than OE manufacturer tools, EBC strongly recommend selling a clutch tool for every clutch sold.

Many dealers have already ordered one of each tool and loan these to customers with a deposit to gain tool loan income.



Heavy Duty Clutches & Springs



EBC Clutches are totally Asbestos Free, made from a cork based “anti-swell” facing and impregnated with aluminium particles to reduce wear and heat fade.

Kits are sold in pre-measured engine sets and should always be replaced in engine sets. **USE ONLY MANUFACTURERS** Drive case oils and avoid lead or other anti-friction additives.

SOAK PLATES in drive case oil before installing. EBC Clutch Springs are 10-15% stiffer than stock springs to avoid slip. Always check lever operating pressure for ease of clutch disengagement before riding or releasing motorcycle for use.

CAUTION – SAFETY WARNINGS FOR CONSUMERS

The following warnings now appear on the underside of our clutch packaging. For stocks in older packaging that do not display these safety warnings, we strongly recommend that you photocopy these essential points and advise customers.

- Never start a motorcycle whilst in gear with clutch depressed.
- Never reverse a motorcycle with the engine running, the machine in gear and clutch depressed.
- Hold front brake lever on when selecting gears from standstill.
- Never engage gears from a standstill with engine revs above 1500 rpm. Check oil levels regularly.
- When fitting heavy duty clutch springs acquaint yourself with increased hand pressure required to depress clutch before riding motorcycle. Assemble the clutch as per the original manufacturers workshop manual.

Make & Model	Year	CK Series #	CKF Series #	Spring Kit #	DRC Series #	DRCF Series #	SRC Series #	SRK Series #	CT Tool #
HONDA									
C 50 M/C 50	-78	CK1107		CSK044					
C 50 Z2/ZZ/ZA	78-81	CK1148		CSK044					
C 50 All models	82-93	CK1148		N/A					
C 50 (Single seat model)	95	CK1148		N/A					
C 50 P/S/N/X/Y/1/2	96-02	CK1148		N/A					
CB 50 J	81	CK1150		CSK003					CT012SP
CB 50 V/W Dream 50	97-98	CK1150		CSK048					CT012SP
CD 50 ST/SV/SW/SX Benley 50 S	96-99	CK1105		N/A					
CF 50/CF 50 K2	77-78	CK1148		CSK044					
CL 50 V/X Benley	97-99	CK1105		N/A					
CR 50 RE-RF	84-85	CK1151	CKF1151	CSK003					CT012SP
CRF 50 F	04-20	CK1148		N/A			SRC090		
CRM 50 RN/RP/RR/RT	93-96	CK1150		CSK003					CT012SP
MB 50	80-82	CK1150		CSK003					CT012SP
MTX 50 SC	83-87	CK1150		CSK003					CT012SP
MBX 50 SD/SF	83-85	CK1150		CSK003					CT012SP
MP 50 3/DX3 (AC17) Solo	03	CK1148		N/A					
MT 50 SA/SE/SG/SJ/SL	80-93	CK1150		CSK003					CT012SP
NSR 50 FP/FR/FS	93-95	CK1150		CSK003					CT012SP
NSR 50 RV/RW/RX/RV	97-00	CK1150		CSK003					CT012SP
NSR 50 SK/SP/SR/SS	89-95	CK1150		CSK003					CT012SP
NSR 50 V (AC10-180)	97	CK1151	CKF1151	CSK003					CT012SP
NSR 50 X (AC10-190)	99	CK1151	CKF1151	CSK003					CT012SP
SS 50 ZK2/ZB2	75-80	CK1105		N/A					
ST 50 J/K Dax	78-93	CK1148		N/A					
TLM 50 F	85	CK1150		CSK031					CT012SP
XR 50 R1/R2/R3	01-03	CK1148		N/A					
XR 50 M5 (AD14) Motard	06	CK1150		CSK048					CT012
XZ 50 39844 APE-AC16	01-02	CK1150		CSK048					CT012
Z 50 RZ/RA-RD	79-86	CK1107		CSK044					
CR 60 RF/RG	85-86	CK1151	CKF1151	CSK003					CT012
ATC 70 All Models	78-85	CK1148		CSK018					
C 70/C 70 M	-78	CK1107		N/A					
C 70 Z2/ZZ/C/D/DMC	78-85	CK1148		CSK018					
CF 70 C	77-78	CK1148		CSK018					
CRF 70 F4/F5/F6/F7/F8/F9/FA/FB/FC/FD	04-13	CK1148		CSK018					
XR 70 RV/RW/RX/RV/R1/RV/R1-R3	97-03	CK1148		CSK018					
CRM 75 RK/RL/RM/RP/RR	89-94	CK1151	CKF1151	CSK003					CT012SP
NSR 75 N/P/R/X/Y (NS-1)	92-00	CK1151	CKF1151	CSK003					CT012SP
XR 75 K4/K5	78-79	CK1150		CSK022					CT012
CR 80 RA/RB/RC	80-82	CK1151	CKF1151	CSK003					CT012

CLUTCH APPLICATIONS

EBC CLUTCH KITS

Make & Model	Year	CK Series #	CKF Series #	Spring Kit #	DRC Series #	DRCF Series #	SRC Series #	SRK Series #	CT Tool #
HONDA Contd.									
CR 80 RD	83	CK1151	CKF1151	CSK023					CT012
CR 80 RE	84	CK1119		CSK023					CT012SP
CR 80 RF/R2F	85	CK1119		CSK173	DRC001				CT012SP
CR 80 RG/R2G	86	CK1119		CSK173	DRC001				CT012SP
CR 80 RH/RJ/RK/RL/RM/RN/RO/RS/RT/RBT/RV /RBV/RW/RBW/RX/RBX/RY/RBY/R1/RB1/R2/RB2	87-02	CK1119		CSK173	DRC001				CT012SP
CRF 80 F4/F5/F6/F7/F8/F9/FB/FC	04-12	CK1150		CSK048					CT012
MBX 80 FWDD/FWDF	83-86	CK1151	CKF1151	CSK003					CT012SP
MTX 80 RFD/RFF	83-84	CK1151	CKF1151	CSK003					CT012SP
NSR 80 J-2/K/L/N/P/R/S (HC06)	88-	CK1151	CKF1151	CSK003					CT012SP
NSR 80 V (HC06-170)	97	CK1151	CKF1151	CSK003					CT012SP
NSR 80 X (HC06-180)	99	CK1151	CKF1151	CSK003					CT012SP
XR 80 Z/A/B	80-81	CK1150		CSK022					CT012
XR 80 R	87-88	CK1150		CSK008					CT012
CR 85 R3/RB3/R4/RB4/R5/RB5/R6/RB6/R7/RB7	03-07	CK1119		CSK173	DRC001				CT012SP
C 90 (from frame no A073285/Z2/ZZ)	75-81	CK1156		N/A					
C 90 C/E/G/MF/P/MP/MG/N/MN/P/MP/T/MT	82-03	CK1148		N/A					
TRX 90 P/R/S/T/V/W/X/Y/1-6	93-06	CK1151	CKF1151	N/A					CT012SP
TRX 90 EX	07-08	CK1151	CKF1151	N/A					CT012SP
TRX 90 X9/XB/XC	09-14	CK1151	CKF1151	N/A					CT012SP
Astrea Supra NF100	99	CK1151	CKF1151	N/A					CT012SP
Astrea Grand/Supra (Drum model)	97-98	CK1151	CKF1151	N/A					CT012SP
CB 100 N	78-80	CK1119		CSK004					CT012SP
CRF 100 F4/F5/F6/R7/F8/F9/FA/FB/RC	04-12	CK1151	CKF1151	CSK023	DRC049	DRCF049			CT012
H 100 A/SD/SG/SJ	84-92	CK1151	CKF1151	CSK048					CT012SP
XL 100 SZ/SA	78-80	CK1151	CKF1151	CSK048					CT012
XL 100 SB	81-82	CK1151	CKF1151	CSK022					CT012
XR 100 RP/RR/RS/RT/RV/RW/RX/RY/R1/R2/R3	93-03	CK1151	CKF1151	CSK023	DRC049	DRCF049			CT012
XR 100 M5 (HD13) Motard	06	CK1151	CKF1151	TBA					CT012
XZ 100 2 APE-HC07	02	CK1151	CKF1151	N/A					CT012
ATC 110 All models	79-84	CK1156		CSK018					
CRF 110 F	13-17	TBA		N/A					
CT 110 A/B/C/D/K/M	80-88	CK1156		N/A					
CT 110 P	89-04	CK1156		N/A					
CT 110 X	05-09	CK1156		N/A					
ANF 125 3/5/T5/6/T6/7/A Innova	03-11	CK1307		CSK197					
ATC 125 ME	84	CK1156		CSK021					
ATC 125 MG	86	CK1151	CKF1151	CSK048					CT012SP
CA 125 S/T	95-96	CK1252		CSK167					CT012SP
CA 125 Rebel V/W/X	98-00	CK1119		CSK167					CT012SP
CB 125 F (GLR 125 1WHF)	15-16	CK1151		TBA					
CB 125 F (GLR 125 1WHH)	17-18	CK1151		TBA					
CB 125 S/J	75-79	CK1119		CSK041					CT012
CB 125 T/T2	78-80	CK1119		CSK167					CT012
CB 125 TDC/TDE	83-86	CK1119		CSK167					CT012SP
CB 125 TDJ	87-89	CK1252		CSK167					CT012SP
CB 125 RS	83	CK1119		CSK041					CT012SP
CBF 125 6 Stunner	06	CK1151		CSK006					CT012SP
CBF 125 M7 Stunner	07	CK1151		CSK006					CT012SP
CBF 125 M9/MA/MB/MD/ME	09-15	CK1119		CSK166					CT012SP
CBR 125 R4/R5/RS5/RW5/RS6/RW6	04-06	CK1252		CSK193					CT012SP
CBR 125 RW7/RW8/RW9/RWA/RWB/RC/RD/RF	07-16	CK1119		CSK193			SRC119	SRK119	CT012SP
CD 125 TC	78	CK1119		CSK167					CT012SP
CG 125 Cargo	10	TBA		TBA					
CG 125 K1/B/C/E/BR/BR-K/BR-KJ/S/T/W	77-00	CK1119		CSK041					CT012
CG 125 M1/1	01-03	CK1252		CSK041					CT012
CG 125 ES4-ES8	04-08	CK1252		CSK041					CT012
CG 125 Job	05	TBA		TBA					
CLR 125 W City Fly	98-03	CK1119		CSK167					CT012SP
CM 125 CC/CF	82-85	CK1119		CSK009					CT012SP
CT 125 C	85	CK1119		CSK041					CT012
CR 125 M2-M4	76-78	CK1144		CSK036					CT002
CR 125 RZ/RA	79-80	CK1199		CSK031					
CR 125 RB	81	CK1191	CKF1191	CSK031					CT002
CR 125 RC	82	CK1186		CSK031					CT002
CR 125 RD/RE	83-84	CK1190	CKF1190	CSK024	DRC067				CT013
CR 125 RF	85	CK1200		CSK024	DRC068				CT001
CR 125 RG/RH/RJ/RK/RL/RM/RN/RO/RS /RT/RV/RW/RX	86-99	CK1222		CSK024	DRC002				CT001
CR 125 RY/R1/R2/R3	00-03	CK1293	CKF1293	CSK176	DRC262	DRCF262			CT001
CR 125 R4/R5/R6/R7	04-07	CK1293	CKF1293	CSK077	DRC101	DRCF101			CT001
CRF 125 F (Small Wheel F 17 Inch/R 14 Inch)	14-15	CK1325		TBA					
CRF 125 FB (Big Wheel F 19 Inch/R 16 Inch)	14-16	CK1325		TBA					
CRM 125 RL/RM/RN/RO/RS/RV/RX	90-99	CK1160		CSK004					CT013SP

CLUTCH APPLICATIONS

EBC CLUTCH KITS

Make & Model	Year	CK Series #	CKF Series #	Spring Kit #	DRC Series #	DRCF Series #	SRC Series #	SRK Series #	CT Tool #
HONDA Contd.									
LS 125 R	00-	CK1252		CSK105					CT012SP
MBX 125 FE	84-86	CK1180		CSK009					CT013SP
Monkey	19-21	CK1315		CSK197			SRC122	SRK122	CT084SP
MSX 125 D/F Grom (Non ABS)	13-21	CK1315		CSK197			SRC122	SRK122	CT084SP
MSX 125 D/F Grom (ABS)	17-21	CK1315		CSK197			SRC122	SRK122	CT084SP
MTX 125 RWD/E/F/H/L	83-95	CK1180		CSK004					CT013SP
NS 125 FG/FH/RH (5 Plate Clutch)	86-87	CK1153		CSK159					CT013SP
NSR 125 FJ/FK/FL/FM/FN (6 Plate Clutch)	88-92	CK1160		CSK004					CT013SP
NSR 125 RK/RL/RM/RN (6 Plate Clutch)	89-92	CK1160		CSK004					CT013SP
NSR 125 RR/RS/RV/RW/RX/RV/R1 (6 Plate Clutch)	93-01	CK1160		CSK004					CT013SP
NX 125 K/S/F Transcity	89-97	CK1119		CSK167					CT012SP
NXR 125 Bros ES/KS	05	TBA		TBA					
TL 125 S	76	CK1119		CSK004					CT012SP
TRX 125 J	88	CK1151	CKF1151	CSK048					CT012SP
VT 125 CX/CY/C2Y/C1/C21/C3/C4/C7/C8 Shadow	99-08	CK1292		CSK120					
XL 125 K2-K4/SZ/SA	78-79	CK1119		CSK004					CT012SP
XL 125 SB/SC/SZ/SA	79-82	CK1119		CSK031					CT012SP
XL 125 RC/RF/RH	83-86	CK1119		CSK009					CT012SP
XL 125 V1-VA Varadero	01-11	CK1292		CSK120					
XLR 125 RW	98-99	CK1119		CSK166					CT012SP
XR 125 L3/L4/L5/L6/L7/L8	03-08	CK1119		CSK167					CT012SP
CBF 150 5	05	CK1151		CSK006					CT012SP
CBF 150 M5 Unicorn	05	CK1151		CSK006					CT012SP
CBF 150 6 (Spoke Wheels)	06	CK1151		CSK006					CT012SP
CBF 150 M6/M7 Unicorn (Spoke Wheels)	06-07	CK1151		CSK006					CT012SP
CBF 150 M7/M9/MA Unicorn (Cast Wheels)	07-10	CK1151		CSK006					CT012SP
CBF 150 MB/MC Unicorn (Cast Wheels)	11-12	CK1151		CSK006					CT012SP
CBR 150 R	00-03	CK1252		N/A					CT012SP
CRF 150 F3/F4/F5	03-05	CK1304		CSK077	DRC180				CT012SP
CRF 150 F6/F7	06-19	CK1119		CSK006	DRC181				CT012SP
CRF 150 R (Small Wheel F 17 Inch/ R 14 Inch)	07-21	CK1191	CKF1191	CSK134	DRC182	DRCF182			CT002
CRF 150 RB (Big Wheel F 19 Inch/ R 16 Inch)	07-21	CK1191	CKF1191	CSK134	DRC182	DRCF182			CT002
CB 175 All Models		CK1134		CSK008					
CD 175	67-68	CK1123		CSK008					
CD 175 K3/4/5/A4/A5/T4	69-79	CK1134		CSK008					
CD 185 T	78	CK1119		CSK009					CT012SP
ATC 185 A/SB/SC/SD	80-83	CK1151	CKF1151	CSK022					CT012SP
XL 185 SZ/SA/SB	80-81	CK1119		CSK041					CT012SP
XL 185 SB	82	CK1119		CSK065					CT012SP
ATC 200 B/ESE/ESF/SE	81-84	CK1151	CKF1151	CSK022					CT012SP
ATC 200 XD	84	CK1119		CSK024					CT012SP
CB 200/CB 200 B	76-78	CK1134		CSK008					
CBX 200 Strada	97-01	TBA		TBA					
CD 200 TA	79-80	CK1119		CSK024					CT012SP
CM 200 TA/TB	79-80	CK1119		CSK024					CT012SP
CTX 200/CTX 200 A Bushlander	04-05	CK1119		CSK105	DRC091				CT012SP
MTX 200 RWD	83-84	CK1217		CSK004					CT013SP
MTX 200 RWF	85	CK1180		CSK106					CT013SP
TA 200 (TA Shadow)	02-05	CK1252		TBA					CT012SP
TL 200 J/Y	76-78	CK1119		CSK004					CT012SP
TLR 200 D/E/G/H	83-87	CK1119		CSK009					CT012SP
TRX 200 L/M	90-91	CK1119		CSK172	DRC004				CT012SP
TRX 200 D	91-97	CK1119		CSK172	DRC004				CT012SP
TRX 200 SX	86-87	CK1119		CSK172	DRC004				CT012SP
XR 200 R	81-83	CK1119		CSK105	DRC091				CT012SP
XR 200 R	84-85	CK1180		CSK004	DRC060				CT013SP
XR 200 R	86-02	CK1119		CSK105	DRC091				CT012SP
XR 200	80-84	CK1119		CSK105	DRC091				CT012SP
FTR 223 Y/2/A2 (MCS4)	00-02	CK1252		TBA					CT012SP
CRF 230 F4/F5/F6/F7/F8/F9	04-09	CK1304		CSK024	DRC136				CT012SP
CRF 230 L	08-10	CK1252		CSK009	DRC249				CT012SP
CRF 230 M (Supermoto)	09-10	CK1252		CSK009	DRC249				CT012SP
SL 230 V/W/X/1	97-01	CK1252		TBA					CT012SP
XL 230 2 (MC36)	02	CK1252		TBA					CT012SP
ATC 250 RB/RC/RD	81-83	CK1163		CSK031					
ATC 250 RF	85	CK1193	CKF1193	CSK015					CT013SP
ATC 250 RG	86	CK1193	CKF1193	CSK032					CT013SP
ATC 250 ESF/ESG/ESH/ESJ	85-88	CK1194		CSK004					CT013SP
AX-1 (NX 250 J/K/R/R3)	89-94	CK1190	CKF1190	CSK030	DRC051				CT013SP
CB 250 K3-K5	73-75	CK1132		CSK004					CT009
CB 250 G5	75-76	CK1132		CSK004					CT009
CB 250 T/N/NA/NB/NDB/NDC	78-82	CK1140		CSK006					CT013SP
CB 250 RSA/RSD	81-84	CK1153		CSK009					CT013SP
CB 250 N/T/W/X/Y/1/4 Two Fifty	93-05	CK1191	CKF1191	CSK024					CT012SP

CLUTCH APPLICATIONS

EBC CLUTCH KITS

Make & Model	Year	CK Series #	CKF Series #	Spring Kit #	DRC Series #	DRCF Series #	SRC Series #	SRK Series #	CT Tool #
HONDA Contd.									
CB 250 FT/FV/FX/FY/F1 (MC31) Hornet	96-01	CK1235		CSK172			SRC047	SRK047	CT012SP
CBF 250 4 / 6	04-06	CK1190	CKF1190	CSK168					CT013SP
CBR 250 FG/RH/RJ/RK/RK2 (MC14/17/19)	86-89	CK1235		CSK172			SRC047	SRK047	CT012SP
CBR 250 RRL/RRN/RRR (MC22 - 100/105/110)	90-94	CK1235		CSK172			SRC047	SRK047	CT012SP
CBR 250 RB/RC (Non ABS Model)	11-13	CK1313	CKF1313	CSK188					
CBR 250 RAB/RAC (ABS Model)	11-13	CK1313	CKF1313	CSK188					
CBX 250 RSE	84	CK1217		CSK007					CT013SP
CBX 250 Twister		CK1217		CSK007					CT013SP
CBX 250	84-98	TBA		CSK106					
CD 250 UJ/UK	88-92	CK1191	CKF1191	CSK024					CT012SP
CJ 250 T/T2	77	CK1132		CSK031					CT009
CL 250 SC	81	CK1153		CSK009					CT013SP
CM 250 TB	81	CK1140		CSK016					CT013SP
CMX 250 CT/CV/CW/CX	96-00	CK1191	CKF1191	CSK024					CT012SP
CR 250 R/RZ/RA	78-80	CK1163		CSK031					
CR 250 RB/RC	81-82	CK1131		CSK041					CT009
CR 250 RD/RE/RF/RG/RH/RJ/RK	83-89	CK1170	CKF1170	CSK028	DRC003				CT009
CR 250 RL/RM/RN/RP	90-93	CK1247	CKF1247	CSK028	DRC075				CT009
CR 250 RR/RS/RT/RV/RW/RX/R1-R7	94-07	CK1247	CKF1247	CSK178	DRC079	DRCF079			CT009
CRF 250 F	19-21	CK1217			DRC335				
CRF 250 LD/LF	13-16	CK1314	CKF1314	CSK188	DRC277	DRCF277			CT081SP
CRF 250 L (Non ABS)/LA (ABS)	13-21	CK1314	CKF1314	CSK188	DRC277	DRCF277			CT081SP
CRF 250 RL/RLA Rally (non ABS & ABS models)	17-21	CK1314	CKF1314	CSK188	DRC277	DRCF277			CT081SP
CRF 250 ME Supermoto	14-15	CK1314	CKF1314	CSK188	DRC277	DRCF277			CT081SP
CRF 250 R4/R5/R6/R7	04-07	CK1293	CKF1293	CSK176	DRC129	DRCF129			CT001
CRF 250 R8-R9	08-09	CK1305	CKF1305	CSK176	DRC208	DRCF208			CT001
CRF 250 RA	10	CK1293	CKF1293	CSK164	DRC256	DRCF256			CT001
CRF 250 R	11-21	CK1305	CKF1305	CSK215	DRC261	DRCF261			CT001
CRF 250 RE (Limited Road Use)	16	CK1305	CKF1305	CSK215	DRC261	DRCF261			CT001
CRF 250 X4/X5/X6/X7/X8/X9/XB/XC/XD/XF/XG/XH	04-17	CK1305	CKF1305	CSK176	DRC208	DRCF208			CT001
CRF 250 RX	18-21	CK1305	CKF1305	CSK176	DRC208	DRCF208			CT001
CRF 250 XRL (Road Legal)	14-16	CK1305	CKF1305	CSK176	DRC208	DRCF208			CT001
CRM 250 R (RK) MK1 MD24 (100001-1008385)	89-90	CK1193	CKF1193	CSK028	DRC093				CT013
CRM 250 R (RM) MK2 MD24 (1200001-1211634)	91-92	CK1193	CKF1193	CSK028	DRC093				CT013
CRM 250 R (RP/RP-11) MK2/2/MD24 (1300001-)	93	CK1193	CKF1193	CSK028	DRC093				CT013
CRM 250 MK3 RR/RR2 (MD24-10)	94-96	CK1181		CSK028					CT013
CRM 250 Active Radial ARV/ARW (MD32)	97-98	CK1181		TBA					CT013
GB 250 E/H/J/L/P/S/V Custom	84-97	CK1217		CSK007					CT013SP
MXV 250 F (MC92)	83-88	N/A		N/A					
NS 250 FE/RE (MC11-100)	84	CK1218	CKF1218	CSK020					CT013
NS 250 RG (MC11-102)	86	CK1218	CKF1218	CSK020					CT013
NSR 250 RG (MC16-100) Wet Clutch	86	CK1181		CSK024					CT013
NSR 250 R2J (MC18-100)/R4J (MC18-100) Wet Clutch	88	CK1181		CSK024					CT013
NSR 250 R5K/R5K-2 (MC18-110) Wet Clutch	89	CK1181		CSK024					CT013
NSR 250 R6K/R6K-2 (MC18-110) Dry Clutch	89	CK1288		CSK009					CT071SP
NSR 250 R7L (MC21-100)/R7N (MC21-106) Wet Clutch	90	CK1181		CSK024					CT013
NSR 250 R8L-3 (MC21-101)/NSR 250 R9L (MC21-102)									
/NSR 250 R8N/R8N-3 (MC21-106)	90-92	CK1288		CSK167					CT071SP
NSR 250 R9N (MC21-106) Dry Clutch	92	CK1288		CSK167					CT071SP
NSR 250 RR (MC28-100) Wet Clutch	94	CK1181		CSK024					CT013
NSR 250 R2R/R3R (MC28-100)/ R3S (MC28-110)									
/R2T/R3T (MC28-120) Dry Clutch	94	CK1288		CSK167					CT071SP
NX 250 J/K/L (MD21)	87-90	CK1190	CKF1190	CSK065					CT013SP
NX 250 2L/M/P/2P	90-93	CK1190	CKF1190	CSK065					CT013SP
TL 250/TL 250 K1	78-79	CK1131		CSK004					CT009
TLR 250 F	85-	CK1119		CSK105	DRC091				CT012SP
TRX 250 F/G/H	85-87	CK1194		CSK004					CT013SP
TRX 250 RG/RH	86-87	CK1193	CKF1193	CSK032	DRC005				CT013
TRX 250 RJ/RK	88-89	CK1193	CKF1193	CSK045	DRC081				CT013
TRX 250 V/W/X/Y/1/TM2 Re Con (Manual Shift)	97-14	CK1119		CSK172	DRC004				CT012SP
TRX 250 TE2 Re Con ES (Electric Shift)	02-14	CK1119		CSK172	DRC004				CT012SP
TRX 250 X9/XA/XB	09-11	CK1119		CSK172	DRC004				CT012SP
TRX 250 EX1/2/3/4/5/6/7/8	01-08	CK1119		CSK172	DRC004				CT012SP
VT 250 CR Magna		CK1235		CSK172			SRC047	SRK047	CT012SP
VT 250 FD	83	CK1191	CKF1191	CSK023					CT002
VT 250 FL Spada/Castec	88-90	CK1235		CSK172					CT012SP
VTZ 250 H/J/K	86-88	CK1235		CSK172			SRC047	SRK047	CT012SP
VTR 250 W/Y (MC33)/1-7	98-07	CK1235		CSK172			SRC047	SRK047	CT012SP
VTR 250 9	09-10	CK1235		CSK004					CT012SP
XL 250 K3/K4	78-79	CK1131		CSK004					CT009
XL 250 S/SZ/SA	78-80	CK1152		CSK009					CT013SP
XL 250 SB/RC	81-82	CK1153		CSK009					CT013SP
XL 250 RE/RF	84-85	CK1180		CSK004	DRC060				CT013SP
XL 250 Degreee		CK1190	CKF1190	CSK009					CT013SP

CLUTCH APPLICATIONS

EBC CLUTCH KITS

Make & Model	Year	CK Series #	CKF Series #	Spring Kit #	DRC Series #	DRCF Series #	SRC Series #	SRK Series #	CT Tool #
HONDA Contd.									
XLR 250 R Baja (5 Plate) (MD22)		CK1180		CSK004	DRC060				CT013SP
XLR 250 R Baja (6 Plate) (MD22)		CK1190	CKF1190	CSK004					CT013SP
XR 250 SZ/SA	79-80	CK1152		CSK009					CT013SP
XR 250 RB/RC/RD	81-83	CK1153		CSK009					CT013SP
XR 250 RE/RF	84-85	CK1180		CSK004	DRC060				CT013SP
XR 250 RG/RH/RJ/RK/RL/RM/RN/RP/RR/RS	86-95	CK1190	CKF1190	CSK004	DRC044	DRCF044			CT013SP
XR 250 RT/RV/RW/RX/RY/R1/R2/R3/R4	96-04	CK1190	CKF1190	CSK065	DRC084				CT013SP
XR 250 Tornado	05	TBA		TBA					
XR 250 Y/3 (MD30)	00-03	CK1190	CKF1190	CSK065					CT013SP
XR 250 3 / 5 (MD30) Motard	03-05	CK1190	CKF1190	CSK065					CT013SP
XR 250 III Y/3 Baja	00-03	CK1190	CKF1190	CSK065					CT013SP
CB 300 FAF/FAG (ABS)	15	CK1314		TBA					CT081SP
CB 300 R10	10	TBA		TBA					
CBF 300 NA	18-21	CK1314		CSK188	DRC277				CT081SP
CBR 300 RA (ABS)	14-21	CK1314		CSK188	DRC277				CT081SP
TRX 300 FW/J/K/L/T/V/W/X/Y/J/K/L/T/V/W/X/Y	88-00	CK1196		CSK023	DRC006				CT013SP
TRX 300 EX P/R/S/T/V/W/X/Y/1-8	93-08	CK1190	CKF1190	CSK004	DRC044	DRCF044			CT013SP
TRX 300 X9	09	CK1190	CKF1190	CSK004	DRC044	DRCF044			CT013SP
XR 300 R10	10	TBA		TBA					
TRX 350 G/H/J/K/L/M/N	86-93	CK1196		CSK012	DRC006				CT013SP
TRX 350 FMY/1-5 Fourtrax Rancher/4 x 4	00-05	CK1196		CSK048	DRC126				CT013SP
TRX 350 TE/FE Fourtrax Rancher ES/ES 4 x 4 FEY/1-5	00-05	CK1160		CSK048	DRC127				CT013SP
CB 350 SG/SJ	86-88	CK1140		CSK015					CT013SP
CB 350 K4		CK1132		CSK082					CT009
XR 350 RD/RE	83-84	CK1190	CKF1190	CSK004	DRC044	DRCF044			CT013SP
CB/CJ 360 All Models		CK1132		CSK082					CT009
SL 350 K0/K1/K2	69-73	CK1134		CSK082					
CB 400 F/F1/F2	75-79	CK1140		CSK082					CT013SP
CB 400 T/N/NA/NB/NC	78-82	CK1140		CSK047					CT013SP
CB-1 (CB 400 F)	89-90	CK1228		CSK006					CT009SP
CB 400 SF (F2N/F2R) (Super Four) (NC31)	92-95	CK1228		CSK006					CT009SP
CB 400 SF (F2V/F3T) (Super Four) (NC31)	96-97	CK1228		CSK006					CT009SP
CB 400 SF (F3V) Superfour (NC31)	97	CK1228		CSK006					CT009SP
CB 400 Four V/V-II/W/W-II (NC36)	97-98	CK1228		TBA					CT009SP
CB 400 SFX/SFY/SF1/SF2/SF3/SF4/5/S5 (NC39) Super Four	99-05	CK1265		TBA					CT009SP
CB 400 SS (SS2-NC41)	01-05	CK1181		CSK032					CT013
CBR 400 RG/RHYA (NC23 100/101)	86	CK1228		TBA					CT009SP
CBR 400 RRJ/RRK (NC23 102/109)	92-93	CK1228		CSK006					CT009SP
CBR 400 RRL/RRN/RRR (NC29)	90-94	CK1181		CSK033			SRC049	SRK049	CT013SP
CL 400 (NC38)	97-03	CK1181		CSK032					CT013
FL 400 R/RK/RL Pilot	89-93	CK1234		TBA					
NS 400 RF/RG	85-87	CK1218	CKF1218	CSK167					CT013
NT 400 Bros NC 25		CK1160		CSK028			SRC061	SRK061	CT013SP
NV 400 CJ/CK (Steed)	92-93	CK1160		CSK028			SRC061	SRK061	CT013SP
NV 400 CS/CV Steed	95-97	CK1160		CSK028			SRC061	SRK061	CT013SP
NV 400 DCY/DC1/DC2 (NC40) Shadow Slasher	00-02	CK1160		CSK028			SRC061	SRK061	CT013SP
TRX 400 FWS/T/V/W/X/Y	95-00	CK1196		CSK023	DRC006				CT013SP
TRX 400 EX/EY/EXX/EXY/EX1-EX8	99-08	CK1193	CKF1193	CSK073	DRC100	DRCF100			CT013
TRX 400 X9	09	CK1193	CKF1193	CSK073	DRC100	DRCF100			CT013
RVF 400 RR/RT/RR-II/RT-II (NC35 -100/110)	94-96	CK1289		N/A					CT002
VF 400 FD	83-85	CK1165		CSK009					CT002
VFR 400 R3K/R3L/R3M/R3N (NC30)	89-92	CK1250		CSK904			SRC063	SRK063	CT002
VFR 400 ZG/ZH/RG/RG-YA (NC21)	85-86	CK1177		CSK006					CT002
VFR 400 RH2/RJ (NC24)	87-88	CK1177		CSK009					CT002
XL 400 R	82	N/A		N/A					
XR 400 RT	96	CK1193	CKF1193	CSK028	DRC093				CT013
XR 400 RV/RW/RX/RY/R1-R5	97-05	CK1193	CKF1193	CSK033	DRC106				CT013
VRX 400 T (NC33)	96	CK1160		CSK033					CT013SP
XR 400 R5/R6 Motard (NC38E)	05-06	CK1181		CSK178	DRC266				CT013
XR 400 M Supermotard (ND08/NC38E)	06-08	CK1181		CSK178	DRC266				CT013
TRX 420 TM7/TM8/TM9/TMA/TMB	07-11	CK1154		CSK154	DRC239				CT013SP
TRX 420 FE7/FE8/FE9/FEA/FEB 4WD Fourtrax ES	07-11	CK1196		CSK155	DRC238				CT013SP
TRX 420 FM7/FM8/FM9/FMA/FMB 4WD Fourtrax	07-11	CK1154		CSK154	DRC239				CT013SP
TRX 420 FPMP/FPMA/FPMB Fourtrax 4WD - Power Steering	09-11	CK1154		CSK154	DRC239				CT013SP
TRX 420 TE7/TE8/TE9 Fourtrax ES 2WD	07-09	CK1196		CSK155	DRC238				CT013SP
CB 450 DX-K	89	CK1140		CSK047					CT013SP
CR 450 RB	81	CK1131		CSK041					CT009
CRF 450 R2/R3	02-03	CK1247	CKF1247	CSK178	DRC112				CT009
CRF 450 R4/R5 (6 Spring Type)	04-05	CK1247	CKF1247	CSK120	DRC148	DRCF148			CT009
CRF 450 R6/R7/R8 (6 Spring Type)	06-08	CK1247	CKF1247	CSK178	DRC112				CT009
CRF 450 R9/RA (4 Spring type)	09-10	CK1247	CKF1247	CSK157	DRC244	DRCF244			CT009
CRF 450 RB/RC	11-12	CK3433	CKF3433	CSK174	DRC259	DRCF259			CT009

CLUTCH APPLICATIONS

EBC CLUTCH KITS

Make & Model	Year	CK Series #	CKF Series #	Spring Kit #	DRC Series #	DRCF Series #	SRC Series #	SRK Series #	CT Tool #
HONDA Contd.									
CRF 450 R	13	CK3433	CKF3433	CSK201	DRC276	DRCF276			CT009
CRF 450 RD/RE/RF/RG (6 Spring Type)	14-16	CK3433	CKF3433	CSK227	DRC301	DRCF301			CT009
CRF 450 R AC (6 Spring Type)	17-20	CK1317	CKF1317	CSK227	DRC299	DRCF299			CT092
CRF 450 RE (Limited Road Use)	16	CK3433	CKF3433	CSK201	DRC276	DRCF276			CT009
CRF 450 X5/X6/X7/X8/X9/XB/XC/XD/XF/XG/XH	05-17	CK1247	CKF1247	CSK120	DRC148	DRCF148			CT009
CRF 450 XRL (Road Legal)	14-16	CK1247	CKF1247	CSK120	DRC148	DRCF148			CT009
CRF 450 X AC (18 inch rear wheel)	18-21	CK1317	CKF1317	CSK227	DRC299	DRCF299			CT092
CRF 450 L AC (18 inch rear wheel)	18-21	CK1317	CKF1317	CSK277	DRC299	DRCF299			CT092
CRF 450 RX AC (18 Inch Rear Wheel)	17-21	CK1317	CKF1317	CSK227	DRC299	DRCF299			CT092
CMX 450 CH/CJ Rebel	02	CK1140		CSK015					CT013SP
TRX 450 ESW/ESX/ESY/ES1	98-01	CK1196		CKS023	DRC006				CT013SP
TRX 450 R4/R5/R6/ER6/R7/ER7/R8/ER8/R9/ER9	04-09	CK1302	CKF1302	CSK178	DRC131	DRCF131			CT009
CR 480 RC	82	CK1131		CSK024					CT009
CR 480 RD	83	CK1170	CKF1170	CSK028	DRC003				CT009
CB 500 FAD/FAE/FAF/FAG (ABS)	13-16	TBA		CSK033					
CB 500 FD/FE/FF (Non ABS)	13-16	TBA		CSK033					
CB 500 K1/K2 (Four)	75-77	CK1135		CSK003					CT009
CB 500 K3 (Four)	78	CK1146		CSK009					CT009SP
CB 500 T (Twin)	75-77	CK1130		CSK015					CT031
CB 500 R/T/V/W/SW/X/SX/Y/SY/2/S2 (Twin)	94-03	CK1181		CSK033					CT013SP
CB 500 F (Non ABS)	13-21	CK1323		CSK033					CT082SP
CB 500 FA (ABS)	13-21	CK1323		CSK033					CT082SP
CB 500 X (Non ABS)	13-21	CK1323		CSK033					CT082SP
CB 500 XA (ABS)	13-21	CK1323		CSK033					CT082SP
CBF 500 4/A4/A5/A6/A7	04-07	CK1181		CSK033					CT013SP
CBR 500 FH/FJ/FK/FL (Four)	87-90	CK1228		CSK012			SRC016	SRK016	CT009SP
CBR 500 R (Non ABS)	13-21	CK1323		CSK033					
CBR 500 RA (ABS)	13-21	CK1323		CSK033					
CR 500 RE/RG/RH/RJ/RK	84-89	CK1170	CKF1170	CSK028	DRC003				CT009
CR 500 RL/RM/RN/RP/RR/R8/RT/RV/RW/RX/RY/R1	90-01	CK1247	CKF1247	CSK028	DRC075				CT009
CX 500 CA/CB/Z/A/B/EC	79-85	CK1146		CSK041					CT009SP
CX 500 Turbo	82	CK1159		CSK010					CT053SP
FT 500 C	82	CK1154		CSK248					CT013SP
GL 500 DC	82	CK1146		CSK041					CT009SP
NX 500 J/K/L/M/N/P/R/S/T/V/W/X Dominator	88-99	CK1170	CKF1170	CSK016	DRC054	DRCF054			CT009
TRX 500 FE5/FE6/FE7/FE8/FE9/FEA/FAB									
Fourtrax Foreman 4WD/ES	05-11	CK1154		CSK117	DRC236				CT013SP
TRX 500 FEC Fourtrax Foreman ES 2 / 4 WD	12	CK1154		CSK029	DRC270				CT013SP
TRX 500 FM5/FM6/FM7/FM8/FM9/FMA/FMB									
Fourtrax Foreman 4 x 4	05-11	CK1154		CSK153	DRC237				CT013SP
TRX 500 FMC Fourtrax Foreman S 2 / 4 WD	12	CK1154		CSK079	DRC271				CT013SP
TRX 500 TM5/TM6 Fourtrax Foreman	05-06	CK1154		CSK153	DRC237				CT013SP
TRX 500 FPE8/FPE9/FPEA/FPEB Fourtrax Foreman									
4 x 4 ES/EPS	08-11	CK1154		CSK117	DRC236				CT013SP
TRX 500 FPEC Fourtrax Foreman S 2 / 4 WD	12	CK1154		CSK029	DRC270				CT013SP
VF 500 FE/F2E/FF/F2F	84-85	CK1177		CSK009					CT002
VT 500 ED/EF	83-85	CK1160		N/A					CT013SP
XBR 500 F/G/H/SH/SJ	85-89	CK1219		CSK016					CT009
XL 500 SZ/SB/RC	80-82	CK1140		CSK248					CT013SP
XR 500 SZ/SA/RB/RC	79-82	CK1154		CSK248					CT013SP
XR 500 RD/RE	84-85	CK1170	CKF1170	CSK248					CT009
CB 550 F/F1/F2/K3	78-80	CK1146		CSK009					CT009SP
CBX 550 FC/F2C/FD/F2D	82-85	CK1228		CSK026			SRC048	SRK048	CT009SP
CB 600 Hornet FW/FX/FY/F2-Y/F1/F21/F2/F22 /F3/F4/F5/F6	98-06	CK1206	CKF1206	CSK045			SRC019	SRK019	CT014SP
CB 600 F7/F8/F9/FA/FB/FC Hornet	07-13	CK1218	CKF1218	CSK101			SRC075	SRK075	CT014
CB 600 FA7/FA8/FA9/FAA/FAB/FAC Hornet (ABS)	07-13	CK1218	CKF1218	CSK101			SRC075	SRK075	CT014
CBF 600 N4/N5/N6	04-06	CK1206	CKF1206	CSK045			SRC019	SRK019	CT014SP
CBF 600 N8/N9/NA	08-11	CK1218	CKF1218	CSK101			SRC075	SRK075	CT014
CBF 600 NA4/NA5/NA6	04-06	CK1206	CKF1206	CSK045			SRC019	SRK019	CT014SP
CBF 600 NA8/NA9/NAA	08-11	CK1218	CKF1218	CSK101			SRC075	SRK075	CT014
CBF 600 S4/S5/S6	04-06	CK1206	CKF1206	CSK045			SRC019	SRK019	CT014SP
CBF 600 S8/S9	08-09	CK1218	CKF1218	CSK101			SRC075	SRK075	CT014
CBF 600 SA4/SA5/SA6	04-06	CK1206	CKF1206	CSK045			SRC019	SRK019	CT014SP
CBF 600 SA8/SA9/SAA	08-12	CK1218	CKF1218	CSK101			SRC075	SRK075	CT014
CBR 600 FH/FJ	87-88	CK1228		CSK012			SRC016	SRK016	CT009SP
CBR 600 FK/FL	89-90	CK1228		CSK047			SRC042	SRK042	CT009SP
CBR 600 FM/FN/FP/FR/FS/FT/FV/FW	91-98	CK1206	CKF1206	CSK045			SRC019	SRK019	CT014SP
CBR 600 FX/FY (CARB MODEL)	99-00	CK1193	CKF1193	CSK029			SRC066	SRK066	CT014
CBR 600 F1/F2/F3/F4/F5/F6 (CARB MODEL)	01-06	CK1218	CKF1218	CSK178			SRC143	SRK143	CT014
CBR 600 FR1/FR2 (ROSSI INJECTION MODEL)	01-02	CK1218	CKF1218	CSK178			SRC143	SRK143	CT014
CBR 600 FS1/FS2 (CBR600 S INJECTION MODEL)	01-02	CK1218	CKF1218	CSK178			SRC143	SRK143	CT014
CBR 600 FB/FC	11-12	CK1218	CKF1218	TBA			SRC057	SRK057	CT014
CBR 600 FAB/FAC	11-12	CK1218	CKF1218	TBA			SRC057	SRK057	CT014

CLUTCH APPLICATIONS

EBC CLUTCH KITS

Make & Model	Year	CK Series #	CKF Series #	Spring Kit #	DRC Series #	DRCF Series #	SRC Series #	SRK Series #	CT Tool #
HONDA Contd.									
CBR 600 RR3/RR4/RR5/RR6/RR7/RR8/RR9/RRA									
/RRB/RRC/RRD	03-19	CK1218	CKF1218	CSK101			SRC075	SRK075	CT014
CBR 600 RR Hannspree	08	CK1218	CKF1218	CSK101			SRC075	SRK075	CT014
CBR 600 RR	09-21	CK1218	CKF1218	CSK101			SRC075	SRK075	CT014
NTV 600 J/K/M	88-91	CK1230		CSK032					CT013SP
VT 600 CN/CR/CS/CT/CV/CW/CX	92-00	CK1181		CSK033					CT013SP
XL 600 RD/LD/RE/LE/RF/RG/RH	83-87	CK1170	CKF1170	CSK016	DRC092				CT009
XL 600 LMF/RMG/LMH	85-87	CK1170	CKF1170	CSK016	DRC054	DRCF054			CT009
XL 600 VH/VJ/VK/VM/VN/VP/VR/VT/VV									
/VV/VX Transalp	87-99	CK1181		CSK033	DRC053				CT013SP
XR 600 RF/RG/RH/RJ/RK/RL/RM/VP/RR/RS/RT									
/RV/RW/RX/RV	84-00	CK1170	CKF1170	CSK016	DRC054	DRCF054			CT009
FMX 650 5 / 6	05-08	CK1170	CKF1170	CSK016	DRC054	DRCF054			CT009
FX 650 X/Y Vigor	99-03	CK1170	CKF1170	CSK016	DRC054	DRCF054			CT009
NT 650 J/K/L (Bros)	88-92	CK1230		CSK028			SRC064	SRK064	CT013SP
NTV 650 J/K/L/M/P/S/T/V	88-97	CK1230		CSK033			SRC062	SRK062	CT013SP
NT 650 VW/VX/VY/V1-V5 Deauville	98-05	CK1230		CSK033			SRC062	SRK062	CT013SP
NX 650 J/K/L/M/N/P/R/S/T/V/W/X	88-02	CK1170	CKF1170	CSK016	DRC054	DRCF054			CT009
CB 650 F (Non ABS)	14-21	CK1181		CSK246			SRC149	SRK149	CT014
CB 650 FA (ABS)	14-20	CK1181		CSK246			SRC149	SRK149	CT014
CB 650 Z/B/SCC	79-82	CK1147		CSK009					
CBR 650 F	14-21	CK1181		CSK246			SRC149	SRK149	CT014
CBR 650 FA ABS	14-21	CK1181		CSK246			SRC149	SRK149	CT014
CX 650 ED	83-85	CK1147		CSK012					
CX 650 TD Turbo	83	CK1159		CSK010					CT053SP
GL 650 D2-E	84	CK1147		CSK012					
SLR 650 V/W	97-98	CK1170	CKF1170	CSK016	DRC054	DRCF054			CT009
XL 650 VY/V1/V2/V3/V4/V5/V6/V7	00-07	CK1230		CSK028					CT013SP
XR 650 L	93-12	CK1170	CKF1170	CSK016	DRC054	DRCF054			CT009
XR 650 RY/R1-R7	00-07	CK1295		CSK045	DRC179				CT009
XRV 650 J/K Africa Twin	88-89	CK1230		CSK028			SRC064	SRK064	CT013SP
NC 700 SC/SD (Manual Gearbox)	12-13	CK1230		CSK033					CT013SP
NC 700 XC/XD (Manual Gearbox)	12-17	CK1230		CSK033					CT013SP
NT 700 V6/VA7/V7/V8/VA8/VA/VAA Deauville	06-13	CK1230		CSK033			SRC062	SRK062	CT013SP
TRX 700 XX8/XX9/XXB	08-11	CK1302	CKF1302	CSK178	DRC240	DRCF240			CT009
XL 700 V8/V9/VA (Transalp/2 Piston Front Caliper									
/ABS on Rear Disc)	08-11	CK1230		CSK009					CT013SP
XL 700 VA8/VA9/VAA (Transalp/3 Piston Front Caliper									
/ABS Front & Rear Wheels)	08-11	CK1230		CSK009					CT013SP
CB 750/CB 750 K1 (Up to E.No:-1056079)	69-70	CK1223		CSK009					
CB 750 K1 (From E.No:-1056080)	70-71	CK1133		CSK009					CT076SP
CB 750 K2/K3/K4/K5	71-75	CK1133		CSK004					CT076SP
CB 750 KZ	80	CK1149		CSK041					CT078SP
CB 750 F/F1	76-77	CK1220		CSK082					
CB 750 K6/K7/F2	76-78	CK1145		CSK082					CT076SP
CB 750 FA/FB/F2C	79-82	CK1149		CSK041					CT078SP
CB 750 F2N/F2R/F2S/F2T/F2W/F2X/F2Y/F21	92-02	CK1265		CSK006					CT009SP
CBR 750 FH/FJ (Superaero)	87-88	CK1287		CSK027					
CBX 750 FE	84-85	CK1166		N/A					CT031
NC 750 S	14-15	CK1230		CSK033			SRC062	SRK062	CT013SP
NC 750 S (ABS)	14-18	CK1230		CSK033			SRC062	SRK062	CT013SP
NC 750 X	14-15	CK1230		CSK033			SRC062	SRK062	CT013SP
NC 750 X (ABS)	14-19	CK1230		CSK033			SRC062	SRK062	CT013SP
NR 750 N	92	CK1257		N/A					
VF 750 FD/FE	83-85	CK1167		CSK900			SRC002	SRK002	CT031
VF 750 SC (V45 Sabre)	82	CK1166		CSK077					CT031
VF 750 CH	87	CK1166		CSK077					CT031
VF 750 CP/CR/CS/CT/CV	93-97	CK1206	CKF1206	CSK028					CT014
VFR 750 FG/FH/FJ/FK/FL/FM/FN/FP/FR/FS/FT/FV	86-97	CK1206	CKF1206	CSK028			SRC003	SRK003	CT014
VFR 750 RJ/RK/RL (RC30)	88-92	CK1229		CSK901			SRC005	SRK005	CT014
VT 750 C Shadow	83	CK1166		N/A					CT031
VT 750 CV/C2V/CW/C2W/CX/C2X/CY/C2Y/C1/C1Y									
/C4/C5/C6/C7/C8	97-09	CK1230		CSK028			SRC064	SRK064	CT013SP
VT 750 C2BA/C2BB/C2BC/C2BE Shadow Black Spirit	10-15	CK1230		TBA					CT013SP
VT 750 C2SA/C2SB Shadow (3 Piston Caliper									
/17 Inch Front Wheel/Rear Disc)	10-12	CK1230		TBA					CT013SP
VT 750 DC1/DC2 Black Widow	01-04	CK1230		CSK028					CT013SP
VT 750 DC7/DC8 Shadow Spirit	07-09	CK1230		CSK028					CT013SP
VT 750 S (VT 750 SA/SB)	10-12	CK1230		CSK028			SRC064	SRK064	CT013SP
RVF 750 RR-R/RR-S	94-98	CK1257		N/A					
XLV 750 R (RD/RF)	83-88	CK1166		CSK077					CT031
XRV 750 L/M/N/P/R/S/T/V/W/X/Y	90-03	CK1167		CSK006					CT009
PC 800 Pacific Coast	89-97	CK1167		CSK030					CT009
VFR 800 Fi-W/Fi-X	98-99	CK1206	CKF1206	CSK135					CT014

CLUTCH APPLICATIONS

EBC CLUTCH KITS

Make & Model	Year	CK Series #	CKF Series #	Spring Kit #	DRC Series #	DRCF Series #	SRC Series #	SRK Series #	CT Tool #
HONDA Contd.									
VFR 800 Fi-Y/Fi-1	00-01	CK1253		CSK101					CT014
VFR 800 2/3/4/5/6/8/9	02-09	CK1218	CKF1218	CSK101					CT014
VFR 800 A2/A3/A4/A5/A6/A8/A9	02-13	CK1218	CKF1218	CSK101					CT014
VFR 800 F (ABS Model)	14-16	CK1218	CKF1218	CSK101			SRC075	SRK075	CT014
VFR 800 XA (Crossrunner/ABS)	11-13	CK1218	CKF1218	CSK101			SRC075	SRK075	CT014
VFR 800 XA (Crossrunner/ABS)	15-16	CK1218	CKF1218	CSK101			SRC075	SRK075	CT014
VFR 800 XC (Crossrunner)	12-14	TBA		TBA					
VFR 800 X (Crossrunner)	15	TBA		TBA					
CB 900 FZ/FA/FB/F2B/F2C/FD/F2D	80-85	CK1149		CSK167					CT078SP
CB 900 F2/F3/F4/F5/F6/F7 Hornet	02-07	CK1218	CKF1218	CSK045			SRC057	SRK057	CT014
CBR 900 RRN/RRP/RRR/RRS (893cc)	92-95	CK1206	CKF1206	CSK028			SRC094	SRK094	CT014
CBR 900 RRT/RRV (918cc)	96-97	CK1284		CSK045			SRC055	SRK055	CT014
CBR 900 RRW/RRX (918cc)	98-99	CK1218	CKF1218	CSK045			SRC057	SRK057	CT014
CBR 900 RRY/RR1 (929cc Fireblade)	00-01	CK1206	CKF1206	CSK045			SRC019	SRK100	CT014
CBR 900 RR2/RR3 (954cc Fireblade)	02-03	CK1206	CKF1206	CSK045			SRC019	SRK100	CT014
CB 1000 FP/FR/FS/FT/FV	93-97	CK1248	CKF1248	CSK029			SRC004	SRK004	CT009
CB 1000 R9/RA/RB/RC/RD/RE/RF (Non ABS Model)	09-15	CK1303		CSK112			SRC080	SRK080	CT009
CB 1000 RA9/RAA/RAB/RAC/RAE/RAF/RAG (ABS Model)	09-16	CK1303		CSK112			SRC080	SRK080	CT009
CBF 1000 6/7/8/9/A (2 Piston Front Caliper/Non ABS)	06-11	CK1303		CSK090					CT009
CBF 1000 A A6/A7/A8/A9/AA (3 Piston Front Caliper/ABS)	06-11	CK1303		CSK090					CT00
CBF 1000 S S7/S8/S9/SA (3 Piston Front Caliper/ABS)	07-10	CK1303		CSK090					CT009
CBF 1000 T T7/T8/T9/TA (GT) (3 Piston Front Caliper/ABS)	07-16	CK1303		CSK090					CT009
CBF 1000 F FA (2 Piston Front Caliper/Non ABS)	10-11	CK1303		CSK090					CT009
CBF 1000 FA FAA (3 Piston Front Caliper/ABS)	10-15	CK1303		CSK090					CT009
CBF 1000 FS FSA (3 Piston Front Caliper/ABS)	10-11	CK1303		CSK090					CT009
CBF 1000 FT FTA (3 Piston Front Caliper/ABS)	10-11	CK1303		CSK090					CT009
CBR 1000 FH/FJ/FK/FL/FM/FN/FP/FR/FS/FT/FV/FW/FX	87-99	CK1248	CKF1248	CSK029			SRC004	SRK004	CT009
CBR 1000 RR Fireblade (Coil Spring Type Clutch)	17-19	TBA		TBA			TBA	TBA	TBA
CBR 1000 RR Fireblade (Diaphragm Type Clutch)	08-16	CK1312	CKF1312	CSK905			SRC095	SRK095	CT043SP
(CBR 1000 SAE/SAF/SAG)	14-16	CK1312	CKF1312	CSK905			SRC095	SRK095	CT043SP
CBR 1000 RR-SP ABS - TT Edition	16	CK1312	CKF1312	CSK905			SRC095	SRK095	CT043SP
CBX 1000 Z	79	CK1183		CSK167					CT066SP
CBX 1000 B/C	80-81	CK1183		CSK010					CT066SP
CRF 1000 LAG (Manual Clutch/ABS)	16-21	CK1319	CKF1319	CSK254	DRC306	DRCF306			CT009
CRF 1000 L (Manual Clutch/Non ABS)	16	CK1319	CKF1319	CSK254	DRC306	DRCF306			CT009
GL 1000 K1 (Up to E.No.: -2002383)	77	CK1221		CSK010					
GL 1000 K1/K2 (From E.No.: -2002384)	77-78	CK1143		CSK010					CT076SP
RC 213 V-S (1000cc)	15	TBA		TBA					
VF 1000 FE/FF/RE/RF/RG/F2F	84-86	CK1176		N/A					CT031
VTR 1000 FV/FW/FX/FY/F1-F6 Firestorm	97-06	CK1290		CSK206			SRC060	SRK060	CT009
VTR 1000 SPY/SP1 (SC45)	00-01	CK1291		CSK043					CT021
VTR 1000 SP-2/SP-3/SP-4/SP-5/SP-6	02-07	CK1300		CSK043					
XL 1000 VX/VY/V1/V2 Varadero - Non ABS Model /10 Plate Kit	99-02	CK1290		CSK206	DRC267				CT009
XL 1000 V3/V4/V5/V6/V7/V8/V9/VA/VB Varadero - Non ABS Model/8 Plate Kit	03-11	CK1257		CSK138	DRC268				CT009
XL 1000 V6/VA6/VA7/VA8/VA9VAA/VAB Varadero - ABS Model/8 Plate Kit	06-11	CK1257		CSK138	DRC268				CT009
CB 1100 RB2/RC2	80-81	CK1149		CSK009					CT078SP
CB 1100 RD2	82	CK1149		CSK207					CT078SP
CB 1100 SFY/SF1 X11	00-03	CK1291		CSK043					CT021
CB 1100 AD (Cast Wheels/3 Piston Caliper)	13	CK1257		CSK070					CT009
CB 1100 AE (Cast Wheels/3 Piston Caliper)	14	CK1257		CSK070					CT009
CB 1100 EX (Spoke Wheels/4 Piston Caliper)	14-16	CK1257		CSK070					
CB 1100 EX	16-21	CK1332		CSK259			SRC161	SRK161	
CBR 1100 XXV/XXW Blackbird	97-98	CK1286		CSK070					CT021
CBR 1100 XXX/XXY/XX1-XX6 Blackbird	99-08	CK1291		CSK043					CT021
CRF 1100 Manual Clutch	19-21	CK1319	CKF1319	CSK254	DRC306	DRCF306			CT009
GL 1100 A/DA/B/IB/DB (SC02)	80-81	CK1159		CSK010					
ST 1100 L/M/N/P/R/S/T/V/W/X/Y/1/2 (Pan European - Non ABS Model)	90-02	CK1264		CSK033			SRC070	SRK070	CT056SP
ST 1100 AN/AP/AR/AS (Pan European ABS Model)	92-95	CK1264		CSK033			SRC070	SRK070	CT056SP
ST 1100 AT/AV/AW/AX/AY/A1/A2 (Pan European ABS Model)	96-02	CK1264		CSK033			SRC070	SRK070	CT056SP
VT 1100 CH/CJ/CN/CP Shadow	87-93	CK1239		N/A					CT031
VT 1100 CR/CS/CT/CV/CW Shadow	94-98	CK1239		N/A					CT032
VT 1100 C2 (S/T/V)	95-97	CK1176		TBA					CT009
VT 1100 C2 (W/X/Y/1/2/3/4/5)	98-05	CK1176		TBA					CT009
VT 1100 C3 (W/X/Y)	98-00	CK1176		TBA					CT031
GL 1200 AE/DE/AF	84-85	CK1210		N/A					CT053SP

CLUTCH APPLICATIONS

EBC CLUTCH KITS

Make & Model	Year	CK Series #	CKF Series #	Spring Kit #	DRC Series #	DRCF Series #	SRC Series #	SRK Series #	CT Tool #
HONDA Contd.									
GL 1200 DH/AH/AG/DG	86-87	CK1224		N/A					
VFR 1200 FA (Manual Gearbox Model)	10-15	CK1312	CKF1312	CSK907			SRC103	SRK103	CT043SP
VFR 1200 XA Crosstourer Manual G/Box	12-15	N/A		N/A	N/A		N/A	N/A	
CB 1300 FW/FX/FY/F1 (SC40)	98-01	CK1299		TBA					CT009
CB 1300 DCV/DCW/DCX/DCY (SC38)	97-00	CK1290		CSK070					CT009
CB 1300 F3/F13	03-04	CK1257		CSK113					CT009
CB 1300 5/6/7/8/9 (Superfour)	05-09	CK1257		CSK113					CT009
CB 1300 A5-A8 (Superfour ABS)	05-08	CK1257		CSK113					CT009
CB 1300 SA5/SA6/SA7/SA8 Super Bol-Dor	05-08	CK1257		CSK113					CT009
CTX 1300 AE	14-15	TBA		TBA					
ST 1300 2/3/4/6/8/9 Pan European - Non ABS	02-09	CK1297		CSK175					CT021
ST 1300 A2/A3/A4/A6/A8/A9/AA									
Pan European - ABS Model	02-15	CK1297		CSK175					CT021
VT 1300 CTA Interstate	11-13	CK1298		CSK090					
VT 1300 CXA (Fury/Chopper/Non ABS									
/9 Spoke Cast Wheel)	10-12	CK1298		CSK090					CT021
VT 1300 CXAA (Fury/Chopper/ABS									
/9 Spoke Cast Wheel)	10-11	CK1298		CSK090					CT021
VTX 1300 S3/S4/S5/S6/S7/S8	03-08	CK1298		CSK090					CT021
GL 1500 J/K/L/SEM/SEN/SEP/SER/SES/SEX Goldwing	88-96	CK1285		N/A					CT068SP
GL 1500 CV/CW/CX/CY/C1/C2 F6C	97-03	CK1285		N/A					CT068SP
GL 1500 SEV/SEW/SEX/SEY Goldwing	97-00	CK1285		N/A					CT068SP
F6B Goldwing Bagger (GLF6BAE)	13-15	TBA		N/A					
F6C Goldwing (4 Piston Caliper) GLF6CAE	14-15	TBA		N/A					
GL 1800 A1-A5 Goldwing	01-05	CK1297		N/A					CT073
GL 1800 5-9/A Goldwing	06-15	CK1297		N/A					CT073
VTX 1800 C2/C3/C4/C15/C16/C17	02-08	CK1298		CSK090					CT021
HONDA-DALLARA									
XR 125 SM	04	CK1119		CSK004					CT012SP
XR 250 R	04	CK1190	CKF1190	CSK065	DRC084				CT013SP
XR 250 RM	04	CK1190	CKF1190	CSK065	DRC084				CT013SP
XR 400/440 R	04	CK1193	CKF1193	CSK033	DRC106				CT013
XR 400/440 SM	04	CK1193	CKF1193	CSK033	DRC106				CT013
XR 650 R	04	CK1295		CSK045					CT009
KAWASAKI									
AE 50 A1/A2	81-84	CK4442		CSK018					
AR 50 A1/C2-C10	81-97	CK4442		CSK018					
KDX 50 A1/A2/A3/A6F	03-06	CK3366		N/A					
KSRI (KMX 50 B1/B2)	90-91	CK4442		CSK044					
KX 60 A1/A2/B1-B19	83-03	CK4438	CKF4438	CSK018	DRC007				CT070SP
KX 65	00-21	CK4438	CKF4438	CSK040	DRC098	DRCF098			CT070SP
AE 80 A1/B1	81-83	CK4440		CSK018					
AR 80 A1/C1-C8	81-91	CK4440		CSK018					
KSRII (KMX 80 B1/B2)	90-91	CK4440		CSK044					
KX 80 E1/E2	83-84	CK4438	CKF4438	CSK040					CT070SP
KX 80 E3/G1/G2/J1/J2	85-87	CK4468		CSK034	DRC008				CT070SP
KX 80 L1	88	CK4477		CSK035	DRC009				
KX 80 L2/L3/R1-R7	89-97	CK4478		CSK035	DRC010				
KX 80 W1/W2/W3	98-00	CK4453	CKF4453	CSK041	DRC045	DRCF045			CT002
KX 85 Smal Wheel (17" Front/14" Rear)	01-21	CK4453	CKF4453	CSK041	DRC045	DRCF045			CT002
KX 85 Big Wheel (19" Front/16" Rear)	01-21	CK4453	CKF4453	CSK041	DRC045	DRCF045			CT002
KC 100 C1-C4	81-83	CK4440		CSK019					
KE 100 A8-A10	79-81	CK4440		CSK019					
KE 100 B1-B15	82-98	CK4440		CSK040					
KH 100 A2-A4/G2-G8	78-87	CK4440		CSK019					
KM 100 A4/A6	79-80	CK4440		CSK019					
KX 100 N1	88	CK4477		CSK035	DRC009				
KX 100 A1/A2/B1-B7	89-97	CK4478		CSK035	DRC010				
KX 100 C1/C2/C3	98-00	CK4453	CKF4453	CSK041	DRC045	DRCF045			CT002
KLF 110 B1/B2	87-88	CK4463		N/A					
KLX 110	02-20	CK4438	CKF4438	CSK040	DRC098	DRCF098			CT070SP
AR 125 A1A/A1-A7/B1-B8	83-94	CK4453	CKF4453	CSK041					CT002
BN 125 A1-A5/A6F/A7F Eliminator	98-07	CK4511		CSK041					
KDX 125 A1/A2/B1/B2	90-94	CK4489		CSK001					CT042
KE 125 A7-A12	80-85	CK4411		CSK001					CT058
KH 125 A1-A4	77-81	CK4411		CSK001					CT058
KH 125 K1	82	CK4440		CSK040					
KH 125 K2-K10	82-98	CK4438	CKF4438	CSK040					CT070SP
KH 125-L1 (KH 125 EX)	83	CK4438	CKF4438	CSK040					CT070SP
KLX 125 A1/A2/A3/A6F	03-06	CK3318	CKF3318	CSK034					CT011
KLX 125 L (B1/B2/B3/B6F)	03-06	CK3318	CKF3318	CSK034					CT011
KLX 125	10-20	CK4522		CSK142	DRC211				CT012SP

EBC CLUTCH KITS

Make & Model	Year	CK Series #	CKF Series #	Spring Kit #	DRC Series #	DRCF Series #	SRC Series #	SRK Series #	CT Tool #
KAWASAKI Contd.									
KLX 125 DAF/DBF/DCF/DEF (D-Tracker)	10-14	CK4522		CSK142	DRC211				CT012SP
KMX 125 A1/A2	86-87	CK4453	CKF4453	CSK031					CT002
KMX 125 A3/A4/A5	88-89	CK4486		CSK031					
KMX 125 B1/B2									
(From E/No.- MX 125 AE 000001-013436)	86-87	CK4453	CKF4453	CSK031					CT002
KMX 125 B2-B12 (From E/No.- MX AE 013437)	87-03	CK4486		CSK031					CT002
KX 125 B1	82	CK4436		CSK001					CT058
KX 125 B2	83	CK4457		CSK036					CT058
KX 125 C1	84	CK4457		CSK001					CT058
KX 125 D1/E1/E2	85-87	CK4469		CSK001	DRC011				CT042
KX 125 F1/G1	88-89	CK4482		CSK006	DRC013				CT042
KX 125 H1/H2	90-91	CK4485		CSK116	DRC036				CT042
KX 125 J1	92	CK4485		CSK116	DRC083				CT042
KX 125 J2	93	CK4498		CSK116	DRC069				CT042
KX 125 K1/K2/K3	94-96	CK4425		CSK007					CT004
KX 125 K4/K5/L1-L4	97-02	CK4425		CSK065	DRC073				CT004
KX 125 M1/M2/M3/M6F/M7F/M8F	03-08	CK4425		CSK097	DRC122				CT004
Z 125 (BR 125 GGF/GHF Auto G/Box)	16-17	CK4438		TBA					CT070SP
Z 125 Pro (Manual G/Box)	16-20	CK4438		TBA					CT070SP
KLX 150 L (KLX 150 EFF)	14-15	CK4522		CSK124	DRC211				CT012SP
KLX 150 D-Tracker (KLX150 HGF)	16	CK4522		CSK124	DRC211				CT012SP
KDX 175 A1-A3	80-82	CK4436		CSK001					CT058
KE 175 B1/B2/B3	76-78	CK4411		CSK039					CT058
KE 175 D2-D5	79-83	CK4411		CSK039					CT058
KLF 185 A3	87	CK1119		CSK003					CT012SP
KDX 200 A1/A2	83-84	CK4457		CSK152					CT058
KDX 200 A3	85	CK4457		CSK001					CT058
KDX 200 C1/C2	86-87	CK4469		CSK001	DRC074				CT042
KDX 200 C3	88	CK4469		CSK001	DRC011				CT042
KDX 200 E1/E2/E3/E4/E5/E6	89-94	CK4482		CSK010	DRC061				CT042
KDX 200 H1/H2/H3/H4/H5	95-99	CK4505		CSK116	DRC062				
KMX 200 A2/A3	88-92	CK4486		CSK009					CT002
Z 200 A1 (Up to E.No:-005062)	77	CK4446		CSK148					CT004
Z 200 A1 (From E.No:-005063)	78	CK4425		CSK148					CT004
Z 200 A2-A6	79-83	CK4425		CSK148					CT004
KDX 220 R A4-A12/A6F	97-06	CK4505		CSK116	DRC062				
KDX 220 SR		CK4505		CSK116	DRC062				
KLF 220 A1-A15	88-02	CK1180		CSK116	DRC224				CT013SP
KLX 230	20	CK4514	CKF4514	CSK097	DRC123	DRCF123			CT004
BJ 250 B1-B7A Estrella	92-99	CK4508		CSK004					
BJ 250 E1-EA Estrella-RS Custom	96-99	CK4508		CSK004					
BJ 250 C1-C7 Estrella-RS	95-01	CK4508		CSK004					
BJ 250 D1-D7 Estrella Custom	96-02	CK4508		CSK004					
BJ 250 F1/F2 (250 TR)	02-03	CK4508		CSK007					
EL 250 B1/B2/B3 Eliminator	87-89	CK4473		CSK004					CT016
ER 250 B1/B2/B3 Scorpion	83-88	CK4433		CSK007					CT006
EL 250 D1-D5	90-94	CK4473		CSK004					CT016
EL 252 (EL 250 F2/F3/F5/F6)	96-03	CK4473		CSK004					CT016
EX 250 K8F/K9F/KAF/KBF/KBFA/KCF Ninja 250R	08-12	CK4521		CSK142					CT009
GPX 250 R (ZX 250 F2/F3/F6-F9)	88-95	CK4473		CSK004					CT016
GPZ 250 R (EX 250 E)	86	CK4473		CSK004					CT016
GPX 250 R II (EX 250 G)	88	CK4473		CSK004					CT016
KDX 250 B1	81	CK4439	CKF4439	CSK006					CT006
KDX 250 B2/B3	82-83	CK4433		CSK006					CT006
KDX 250 D1	91-93	CK4475		CSK030	DRC041				CT006
KDX 250 SR (KDX 250 F1)	91	CK4509		CSK030					
KH 250 B4/B5	79-80	CK4436		CSK001					CT058
KL 250 A1-A4/C1/C2	78-84	CK4425		CSK007					CT004
KL 250 H1 Super Sherpa	98	CK4469		CSK074					CT042
KL 250 J1 Stockman		CK4469		CSK074					CT042
KLE 250 A1/A1A/A2 (Anhelo)		CK4473		CSK007					CT016
KLE 250 A2	95	TBA		TBA					
KLE 250 A3	97	TBA		TBA					
KLE 250 A5/A6	00-01	TBA		TBA					
KLF 250 A1/A2/A3/A6F/A7F/A8F/A9F/AAF/ABF (Bayou 250)	03-11	CK1180		CSK116	DRC224				CT013SP
KLR 250 D2-D22	84-05	CK4446		CSK148	DRC063				CT004
KLT 250 C1-C3	83-85	CK4425		CSK148					CT004
KLX 250 D1/D2	93-95	CK4469		CSK001					CT042
KLX 250 F1-F4 (KLX 250 E)	94-97	CK4469		CSK001					CT042
KLX 250 G1	94-	CK4469		CSK001					CT042
KLX 250 J1-J6 D-Tracker	98-03	CK4469		CSK001					CT042
KLX 250 S H6F/H7F	06-07	CK4469		CSK144	DRC212				CT042
KLX 250 (KLX 250 S9F/SAF/SBF/SCF/SDF/SEF/SFF/SGF)	09-16	CK4469		CSK144	DRC212				CT042

CLUTCH APPLICATIONS

EBC CLUTCH KITS

Make & Model	Year	CK Series #	CKF Series #	Spring Kit #	DRC Series #	DRCF Series #	SRC Series #	SRK Series #	CT Tool #
KAWASAKI Contd.									
KLX 250	09-16	CK4469		CSK144	DRC212				CT042
KR 250 A1/A2	84-86	CK4517		CSK010					CT016
KR-1 (KR 250 B2)	89	CK4484		CSK010					CT016
KR-1S (KR 250 C2/C3)	90-92	CK4484		CSK010					CT016
KSF 250 A1-A18 (KXF 250 Mojave)	87-04	CK4425		CSK148	DRC225				CT004
KT 250 A/A2	75-76	CK4411		CSK001					CT058
KX 250	74	CK4419		CSK007					CT006
KX 250 A/A3/A4/A5	75-79	CK4419		CSK007					CT006
KX 250 A6/A7	80-81	CK4439	CKF4439	CSK007					CT006
KX 250 B1/C1	82-83	CK4465		CSK010					CT006
KX 250 C2	84	CK4465		CSK010					CT006
KX 250 D1/D2	85-86	CK4459		CSK010					CT006
KX 250 E1/F1/G1	87-89	CK4475		CSK007	DRC015				CT006
KX 250 H1	90	CK4475		CSK006	DRC017				CT006
KX 250 H2	91	CK4475		CSK030	DRC041				CT006
KX 250 J1/J2/K1-K5/L1-L4	92-02	CK4435	CKF4435	CSK007	DRC046	DRCF046			CT016
KX 250 M1/M2/R1/R6F/R7F/R8F (2T)	03-08	CK4435	CKF4435	CSK007	DRC046	DRCF046			CT016
KX 250 F (KX 250 N1/N2/T6F/T7F/T8F) (4T)	04-08	CK4514	CKF4514	CSK097	DRC123	DRCF123			CT004
KX 250 F (4T)	2009-2020	CK4514	CKF4514	CSK097	DRC123	DRCF123			CT004
KX-F 250 4T	2021	CK4514	CKF4514	TBC	DRC336				TBC
KXF 250 A1/A2	87-88	CK4475		CSK010					CT006
KXT 250 A1 Tecate	84	CK4433		CSK007					CT006
KXT 250 A2 Tecate	85	CK4465		CSK010					CT006
KXT 250 B1 Tecate	86	CK4459		CSK010	DRC038				CT006
KXT 250 B2 Tecate	87	CK4459		CSK010	DRC038				CT006
Z 250 A1-A3/B1/B2	79-81	CK4433		CSK006					CT006
Z 250 C1/C2/G1/G2	80-83	CK4425		CSK007					CT004
Z 250 SL (Naked/Non ABS) BR 250 EFF	15	TBA		TBA					
Z 250 SL (Naked/ABS) BR 250 FFF	15-16	TBA		TBA					
Ninja 250 SL (BX 250 AFF/AFS/AFSA - KRT Edition Non ABS)	15	TBA		TBA					
Ninja 250 SL (BX 250 BFF/BFS/BGF/BGFS - ABS)	15-16	TBA		TBA					
Ninja 250 SL (BX 250 BFS/BGSA KRT/ABS Edition)	15-16	TBA		TBA					
ZR 250 A1-A5 Balius	91-95	CK4508		CSK007					
ZR 250 B6 (Balius-II)	02	CK4508		CSK007					
ZZ-R 250 (EX 250 H1-H13)	90-03	CK4473		CSK004					CT016
ZXR 250 (ZX 250 A1/A2)	89-90	CK4508		CSK007					
ZXR 250 C1-C5 (ZX 250 C1-C5)	91-95	CK4508		CSK007					
ZXR 250 R (ZX 250 D1)	91	CK4508		CSK007					
ZXR 250 R (ZX 250 B1/B2)	89-90	CK4509		CSK007					
EX 300 ADF/AEF/AFF Ninja 300 (Non ABS)	13-15	CK4524		CSK203			SRC118	SRK118	CT009
EX 300 AEFA/AFFA Ninja 300 Special Edition (Non-ABS)	13-15	CK4524		CSK203			SRC118	SRK118	CT009
EX 300 BDF/BEF/BFF/BGF Ninja 300 (ABS)	13-16	CK4524		CSK203			SRC118	SRK118	CT009
EX 300 BEFA/BFFA/BGFA Ninja 300 Special Edition (ABS)	13-16	CK4524		CSK203			SRC118	SRK118	CT009
KEF 300 B1/B2 Lakota Sport	01-02	CK4419		CSK151	DRC233				CT006
KLF 300 A1/A2/B1-B17/C1-C17	87-05	CK4419		CSK151	DRC233				CT006
KLX 300 A2	97	CK4469		CSK001					CT042
KLX 300 A3-A10/A6F	98-06	CK4469		CSK144					CT042
Versys-X 300 ABS	17-21	CK4524		CSK203			SRC118	SRK118	CT009
Z 300 Non ABS (ER 300 AFF)	15	CK4524		CSK203			SRC118	SRK118	CT009
Z 300 ABS (ER 300 BFF) - Ninja 300 (ABS) - Floating Disc Conversion	15-16	CK4524		CSK203			SRC118	SRK118	CT009
GPz 305 A1/B2-B10	83-96	CK4433		CSK010					CT006
S2/S2A (350cc)	72-73	CK4457		CSK192					CT058
FX 400 R (ZX 400 E1/E2/E3)	86-88	CK4424	CKF4424	CSK023					CT016
GPZ 400 R (ZX 400 D1/D2/D3/D3A)	85-87	CK4424	CKF4424	CSK023					CT016
GPZ 400 R (ZX 400 F1)	87	CK4424	CKF4424	CSK023					CT016
S3/S3A (400cc)	74-75	CK4457		CSK192					CT058
KH 400 A3-A5	76-78	CK4457		CSK192					CT058
KLF 400 B1-B7	93-98	CK4439	CKF4439	CSK151	DRC234				CT006
KLX 400 R (KLX 400 B1/B2)	03-04	CK3433	CKF3433	CSK079	DRC105	DRCF105			CT006
KSF 400 A1/A2 (KFX 400)	03-04	CK3433	CKF3433	CSK079	DRC105	DRCF105			CT006
KSF 400 A3/A6F (KFX 400)	05-06	CK3447	CKF3447	CSK079	DRC137	DRCF137			CT006
Ninja 400	17-21	CK4530		TBC			SRC167	SRK167	
Z 400 B1/B2	78-80	CK4421		CSK010					
Z 400 G1	79	CK4421		CSK010					
Z 400 J1-J3	80-83	CK4424	CKF4424	CSK010			SRC011	SRK011	CT016
Z 400	17-21	CK4530		TBC			SRC167	SRK167	
ZL 400 A Eliminator	86-87	CK4424	CKF4424	CSK007			SRC022	SRK022	CT016
ZL 400 B Eliminator 400 SE	88	CK4424	CKF4424	CSK007			SRC022	SRK022	CT016
ZL 400 D1/D2	94-95	CK4424	CKF4424	CSK148					
ZR 400 A1/B1 (Z 400 F)	83-84	CK4424	CKF4424	CSK010			SRC011	SRK011	CT016

EBC CLUTCH KITS

Make & Model	Year	CK Series #	CKF Series #	Spring Kit #	DRC Series #	DRCF Series #	SRC Series #	SRK Series #	CT Tool #
KAWASAKI Contd.									
ZR 400 D1/D3/D4 Xanthus	92-95	CK4446		CSK007					CT004
ZRX 400 (ZR 400 E1-E7)	94-01	CK4424	CKF4424	TBA					CT016
ZR 400 Zephyr (G2/G3/G3A/G4/G5)	97-01	CK4424	CKF4424	CSK010			SRC044	SRK044	CT016
ZX 400 C2 (Z 400 F 11)	85	CK4424	CKF4424	CSK010			SRC011	SRK011	CT016
ZXR 400 H1/H2	89	CK4446		CSK007					CT004
ZXR 400 (ZX 400 L1-L5/L8/L9)	91-02	CK4446		CSK006			SRC021	SRK021	CT004
ZXR 400 R (ZX 400 M1-M4)	91-94	CK4446		CSK006					CT004
ZX 400 J1/J2	89-90	CK4446		CSK007					CT004
ZZR 400 (ZX 400 K1/K2/K3)	90-92	CK4424	CKF4424	CSK007					CT016
ZZR 400 (ZX 400 N1-N7)	93-99	CK4424	CKF4424	CSK043					CT016
Z 440 A2	80-81	CK4421		CSK004					
Z 440 C1/C2	80-81	CK4421		CSK004					
Z 440 D4-D6 (Ltd)	82-84	CK4421		CSK004					
Z 440 H1/H2	82-83	CK4421		CSK004					
KX 420 A1/A2	80-81	CK4439	CKF4439	CSK006					CT006
EN 450 A1-A5 (LTD 454)	86-89	CK4424	CKF4424	CSK010			SRC011	SRK011	CT016
KFX 450 R Quad (KSF 450 B8F/B9F/BAF/ BBF/BCS/BFD/BEF)	08-14	CK4519		CSK177	DRC185				CT006
KLX 450 R (A8F/A9F/AAF/ABF/ACF/ADF/AEF/AFF/AGF)	08-15	CK1247	CKF1247	CSK180	DRC158	DRCF158			CT006
KX 450 F (D6F/D7F/D8F/E9F/EAF/EBF)	06-11	CK1247	CKF1247	CSK180	DRC158	DRCF158			CT006
KX-F 450	12-20	CK1247	CKF1247	CSK029	DRC269	DRCF269			CT006
KX-F 450	21	CK4531		TBC	DRC337				TBC
EN 500 A1-A4/B1/B2/C1-C9	90-04	CK4424	CKF4424	CSK010			SRC011	SRK011	CT016
ER-5 (ER 500 A1/A2/A3/A4/C1-C5P)	97-07	CK4424	CKF4424	CSK010			SRC011	SRK011	CT016
EX 500 A1-A6/D1-D7 (GPz 500 S)	87-02	CK4424	CKF4424	CSK010			SRC011	SRK011	CT016
GPZ 500 S (EX 500 B1-B5)	88-93	CK4424	CKF4424	CSK010			SRC011	SRK011	CT016
GPZ 500 S (EX 500 E1-E10)	94-04	CK4424	CKF4424	CSK010			SRC011	SRK011	CT016
H1 500 Mach III	69-70	CK4425		CSK194					CT004
H1-A 500 S Mach III	71	CK4425		CSK194					CT004
H1-B/C 500 Mach III	72	CK4425		CSK194					CT004
H1-D/E/F 500	73-75	CK4425		CSK194					CT004
KH 500 A8	76	CK4425		CSK194					CT004
KX 500 A1/A2	83-84	CK4433		CSK010					CT006
KX 500 B1/B2	85-86	CK4459		CSK010	DRC038				
KX 500 C1/D1	87-88	CK4475		CSK010	DRC016				CT006
KX 500 E1-E16	89-04	CK4475		CSK010	DRC016				CT006
KLE 500 A1-A12	91-04	CK4424	CKF4424	CSK010	DRC064				CT016
KLE 500 B1P/B6F/B7F	05-07	CK4424	CKF4424	CSK010	DRC064				CT016
Z 500 A1-A3/B1/B2	79-81	CK4424	CKF4424	CSK010			SRC011	SRK011	CT016
GT 550 G1-G9	83-01	CK4424	CKF4424	CSK010			SRC011	SRK011	CT016
GPz 550 D1/H1/H2/A1-A4	81-87	CK4424	CKF4424	CSK010			SRC011	SRK011	CT016
ZR 550 A1/A2 (Z 550 F)	83-84	CK4424	CKF4424	CSK010			SRC011	SRK011	CT016
ZR 550 B2-B6 Zephyr	91-99	CK4424	CKF4424	CSK010			SRC044	SRK044	CT016
Z 550 C1/C2 (Ltd)	80-81	CK4424	CKF4424	CSK010			SRC011	SRK011	CT016
KL 600 A1 (KLR 600)	84	CK4424	CKF4424	CSK010			SRC011	SRK011	CT016
KLR 600 B1/B2/B4/B6-B9	85-94	CK4424	CKF4424	CSK010			SRC011	SRK011	CT016
GPz 600 R A1-A6	85-89	CK4424	CKF4424	CSK010			SRC011	SRK011	CT016
GPX 600 R (C1-C3/C6-C7)	88-96	CK4424	CKF4424	CSK010			SRC044	SRK044	CT016
ZL 600 B1	95-97	CK4424	CKF4424	CSK023			SRC044	SRK044	CT016
ZZR 600 D1/D2/D2A/D3	90-92	CK4424	CKF4424	CSK010			SRC022	SRK022	CT016
ZZR 600 (ZX 600 E1-E13)	93-05	CK4424	CKF4424	CSK043			SRC043	SRK043	CT016
ZZR 600 (ZX 600 E6F)	06-07	CK4424	CKF4424	CSK043			SRC043	SRK043	CT016
ZX6 R F1/F2/F3/G1/G2	95-99	CK4503		CSK056			SRC038	SRK108	CT004
ZX6 R (ZX 600 J1/J2)	00-01	CK4503		CSK056			SRC038	SRK038	CT004
ZX6 R (ZX 600 P7F/P8F/R9F/RAF/RBF/RCF/RDF /REF/RFF/RGF) (599cc)	07-16	CK4514	CKF4514	CSK165			SRC101	SRK101	CT004
ZX6 R (ZX 636 A1P) (636cc)	02	CK4503		CSK056			SRC038	SRK038	CT004
ZX6 R (ZX 636 B1/B2)	03-04	CK4503		CSK056			SRC038	SRK038	CT004
ZX6 R (ZX 636 C1/C6F)	05-06	CK4514	CKF4514	CSK117			SRC084	SRK084	CT004
ZX6 R (599cc)	07-16	CK4514	CKF4514	CSK165			SRC101	SRK101	CT004
ZX6 R (ZX 636 FDF/FEF/FFF/FGF/FHF - ABS - 636cc)	13-17	CK4514	CKF4514	CSK202					CT004
ZX6 R (ZX 636 EGFA/EHFA - Non ABS /KRT Edition - 636cc)	16-17	CK4514	CKF4514	CSK202					CT004
ZX6 R (ZX 636 FGFA/FHFA - ABS/KRT Edition - 636cc)	16-17	CK4514	CKF4514	CSK202					CT004
ZX6 R 30th Anniversary Edition (ZX 636 EFFA - Non ABS - 636cc)	15	CK4514	CKF4514	CSK202					CT004
ZX6 R 30th Anniversary Edition (ZX 636 FFFA - ABS - 636cc)	15	CK4514	CKF4514	CSK202					CT004
ZX6 RR (ZX 600 K1)	03	CK4503		CSK099			SRC076	SRK076	CT004
ZX6 RR (ZX 600 M1)	04	CK4514	CKF4514	CSK099			SRC083	SRK083	CT004
ZX6 RR (ZX 600 N1/N6F)	05-06	CK4514	CKF4514	CSK117				SRK107	CT004
650 Vulcan S (EN 650 AFF/AGF/Non ABS)	15-16	CK4424	CKF4424	CSK010			SRC022	SRK022	CT016
650 Vulcan S (EN 650 BFF/BGF/ ABS)	2015-2016	CK4424	CKF4424	CSK010			SRC022	SRK022	CT016
ER-6F (EX 650)	06-11	CK4424	CKF4424	CSK010			SRC022	SRK102	CT016

CLUTCH APPLICATIONS

EBC CLUTCH KITS

Make & Model	Year	CK Series #	CKF Series #	Spring Kit #	DRC Series #	DRCF Series #	SRC Series #	SRK Series #	CT Tool #
KAWASAKI Contd.									
ER-6F ABS (EX 650 ABS)	06-11	CK4424	CKF4424	CSK010			SRC022	SRK102	CT016
Ninja 650 (EX 650)	12-21	CK4527					SRC155	SRK155	
Ninja 650 ABS (EX 650 ABS)	12-21	CK4527					SRC155	SRK155	
ER-6N (ER 650)	06-11	CK4424	CKF4424	CSK010			SRC022	SRK102	CT016
ER-6N ABS (ER 650 ABS)	06-11	CK4424	CKF4424	CSK010			SRC022	SRK102	CT016
Z 650 (ER 650)	12-21	CK4527					SRC155	SRK155	
Z 650 ABS (ER 650 ABS)	12-21	CK4527					SRC155	SRK155	
KLE 650 A7F/A8F/A9F/CAF (Versys)	07-10	CK4424	CKF4424	CSK010			SRC022	SRK102	CT016
KLE 650 B7F/B8F/B9F/DAF (Versys ABS)	07-10	CK4424	CKF4424	CSK010			SRC022	SRK102	CT016
KLE 650 CBF/CCF/CDF/CEF (Versys/Non ABS)	11-14	CK4424	CKF4424	CSK010					CT016
KLE 650 DBF/DCF/DDF/DEF (Versys/ABS)	11-14	CK4424	CKF4424	CSK010					CT016
KLE 650 Versys (KLE 650 EFF/EGF/Non ABS)	15-16	CK4424	CKF4424	CSK010					CT016
KLE 650 Versys (KLE 650 FFF/FGF/ABS)	15-16	CK4424	CKF4424	CSK010					CT016
KLR 650 A1-A3	87-89	CK4424	CKF4424	CSK007	DRC065				CT016
KLR 650 (KL 650 E8F/E9F)	08-09	CK4435	CKF4435	CSK224	DRC168				CT016
KL 650 B1/B2/B3 Tengai	89-92	CK4424	CKF4424	CSK007	DRC065				CT016
KLX 650 C1/C2/C3	93-97	CK4424	CKF4424	CSK007	DRC065				CT016
KLR 650 C1-C10	95-04	CK4435	CKF4435	CSK224	DRC168				CT016
W 650 (EJ 650 A1/C3-C7)	99-05	CK4435	CKF4435	CSK010			SRC046	SRK046	CT016
Z 650 B/B2/B3	77-79	CK4413		CSK007					CT019
Z 650 C1/C2/C3 Custom	77-79	CK4413		CSK010					CT019
Z 650 D2/D3	79-80	CK4413		CSK010					CT019
Z 650 F1/F2/F3/F4	80-83	CK4413		CSK010					CT019
Z 700 A1 Ltd	84	CK4413		CSK007					CT019
ZN 700 A1/A2 Ltd	84-85	CK4413		CSK007					CT019
VN 700 A1 Vulcan	85	CK4435	CKF4435	CSK007			SRC053	SRK053	CT016
GPX 750 F1/F2/F2A/F3	87-89	CK4435	CKF4435	CSK007			SRC053	SRK053	CT016
GPz 750 R1	82	CK4413		CSK010					CT019
GPz 750 A1-A5	83-87	CK4413		CSK010					CT019
GPz 750 R G2/G3	85-86	CK4435	CKF4435	CSK010					CT016
GT 750 P1-P5	82-90	CK4413		CSK007					CT019
GT 750 P7/P9	92-96	CK4493		CSK023					CT019
H2/H2-A Mach IV (750cc)	72-73	CK4415		CSK023					CT004
H2-B/H2-C Mach IV (750cc)	74-75	CK4523		CSK023					CT004
VN 750 A2/A3/A4/A5/A10	86-94	CK4435	CKF4435	CSK007			SRC053	SRK053	CT016
Z 750 B1/B2	77-78	CK4435	CKF4435	CSK010			SRC046	SRK046	CT016
Z 750 D1	76	CK4435	CKF4435	CSK007			SRC053	SRK053	CT016
Z 750 N1/N2 Spectre	82-83	CK4413		CSK007					CT019
Z 750 (ZR 750 J1/J2/J6F)	04-06	CK4503		CSK217					CT004
ZR 750 C1/C2/C3/C4 Zephyr	91-95	CK4493		CSK010					CT019
ZR 750 C5/D1 Zephyr	95-98	CK4493		CSK038					CT019
ZR7 (ZR 750 F1/F3/F5)	99-04	CK4493		CSK117					CT019
ZR-7S (ZR 750 H1/H2)	01-04	CK4493		CSK117					CT019
Z 750 E1/H1/H2/L1-L4	80-84	CK4413		CSK007					CT019
Z 750 Y1 (Ltd)	82	CK4435	CKF4435	CSK007			SRC053	SRK053	CT016
Z 750 S (ZR 750 K1/K6)	05-07	CK4503		CSK217					CT004
Z 750 (ZR 750 L7F/L8F)	07-08	CK4503		CSK217					CT004
Z 750 (ZR 750 L9F/LAF/LAS)	09-10	CK4503		CSK209			SRC150	SRK150	CT004
Z 750 ABS (ZR 750 M7F/M8F)	07-08	CK4503		CSK217					CT004
Z 750 ABS (ZR 750 M9F/MAF/MAS)	09-10	CK4503		CSK209			SRC150	SRK150	CT004
Z 750 R Non ABS (ZR 750 NBF/NCF)	11-12	CK4503		CSK209			SRC150	SRK150	CT004
Z 750 R Black Edition (ZR 750 NBFA)	12	CK4503		CSK209			SRC150	SRK150	CT004
Z 750 R ABS (ZR 750 PBF/PCF)	11-12	CK4503		CSK209			SRC150	SRK150	CT004
ZX 750 E1/E2 (Turbo)	84-87	CK4443		CSK010					CT019
ZXR 750 H1/H2	89-90	CK4424	CKF4424	CSK023					CT016
ZXR 750 J1/J2/L1-L3/P1-P7	91-03	CK4435	CKF4435	CSK088			SRC024	SRK024	CT016
ZXR 750 R (ZX 750 K1/K2/M1/M2)	91-94	CK4435	CKF4435	CSK088			SRC024	SRK024	CT016
ZX7RR (ZX 750 N1/N2)	96-99	CK4435	CKF4435	CSK038			SRC041	SRK041	CT016
VN 800 A1-A3/B1-B10/B6F	95-06	CK4435	CKF4435	CSK010			SRC046	SRK046	CT016
VN 800 C1/C2/E1/E2/E3 Drifter	99-04	CK4435	CKF4435	CSK007			SRC053	SRK053	CT016
EJ 800 ABF/ACF (W 800 Solid Front Disc)	11-12	CK4435	CKF4435	CSK010			SRC046	SRK046	CT016
EJ 800 (W 800 Cafe Style/Cockpit Fairing)	11	CK4435	CKF4435	CSK010			SRC046	SRK046	CT016
EJ 800 ACFA (W 800 Special Edition Black Exhaust /Gold Rims)	12	CK4435	CKF4435	CSK010			SRC046	SRK046	CT016
EJ 800 ADF/AEF/AFF/AGF (W 800)	13-16	CK4435	CKF4435	CSK010			SRC046	SRK046	CT016
EJ 800 ADFA/AEFA/AFFA/AGFA (W 800 Special Edition)	13-16	CK4435	CKF4435	CSK010			SRC046	SRK046	CT016
Z 800 ADS/AEF/AFF/AGF (Non ABS)	13-16	CK4503		CSK209			SRC150	SRK150	CT004
Z 800 BDS/BEF/BFF/BGF (ABS Model)	13-16	CK4503		CSK209			SRC150	SRK150	CT004
Z 800 E CDS/CEF/CFF/CGF (Non ABS)	13-16	CK4503		CSK209			SRC150	SRK150	CT004
Z 800 E DDS/DEF/DFF/DGF (ABS Model)	13-16	CK4503		CSK209			SRC150	SRK150	CT004
Z1/Z1A/Z1 B	74-76	CK4409		CSK010					CT019
Z 900 A4/A5	76-77	CK4409		CSK010					CT019
Z 900 (ZR 900 A)	17-21	CK4510		CSK169					CT004

CLUTCH APPLICATIONS

EBC CLUTCH KITS

Make & Model	Year	CK Series #	CKF Series #	Spring Kit #	DRC Series #	DRCF Series #	SRC Series #	SRK Series #	CT Tool #
KAWASAKI Contd.									
Z 900 ABS (ZR 900 B)	17-21	CK4510		CSK169					CT004
Z 900 RS (ZR 900 C)	18-21	CK4510		CSK169					CT004
Z 900 RS Café (ZR 900 E)	18-21	CK4510		CSK169					CT004
ZL 900 A1/A2 Eliminator	85-86	CK4434		CSK023			SRC020	SRK020	CT016
GPz 900 R A1-A8	84-96	CK4435	CKF4435	CSK010			SRC046	SRK046	CT016
GPZ 900 R (ZX 900 A11)	98	CK4435	CKF4435	CSK010			SRC046	SRK046	CT016
GPZ 900 R (ZX 900 A12-15)	99-02	CK4435	CKF4435	CSK010			SRC046	SRK046	CT016
VN 900 A6F Classic	06	CK4435	CKF4435	CSK010			SRC046	SRK046	CT016
VN 900 Vulcan Classic LT (Spoke wheel & Screen)	07-21	CK4435	CKF4435	CSK010			SRC046	SRK046	CT016
VN 900 Classic Special Edition (Spoke wheel)	11-21	CK4435	CKF4435	CSK010			SRC046	SRK046	CT016
VN 900 Custom (Cast wheel)	07-21	CK4435	CKF4435	CSK010			SRC046	SRK046	CT016
ZX9R (ZX 900 B1-B4)	94-97	CK4435	CKF4435	CSK038			SRC041	SRK041	CT016
ZX9R (ZX 900 C1/C2)	98-99	CK4510	CKF4510	CSK067			SRC059	SRK059	CT004
ZX9R (ZX 900 E1/E2/F1/F2)	00-03	CK4510	CKF4510	CSK128			SRC089	SRK089	CT004
KLV 1000 (LV 1000 A1H/A2H)	04-05	CK3443	CKF3443	CSK043					CT021
KLZ 1000 ACF/ADF/AEF Versys	12-14	CK4510	CKF4510	TBA					CT004
KLZ 1000 BFF/BGF/BGFAS Versys	15-19	CK4503		TBA					CT004
Z 1000 D1-D3 Z1R	78-80	CK4409		CSK007					CT019
Z 1000 E1/E2 (ST-Shaft)	79-80	CK4434		CSK023			SRC020	SRK020	CT016
Z 1000 A1/A2/A3/A4	77-80	CK4409		CSK010					CT019
Z 1000 H1	80	CK4409		CSK010					CT019
Z 1000 K1/K2 (Ltd)	81-82	CK4434		CSK010			SRC054	SRK054	CT016
Z 1000 J1/J2/J3	81-83	CK4434		CSK010			SRC054	SRK054	CT016
Z 1000 R1/R2 (Eddie Lawson Replica)	83	CK4434		CSK010			SRC054	SRK054	CT016
Z 1000 (ZR 1000 A1/A2/A3/A6F)	03-06	CK4510	CKF4510	CSK128			SRC089	SRK089	CT004
GPz 1000 RX A1-A3	86-88	CK4434		CSK023			SRC020	SRK020	CT016
Ninja H2	15-21	CK4528		CSK269			SRC163	SRK163	
Ninja H2R	15-21	CK4529		CSK270			SRC164	SRK164	
1000 GTR (ZG 1000 A1-A18)	86-03	CK4434		CSK023			SRC020	SRK020	CT016
H2 Ninja (ZX 1000 NFF/NGF)	15-16	TBA		TBA					
H2 R Ninja (ZX 1000 PFF/PGF)	15-16	TBA		TBA					
Z 1000 (ZR 1000 B7F/B8F)	07-08	CK4510	CKF4510	CSK110					CT004
Z 1000 ABS (ZR 1000 C7F/C8F/C9F)	07-09	CK4510	CKF4510	CSK110					CT004
Z 1000 (ZR 1000 DAF/DBF/DCF/DDF)	10-13	CK4510	CKF4510	CSK169					CT004
Z 1000 Black Edition (ZR 1000 DCFA/DDFA)	12-13	CK4510	CKF4510	CSK169					CT004
Z 1000 (ZR 1000 EAF/EBF/ECF/EDF/GEF/GFF)	10-15	CK4510	CKF4510	CSK169					CT004
Z 1000 DAF/DAS/DBF/DCF/DCFA/DDF/DDFA									
(5 Spring Clutch)	10-13	CK4510	CKF4510	CSK169					CT004
Z 1000 EAF/EBF/ECF/ECFA/EDF/EDFA									
(5 Spring Clutch)	10-13	CK4510	CKF4510	CSK169					CT004
Z 1000 FEF/FEFA/FFF (5 Spring Clutch)	14-15	CK4510	CKF4510	CSK169					CT004
Z 1000 GEF/GEFA/GFF (5 Spring Clutch)	14-15	CK4510	CKF4510	CSK169					CT004
Z 1000 (ZR 1000 GGF) 3 Spring Clutch	16	CK4503		TBA					CT004
Z 1000 (ZR 1000 FGF) 3 Spring Clutch	16	CK4503		TBA					CT004
Z 1000 Performance	16-21	CK4510	CKF4510	CSK169					CT004
Z 1000 Special Edition (ZR 1000 GEFA)	14	CK4510	CKF4510	CSK169					CT004
Z 1000 SX ABS Model (ZX 1000 HBF/HCF/HDF)	11-13	CK4510	CKF4510	CSK169					CT004
Z 1000 SX Non ABS Model (ZX 1000 GBF/GCF/GDF)	11-13	CK4510	CKF4510	CSK169					CT004
Z 1000 SX Non ABS Model (ZX 1000 LEF/LFF)	14-15	CK4510	CKF4510	CSK169					CT004
Z 1000 SX ABS Model (ZX 1000 MEF/MFF)	14-15	CK4510	CKF4510	CSK169					CT004
Z 1000 SX Tourer	11-21	CK4510	CKF4510	CSK169					CT004
Z 1000 SX ABS (ZX 1000 MGF) (3 Spring Clutch)	16	CK4503		TBA					CT004
Z 1000 SX Non ABS (ZX 1000 LGF) (3 Spring Clutch)	16	CK4503		TBA					CT004
ZX10 B1/B2/B3	88-90	CK4434		CSK023			SRC020		CT016
ZX10R (ZX 1000 C1/C2)	04-05	CK4510	CKF4510	CSK111			SRC079	SRK079	CT004
ZX10R (ZX 1000 D6F/D7F/E8F/E9F/FAF)	06-10	CK4510	CKF4510	CSK111			SRC079		CT004
ZX10R ABS (ZX 1000 KBF/KCF/KDF/KEF/KFF)	11-15	CK4510	CKF4510	CSK111			SRC079	SRK079	CT004
ZX10R (ZX 1000 JBF/JCF/JDF/JEF/JFF)	11-15	CK4510	CKF4510	CSK111			SRC079	SRK079	CT004
ZX10R 30th Anniversary Edition (ZX 1000 KFFA/ABS)	15	CK4510	CKF4510	CSK111			SRC079	SRK079	CT004
ZX10R 30th Anniversary Edition (ZX 1000 JFFA/Non ABS)	15	CK4510	CKF4510	CSK111			SRC079	SRK079	CT004
ZX10R (ZX 1000 SGF)	16-21	CK4510	CKF4510	CSK111			SRC079	SRK079	CT004
ZX10R Winter Test Edition (ZX 1000 SGFB)	16	CK4510	CKF4510	CSK111			SRC079	SRK079	CT004
ZX10R Ninja KRT Replica (ZX 1000 SGFA)	16-19	CK4510	CKF4510	CSK111			SRC079	SRK079	CT004
ZX-10RR	17-19	CK4510	CKF4510	CSK111			SRC079	SRK079	CT004
ZX-10RR Performance	17-21	CK4510	CKF4510	CSK111			SRC079	SRK079	CT004
ZL 1000 A1	87	CK4434		CSK023			SRC020	SRK020	CT016
GPz 1100 B1/B2	81-82	CK4434		CSK010			SRC054	SRK054	CT016
GPz 1100 A1-A3	82-85	CK4434		CSK023			SRC020	SRK020	CT016
Z 1100 R1	84	CK4434		CSK023			SRC020	SRK020	CT016
Z 1100 A1-A3	81-83	CK4434		CSK023			SRC020	SRK020	CT016
Z 1100 D1/D2 Spectre	82-83	CK4434		CSK023			SRC020	SRK020	CT016
ZR 1100 A1/A2/A3/A4/B1	92-97	CK4434		CSK023			SRC020	SRK020	CT016
ZR 1100 B5 (Zephyr 1100 RS)	02	CK4434		CSK023					CT016
ZRX 1100 (ZX 1100 C1/C2/C3/C4)	97-00	CK4434		CSK023			SRC020	SRK020	CT016

EBC CLUTCH KITS

Make & Model	Year	CK Series #	CKF Series #	Spring Kit #	DRC Series #	DRCF Series #	SRC Series #	SRK Series #	CT Tool #
KAWASAKI Contd.									
ZX 1100 E1/E2/F1	95-98	CK4488		CSK029			SRC025	SRK025	CT021
ZRX 1200 R A1/A2/A3/A4/A5/A6F	01-08	CK4434		CSK038					CT016
ZRX 1200 S B1/B2/B3 (ZR 1200)	01-03	CK4434		CSK038					CT016
ZX12R (ZX 1200 A1)	00	CK4513		CSK109					CT009
ZX12R (ZX 1200 A2/A3/A4/B1-B4/B6F)	01-06	CK4515		CSK067					CT009
ZZR 1200 C1H/C2H	02-04	CK4488		CSK029			SRC025	SRK025	CT021
Z 1300 A1-A3	79-81	CK4452		CSK010					
Z 1300 A4/A5	82-83	CK4458		CSK010					
ZG 1300 A1-A3	84-86	CK4455		CSK007					CT032
GTR 1400 (ZG 1400 A8F/A9F/CAF/CBF) ABS	08-11	CK4520		CSK023					CT021
GTR 1400 ABS (ZG 1400 CCF/CD/CE/EEF/EGF)	12-16	CK4520		CSK023					CT021
ZZR 1400 (ZX 1400 A6F/A7F)	06-07	CK4518		CSK124					CT021
ZZR 1400 ABS (ZX 1400 B6F/B7F)	06-07	CK4518		CSK124					CT021
ZZR 1400 ABS	08-11	CK4518		CSK124					CT021
ZZR 1400 ABS	12-16	CK4518		CSK023					CT021
ZZR 1400 ABS Performance	12-19	CK4518		CSK023					CT022
ZZR 1400 ABS Performance Sport	14-19	CK4518		CSK023					CT023
VN 1500 B2/C1/C2/D1	88-96	CK4455		N/A					CT032
VN 1500 B2-B6	88-92	CK4455		N/A					CT032
VN 1500 C1/C2	94-95	CK4455		N/A					CT032
VN 1500 D1/D2	96-98	CK4455		N/A					CT032
VN 1500 G1/G2	98-99	CK4455		N/A					CT032
VN 1500 E1/E2 Classic	98-99	CK4455		N/A					CT032
VN 1500 J1/J2/R1/R2/R3 Drifter	99-04	CK4455		N/A					CT032
VN 1500 N1/N2/N3 Classic Fi	00-04	CK4455		N/A					CT032
VN 1500 L1/L2/L3/L4 Classic Tourer Fi	00-03	CK4455		N/A					CT032
VN 1500 P1/P2 Mean Streak	02-04	CK4455		N/A					CT032
VN 1600 A1/A2/A3/A6F Classic	03-08	CK4455		N/A					CT032
VN 1600 B1 Mean Streak	04	CK4455		N/A					CT032
VN 1600 B2H/B6F/B7F (Mean Streak)	05-08	CK4455		N/A					CT032
VN 1600 D1H/D6F Classic Tourer	05-08	CK4455		N/A					CT032
VN 1700 B9F/BAF/BBF/BCF/BDF/BEF/BFF/BGF									
Voyager ABS	09-16	CK4516		CSK170					CT032
VN 1700 C9F Classic Tourer	09	CK4516		CSK170					CT032
VN 1700 DAF/DBF/DCF/DDF/DEF Classic Tourer ABS	10-14	CK4516		CSK170					CT032
VN 1700 DFF/DGF - Vulcan 1700 Nomad	15-16	CK4516		CSK170					CT032
VN 1700 E9F Classic	09	CK4516		CSK170					CT032
VN 1700 Classic ABS	10-17	CK4516		CSK170					CT032
VN 1700 Voyager Custom	11-17	CK4516		CSK170					CT032
VN 2000 A1/A2/A6F	04-07	CK4516		CSK110					CT032
VN 2000 H8F/H9F Classic	08-09	CK4516		CSK110					CT032
SUZUKI									
AP 50	-78	CK3311		CSK025					CT051
DR-Z50	19-21	CK3458							
FR 50	81-	CK3393		N/A					
GS 50 K5 (NA41A)	05	CK3328		CSK013					CT011
GT 50 KB/KEN	77-80	CK3328		CSK001					CT011
JR 50 (All models)	78-07	CK3366		CSK002					
RM 50 C/N/T/X/Z	78-82	CK3328		CSK001					
OR 50 ET	80	CK3328		CSK001					CT011
RB 50 H	87	CK3380		CSK001					CT051
RG 50 EW		CK3349		CSK001					CT011
TS 50 KN/ERKT/ERKX/ERKZ/ERKD	79-83	CK3328		CSK001					CT011
TS 50 XKE/XKG/XKH/XKJ/XKM/XKR	84-02	CK3349		CSK001					CT011
TS 50 W		CK3349		CSK001					CT011
ZR 50 KEN/KEX	79-81	CK3328		CSK001					CT011
ZR 50 SLXX/SKX	81	CK3328		CSK001					CT011
ZR 50 SKE/SKH	84-87	CK3328		CSK001					CT011
RM 60 K3	03	CK4438	CKF4438	CSK018	DRC007				CT070SP
RM 65 K3/K4/K5	03-05	CK4438	CKF4438	CSK040	DRC098	DRCF098			CT070SP
DR-Z70	08-21	CK3458							
DS 80 T/X/Z/D/F/G/H/J/K/L/M/N/P/R/S/T/V/W/X/Y	80-00	CK3340		CSK001					CT011
FR 80 M/B/N/X/Z/D	76-83	CK3378		N/A					
JR 80 K1/K2/K3/K4/K5/K6/K7	01-07	CK3340		CSK001					CT011
RM 80 B	77	CK3318	CKF3318	CSK001					CT011
RM 80 C/N/XT/XX	78-81	CK3318	CKF3318	CSK001					CT011
RM 80 XZ	-82	CK3340		CSK036					CT011
RM 80 XD/HD	83	CK3340		CSK034					CT011
RM 80 XE/XF/HF	84-85	CK3318	CKF3318	CSK034					CT011
RM 80 XG	86	CK3367		CSK034					
RM 80 XH/XJ	87-88	CK3367		CSK055	DRC019				
RM 80 K/L	89-90	CK3318	CKF3318	CSK001	DRC020				CT011
RM 80 M/N/P/R/S/T/V/W/X/Y/K1	91-01	CK3318	CKF3318	CSK014	DRC025	DRCF025			CT011

EBC CLUTCH KITS

Make & Model	Year	CK Series #	CKF Series #	Spring Kit #	DRC Series #	DRCF Series #	SRC Series #	SRK Series #	CT Tool #
SUZUKI Contd.									
RM 85 (Small Wheel F 17 Inch/R 14 Inch Wheel)	02-21	CK3318	CKF3318	CSK014	DRC025	DRCF025			CT011
RM 85 (Big Wheel F 19 Inch/ R 16 Inch)	02-21	CK3318	CKF3318	CSK014	DRC025	DRCF025			CT011
FB 90 K1	01	N/A		N/A					
A 100 L/M/N	74-80	CK3312		CSK025					CT051
GP 100 C/UC	78	CK3319		CSK025					CT011
GP 100 N/UN	79	CK3318	CKF3318	CSK025					CT011
GP 100 X/UX/D/UD/UL	81-92	CK3339		CSK025					CT011
RM 100 A	76	CK3319		CSK025					CT011
RM 100 B/C	77-78	CK3329		CSK025					CT011
RM 100 N/T/X	79-81	CK3319		CSK025					CT011
RM 100 K3	03	CK4453	CKF4453	CSK041	DRC045	DRCF045			CT002
TS 100 K/L/M/A/B	73-77	CK3326		CSK025					CT051
TS 100 C	78	CK3318		CSK025					CT011
TS 100 ERN Upto F 300563	79	CK3318	CKF3318	CSK025					CT011
TS 100 ERN/ERT/ERX From F 300564	80-81	CK3337		CSK025					CT011
TS 100 ERZ/ERH	82	CK3318	CKF3318	CSK025					CT011
DR-Z 110 K3/K4/K5	03-05	CK4438	CKF4438	CSK040					CT070SP
110cc Smash	03	CK4438	CKF4438	CSK010					CT070SP
B 120		CK3306		CSK001					CT052
DF 125		CK3318	CKF3318	CSK034					CT011
DR 125 SZ/SD/SE/SF/SH/SJ	82-94	CK3318	CKF3318	CSK034					CT011
DR 125 SEX/SEY	99-01	CK3318	CKF3318	CSK034					CT011
DR 125 SMK8/SMK9/SML0	08-12	CK3337		CSK034					CT011
DR-Z 125	03-20	CK3318	CKF3318	CSK034					CT011
DR-Z 125 L	03-20	CK3318	CKF3318	CSK034					CT011
FX 125		CK3318	CKF3318	CSK034					CT011
GN 125 R/V/W/X/Y/K1 (NF41A)	94-01	CK3318	CKF3318	CSK034					CT011
GN 125 ER/EV/EW/EX/EY/EK1 (NF41A)	94-01	CK3318	CKF3318	CSK034					CT011
GN 125 Z/D/K (Gold Cast Wheel/Aisin caliper)	82-90	CK3318	CKF3318	CSK034					CT011
GN 125 HS (LC6PCJB1/Chinese Production)	00-11	CK3318	CKF3318	CSK034					CT011
GP 125 C/N	78-79	CK3319		CSK025					CT011
GP 125 X/XD	81-84	CK3338		CSK025					CT011
GS 125 Z/D/ESZ/ESD/ESF/ESK/ESM/ESR/ESX	82-00	CK3318	CKF3318	CSK034					CT011
GSX-R 125	18-21	CK3318	CKF3318	CSK245			SRC148	SRK148	CT011
GSX-S 125	18-21	CK3318	CKF3318	CSK245			SRC148	SRK148	CT011
GT 125 L/M/A/B/C/EC	74-78	CK3318	CKF3318	CSK025					CT011
GT 125 EN	79	CK3337		CSK025					CT011
GZ 125 W/X/Y/K1-K9 Marauder	98-11	CK3318	CKF3318	CSK034					CT011
LT 125 D/E/F/G/H	84-86	CK3328		N/A					CT011
RG 125 CG/CH/J (NF12A) (Gamma /Rear Drum Brake Model)	86-90	CK3319		CSK025					CT011
RG 125 UCG/UCH/UCJ/J/BUJ (NF12B) (Gamma/Rear Drum Model)	86-90	CK3319		CSK025					CT011
RG 125 FN/FP/FR Gamma (NF13A/Rear Disc Model)	92-94	CK3319		CSK146					CT011
RG 125 FUN/FUP/FUR Gamma (NF13B/Rear Disc Model)	92-94	CK3319		CSK146					CT011
RG 125 UN Wolf (NF13E/Naked)	92-94	CK3319		CSK146					CT011
RM 125 A/B/C	76-78	CK3329		CSK025					CT011
RM 125 N/T	79-80	CK3319		CSK025					CT011
RM 125 X/Z	81-82	CK3329		CSK036					CT011
RM 125 D	83	CK3329		CSK034					CT011
RM 125 E	84	CK3356		CSK034					CT011
RM 125 F	85	CK3329		CSK034					CT011
RM 125 G/H	86-87	CK3319		CSK001	DRC021				CT011
RM 125 J/K/L/M	88-91	CK3356		CSK053	DRC022				CT011
RM 125 N	92	CK3401		CSK032	DRC114				CT003
RM 125 P/R/S/T/V/W	93-96	CK3401		CSK027	DRC076S				CT003
RM 125 X/Y/K1	97-01	CK3401		CSK093	DRC115				CT003
RM 125 K2/K3/K4/K5/K6/K7/K8/K9	02-12	CK4514	CKF4514	CSK091	DRC130	DRCF130			CT003
RM 125 XCK8	09	CK4514	CKF4514	CSK091	DRC130	DRCF130			CT003
RV 125 K2/K3/K4/K5/K6/K7/K8/K9/L0/L3/L4 Van-Van	02-15	CK3318	CKF3318	CSK034					CT011
T 125/125-11/R Stinger	69-71	CK3306		CSK025					CT052
TF 125 Farm Bike (All models)	78-05	CK3318	CKF3318	CSK025					CT011
TS 125 K/L/M/A/B/C/2	73-78	CK3318	CKF3318	CSK025					CT011
TS 125 ERN Up to F No 302345	79	CK3318	CKF3318	CSK025					CT011
TS 125 ERN From F No 302346	79	CK3337		CSK025					CT011
TS 125 ERT/ERX	80-81	CK3337		CSK025					CT011
TS 125 ERZ	82	CK3318	CKF3318	CSK025					CT011
TS 125 N to Frame No. 178871	84	CK3318	CKF3318	CSK025					CT011
TS 125 N from Frame No.178872	84	CK3337		CSK025					CT011
TS 125 XUE/XUF/XUG/XUH/XUJ	84-90	CK3319		CSK025					CT011
TS 125 RK/RL/RM/RN/RR	90-94	CK3319		CSK146					CT011
TU 125 XTUX/XTX	99	CK3319		CSK034					CT011
VL 125 Y/K1-K7 Intruder	00-08	CK3432		CSK158					CT029
X4 125		TBA		TBA					

CLUTCH APPLICATIONS

EBC CLUTCH KITS

Make & Model	Year	CK Series #	CKF Series #	Spring Kit #	DRC Series #	DRCF Series #	SRC Series #	SRK Series #	CT Tool #
SUZUKI Contd.									
GSX 150 L6/DZAL6 Gixxer	16	CK3318	CKF3318	CSK245			SRC148	SRK148	CT011
GSX 150 DEAL8/DZAL8/DXAL8 Gixxer	18	CK3318	CKF3318	TBA			TBA	TBA	CT011
GSX-R 150 FRFAL7/FRZAL7	17-18	CK3318	CKF3318	TBA			TBA	TBA	CT011
GSX-R 150 RF-Q/RFX-Q	17-18	CK3318	CKF3318	CSK245			SRC148	SRK148	CT011
GSX-R 150	18-21	CK3318	CKF3318	CSK245			SRC148	SRK148	CT011
GSX-S 150	18-21	CK3318	CKF3318	CSK245			SRC148	SRK148	CT011
LT 160 EK/EL/EM/EN	89-92	CK3364		CSK048	DRC218				CT011
LT-F 160 L/M/N/P/R/S/T/V/W/X/Y/K1-K3	90-03	CK3364		CSK048	DRC218				CT011
LT 160 K3/K4 QuadSport	03-04	CK3364		CSK048	DRC218				CT011
PE 175 C/N/T/X/Z	78-82	CK3329		CSK025					CT011
GT 185 K/L/M/A/B/C/EC	73-79	CK3319		CSK025					CT011
LT 185 E/F	84-85	CK3328		N/A					CT011
TS 185 K/L/M	73-75	CK3319		CSK025					CT011
TS 185 B/C	77-78	CK3319		CSK025					CT011
TS 185 ERN/ERT/ERX	79-81	CK3319		CSK025					CT011
DF 200 EV/EW/EY (SH42A)	98-99	CK3319		CSK034	DRC274				CT011
DR 200 G/H/J	86-89	CK3319		CSK034	DRC094				CT011
DR 200 SEP/SER/SES/SEV/SEW/SEX/SEY (SH42A) Djebel	93-00	CK3319		CSK034	DRC274				CT011
DR 200 SE Trojan		CK3319		CSK034	DRC274				CT011
DR 200 SEK1-SEK9	01-09	CK3319		CSK034	DRC274				CT011
GT 200 EN/EX X5	79-80	CK3319		CSK025					CT011
RV 200 K2/K3	02-03	CK3319		CSK034	DRC274				CT011
SB 200 N/X	79-80	CK3319		CSK025					CT011
SX 200 R/R-Z/RJ/RM	90-91	CK3319		CSK034					CT011
TS 200 RK/RL/RM/RN/RR	89-94	CK3329		CSK034					CT011
LT 230 GEF/GEG	85-86	CK3364		CSK048	DRC218				CT011
LT-F 230 G/H	86-87	CK3364		CSK048	DRC218				CT011
DR 250 RS/RLS/RT/RV/RLV/RW/RLW/RY (SJ45A/DOHC)	95-00	CK1181		CSK046					CT013
DR 250 RXT/RXL/RTX/RXLV/RXW/RXLW/RXGW/RXGLW /RXY/RXGY (Djebel 250 XC/GPS Ver) (SJ45A)		CK1181		CSK046					CT013
DR 250 SL/SM/SN/SEP/SER/SES (SJ44A)	90-95	CK3399	CKF3399	CSK034	DRC058	DRCF058			CT022
DR-Z 250 K1-K7 (DJ43A)	01-07	CK1181		CSK046	DRC280				CT013
GS 250 TT/TX	80-81	CK3329		CSK036					CT011
GSF 250 N/ZM/P/NP/ZP/R/NR (GJ74A)	92-96	CK3319		CSK036					CT011
GSF 250 VS/VT/VV/VVZ/VW/VX/VY Bandit (GJ77A)	95-00	TBA		TBA					CT011
GSX 250 ET/EX/EZ	80-82	CK3329		CSK036					CT011
GSX 250 FL/FM/FN/FP/FR/FS/FT/FV/FW - Across	90-98	TBA		TBA					CT011
GSX 250 RCH/RH (GJ72A)		CK3319		CSK036					CT011
GSX 250 SSM Katana (GJ76A)	91	CK3339		CSK036					CT011
GSX 250 FXK2/F3/F4/F5 (ZR 250 C)	02-05	CK4508		CSK007					CT011
GSXR 250 CJ (GJ72A)		CK3319		CSK036					CT011
GSXR 250 CK (GJ72A)		CK3319		CSK036					CT011
GSXR 250 RK (GJ73A)	89	CK3339		CSK036					CT011
GN 250 F/J/M/R/T (NJ41A)	85-97	CK3358		CSK158					CT029
GT 250 K/L	73-74	CK3313		CSK159					CT046
GT 250 M/A-C	75-78	CK3315		CSK159					CT022
GT 250 EN/ET/EX X7	79-81	CK3315		CSK159					CT022
GW 250 L3/ZL5 Inazuma	13-15	CK3358		CSK204					CT029
GW 250 FL5 Inazuma	15	CK3358		CSK204					CT029
GZ 250 X/Y/K1-K8 Marauder	99-08	CK3358		CSK068					CT029
LT-F 250 J/K/L/M/N/P/R/S/T/V/W/Y/K1	89-01	CK3390		CSK048	DRC089				CT011
LT-F 4WD H/J/K/L/M/N/P/R/S/T/V/W	87-98	CK4523		CSK048	DRC089				CT011
LT 250 RH/RJ/RK	87-90	CK3372		CSK034	DRC023				CT022
LT 250 EFF/EFG	85-86	CK3390		CSK048	DRC089				CT011
LT-F 250 FX/FY/FK1/FK2	99-02	CK3390		CSK048	DRC089				CT011
LT-F 250 K2 Ozark (Up to F/No JSAAJ51A22100696)	02	CK3364		CSK048	DRC220				CT011
LT-F 250 K2 Ozark (From F/No JSAAJ51A22100697-)	02	CK3364		CSK147	DRC297				CT011
LT-F 250 K3 Ozark	03	CK3390		CSK147	DRC221				CT011
LT-F 250 K4 Ozark	04	CK3448		CSK148	DRC222				CT011
LT-F 250 K5/K6/K7/K8/K9/L2/L3/L4 Ozark	05-14	CK3390		CSK147	DRC221				CT011
LT-Z 250 K4/K5/K6/K7/K8/K9/L0 QuadSport	04-12	CK3448		CSK048	DRC222				CT011
250 SBK 2 (LX 250 L)	02	CK4469		CSK001					CT042
PE 250 B/C/N	77-79	CK3334		CSK006					CT022
PE 250 T/X/Z	80-82	CK3331		CSK006					CT022
RG 250 WD	83	CK3384		CSK159					CT022
RG 250 WE	84	CK3351		CSK159					CT022
RG 250 FG/FH/CH/FCH	85-88	CK3351		CSK006					CT022
RGV 250 J	88	CK3351		CSK007					CT022
RGV 250 K/L (VJ21A)	89-90	CK3351		CSK007					CT022
RGV 250 M/N/P/R/S (VJ22A)	91-95	CK3333		CSK007					CT022
RGV 250 T (RGVR 250 SP) VJ23A Dry Clutch	96	CK1288		CSK167					CT071SP
RL 250 L/M	74-75	CK3315		N/A					CT022
RL 250 Beamish Model Reed Valve Engine	78-82	CK3343		CSK006					CT018SP

CLUTCH APPLICATIONS

EBC CLUTCH KITS

Make & Model	Year	CK Series #	CKF Series #	Spring Kit #	DRC Series #	DRCF Series #	SRC Series #	SRK Series #	CT Tool #
SUZUKI Contd.									
RM 250 A/B/C	76-78	CK3334		CSK006					CT022
RM 250 N/T/X/Z/D/E/F	79-85	CK3331		CSK006					CT022
RM 250 G	86	CK3372		CSK034					CT022
RM 250 H	87	CK3372		CSK055	DRC052				CT022
RM 250 J/K/L	88-90	CK3374	CKF3374	CSK027	DRC024				CT022
RM 250 M	91	CK3374	CKF3374	CSK045	DRC040				CT022
RM 250 N/P	92-93	CK3400		CSK032	DRC048				CT022
RM 250 R/S	94-95	CK3374	CKF3374	CSK032	DRC072				CT022
RM 250 T	96	CK4435	CKF4435	CSK032	DRC080				CT016
RM 250 V/W/X/Y/K1/K2	97-02	CK4435	CKF4435	CSK091	DRC095				CT016
RM 250 K3/K4/K5	03-05	CK3454	CKF3454	CSK091	DRC161				CT016
RM 250 K6/K7/K8/K9	06-12	CK3453		CSK119	DRC160				CT016
RM 250 XCK8	09	CK3453		CSK119	DRC160				CT016
RMX 250 K/L	89-90	CK3374	CKF3374	CSK027					CT022
RMX 250 M	91	CK3374	CKF3374	CSK045					CT022
RMX 250 N/P	92-93	CK3400		CSK032					CT022
RMX 250 R/S/T/V/W	94-98	CK3374	CKF3374	CSK032	DRC072				CT022
RMX 250 SN/SR/S-S (SJ13A)	95-97	CK3437		N/A					CT022
RMX 250 ST/SW/SX (SJ14A)	96-99	CK3374	CKF3374	CSK032	DRC072				CT022
RM-Z 250 K4/K5/K6	04-06	CK4514	CKF4514	CSK097	DRC123	DRCF123			CT004
RM-Z 250 K7/K8/K9	07-09	CK4514	CKF4514	CSK141	DRC189	DRCF189			CT004
RM-Z 250	10-21	CK4514	CKF4514	CSK164	DRC255	DRCF255			CT004
SW-1 (NJ45A)	92	CK3358		CSK006					CT029
T20 Super Six	66-68	CK3310		CSK076					CT038SP
T 250 II/R/J	70-72	CK3313		CSK159					CT046
TS 250 K/L/M/A/B/C/ERN/ERT/ERX	73-81	CK3315		CSK159					CT022
TS 250 XE/XG/XH/XJ/XK	85-89	CK3319		CSK034					CT011
TU 250 T/XS/X-T/X-SV Volty	92-97	CK3358		CSK006					CT029
TU 250 TX/X/XTY (NJ45A-115-) Volty	99-00	CK3358		CSK068					CT029
TU 250 GY/GBK1 Grass Tracker Big Boy (NJ47A-117/123)	00-01	CK3358		CSK068					CT029
TV 250 J/K/RK/L (VJ21A) Wolf	88-90	CK3351		CSK007					CT022
VL 250 Y/K1/K5/K6/K7 Intruder	00-01	CK3358		CSK068					CT029
VL 250 Y/K1/K5/K6/K7 Intruder	05-07	CK3358		CSK068					CT029
LT-F 300 J/K	88-89	CK3390		CSK048	DRC089				CT011
LT-F 4WD XM/N/P/R/S/T/V/W 300 Quadrunner	91-98	CK3356		CSK048	DRC103				CT011
TU 250 XV/XW	97-00	CK3358		CSK006					CT029
LT-F 300 FX/FY/FK1	99-01	CK3356		CSK048	DRC103				CT011
RL 325 Beamish Model Reed Valve Engine	78-82	CK3343		CSK006					CT018SP
DR 350 SL/SM/SN/SP/SER/SES/SET/SEV/SEW/SEX	90-99	CK3399	CKF3399	CSK034	DRC058	DRCF058			CT022
SG 350 N Goose	92	CK3399	CKF3399	CSK034					CT022
T 350 1/2/R/J	69-72	CK3313		CSK159					CT046
SP 370 C/N	78-79	CK3334		CSK006					CT022
GT 380 K-M/A/B	73-77	CK3315		CSK159					CT022
DR 400 ST/SX	80-81	CK3332		CSK006					CT022
DR-Z 400 SY/EY/Y/SK1/EK1/K1/SK2/EK2/K2 /SK3/EK3/K3/SK4/EK4/K4/EK5/SK5/K6/SK6 /EK6/SK7/EK7/K7/SK8/SK9	00-09	CK3433	CKF3433	CSK079	DRC105	DRCF105			CT006
DR-Z 400 SMK5/SMK6/SMK7/SMK8/SMK9	05-09	CK3433	CKF3433	CSK079	DRC105	DRCF105			CT006
GN 400 TT	80	CK3332		CSK006					CT022
GS 400 B/C	77-78	CK3343		CSK159					CT018SP
GSF 400 M/N/P	91-95	CK3397		CSK034					CT011
GSF 400 K/NK/Z/VN/VZM/P/NP/VPV/ZR/VR									
Bandit (GK75A)	89-94	CK3397		CSK034					CT011
GSF 400 V/VS/N-V/VZ-V Bandit (GK7AA)		CK3397		CSK034					CT011
GSX 400 ET/EX/EZ	80-82	CK3333		CSK006					CT022
GSX 400 FEX/FZ/FD	81-83	CK3332		CSK006					CT022
GSX 400 FW/FWS/FWS-2		CK3332		CSK006					CT022
GSX 400 R2 (GK71B)		CK3385		CSK034					CT011
GSX 400 R3 (GK71F)		CK3385		CSK034					CT011
GSX 400 FJ/FK/FAK/FL (GK74A)	88-90	CK3397		CSK034					CT011
GSX 400 X/XA/XS Impulse		CK3385		CSK034					CT011
GSX 400 R/S/T/X/ZR/ZS/ZT Impulse Type S	94-99	CK1177		CSK006					CT002
GSX 400 TX/LX	81	CK3333		CSK159					CT022
GSX 400 FSV/FSK1 (GK7BA) Inazuma	00	CK3359		CSK006					CT047SP
GSX 400 SSN (GK77A) Katana	92	CK3441		TBA					
GSXR 400 H	87	CK3385		CSK034					CT011
GSXR 400 J/RR/RAK (GK73A)	88-90	CK3397		CSK034					CT011
GSXR 400 RL/RM/RN/RP/RS (GK76A)	90-95	CK3397		CSK034					CT011
GSR 400 K6/K7/K8	06	CK1218	CKF1218	CSK075					CT014
LT-F 400 K2 (Eiger)	02	CK4439	CKF4439	CSK098	DRC223				CT006
LT-F 400 FK2-FK7 (Eiger 4WD)	02-07	CK4439	CKF4439	CSK098	DRC120				CT006
LT-F 400 FK8/FK9/FL0/FL1 King Quad 4WD	08-12	CK4439	CKF4439	CSK098	DRC120				CT006
LT-F 400 K3-K7 Eiger 2WD	03-07	CK4439	CKF4439	CSK098	DRC120				CT006

CLUTCH APPLICATIONS

EBC CLUTCH KITS

Make & Model	Year	CK Series #	CKF Series #	Spring Kit #	DRC Series #	DRCF Series #	SRC Series #	SRK Series #	CT Tool #
SUZUKI Contd.									
LT-Z 400 K3/K4	03-04	CK3433	CKF3433	CSK079	DRC105	DRCF105			CT006
LT-Z 400 K5/K6/K7/K8/K9/L0/L1/L2/L3 QuadSport	05-15	CK3447	CKF3447	CSK079	DRC137	DRCF137			CT006
PE 400 T/X	80-81	CK3332		CSK006					CT022
RF 400 RP/RR/VR/RT/RVT/RV-V (GK78A)		CK1177		CSK006					CT002
RG 400 EWF/EW-2G/EWH Walter Wolf	85-87	CK4503		CSK007					CT037SP
RM 400 C	78	CK3315		CSK006					CT022
RM 400 N/T	79-80	CK3332		CSK006					CT022
RV 400 RP/RR	93-	CK1177		CSK006					CT002
SP 400 T	80	CK3332		CSK006					CT022
ST 400 V/W/X/Y/K1/K2/K3 Tempter	97-03	CK3359		CSK026					CT029SP
SV 400 N (VK53A)	98	CK3377		CSK069			SRC081	SRK081	CT033SP
SV 400 X/Y/K1/K2	99-02	CK3377		CSK069			SRC081	SRK081	CT033SP
SV 400 K3/K4/K5	03-05	CK1219		CSK133			SRC082	SRK082	CT033SP
SV 400 SN (VK53A)	98	CK3377		CSK069			SRC081	SRK081	CT033SP
SV 400 SX/SY/SK1/SK2	99-02	CK3377		CSK069			SRC081	SRK081	CT033SP
SV 400 SK3/SK4/SK5	03-05	CK1219		CSK133			SRC082	SRK082	CT033SP
VS 400 VR/FR/VTR/FTR/VT/FT Intruder	94-	CK3377		CSK026					CT029
GS 425 EN	79	CK3343		CSK006					CT018SP
GS 450 ET/EG/EJ	80-88	CK3333		CSK006					CT022
LT-R 450 K6/K7/K8/K9/L0/L1	06-12	CK3450	CKF3450	CSK125	DRC164	DRCF164			CT045
RM-X 450 ZL0/ZL2	10-15	CK3450	CKF3450	CSK186	DRC155	DRCF155			CT045
RM-Z 450 K5/K6/K7	05-07	CK3450	CKF3450	CSK164	DRC254	DRCF254			CT045
RM-Z 450	08-19	CK3450	CKF3450	CSK186	DRC155	DRCF155			CT045
RM-Z 450	20-21	TBC	TBC	TBC	TBC	TBC			CT045
RM 465 X/Z	81-82	CK3348		CSK006					CT022
DR 500 X/Z/D	81-83	CK3359		CSK026					CT029SP
LT 500 RL/RM	90-91	CK3374	CKF3374	CSK034	DRC026				CT022
LT-F 500 FW/FX/FY/FK1/FK2	98-02	CK4439	CKF4439	CSK007	DRC217				CT006
LT-F 500 FK3-FK7	03-07	CK3452		CSK007					CT006
GS 500 EK/EL/EM/EN/EP/ER/ES/ET/EV/EW/EX/EY /K1/K2/K3/K4/FK4/F5/FK5/K6/FK6/K7/FK7/K8/FK8	89-08	CK3333		CSK061					CT022
GT 500 A/B	76-77	CK3316		CSK158					CT022
RE5 M/A	75-76	CK3373		CSK158					CT035SP
RG 500 G/CH	85-87	CK4503		CSK224					CT037SP
RM 500 D/E	83-84	CK3348		CSK006					CT022
T500 1/2/3 (18 ears)	68-70	CK3314		CSK158					CT046
T500 R/J/K/L/M (12 ears)	71-75	CK3316		CSK158					CT022
GT 550 J/K/L/M/A/B	72-77	CK3321		CSK158					CT035SP
GS 550 DB/DC/EC/EN/ET/EX/EZ	77-82	CK3344		CSK159					CT018SP
GS 550 MX/MZ Katana	81-82	CK3344		CSK159					CT018SP
GS 550 LT/LX	80-81	CK3344		CSK159					CT018SP
GSX 550 ESD/ESE/EFF/EFE/ESH/EFG (GN71D)	84-87	CK3344		CSK159					CT018SP
DR 600 RG/RH/RJ/RK (SN41A)	86-89	CK3359		CSK224					CT029SP
DR 600 SF (SN41A)	85	CK3359		CSK224					CT029SP
DR 600 SG/SH/SJ/SK (SN41A)	86-89	CK3359		CSK224					CT029SP
GSF 600 S/T/V/W/X (Naked Bandit)	95-99	CK3348		CSK198					CT047SP
GSF 600 ST/SV/SW/SX (Faired Bandit)	96-99	CK3348		CSK198					CT047SP
GSF 600 Y/K1/K2/K3/K4 (Naked Bandit)	00-04	CK3348		CSK198					CT047SP
GSF 600 SY/SK1/SK2/SK3/SK4 (Faired Bandit)	00-04	CK3348		CSK198					CT047SP
GSR 600 K6/K7/K8	06-10	CK1218	CKF1218	CSK075					CT014
GSX 600 FJ/FK/FL/FM	88-91	CK3348		CSK026			SRC013	SRK013	CT047SP
GSX 600 FN/FP/FR/FS/FT/FV	92-97	CK3387		CSK198			SRC017	SRK017	CT036SP
GSX 600 FW/FX/FY/FK1/FK2/FK3/FK4/FK5/FK6	98-06	CK3357	CKF3357	CSK198					CT047SP
GSXR 600 V/W (SRAD)	97-98	CK1206	CKF1206	CSK902			SRC058	SRK106	CT055SP
GSXR 600 X/Y (SRAD)	99-00	CK1206	CKF1206	CSK902			SRC058	SRK058	CT055SP
GSXR 600 K1/K2/K3/ZK3	01-03	CK3466		CSK261			SRC112	SRK112	CT014
GSXR 600 K4/K5	04-05	CK1206	CKF1206	CSK156			SRC078	SRK078	CT014
GSXR 600 K6/K7	06-07	CK3455	CKF3455	CSK205			SRC086	SRK086	CT015
GSXR 600 K8/K9/L0	08-10	CK3456	CKF3456	CSK205			SRC088	SRK109	CT01
GSXR 600	11-21	CK3456	CKF3456	CSK183			SRC110	SRK110	CT015
RF 600 RP/RR/RS/RT	93-96	CK3408	CKF3408	CSK198			SRC045	SRK045	CT036SP
VS 600 GLS/GLT/GLV	95-97	CK3377		CSK115					CT029
DL 650 K4-K6 V-Strom	04-06	CK1219		CSK133			SRC082	SRK082	CT033SP
DL 650 AK7/AK8/AK9/AL0 V-Strom ABS	07-11	CK1219		CSK133			SRC082	SRK082	CT033SP
DL 650 AL2/AL3/AL4/AL5 V-Strom ABS	12-15	CK1219		CSK133			SRC082	SRK082	CT033SP
DL 650 AL1XP V-Strom Xpedition ABS	11	CK1219		CSK133			SRC082	SRK082	CT033SP
DL 650 AK9GT V-Strom Traveller ABS	09-10	CK1219		CSK133			SRC082	SRK082	CT033SP
DL 650 XK7/XK8/XK9/XL0 V-Strom	04-11	CK1219		CSK133			SRC082	SRK082	CT033SP
DL 650 XT V-Strom ABS (DL 650 XAL5/ XAL9)	15-21	CK1219		CSK133			SRC082	SRK082	CT033SP
DR 650 RL/RM (SP41A)	90-91	CK3402		CSK115	DRC059				CT029SP
DR 650 RSL/RSM (SP42A)	90-91	CK3402		CSK115	DRC059				CT029SP
DR 650 RUN/RN/RUP/RP (SP44A/B)	92-93	CK3402		CSK115	DRC059				CT029SP
DR 650 RSEM/RSEN/RSEP (SP43A/B)	91-93	CK3402		CSK115	DRC059				CT029SP
DR 650 RER/RES (SP45A/B)	94-95	CK3402		CSK115	DRC142				CT029SP

EBC CLUTCH KITS

Make & Model	Year	CK Series #	CKF Series #	Spring Kit #	DRC Series #	DRCF Series #	SRC Series #	SRK Series #	CT Tool #
SUZUKI Contd.									
DR 650 SET/SEV	96-97	CK3386		CSK026	DRC087				CT024
GR 650 D/XD	83	CK3357	CKF3357	CSK026					CT029
GS 650 GX/GZ Katana	81-82	CK3330		CSK159					CT018SP
GS 650 GTX/GTZ/GTD	81-83	CK3330		CSK159					CT018SP
GSF 650 K5/K6 Naked Bandit - Non ABS	05-06	CK3357	CKF3357	CSK122					CT047SP
GSF 650 SK5/SK6 Faired Bandit - Non ABS	05-06	CK3357	CKF3357	CSK122					CT047SP
GSF 650 AK5/AK6 Naked Bandit - ABS Model	05-06	CK3357	CKF3357	CSK122					CT047SP
GSF 650 SAK5/SAK6 Faired Bandit - ABS Model	05-06	CK3357	CKF3357	CSK122					CT047SP
GSF 650 K7/K8/K9/L0/L1/L2 Naked Bandit - Non ABS	07-12	CK1218	CKF1218	CSK122					CT014
GSF 650 SK7/SK8/SK9/SLO/SL1/SL2 Faired Bandit - Non ABS	07-12	CK1218	CKF1218	CSK122					CT014
GSF 650 AK7/AK8/AK9/AL0/AL1/AL2 Naked Bandit - ABS	07-12	CK1218	CKF1218	CSK122					CT014
GSF 650 SAK7/SAK8/SAK9/SALO/SAL0/SAL1/SAL2 Faired Bandit - ABS	07-15	CK1218	CKF1218	CSK122					CT014
GSX 650 FK8/FK9/FLO/FL1/FL2 (Non ABS)	08-14	CK1218	CKF1218	CSK122					CT014
GSX 650 FAK8/FAK9/FALO/FAL1/FAL2 (ABS)	08-15	CK1218	CKF1218	CSK122					CT014
LS 650 Savage FG/PK/PM/PR/PG/PT/PV	87-97	CK3359		CSK026					CT029SP
SFV 650 K9/L0/L1/L2/L3/L4/L5 Gladius (Non ABS)	09-15	CK1219		CSK133			SRC082	SRK082	CT033SP
SFV 650 AK9/AL0/AL1/AL2/AL3/AL4/AL5 Gladius (ABS)	09-15	CK1219		CSK133			SRC082	SRK082	CT033SP
SV 650 X/Y/K1/K2 (Naked - Non ABS)	99-02	CK3377		CSK069			SRC081	SRK081	CT022
SV 650 SX/SY/SK1/SK2 (Faired - Non ABS)	99-02	CK3377		CSK069			SRC081	SRK081	CT022
SV 650 K3/K4/K5/K6/K7/K8/K9/L0 (Naked - Non ABS)	03-10	CK1219		CSK133			SRC082	SRK082	CT033SP
SV 650 SK3/SK4/SK5/SK6/SK7/SK8/SK9/SLO (Top Fairing - Non ABS)	03-15	CK1219		CSK133			SRC082	SRK082	CT033SP
SV 650 AK7/AK8/AK9/AL0 (Naked ABS Model)	07-10	CK1219		CSK133			SRC082	SRK082	CT033SP
SV 650 SAK7/SAK8/SAK9/SALO (Top Fairing - ABS Model)	07-15	CK1219		CSK133			SRC082	SRK082	CT033SP
SV 650 ABS	16-20	CK1219		CSK133			SRC082	SRK082	CT033SP
XF 650 V/W/X/Y Freewind	97-02	CK3386		CSK026	DRC087				CT024
XN 85 D Turbo	83	CK3347		CSK006					CT018SP
GS 700 EF/ESF	85	CK3330		CSK115					CT018SP
VS 700 GLFG/GLEFG/GLPH/GLEPH	86-87	CK3377		CSK115					CT029
DR 750 SJ/SK	88-89	CK3386		CSK115					CT024
GT 750 J/K/L/M/A/B	72-77	CK3324		CSK158					CT018SP
GS 750 B/DB/DC/EC/EN	77-79	CK3324		CSK006					CT018SP
GSR 750 L1/L2/L3	11-14	CK3417		CSK109					CT014
GSR 750 AL2/AL3/AL4/AL5 (ABS)	12-15	CK3417		CSK109					CT014
GSX 750 ET/EX	80-81	CK3330		CSK006					CT018SP
GSX 750 ESD/EFE/ESG/ESE/EFF	83-86	CK3330		CSK115					CT018SP
GSX 750 SE Katana	84	CK3330		CSK026					CT018SP
GSX 750 FK/FL/FM/FN/FP/FR/FS/FT/FV	89-97	CK3387		CSK012					CT036SP
GSX 750 FW/FX/FY/FK1-FK6	98-06	CK3357	CKF3357	CSK198					CT047SP
GSX 750 W/X/Y/K1	98-03	CK3357	CKF3357	CSK198					CT047SP
GSX 750 S/SS (GS75X-106815-)		CK3330		CSK006					CT018SP
GSX 750 S-2/S-2C (GS75X-114747-) Katana		CK3330		CSK006					CT018SP
GSXR 750 F/G/H (GR75A)	85-87	CK3348		CSK115			SRC013	SRK013	CT047SP
GSXR 750 RG (Dry Clutch - Sintered Friction)	86	CK3376		CSK198			N/A	SRK138	CT072SP
GSXR 750 J/K	88-89	CK3387		CSK012			SRC014	SRK014	CT036SP
GSXR 750 L/M/WN	90-92	CK3387		CSK198			SRC017	SRK017	CT036SP
GSXR 750 WP/WR/WS	93-95	CK3387		CSK198			SRC017	SRK104	CT036SP
GSXR 750 T/V/W/X (SRAD)	96-99	CK3417		CSK902			SRC040	SRK040	CT055SP
GSXR 750 Y	00	CK1229		CSK156			SRC071	SRK071	CT014
GSXR 750 K1/ K2/K3	01-03	CK3465		CSK156			SRC111	SRK111	CT014
GSXR 750 K4/K5	04-05	CK3417		CSK075			SRC121	SRK121	CT014
GSXR 750 K6/K7	06-07	CK3456	CKF3456	CSK205			SRC088	SRK088	CT015
GSXR 750 K8/K9/L0	08-10	CK3456	CKF3456	CSK205			SRC088	SRK109	CT015
GSX-R 750	11-21	CK3456	CKF3456	CSK183			SRC110	SRK110	CT015
GSX-S 750	2015-2021	CK3417					SRC169	SRK169	CT015
GSXR 750 L1/L2/L3/L4/L5	11-15	CK3456	CKF3456	CSK183			SRC110	SRK110	CT015
VS 750 GLF/GLFG/GLFH/GLPG/GLPK/GLPL/GLPM/GLPH /GLEFH/GLEPH (VR51A)	85-91	CK3377		CSK115					CT029
DR 800 SL (SR43A)/SM/SN/SP/SR/SS (SR43B)	90-95	CK3386		CSK115					CT024
DR 800 ST/SV (SR43B)	96-97	CK3386		CSK115					CT024
VS 800 GLN/GLP/GLR/GLS/GLT/GLV	92-97	CK3377		CSK115					CT029
VL 800 K1-K5 Intruder Volusia	01-05	CK3377		CSK066					CT029
C 800 Intruder - Spoke Wheels (VL 800 K6/K7/K8/K9/L0/L1/L2/L3/L5)	06-15	CK3377		CSK066					CT029
C 800 C Intruder - Cast Wheels (VL 800 CK7/CK8/CK9/CLO/CL1/CL2/CL3)	07-15	CK3377		CSK066					CT029
C 800 Intruder - Cast Wheels (VL 800 BLT4)	14	CK3377		CSK066					CT029
VX 800 L/M/N/P/R/T (8 Spring CSK Kit)	90-96	CK3377		CSK162					CT029
VZ 800 V/W/X/Y/K1/K2 Marauder (8 Spring CSK Kit)	97-02	CK3377		CSK162					CT029
M 800 (VZ 800 K5-K9/L0/L1/L3) Intruder M800	05-13	CK3377		CSK066					CT029
M 800/T (VZ 800 L4/L5 Intruder M 800/T)	14-15	CK3377		CSK066					CT029

CLUTCH APPLICATIONS

EBC CLUTCH KITS

Make & Model	Year	CK Series #	CKF Series #	Spring Kit #	DRC Series #	DRCF Series #	SRC Series #	SRK Series #	CT Tool #
SUZUKI Contd.									
M 800 Z (VZ 800 K9Z Intruder M 800Z)	09-10	CK3377		CSK066					CT029
GS 850 GN/GT/GX/GZ/GF/GG	79-85	CK3330		CSK006					CT018SP
RF 900 RR	1994	CK3418		CSK902			SRC039	SRK039	CT055SP
RF 900 RS/R2S/RT/RV/RW	95-98	CK3417		CSK029					CT014
DL 1000 K2-K9/L0 V-Strom	02-10	CK3443	CKF3443	CSK043					CT021
DL 1000 V-Strom ABS	14-21	CK3443	CKF3443	CSK043					CT021
DL 1000 V-Strom Adventure	14-21	CK3443	CKF3443	CSK043					CT021
GS1000 HC/EC/EN/SN/ET	78-80	CK3345		CSK158			SRC115	SRK115	CT035SP
GS 1000 GT/GX	80-81	CK3335		CSK006			SRC050	SRK050	CT024SP
GSX 1000 SZ	82	CK3335		CSK006			SRC050	SRK050	CT024SP
GSX-R 1000 K1/K2/K3/K4	01-04	CK4510	CKF4510	CSK128			SRC089	SRK089	CT004
GSX-R 1000 K5/K6/K7/K8	05-08	CK3451	CKF3451	CSK145			SRC085	SRK085	CT015
GSX-R 1000 K9/L0/L1	09-11	CK3462	CKF3462	CSK160			SRC097	SRK097	CT009
GSX-R 1000 L2/L3/ZL3/L4/ZL4/AL5/L5/AL6	12-16	CK3462	CKF3462	CSK196			SRC120	N/A	CT009
GSX-R 1000 ABS	17-21	CK3468		CSK242			SRC142	SRK142	CT009
GSX-S 1000	16-17	CK4510	CKF4510	CSK223					CT004
GSX-S 1000 ABS	16-17	CK4510	CKF4510	CSK223					CT004
GSX-S 1000	18-21	CK3451	CKF3451	CSK145			SRC085	SRK085	CT015
GSX-S 1000 ABS	18-21	CK3451	CKF3451	CSK145			SRC085	SRK085	CT015
GSX-S 1000 F	16-17	CK4510	CKF4510	CSK223					CT004
GSX-S 1000 F ABS	16-17	CK4510	CKF4510	CSK223					CT004
GSX-S 1000 F	18-21	CK3451	CKF3451	CSK145			SRC085	SRK085	CT015
GSX-S 1000 F ABS	18-21	CK3451	CKF3451	CSK145			SRC085	SRK085	CT015
Katana	19-21	CK3451	CKF3451	CSK145			SRC085	SRK085	CT015
SV 1000 K3/K4/K5/K6/K7 (Naked)	03-07	CK3443	CKF3443	CSK114					CT021
SV 1000 SK3/SK4/SK5/SK6/SK7 (Faired)	03-07	CK3443	CKF3443	CSK114					CT021
TL 1000 SV/SW	97-98	CK3417		CSK078					CT014
TL 1000 RW/RX/RV	98-00	CK3428		CSK071			SRC068	SRK068	CT009
TL 1000 SX/SY	99-00	CK3428		CSK071			SRC068	SRK068	CT009
TL 1000 SK1	01-02	CK3435		CSK071					CT009
TL 1000 RK1	01-02	CK3435		CSK071					CT009
GS 1100 GZ	82	CK3335		CSK006			SRC050	SRK050	CT024SP
GSX 1100 ET/EX/EZ	80-82	CK3335		CSK006			SRC050	SRK050	CT024SP
GSX 1100 SZ	82	CK3335		CSK006			SRC050	SRK050	CT024SP
GSX 1100 SD	83	CK3346		CSK006					CT024SP
GSX 1100 ESD	83	CK3346		CSK006					CT024SP
GSX 1100 EFE/EFG/ESF	84-86	CK3335		CSK006			SRC050	SRK050	CT024SP
GSX 1100 FJ/FK/FL/FM/FN/FP/FR	88-94	CK3381		CSK012					CT048SP
GSX 1100 GM/GN	91-94	CK3392		CSK902			SRC010	SRK010	CT055SP
GSXR 1100 G/H/J	86-88	CK3381		CSK026			SRC015	SRK015	CT048SP
GSXR 1100 K/L/M/N	89-92	CK3392		CSK902			SRC010	SRK010	CT055SP
GSXR 1100 WP/WR/WS/WT	93-96	CK3418		CSK902			SRC039	SRK039	CT055SP
GS 1200 SSK/ZK1 (GV78A)	01	CK3417		CSK902			SRC040	SRK040	CT055SP
GSF 1200 T/V/W/X/Y (Naked Bandit - 4 Piston Caliper)	96-00	CK3417		CSK902			SRC040	SRK040	CT055SP
GSF 1200 K1/K2/K3/K4/K5 (Naked Bandit - 6 Piston caliper)	01-05	CK3417		CSK902			SRC040	SRK040	CT055SP
GSF 1200 ST/SV/SW/SX/SY (Faired Bandit - 4 Piston Caliper)	96-00	CK3417		CSK902			SRC040	SRK040	CT055SP
GSF 1200 SAV ABS Bandit	97	CK3417		CSK902			SRC040	SRK040	CT055SP
GSF 1200 SK1/SK2/SK3/SK4/SK5 (Faired Bandit - 6 Piston caliper)	01-05	CK3417		CSK902			SRC040	SRK040	CT055SP
GSF 1200 K6/AK6 (Naked Bandit - Non & ABS Version - 4 Piston caliper)	06	CK3417		CSK902			SRC040	SRK040	CT055SP
GSF 1200 SK6/SAK6 (Faired Bandit - Non & ABS Version - 4 Piston caliper)	06	CK3417		CSK902			SRC040	SRK040	CT055SP
GSF 1200 SFK7 Bandit Streetfighter	07-09	CK3459		CSK124					CT021
GSX 1200 FSW/FSX Inazuma (GV76A)	98-99	CK3417		CSK902			SRC040	SRK040	CT055SP
GV 1200 GLF/GLF2/GLG Madura	85-86	CK3375		CSK115					CT029
GSF 1250 K7/K8/K9 (Naked Bandit - Non ABS - 4 Piston caliper)	07-10	CK3459		CSK124					CT021
GSF 1250 AK7/AK8 (Naked Bandit - ABS Model - 4 Piston caliper)	07-10	CK3459		CSK124					CT021
GSF 1250 SK7/SK8/SK9/SLO (Faired Bandit - ABS Model - 4 Piston Caliper)	07-10	CK3459		CSK124					CT021
GSF 1250 SAK7/SAK8/SAK9/SAZK9/SALO (Faired Bandit - ABS Model - 4 Piston Caliper)	07-15	CK3459		CSK124					CT021
GSX 1250 FALO/FAL1/FAL2	10-15	CK3459		CSK124					CT021
GSX 1250 FAL0ST/FAL1ST Sports Touring	10-14	CK3459		CSK124					CT021
GSX 1300 RX Hayabusa	99	CK3430		CSK072			SRC067	SRK067	CT021
GSX 1300 RY/RK1 Hayabusa	00-01	CK3430		CSK171					CT021
GSX 1300 RK2/RZK3/RK3/RK4/RK5/K6/K7	02-07	CK3443	CKF3443	CSK171					CT021
GSX 1300 RK8/RK9/RL0/RL1/RL2/RAL3 /RAL4/RAL5 Hayabusa	08-15	CK3443	CKF3443	CSK139					CT021
GSX 1300 BKK8/BBK9/BKLO/BKL1 B-King	08-12	CK3443	CKF3443	CSK139					CT021

EBC CLUTCH KITS

Make & Model	Year	CK Series #	CKF Series #	Spring Kit #	DRC Series #	DRCF Series #	SRC Series #	SRK Series #	CT Tool #
SUZUKI Contd.									
GSX 1400 K1	01	CK3445		CSK089					CT009
GSX 1400 K2/K3/K4/K5/K6/K7	02-07	CK3439		CSK089			SRC133	SRK133	CT009
GV 1400 Cavalcade (All models)	85-88	CK3388		CSK115					CT029
VS 1400 GLPH/GLPJ/GLFH/GLFJ/GLPR/GLPT/GLPV /GLPW/GLPY/GLPK1/GLPK2	87-03	CK3382		N/A					CT029
VL 1500 W/X/Y/K1/K2/K3 Intruder Legendary Classic	98-03	CK3335		CSK031					CT024SP
VL 1500 K5/K6/K7/K8/K9 (C 1500 Intruder)	05-09	CK3335		CSK031					CT024SP
VL 1500 BTL3/BTL4/BTL5 (C 1500 BT Intruder)	13-14	CK3459		TBA					CT021
M 1500 (VZ 1500 K9/L0) (M 1500 Intruder)	09-13	CK3459		TBA					
M 1600 (VZ 1600 K4/K5) (M 1600 Marauder)	04-05	CK4455		N/A					CT032
C 1800 R Intruder (VLR 1800 K8/K9/L0/L1)	08-13	CK3463		CSK075					
C 1800 RT Intruder (VLR 1800 K8RT/K9RT)	08-09	CK3463		CSK075					
M 1800 R (VZR 1800 K6/K7/K8/K9)									
(M 1800 R Intruder - With handlebar cowling)	06-09	CK3457		CSK122					
M 1800 R2 (VZR 1800 NK8/NK9 Intruder - M1800R2 - No handlebar cowling)	08-09	CK3457		CSK122					
M 1800 RZ (VZR1800 ZK7/ZK8/ZL1/ZL2/ZL3 - M1800RZ - With handlebar cowling)	07-13	CK3457		CSK122					
M 1800 RB (VZR 1800 BZL4/BZL5 - M 1800 RB)	14-15	CK3457		CSK122					
YAMAHA									
FS1 E/FS 1 DX	74-80	CK2205		CSK042					CT044
FS1	87-90	CK2205		CSK042					CT044
FS1 SE	81-82	CK2205		CSK042					CT044
DT 50 M	78-79	CK2206		CSK042					CT044
DT 50 M/MX	80-95	CK2205		CSK042					CT044
DT 50 LC	98	CK2206		CSK042					CT044
DT 50 R	97-08	CK2348		N/A					
DT 50 X (Supermotard)	04-08	CK2348		N/A					
RD 50 M	78-79	CK2206		CSK042					CT044
RD 50 M/MX	80-83	CK2205		CSK042					CT044
RD 50	86-87	CK2205		CSK042					CT044
RZ 50 (5FC1/2)	02	CK2238		CSK042					CT044
TT 50 E	06-15	TBA		N/A					
TY 50/TY 50 M (1F4/1G7)	77-78	CK2206		CSK042					CT044
TY 50 M (2K0)	80	CK2205		CSK042					CT044
T 50	86	CK2302		N/A					
TZR 50 (5 Plate Kit)	97-03	CK2349		N/A					
TZR 50 (4 Plate Kit)	04-16	CK2348		N/A					
V 50 M/P	75-77	CK2303		N/A					
YFM 50 S/T/RV/RW/RX Raptor	04-08	CK2303		N/A					
YZ 50 G/H/J/K	80-83	CK2206		CSK042					CT044
YZ 65 J	19-21	CK2304		CSK042					CT010
DT 80 LC1 (37A) - 4 Plate Clutch	81-84	CK2238		CSK042					CT044
DT 80 LC2 (53A) - 5 Plate Clutch	85-92	CK2254	CKF2254	CSK042					CT044
DT 80 MX Type 5J2	81-82	CK2206		CSK042					CT044
DT 80 MX Type 12X	83	CK2206		CSK042					CT044
DT 80 MX Type 36N	83-85	CK2238		CSK001					CT044
DT 80 MXS	84	CK2238		CSK042					CT044
PW 80 (All models)	83-06	CK2303		N/A					
RD 80	82	CK2206		CSK042					CT044
RD 80 LC	82	CK2238		CSK042					CT044
T 80	83-97	CK2303		N/A					
TY 80	77-83	CK2206		CSK042					CT044
V 80	79-83	CK2303		N/A					
YFM 80 D/E/F/G/H/J/K/L/M/N Badger	91-01	CK2303		N/A					
YFM 80 WP/WR/WS/RT/RV/RW/RX Raptor	02-08	CK2303		N/A					
YFM 80 GT/GV/GW/GX Grizzly	05-08	CK2303		N/A					
YZ 80 D	77	CK2238		CSK042					CT044
YZ 80 E/F	78-79	CK2254	CKF2254	CSK042					CT044
YZ 80 G	80	CK2238		CSK042					CT044
YZ 80 H/J/K/L/N	81-85	CK2287		CSK042					CT010
YZ 80 S/T/U/W	86-89	CK2304		CSK042	DRC027				CT010
YZ 80 E/LC/LW/F	93-94	CK2304		CSK039	DRC066				CT010
YZ 80 G/H/J/K/L/M/N	95-01	CK2335	CKF2335	CSK042	DRC078				CT010
YZ 85 (2T/Small Wheel F 17 Inch/R 14 Inch)	02-21	CK2335	CKF2335	CSK042	DRC111	DRCF111			CT010
YZ 85 (2T/Big Wheel F 19 Inch/R 16 Inch)	02-21	CK2335	CKF2335	CSK042	DRC111	DRCF111			CT010
TT-R 90 M/N/P/R/ES/S/ET/T/EV/EW	00-07	CK2354		N/A					
T 90 N/D (4NM1-9) Mate	00-	CK2354		N/A					
AG 100 E Farm Bike	93	CK2208		CSK001					CT039
AG 100 J (3HAA)	82	CK2208		CSK001					CT039
DT 100	76-80	CK2236		CSK042					CT039
RS 100 478	75-76	CK2208		CSK042					CT039
RS 100 (1Y8 Europe)	77-78	CK2254	CKF2254	CSK042					CT044

EBC CLUTCH KITS

Make & Model	Year	CK Series #	CKF Series #	Spring Kit #	DRC Series #	DRCF Series #	SRC Series #	SRK Series #	CT Tool #
YAMAHA Contd.									
RS 100 S (1Y8 UK)	77-78	CK2254	CKF2254	CSK042					CT044
RS 100 DX (1Y8 Europe)	79	CK2254	CKF2254	CSK042					CT044
RS 100 (1Y9 UK)	79-81	CK2254	CKF2254	CSK042					CT044
RS 100 (1Y8 Europe)	80-82	CK2254	CKF2254	CSK042					CT044
RT 100 E/F/K	93-03	CK2254	CKF2254	CSK001					CT044
RXS 100	83-97	CK2254	CKF2254	CSK001					CT044
YB 100	78-92	CK2207		N/A					CT044
YZ 100 E/F/G/H/J/K	78-83	CK2234		CSK039					CT039
T 105/105 E Crypton	96	CK2354		N/A					
T 105 E (5ER1/2)	99	CK2354		N/A					
V 110 ZE/ZK/ZHE/ZHK/FIZR/FIZR Sporty		CK2354		N/A					
TT-R 110 E	08-21	CK2375		CSK150					
RX 115 (5FS3)	99	CK2254	CKF2254	CSK042					CT044
AS3 125	71-72	CK2236		CSK042					CT039
DT 125	74	CK2209		CSK042					CT039
DT 125/125 F	76-77	CK2236		CSK039					CT039
DT 125 E	78-79	CK2236		CSK001					CT039
DT 125 MX	80-81	CK2236		CSK042					CT039
DT 125 LC Type 10V	82	CK2281		CSK042					
DT 125 LC Type 12W	82	CK2281		CSK042					
DT 125 LC Type 26G	83	CK2281		CSK042					
DT 125 LC Type 35A	85-87	CK2283		CSK042					CT044
DT 125 R	88-03	CK2313	CKF2313	CSK042	DRC042	DRCF042			CT010
DT 125 RE	04-07	CK2313	CKF2313	CSK042	DRC042	DRCF042			CT010
DT 125 (3TT4)	96	CK2283		CSK042					CT044
DT 125 X	05-06	CK2313	CKF2313	CSK042	DRC042	DRCF042			CT010
IT 125 G/H/J	80-82	CK2234		CSK042					CT044
MT 125 (Non ABS)	14-16	CK1119		CSK208					CT088
MT 125 A (ABS)	14-18	CK1119		CSK208					CT088
RD 125	73-74	CK2236		CSK042					CT039
RD 125 DX	75-76	CK2236		CSK042					CT039
RD 125 DX	78-81	CK2254	CKF2254	CSK042					CT044
RD 125 LC (MK1-MK3)	82-87	CK2283		CSK042					CT044
RZ 125 (1GV 030101-)	85	CK2283		CSK042					CT044
RS 125/RS 125 DX	75-76	CK2236		CSK042					CT039
RS 125	77-81	CK2254	CKF2254	CSK042					CT044
SR 125 SE	81-83	CK2256		CSK052					CT039
SR 125	89-03	CK2256		CSK052					CT039
TDR 125 (3HS1/3XD0/3HS3/3XD1)	89-93	CK2313		CSK042					CT010
TDR 125 (4GH/GX 1/2/3/4)	93-03	CK2313	CKF2313	CSK042	DRC042	DRCF042			CT010
TDR 125 R (3HS2/3XE2) Lightburner	93-94	CK2313	CKF2313	CSK042					CT010
TT-R 125	00-21	CK2254	CKF2254	CSK042	DRC230	DRCF230			CT044
TW 125 (5EK) 4 Friction Plate Type	99-02	CK2256		CSK052					CT039
TW 125 (5RS) 5 Friction Plate Type	03-04	CK2234		CSK052					CT039
TZR 125 (2RK/3PC1/2/3)	87-92	CK2304		CSK042					CT010
TZR 125 (3JB/4JB/4HW/4HX)	93-95	CK2313	CKF2313	CSK042					CT010
TZR 125 R (4DL1/4DL2)	91-93	CK2313	CKF2313	CSK042					CT010
TZR 125 RR (4DL3)	94-95	CK2313	CKF2313	CSK042	DRC042	DRCF042			CT010
TY 125	80-82	CK2234		CSK042					CT039
WR 125 R	09-15	CK2292		CSK212					CT061
WR 125 X (Supermoto)	09-16	CK2292		CSK212					CT061
XV 125 Virago	97-00	CK2316		CSK002					CT008
XVS 125 Drag Star (5XJ1)	00	CK2316		CSK002					CT008
XVS 125 Drag Star (5XJ3/5XJ5/5XJ7)	01-04	CK2250		CSK002					CT008
XT 125	82-83	CK2256		CSK052					CT039
XT 125 R (3D61/3D63) - 5 Friction plate type	05-06	CK2254	CKF2254	CSK042					CT044
XT 125 R (13D1) - 5 Friction plate type	07	CK2254	CKF2254	CSK042					CT044
XT 125 R (13D3/13D5) - 4 Friction plate type	07-11	CK1151	CKF1151	CSK042					CT012
XT 125 X (3D62/3D64) - 5 Friction plate type	05-06	CK2254	CKF2254	CSK042					CT044
XT 125 X (13D2) - 5 Friction plate type	07	CK2254	CKF2254	CSK042					CT044
XT 125 X (13D4/13D6) - 4 Friction plate type	07-11	CK1151	CKF1151	CSK042					CT012
XTZ 125 (5RM) (5 plate clutch)	03-10	CK2254	CKF2254	CSK042					CT044
YBA 125 Enticer (3P01/3P41)	05-06	TBA		TBA					
YBR 125 ED (3D91/3D92/3D9) - 4 Plate type	06-09	CK1151	CKF1151	N/A					CT012
YBR 125 ED (51D1/2) - 4 Plate type	10-16	CK1151	CKF1151	N/A					CT012
YBR 125 E/K (5HH1/2/C/G/J/5LX/5LX9)									
(Drum Front/Brazil) - 5 Friction plate type	00-06	CK2254	CKF2254	CSK042					CT044
YBR 125 ED (5HHB/F/H) (Disc front/Brazil) - 5 Friction plate type	06-08	CK2254	CKF2254	CSK042					CT044
YBR 125 Custom - 4 Friction plate type	08-16	CK1151	CKF1151	N/A					CT012
YZ 125 C (2T)	76	CK2234		CSK039					CT039
YZ 125 D/E (2T)	77-78	CK2235		CSK039					CT039
YZ 125 F (2T)	79	CK2234		CSK042					CT039
YZ 125 G (2T)	80	CK2234		CSK039					CT039

EBC CLUTCH KITS

Make & Model	Year	CK Series #	CKF Series #	Spring Kit #	DRC Series #	DRCF Series #	SRC Series #	SRK Series #	CT Tool #
YAMAHA Contd.									
YZ 125 H (2T)	81	CK2235		CSK039					CT039
YZ 125 J (2T)	82	CK2276		CSK039					
YZ 125 K/L/N (2T)	83-85	CK2278		CSK039					CT054SP
YZ 125 S/T (2T)	86-87	CK2278		CSK002	DRC028				CT054SP
YZ 125 U (2T)	88	CK2312		CSK002	DRC029				CT054SP
YZ 125 W/A (2T)	89-90	CK2311		CSK002	DRC030				CT054SP
YZ 125 B/D (2T)	91-92	CK2319		CSK081	DRC039				CT005
YZ 125 E/F/G (2T)	93-95	CK2325	CKF2325	CSK081	DRC070	DRCF070			CT005
YZ 125 H (2T)	96	CK2325	CKF2325	CSK014	DRC085	DRCF085			CT005
YZ 125 J/K/L/M/N (2T)	97-01	CK2325	CKF2325	CSK081	DRC070	DRCF070			CT005
YZ 125 P/R/S (2T)	02-04	CK2325	CKF2325	CSK014	DRC085				CT005
YZ 125 T/V/W/X/Y/Z/A/B/D/E/F/G (2T)	05-16	CK2325	CKF2325	CSK081	DRC070	DRCF070			CT005
YZF-R 125 (Standard Mount Front Caliper)	08-13	CK2292		CSK212					CT061
YZF-R 125 (Radial Mount Front Caliper/Non ABS)	14-18	CK1119		CSK208					CT088
YZF-R 125 A (Radial Mount Front Caliper/ABS)	14-18	CK1119		CSK208					CT088
RX 135 (13X)	81	CK2283		CSK042					CT044
T 135 HC/S (2S61) Crypton X/Jupiter MX/Spark 135									
/Exciter/135 LC Sniper	06-08	TBA		TBA					
T 135 SE (1S71) Crypton X/Jupiter MX/Spark 135									
/Exciter/135 LC Sniper	06-08	TBA		TBA					
TZR 150 R (4AP2)	00	CK2313	CKF2313	CSK042					CT010
DT 175	74-75	CK2209		CSK042					CT039
DT 175	76-77	CK2236		CSK039					CT039
DT 175 MX	78-81	CK2245		CSK042					CT039
DT 175 (3TS4)	96	CK2365		CSK042					CT044
IT 175 G/H/J	80-82	CK2235		CSK039					CT039
TY 175	77-80	CK2234		CSK042					CT039
AG 200 E (3GX6)	93	CK2292		CSK149	DRC055				CT039
DT 200 (2LR)	87	CK2313	CKF2313	CSK042					CT010
DT 200 WR 3XP	92-93	CK2313	CKF2313	CSK042					CT010
IT 200 L	84	CK2235		CSK001					CT039
RD 200 DX	76-81	CK2209		CSK042					CT039
RS 200	79-80	CK2209		CSK042					CT039
SDR 200 (2TV)	87-89	CK2313	CKF2313	CSK042	DRC042	DRCF042			CT010
TW 200 (2JL/4CS1/2/3/5)	91-98	CK2234		CSK149	DRC231				CT039
TW 200 (4CS4/6/5LB1/2)	98-01	CK2234		CSK149	DRC231				CT039
WR 200 D/E/F	92-94	CK2313	CKF2313	CSK042	DRC042	DRCF042			CT010
YFM 200 DKW/DX/DXA	86-90	CK2287		CSK149	DRC232				CT010SP
YFS 200 B/F/G/H/J/K/L/M/N/P/R/S/T/V Blaster	91-06	CK2313	CKF2313	CSK042	DRC042	DRCF042			CT010
YTM 200 EL/DX	89	CK2304		N/A					CT010
ST 225 (5BT) Bronco	97	CK2324		CSK149	DRC229				CT039
TDM 225	05	TBA		TBA					
TW 225 E (5VC1/2)	02-03	CK2234		CSK149	DRC229				CT039
XT 225 (2LN) Serrow (1KH 020101-)	86-87	CK2324		CSK149	DRC229				CT039
XT 225 (3RW1/2/4/5 Serrow) (1KH 034101-132000)	89-93	CK2324		CSK149	DRC229				CT039
XT 225 S (3RW3 Serrow) (1KH 034101-132000)	92	CK2324		CSK149	DRC229				CT039
XT 225 (3RW4) Serrow (1KH 080101-)	92	CK2324		CSK149	DRC229				CT039
XT 225 W (4JG1/2/3/4) Serrow	93-95	CK2324		CSK149	DRC229				CT039
XT 225 WE (4JG5/6) Serrow	97-98	CK2324		CSK149	DRC229				CT039
XT 225 (4VW1/3/5/7/9) (4VWA/B/D/G/J/L) (Brasil)	97-06	CK2324		CSK149	DRC229				CT039
YFM 225 N/S/T/U	85-89	CK2287		CSK149					CT010SP
YTM 225 DRN	85	CK2287		CSK052	DRC104				CT010SP
DT 230 R Lanza (4TP1/2)	97-98	CK2313	CKF2313	CSK042	DRC042	DRCF042			CT010
YFU1W/TW Pro Hauler Pro 4 (230cc)	89	CK2287		CSK052	DRC104				CT010SP
DT 250	75-76	CK2240		CSK002					CT008
DT 250 MX	77-80	CK2223		CSK002					
FZR 250	87	CK2331		CSK034			SRC034	SRK034	CT010
FZR 250 R (3LN1/3/5/6/7)		CK2331		CSK034			SRC034	SRK034	CT010
FZX 250 Zeal (3YX1/2/4)	91-92	CK2331		CSK034			SRC034	SRK034	CT010
IT 250 G	80	CK2250		CSK002					CT008
IT 250 H/J	81-82	CK2279	CKF2279	CSK002					CT008
IT 250 L	84	CK2280		CSK002					CT060
RD 250/A/B	73-75	CK2240		CSK039					CT008
RD 250 C/D/E/F	76-79	CK2240		CSK002					CT008
RD 250 LC	80-82	CK2240		CSK002					CT008
RZ 250 R (1AR/1XG)		CK2240		CSK002					CT008
RZ 250 R (29L)		CK2240		CSK002					CT008
RZ 250 RR (51L)		CK2240		CSK002					CT008
RZ 250 (4L3)		CK2240		CSK002					CT008
RI-Z (250cc/3XC)	90-92	CK2319		CSK052					CT005
XT 250 Serrow (3C51/2)	05-08	CK2370	CKF2370	CSK081					CT005
SR 250 (US Custom/3Y8/6 Plate Clutch)	80-81	CK2267		CSK002					CT008
SR 250 SE (Special/3Y8/5 Plate Clutch)	81-83	CK2261		CSK002					CT008
SR 250 (4GR1/2/3/4/5 Plate Clutch)	94-96	CK2261		CSK002					CT008

EBC CLUTCH KITS

Make & Model	Year	CK Series #	CKF Series #	Spring Kit #	DRC Series #	DRCF Series #	SRC Series #	SRK Series #	CT Tool #
YAMAHA Contd.									
SR 250 (Classic/21L/5 Plate Clutch)	96-00	CK2261		CSK002					CT008
SRV 250 Soulful Twin/Renaissa (4DN1-6)	92-97	CK2316		N/A					CT008
SRX 250		CK2261		CSK049					CT008
TDR 250 (3CK1/3CK2 Europe - Eng/Frame # 3CK)	88-92	CK2319		CSK052					CT025
TT 250 R (4GY1 Japan - 6 Plate Clutch)	93-94	CK2370	CKF2370	CSK049					CT005
TT 250 R (4RR1/2 Japan - 6 Plate Clutch)	95-97	CK2370	CKF2370	CSK049					CT005
TT 250 R (4GY3/4GY5/4WA1 - Raid - Japan - 6 Plate Clutch)	94-96	CK2370	CKF2370	CSK049					CT005
TT 250 R (4MR2 - UK - 6 Plate Clutch)	96	CK2370	CKF2370	CSK049					CT005
TT 250 RL (4PX5 - 6 Plate Clutch)	99	CK2370	CKF2370	CSK049					CT005
TT 250 RM (4PX6 - 7 Plate Clutch)	00	CK2319		CSK014	DRC226				CT005
TYR 250 D/E	77-78	CK2240		CSK002					CT008
TY 250 S/R	84-90	CK2295		CSK059					CT060
TY 250 R	91-92	CK2295		CSK059					CT060
TY 250 Z	93-96	CK2319		CSK002					CT005
TZR 250 (2MA/2XW1/2XW2 Europe - Eng/Frame # 2MA -)	87-92	CK2319		CSK052					CT025
TZR 250 (1KT/2AW Japan - Eng/Frame # 1KT - 000/056-)	87	CK2319		CSK052					CT025
TZR 250 (2XT1 Japan - Eng/Frame # 1KT - 09-)	88	CK2319		CSK052					CT025
TZR 250 (3MA1 - Reverse Cylinder - Eng/Frame # 3MA 0001-)	89	CK2342		CSK081					CT008
TZR 250 (3MA3/3MA5 - Reverse Cylinder - Eng/Frame # 3MA -0.793103448275862 -)	89-90	CK2342		CSK081					CT008
TZR 250 SP (3MA4 - Eng/Frame # 3MA 55 -)	90	N/A		CSK002					
TZR 250 R (3XV1/3XV4/3XV6 - V-Twin - Eng/Frame # 3XV 000101-08600)	91-93	CK2319		CSK014					CT005
TZR 250 RS (3XV8/3XV9/3XVA - V-Twin - Eng/Frame # 3XV 080101-08200/088-)	92-94	N/A		N/A					
TZR 250 SPR (3XVC - V-Twin - Eng/Frame # 3XV -107101)	95	N/A		N/A					
WR 250 ZB/ZD/ZE (2T)	91-93	CK2309		CSK081					CT020
WR 250 ZF/ZG/ZH/ZJ/ZK (2T)	94-98	CK2274	CKF2274	CSK081					CT020
WR 250 FN/FP/FR/FS/FT/FV/FW/FX/FY/FZ/FA/FB/FD (4T)	01-13	CK2355	CKF2355	CSK002	DRC119	DRCF119			CT005
WR 250 FF/FG (4T/Reverse Cylinder)	15-21	CK2355	CKF2355	TBA					CT005
WR 250 R L	20-21	CK2319		CSK014	DRC226				CT005
WR 250 RX/RY (32D1/3)	08-15	CK2319		CSK014	DRC226				CT005
WR 250 XX/XY (Supermoto) (32D2/4)	08-15	CK2319		CSK014	DRC226				CT005
XG 250 Tricker (5XT1)	04-06	CK2370	CKF2370	CSK081					CT005
XS 250 C/D/E	78-80	CK2279	CKF2279	CSK002					CT008
XS 250 SE/C	80-81	CK2250		CSK049					CT008
XT 250	80	CK2267		CSK001					CT008
XT 250 Sorrow (3C51/2)	05-08	CK2370	CKF2370	CSK081					CT005
XTZ 250 Lander (Brasil) (4B41/2/3)	07-09	CK1217		CSK132					CT014
XV 250 Virago	89-94	CK2316		CSK002					CT008
XV 250 S Virago	95-00	CK2316		CSK002					CT008
XVS 250 Dragstar	01-04	CK2250		CSK002					CT008
YBR 250 (5D11/3/4)	07-11	CK1217		CSK132					CT014
YDS7 250cc	72	CK2240		CSK039					CT008
YFB 250 D/E/F/G/H/J/K/FWF/FWG/FWH/FWJ /FWK/FWL/FWM	92-00	CK2287		CSK052	DRC104				CT010SP
YFM 250 W/A/B	90-92	CK2287		CSK052	DRC104				CT010SP
YFM 250 XN/XP/XR/XS Bear Tracker	00-04	CK2287		CSK052	DRC104				CT010SP
YFM 250 FN	01	CK2287		CSK052	DRC104				CT010SP
YFM 250 BT/BV Bruin	05-06	CK2287		CSK052	DRC104				CT010SP
YFM 250 BW/BX/BY Big Bear	07-10	CK2287		CSK052	DRC104				CT010SP
YFM 250 R (33B)	09-11	CK2370	CKF2370	CSK058	DRC200	DRCF200			CT005
YFM 250 R (1BT)	12-13	CK2370	CKF2370	CSK058					CT005
YTZ 250 N/S (TRI Z)	85-86	CK2280		CSK002	DRC032				CT060
YS 250 Fazer (Brasil) (1S41/2/3)	06-08	CK1217		CSK132					CT014
YZ 250 D/E (2T)	77-78	CK2244		CSK002					CT008
YZ 250 F (2T)	79	CK2250		CSK002					CT008
YZ 250 G (2T)	80	CK2244		CSK002					CT008
YZ 250 H (2T)	81	CK2279	CKF2279	CSK002					CT008
YZ 250 J/K/L (2T)	82-84	CK2280		CSK002					CT060
YZ 250 N/S/T (2T)	85-87	CK2280		CSK103	DRC035				CT060
YZ 250 U/W/A/B/D (2T)	88-92	CK2309		CSK081	DRC031				CT020
YZ 250 E/F/G/H/J/L (2T)	93-99	CK2274	CKF2274	CSK081	DRC071				CT020
YZ 250 M/N (2T)	00-01	CK2274	CKF2274	CSK049	DRC097				CT020
YZ 250 (2T)	02-20	CK2274	CKF2274	CSK092	DRC113	DRCF113			CT020
YZ 250 FN/FP/FR/FS/FT/FV/FW (4T)	01-07	CK2355	CKF2355	CSK191	DRC109	DRCF109			CT005
YZ 250 FX/FY/FZ/FA/FB/FD (4T)	08-13	CK2355	CKF2355	CSK137	DRC227	DRCF227			CT005
YZ 250 FE/FF (4T)	14-15	CK2355	CKF2355	CSK214	DRC288	DRCF288			CT005
YZ 250 F (4T)	16-21	CK2361	CKF2361		DRC313	DRCF313			
YZ 250 FG (270mm Disc)	16-18	CK2355	CKF2355	CSK214	DRC288	DRCF288			CT020

CLUTCH APPLICATIONS

EBC CLUTCH KITS

Make & Model	Year	CK Series #	CKF Series #	Spring Kit #	DRC Series #	DRCF Series #	SRC Series #	SRK Series #	CT Tool #
YAMAHA Contd.									
YZ 250 FGY (60th Anniversary Edition/270mm Disc)	16	CK2355	CKF2355	CSK214	DRC288	DRCF288			CT020
YZ 250 F FK	19	CK2387	CKF2387		DRC315	DRCF315			
MTN 320 A (MT03 321cc)	2016	CK1193		CSK219			SRC128	SRK128	CT080
MT-03	12-21	CK1193		CSK219			SRC128	SRK128	CT080
YZF-R3 (321cc/ABS)	15-21	CK1193		CSK219			SRC128	SRK128	CT080
R5/5A/5B 350cc	70-72	CK2240		CSK039					CT008
RD 350/A/B	73-75	CK2240		CSK039					CT008
RD 350 LC/YPVS	80-84	CK2240		CSK002					CT008
RD 350 N/F/F2/R	85-95	CK2240		CSK002					CT008
TT 350 A (3GJ)	90-95	CK2240		CSK014	DRC056				CT008
TT 350 (ITJ)	85-89	CK2240		CSK014	DRC056				CT008
XT 350	85-95	CK2240		CSK014	DRC056				CT008
YFM 350 FWT/FWU/FWW/FWA/FWE Big Bear	86-93	CK2290	CKF2290	CSK058	DRC033	DRCF033			CT090SP
YFM 350 FWF/FWG/FWH/FWJ	94-97	CK2290	CKF2290	CSK049	DRC082				CT090SP
YFM 350 XD/XE/XF/XG/XH/XJ/XK/XL/XM/XN/XP/XR/XS	92-04	CK2290	CKF2290	CSK058	DRC033	DRCF033			CT090SP
YFM 350 ERD/ERE/ERF	92-94	CK2290	CKF2290	CSK058	DRC033	DRCF033			CT090SP
YFM 350 ERG	95	CK2290	CKF2290	CSK049	DRC082				CT090SP
YFM 350 FX Wolverine All models	95-04	CK2240		CSK081	DRC228				CT008
YFM 350 UH/UJ	96-97	CK2290	CKF2290	CSK049	DRC082				CT090SP
YFM 350 S/T/V/R-WV/RW/RX/RV Raptor	04-09	CK2290	CKF2290	CSK058	DRC033	DRCF033			CT090SP
YFZ 350 T/U/W/A/B/D/E/F/G/H/J/K/L/M/N/P									
/R/S/T/V Banshee	87-09	CK2279	CKF2279	CSK002	DRC043	DRCF043			CT008
DT 400	75-76	CK2240		CSK002					CT008
DT 400 MX	77-79	CK2290	CKF2290	CSK002					CT008
FZ 400 N (IFK/33M/46X)	85	CK2255	CKF2255	CSK014					CT008
FZ 400 (4YR1)	96	CK2371		CSK035					CT010
FZR 400 RR (4DX)	92	CK2317		CSK185			SRC006	SRK006	CT010
FZR 400 Genesis (1WG)	86	CK2317		CSK185			SRC006	SRK006	CT010
FZR 400 RSP (2TK-EXUP)	87	CK2315		CSK185			SRC007	SRK007	CT010
FZR 400 (3EN1/3EN2)	88-89	CK2317		CSK185			SRC006	SRK006	CT010
FZR 400 RR (3TJ)		CK2317		CSK185			SRC006	SRK006	CT010
FZR 400 RRSP (3TJ2/6/7)		CK2315		CSK185			SRC007	SRK007	CT010
RD 400 C/D/E/F	76-79	CK2240		CSK002					CT008
SR 400 (3HT1)	88	CK2296		CSK014					CT008
SR 400 (2RD)	14-16	CK2296		CSK014					CT008
SRX 400 (1JL)		CK2297	CKF2297	CSK081					CT008
SRX 400 (3VN1/3VN2/3VN5)	90-96	CK2297	CKF2297	CSK081					CT008
XJR 400 (4HM1/4HM2/4HM4/4HM7)	93-96	CK2255	CKF2255	CSK081					CT008
XJR 400 (4HM3/4HM5/4HM6/4HM9/4HMA/4HMB)	95-99	CK2255	CKF2255	CSK081					CT008
XS 400	78-79	CK2279	CKF2279	CSK002					CT008
XS 400	82	CK2262		CSK002					CT017
XS 400 SE	80	CK2279	CKF2279	CSK002					CT008
XVS 400	96	CK2299		CSK091					CT020
YFM 400 FWE/FWF/FWG/FWH/FWJ/FWK Kodiak	93-00	CK2290	CKF2290	CSK049	DRC082				CT090SP
YFM 400 FPR/FPS Big Bear	03-04	CK2290	CKF2290	CSK049	DRC082				CT090SP
YZ 400 D/E/F (2T)	77-79	CK2279	CKF2279	CSK002					CT008
YZ 400 FK/FL (4T)	98-99	CK2310		CSK181	DRC265				CT008
WR 400 FK/FL/FM/FN (4T)	98-01	CK2310		CSK049	DRC099				CT008
IT 425 G	80	CK2279	CKF2279	CSK002					CT008
WR 426 FN/FP (4T)	01-02	CK2356	CKF2356	CSK062	DRC110				CT020
YZ 426 FM (4T)	00	CK2352	CKF2352	CSK181	DRC102				CT020
YZ 426 FN/FP (4T)	01-02	CK2356	CKF2356	CSK092	DRC116				CT020
WR 450 FR (4T)	03	CK2356	CKF2356	CSK062	DRC110				CT020
WR 450 FS (4T)	04	CK2352	CKF2352	CSK062	DRC263				CT020
WR 450 FT/FV/FW/FX/FY/FZ/FA/FB/FD/FE/FF (4T)	05-15	CK2274	CKF2274	CSK092	DRC194				CT020
WR 450 FG/FH (270mm F. Disc/4T)	16-21	CK2274	CKF2274	CSK037	DRC298	DRCF298			CT020
YZ 450 FR/FS (4T)	03-04	CK2352	CKF2352	CSK092	DRC121				CT020
YZ 450 FT/FV (4T)	05-06	CK2352	CKF2352	CSK058	DRC162				CT020
YZ 450 FW/FX/FY/FZ/FA/FB/FD (4T)	07-13	CK2274	CKF2274	CSK037	DRC195	DRCF195			CT020
YZ 450 FE/FF (4T)	14-21	CK2274	CKF2274	CSK213	DRC287	DRCF287			CT020
YZ 450 FG (270mm Disc)	16	CK2274	CKF2274	CSK213	DRC287	DRCF287			CT020
YZ 450 FG (60th Anniversary Edition/270mm Disc)	16	CK2274	CKF2274	CSK213	DRC287	DRCF287			CT020
YFZ 450 S/T/V Quad	04-06	CK2364	CKF2364	CSK187	DRC159	DRCF159			CT020
YFZ 450 W/X Quad	07-09	CK2364	CKF2364	CSK058	DRC201	DRCF201			CT020
YFZ 450 B/D	13-14	CK2364	CKF2364	CSK092					CT020
YFZ 450 RX/RV Quad	09-10	CK2364	CKF2364	CSK058	DRC201	DRCF201			CT020
YFZ 450 RSEA/RSEB/RSED/RSE	11-14	CK2274	CKF2274	CSK058					CT020
YFZ 450 R Quad	14-21	CK2389		TBC	DRC322				
IT 465 H/J	81-82	CK2279	CKF2279	CSK002					CT008
YZ 465 G/H	80-81	CK2279	CKF2279	CSK002					CT008
IT 490 L	84	CK2280		CSK002	DRC032				CT060
YZ 490 J/K/L/N/S/T/U	82-88	CK2280		CSK002	DRC032				CT060
RD 500 LC	84-86	CK2305		CSK014					CT017
RZV 500 R (51X)	85	CK2305		CSK014					CT017

CLUTCH APPLICATIONS

EBC CLUTCH KITS

Make & Model	Year	CK Series #	CKF Series #	Spring Kit #	DRC Series #	DRCF Series #	SRC Series #	SRK Series #	CT Tool #
YAMAHA Contd.									
SR 500	78-82	CK2296		CSK014					CT008
SR 500 S (3GWS)	98	CK2296		CSK014					CT008
SR 500 (3GW1/4/6/7)	96-98	CK2296		CSK014					CT008
WR 500 ZD	92-93	CK2280		CSK002					CT060
TT 500 G/H	80-81	CK2296		CSK014					CT008
XP 500 (T-Max Scooter - All models)	01-11	CK2378		CSK189			SRC099	SRK099	
XT 500 C	76	CK2334		CSK014					CT008
XT 500	77-81	CK2296		CSK014					CT008
XS 500 B	77	CK2255	CKF2255	CSK014					CT008
XS 500 C/D	78-79	CK2255	CKF2255	CSK014					CT008
T Max 530 ABS	12-21	CK2382		CSK267	DRC284				
T Max 530 DX ABS	17-21	CK2382		CSK267	DRC284				
T Max 530 SX ABS	17-21	CK2382		CSK267	DRC284				
T Max 530 Black Max ABS	13	CK2382		CSK267	DRC284				
T Max 530 Bronze Max ABS	14	CK2382		CSK267	DRC284				
T Max 530 Iron Max ABS	15	CK2382		CSK267	DRC284				
XV 535/535 S Virago	88-03	CK2299		CSK091					CT020
XJ 550	81	CK2306	CKF2306	CSK014					CT008SP
XJ 550 H/J/K Maxim	81-83	CK2306	CKF2306	CSK014					CT008SP
XJ 550 RH/RJ/RK Seca	81-83	CK2306	CKF2306	CSK014					CT008SP
XT 550	82	CK2310		CSK014					CT008
XT 550	83	CK2297	CKF2297	CSK014			SRC072	SRK072	CT008
XZ 550	82	CK2296		CSK014					CT008
FZ 600	87-88	CK2255	CKF2255	CSK014					CT008SP
FZR 600	89-93	CK2315		CSK185			SRC007	SRK007	CT010
FZR 600 R (4JH1/4)	94-95	CK2332	CKF2332	CSK081					CT054SP
FZ6 Naked - Non-ABS/2 Piston Caliper (1B3/1B3D)	04-07	CK2255	CKF2255	CSK017			SRC051	SRK051	CT008SP
FZ6 NS - Naked/Non-ABS/2 Piston Caliper (1B35/1B6)	05-06	CK2255	CKF2255	CSK017			SRC051	SRK051	CT008SP
FZ6 S2 - Naked/Non ABS/4 Piston Caliper (5S51/5S5)	07-09	CK2255	CKF2255	CSK017			SRC051	SRK051	CT008SP
FZ6 Fazer - Half Fairing/Non ABS/2 Piston Caliper (5VX/5VXL)	04-07	CK2255	CKF2255	CSK017			SRC051	SRK051	CT008SP
FZ6 Fazer - Half Fairing/ABS/2 Piston Caliper (4P5)	06-07	CK2255	CKF2255	CSK017			SRC051	SRK051	CT008SP
FZ6 Fazer S2 - Half Fairing/Non ABS/4 Piston Caliper (4S81/4S8)	07-09	CK2255	CKF2255	CSK017			SRC051	SRK051	CT008SP
FZ6 Fazer S2 - Half Fairing/ABS/4 Piston Caliper (5S2)	08	CK2255	CKF2255	CSK017			SRC051	SRK051	CT008SP
FZS 600 Fazer	98-99	CK2347		CSK002					CT054SP
FZS 600 Fazer/SP	00-03	CK2347		CSK081					CT054SP
SRX 600	86-87	CK2297	CKF2297	CSK014			SRC072	SRK072	CT008
SRX 600 (1JK/3SX)	85-91	CK2297	CKF2297	CSK014			SRC072	SRK072	CT008
TT 600 L (Kick Start Only)	84	CK2297	CKF2297	CSK002	DRC057				CT008
TT 600 N (59X) Frame # 59X 000101-7852 (Kick Start Only)	85-88	CK2297	CKF2297	CSK002	DRC057				CT008
TT 600 W (2JT/3SU1) Frame # 59X 7853									
Onwards (Kick Start Only)	89-92	CK2297	CKF2297	CSK002	DRC057				CT008
TT 600 R (5CH1) (Kick Start Only)	97	CK2297	CKF2297	CSK002	DRC057				CT008
TT 600 R (5CH2) (Kick Start Only)	98-99	CK2297	CKF2297	CSK002	DRC057				CT008
TT 600 R (5CH3/4) (Kick Start Only)	00-02	CK2297	CKF2297	CSK002	DRC057				CT008
TT 600 RE (5CH5) (Electric Start)	04	CK2297	CKF2297	CSK014	DRC088				CT008
TT 600 E (Electric Start)	94-01	CK2297	CKF2297	CSK014	DRC088				CT008
TT 600 K (Kick Start Only)	93-96	CK2297	CKF2297	CSK002	DRC057				CT008
XJ 600	84-92	CK2255	CKF2255	CSK014					CT008SP
XJ 600 S Diversion	92-03	CK2255	CKF2255	CSK014					CT008SP
XJ 600 N	95-03	CK2255	CKF2255	CSK014					CT008SP
XJ6-N 600 (Naked - Non ABS & ABS Model - 20S)	09-15	CK2306	CKF2306	CSK017			SRC127	SRK127	CT008SP
XJ6-F Diversion 600 (Full Fairing Diversion - Non ABS & ABS Models - 1CW)	10-15	CK2306	CKF2306	CSK017			SRC127	SRK127	CT008SP
XJ6-S Diversion 600 (Top Fairing Diversion - Non ABS & ABS Models - 36C)	09-15	CK2306	CKF2306	CSK017			SRC127	SRK127	CT008SP
XJ6-SP Diversion 600 (Non ABS & ABS Models)	13	CK2306	CKF2306	CSK017			SRC127	SRK127	CT008SP
XT 600 (Kick Start Model)	84-87	CK2297	CKF2297	CSK002	DRC057				CT008
XT 600 Z (Kick Start Model)	84-85	CK2297	CKF2297	CSK002	DRC057				CT008
XT 600 Z (Kick & Electric Start)	86-90	CK2297	CKF2297	CSK014	DRC088				CT008
XT 600 E (Electric Start Only)	90-03	CK2297	CKF2297	CSK014	DRC088	DRCF088			CT008
YX 600 S/SC/T/TC/UC/U/W/WC/A/AC Radian	86-90	CK2255	CKF2255	CSK014					
YZF 600 Thunder Cat	96-03	CK2332	CKF2332	CSK102			SRC033	SRK033	CT054SP
YZF 600 R R6 (8 plate)	99-02	CK2255	CKF2255	CSK017			SRC051	SRK051	CT008SP
YZF-R6 (8 plate)	03-05	CK2255	CKF2255	CSK092			SRC074	SRK074	CT008S
YZF R6 (9 plate)	06-17	CK2318	CKF2318	CSK126			SRC087	SRK087	CT008SP
YZF R6 (8 Plate)	18-21	CK2358		CSK126			SRC160	SRK160	CT008SP
XJ 650	80-84	CK2255	CKF2255	CSK081					CT008SP
XJ 650 Turbo	82	CK2255	CKF2255	CSK014					CT008SP
XJ 650 G/H/J/K Maxim	80-83	CK2255	CKF2255	CSK081					CT008SP
XJ 650 LH Midnight	81	CK2255	CKF2255	CSK081					CT008SP
XJ 650 RJ/LK Seca	82-83	CK2255	CKF2255	CSK014					CT008SP

EBC CLUTCH KITS

Make & Model	Year	CK Series #	CKF Series #	Spring Kit #	DRC Series #	DRCF Series #	SRC Series #	SRK Series #	CT Tool #
YAMAHA Contd.									
XS 650	75-76	CK2226		CSK014					CT074
XS 650	77-79	CK2226		CSK002					CT074
XS 650	80-81	CK2242		CSK014					CT074
XS 650 SE	79-81	CK2242		CSK014					CT074
XVS 650 Dragstar	97-04	CK2309		CSK091					CT020
XVS 650 A Dragstar Classic	98-07	CK2309		CSK091					CT020
MT-03 (660cc)	06-12	CK2368		CSK123					CT020
SZR 660	96-97	CK2297	CKF2297	CSK014	DRC088	DRCF088			CT008
XTZ 660 Tenere	91-97	CK2297	CKF2297	CSK014	DRC088	DRCF088			CT008
XT 660 X Supermoto (1D21/1D23/1D24/1D26/3S72/10S1/11B1)	04-09	CK2368		CSK123					CT020
XT 660 X Supermoto (10S7)	10-16	CK2368		CSK123					CT020
XT 660 R (Model Code 5VK1/3/4/6/8/3S62/3S63)	04-07	CK2368		CSK123					CT020
XT 660 R (Model Code 5VKA/5VKC)	08-09	CK2368		CSK123					CT020
XT 660 R (Model Code 5VKE)	10-16	CK2368		CSK123					CT020
XT 660 Z Tenere (Non ABS)	08-16	CK2368		CSK123					CT020
XT 660 ZA Tenere (ABS)	11-16	CK2368		CSK123					CT020
YFM 660 RV/RP/RR/RS/RT Raptor	01-05	CK2297	CKF2297	CSK014	DRC088	DRCF088			CT008
MT-07 Non ABS (689cc/2 Cyl)	14-21	CK2309		CSK037			SRC125	SRK125	CT020
MT-07A ABS (689cc/2 Cyl)	14-21	CK2309		CSK037			SRC125	SRK125	CT020
MT-07 Motocage ABS (689cc/2 Cyl)	15	CK2309		CSK037			SRC125	SRK125	CT020
FZX 700 S/SC/T/TC Fazer	86-87	CK2255	CKF2255	CSK017			SRC051	SRK051	CT008SP
YFM 700 RV/RW/RA/R/RD/RE	06-14	CK2364	CKF2364	CSK037	DRC128	DRCF128			CT020
YFM 700 RSE	13-14	CK2364	CKF2364	CSK037	DRC128	DRCF128			CT020
XSR 700 ABS (MTM 690-U)	16	CK2309		CSK037			SRC125	SRK125	CT020
FZ 750	85-86	CK2255	CKF2255	CSK017			SRC051	SRK051	CT008SP
FZ 750	87-92	CK2306	CKF2306	CSK017					CT008SP
FZX 750	87	CK2306	CKF2306	CSK017					CT008SP
FZR 750	87	CK2308		CSK017			SRC008	SRK008	CT008SP
FZR 750 R OW01	89-90	CK2318	CKF2318	CSK017			SRC009	SRK009	CT008SP
XJ 750	82-83	CK2255	CKF2255	CSK014					CT008SP
XJ 750 RF/RJ/RK Seca	81-83	CK2255	CKF2255	CSK014					CT008SP
XS 750	77-79	CK2279	CKF2279	CSK014					CT008SP
XS 750 SE	79-80	CK2279	CKF2279	CSK014					CT008SP
XTZ 750	89-95	CK2255	CKF2255	CSK187					CT008
XV 750 SE	81	CK2274	CKF2274	CSK081					CT020
XV 750 Virago	92-97	CK2274	CKF2274	CSK081					CT020
YZF 750 R/SP	93-97	CK2318	CKF2318	CSK017			SRC009	SRK009	CT008SP
YZF7R OW02	99-00	CK2353		N/A					CT020
FZ8 N-800cc (Naked/Single Headlight/Non ABS)	11-15	CK2364	CKF2364	CSK119			SRC126	SRK126	CT020
FZ8 NA-800cc (Naked/Single Headlight/ABS)	11-15	CK2364	CKF2364	CSK119			SRC126	SRK126	CT020
Fazer 8 S-800cc (Top Fairing/Twin Headlight/Non ABS)	11-15	CK2364	CKF2364	CSK119			SRC126	SRK126	CT020
Fazer 8 SA-800cc (Top Fairing/Twin Headlight/ABS)	11-15	CK2364	CKF2364	CSK119			SRC126	SRK126	CT020
TDM 850	91-95	CK2255	CKF2255	CSK017					CT008
TDM 850	96-98	CK2318	CKF2318	CSK017			SRC009	SRK009	CT008
TDM 850	99-01	CK2318	CKF2318	CSK092					CT008
TRX 850	96-98	CK2318	CKF2318	CSK017			SRC009	SRK009	CT008
XS 850	80	CK2273		CSK014					CT008SP
MT-09 (1RC/Non ABS/847cc/3 Cyl Engine)	14-21	CK2352	CKF2352	CSK119			SRC124	SRK124	CT020
MT-09 Tracer ABS (847cc/3 Cyl Engine)	14-21	CK2352	CKF2352	CSK119			SRC124	SRK124	CT020
MT-09A (2DR/ABS/847cc/3 Cyl Engine)	14-21	CK2352	CKF2352	CSK119			SRC124	SRK124	CT020
MT-09A Sport Tracker ABS (847cc/3 Cyl Engine)	14-21	CK2352	CKF2352	CSK119			SRC124	SRK124	CT020
MT-09A Street Rally ABS (847cc/3 Cyl Engine)	14-21	CK2352	CKF2352	CSK119			SRC124	SRK124	CT020
TDM 900 (5PS/Non ABS)	02-14	CK2318	CKF2318	CSK037					CT008
TDM 900 A (2B0/ABS)	05-13	CK2318	CKF2318	CSK037					CT008
XJ 900	83	CK2255	CKF2255	CSK049					CT008SP
XJ 900	90	CK2255	CKF2255	CSK049					CT008SP
XJ 900 F	85-92	CK2255	CKF2255	CSK017					CT008SP
XJ 900 S Diversion	95-03	CK2255	CKF2255	CSK187					CT008SP
XSR 900 ABS	18-21	CK2388		CSK268			SRC162	SRK162	
XV 950 Racer (Remote Reservoir Rear Shocks)	15-16	CK2379		CSK911					CT017
XVS 950 A Midnight Star	09-13	CK2379		CSK911					CT017
XV 950 - XVS 950 (Non ABS/Standard Rear Shocks)	14	CK2379		CSK911					CT017
XV 950 CU - XVS 950 (1XC1/ABS/Standard Rear Shocks)	14-16	CK2379		CSK911					CT017
XV 950 R - XVS 950 R (2DE/Remote Reservoir Rear Shocks)	14-16	CK2379		CSK911					CT017
FZ1 (Naked) (1000cc) (2D11)	06-09	CK2356	CKF2356	CSK119			SRC077	SRK077	CT020
FZ1-N/NA (Naked/Non ABS & ABS)	10-15	CK2356	CKF2356	CSK119			SRC077	SRK077	CT020
FZ1 Fazer (1000cc) (3C3/Half Fairing/Non ABS)	06-15	CK2356	CKF2356	CSK119			SRC077	SRK077	CT020
FZ1 Fazer (Half Fairing - ABS - 5D0)	08-15	CK2356	CKF2356	CSK119			SRC077	SRK077	CT020
FZR 1000 (2RG - Genesis Non EX-UP)	87-88	CK2308		CSK017			SRC008	SRK008	CT008SP
FZR 1000 (3GM1/3/5/7/8-3LG1/2/3/4-3LH1/2/3/4-3LE1/2/3/4 - EX-UP Models)	89-92	CK2321		CSK037			SRC031	SRK031	CT008SP
FZR 1000 (3GME/F-3LG5/6-3LH5/6-3LE/5-3LG6-3LJ6-4PM1 - EX-UP Models)	93-95	CK2327		CSK037			SRC029	SRK029	CT008SP

APPLICATIONS
CLUTCH

EBC CLUTCH KITS

Make & Model	Year	CK Series #	CKF Series #	Spring Kit #	DRC Series #	DRCF Series #	SRC Series #	SRK Series #	CT Tool #
YAMAHA Contd.									
FZS 1000 Fazer	01-05	CK2358		CSK037					CT008SP
GTS 1000	93-96	CK2327		CSK037			SRC029	SRK029	CT008SP
MT-10 (998cc)	16	CK4510	CKF4510	CSK218			SRC129	SRK129	CT079SP
XV 1000 TR1	81	CK2274	CKF2274	CSK014					CT020
XV 1000	86	CK2274	CKF2274	CSK014					CT020
YXR 1000 R EPS (Side X Side) YXZ10PXG	16	TBA		TBA					
YXR 1000 SE (Side X Side)	16	TBA		TBA					
YZF 1000 Thunder Ace	96-02	CK2327		CSK037			SRC029	SRK029	CT008SP
YZF R1 (4XV1/2)	98	CK2226		CSK903			SRC056	SRK056	CT017
YZF R1 (4XV7/8 5JJ1/8 5PW1/7)	99-03	CK2350		CSK903			SRC065	SRK065	CT017
YZF R1	04-06	CK2356	CKF2356	CSK119			SRC077	SRK077	CT020
YZF R1 SP (4B1)	06	CK2356	CKF2356	CSK211			SRC093	SRK093	CT020
YZF R1	07-08	CK2356	CKF2356	CSK211			SRC093	SRK093	CT020
YZF R1	09-14	CK2352	CKF2352	CSK211			SRC096	SRK096	CT020
YZF R1	15-21	CK4510	CKF4510	CSK218			SRC129	SRK129	CT079SP
YZF R1M	15-21	CK4510	CKF4510	CSK218			SRC129	SRK129	CT079SP
YZF R1 (60th Anniversary Edition)	16	CK4510	CKF4510	CSK218			SRC129	SRK129	CT079SP
BT 1100 Bulldog P/R/S/TV	02-06	CK2274	CKF2274	N/A					CT020
XS 1100/1100 S	78-81	CK2230		CSK014					CT077SP
XV 1100 Virago	89-00	CK2274	CKF2274	N/A					CT020
XVS 1100 A Dragstar Classic	00-07	CK2274	CKF2274	N/A					CT020
XVS 1100 Dragstar	99-04	CK2274	CKF2274	N/A					CT020
FJ 1100	84-85	CK2285		CSK903					CT017
FJ 1200/1200 A	86-95	CK2285		CSK903					CT017
XT 1200 Z Super Tenere (ABS/UBS Brake System)	10-16	CK2362		CSK903			SRC131	SRK131	CT017
XT 1200 ZE Super Tenere (ABS/UBS Brake System)	14-16	CK2362		CSK903			SRC131	SRK131	CT017
XVZ 12 TD	85	CK2300		CSK046					CT050SP
V-Max All models	91-03	CK2300		CSK906					CT050SP
XJR 1200	95-98	CK2285		CSK903					CT017
FJR 1300 N/P	01-02	CK2362		CSK903			SRC131	SRK131	CT017
FJR 1300 R/AR/S/AS/AT (ABS)	03-05	CK2362		CSK903			SRC131	SRK131	CT017
FJR 1300 A (1CY/Manual G/Shift)	06-15	CK2362		CSK903			SRC131	SRK131	CT017
FJR 1300 AE (Electronic Suspension Adjustment /USD Forks)	14-15	CK2362		CSK903			SRC131	SRK131	CT017
FJR 1300 AS (Electric G/Shift)	06-15	CK2362		N/A			N/A	N/A	CT017
XJR 1300 L 5EA2/5EA3/5EA4	99	CK2285		CSK903					CT017
XJR 1300 M 5EAA/5EAB/5EAC	00	CK2285		CSK903					CT017
XJR 1300 (5EA1/5EA7)	98-99	CK2285		CSK903					CT017
XJR 1300 (5EA9/5EAG)	00	CK2285		CSK903					CT017
XJR 1300 C/Racer	15-16	CK2285		CSK903					CT017
XJR 1300 N/P (5EAP/5EAS/5EAT/5EAW/5EAV/5EAY)	01-02	CK2285		CSK903					CT017
XJR 1300 R/S 5WM1/5WM3/5WM5/5WM6/5WM7									
/5WM9	03-04	CK2285		CSK903					CT017
XJR 1300 T/V/W/X/Y 5WMA/5WMC/5WMD/5WMF	05-14	CK2285		CSK903					CT017
XJR 1300 SP (L) (5EA5/5EA6/5EA8)	99	CK2285		CSK903					CT017
XJR 1300 SP (M) (5EAD/5EAE/5EAF)	00	CK2285		CSK903					CT017
XJR 1300 SP (N) (5EAL/5EAM/5EAN)	01	CK2285		CSK903					CT017
XVZ 13 Royal Star All models	96-01	CK2300		CSK906					CT050SP
XVS 1300 A Midnight Star	07-16	CK2362		CSK903			SRC131	SRK131	CT017
XVS 1300 CU Custom	14-16	CK2362		CSK903			SRC131	SRK131	CT017
XVS 1300 ACFD Midnight Star/Casual Full Dresser (With Handbar Fairing)	14-16	TBA		TBA					
XV 1600 A Wild Star	99-04	CK2351		CSK906					CT050SP
MT-01 (1670cc)	05-09	CK2366		CSK903					CT017
MT-01S (1670cc)	09	CK2366		CSK903					CT017
XV 1700 PCR Road Star Warrior	03-05	CK2363		CSK906					CT050SP
XV 1700 V-Max	09-16	CK2380		CSK903					CT017
XV 1900 A Midnight Star (Diaphragm Spring)	06-12	CK2367		CSK903					CT017
XV 1900 A Midnight Star (3 Spring Clutch)	13-16	TBA		TBA					
XV 1900 ACFD Midnight Star/Casual Full Dresser (Handlebar Fairing)	14-16	TBA		TBA					

CLUTCH APPLICATIONS

EBC CLUTCH KITS

Make & Model	Year	CK Series #	CKF Series #	Spring Kit #	DRC Series #	DRCF Series #	SRC Series #	SRK Series #	CT Tool #
AJP									
PR5 250 Trials	13-17	CK1318		CSK226	DRC300				CT091
PR5 250 Supermoto	13-17	CK1318		CSK226	DRC300				CT091
PR5 250 Enduro	13-17	CK1318		CSK226	DRC300				CT091
PR5 250 Extreme	13-17	CK1318		CSK226	DRC300				CT091
APRILIA									
AF1 Futura 50	90-92	CK2348		N/A					
Classic 50	92-01	CK2348		N/A					
Europa 50	90-92	CK2348		N/A					
MX 50	03-05	CK2348		N/A					
Pegaso 50	92-94	CK2348		N/A					
RS 50	93-05	CK2348		N/A					
RS 50	06-10	CK5604		CSK143					CT026
RX3-5 Marce	91-94	CK2348		N/A					
RX 50 All models	91-05	CK2348		N/A					
RX 50	06-09	CK5604		CSK143					CT026
SX 50	06-09	CK5604		CSK143					
Tuono 50	03-04	CK2348		N/A					
AF1 125	87-91	CK5598		CSK190	DRC247				CT034SP
Classic 125	95-01	CK5598		CSK190	DRC247				CT034SP
MX 125	04-06	CK5598		CSK190	DRC247				CT034SP
Pegaso 125	91-95	CK5598		CSK190	DRC247				CT034SP
Red Rose 125 (Cast Wheel)	87	CK5598		CSK190	DRC247				CT034SP
Red Rose 125 (Spoke Wheel)	88-94	CK5598		CSK190	DRC247				CT034SP
RS 125 (2T)	92-14	CK5598		CSK190	DRC247				CT034SP
RX 125	92-98	CK5598		CSK190	DRC247				CT034SP
Tuono 125	03-04	CK5598		CSK190	DRC247				CT034SP
RS 250	95-02	CK3333		CSK007					CT022
Pegaso Strada/Trial	05-06	CK2368		CSK123					CT020
ETV 1000 Caponord/Rally (PS00/PSB0)									
(Non ABS Models)	01-03	CK4434		CSK200			SRC117	SRK117	
ETV Caponord (PS004) (ABS Model)	04-08	CK4434		CSK200			SRC117	SRK117	
RST 1000 Futura	01-04			CSK200					
RSV 1000 Mille	01-02	CK6680		CSK200					
RSV 1000 R Mille	01-02	CK6680		CSK200					
RSV 1000 SP	99-00	CK6680		CSK200					
RSV 1000 Mille	00	CK6680		CSK200					
RSV 1000 Mille R	00	CK6680		CSK200					
RSV 1000 R Factory	04-08	CK6680		CSK200					
RSV 1000 R	04-08	CK6680		CSK200					
RSV 1000 R Tuono	02-06	CK6680		CSK200					
RSV-R 1000 Tuono Factory	06-09	CK6681		CSK184			SRC113	SRK113	
SL 1000 Falco	00-04	CK6680		CSK200					
RSV4 Factory SBK Racing	09-10	CK6681		CSK184			SRC113	SRK113	
RSV4 Factory APRC	11-13	CK6681		CSK184			SRC113		
RSV4R	10	CK6681		CSK184			SRC113	SRK113	
RSV4R APRC	11-13	CK6681		CSK184			SRC113		
ARCTIC CAT ATV 4 WHEELERS									
250 (2 x 4 / 4 x 4)	01-04	CK3390		CSK048	DRC089				CT011
250 (2 x 4 / 4 x 4)	05	CK3390		CSK048	DRC089				CT011
300 (2 x 4 / 4 x 4)	98-04	CK3356		CSK048	DRC103				CT011
300 (4 x 4)	05	CK3356		CSK048	DRC103				CT011
400 (2 x 4 / 4 x 4)	98-	CK4439	CKF4439	CSK088	DRC215				CT006
400 (2 x 4)	98	CK4439	CKF4439	CSK088	DRC214				CT006
400 (2 x 4 / 4 x 4)	00-02	CK4419		CSK088	DRC215				CT006
400 (2 x 4 / 4 x 4)	03-04	CK4439	CKF4439	CSK098	DRC120				CT006
400 (4 x 4 Manual)	05-08	CK4439	CKF4439	CSK098	DRC120				CT006
400 DVX	04-06	CK3433	CKF3433	CSK079	DRC105	DRCF105			CT006
400 DVX	07-08	CK3447	CKF3447	CSK079	DRC137	DRCF137			CT006
Bearcat 454 (4 x 4)	96-98	CK4439	CKF4439	CSK088	DRC216				CT006
Bearcat 454 (2 x 4)	97-98	CK4439	CKF4439	CSK088	DRC216				CT006
500 (4 x 4)	98-02	CK4439	CKF4439	CSK088	DRC214				CT006
500 (4 x 4 Manual)	03-04	CK3452		CSK007	DRC216				CT006
500 (Manual 4 x 4)	05-09	CK3452		CSK007	DRC216				CT006
BENELLI									
Leoncino 500	17-19	CK1230		CSK241			SRC141	SRK141	CT014SP
Leoncino Trail 500	18-19	CK1230		CSK241			SRC141	SRK141	CT014SP
TRK 502 ABS Euro 4	17-18	CK1230		CSK241			SRC141	SRK141	CT014SP
TRK 502 X	18-19	CK1230		CSK241			SRC141	SRK141	CT014SP
BN 600 GT	14-17	CK1230		CSK241			SRC141	SRK141	CT014SP
BN 600 i	14-17	CK1230		CSK241			SRC141	SRK141	CT014SP
BN 600 R	14-15	CK1230		CSK241			SRC141	SRK141	CT014SP

CLUTCH APPLICATIONS

EBC CLUTCH KITS

Make & Model	Year	CK Series #	CKF Series #	Spring Kit #	DRC Series #	DRCF Series #	SRC Series #	SRK Series #	CT Tool #
BENELLI Contd.									
BN 600 S	14-15	CK1230		CSK241			SRC141	SRK141	CT014SP
BETA									
Enduro RR 250 2T	18-20	CK5672							
Enduro RR 300 2T	18-20	CK5672							
Enduro RR 350 4T	18-20	CK5672							
Enduro RR 390 4T	18-20	CK5672							
Enduro RR 400 4T	10-15	CK2364			DRC333				
Enduro RR 430 4T	18-20	CK5672							
Enduro RR 450 4T	10-15	CK2364			DRC333				
Enduro RR 480 4T	18-20	CK5672							
BMW									
R45/R 45 N	81-	CK6601		N/A					
R65 All models	81-	CK6601		N/A					
R80 All models	80-	CK6601		N/A					
R100 All models	80-	CK6601		N/A					
R45/R 45 N	78-80	CK6602		N/A					
R65	78-80	CK6602		N/A					
R50/5	69-72	CK6603		N/A					
R60/5-7	69-80	CK6603		N/A					
R75 All models	69-	CK6603		N/A					
R80/7 N-S	77-80	CK6603		N/A					
R90/6, S	73-76	CK6603		N/A					
R100/7 T, S, RT, RS	76-80	CK6603		N/A					
K75 All models	85-	CK6604		N/A					
K100 All models	83-	CK6605		N/A					
K1	89-	CK6605		N/A					
R100 RS	86-92	CK6601		N/A					
R100 RT	87-95	CK6601		N/A					
R45	Sept 80-85	CK6601		N/A					
R45/N	Sept 80-85	CK6601		N/A					
R45 T	Sept 80-85	CK6601		N/A					
R45 T/N	Sept 80-85	CK6601		N/A					
R65	Sept 80-85	CK6601		N/A					
R65 LS	81-85	CK6601		N/A					
R65 T	80-85	CK6601		N/A					
R65 GS	87-92	CK6601		N/A					
R80 GS	80-87	CK6601		N/A					
R80 ST	82-84	CK6601		N/A					
R80	Sept 80-84	CK6601		N/A					
R80 RT	82-84	CK6601		N/A					
R80 TIC	Sept 80-85	CK6601		N/A					
R100/7 T	Sept 80-84	CK6601		N/A					
R100 CS	80-84	CK6601		N/A					
R100 RS	Sept 80-84	CK6601		N/A					
R100 RT	Sept 80-84	CK6601		N/A					
R100 TIC	80-84	CK6601		N/A					
R65/20	85-93	CK6601		N/A					
R65/35	85-88	CK6601		N/A					
R65 RT	85-88	CK6601		N/A					
R80	84-95	CK6601		N/A					
R80 RT	84-95	CK6601		N/A					
R100 GS	86-90	CK6601		N/A					
R100 PD	89-90	CK6601		N/A					
R80 GS	87-90	CK6601		N/A					
R80 PD/CH	90	CK6601		N/A					
R100 MYS	93-96	CK6601		N/A					
R100 R	91-95	CK6601		N/A					
R80 MYS	94-95	CK6601		N/A					
R80 R	91-94	CK6601		N/A					
R80 GS	96	CK6601		N/A					
R45	78-Sept 80	CK6602		N/A					
R45 N	78-Sept 80	CK6602		N/A					
R65	78-Sept 80	CK6602		N/A					
R50/5	69-73	CK6603		N/A					
R60/5	69-73	CK6603		N/A					
R60/6	73-76	CK6603		N/A					
R75/5	69-73	CK6603		N/A					
R75/6	73-76	CK6603		N/A					
R90/6	73-79	CK6603		N/A					
R90 S	73-76	CK6603		N/A					
R60/7	76-Sept 80	CK6603		N/A					
R60 TIC	78-Sept 80	CK6603		N/A					

CLUTCH APPLICATIONS

EBC CLUTCH KITS

Make & Model	Year	CK Series #	CKF Series #	Spring Kit #	DRC Series #	DRCF Series #	SRC Series #	SRK Series #	CT Tool #
BMW Contd.									
R75/7	76-79	CK6603		N/A					
R80	77-Sept 80	CK6603		N/A					
R80 TIC	78-Sept 80	CK6603		N/A					
R100	76-77	CK6603		N/A					
R100/7T	77-Sept 80	CK6603		N/A					
R100 RS	76-Sept 80	CK6603		N/A					
R100 RT	78-Sept 80	CK6603		N/A					
R100 S	76-80	CK6603		N/A					
K75	84-96	CK6604		N/A					
K75/2	84-96	CK6604		N/A					
K75 C	85-88	CK6604		N/A					
K75 RT	89-96	CK6604		N/A					
K75 S	85-95	CK6604		N/A					
K100	82-88	CK6605		N/A					
K100/2	87-90	CK6605		N/A					
K100 LT	86-91	CK6605		N/A					
K100 RT	83-89	CK6605		N/A					
K1	88-93	CK6605		N/A					
K100 RS	89-92	CK6605		N/A					
K1100 LT	89-99	CK6605		N/A					
K1100 RS	92-96	CK6605		N/A					
F650 (E169/0161/Standard)	Sept 93-96	CK5605		CSK104					
F650 (E169/0162/ Funduro/High Screen /19 Inch Front Wheel)	97-00	CK5605		CSK104					
F650 CS/Scarver K14/0174/0184/Belt drive /17 Inch Cast Wheels	00-03	CK5636		CSK104					
F650 CS/Scarver K14/0177/0187/Belt drive /17 Inch Cast Wheels	04-07	CK5635		CSK104					
F650 GS (R13/0172/0182/Single Cylinder /19 Inch Front Wheel)	99-03	CK5636		CSK104					
F650 GS (R13/0175/0185/Single Cylinder /19 Inch Front Wheel)	04-07	CK5635		CSK104					
F650 GS (Late type plates 2 x 13mm/7 x 14mm ears)	07-17	CK5660		CSK240			SRC130	SRK130	CT085
F650 GS Dakar (R13/0173/0183/Single Cylinder /21 Inch front wheel)	99-03	CK5636		CSK104					
F650 GS Dakar (R13/0176/0186/Single Cylinder /21 Inch front wheel)	04-07	CK5635		CSK104					
F650 ST (E169/0163/0168/Strada/Low Screen /18 Inch Front Wheel)	97-00	CK5605		CSK104					
F700 GS (Late type plates 2 x 13mm/7 x 14mm ears)	11-17	CK5660		CSK240			SRC130	SRK130	CT085
F750 GS (OB08, OB018, OB28 & OB38)	16-22	CK5685		CSK271			SRC170	SRK170	TBC
F800 GS (Early type plates 14mm ears)	08-11	CK5667		CSK240			SRC144	SRK144	CT085
F800 GS (Late type plates 2 x 13mm/7 x 14mm ears)	12-19	CK5660		CSK240			SRC130	SRK130	CT085
F800 GS Adventure (Late type plates 2 x 13mm /7 x 14mm ears)	12-19	CK5660		CSK240			SRC130	SRK130	CT085
F800 GT (Early type plates 14mm ears)	04-06	CK5667		CSK240			SRC144	SRK144	CT085
F800 GT (Late type plates 2 x 13mm/7 x 14mm ears)	07-19	CK5660		CSK240			SRC130	SRK130	CT085
F800 S (Early type plates 14mm ears)	04-06	CK5667		CSK240			SRC144	SRK144	CT085
F800 S (Late type plates 2 x 13mm/7 x 14mm ears)	07-19	CK5660		CSK240			SRC130	SRK130	CT085
F800 ST (Early type plates 14mm ears)	04-06	CK5667		CSK240			SRC144	SRK144	CT085
F800 ST (Late type plates 2 x 13mm/7 x 14mm ears)	07-19	CK5660		CSK240			SRC130	SRK130	CT085
F800 R (Late type plates 2 x 13mm/7 x 14mm ears)	05-19	CK5660		CSK240			SRC130	SRK130	CT085
F850 GS (OB09, OB19, OB29 & OB39 Inc Adventure models)	16-22	CK5685		CSK271			SRC170	SRK170	TBC
G 310 R	17-21	CK1253		CSK249			SRC151	SRK151	CT013
G 310 GS	17-21	CK1253		CSK249			SRC151	SRK151	CT013
G 650 GS (R13)	08-16	CK5635		CSK133			SRC145	SRK145	CT083
G 650 GS Sertao (R13)	10-14	CK5635		CSK133			SRC145	SRK145	CT083
G 650 Xcountry (K15)	08-10	CK5635		CSK133			SRC145	SRK145	CT083
R 1200 GS	13-18	CK5676		CSK264			SRC165	SRK165	
R 1200 GS Adventure	13-18	CK5676		CSK264			SRC165	SRK165	
R 1200 R	13-18	CK5676		CSK264			SRC165	SRK165	
R 1200 RS	14-18	CK5676		CSK264			SRC165	SRK165	
R 1250 GS	19-21	CK5676		CSK264			SRC165	SRK165	
R 1250 GS TE	19-21	CK5676		CSK264			SRC165	SRK165	
R 1250 GS Rallye	19-21	CK5676		CSK264			SRC165	SRK165	
R 1250 GS Rallye TE	19-21	CK5676		CSK264			SRC165	SRK165	
R 1250 GS Adventure	19-21	CK5676		CSK264			SRC165	SRK165	
R 1250 GS Adventure TE	19-21	CK5676		CSK264			SRC165	SRK165	
R 1250 GS Adventure Rallye	19-21	CK5676		CSK264			SRC165	SRK165	
R 1250 GS Adventure Rallye TE	19-21	CK5676		CSK264			SRC165	SRK165	
K 1300 GT	08-11	CK5682							
K 1300 R	08-12	CK5682							
K 1300 S	08-16	CK5682							

CLUTCH APPLICATIONS

EBC CLUTCH KITS

Make & Model	Year	CK Series #	CKF Series #	Spring Kit #	DRC Series #	DRCF Series #	SRC Series #	SRK Series #	CT Tool #
CCM									
R30 (644 Suzuki Engine)	02-04	CK3386		CSK004	DRC087				CT024
R35/R35S	06-07	CK3433	CKF3433	CSK079	DRC105	DRCF105			CT006
404E/DS/Supermoto	03-04	CK3433	CKF3433	CSK079	DRC105	DRCF105			CT006
604 Trial/SM/RS/R30 (Rotax Engine)	98-03	CK5628		CSK127	DRC165				CT040SP
644 DS/Supermoto	04	CK3386		CSK004	DRC087				CT024
CR40 S Cafe Racer	07	CK3433	CKF3433	CSK079	DRC105	DRCF105			CT006
CR40 Street	07	CK3433	CKF3433	CSK079	DRC105	DRCF105			CT006
SR40 Street Scrambler	07	CK3433	CKF3433	CSK079	DRC105	DRCF105			CT006
DERBI									
GPR 50 Nude	04-05	CK5604		CSK143					CT026
GPR 50 R	97-00	CK5604		CSK143					CT026
GPR 50 Racing	04-05	CK5604		CSK143					CT026
GPR 50 Replica	99-05	CK5604		CSK143					CT026
DERBI Contd.									
Senda 50 (4 Plate Clutch)	99-05	CK5604		CSK143					CT026
Mulhacen 659	06-07	CK2297	CKF2297	CSK014					CT008
DUCATI									
Monster 620 ie	01-06	CK5675							
899 Panigale	13-15	CK5661							
959 Panigale	17-20	CK5670							
ELSTARS (Pit Bikes)									
Various models (Check parts before fitting)		CK1308		N/A			SRC091		
GAS-GAS									
EC 125 (2T)	00-08	CK1293	CKF1293	CSK024	DRC206				CT001
SM 125 (2T) Supermotard	03-06	CK1293	CKF1293	CSK024	DRC206				CT001
EC200/250/300 (2T)	00-08	CK5643		CSK141	DRC207				CT009
EC 450 FSR/FSE (4T) Enduro	05-08	CK5643		CSK141	DRC207				CT009
SM 450 FSR (4T) Supermotard	07-08	CK5643		CSK141	DRC207				CT009
Wild HP 450 Quad	04-08	CK5643		CSK141	DRC207				CT009
EC 515 FSR/FSE (4T) Enduro	05-08	CK5643		CSK141	DRC207				CT009
SM 515 FSR (4T) Supermotard	07-08	CK5643		CSK141	DRC207				CT009
HUSQVARNA									
TC 50	17-19	CK5674							
TC 65	17-21	CK5594	CKF5594	CSK021	DRC241	DRCF241			CT057SP
TC 85 (F 17"/R 14")	14-17	CK5610		CSK042	DRC139				CT028
TC 85 (F19"/R 16")	14-17	CK5610		CSK042	DRC139				CT028
TC 85 (F 17"/R 14")	18-21	CK5668	CKF5668	CSK908	DRC304	DRCF304			CT087SP
TC 85 (F19"/R 16")	18-21	CK5668	CKF5668	CSK908	DRC304	DRCF304			CT087SP
CR 125	00-11	CK1222		CSK182	DRC264				CT001
TC 125	19-21	CK5611	CKF5611	CSK210	DRC303	DRCF303			CT001
TE 125	14-16	CK5611	CKF5611	CSK210	DRC303	DRCF303			CT001
TX 125	17-18	CK5611	CKF5611	CSK210	DRC303	DRCF303			CT001
WR 125	00-11	CK1222		CSK182	DRC264				CT001
WRE 125	00-11	CK1222		CSK182	DRC264				CT001
SMS 125	00-11	CK1222		CSK182	DRC264				CT001
TE 150	17-18	CK5611	CKF5611	CSK210	DRC303	DRCF303			CT001
TE 150i	19-21	TBC	TBC	TBC	TBC				CT001
FC 250	14-17	CK5651	CKF5651	CSK221	DRC293				CT023
FC 250	18-21	TBC	TBC	TBC	TBC				CT023
TC 250	03-08	CK5657							
TC 250	14-21	CK5651	CKF5651	CSK910	TBA				CT023
TE 250 2T	03-09	CK5657							
TE 250 2T	14-21	CK5651	CKF5651	CSK910	TBA				CT023
TE 250i 2T	18-21	CK5651	CKF5651	CSK910	TBC				CT023
TE 300 2T	14-21	CK5651	CKF5651	CSK910	TBA				CT023
TE 300i 2T	18-21	CK5651	CKF5651	CSK910	TBC				CT023
TX 300i	18-21	CK5651	CKF5651	CSK910	TBA				CT023
TE 310	08-10	CK5657							
FC 350	14-17	CK5651	CKF5651	CSK221	DRC293				CT023
FC 350	18-21	TBC	TBC	TBC	TBC				CT023
FE 350	14-17	CK5651	CKF5651	CSK910	DRC273				CT023
FE 350	18-21	TBC	TBC	TBC	TBC				CT023
FX 350	17-18	CK5651	CKF5651	CSK221	DRC293				CT023
FX 350	18-21	TBC	TBC	TBC	TBC				CT023
FC 450	18-19	CK5651	CKF5651	CSK910	DRC275				CT023
FC 450 inc Rockstar Edition	18-21	TBC	TBC	TBC	TBC				CT023
FE 450	14-17	CK5651	CKF5651	CSK910	DRC275				CT023
FE 450	18-21	TBC	TBC	TBC	TBC				CT023

EBC CLUTCH KITS

Make & Model	Year	CK Series #	CKF Series #	Spring Kit #	DRC Series #	DRCF Series #	SRC Series #	SRK Series #	CT Tool #
HUSQVARNA Contd.									
FR 450 Rally	17-21	TBC	TBC	TBC	TBC				CT023
FS 450	15-21	CK5651	CKF5651	CSK909	DRC281				CT023
FX 450	2017	CK5651	CKF5651	CSK909	DRC281				CT023
FX 450	2018-2021	TBC	TBC	TBC	TBC				CT023
TC 450	02-07	CK5656							
TE 450	02-07	CK5656							
FE 501	2014-2016	CK5651	CKF5651	CSK910	DRC275				CT023
FE 501	2017-2021	CK5651	CKF5651	CSK909	DRC281				CT023
FE 501S	16	CK5651	CKF5651	CSK910	DRC275				CT023
SMR 570	03-04	CK5656							
TC 570	03-04	CK5656							
TE 570	03-04	CK5656							
TE 610	05-12	CK5656							
701 Enduro R	2016-2021	CK5642		CSK131	DRC205				CT069
701 Supermoto	2016-2021	CK5642		CSK131	DRC205				CT069
Svartpilen 401	2018-2021	CK5642		CSK131	DRC205				CT069
Svartpilen 701	2018-2021	CK5642		CSK131	DRC205				CT069
Vitpilen 401	2018-2021	CK5642		CSK131	DRC205				CT069
Vitpilen 701	2018-2021	CK5642		CSK131	DRC205				CT069
HARLEY-DAVIDSON® VRSC									
VRSCA V-Rod	02-06	CK7006		CSK232			SRC7007	SRK7007	CT707SP
VRSCSE CVO V-Rod	05-06	CK7006		CSK232			SRC7007	SRK7007	CT707SP
VRXSE CVO VR Destroyer	06	CK7006		CSK232			SRC7007	SRK7007	CT707SP
VRSCR Street Rod	06-07	CK7006		CSK232			SRC7007	SRK7007	CT707SP
VRSCAW V-Rod Wide Tire	07	CK7006		CSK232			SRC7007	SRK7007	CT707SP
VRSCX Screamin' Eagle V-Rod	07	CK7006		CSK232			SRC7007	SRK7007	CT707SP
VRSCAW V-Rod	09-10	CK7005		CSK233			SRC7006	SRK7006	CT706SP
VRSCAW V-Rod Wide Tire	08	CK7005		CSK233			SRC7006	SRK7006	CT706SP
VRSCAWA V-Rod Wide Tire W/ABS	08	CK7005		CSK233			SRC7006	SRK7006	CT706SP
VRSCD Night Rod	08	CK7005		CSK233			SRC7006	SRK7006	CT706SP
VRSCDA Night Rod W/ABS	08	CK7005		CSK233			SRC7006	SRK7006	CT706SP
VRSCDX ANV Night Rod Special Anv	12	CK7005		CSK233			SRC7006	SRK7006	CT706SP
VRSCDX Night Rod Special	08-17	CK7005		CSK233			SRC7006	SRK7006	CT706SP
VRSCDXA Night Rod Special W/ABS	08	CK7005		CSK233			SRC7006	SRK7006	CT706SP
VRSCF V-Rod Muscle	09-17	CK7005		CSK233			SRC7006	SRK7006	CT706S
HARLEY-DAVIDSON® TRIKE									
FLD 103 Dyna Switchback	12-16	CK7008		CSK916			SRC7012	SRK7012	CT703SP
FLD Dyna Switchback	12-16	CK7008		CSK916			SRC7013	SRK7013	CT703SP
FLHP Road King Police	11-16	CK7008		CSK914			SRC7009	SRK7009	CT703SP
FLHR Road King	17	CK7002		CSK236			SRC7010	SRK7010	CT702SP
FLHRC Road King Classic	17	CK7002		CSK236			SRC7010	SRK7010	CT702SP
FLFBS Fat Boy 114	18	CK7007		CSK236			SRC7008	SRK7008	CT708SP
FLFBS Fat Boy 114 Anniversary	18	CK7007		CSK236			SRC7008	SRK7008	CT708SP
HARLEY-DAVIDSON® TOURING									
FLH Electra Glide	81-83	CK7012		CSK255			SRC7018	SRK7018	CT704SP
FLH Electra Glide Shrine Shovelhead	83	CK7012		CSK255			SRC7018	SRK7018	CT704SP
FLHC Electra Glide Classic	81-82	CK7012		CSK255			SRC7018	SRK7018	CT704SP
FLHS Electra Glide Heritage	81	CK7012		CSK255			SRC7018	SRK7018	CT704SP
FLHS Electra Glide Sport	81-83	CK7012		CSK255			SRC7018	SRK7018	CT704SP
FLHT Electra Glide Classic	83	CK7012		CSK255			SRC7018	SRK7018	CT704SP
FLHT Electra Glide Standard	83	CK7012		CSK255			SRC7018	SRK7018	CT704SP
FLHT Electra Glide	83	CK7012		CSK255			SRC7018	SRK7018	CT704SP
FLHTC Electra Glide Classic	83-84	CK7012		CSK255			SRC7018	SRK7018	CT704SP
FLT Tour Glide	81-83	CK7012		CSK255			SRC7018	SRK7018	CT704SP
FLTC Tour Glide Classic	80-84	CK7012		CSK255			SRC7018	SRK7018	CT704SP
FLH Electra Glide	EARLY 84	CK7011		CSK255			SRC7017	SRK7017	CT704SP
FLH Electra Glide Shrine Shovelhead	EARLY 84	CK7011		CSK255			SRC7017	SRK7017	CT704SP
FLHS Electra Glide Sport	EARLY 84	CK7011		CSK255			SRC7017	SRK7017	CT704SP
FLHT Electra Glide	EARLY 84	CK7011		CSK255			SRC7017	SRK7017	CT704SP
FLHT Electra Glide Classic	EARLY 84	CK7011		CSK255			SRC7017	SRK7017	CT704SP
FLT Classic Tour Glide Classic	EARLY 84	CK7011		CSK255			SRC7017	SRK7017	CT704SP
FLT Tour Glide	EARLY 84	CK7011		CSK255			SRC7017	SRK7017	CT704SP
FLHS Electra Glide Sport	84-89	CK7010		TBA			SRC7016	SRK7016	CT705SP
FLHT Electra Glide	LATER 84	CK7010		TBA			SRC7016	SRK7016	CT705SP
FLHT Electra Glide Classic	LATER 84	CK7010		TBA			SRC7016	SRK7016	CT705SP
FLHT Electra Glide Shrine Shovelhead	LATER 84	CK7010		TBA			SRC7016	SRK7016	CT705SP
FLHT Electra Glide Standard	88	CK7010		TBA			SRC7016	SRK7016	CT705SP
FLHTC Electra Glide Classic	84-89	CK7010		TBA			SRC7016	SRK7016	CT705SP
FLHTCU Electra Glide Classic Ultra	89	CK7010		TBA			SRC7016	SRK7016	CT705SP
FLST Softail Heritage	86-89	CK7010		TBA			SRC7016	SRK7016	CT705SP
FLSTC Softail Heritage Classic	87-89	CK7010		TBA			SRC7016	SRK7016	CT705SP

CLUTCH APPLICATIONS

EBC CLUTCH KITS

Make & Model	Year	CK Series #	CKF Series #	Spring Kit #	DRC Series #	DRCF Series #	SRC Series #	SRK Series #	CT Tool #
HARLEY-DAVIDSON® TOURING Contd.									
FLT Tour Glide	LATER 84	CK7010		TBA			SRC7016	SRK7016	CT705SP
FLTC Tour Glide Classic	84-89	CK7010		TBA			SRC7016	SRK7016	CT705SP
FLHR Road King	93-97	CK7009		TBA			SRC7014	SRK7014	CT701SP
FLHS Electra Glide Sport	91-94	CK7009		TBA			SRC7014	SRK7014	CT701SP
FLHS Touring Electra Glide Sport	90	CK7009		TBA			SRC7015	SRK7015	CT701SP
FLHT Electra Glide Standard	94-97	CK7009		TBA			SRC7014	SRK7014	CT701SP
FLHTC Electra Glide Classic	91-97	CK7009		TBA			SRC7014	SRK7014	CT701SP
FLHTC Touring Electra Glide Classic	90	CK7009		TBA			SRC7015	SRK7015	CT701SP
FLHTCI Electra Glide Classic	96-97	CK7009		TBA			SRC7014	SRK7014	CT701SP
FLHTCU Touring Electra Glide Classic Ultra	90	CK7009		TBA			SRC7015	SRK7015	CT701SP
FLHTCU Ultra Classic	91-97	CK7009		TBA			SRC7014	SRK7014	CT701SP
FLST Softail Heritage	90	CK7009		TBA			SRC7019	SRK7019	CT701SP
FLSTC Softail Heritage Classic	90-97	CK7009		TBA			SRC7019	SRK7019	CT701SP
FLSTF Fat Boy	91-97	CK7009		TBA			SRC7019	SRK7019	CT701SP
FLSTF Softail Fat Boy	90	CK7009		TBA			SRC7019	SRK7019	CT701SP
FLHPE Road King Police	11	CK7008		CSK914			SRC7009	SRK7009	CT703SP
FLHR 103 Road King	11	CK7008		CSK916			SRC7012	SRK7012	CT703SP
FLHR Road King	06-11	CK7008		CSK915			SRC7013	SRK7013	CT703SP
FLHR Road King	12-13	CK7008		CSK916			SRC7012	SRK7012	CT703SP
FLHR Road King	15-16	CK7008		CSK917			SRC7011	SRK7011	CT703SP
FLHR Road King	98-03	CK7008		CSK917			SRC7011	SRK7011	CT703SP
FLHR Road King	04-05	CK7008		CSK916			SRC7012	SRK7012	CT703SP
FLHR 96 Road King	11	CK7008		CSK915			SRC7013	SRK7013	CT703SP
FLHRANV Road King Anniversary	13	CK7008		CSK916			SRC7012	SRK7012	CT703SP
FLHRC 103 Road King Classic	11	CK7008		CSK916			SRC7012	SRK7012	CT703SP
FLHRC Road King Classic	07-11	CK7008		CSK915			SRC7013	SRK7013	CT703SP
FLHRC Road King Classic	12-13	CK7008		CSK916			SRC7012	SRK7012	CT703SP
FLHRC Road King Classic	14-16	CK7008		CSK917			SRC7011	SRK7011	CT703SP
FLHRCI Road King Classic	04	CK7008		CSK916			SRC7012	SRK7012	CT703SP
FLHRCI Road King Classic	98-03	CK7008		CSK917			SRC7011	SRK7011	CT703SP
FLHRCI Road King Classic	05	CK7008		CSK916			SRC7012	SRK7012	CT703SP
FLHRCI Road King Classic	06	CK7008		CSK915			SRC7013	SRK7013	CT703SP
FLHRI Road King	00-03	CK7008		CSK917			SRC7011	SRK7011	CT703SP
FLHRI Road King	04-05	CK7008		CSK916			SRC7012	SRK7012	CT703SP
FLHRI Road King	06	CK7008		CSK915			SRC7013	SRK7013	CT703SP
FLHRS Road King Custom	04-05	CK7008		CSK916			SRC7012	SRK7012	CT703SP
FLHRS Road King Custom	06-07	CK7008		CSK915			SRC7013	SRK7013	CT703SP
FLHRSI 1FYW Road King Custom	04-05	CK7008		CSK916			SRC7012	SRK7012	CT703SP
FLHRSI 1FYW Road King Custom	06	CK7008		CSK915			SRC7013	SRK7013	CT703SP
FLHT Electra Glide Standard	98-03	CK7008		CSK917			SRC7011	SRK7011	CT703SP
FLHT Electra Glide Standard	04-05	CK7008		CSK916			SRC7012	SRK7012	CT703SP
FLHT Electra Glide Standard	06-10	CK7008		CSK915			SRC7013	SRK7013	CT703SP
FLHTC 103 Electra Glide Classic	11	CK7008		CSK916			SRC7012	SRK7012	CT703SP
CT703SPFLHTC Electra Glide Classic	98-03	CK7008		CSK917			SRC7011	SRK7011	CT703SP
FLHTC Electra Glide Classic	04-05	CK7008		CSK916			SRC7012	SRK7012	CT703SP
FLHTC Electra Glide Classic	07-11	CK7008		CSK915			SRC7013	SRK7013	CT703SP
FLHTC Electra Glide Classic	12-13	CK7008		CSK916			SRC7012	SRK7012	CT703SP
FLHTCI Ultra Classic	05	CK7008		CSK916			SRC7012	SRK7012	CT703SP
FLHTCI Electra Glide Classic	98-03	CK7008		CSK917			SRC7011	SRK7011	CT703SP
FLHTCI Electra Glide Classic	04-05	CK7008		CSK916			SRC7012	SRK7012	CT703SP
FLHTCI Electra Glide Classic	06	CK7008		CSK915			SRC7013	SRK7013	CT703SP
FLHTCU 103 Ultra Classic	11	CK7008		CSK916			SRC7012	SRK7012	CT703SP
FLHTCU Ultra Classic	07-11	CK7008		CSK915			SRC7013	SRK7013	CT703SP
FLHTCU Ultra Classic	12-13	CK7008		CSK916			SRC7012	SRK7012	CT703SP
FLHTCU Ultra Classic	14-16	CK7008		CSK917			SRC7011	SRK7011	CT703SP
FLHTCU TC Ultra Classic Twin-Cooled	14-16	CK7008		CSK917			SRC7011	SRK7011	CT703SP
FLHTCUI Ultra Classic	04	CK7008		CSK916			SRC7012	SRK7012	CT703SP
FLHTCUI Ultra Classic	98-03	CK7008		CSK917			SRC7011	SRK7011	CT703SP
FLHTCUI Ultra Classic	06	CK7008		CSK915			SRC7013	SRK7013	CT703SP
FLHTCUTG Tri Glide Ultra Classic	09-13	CK7008		CSK914			SRC7009	SRK7009	CT703SP
FLHTCUTGANV Tri Glide Ultra Classic Anniversary	13	CK7008		CSK914			SRC7009	SRK7009	CT703SP
FLHTI Electra Glide Standard	03	CK7008		CSK917			SRC7011	SRK7011	CT703SP
FLHTI Electra Glide Standard	04-05	CK7008		CSK916			SRC7012	SRK7012	CT703SP
FLHTI Electra Glide Standard	06	CK7008		CSK915			SRC7013	SRK7013	CT703SP
FLHTK Ultra Limited	14-16	CK7008		CSK917			SRC7011	SRK7011	CT703SP
FLHTK Electra Glide Ultra Limited	10-13	CK7008		CSK916			SRC7012	SRK7012	CT703SP
FLHTKANV Electra Glide Ultra Limited Anniversary	13	CK7008		CSK916			SRC7012	SRK7012	CT703SP
FLHTP Electra Glide Standard Police	11-16	CK7008		CSK914			SRC7009	SRK7009	CT703SP
FLHX 103 Street Glide	11	CK7008		CSK916			SRC7012	SRK7012	CT703SP
FLHX Street Glide	06-11	CK7008		CSK915			SRC7013	SRK7013	CT703SP
FLHX Street Glide	12-13	CK7008		CSK916			SRC7012	SRK7012	CT703SP
FLHX Street Glide	14-16	CK7008		CSK917			SRC7011	SRK7011	CT703SP
FLHXS Street Glide Special	14-16	CK7008		CSK917			SRC7011	SRK7011	CT703SP
FLHXXX Street Glide Trike	10-11	CK7008		CSK914			SRC7009	SRK7009	CT703SP

CLUTCH APPLICATIONS

EBC CLUTCH KITS

Make & Model	Year	CK Series #	CKF Series #	Spring Kit #	DRC Series #	DRCF Series #	SRC Series #	SRK Series #	CT Tool #
HARLEY-DAVIDSON® TOURING Contd.									
FLS 103 Softail Slim	13-15	CK7008		CSK916			SRC7012	SRK7012	CT703SP
FLS 103 Softail Slim	12	CK7008		CSK916			SRC7012	SRK7012	CT703SP
FLHRXS Road King Special	18	CK7002		CSK236			SRC7010	SRK7010	CT702SP
FLS Softail Slim	12-15	CK7008		CSK915			SRC7013	SRK7013	CT703SP
FLS Softail Slim	16-17	CK7008		CSK916			SRC7012	SRK7012	CT703SP
FLST Heritage Softail	08-09	CK7008		CSK915			SRC7013	SRK7013	CT703SP
FLST Heritage Softail	06	CK7008		CSK915			SRC7013	SRK7013	CT703SP
FLSTC 103 Heritage Softail Classic	12-15	CK7008		CSK916			SRC7012	SRK7012	CT703SP
FLSTC103ANV Heritage Softail Classic Anniversary	13	CK7008		CSK916			SRC7012	SRK7012	CT703SP
FLHTCU Electra Glide Ultra Classic	17-18	CK7002		CSK236			SRC7010	SRK7010	CT702SP
FLHTCUL TC Ultra Classic Low Twin-Cooled	15-16	CK7002		CSK235			SRC7003	SRK7003	CT702SP
FLHTCUL Ultra Classic Low	15-16	CK7002		CSK235			SRC7003	SRK7003	CT702SP
FLSTC Heritage Softail Classic	98-03	CK7008		CSK917			SRC7011	SRK7011	CT703SP
FLSTC Heritage Softail Classic	04-05	CK7008		CSK916			SRC7012	SRK7012	CT703SP
FLHCS Heritage Classic 114	18	CK7007		CSK236			SRC7008	SRK7008	CT708SP
FLHTCUTG Tri Glide Ultra Classic	14-16	CK7002		CSK235			SRC7003	SRK7003	CT702SP
FLHTK 103 CVO Limited	14	CK7002		CSK235			SRC7003	SRK7003	CT702SP
FLHCS Heritage Classic 114 Anniversary	18	CK7007		CSK236			SRC7008	SRK7008	CT708SP
FLHTK Ultra Limited	17-18	CK7002		CSK236			SRC7010	SRK7010	CT702SP
FLHTK Ultra Limited Anniversary	18	CK7002		CSK236			SRC7010	SRK7010	CT702SP
FLHTK Ultra Limited Shrine Edition	18	CK7002		CSK236			SRC7010	SRK7010	CT702SP
FLHTKL Ultra Limited Low	15-18	CK7002		CSK235			SRC7003	SRK7003	CT702SP
FLHX Street Glide	17-18	CK7002		CSK236			SRC7010	SRK7010	CT702SP
FLHX Street Glide Anniversary	18	CK7002		CSK236			SRC7010	SRK7010	CT702SP
FLHXS Street Glide Special	17-18	CK7002		CSK236			SRC7010	SRK7010	CT702SP
FLHP Road King Police	17	CK7007		CSK236			SRC7008	SRK7008	CT708SP
FLHTCUTG Tri Glide Ultra	17-18	CK7007		CSK236			SRC7008	SRK7008	CT708SP
FLHC 1YAJ Heritage Classic	18	TBA		CSK236			TBA	TBA	
FLHTCUTG Tri Glide Ultra Anniversary	18	CK7007		CSK236			SRC7008	SRK7008	CT708SP
FLHTP Electra Glide Standard Police	17	CK7007		CSK236			SRC7008	SRK7008	CT708SP
FLHXS Street Glide Special Anniversary	18	CK7002		CSK236			SRC7010	SRK7010	CT702SP
FLRT Freewheeler	15-16	CK7002		CSK235			SRC7003	SRK7003	CT702SP
FLSS Softail Slim S	16-17	CK7002		CSK235			SRC7003	SRK7003	CT702SP
FLSTFBS Fat Boy S	16-17	CK7002		CSK235			SRC7003	SRK7003	CT702SP
HARLEY-DAVIDSON® DYNA									
FXB Super Glide B80	81-82	CK7012		CSK255			SRC7018	SRK7018	CT704SP
FXDG Dyna Glide Glide Custom	83	CK7012		CSK255			SRC7018	SRK7018	CT704SP
FXE Super Glide	81-84	CK7012		CSK255			SRC7018	SRK7018	CT704SP
FXEF Super Glide Fat Bob	81	CK7012		CSK255			SRC7018	SRK7018	CT704SP
FXS Super Glide	81-82	CK7012		CSK255			SRC7018	SRK7018	CT704SP
FXSB Low Rider	83-84	CK7012		CSK255			SRC7018	SRK7018	CT704SP
FXST Softail Standard	EARLY 84	CK7012		CSK255			SRC7018	SRK7018	CT704SP
FXWG Wide Glide	81-84	CK7012		CSK255			SRC7018	SRK7018	CT704SP
FLTCU Tour Glide Classic Ultra	89	CK7010		TBA			SRC7016	SRK7016	CT705SP
FLSTN Heritage Softail Nostalgia	93-96	CK7009		TBA			SRC7019	SRK7019	CT701SP
FLSTS Heritage Springer	97	CK7009		TBA			SRC7019	SRK7019	CT701SP
FLTC Tour Glide Classic	90-92	CK7009		TBA			SRC7014	SRK7014	CT701SP
FLTCU Tour Glide Ultra Classic	90-95	CK7009		TBA			SRC7014	SRK7014	CT701SP
FLSTC Heritage Softail Classic	06-15	CK7008		CSK915			SRC7013	SRK7013	CT703SP
FLSTC Heritage Softail Classic	16-17	CK7008		CSK916			SRC7012	SRK7012	CT703SP
FLSTCANV Heritage Softail Classic Anniversary	13	CK7008		CSK915			SRC7013	SRK7013	CT703SP
FLSTCI Heritage Softail Classic	01-03	CK7008		CSK917			SRC7011	SRK7011	CT703SP
FLSTCI Heritage Softail Classic	04-05	CK7008		CSK916			SRC7012	SRK7012	CT703SP
FLSTCI Heritage Softail Classic	06	CK7008		CSK915			SRC7013	SRK7013	CT703SP
FLSTCI Heritage Softail Classic Shrine	05	CK7008		CSK916			SRC7012	SRK7012	CT703SP
FLSTF Fat Boy	12	CK7008		CSK915			SRC7013	SRK7013	CT703SP
FLSTF 103 Fat Boy	12-14	CK7008		CSK916			SRC7012	SRK7012	CT703SP
FLSTF 103 Fat Boy	15	CK7008		CSK916			SRC7012	SRK7012	CT703SP
FLSTF Fat Boy	98-99	CK7008		CSK917			SRC7011	SRK7011	CT703SP
FLSTF Fat Boy	00-03	CK7008		CSK917			SRC7011	SRK7011	CT703SP
FLSTF Fat Boy	04-05	CK7008		CSK916			SRC7012	SRK7012	CT703SP
FLSTF Fat Boy	06-15	CK7008		CSK915			SRC7013	SRK7013	CT703SP
FLSTF Fat Boy	16-17	CK7008		CSK916			SRC7012	SRK7012	CT703SP
FLSTFB 103 Fat Boy LO	12-15	CK7008		CSK916			SRC7012	SRK7012	CT703SP
FLSTFB103ANV Fat Boy 103 LO Anniversary	13	CK7008		CSK916			SRC7012	SRK7012	CT703SP
FLSTFB Fat Boy LO	10-11	CK7008		CSK915			SRC7013	SRK7013	CT703SP
FLSTFB Fat Boy LO	12	CK7008		CSK916			SRC7012	SRK7012	CT703SP
FLSTFB Fat Boy LO	13-15	CK7008		CSK915			SRC7013	SRK7013	CT703SP
FLSTFB Fat Boy LO	16-17	CK7008		CSK916			SRC7012	SRK7012	CT703SP
FLSTFBANV Fat Boy LO Anniversary	13	CK7008		CSK915			SRC7013	SRK7013	CT703SP
FLSTFI Fat Boy	01-03	CK7008		CSK917			SRC7011	SRK7011	CT703SP
FLSTFI Fat Boy	04-05	CK7008		CSK916			SRC7012	SRK7012	CT703SP
FLSTFI Fat Boy	06	CK7008		CSK915			SRC7013	SRK7013	CT703SP

CLUTCH APPLICATIONS

EBC CLUTCH KITS

Make & Model	Year	CK Series #	CKF Series #	Spring Kit #	DRC Series #	DRCF Series #	SRC Series #	SRK Series #	CT Tool #
HARLEY-DAVIDSON® DYNA Contd.									
FLSTFI Fat Boy Shrine	05	CK7008		CSK916			SRC7012	SRK7012	CT703SP
FLSTI Heritage Softail	06	CK7008		CSK915			SRC7013	SRK7013	CT703SP
FLSTN 103 Softail Deluxe	12-15	CK7008		CSK916			SRC7012	SRK7012	CT703SP
FLSTN Softail Deluxe	05	CK7008		CSK916			SRC7012	SRK7012	CT703SP
FLSTN Softail Deluxe	06	CK7008		CSK915			SRC7013	SRK7013	CT703SP
FLSTN Softail Deluxe	07-15	CK7008		CSK915			SRC7013	SRK7013	CT703SP
FLSTN Deluxe	17	CK7008		CSK916			SRC7012	SRK7012	CT703SP
FLSTN Softail Deluxe	16	CK7008		CSK916			SRC7012	SRK7012	CT703SP
FLSTNI Softail Deluxe	06	CK7008		CSK915			SRC7013	SRK7013	CT703SP
FLSTNI Softail Deluxe	05	CK7008		CSK916			SRC7012	SRK7012	CT703SP
FLSTS Heritage Springer	98-03	CK7008		CSK917			SRC7011	SRK7011	CT703SP
FLSTSB Cross Bones	08-11	CK7008		CSK915			SRC7013	SRK7013	CT703SP
FLSTSC Springer Classic	06-07	CK7008		CSK915			SRC7013	SRK7013	CT703SP
FLSTSC Springer Classic	05	CK7008		CSK916			SRC7012	SRK7012	CT703SP
FLSTSI Heritage Springer	01-03	CK7008		CSK917			SRC7011	SRK7011	CT703SP
FLTR Road Glide	98-03	CK7008		CSK917			SRC7011	SRK7011	CT703SP
FLTR Road Glide	06-09	CK7008		CSK915			SRC7013	SRK7013	CT703SP
FLTRI Road Glide	04-05	CK7008		CSK916			SRC7012	SRK7012	CT703SP
FLTRU Road Glide Ultra	2016	CK7008		CSK917			SRC7011	SRK7011	CT703SP
FLTRU Road Glide Ultra	11-13	CK7008		CSK916			SRC7012	SRK7012	CT703SP
FLTRX 103 Road Glide Custom	11	CK7008		CSK916			SRC7012	SRK7012	CT703SP
FLTRX Road Glide Custom	10-11	CK7008		CSK915			SRC7013	SRK7013	CT703SP
FLTRX Road Glide	15-16	CK7008		CSK917			SRC7011	SRK7011	CT703SP
FLTRX Road Glide Custom	12-13	CK7008		CSK916			SRC7012	SRK7012	CT703SP
FLTRXS Road Glide Special	15-16	CK7008		CSK917			SRC7011	SRK7011	CT703SP
FXCW Rocker	08-09	CK7008		CSK915			SRC7013	SRK7013	CT703SP
FXCWC Rocker C	08-11	CK7008		CSK915			SRC7013	SRK7013	CT703SP
FXD Dyna Super Glide	98-03	CK7008		CSK917			SRC7011	SRK7011	CT703SP
FXFB 1YKJ Fat Bob	18	TBA		CSK236			TBA	TBA	
FLRT Freewheeler	17-18	CK7007		CSK236			SRC7008	SRK7008	CT708SP
FXLR 1YNJ Low Rider	18	TBA		CSK236			TBA	TBA	
HARLEY-DAVIDSON® SPORTSTER									
XLCH1000 Sportster 1000	70	CK7016		TBA			TBA	TBA	
XLH1000 Sportster Standard	70	CK7016		TBA			TBA	TBA	
XLCH1000 Sportster 1000	71-80	CK7015		CSK257			SRC7025	SRK7025	CT709SP
XLH Sportster 1000	81-84	CK7015		CSK257			SRC7025	SRK7025	CT709SP
XLH1000 Sportster 1000 Standard	71-78	CK7015		CSK257			SRC7025	SRK7025	CT709SP
XLS Sportster Roadster 1000	81-84	CK7015		CSK257			SRC7025	SRK7025	CT709SP
XR1000 Sportster 1000	83-84	CK7015		CSK257			SRC7025	SRK7025	CT709SP
XL883 Sportster 883	86-90	CK7014		CSK921			SRC7024	SRK7024	CT709SP
CT709SPXL883DLX Sportster 883 Deluxe	86-90	CK7014		CSK921			SRC7024	SRK7024	CT709SP
XL883HUG Sportster 883 Hugger	87-90	CK7014		CSK921			SRC7024	SRK7024	CT709SP
XLH Sportster 1000	84	CK7014		CSK921			SRC7024	SRK7024	CT709SP
XLH1100 Sportster 1100	86-87	CK7014		CSK921			SRC7024	SRK7024	CT709SP
CT709SPXLH1200 Sportster 1200	88-90	CK7014		CSK921			SRC7024	SRK7024	CT709SP
XLS Sportster Roadster 1000	84	CK7014		CSK921			SRC7024	SRK7024	CT709SP
XLX Sportster Roadster 1000	84	CK7014		CSK921			SRC7024	SRK7024	CT709SP
XR1000 Sportster	84	CK7014		CSK921			SRC7024	SRK7024	CT709SP
FLTCUJ Tour Glide Ultra Classic	96	CK7009		TBA			SRC7014	SRK7014	CT701SP
FXD Dyna Super Glide	95-97	CK7009		TBA			SRC7019	SRK7019	CT701SP
FXDB Dyna Daytona	92	CK7009		TBA			SRC7019	SRK7019	CT701SP
FXDB Dyna Sturgis	91	CK7009		TBA			SRC7019	SRK7019	CT701SP
FXDC Super Glide Custom	92	CK7009		TBA			SRC7019	SRK7019	CT701SP
FXDL Dyna Low Rider	93-97	CK7009		TBA			SRC7019	SRK7019	CT701SP
FXDSCONV Dyna Glide Convertible	93	CK7009		TBA			SRC7019	SRK7019	CT701SP
FXDWG Dyna Wide Glide	93-97	CK7009		TBA			SRC7019	SRK7019	CT701SP
FXST Softail Standard	90	CK7009		TBA			SRC7019	SRK7019	CT701SP
FXSTC Softail Custom	90-97	CK7009		TBA			SRC7019	SRK7019	CT701SP
FXSTS Softail Springer	90-97	CK7009		TBA			SRC7019	SRK7019	CT701SP
XL1200 Forty Eight Anniversary	18	CK7009		CSK919			SRC7020	SRK7020	CT701SP
XL1200 Sportster 1200	91-03	CK7009		CSK920			SRC7023	SRK7023	CT701SP
XL1200C Sportster 1200 Custom	96-03	CK7009		CSK920			SRC7023	SRK7023	CT701SP
XL1200C Sportster 1200 Custom	04-18	CK7009		CSK919			SRC7020	SRK7020	CT701SP
XL1200CA Sportster 1200 Custom Limited A	13-16	CK7009		CSK919			SRC7020	SRK7020	CT701SP
XL1200CANV Sportster 1200 Custom Anniversary	13	CK7009		CSK919			SRC7020	SRK7020	CT701SP
XL1200CB Sportster 1200 Custom Limited B	13-17	CK7009		CSK919			SRC7020	SRK7020	CT701SP
XR1200 Sportster	08-10	CK7013		CSK913			SRC7022	SRK7022	CT701SP
XL1200CP Sportster 1200 Custom (H-D1)	11-16	CK7009		CSK919			SRC7020	SRK7020	CT701SP
XL1200CX 1200 Roadster	16-18	CK7009		CSK919			SRC7020	SRK7020	CT701SP
XR1200X 1200 Sportster X	10-13	CK7013		CSK913			SRC7022	SRK7022	CT701SP
XL1200L Sportster 1200 Low	06-11	CK7009		CSK919			SRC7020	SRK7020	CT701SP
XL1200N Nightster	07-12	CK7009		CSK919			SRC7020	SRK7020	CT701SP
XL1200R Sportster 1200 Roadster	04-09	CK7009		CSK919			SRC7020	SRK7020	CT701SP

CLUTCH APPLICATIONS

EBC CLUTCH KITS

Make & Model	Year	CK Series #	CKF Series #	Spring Kit #	DRC Series #	DRCF Series #	SRC Series #	SRK Series #	CT Tool #
HARLEY-DAVIDSON® SPORTSTER									
XL1200S Sportster 1200 Sport	96-03	CK7009		CSK920			SRC7023	SRK7023	CT701SP
XL1200T Sportster 1200 SuperLow	14-18	CK7009		CSK919			SRC7020	SRK7020	CT701SP
XL1200V Seventy-Two	12-16	CK7009		CSK919			SRC7020	SRK7020	CT701SP
XL1200X Forty Eight	10-18	CK7009		CSK919			SRC7020	SRK7020	CT701SP
XL50 50th Anniversary Sportster	07	CK7009		CSK919			SRC7020	SRK7020	CT701SP
XL883 Sportster 883	91-03	CK7009		CSK920			SRC7023	SRK7023	CT701SP
XL883 Sportster 883	04-09	CK7009		CSK918			SRC7021	SRK7021	CT701SP
XL883C Sportster 883 Custom	98-03	CK7009		CSK920			SRC7023	SRK7023	CT701SP
XL883C Sportster 883 Custom	04-10	CK7009		CSK918			SRC7021	SRK7021	CT701SP
HARLEY-DAVIDSON® SOFTAIL									
FXE Super Glide	84	CK7010		TBA			SRC7016	SRK7016	CT705SP
FXEF Super Glide Fat Bob	85	CK7010		TBA			SRC7016	SRK7016	CT705SP
FXSB Low Rider	84-85	CK7010		TBA			SRC7016	SRK7016	CT705SP
FXST Softail Standard	84-89	CK7010		TBA			SRC7016	SRK7016	CT705SP
FXSTC Softail Custom	86-89	CK7010		TBA			SRC7016	SRK7016	CT705SP
FXSTS Softail Springer	88-89	CK7010		TBA			SRC7016	SRK7016	CT705SP
FXWG Wide Glide	84-86	CK7010		TBA			SRC7016	SRK7016	CT705SP
XL883DLX Sportster 883 Deluxe	91-95	CK7009		CSK920			SRC7023	SRK7023	CT701SP
XL883HUG Sportster 883 Hugger	91-03	CK7009		CSK920			SRC7023	SRK7023	CT701SP
XL883L Sportster 883 Low	05-11	CK7009		CSK918			SRC7021	SRK7021	CT701SP
XL883L SuperLow	12-18	CK7009		CSK918			SRC7021	SRK7021	CT701SP
XL883N Iron 883	09-18	CK7009		CSK918			SRC7021	SRK7021	CT701SP
XL883R 883 Roadster	11-15	CK7009		CSK918			SRC7021	SRK7021	CT701SP
XL883R Sportster 883R	02-06	CK7009		CSK920			SRC7023	SRK7023	CT701SP
XL883R Sportster 883R	07-10	CK7009		CSK918			SRC7021	SRK7021	CT701SP
FXD Dyna Super Glide	04-05	CK7008		CSK916			SRC7012	SRK7012	CT703SP
FXD Dyna Super Glide	07-10	CK7008		CSK915			SRC7013	SRK7013	CT703SP
FXD35 Dyna 35th Anniversary Super Glide	06	CK7008		CSK915			SRC7013	SRK7013	CT703SP
FXDB 103 Dyna Street Bob	14-17	CK7008		CSK916			SRC7012	SRK7012	CT703SP
FXDB Dyna Street Bob	07-17	CK7008		CSK915			SRC7013	SRK7013	CT703SP
FXDBA 103 Dyna Street Bob (H-D1)	13-15	CK7008		CSK916			SRC7012	SRK7012	CT703SP
FXDBA Dyna Street Bob (H-D1)	13-15	CK7008		CSK915			SRC7013	SRK7013	CT703SP
FXDBC 103 Dyna Street Bob Limited	16	CK7008		CSK916			SRC7012	SRK7012	CT703SP
FXDBC Dyna Street Bob Limited	16	CK7008		CSK915			SRC7013	SRK7013	CT703SP
FXDBI Dyna Street Bob	06	CK7008		CSK915			SRC7013	SRK7013	CT703SP
FXDBP 103 Dyna Street Bob	16	CK7008		CSK916			SRC7012	SRK7012	CT703SP
FXDC 103 Dyna Super Glide Custom	14	CK7008		CSK916			SRC7012	SRK7012	CT703SP
FXDC Dyna Super Glide Custom	05	CK7008		CSK916			SRC7012	SRK7012	CT703SP
FXDC Dyna Super Glide Custom	07-14	CK7008		CSK915			SRC7013	SRK7013	CT703SP
FXDCANV Dyna Super Glide Custom Anniversary	13	CK7008		CSK915			SRC7013	SRK7013	CT703SP
FXDCI Dyna Super Glide Custom	05-06	CK7008		CSK915			SRC7013	SRK7013	CT703SP
FXDF 103 Dyna Fat Bob	12-17	CK7008		CSK916			SRC7012	SRK7012	CT703SP
FXDF Dyna Fat Bob	08-17	CK7008		CSK915			SRC7013	SRK7013	CT703SP
FXDI Dyna Super Glide	04-06	CK7008		CSK915			SRC7013	SRK7013	CT703SP
FXDL 103 Dyna Low Rider	14-16	CK7008		CSK916			SRC7012	SRK7012	CT703SP
FXDL 103 Low Rider 103	17	CK7008		CSK916			SRC7012	SRK7012	CT703SP
FXDL Dyna Low Rider	98-03	CK7008		CSK917			SRC7011	SRK7011	CT703SP
FXDL Dyna Low Rider	04-05	CK7008		CSK916			SRC7012	SRK7012	CT703SP
FXDL Dyna Low Rider	06-17	CK7008		CSK915			SRC7013	SRK7013	CT703SP
FXDLI Dyna Low Rider	04-05	CK7008		CSK916			SRC7012	SRK7012	CT703SP
FXDLS Dyna Low Rider S	16-17	CK7008		CSK914			SRC7009	SRK7009	CT703SP
FXDSCONV Dyna Glide Convertible	99-00	CK7008		CSK917			SRC7011	SRK7011	CT703SP
FXDWG Dyna Wide Glide	98-05	CK7008		CSK917			SRC7011	SRK7011	CT703SP
FXDWG Dyna Wide Glide	07-16	CK7008		CSK915			SRC7013	SRK7013	CT703SP
FXDWG 103 Dyna Wide Glide	12-17	CK7008		CSK916			SRC7012	SRK7012	CT703SP
FXDWGANV Dyna Wide Glide 105th Anniversary	08	CK7008		CSK915			SRC7013	SRK7013	CT703SP
FXDWGI Dyna Wide Glide	04-05	CK7008		CSK916			SRC7012	SRK7012	CT703SP
FXDWGI Dyna Wide Glide	06	CK7008		CSK915			SRC7013	SRK7013	CT703SP
FXDX Dyna Super Glide Sport	99-03	CK7008		CSK917			SRC7011	SRK7011	CT703SP
FXDX Dyna Super Glide Sport	04-05	CK7008		CSK916			SRC7012	SRK7012	CT703SP
FXDXT Dyna Super Glide T-Sport	01-03	CK7008		CSK917			SRC7011	SRK7011	CT703SP
FXS 103 Blackline	12-13	CK7008		CSK916			SRC7012	SRK7012	CT703SP
FXS Blackline	11	CK7008		CSK915			SRC7013	SRK7013	CT703SP
FXS Blackline	12	CK7008		CSK916			SRC7012	SRK7012	CT703SP
FXS Blackline	13	CK7008		CSK915			SRC7013	SRK7013	CT703SP
FXSB 103 Softail Breakout	13-15	CK7008		CSK916			SRC7012	SRK7012	CT703SP
FXSB Softail Breakout	13-17	CK7008		CSK915			SRC7013	SRK7013	CT703SP
FXST Softail Standard	99-03	CK7008		CSK917			SRC7011	SRK7011	CT703SP
FXST Softail Standard	04-06	CK7008		CSK916			SRC7012	SRK7012	CT703SP
FXST Softail Standard	07-11	CK7008		CSK915			SRC7013	SRK7013	CT703SP
FXST Softail Standard	12-15	CK7008		CSK916			SRC7012	SRK7012	CT703SP
FXSTB Night Train	99-03	CK7008		CSK917			SRC7011	SRK7011	CT703SP
FXSTB Night Train	04-05	CK7008		CSK916			SRC7012	SRK7012	CT703SP

CLUTCH APPLICATIONS

EBC CLUTCH KITS

Make & Model	Year	CK Series #	CKF Series #	Spring Kit #	DRC Series #	DRCF Series #	SRC Series #	SRK Series #	CT Tool #
HARLEY-DAVIDSON® SOFTAIL Contd.									
FXSTB Night Train	06-09	CK7008		CSK915			SRC7013	SRK7013	CT703SP
FXSTBI Night Train	01-03	CK7008		CSK917			SRC7011	SRK7011	CT703SP
FXSTBI Night Train	04-05	CK7008		CSK916			SRC7012	SRK7012	CT703SP
FXSTBI Night Train	06	CK7008		CSK915			SRC7013	SRK7013	CT703SP
FXSTC Softail Custom	98-99	CK7008		CSK917			SRC7011	SRK7011	CT703SP
FXSTC Softail Custom	07-10	CK7008		CSK915			SRC7013	SRK7013	CT703SP
FXSTD Softail Deuce	00-03	CK7008		CSK917			SRC7011	SRK7011	CT703SP
FXSTD Softail Deuce	04-05	CK7008		CSK916			SRC7012	SRK7012	CT703SP
FXSTD Softail Deuce	06-07	CK7008		CSK915			SRC7013	SRK7013	CT703SP
FXSTDI Softail Deuce	01-03	CK7008		CSK917			SRC7011	SRK7011	CT703SP
FXSTDI Softail Deuce	04-05	CK7008		CSK916			SRC7012	SRK7012	CT703SP
FXSTDI Softail Deuce	06	CK7008		CSK915			SRC7013	SRK7013	CT703SP
FXSTI Softail Standard	01-03	CK7008		CSK917			SRC7011	SRK7011	CT703SP
FXSTI Softail Standard	04-05	CK7008		CSK916			SRC7012	SRK7012	CT703SP
FXSTI Softail Standard	06	CK7008		CSK915			SRC7013	SRK7013	CT703SP
FXSTS Springer Softail	98-03	CK7008		CSK917			SRC7011	SRK7011	CT703SP
FXSTS Springer Softail	04-05	CK7008		CSK916			SRC7012	SRK7012	CT703SP
FXSTS Springer Softail	06	CK7008		CSK915			SRC7013	SRK7013	CT703SP
FXSTSI Springer Softail	01-03	CK7008		CSK917			SRC7011	SRK7011	CT703SP
FLTRU Road Glide Ultra	17-18	CK7002		CSK236			SRC7010	SRK7010	CT702SP
FXSTSI Springer Softail	04-05	CK7008		CSK916			SRC7012	SRK7012	CT703SP
FLTRX Road Glide	17-18	CK7002		CSK236			SRC7010	SRK7010	CT702SP
FLTRXS Road Glide Special	17-18	CK7002		CSK236			SRC7010	SRK7010	CT702SP
FXSTSI Springer Softail	06	CK7008		CSK915			SRC7013	SRK7013	CT703SP
FLDE 1YJ Deluxe	18	TBA		CSK236			TBA	TBA	
FLFB 1YFJ Fat Boy	18	TBA		CSK236			TBA	TBA	
FXBRS Breakout 114	18	CK7007		CSK236			SRC7008	SRK7008	CT708SP
FLSL 1YDJ Slim	18	TBA		CSK236			TBA	TBA	
FXBB 1YJJ Street Bob	18	TBA		CSK236			TBA	TBA	
FXBR 1YEJ Breakout	18	TBA		CSK236			TBA	TBA	
FXBRS Breakout 114 Anniversary	18	CK7007		CSK236			SRC7008	SRK7008	CT708SP
FXFBS Fat Bob 114	18	CK7007		CSK236			SRC7008	SRK7008	CT708SP
HARLEY-DAVIDSON® STREET									
XG500	15-20	CK7004		CSK230			SRC7005	SRK7005	
XG750	15-20	CK7004		CSK229			TBA	TBA	
INDIAN									
Chief Classic	14-20	CK7003		CSK232			SRC7004	SRK7004	
Chief Dark Horse	16-20	CK7003		CSK232			SRC7004	SRK7004	
Chief Vintage	14-20	CK7003		CSK232			SRC7004	SRK7004	
Chieftain	14-18	CK7003		CSK232			SRC7004	SRK7004	
Chieftain Dark Horse	16-20	CK7003		CSK232			SRC7004	SRK7004	
Chieftain Elite	17-20	CK7003		CSK232			SRC7004	SRK7004	
Chieftain Limited	17-18	CK7003		CSK232			SRC7004	SRK7004	
FTR 1200	19-21	CK7018							
Octane	17	CK7001		CSK231			SRC7001	SRK7001	
Roadmaster	15-18	CK7003		CSK232			SRC7004	SRK7004	
Roadmaster Classic	17-20	CK7003		CSK232			SRC7004	SRK7004	
Roadmaster Elite	18-20	CK7003		CSK232			SRC7004	SRK7004	
Scout	15-16	CK7001		CSK231			SRC7001	SRK7001	
Scout	17-20	CK7001					SRC7002	SRK7002	
Scout 1200	17-20	CK7001					SRC7002	SRK7002	
Scout Bobber	18	CK7001					SRC7002	SRK7002	
Scout Sixty	16-17	CK7001		CSK231			SRC7001	SRK7001	
Scout Sixty	17-20	CK7001					SRC7002	SRK7002	
Springfield	16-20	CK7003		CSK232			SRC7004	SRK7004	
Springfield Dark Horse	18	CK7003		CSK232			SRC7004	SRK7004	
KTM									
SX 50	13-19	CK5674							
SX 60	98-00	CK5594	CKF5594	CSK064	DRC107	DRCF107			CT027
SX 65	98-08	CK5594	CKF5594	CSK064	DRC107	DRCF107			CT027
SX 65	09-18	CK5594	CKF5594	CSK021	DRC241	DRCF241			CT057SP
SX 85 (17 Inch/14 Inch Wheels)	03-17	CK5610		CSK042	DRC139				CT028
SX 85 (19 Inch/16 Inch Wheels)	03-17	CK5610		CSK042	DRC139				CT028
SX 85 (17 Inch/14 Inch Wheels)	18-21	CK5668	CKF5668	CSK908	DRC304	DRCF304			CT087SP
SX 85 (19 Inch/16 Inch Wheels)	18-21	CK5668	CKF5668	CSK908	DRC304	DRCF304			CT087SP
125 EGS	94-97	N/A		CSK011	N/A		N/A		
125 EGS	98-99	CK5611	CKF5611	CSK024	DRC145				CT001
125 EXE	00-01	CK5611	CKF5611	CSK024	DRC145				CT001
125 LC 2 Sting	96-98	N/A		N/A	N/A		N/A		
125 Supermoto	00-01	CK5611	CKF5611	CSK024	DRC145				CT001
Duke 125	11-18	CK4522		CSK199			SRC154	SRK154	

EBC CLUTCH KITS

Make & Model	Year	CK Series #	CKF Series #	Spring Kit #	DRC Series #	DRCF Series #	SRC Series #	SRK Series #	CT Tool #
KTM Contd.									
EXC 125	98-06	CK5611	CKF5611	CSK024	DRC145				CT001
EXC 125	07-15	CK5611	CKF5611	CSK132	DRC174				CT001
EXC 125 Six Days	11-15	CK5611	CKF5611	CSK132	DRC174				CT001
RC 125	14-18	CK4522		CSK199			SRC154	SRK154	
SX 125	98-07	CK5611	CKF5611	CSK024	DRC145				CT001
SX 125	08	CK5611	CKF5611	CSK132	DRC174				CT001
SX 125	09-15	CK5611	CKF5611	CSK024	DRC145				CT001
SX 125	15-18	CK5611	CKF5611	CSK210	DRC303				
SX 125	19-21	TBC	TBC	TBC	TBC				
125 SXS	01-02	CK5611	CKF5611	CSK024	DRC145				CT001
XC 150	11-13	CK5611	CKF5611	CSK091	DRC144				CT001
XC-W-150	17-21	CK5611	CKF5611	CSK210	DRC303				
SX 150	08-18	CK5611	CKF5611	CSK091	DRC144				CT001
SX 150	19-21	TBC	TBC	TBC	TBC				
Duke 200	12-18	CK4486		CSK195			SRC153	SRK153	
200 EGS	98-99	CK5611	CKF5611	CSK091	DRC144				CT001
200 EXC	97-14	CK5611	CKF5611	CSK091	DRC144				CT001
200 MXC	98-03	CK5611	CKF5611	CSK091	DRC144				CT001
RC 200	14-17	CK4486		CSK195			SRC153	SRK153	
SX 200	March 06-07	CK5611	CKF5611	CSK091	DRC144				CT001
SX 250 (2T)	94-12	CK5595	CKF5595	CSK080	DRC108	DRCF108			CT007
SX 250 (2T/Diaphragm Spring)	13-21	CK5651	CKF5651	CSK910	DRC275				CT023
SX-F 250 (4T)	05-12	CK1293	CKF1293	CSK179	DRC163	DRCF163			CT001
SX-F 250 (4T/Coil Spring)	13-15	CK5651	CKF5651	CSK091	DRC260				CT023
SX-F 250 (4T)	16-18	CK5612	CKF5612	CSK210	DRC171				CT023
SX-F 250 (4T)	19-21	CK5612		TBC	TBC				CT023
SX-F 250 Factory (4T)	16-18	CK5612	CKF5612	CSK210	DRC171				CT023
250 EGS	94-99	CK5595	CKF5595	CSK080	DRC108	DRCF108			CT007
Duke 250	15-18	CK5666		CSK239			SRC140	SRK140	
EXC 250 (2T)	94-12	CK5595	CKF5595	CSK080	DRC108	DRCF108			CT007
EXC 250 Six Days (2T)	11-12	CK5595	CKF5595	CSK080	DRC108	DRCF108			CT007
EXC 250 (2T)	13-17	CK5651	CKF5651	CSK910	DRC275				CT023
EXC 250 Tpi (2T)	18-21	CK5651	CKF5651	CSK910	DRC275				CT023
EXC 250 Six Days (2T/Diaphragm Spring)	13-15	CK5651	CKF5651	CSK910	DRC275				CT023
250 EXC-G Racing	03	CK5612	CKF5612	CSK210	DRC171				CT023
250 MXC	98-99	CK5595	CKF5595	CSK080	DRC108	DRCF108			CT007
250 SXS	01-03	CK5595	CKF5595	CSK080	DRC108	DRCF108			CT007
250 EXC Racing	02-03	CK5612	CKF5612	CSK210	DRC171				CT023
250 EXC Racing	04	CK5602		CSK210	DRC117				CT059
250 EXC Racing (2T)	05	CK5612	CKF5612	CSK210	DRC154				CT023
250 EXC-G Racing	04	CK5602		CSK210	DRC117				CT059
EXC-F 250 (4T)	08-13	CK1293	CKF1293	CSK179	DRC163	DRCF163			CT001
EXC-F 250 (4T)	14-19	CK5651	CKF5651	CSK910	DRC275				CT023
EXC-F 250 (4T)	20-21	TBC	TBC	TBC	TBC				CT023
EXC-F 250 Six Days (4T)	11-13	CK1293	CKF1293	CSK179	DRC163	DRCF163			CT001
EXC-F 250 Six Days (4T)	14-19	CK5651	CKF5651	CSK910	DRC275				CT023
Freeride 250 R (2T)	14-15	CK5612	CKF5612	TBA					
RC 250	15-18	CK5666		CSK239			SRC140	SRK140	
XC 250 (2T)	11-12	CK5595	CKF5595	CSK080	DRC108	DRCF108			CT007
XC 250 (2T/Diaphragm Spring)	13	CK5651	CKF5651	CSK910	DRC275				CT023
XC-F 250 (4T)	11-12	CK1293	CKF1293	CSK179	DRC163	DRCF163			CT001
XC-F 250 (4T/Coil Spring)	13-17	CK5651	CKF5651	CSK091	DRC260				CT023
XC-F 250 (4T)	18-21	TBC	TBC	TBC	TBC				CT023
300 EGS	94-99	CK5595	CKF5595	CSK080	DRC108	DRCF108			CT007
EXC 300 (2T)	00-12	CK5595	CKF5595	CSK080	DRC108	DRCF108			CT007
EXC 300 (2T/Diaphragm Spring)	13-21	TBC	TBC	TBC	TBC				CT023
EXC 300 (2T)	16-18	CK5651	CKF5651	CSK910	DRC275				CT023
EXC 300 Six Days (2T)	11-12	CK5595	CKF5595	CSK080	DRC108	DRCF108			CT007
EXC 300 Six Days (2T/Diaphragm Spring)	13-15	CK5651	CKF5651	CSK910	DRC275				CT023
EXC 300 Six Days (2T)	16-18	CK5651	CKF5651	CSK910	DRC275				CT023
300 EXC	94-07	CK5595	CKF5595	CSK080	DRC108	DRCF108			CT007
300 MXC	94-03	CK5595	CKF5595	CSK080	DRC108	DRCF108			CT007
300 MXC	04-05	CK5595	CKF5595	CSK080	DRC108	DRCF108			CT007
XC 300 (2T)	11-12	CK5595	CKF5595	CSK080	DRC108	DRCF108			CT007
SX 300	94	CK5595	CKF5595	CSK080	DRC108	DRCF108			CT007
300 Six Days	96	CK5595	CKF5595	CSK080	DRC108	DRCF108			CT007
350 Enduro (2T)	89	CK5596		CSK084	DRC173				CT075
350 EXC	94	CK5631	CKF5631	CSK080	DRC169				CT030
350 Freeride (4T)	12-15	CK5651	CKF5651	CSK910	DRC273				CT023
350 MX (2T)	89	CK5596		CSK084	DRC173				CT075
350 Super Comp	94-95	CK5631	CKF5631	CSK080	DRC169				CT030
EXC-F 350 (Coil Spring)	11	CK5651	CKF5651	CSK091	DRC260				CT023
EXC-F 350 (4T/Diaphragm Spring)	12-17	CK5651	CKF5651	CSK910	DRC273				CT023
EXC-F 350 (4T/Diaphragm Spring)	18-21	TBC	TBC	TBC	TBC				

CLUTCH APPLICATIONS

EBC CLUTCH KITS

Make & Model	Year	CK Series #	CKF Series #	Spring Kit #	DRC Series #	DRCF Series #	SRC Series #	SRK Series #	CT Tool #
KTM Contd.									
EXC-F 350 Six Days (4T/Diaphragm Spring)	12-17	CK5651	CKF5651	CSK910	DRC273				CT023
EXC-F 350 Six Days (4T/Diaphragm Spring)	18-21	CK5651	CKF5651	CSK910	DRC275				CT023
SX-F 350	11-15	CK5651	CKF5651	CSK091	DRC260				CT023
SX-F 350	16-18	CK5651	CKF5651	CSK091	DRC260				CT023
SX-F 350	19-21	TBC	TBC	TBC	TBC				CT023
XC-F 350	12	CK5651	CKF5651	CSK210					CT023
XC-F 350	16-18	CK5612	CKF5612	CSK210	DRC171				CT023
XCF-W 350 (2T)	16	CK5651	CKF5651	CSK091	DRC260				
XCF-W 350 Six Days (2T)	16	CK5651	CKF5651	CSK091	DRC260				
360 EGS	96-97	CK5595	CKF5595	CSK080	DRC108	DRCF108			CT007
360 EXC	96-97	CK5595	CKF5595	CSK080	DRC108	DRCF108			CT007
360 MXC	96-97	CK5595	CKF5595	CSK080	DRC108	DRCF108			CT007
360 SX	96-97	CK5595	CKF5595	CSK080	DRC108	DRCF108			CT007
360 Six Days	96	CK5595	CKF5595	CSK080	DRC108	DRCF108			CT007
380 EGS	98-99	CK5631	CKF5631	CSK129	DRC170				CT030
380 EXC	98-02	CK5595	CKF5595	CSK080	DRC108	DRCF108			CT007
380 MXC	98-01	CK5595	CKF5595	CSK080	DRC108	DRCF108			CT007
SX 380	98-02	CK5595	CKF5595	CSK080	DRC108	DRCF108			CT007
390 Duke	13-17	CK5665		CSK237			SRC139		
RC 390	14-17	CK5665		CSK237			SRC139		
400 Duke	94-95	CK5631	CKF5631	CSK080	DRC169				CT030
400 EGS-E	97	CK5631	CKF5631	CSK129	DRC170				CT030
400 EGS	94	CK5631	CKF5631	CSK080	DRC169				CT030
400 EGS	96-97	CK5631	CKF5631	CSK129	DRC170				CT030
400 EXC (LC4 Engine)	93-95	CK5632		CSK011	DRC178				CT075
400 EXC	94	CK5631	CKF5631	CSK080	DRC169				CT030
400 EXC	96	CK5631	CKF5631	CSK129	DRC170				CT030
400 EXC	00-02	CK5602		CSK210	DRC117				CT059
400 EXC Racing	02	CK5612	CKF5612	CSK210	DRC171				CT023
400 EXC-G Racing	02	CK5612	CKF5612	CSK210	DRC171				CT023
400 EXC Racing	05	CK5612	CKF5612	CSK210	DRC154				CT023
400 EXC	07-09	CK5612	CKF5612	CSK210	DRC171				CT023
400 EXC-G Racing	05	CK5612	CKF5612	CSK210	DRC154				CT023
400 EXC-G Racing	06	CK5612	CKF5612	CSK210	DRC171				CT023
EXC 400 (4T)	09-11	CK5648	CKF5648	CSK140	DRC252				CT041
400 LC-4	98	CK5631	CKF5631	CSK129	DRC170				CT030
400 LC4-E	00-01	CK5631	CKF5631	CSK129	DRC170				CT030
LC4R 400	99	CK5631	CKF5631	CSK129	DRC170				CT030
400 LSE	97	CK5631	CKF5631	CSK129	DRC170				CT030
400 LSE	04	CK5631	CKF5631	CSK129	DRC170				CT030
400 MXC	01	CK5602		CSK210	DRC117				CT059
400 MXC	02	CK5612	CKF5612	CSK210	DRC171				CT023
400 Super Comp	95	CK5631	CKF5631	CSK080	DRC169				CT030
400 Super Comp/EXC	96-99	CK5631	CKF5631	CSK129	DRC170				CT030
RXC-E 400	95	CK5595	CKF5595	CSK011	DRC108	DRCF108			CT007
400 RXC-E	95	CK5632		CSK011	DRC178				CT075
400 RXC-E	96-97	CK5631	CKF5631	CSK129	DRC170				CT030
SC 400 (LC4 Engine)	95	CK5632		CSK011	DRC178				CT075
SXC 400	97	CK5631	CKF5631	CSK129	DRC170				CT030
400 SX-X	98	CK5631	CKF5631	CSK129	DRC170				CT030
400 SX	99	CK5631	CKF5631	CSK129	DRC170				CT030
SX 400	00-01	CK5602		CSK210	DRC117				CT059
400 SX Racing	02	CK5612	CKF5612	CSK210	DRC171				CT023
400 SXC	00	CK5631	CKF5631	CSK129	DRC170				CT030
400 TXC	98	CK5631	CKF5631	CSK129	DRC170				CT030
SX 440	94	N/A		N/A	N/A		N/A		
MXC 440	94	N/A		N/A	N/A		N/A		
EXC 440	94-95	N/A		N/A	N/A		N/A		
450 EXC Racing	03	CK5612	CKF5612	CSK210	DRC171				CT023
450 EXC-G Racing	03	CK5612	CKF5612	CSK210	DRC171				CT023
450 EXC-G Racing	04	CK5602		CSK210	DRC117				CT059
450 EXC-G Racing	05	CK5612	CKF5612	CSK210	DRC154				CT023
450 EXC Racing	04	CK5602		CSK210	DRC117				CT059
450 EXC Racing	05	CK5612	CKF5612	CSK210	DRC154				CT023
450 EXC	04-05	CK5612	CKF5612	CSK210	DRC154				CT023
450 EXC	06-09	CK5612	CKF5612	CSK210	DRC171				CT023
EXC 450 (4T/Coil Spring)	09-11	CK5648	CKF5648	CSK140	DRC252				CT041
EXC 450 (4T/Diaphragm Spring)	12	CK5651	CKF5651	CSK910	DRC273				CT023
EXC-F 450 (4T/Diaphragm Spring)	13-17	CK5651	CKF5651	CSK910	DRC275				CT023
EXC 450 Six Days (4T)	11	CK5648	CKF5648	CSK140	DRC252				CT041
EXC 450 Six Days (4T/Diaphragm Spring)	12	CK5651	CKF5651	CSK910	DRC273				CT023
EXC 450 Six Days (4T/Diaphragm Spring)	13-15	CK5651	CKF5651	CSK910	DRC275				CT023
EXC-F 450 (4T/Diaphragm Spring)	12-16	CK5651	CKF5651	CSK910	DRC275				CT023
EXC-F 450 (4T/Diaphragm Spring)	18-21	TBC	TBC	TBC	TBC				

CLUTCH APPLICATIONS

EBC CLUTCH KITS

Make & Model	Year	CK Series #	CKF Series #	Spring Kit #	DRC Series #	DRCF Series #	SRC Series #	SRK Series #	CT Tool #
KTM Contd.									
EXC-R 450 (4T)	08-10	CK5648	CKF5648	CSK140	DRC252				CT041
450 MXC-G Racing	03	CK5612	CKF5612	CSK210	DRC171				CT023
450 MXC-G Racing	04	CK5602		CSK210	DRC117				CT059
450 MXC-G Racing	05	CK5612	CKF5612	CSK210	DRC154				CT023
MXC 450	06	CK5612	CKF5612	CSK210	DRC171				CT023
450 SMR	04-05	CK5612	CKF5612	CSK210	DRC154				CT023
SMR 450	06-07	CK5612	CKF5612	CSK210	DRC171				CT023
SMR 450 (Slipper Clutch)	08-14	N/A		N/A					
450 SMS	04	CK5612	CKF5612	CSK210	DRC172				CT023
SX 450 (4T)	03	CK5612	CKF5612	CSK210	DRC171				CT023
SX 450 (4T)	04-05	CK5612	CKF5612	CSK210	DRC154				CT023
SX 450 (4T)	06	CK5612	CKF5612	CSK210	DRC171				CT023
SX-F 450 (4T/Coil Spring)	07-11	CK5638		CSK136	DRC184				CT009
SX-F 450 (4T/Diaphragm Spring)	12-13	CK5651	CKF5651	CSK910	DRC273				CT023
SX-F 450 (4T/Diaphragm Spring)	13-17	CK5651	CKF5651	CSK909	DRC281				CT023
SX-F 450 (4T/Diaphragm Spring)	18-21	TBC	TBC	TBC	TBC				CT023
EXC-F 450 (4T)	18-19	CK5651	CKF5651	CSK910	DRC275				
EXC-F 450 (4T)	18	TBA	TBA	TBA	TBA				
450 SX (Quad)	09-11	CK5638		CSK136	DRC184				CT009
XC 450 Quad (4T)	08-09	CK5612	CKF5612	CSK210	DRC171				CT023
500 Enduro (2T)	89	CK5596		CSK084	DRC173				CT075
500 Enduro (4T)	89	CK5596		CSK084	DRC173				CT075
EXC 500 (4T/Diaphragm Spring)	12	CK5651	CKF5651	CSK910	DRC273				CT023
EXC 500 (4T/Diaphragm Spring)	13-15	CK5651	CKF5651	CSK910	DRC275				CT023
EXC 500 Six Days (4T/Diaphragm Spring)	12	CK5651	CKF5651	CSK910	DRC273				CT023
EXC 500 Six Days (4T/Diaphragm Spring)	13-16	CK5651	CKF5651	CSK910	DRC275				CT023
EXC-F 500	17	CK5651	CKF5651	CSK909	DRC281				CT023
EXC-F 500	18-21	TBC	TBC	TBC	TBC				CT023
EXC-F 500 Six Days	18-21	TBC	TBC	TBC	TBC				CT023
500 MX (2T)	89	CK5596		CSK084	DRC173				CT075
500 MX (4T) LC	89	CK5596		CSK084	DRC173				CT075
XC-W 500	16	CK5651	CKF5651	CSK909	DRC281				
SX-F 505	07-09	CK5638		CSK136	DRC184				CT009
505 SX-F (Quad)	09-12	CK5638		CSK136	DRC184				CT009
520 EXC	00-01	CK5602		CSK210	DRC117				CT059
SX 520	00-01	CK5602		CSK210	DRC117				CT059
520 SX Racing	02	CK5612	CKF5612	CSK210	DRC171				CT023
525 EXC-G Racing	03	CK5612	CKF5612	CSK210	DRC171				CT023
525 EXC	03	CK5612	CKF5612	CSK210	DRC171				CT023
525 EXC Racing	04	CK5602		CSK210	DRC117				CT059
525 EXC-G Racing	04	CK5602		CSK210	DRC117				CT059
525 EXC Racing	05	CK5612	CKF5612	CSK210	DRC154				CT023
525 EXC-G Racing	05	CK5612	CKF5612	CSK210	DRC154				CT023
525 MXC Desert Racing	03	CK5612	CKF5612	CSK210	DRC171				CT023
525 MXC Desert Racing	04	CK5602		CSK210	DRC117				CT059
525 MXC Desert Racing	05	CK5612	CKF5612	CSK210	DRC154				CT023
MXC 525	06	CK5612	CKF5612	CSK210	DRC171				CT023
525 MXC-G Racing	04	CK5602		CSK210	DRC117				CT059
525 SMR	04-05	CK5612	CKF5612	CSK210	DRC154				CT023
525 SX Racing	03	CK5612	CKF5612	CSK210	DRC171				CT023
525 SX Racing	04	CK5602		CSK210	DRC117				CT059
525 SX Racing	05	CK5602		CSK210	DRC154				CT023
SX 525	06	CK5612	CKF5612	CSK210	DRC171				CT023
XC 525 (Quad)	08-12	CK5612	CKF5612	CSK210	DRC171				CT023
EXC-R 530 (4T) (9 Friction plate type)	08	CK5648	CKF5648	CSK140	DRC252				CT041
EXC 530 (9 Friction Plate Type)	09-11	CK5648	CKF5648	CSK140	DRC252				CT041
540 SX-C	98-99	CK5639		CSK129	DRC196				CT030
540 SXS Racing	02	CK5612	CKF5612	CSK210	DRC171				CT023
MXC 550	94-96	N/A		N/A	N/A		N/A		
SMR 560	06-07	CK5612	CKF5612	CSK210	DRC171				CT023
600 Enduro (4T) LC	89	CK5596		CSK084	DRC173				CT075
600 MX (4T) LC	89	CK5596		CSK084	DRC173				CT075
620 Duke	94	CK5631	CKF5631	CSK080	DRC169				CT030
620 Duke	97	CK5631	CKF5631	CSK129	DRC170				CT030
620 EGS	94-95	CK5631	CKF5631	CSK080	DRC169				CT030
620 EGS/Adventure	96-97	CK5631	CKF5631	CSK129	DRC170				CT030
620 EGS-E	97	CK5631	CKF5631	CSK129	DRC170				CT030
620 Enduro Ltd	97	CK5631	CKF5631	CSK129	DRC170				CT030
620 EXC	94-95	CK5631	CKF5631	CSK080	DRC169				CT030
620 LC-4	98	CK5631	CKF5631	CSK129	DRC170				CT030
620 LC4 Competition	99	CK5639		CSK129	DRC196				CT030
620 LC4 Super Moto	99	CK5639		CSK129	DRC196				CT030
620 LSE	97	CK5631	CKF5631	CSK129	DRC170				CT030
620 RXC-E	96-97	CK5631	CKF5631	CSK129	DRC170				CT030

CLUTCH APPLICATIONS

EBC CLUTCH KITS

Make & Model	Year	CK Series #	CKF Series #	Spring Kit #	DRC Series #	DRCF Series #	SRC Series #	SRK Series #	CT Tool #
KTM Contd.									
620 Six Days	96	CK5631	CKF5631	CSK129	DRC170				CT030
620 Super Comp	94-95	CK5631	CKF5631	CSK080	DRC169				CT030
620 Super Comp	96-99	CK5639		CSK129	DRC196				CT030
RXC-E 620	95	CK5595	CKF5595	CSK011	DRC108				CT007
620 RXC-E	95	CK5632		CSK011	DRC178				CT075
620 SC	00-01	CK5631	CKF5631	CSK129	DRC170				CT030
SX 620	94	CK5631	CKF5631	CSK080	DRC169				CT030
SX 620	97-99	CK5639		CSK129	DRC196				CT030
SXC 620	97	CK5631	CKF5631	CSK129	DRC170				CT030
620 Supermoto	98	CK5639		CSK129	DRC196				CT030
620 TXC	98	CK5639		CSK129	DRC196				CT030
625 SC	02	CK5639		CSK129	DRC196				CT030
625 SMC	04-06	CK5639		CSK129	DRC196				CT030
625 SXC	03-04	CK5639		CSK129	DRC196				CT030
640 Adventure-R	98-02	CK5639		CSK129	DRC196				CT030
640 Duke-E	98	CK5639		CSK129	DRC196				CT030
Duke-E 640	98	CK5639		CSK129	DRC196				CT030
Duke II 640	99-02	CK5639		CSK129	DRC196				CT030
Duke II 640	03-07	CK5639		CSK129	DRC196				CT030
640 LC Rallye Dakar	97	CK5631	CKF5631	CSK129	DRC170				CT030
640 LC4	99	CK5639		CSK129	DRC196				CT030
640 LC4	99-00	CK5639		CSK129	DRC196				CT030
640 LC4 Six Days	99	CK5639		CSK129	DRC196				CT030
640 LC4-E	00-02	CK5639		CSK129	DRC196				CT030
640 LC4 Adventure	03-06	CK5639		CSK129	DRC196				CT030
640 LC4 Supermoto	03-04	CK5639		CSK129	DRC196				CT030
660 LC4	97	CK5631	CKF5631	CSK129	DRC170				CT030
660 LC4 Rallye	99-00	CK5639		CSK131	DRC175				CT030
660 Rallye	01-03	CK5633		CSK129	DRC176				CT030
660 Rallye Factory	04	CK5633		CSK129	DRC176				CT030
660 SM Factory Replica	02-03	CK5639		CSK131	DRC175				CT030
660 SMC	03-04	CK5639		CSK131	DRC175				CT030
660 SMS	04	CK5631	CKF5631	CSK131					CT030
690 Duke	08-18	CK5642		CSK131	DRC205				CT069
690 Duke R	10-11	CK5642		CSK131	DRC205				CT069
690 Duke R	13-18	CK5642		CSK131	DRC205				CT069
690 Enduro	08-18	CK5642		CSK131	DRC205				CT069
690 R Enduro	09-18	CK5642		CSK131	DRC205				CT069
690 Rally Factory Replica	07-09	CK5641		CSK131	DRC199				CT030
690 SM	07-09	CK5642		CSK129					CT069
690 SM - LE (Limited Edition)	10-11	CK5642		CSK131	DRC205				CT069
690 SMC	08-11	CK5642		CSK131	DRC205				CT069
690 SMR	07-11	CK5642		CSK131	DRC205				CT069
690 SMC R	12-18	CK5642		CSK131	DRC205				CT069
Duke 790	17-21	CK5669			DRC320				
Adventure 790	17-21	CK5669			DRC320				
Duke 890	21	CK5669			DRC320				
Adventure 890	21	CK5669			DRC320				950
Adventure S	03-04	CK5634		CSK130	DRC177				CT015
950 Adventure	02-06	CK5634		CSK130	DRC177				CT015
950 Superenduro R	07-08	CK5634		CSK130	DRC177				CT015
950 Supermoto	05-07	CK5634		CSK130	DRC177				CT015
990 Adventure S	06-08	CK5634		CSK130	DRC177				CT015
990 Adventure R	09-12	CK5634		CSK130	DRC177				CT015
990 Adventure	09-12	CK5634		CSK130	DRC177				CT015
990 Adventure Dakar Edition	11	CK5634		CSK130	DRC177				CT015
990 Superduke	05-11	CK5634		CSK130	DRC177				CT015
990 Superduke R	07-13	CK5634		CSK130	DRC177				CT015
990 Supermoto T (SM-T)	08-13	CK5634		CSK130	DRC177				CT015
990 Supermoto R (SM-R)	08-09	CK5634		CSK130	DRC177				CT015
990 Supermoto R (SM-R)	10-13	CK5634		CSK130	DRC177				CT015
1050 Adventure	15-16	CK5683		TBC			SRC168	SRK168	
1090 Adventure	17-18	CK5683		TBC			SRC168	SRK168	
1090 Adventure L	19	CK5683		TBC			SRC168	SRK168	
1090 Adventure R	17-19	CK5683		TBC			SRC168	SRK168	
1090 Adventure S	19	CK5683		TBC			SRC168	SRK168	
RC8 R (1190cc)	13-15	CK5644		CSK161			SRC098	SRK098	CT021
RC8R/Track (1190cc/6 Spring Clutch)	10-12	CK5644		CSK161			SRC098	SRK098	CT021
RC8R/Track (1190cc/3 Spring Clutch)	13-14	CK5644		TBC					CT021
1190 Adventure	13-16	CK5683		TBC			SRC168	SRK168	
1190 Adventure R	13-16	CK5683		TBC			SRC168	SRK168	
1290 Super Adventure	15-16	CK5683		TBC			SRC168	SRK168	
1290 Super Adventure R	17-21	CK5683		TBC			SRC168	SRK168	
1290 Super Adventure S	17-21	CK5683		TBC			SRC168	SRK168	

CLUTCH APPLICATIONS

EBC CLUTCH KITS

Make & Model	Year	CK Series #	CKF Series #	Spring Kit #	DRC Series #	DRCF Series #	SRC Series #	SRK Series #	CT Tool #
KTM Contd.									
1290 Super Adventure T	17	CK5683		TBC			SRC168	SRK168	
1290 Super Duke GT	17-19	CK5683		TBC			SRC168	SRK168	
1290 Super Duke R	16-19	CK5683		TBC			SRC168	SRK168	
Rekluse After Market Clutch for EXC 250/300 (2T Models/24 Tooth Steel Plate)	03-11	CK5595	CKF5595	N/A	N/A	N/A			CT049
Rekluse After Market Clutch for SX 250/300 (2T Models/24 Tooth Steel Plate)	03-11	CK5595	CKF5595	N/A	N/A	N/A			CT049
METRAKIT									
GP 50/70/80	All			CSK266	DRC311				
MODENAS									
Kriss 110/115		CK4438	CKF4438	CSK040					CT070SP
MONTESA-HONDA									
315R (2T)	97-04	CK1170	CKF1170	CSK163	DRC250				CT009
4RT 250cc (4T)	05-09	CK1171		CSK238					
MORIWAKI/HONDA									
MD 250 H	08-11	CK1305	CKF1305	CSK176					CT001
MORIWAKI/HONDA Contd.									
MD 250 S	08-11	CK1305	CKF1305	CSK176					CT001
MOTOROMA									
Geko 300 Quad	04-06	CK1190	CKF1190	N/A					CT013SP
NORTON									
Commando 961 Sport	10-20	CK2358		CSK126			SRC160	SRK160	
Commando 961 Café Racer	10-20	CK2358		CSK126			SRC160	SRK160	
Commando 961 Dominator	15-20	CK2358		CSK126			SRC160	SRK160	
Commando SE/SF	13-15	CK2358		CSK126			SRC160	SRK160	
OHVALE									
GP-O 110cc, 160cc	19-20	CK1119							
SACHS									
XTC 125	00-07	CK3318	CKF3318	CSK034					CT011
X Road 125	06-07	CK3318	CKF3318	CSK034					CT011
TRIUMPH									
Adventurer	96-01	CK5588	CKF5588	CSK068					CT021
America (Cast Wheel)	07-09	CK5608		CSK015					
Bonneville 800 (790cc) Up to Engine no. 211132	01-04	CK5597		CSK015					CT009SP
Bonneville 800 From Engine no. 211133	01-04	CK5608		CSK015					
Bonneville America	02-06	CK5608		CSK015					
Bonneville/Bonneville Black (865cc)	07-08	CK5608		CSK260					
Bonneville (865cc)	09	TBA		CSK258					
Bonneville SE (865cc)	09	TBA		CSK258					
Bonneville T-100 (790cc) Up to Engine no. 211132	02-04	CK5597		CSK015					CT009SP
Bonneville T-100 From Engine No. 211133	02-04	CK5608		CSK015					
Bonneville T-100 (865cc)	05-09	CK5608		CSK015					
Bonneville - Steve McQueen SE	12	CK5608		CSK015					
Bonneville T100 (900cc/Liquid Cooled)	16-18	CK5669		CSK244			SRC147	SRK147	CT086SP
Bonneville T100 Black (900cc/Liquid Cooled)	16-18	CK5669		CSK244			SRC147	SRK147	CT086SP
Bonneville T120 (1200cc Liquid Cooled)	16-18	CK5669		CSK243			SRC146	SRK146	CT086SP
Bonneville T120 Black (1200cc Liquid Cooled)	16-18	CK5669		CSK243			SRC146	SRK146	CT086SP
Bonneville Bobber (1200cc Liquid Cooled)	17-20	CK5669		CSK243			SRC146	SRK146	CT086SP
Bonneville Bobber Black (1200cc Liquid Cooled)	18-20	CK5669		CSK243			SRC146	SRK146	CT086SP
Bonneville Bobber (1200cc Liquid Cooled)	17-21	CK5669		CSK243			SRC146	SRK146	CT086SP
Bonneville Bobber Black (1200cc Liquid Cooled)	18-21	CK5669		CSK243			SRC146	SRK146	CT086SP
T595 Daytona (9 Friction Plates)	97-98	CK5589	CKF5589	CSK029					CT009
Daytona 600	02-05	CK1206	CKF1206	CSK083					CT013SP
Daytona 650	05	CK1181		CSK015					CT014
Daytona 675	06-12	CK1206	CKF1206	CSK135					CT014
Daytona 675 R	11-12	CK1206	CKF1206	CSK228					CT014
Daytona 675	13-	CK5664							
Daytona 675 R	13-	CK5664							
Daytona 750 (3cyl)	92	CK5588	CKF5588	CSK068					CT021
Daytona 900 (3cyl)	93-96	CK5588	CKF5588	CSK068					CT021
Daytona 955i (10 Friction Plates)	99-06	CK5599	CKF5599	CSK262					CT009
Daytona 1000 (4cyl)	92	CK5588	CKF5588	CSK015					CT021
Daytona Super III (3cyl)	94-97	CK5588	CKF5588	CSK068					CT021
Daytona 1200 (4cyl)	93-98	CK5588	CKF5588	CSK045					CT021
Legend TT	98-01	CK5588	CKF5588	CSK068					CT021

EBC CLUTCH KITS

Make & Model	Year	CK Series #	CKF Series #	Spring Kit #	DRC Series #	DRCF Series #	SRC Series #	SRK Series #	CT Tool #
TRIUMPH Contd.									
Rocket III 2300cc	04-09	CK5624		CSK118					CT021
Rocket III Classic	07-09	CK5624		CSK118					CT021
Rocket III Roadster ABS	10-12	CK5624		CSK118					CT021
Rocket III Touring	08-12	CK5624		CSK118					CT021
Speedmaster 800 (790cc) Up to VIN 210261	03-04	CK5608		CSK015					
Speedmaster From VIN 210262	03-04	CK5608		CSK015					
Scrambler (865cc)	06-09	CK5608		CSK015					
Speedmaster (865cc)	05-09	CK5608		CSK015					
Speed Triple (Carb models)	94-97	CK5588	CKF5588	CSK068					CT021
Speed Triple (EFI)	97-01	CK5589	CKF5589	CSK029					CT009
Speed Triple 955cc (From VIN 141872 to 210444)	02-04	CK5599		CSK029					CT009
Speed Triple (1050cc)	05-08	CK5599		CSK262					CT009
Speed Triple R (1050cc)	12	CK5599		CSK262					
Sprint GT 1050	10-12	CK5599		CSK029					
Sprint ST (1050cc) (From VIN 208167)	05-09	CK5599		CSK262					CT009
Rocket III 2300cc (All models)	04-09	CK5624		CSK118					CT021
Sprint (All carb models up to VIN 9082)	93	CK5588	CKF5588	CSK068					CT021
Sprint (All carb models from VIN 9083)	94-98	CK5588	CKF5588	CSK068					CT021
Sprint RS (Up to VIN 139276)	99-01	CK5589	CKF5589	CSK029					CT009
Sprint RS (From VIN 139277)	02-04	CK5599		CSK029					CT009
Sprint ST (Up to VIN 139276)	99-01	CK5589	CKF5589	CSK029					CT009
Sprint ST (From VIN 139277 to 208166)	02-04	CK5599		CSK029					CT009
Street Cup (900cc Liquid Cooled)	16-21	CK5669		CSK244			SRC147	SRK147	CT086SP
Street Scrambler (900cc Liquid Cooled)	16-21	CK5669		CSK244			SRC147	SRK147	CT086SP
Street Triple 675	07-16	CK1206	CKF1206	CSK135					CT014
Street Triple R 675	09-16	CK1206	CKF1206	CSK135					CT014
Street Triple S 765	17-21	CK1206	CKF1206	CSK135					CT014
Street Triple R 765	17-21	CK1206	CKF1206	CSK135					CT014
Street Triple RS 765	17-21	CK1206	CKF1206	CSK135					CT014
Street Twin (900cc Liquid Cooled)	16-2018	CK5669		CSK244			SRC147	SRK147	CT086SP
TT 600	00-03	CK1206	CKF1206	CSK083					CT013SP
Thunderbird	95-03	CK5588	CKF5588	CSK068					CT021
Thunderbird Sport	98-04	CK5588	CKF5588	CSK068					CT021
Thunderbird (1597cc)	09-12	TBA		TBA					
Thunderbird Storm (1699cc)	11-12	TBA		TBA					
Thruxton 900	04-12	CK5608		CSK015					
Tiger 800	11-12	CK1206	CKF1206	CSK135					CT014
Tiger 800 XC	11-12	CK1206	CKF1206	CSK135					CT014
Tiger 800 XR	18-	CK1206							CT014
Tiger 800 XR (from VIN674842)	18-21	CK5681					SRC166	SRK166	
Tiger 900cc (Up to VIN 71698) Carb Models	93-96	CK5588	CKF5588	CSK068					CT021
Tiger 900cc (From VIN 71699) Injection Models	97-98	CK5589	CKF5589	CSK029					CT009
Tiger 955cc (Up to VIN 198874)	99-04	CK5589	CKF5589	CSK029					CT009
Tiger 955 (From VIN 198875)	04-06	CK5589	CKF5589	CSK262					CT009
Tiger 1050	07-12	CK5599		CSK029					CT009
Tiger 1050 SE	10-12	CK5599		CSK029					CT009
Tiger Explorer 1200	12	TBA		TBA					
Trident 750	92-98	CK5588	CKF5588	CSK068					CT021
Trident 900	92-98	CK5588	CKF5588	CSK068					CT021
Trophy 900 (3cyl)	92-01	CK5588	CKF5588	CSK068					CT021
Trophy 1200 (4cyl)	92-01	CK5588	CKF5588	CSK015					CT021
Thruxton 1200 (Liquid Cooled)	16-21	CK5669		CSK243			SRC146	SRK146	CT086SP
Thruxton R 1200 (Liquid Cooled)	16-21	CK5669		CSK243			SRC146	SRK146	CT086SP
VESPA									
V 50	63-90	CK5679							
SS 50	65-73	CK5679							
PK 50	82-93	CK5679							
PK 50 HP	82-93	CK5679							
PK 50 S	82-93	CK5679							
PK 50 SS	82-93	CK5679							
PK 50 XL	82-93	CK5679							
PK 80	82-86	CK5679							
PK 80 S	82-86	CK5679							
SS 90	65-71	CK5679							
V 90	63-86	CK5679							
P 125 ETS	84-85	CK5679							
PL 125 S	82-90	CK5679							
PK 125 XL	86-93	CK5679							
PX 125	77-82	CK5679							
Primavera ET3 125	76-83	CK5679							

CK/CKF CLUTCH KITS BUYERS GUIDE

Part No.	Make/Model	Year	Part No.	Make/Model	Year	
CK1105	HONDA SS 50 ZK2/ZB2 CD 50 ST/SV/SW/SX Benley 50 S CL 50 V/X Benley CL 50	75-80	CK1130 ▲=CT031	CB500 T	75-77 ▲	
		96-99	CK1131	HONDA CR 250 RB/RC TL 250/TL250 K1 XL 250 K3/K4 CR 450 RB CR 480 RC	81-82	
97-99	78-79					
CK1107	Z50 RZ-RD C 70/C70M	79-86 -78	CK1132 ▲=CT009	CB 250 K3-K5/G5 CJ 250 T/T2 CB 350 K4 CB 360/CJ 360 (All models)	73-76 ▲ 77 ▲ ▲ ▲	
CK1119 ▲=CT088 ■=CT012SP ★=CT012 *=CT002	CR 80 RE CR 80 RF/R2F/RG/R2G/RH/RJ/RK/RL /RM/RP/RR/RS/RT/RBT/RV/RBV/RW /RBW/RX/RBX/RV/RBY/R1/RB1/R2/RB2 CR 85 R3/RB3/R4/RB4/R5/RB5/R6 /RB6/R7/RB7 CB 100 N CA 125 V/W/X CB 125 S/J CB 125 T/T2 CB 125 TDC/TDE CB 125 RS CBF 125 M9/MA/MB/MD/ME CBR 125 RW7/RW8/RW9/RWA/RWB /RC/RD/RF (No judder spring) CD 125 TC CG 125 K1/B/C/E/BR/BR-K/BR-J/S/T/W CLR 125 W 'City Fly' CM 125 CC/CF CT 125 C TL 125 S NX 125 K/S/F Transcity XL 125 K2-K4/SZ/SA XL 125 SB/SC/SZ/SA/RC/RF/RH XLR 125 RW XR 125 L3/L4/L5/L6/L7/L8 CRF 150 F6/F7 CRF 150 R (Small Wheel F 17 Inch/ R 14 Inch) CRF 150 RB (Big Wheel F 19 Inch/ R 16 Inch) CD 185 T XL 185 SZ/SA/SB ATC 200 XD CD 200 TA CM 200 TA/TB CTX 200/CTX 200 A Bushlander TL 200 J/Y TLR 200 D/E/G/H TRX 200 D TRX 200 L/M Fourtrax TRX 200 SX XR 200 RB/RC/RD XR 200 XR 200 R XR 200 R TLR 250 F TRX 250 V/W/X/Y/1/TM Recon (Manual Shift) TRX 250 TE Recon ES (Electric Shift) TRX 250 EX1/2/3/4/5/6/7/8 TRX 250 X9/XA/XB HONDA-DALL'ARA XR 125 SM KAWASAKI KLF 185 A3 OHVALE GP-O 110cc, 160cc YAMAHA MT 125 (Non ABS) MT 125 A (ABS) YZF-R 125 (Radial Mount Front Caliper/Non ABS) YZF-R 125 A (Radial Mount Front Caliper/ABS)	84 ■			CK1133 ▲=CT076SP	CB 750/K1/K2/K3/K4/K5 (From E/No.: -1056080)
		85-02 ■	CK1134	CB 175 (All models) CD 175 (All models) CB 200/CB 200 B SL 350 K0/K1/K2	76-78 69-73	
		03-07 ■	CK1135 ▲=CT009	CB 500/K1/K2	75-77 ▲	
		78-80 ■	CK1140 ■=CT013SP	CB 250 T/N/NA/NB/ND/NBD/NDC CM 250 TB CB 350 SG/SJ CB 400 F/F1/F2 CB 400 T/N/NA/NB/NC CB 450 DX-K CMX 450 CH/CJ Rebel XL 500 SZ/SB/RC	78-82 ■ 81 ■ 86-88 ■ 75-79 ■ 78-82 ■ 89 ■ 02 ■ 80-82 ■	
		98-00 ■			CK1143 ▲=CT076SP	GL 1000 K1/K2 'Goldwing' (From E/No.: -2002384)
		75-79 ★	CK1144 ▲=CT002	CR 125 M2-M4	76-78 ▲	
		78-80 ★	CK1145 ▲=CT076SP	CB 750 F2 CB 750 K6/K7	78 ▲ 76-77 ▲	
		83-86 ■			CK1146 ▲=CT009SP	CB 500 K3 CX 500 CA/CB/Z/A/B/EC GL 500 DC CB 550 F/F1/F2/K3
		83 ■	CK1147	CB 650 Z/B/SCC CX 650 ED GL 650 D2-E	79-82 83-85 84	
		09-15 ■			CK1148	C 50 Z2/ZZ/ZA C 50 All Models C 50 N (Single seat model) C 50 P/S/N/X/Y/1/2 CF 50/CF 50 K2 CRF 50 F MP 50 3/DX3 Solo (AC17) ST 50 J/K Dax XR 50 1/2/3 ATC 70 All Models C 70 Z2/ZZ/C/D/DMC CRF 70 F4/F5/F6/F7/F8/F9/FA/FB/FC/FD XR 70 RV/RW/RX/RV/R1/R2/R3 C 90 C/E/G/MF/P/MP/MG/N/MN P/MP/T/MT
		07-16 ■	CK1149 ▲=CT078SP	CB 750 KZ CB 750 FA/FB/F2C CB 900 FZ/FA/FB/F2B/F2C/FD/F2D CB 1100 RB2/RC2/RD2		
		78 ■	CK1150 ■=CT012SP ▲=CT012	CB 50 J CB 50 V/W Dream 50 CRM 50 RN/RP/RR/RT MB 50	81 ■ 97-98 ■ 93-96 ■ 80-82 ■	
		77-00 ★			CK1123	CD 175
		98-03 ■				
		82-85 ■				
		85 ★				
		76 ■				
		89-97 ■				
		78-79 ■				
		79-86 ■				
		98-99 ■				
		03-08 ■				
		06-19 ■				
		07-19 *				
		07-19 *				
		78 ■				
		80-82 ■				
		84 ■				
		79-80 ■				
		79-80 ■				
		04-05 ■				
		76-78 ■				
		83-87 ■				
		91-97 ■				
		90-91 ■				
		86-87 ■				
		81-83 ■				
		80-84 ■				
		81-83 ■				
		86-02 ■				
		85- ■				
		97-14 ■				
		02-14 ■				
		01-07 ■				
		09-11 ■				
		04 ■				
		87 ■				
19-20						
14-16 ▲						
14-16 ▲						
14-16 ▲						
14-15 ▲						

CLUTCH BUYERS GUIDE

Part No.	Make/Model	Year	Part No.	Make/Model	Year	
CK1150 ■=CT012SP ▲=CT012 Contd.	MBX 50 SD/SF	83-85 ■	CK1154 ■=CT013SP Contd.	/FMA Fourtrax Foreman 4WD	05-10 ■	
	MTX 50 SC	83-87 ■		TRX 500 FPE8/FPE9/FPEA	08-10 ■	
	NSR 50 FP/FR/FS	93-95 ■		Fourtrax Foreman - Power Steering		
	HONDA			HONDA		
	NSR 50 RV/RW/RX/RV	97-00 ■		TRX 500 TM5/TM6 Fourtrax Foreman	05-06 ■	
	NSR 50 SK/SP/SR/SS	89-95 ■		TRX 500 FEC Fourtrax Foreman ES 2/4 WD	12 ■	
	TLM 50 F	85 ■		TRX 500 FMC Fourtrax Foreman 2/4 WD	12 ■	
	XR 50 M5 (AD14) Motard	05 ▲		TRX 500 FPEC Fourtrax Foreman 2/4 WD	12 ■	
	XZ 50 1/2 Ape-AC16	01-02 ▲		XR 500 SZ/SA/RB/RC	79-82 ■	
	XR 75 K4/K5	78-79 ▲				
CRF 80 F4/F5/F6/F7/F8/F9/FB/FC	04-12 ▲	CK1156	C 90 Z2/ZZ (From E/No.:A073285)	75-81		
XR 80 Z/A/B	80-81 ▲		ATC 110 All Models	79-84		
XR 80 R	87-88 ▲		CT 110 A/B/C/D/K/M/P/X	80-09		
			ATC 125 ME	84		
CK1151 CKF1151 ■=CT012SP ▲=CT012	CR 50 RE/RF	84-85 ■	CK1159 ▲=CT053SP	CX 500 TC 'Turbo'	82 ▲	
	NSR 50 V (AC10-180)	97 ■		CX 650 TD 'Turbo'	83 ▲	
	NSR 50 X (AC10-190)	99 ■	CK1160 ■=CT013SP	GL 1100 A/DA/BI/B/DB	▲	
	CR 60 RF/RG	85-86 ▲		CRM 125 RL/RM/RN/RP/RR/RV/RX	90-99 ■	
	CRM 75 RK/RL/RM/RP/RR	89-94 ■		NSR 125 FJ/FK/FL/FM/FN	88-92 ■	
	NSR 75 N/P/R/X/Y (NS-1)	92-00 ■		NSR 125 RK/RL/RM/RN	89-92 ■	
	CR 80 RA/RB/RC/RD	80-83 ▲		NSR 125 RR/RS/RV/RW/RX/RV/R1	93-01 ■	
	MBX 80 FWDD/FWDF	83-86 ■		TRX 350 TE/FE Fourtrax Rancher		
	MTX 80 RFD/RFF	83-84 ■		ES/ES 4x4 (FEY/1-5)	00-05 ■	
	NSR 80 J-2/K/L/N/P/R/S (HC06)	88- ■		NT 400 Bros (NC25)		
	NSR 80 V (HC06-170)	97 ■		NV 400 CJ/CK (Steed)	92-93 ■	
	NSR 80 X (HC06-180)	99 ■		NV 400 CS/CV Steed	95-97 ■	
	TRX 90 P/R/S/T/V/W/X/Y/1-6	93-06 ■	NV 400 DCY/DC1/DC2 (NC40)			
	TRX 90 EX	07-08 ■	Shadow Slasher	00-02 ■		
	TRX 90 X9/XB/XC	09-14 ■	VRX 400 T (NC33)	96 ■		
	Astrea Supra NF 100	99 ■	VT 500 ED/EF	83-85 ■		
	Astrea Grand/Supra	97-98 ■				
	CRF 100 F4/F5/F6/F7/F8/F9/FA/FB/FC	04-12 ▲	CK1163	CR 250 R/RZ/RA	78-80	
	XL 100 SZ/SA/SB	78-82 ▲		ATC 250 RB/RC/RD	81-83	
	XR 100 RP/RR/RS/RT/RV/RW/RX		CK1165 ▲=CT002	VF 400 FD	83-85 ▲	
	/RY/R1/R2/R3	93-03 ▲		CK1166 ▲=CT031	CBX 750 FE	84-85 ▲
	XR 100 M5 (HD13) Motard	05 ▲	VF 750 SC (V45 Sabre)		82 ▲	
	XZ 100 2 APE-HC07	02 ▲	VF 750 CH		87 ▲	
	ATC 125 MG	86 ■	VT 750 C 'Shadow'		83 ▲	
	CB 125 F (GLR 125 1WHF)	15-16	XLV 750 R (RD/RF)	83-88 ▲		
	CB 125 F (GLR 125 1WHH)	17-18	CK1167 ▲=CT031 ■=CT009	VF 750 FD/FE	83-85 ▲	
	CBF 125 6 Stunner	06▲		XRV 750 L/M/N/P/R/S/T/V/W/X/Y	90-03 ■	
	CBF 125 M7 Stunner	07▲	PC 800 Pacific Coast	89-97 ■		
	H 100 A/SD/SG/SJ	84-92 ■	CK1170 CKF1170 ■=CT009	CR 250 RD-RK	83-89 ■	
	TRX 125 J	88 ■		CR 480 RD	83 ■	
	CBF 150 5	05▲		CR 500 RE/RG/RH/RJ/RK	84-89 ■	
	CBF 150 M5 Unicorn	05▲		NX 500 J/K/L/M/N/P/R/S/T/V/W/X Dominator	88-99 ■	
	CBF 150 6 (Spoke Wheels)	06▲		XR 500 RD/RE	84-85 ■	
	CBF 150 M6/M7 Unicorn (Spoke Wheels)	06-07▲		SLR 650 V/W	97-98 ■	
	CBF 150 M7/M9/MA Unicorn (Cast Wheels)	07-10▲		XL 600 RD/RF/LMF/RMH/LMH/		
	CBF 150 MB/MC Unicorn (Cast Wheels)	11-12▲		LD/RE/LE/RG/RH	83-87 ■	
	ATC 185 A/SB/SC/SD	80-83 ■		XR 600 RF/RG/RH/RJ/RK/RL/RM/		
	ATC 200 B/ESE/ESF/SE	81-84 ■		RP/RR/RS/RT/RV/RW/RX/RV	89-00 ■	
	YAMAHA		FMX 650 5/6	05-08 ■		
	XT 125 R (13D3/13D5)		FX 650 X/Y	99-03 ■		
	(4 friction plate clutch)	07-11 ▲	NX 650 J/K/L/M/N/P/R/S/T/V/W/X	88-01 ■		
	XT 125 X (13D4/13D6)		XR 650 L	93-12 ■		
	(4 friction plate clutch)	07-11 ▲	MONTESA-HONDA			
	YBR 125 ED (3D91/3D92)	05-12 ▲	315 R (2T)	97-04 ■		
	YBR 125 (51D1/2) (4 plate clutch)	10-16 ▲				
	YBR 125 Custom	08-16 ▲	CK1171 ■=CT009SP	MONTESA-HONDA		
				4RT 250cc (4T)	05-10 ■	
	CK1152 ■=CT013SP	XL 250 S/SZ/SA	78-80 ■	CK1176 ▲=CT031 ■=CT009	VF 1000 FE/FF/RE/RF/RG/F2F	84-86 ▲
		XR 250 SZ/SA	78-80 ■		VT 1100 C2 (W/X/Y/1/2/3/4/5)	98-05 ■
	CK1153 ■=CT013SP	NS 125 FG/FH/RH	86-87 ■	VT 1100 C2 (S/T/V)	95-97 ■	
CB 250 RSA/RSD		81-84 ■	VT 1100 C3 (W/X/Y)	98-00 ▲		
CL 250 SC		81 ■	CK1177 ▲=CT002	VFR 400 ZG/ZH/RG/RG-YA/RH2/RJ (NC21/24)	85-88 ▲	
XL 250 RB/RC/RD		81-83 ■		VF 500 FE/F2E/FF/F2F	84-85 ▲	
XL 250 SB/RC	81-82 ■	SUZUKI	GSX 400 R/S/T/X/ZR/ZS/ZT			
CK1154 ■=CT013SP	TRX 420 FM7/FM8/FM9/FMA/FMB	07-11 ■	'Impulse Type S'	94-99 ▲		
	4WD - Fourtrax		RF 400 RP/RR/VR/RT/RVT/RV-V (GK78A)	93-97 ▲		
	TRX 420 FPM9/FPMA/FPMB	09-11 ■	RV 400 RP/RR	93- ▲		
	Fourtrax - 4WW - Power Steering					
	TRX 420 TM7/TM8/TM9/TMA/TMB	07-12 ■				
	Fourtrax 2WD	82 ■				
FT 500C						
TRX 500 FE5/FE6/FE7/FE8/FE9	05-10 ■					
/FEA Fourtrax Foreman 4WD-ES						
TRX 500 FM5/FM6/FM7/FM8/FM9						

Part No.	Make/Model	Year	Part No.	Make/Model	Year
CK1180 ■=CT013SP	KAWASAKI MBX 125 FE MTX 125 RWD/E/F/H/L MTX 200 RWF XR 200 R XL 250 RE-RF XLR 250 R - 5 Plate 'Baja' XR 250 RE/RF	84-86 ■ 83-95 ■ 85 ■ 84-85 ■ 84-85 ■ 84-85 ■	CK1193	HONDA ATC 250 RF/RG	85-86 ■
CK1181 ▲=CT013 ■=CT013SP ★=CT014	KLF 220 A1-A15 KLF 250 A1/A2/A3/A6F/A7F/A8F /A9F/AAF/ABF HONDA CRM 250 ARV/ARW (MD32) CRM 250 MK3 (MD24-140) CRM 250 RR/RR-II (MD24) 140 MK3 NSR 250 RG/R2J (MC16/18) NSR 250 R5K/R5K-2 NSR 250 R7L/R7N NSR 250 RR CB 400 SS (SS2-NC41) CBR 400 RRL/RRN/RRR (NC29) CL 400 (NC38) XR 400 R5/R6 Motard (NC38E) XR 400 M Supermotard (ND08/NC38E) CB 500 R/T/N/W/SW/X/SX/Y/SY/2/S2 CBF 500 4/A4/A5/A6/A7 XL 600 VH/VJ/VN/VN/VP/VR/VT /VV/VW/VX Transalp VT 600 CN/CR/CS/CT/CV/CW/CX CB 650 F (Non ABS) CB 650 FA (ABS) CBR 650 F (Non ABS) CBR 650 FA(ABS) SUZUKI DR 250 RS/RLS/RT/RV/RLV/RW/RLW /RY (SJ45A/DOHC) DR 250 RXT/RXL/RXV/RXLV/RXW /RXLW/RXGW/RXGLW/RXY/RXGY (Deibel 250 XC/GPS Ver SJ45A) DR-Z 250 K1-K7 (DJ43A) TRIUMPH Daytona 650	88-02 ■ 03-11 ■ 97-98 ▲ 94-96 ▲ 94-96 ▲ 86-88 ▲ 89 ▲ 90 ▲ 94 ▲ 01-05 ▲ 90-94 ■ 98-03 ▲ 05-06 ▲ 06-08 ▲ 94-03 ■ 04-07 ■ 87-00 ■ 92-00 ■ 14-20★ 14-20★ 14-20★ 14-20★ 95-00 ▲ 01-07 ▲ 05 ★	CKF1193 ▲=CT013 ★=CT014 ■=CT013SP ❖=CT080	CRM 250 R (RK) MK1/MD 24 (100001-1008385) CRM 250 R (RM) MK2/MD24 (1200001-1211634) CRM 250 R (RP/RP-II) MK2/2 MD24 (1300001-) TRX 250 RG/RH/RJ/RK TRX 400 EXX/EXY/EX1-EX8 TRX 400 X9 XR 400 RT/RV/RW/RX/RY/R1-R5 CBR 600 FX/FY (Carb Model)	89-90 ▲ 91-92 ▲ 93 ▲ 86-89 ▲ 99-08 ▲ 09 ▲ 96-05 ▲ 99-00 ★
CK1183 ▲=CT066SP	CBX 1000 Z/B/C	79-81 ▲	CK1194 ▲=CT013SP	TRX 250 F/G/H ATC 250 ESF/ESG/ESH/ESJ	85-87 ▲ 85-88 ▲
CK1186 ▲=CT002 CK1190 CKF1190 ▲=CT013 ■=CT013SP	CR125 RC CR 125 RD/RE AX-1 (NX 250 J/K/R/R3) CBF 250 4/6 NX 250 J/K/L (MD21) NX 250 2L/M/P/2P XL 250 Degree XLR 250 R - 6 Plate 'Baja' CRM 250-3 XR 250 RG/RH/RJ/RK/RL/RM/RN/RP /RR/RSRT/RV/RW/RX/RY/R1/R2/R3 XR 250 Y/3 (MD30) XR 250 3/5 (MD30) Motard XR 250 III Y/3 Baja TRX 300 EX All models TRX 300 X9 XR 350 RD/RE HONDA-DALL'ARA XR 250 R XR 250 SM MOTO ROMA Geko 300 Quad	82 ▲ 83-84 ▲ 89-94 ■ 04-06 ■ 87-90 ■ 90-93 ■ 94- ▲ 86-03 ■ 00-03 ■ 03-05 ■ 00-03 ■ 93-08 ■ 09 ■ 83-84 ■ 04 ■ 04 ■ 04-06 ■	CK1196 ■=CT013SP	TRX 300 FWJ/FWK/FWL/FWT/FWV /FWW/FWX/J/K/L/T/V/W/X/Y TRX 350 G/H/J/K/L/M/N TRX 350 FMY/1-5 Fourtrax Rancher/4x4 TRX 400 FWS/T/V/W/X/Y TRX 420 FE7/FE8/FE9/FEA/FEB 4WD - Fourtrax ES TRX 420 TE7/TE8/TE9 Fourtrax ES-2WD TRX 450 ESW/ESX/ESY/ES1	88-00 ■ 86-93 ■ 00-05 ■ 95-00 ■ 07-11 ■ 07-09 ■ 98-01 ■
CK1191 CKF1191 ▲=CT012 ■=CT012SP	CR 125 RB CRF 150 R (Small Wheel F17"/ R14") CRF 150 RB (Big Wheel F19"/ R16") CB 250 N/T/W/X/Y/1/4 "Two Fifty" VT 250 FD CD250 UJ/UK CMX 250 CT/CV/CW/CX	81 07-20 ▲ 07-20 ▲ 93-05 ■ 83 ▲ 88-92 ■ 96-00 ■	CK1199	CR 125 RZ/RA	79-80
			CK1200 ▲=CT001	CR 125 RF	85 ▲
			CK1206 CKF1206 ▲=CT014 ●=CT014SP ■=CT055SP	CBR 600 FM/FN/FP/FR/FS/FT/FV/FW CB 600 FW/FX/FY/FSY/F2Y/F21 /F1/F2/F22/F3/F4/F5/F6 Hornet CBF 600 N4/N5/N6 (Non ABS) CBF 600 NA4/NA5/NA6 (ABS) CBF 600 S4/S5/S6 (Non ABS) CBF 600 SA4/SA5/SA6 (ABS) VFR 750 FG/FH/FJ/FL/FM/FN/FP/ FR/FS/FT/FV VF 750 CP/CR/CS/CT/CV VFR 800 Fi-W/Fi-X CBR 900 RRN/RRP/RRR/RRS (893cc) CBR 900 RRY/RR1 (929cc Fireblade) CBR 900 RR2/RR3 954cc Fireblade SUZUKI GSXR 600 V/W/X/Y GSXR 600 K4/K5 TRIUMPH TT 600 Daytona 600 Daytona 675 Daytona 675 R Street Triple 675 Street Triple R 675 Street Triple S 765 Street Triple R 765 Street Triple RS 765 Tiger 800 Tiger 800 XC	91-98 ● 98-06 ● 04-06 ● 04-06 ● 04-06 ● 04-06 ● 86-97 ▲ 93-97 ▲ 98-99 ▲ 92-95 ▲ 00-01 ▲ 02-03 ▲ 97-00 ■ 04-05 ▲ 00-03 ● 02-05 ● 06-16 ▲ 11-16 ▲ 07-16 ▲ 09-16 ▲ 17-20 ▲ 17-20 ▲ 17-20 ▲ 11-12 ▲ 11-12 ▲
			CK1210 ▲=CT053SP	GL 1200 AE/DE/AF	84-85 ▲
			CK1217 ■=CT013SP ▲=CT014	MTX 200 RWD CBX 250 Twister CBX 250 RSE GB 250 E/H/J/L/P/S/V 'Custom' YAMAHA XTZ 250 Lander (Brasil) YBR 250 (5D11/3/4) YS 250 Fazer (Brasil)	83-84 ■ 84 ■ 84-97 ■ 07-09 ▲ 07-11 ▲ 06-08 ▲

Part No.	Make/Model	Year	Part No.	Make/Model	Year
CK1218 CKF1218 ▲=CT014	HONDA NS 250 FE (MC11)	84	CK1224	HONDA GL 1200 DH/AH/AG/DG	86-87
	NS 250 RE/RG (MC11)	84-86	CK1228 ■=CT009SP	HONDA CB-1 (CB 400 F) CB 400 SF (F2N/F2R) (Super Four) (NC31) CB 400 SF (F2V/F3T) Superfour (NC31) CB 400 SF (F3V) Superfour (NC31) CB 400 Four V/V-II/W-II (NC36) CBR 400 RG/RH-YA (NC23) CBR 400 RRJ/RRK (NC23) CBR 500 FH/FJ/FK/FL CBX 550 FC/F2C/FD/F2D CBR 600 FH/FJ/FK/FL	89-90 ■ 92-95 ■ 96-97 ■ 97 ■ 97-98 ■ 86-87 ■ 92-93 ■ 87-90 ■ 82-85 ■ 87-90 ■
NS 400 RF/RG	85-87	CK1229 ▲=CT014			HONDA VFR 750 RJ/RK/RL (RC30) SUZUKI GSXR 750 Y
CB 600 F7/F8/F9/FA/FB/FAC	07-13 ▲		CK1230 ■=CT013SP ▲=CT014SP	NTV 600 J/K/M NTV 650 J/K/L/M/P/S/T/V NT 650 J/K/L (BR05) NT 650 VW/VX/VY/V1-V5 Deauville XL 650 VY/V1/V2/V3/V4/V5/V6/V7 XRV 650 J/K XL 700 V8/V9/VA/VA8/VA9/VAA Transalp NC 700 SC/SD (Manual Gearbox) NC 700 XC/XD (Manual Gearbox) NT 700 V6/VA7/V7/V8/VA8/VA/VAA Deauville NC 750 S NC 750 S (ABS) NC 750 X NC 750 X (ABS) VT 750 CV/C2V/CW/C2W/CX/C2X /CY/C2Y/C1/C21/C4/C5/C6/C7/C8 VT 750 C2BA/C2BB/C2BC/C2BE Shadow Black Spirit VT 750 CS2A/C2SB Shadow VT 750 DC1/DC2 'Black Widow' VT 750 DC7/DC8 Shadow Spirit VT 750 S (VT 750 SA/SB)	
CB 600 FR1/FR2 (Rossi Injection Model)	01-02 ▲	BENELLI Leoncino 500 Leoncino Trail 500 TRK 502 ABS Euro 4 TRK 502 X BN 600 GT BN 600 i BN 600 R BN 600 S			17-19 ▲ 18-19 ▲ 17-18 ▲ 18-19 ▲ 14-17 ▲ 14-17 ▲ 14-15 ▲ 14-15 ▲
CB 600 RR (Non ABS)	03-19 ▲		CK1234	FL 400 R/RK/RL 'Pilot'	89-93
CB 600 RA9/RA/RAB/RRC/RAD /RAG/RRD (C-ABS)	09-19 ▲	CK1235 ■=CT012SP	CB 250 FT/FV/FX/FY/F1 CBR 250 FG/RH/RJ/RK/RK2 (MC14/17/19) CBR 250 RRL/RRN/RRR (MC22-100/105/110) VTZ 250 H/J/K VT 250 CR/CT/CV 'Magna' MC29 VT 250 FL Spada/Castec VTR 250 W/Y/1-7 (MC33) VTR 250-9	96-01 ■ 86-89 ■ 90-94 ■ 86-88 ■ 95-97 ■ 88-90 ■ 98-07 ■ 09-10 ■	
CBR 600 RR Hannspree	08 ▲			CK1239 ▲=CT031	VT 1100 CH/CJ/CN/CP Shadow VT 1100 CR/CS/CT/CV/CW Shadow
CBR 600 FAB/FAC (ABS Model)	11-12 ▲	CK1247 CKF1247 ▲=CT009 ■=CT006	CR 250 RL/RM/RN/RP/RR/RS/RT/RV /RW/RX/RY/R1/R2/R3/R4/R5/R6/R7 CRF 450 R2/R3/R4/R5/R6/R7/R8 CRF 450 X5/X6/X7/X8/X9/XB/XC/XD/XF/XG/XH CRF 450 XRL (Road Legal) CRF 450 R9/RA (4 spring type clutch) CR 500 RLRM/RN/RP/RR/RS/RT /RV/RW/RX/RY/R1 KAWASAKI KX 450 F (D6F/D7F/D8F/E9F/EAF/EBF) KLX 450 R A8F/A9F/AAF/ABF/ACF/ACF /ADF/AEF/AFF/AGF KX 450 F	90-07 ▲ 02-08 ▲ 05-17 ▲ 14-16 ▲ 09-10 ▲ 90-01 ▲ 06-11 ■ 08-15 ■ 12-20 ■	
CBR 600 FB/FC	11-12 ▲			CK1220	CB 750 F/F1
VFR 800 2/3/4/5/6/8/9	02-09 ▲	CK1221 ▲=CT053SP	GL 1000 K1 (Up to E/No.2002383)	77 ▲	
VFR 800 A2/A3/A4/A5/A6/A8/A9	02-13 ▲	CK1222 ▲=CT001	CR 125 RG/RH/RJ/RK/RL/RM/RN/ RP/RR/RS/RT/RV/RW/RX CR 125 SMS 125 WR 125 WRE 125	86-99 ▲ 00-11 ▲ 00-11 ▲ 00-11 ▲ 00-11 ▲	
VFR 800 XA (Crossrunner/ABS)	11-13 ▲			CK1223	CB 750/CB 750 K1 (Up to E/No.: -1056079)
VFR 800 XA (Crossrunner/ABS)	15-16 ▲	CK1219 ▲=CT009 ■=CT033SP	HONDA GB 500 TT XBR 500 F/G/H/SH/SJ SUZUKI SV 400 K3/K4/K5 SV 400 SK3/SK4/SK5 DL 650 K4/K5/K6 DL 650 AK7/AK8/AK9/ALO V-Strom ABS DL 650 AL1XP V-Strom Xpedition DL 650 AL2/AL3/AL4/AL5 V-Strom DL 650 AK9 GT V-Strom Traveller ABS DL 650 XT V-Strom SFV 650 K9/L0/L1/L2/L3/L4/L5 SFV 650 AK9/ALO/AL1/AL2/AL3/AL4/AL5 (ABS) SV 650 K3/K4/K5/K6/K7/K8/K9/L0 Naked - Non ABS SV 650 AK7/AK8/AK9/ALO Naked - ABS SV 650 SAK7/SAK8/SAK9/SALO SV 650 SK3/SK4/SK5/SK6/SK7/SK8 /SK9/SLO Top Fairing - Non ABS SV 650 ABS	06-10 ▲ 07-12 ▲ 07-12 ▲ 07-12 ▲ 07-15 ▲ 08-14 ▲ 08-15 ▲	
CB 900 F2/F3/F4/F5/F6/F7 Hornet	02-07 ▲			85-89 ▲	
CBR 900 RRW/RRX/RRY	98-00 ▲			03-05 ■	
VFR 800 F (ABS Model)	14-16 ▲			03-05 ■	
SUZUKI GSR 600 K6/K7/K8	06-10 ▲			04-06 ■	
GSF 650 K7/K8/K9/L0/L1/L2 Naked Bandit - Non ABS	07-12 ▲			07-11 ■	
GSF 650 SK7/SK8/SK9/SLO/SL1 /SL2 Faired Bandit - Non ABS	07-12 ▲			11 ■	
GSF 650 AK7/AK8/AK9/ALO/AL1 /AL2 Naked Bandit - ABS	07-12 ▲			12-15 ■	
GSF 650 SAK7/SAK8/SAK9/SALO /SAL1/SAL2 Faired Bandit - ABS	07-15 ▲			09-11 ■	
GSX 650 FK8/FK9/FL0/FL1/FL2 (Non ABS)	08-14 ▲			15-20 ■	
GSX 650 FAK8/FAK9/FAL0/FAL1 /FAL2 (ABS Model)	08-15 ▲			09-15 ■	

Part No.	Make/Model	Year	Part No.	Make/Model	Year
CK1248 CKF1248 ▲=CT009	HONDA CB 1000 FP/FR/FS/FT/FV CBR 1000 FH/FJ/FK/FL/FM/FN/ FP/FR/FS/FT/FV/FW/FX	93-97 ▲ 87-99 ▲	CK1291 ▲=CT021	HONDA CBR 1100 XXX/XXY/XX1/XX2/XX3 /XX4/XX5/XX6 'Blackbird' CB 1100 SFY/SF1 "XII" VTR 1000 SPY/SP1 (SC45)	99-07 ▲ 00-03 ▲ 00-01 ▲
CK1250 ▲=CT002	VFR 400 R3K/R3L/R3M/R3N (NC30)	89-92 ▲	CK1292 ▲=CT011	VT 125 CX/CY/C1/C21/C3/C4/C7/C8 XL 125 V1/V2/V3/V4/V5/V6/V7/V8/V9/VA	99-08 ▲ 01-11 ▲
CK1252 ■=CT012SP ▲=CT012	CA 125 S/T CB 125 TDJ CBR 125 R4/R5/RS5/RS6/RW5/RW6 CG 125 M1/1/ES4-8 LS 125 R CBR 150 R TA 200 (TA Shadow) FTR 223 Y/2/A2 (MC34) CRF 230 L CRF 230 M Supermoto SL 230 V/W/X/1 XL 230-2 (NC36)	95-96 ■ 87-89 ■ 04-06 ■ 01-08 ▲ 00- ■ 00-03 ■ 02-05 ■ 00-02 ■ 08-10 ■ 09-10 ■ 97-02 ■ 02 ■	CK1293 CKF1293 ▲=CT001	CR 125 RY/R1/R2/R3 CR 125 R4/R5/R6/R7 CRF 250 R4/R5/R6/R7 CRF 250 RA GAS-GAS EC 125 (2T) SM 125 (2T) Supermotard KTM EXC-F 250 EXC-F 250 (4T) Six Days SX-F 250 (4T) XC-F 250 (USD) XC-F 250 SX-F 250 (4T) XC-F 250 (USD) XC-F 250	00-03 ▲ 04-07 ▲ 04-07 ▲ 10 ▲ 00-08 ▲ 03-06 ▲ 07-13 ▲ 11-12 ▲ 05-12 ▲ 11-12 ▲ 12 ▲ 05-12 ▲ 11-12 ▲ 12 ▲
CK1253 ▲=CT014 ■=CT013	VFR 800 Fi-Y/Fi-1 BMW G 310 GS G 310 R	00-01 ▲ 17-20 ■ 17-20 ■	CK1295 ▲=CT009	XR 650 RY/R1-R7 HONDA-DALL'ARA XR 650 R	00-07 ▲ 04 ▲
CK1257 ▲=CT031 ■=CT009	NR 750 N RVF 750 RR-R/RR-S (RC45) XL 1000 V3/V4/V5/V6 V7/V8/V9 /VA/VB Varadero Non ABS Model XL 1000 VA4/VA5/VA6/VA7/VA8/VA9 /VAA/VAB Varadero - ABS Model CB 1100 AD (Cast Wheels/3 Piston Calipers) CB 1100 AE (Cast Wheels/3 Piston Calipers) CB 1100 EX (Spoke Wheels/4 Piston Caliper) CB 1300 F3/F13 CB 1300 5/6/7/8/9 (Superfour) CB 1300 A5/A6/A7/A8/A (Superfour ABS) CB 1300 SA5/SA6/SA7/SA8/SA9/SAA CB 1300 S5/S6/S7/S8/S9	92 94-98 ▲ 03-11 ■ 04-11 ■ 13 ■ 14 ■ 14-16 ■ 03-04 ■ 05-09 ■ 05-09 ■ 05-11 ■ 05-09 ■	CK1297 ▲=CT021	ST 1300 A2/A3/A4/A6 Pan European (ABS Model) ST 1300 8/9 Pan European (Non ABS) ST 1300 A8/A9/AA Pan European (ABS Model) GL 1800 A1/A2/A3/A4/A5 Goldwing GL 1800 6/7/8/9/A Goldwing	02-07 ▲ 08-09 ▲ 08-15 ▲ 01-05 ▲ 06-15 ▲
CK1264 ■=CT056SP	ST 1100 AN/AP/AR/AS Pan European (ABS Model) ST 1100 AT/AV/AW/AX/AY/A1/A2 Pan European (ABS Model) ST 1100 L/M/N/P/R/S/T/V/W/XY Pan European - Non ABS	92-95 ■ 96-02 ■ 90-02 ■	CK1298 ▲=CT021	VTX 1300 S3/S4/S5/S6/S7/S8 CTX 1300 CTA Interstate VT 1300 CXA Chopper VTX 1300 CXAA VTX 1800 C2/C3/C4/C5/C15/C16/C17	03-08 ▲ 11-15 10-12 ▲ 10-11 ▲ 02-08 ▲
CK1265 ■=CT009SP	CB 400 SFX/SFY/SF1/SF2/SF3 /SF4/S/S5 Super Four (NC39) CB 750 F2N/F2R/ F2S/F2T/F2W/F2X/F2Y/F21	99-05 ■ 92-02 ■	CK1299 ▲=CT009	CB 1300 FW/FX/FY/F1 (SC40)	98-01 ▲
CK1284 ▲=CT014	CBR 900 RRT/RRV (918cc)	96-97 ▲	CK1300 ▲=CT021	VTR 1000 SP2/SP3/SP4/SP5/SP6	02-07 ▲
CK1285 ▲=CT068SP	GL 1500 CV/CW/CX/CY/C1/C2 'F6C' GL 1500 SEV/SEW/SEX/SEY GL 1500 J-SES	97-02 ▲ 97-00 ▲ 88-96 ▲	CK1302 CKF1302 ▲=CT009	TRX 450 R4/R5/R6/ER6/R7/ER7 /R8/ER8/R9/ER9 TRX 700 XX8/XX9/XXB	04-08 ▲ 08-11 ▲
CK1286 ▲=CT021	CBR 1100 XXV/XXW 'Blackbird'	97-98 ▲	CK1303 ■=CT009	CBR 1000 RR4/RR5/RR6/RR7 CB 1000 R9/RA/RB/RC/RD/RE/RF Non ABS Model CB 1000 RA9/RAA/RAB/RAC/RAE RAF/RAG (ABS Model) CBF 1000 6/7/8/9/A (Non ABS Model) CBF 1000 A6-A9/AA (ABS Model) CBF 1000 S (S7/S8/S9/SA) CBF 1000 T (T7/T8/T9/TA) GT CBF 1000 FA (FAA) CBF 1000 FS (FSA) CBF 1000 FT (FTA)	04-07 ■ 09-15 ■ 09-16 ■ 06-11 ■ 06-10 ■ 07-11 ■ 07-16 ■ 10-15 ■ 10-11 ■ 10-11 ■
CK1287	CBR 750 FH/FJ (Superaero)	87-88	CK1304 ■=CT012SP	CRF 150 F3/F4/F5 CRF 230 F4/F5/F6/F7/F8/F9	03-05 ■ 04-09 ■
CK1288 Dry Clutch ■=CT071SP	NSR 250 R2R/R3R/R2T/R3T NSR 250 R6K/R6K-2 NSR 250 R8L-3/R9L/R8N/R8N-3 NSR 250 R9N RGV 250 T (RGVR 250 SP)	94 ▲ 89 ▲ 90-92 ▲ 92 ▲ 96 ▲	CK1305 CKF1305 ▲=CT001	CRF 250 X4/X5/X6/X7/X8/X9/XB/XC/XD/XF/XG/XH CRF 250 XRL (Road Legal) CRF 250 R8-R9 CRF 250 RB/RC/RD/RE/RF/RG/RH CRF 250 RE (Limited Road Use) CRF 250 RX MD 250 H MD 250 S	04-17 ▲ 14-16 08-09 ▲ 11-20 ▲ 16 ▲ 18-20 ▲ 08-11 ▲ 08-11 ▲
CK1289 ▲=CT002	RVF 400 RR/RR-II/RT/RT-II (NC35) -100/110	94-96 ▲			
CK1290 ▲=CT009	VTR 1000 FV/FW/FX/FY/F1/F2/F3 /F4/F5/F6 'Firestorm' XL 1000 VX/VY/V1/V2 Varadero - Non ABS Model CB 1300 DCV/DCW/DCX/DCY SC38	97-06 ▲ 99-02 ▲ 97-00 ▲			

Part No.	Make/Model	Year	Part No.	Make/Model	Year
CK1307	HONDA ANF 125 3/5/T5/6/T6/7/A Innova	03-11	CK2208 ▲=CT039	YAMAHA RS 100 AG 100 E 'Farm Bike' AG 100 J (3HAA)	75-76 ▲ 93 ▲ 82 ▲
CK1308 ▲=CT009	ELSTARS (Pit bikes) Various models		CK2209 ▲=CT039	DT 125 DT 175 RD 200 DX RS 200	74 ▲ 74-75 ▲ 76-81 ▲ 79-80 ▲
CK1312 CKF1312 ▲=CT043SP	CBR 1000 RR8/RR9/RA9/RRA/RAA /RAB/RRB/RRC/RAC/RRD/RAD/RAE /RRF/RRG/RAF/RAG Fireblade VFR 1200 FA (Manual Gearbox Model) CBR 1000 RR-SP ABS Fireblade (CBR1000 SAE/SAF/SAG) CBR 1000 RR-SP ABS-TT Edition	08-16 ▲ 10-15 ▲ 14-16 ▲ 16 ▲	CK2223	DT 250 MX	77-80
CK1313 CKF1313	CBR 250 RB/RC (Non ABS) CBR 250 RAB/RAC (ABS)	11-13 11-13	CK2226 ▲=CT017 ■=CT074	XS 650 YZF R1	75-79 ■ 98 ▲
CK1314 CKF1314 ■=CT081SP	CRF 250 LD/LF CRF 250 ME Supermoto CRF 250 RL/RLA Rally (non ABS & ABS models) CB 300 FAF/FAG (ABS) CBF 300 NA CBR 300 RA ABS	13-20 ▲ 14-15 ▲ 17-20 ▲ 15 ▲ 18-20 ▲ 14-19 ▲	CK2230 ▲=CT076SP	XS 1100 /1100 S	78-81 ▲
CK1315 ■=CT084SP	Monkey 125 MSX 125 Grom MSX 125 A Grom ABS	19-20 ▲ 13-20 ▲ 17-20 ▲	CK2234 ▲=CT039	YZ 100 E/F/G/H/K IT 125 G/H/J TW 125 (5rs) (5 friction plate type) TY 125 YZ 125 C YZ 125 F/G TY 175 TW 200 (2JL/4CS1/2/3/5) TW 200 E (4CS4/6/5LB1/2) TW 225 E (5VC1/2)	78-83 ▲ 80-82 ▲ 03-04 ▲ 80-82 ▲ 76 ▲ 79-80 ▲ 77-80 ▲ 91-98 ▲ 98-01 ▲ 02-03 ▲
CK1317 CKF1317 ▲=CT092	CRF 450 R (6 Spring) CRF 450 RXH (18" Rear Wheel) CRF 450 X	17-20 ▲ 17-20 ▲ 18-20 ▲	CK2235 ▲=CT039	YZ 125 D/E YZ 125 H IT 175 G-J IT 200 L	77-78 ▲ 81 ▲ 80-82 ▲ 84 ▲
CK1318 ▲=CT091	AJP PR5 250 Trials PR5 250 Supermoto PR5 250 Enduro PR5 250 Extreme	13-17 ▲ 13-17 ▲ 13-17 ▲ 13-17 ▲	CK2236 ▲=CT039	DT 100 AS3 125 125 DT 125/125F/125E/125 MX RD 125 RD 125 DX RS 125/125 DX DT 175	76-80 ▲ 71-72 ▲ 76-81 ▲ 71-72 ▲ 75-76 ▲ 75-76 ▲ 76-77 ▲
CK1319 CKF1319 ▲=CT009	CRF 1000 LAG (Manual Clutch/ABS) CRF 1000 L (Manual Clutch/Non ABS)	16-20 ▲ 16 ▲	CK2238 ▲=CT044	RZ 50 (5FC1/2) DT 80 LC1 RD 80 LC YZ 80 G DT 80 MX (Type 36N) DT 80 MXS YZ 80 D	02 ▲ 81-84 ▲ 82 ▲ 80 ▲ 83-85 ▲ 84 ▲ 77 ▲
CK1323	CB 500 F (Non ABS) CB 500 FA (ABS) CB 500 X (Non ABS) CB 500 XA (ABS) CBR 500 R (Non ABS) CBR 500 RA (ABS)	13-18 13-18 13-18 13-18 13-18 13-18	CK2240 ▲=CT008	DT 250 RD 250/A/B RD 250 C/D/E/F RD 250 LC RZ 250 R (1AR/1XG) RZ 250 R (29L) RZ 250 RR (51L) RZ 250 (4L3) TY 250 D/E YDS7 250cc R5/5A/5B 350cc RD 350/A/B RD 350 LC/YPVS RD 350 N/F/F2/R TT 350 (ITJ) TT 350 A (3GJ) XT 350 YFM 350 FX 'Wolverine' All models DT 400 RD 400 C-F	75-76 ▲ 73-75 ▲ 76-79 ▲ 80-82 ▲ ▲ ▲ ▲ ▲ 77-78 ▲ 72 ▲ 70-72 ▲ 73-75 ▲ 80-84 ▲ 85-95 ▲ 85-89 ▲ 90-95 ▲ 85-95 ▲ 95-03 ▲ 75-76 ▲ 76-79 ▲
CK1325 CRF 125 F CRF 125 FB	HONDA 14-21 14-21		CK2242 ▲=CT074	XS 650 XS 650 SE	80-81 ▲ 79-81 ▲
CK1332	CB 1100 EX	16-19	CK2244 ▲=CT008	YZ 250 G YZ 250 D/E	80 ▲ 77-78 ▲
CK1333	CB 500 F (Non ABS) CB 500 FA (ABS) CB 500 X (Non ABS) CB 500 XA (ABS) CBR 500 R (Non ABS) CBR 500 RA (ABS)	13-18 13-18 13-18 13-18 13-18 13-18			
CK2205 ▲=CT044	YAMAHA DT 50 M/MX FS1E/FS1DX/FS1/FS1SE RD 50/M/MX TY 50M (2K0)	80-95 ▲ 74-90 ▲ 80-87 ▲ 80 ▲			
CK2206 ▲=CT044	DT 50 M DT 50 MX Type 5J2/12Y DT 50 LC RD 50 M TY 50/TY 50 M (1F4/1G7) YZ 50 G-K TY 80 RD 80	78-79 ▲ 81-83 ▲ 98 ▲ 78-79 ▲ 77-78 ▲ 80-83 ▲ 77-83 ▲ 82 ▲			
CK2207 ▲=CT044	YB 100	78-92 ▲			

Part No.	Make/Model	Year	Part No.	Make/Model	Year
CK2245 ▲=CT039	YAMAHA DT 175 MX	78-81 ▲	CK2261 ▲=CT008	SR 250 (4GR1/2/3/4) (5 plate clutch) SR 250 Classic (2IL) (5 plate clutch) SRX 250	94-96 ▲ 96-00 ▲ ▲
CK2250 ▲=CT008	XVS125 Dragstar (5XJ3/5XJ5/5XJ7) IT 250 G XS 250 SE/C YZ 250 F XVS 250 Dragstar	01-04 ▲ 80 ▲ 80-81 ▲ 79 ▲ 01-03 ▲	CK2262 ▲=CT017	YAMAHA XS 400	82 ▲
CK2254 CKF2254 ▲=CT044	DT 80 LC2 YZ 80 E/F RS 100/RS 100 'S' RS 100 (IY8 Europe) RS 100 (IY8 Europe) RS 100 S (IY8 UK) RS 100/RS 100 DX RS 100 DX (IY8 Europe) RS 100 (IY9 UK) RS 100 RT 100 E/F/K RXS 100 RX 115 (5FS3) RD 125 DX RS 125 TT-R 125 (Large Wheel) XT 125 R (3D61/3D63) (5 friction plate clutch) XT 125 R (13D1) (5 friction plate clutch) XT 125 X (3D62/3D64) (5 friction plate clutch) XT 125 X (13D2) (5 friction plate clutch) XTZ 125 K/K XYZ 125 (5RM) YBR 125 E/K ED	85-97 ▲ 78-79 ▲ 77-78 ▲ 77-78 ▲ 80-82 ▲ 77-78 ▲ 79 ▲ 79 ▲ 79-81 ▲ 80-81 ▲ 93-03 ▲ 83-97 ▲ 99 ▲ 78-81 ▲ 77-81 ▲ 00-20 ▲ 05-06 ▲ 07 ▲ 05-06 ▲ 07 ▲ 05-10 ▲ 03-10 ▲ 00-08 ▲	CK2267 ▲=CT008	SR 250 (3Y8) US Custom (6 plate clutch) SR 250 SE Special (3Y8) (6 plate clutch) XT 250	80-81 ▲ 81-83 ▲ 80 ▲
			CK2273 ■=CT008SP	XS 850	80 ■
			CK2274 CKF2274 ▲=CT020	WR 250 ZF/ZG/ZH/ZJ/EK YZ 250 (2T) WR 450 FT/FV/FW/FX/FY/FZ/FA/ /FB/FD/FE/FF (4T) WR 450 F (270mm F/Disc/4T) YZ 450 FW/FX/FY/FZ/FA/FB/FD/FE/FF (4T) YZ 450 FG (270mm Disc) YZ 450 FG (60th Anniversary Edition/270mm Disc) YZF 450 RSEA/RSEB/RSED/RSE XV 750 SE XV 750 Virago XV 1000/TR1 BT 1100 P/R/S/T/V "Bulldog" XV 1100 Virago XVS 1100 A Dragstar Classic XVS 1100 Dragstar	94-98 ▲ 93-20 ▲ 05-15 ▲ 16-20 ▲ 07-15 ▲ 16-20 ▲ 16-20 ▲ 11-14 ▲ 81 ▲ 92-97 ▲ 81-86 ▲ 02-06 ▲ 89-00 ▲ 00-07 ▲ 99-03 ▲
			CK2276	YZ 125 J	82
			CK2278 ▲=CT054SP	YZ 125 K-T	83-87 ▲
CK2255 CKF2255 ■=CT008SP	FZ 400 N (1FK 46X 33M) XJR 400 XS 500 B/C/D FZ 600 FZ6 Fazer FZ6 Naked Version FZ6 Naked/Non ABS 2 piston caliper (IB3/IB3D) FZ6 S2 ABS (Naked) FZ6 Fazer S2 (ABS) FZ6-NS Naked/Non ABS /2 Piston Caliper (IB35/6) FZ6-Fazer (Half Fairing/Non ABS /2 Piston Caliper) (5VX/5VXL) FZ6-Fazer (ABS/Half Fairing /2 Piston Caliper) FZ6 Fazer S2 (ABS/Half Fairing /4 Piston Caliper) (5S2) FZ6 Fazer S2 (Non ABS/Half Fairing/4 Piston Caliper) (4S81/4S8) FZ6 S2 (Naked/Non ABS /4 Piston Caliper) (SS51/SSS) XJ 600 XJ 650 XJ 650 Turbo XJ 600 S/N Diversion YX 600 S/SC/T/TC/UC/UW/WC/A/AC 'Radian' YZF R6 XJ 650 G/H/J/K 'Maxim' XJ 650 LH 'Midnight' XJ 650 RJ/LK Seca FZX 700 S/SC/T/TC 'Fazer' FZ 750 XJ 750 XJ 750 RF/RJ/RK 'Seca' XTZ 750 TDM 850 XJ 900/900 F XJ 900 S Diversion	85- 93-99 ■ 78-79 ■ 87-88 ■ 04-07 ■ 04-07 ■ 04-07 ■ 07-08 ■ 07-08 ■ 05-06 ■ 04-07 ■ 06-07 ■ 08 ■ 07-09 ■ 07-09 ■ 84-92 ■ 80-84 ■ 82 ■ 92-03 ■ 86-90 ■ 99-05 ■ 80-83 ■ 81 ■ 82-83 ■ 86-87 ■ 85-86 ■ 82-83 ■ 81-83 ■ 89-95 ■ 91-95 ■ 83-92 ■ 95-03 ■	CK2279 CKF2279 ▲=CT008 ■=CT008SP	IT 250 H/J YZ 250 H XS 250 C/D/E YFZ 350 T/U/W/A/B/D/E/F/G/H/J/ K/L/M/N/P/R/S/T/V XS 400 XS 400 SE YZ 400 D-F IT 425 G IT 465 H/J YZ 465 G/H XS 750 XS 750 SE	81-82 ▲ 81 ▲ 78-80 ▲ 87-06 ▲ 78-79 ▲ 80 ▲ 77-79 ▲ 80 ▲ 81-82 ▲ 80-81 ▲ 77-79 ■ 79-80 ■
			CK2280 ▲=CT060	IT 250 L YZ 250 J-T YTZ 250 N/S IT 490 L YZ 490 J-U WR 500 ZD	84 ▲ 82-87 ▲ 85-86 ▲ 84 ▲ 82-88 ▲ 92-93 ▲
			CK2281	DT 125 LC (Type 10V/12W/26G)	82-83
			CK2283 ▲=CT044	DT 125 LC (Type 35A) DT 125 (3TT4) RD 125 LC Mk1 - 3 RZ 125 (1GV 030101-) RX 135 (13X)	85-87 ▲ 96 ▲ 82-87 ▲ 85 ▲ 81 ▲
CK2256 ▲=CT039SP	SR 125 SE SR 125 XT 125 (5EK) (4 friction plates) TW 125	81-83 ▲ 89-03 ▲ 99-02 ▲ 82-83 ▲	CK2285 ▲=CT017	YAMAHA FJ 1100 XJR 1200 FJ 1200/1200 A XJR 1300 L 5EA2/5EA3/5EA4 XJR 1300 M 5EAA/5EAB/5EAC XJR 1300 (5EA1/5EA7) XJR 1300 (5EA9/5EAG) XJR 1300 N/P (5EAP/5EAR/5EAS /5EAT/5EAW/5EAV/5EAY) XJR 1300 R/S 5WM1/5WM3 /5WM5/5WM6/5WM7/5WM9	84-85 ▲ 95-98 ▲ 86-95 ▲ 99 ▲ 00 ▲ 98-99 ▲ 00 ▲ 01-02 ▲ 03-04 ▲

Part No.	Make/Model	Year	Part No.	Make/Model	Year
CK2285 ▲=CT017 Contd.	XJR 1300 T/V/W/X 5WMA/5WMC	05-14 ▲	CK2300 ▲=CT050SP	XVZ 12 TD	85 ▲
	/5WMD/5WMF	15-16 ▲		V-Max All models	91-03 ▲
	XJR 1300 C / Racer	99 ▲	CK2302	XVZ 13 Royal Star All models	96-01 ▲
	XJR 1300 SP (L) 5EA5/5EA6/5EA8	00 ▲		T 50	86
	XJR 1300 SP (M) 5EAD/5EAE/5EAF	01 ▲		CK2303	V 50 M/P
XJR 1300 SP (N) 5EAL/5EAM/5EAN		YFM 50 S/T/RV/RW/RX Raptor	04-08		
CK2287 ▲=CT010 ■=CT010SP	YZ 80 H/J/K/L/N	81-85 ▲	YFM 80 D/E/F/G/H/J/K/L/M/N Badger		91-01
YTM 225 DRN	85 ■	YFM 80 WP/WR/WS/WT/RV/RW/RX Raptor	02-08		
YFM 200 DKW/DX/DXA	86-90 ■	YFM 80 GT/GV/GW/GX Grizzly	05-08		
YFM 225 N/S/T/U	85-89 ■	T 80	83-97		
YFB 250 D/E/F/G/H/J/K/FWF/FWG/ FWH/FWJ/FWK/FWL/FWM	92-00 ■	PW 80 All models	83-05		
YFM 250 W/A/B	90-92 ■	V 80	79-85		
YFM 250 XN/XP/XR "Bear Tracker"	99-03 ■	CK2304 ▲=CT010	YZ 80 S/T/U/W/E/LC/LW/F	86-94 ▲	
YFM 250 FN	01 ■		YZ 65 J	19-20 ▲	
YFM 250 BT/BV (Bruin)	05-06 ■		TZR 125 (2RK/3PC1/2/3)	87-92 ▲	
YFM 250 BW/BX/BY Big Bear	07-10 ■	YTM 200 EL/DX	89 ▲		
YFUIWT	89-90 ■	CK2305 ▲=CT017	RD 500 LC	84-86 ▲	
YFUIW/TW Pro Hauler Pro 4 (230cc)	89 ■		RZV 500 R (Six)	85 ▲	
CK2290 CKF2290 ▲=CT008 ■=CT090SP	YFM 350 FWT/FWU/FWW/FWA/ FWE Big Bear	86-93 ■	CK2306 CKF2306 ■=CT008SP	XJ6-N (600cc) (Naked - 20S) Non ABS/ABS	09-15 ■
	YFM 350 FWF/FWG/FWH/FWJ	94-97 ■		XJ6-S Diversion (600cc) (Top Fairing - 36C) ABS and Non ABS Version	09-15 ■
	YFM 350 ERD/ERE/ERF/ERG	92-95 ■	XJ6 SP	13 ■	
	YFM 350 XD/XE/XF/XG/XH/XJ/XK /XL/XM/XN/XP/XR	92-03 ■	XJ6-F Diversion (600cc) (Full Fairing - 1CW1) (Non ABS/ABS)	10-15 ■	
	YFM 350 S/T/V/R-WV/RW/RX/RY/RZ Raptor	04-10 ■	FZ 750	87-92 ■	
	YFM 350 UH/UJ	96-97 ■	FZX 750	87 ■	
	DT 400 MX	77-79 ▲	CK2308 ■=CT008SP	FZR 750	87 ■
	YFM 400 FWE/FWF/FWG/FWH /FWJ/FWK/FWL/FWM Kodiak	93-00 ■		FZR 1000	87-88 ■
	YFM 400 FPR	03 ■	CK2309 ▲=CT020	WR 250 ZB/ZD/ZE	91-93 ▲
	CK2292 ▲=CT039 ■=CT061	WR 125 R		09-15 ■	YZ 250 U/W/A/B/D
WR 125 X (Supermoto)		09-16 ■		YZ 250 WRW/WRA	89-90 ▲
CK2295 ▲=CT060	YZF-R 125	08-13 ■		XVS 650 Dragstar	97-03 ▲
	AG 200 E (3GX6)	93 ▲		XVS 650 A Dragstar Classic	98-07 ▲
	CK2296 ▲=CT008	SR 400 (3HT1)	88 ▲	MT-07 (Non ABS/689cc / 2 Cyl)	14-20 ▲
SR 400 (2RD)		14-16 ▲	MT-07A (ABS/689cc / 2 Cyl)	14-20 ▲	
SR 500		78-82 ▲	MT-07 Motocage ABS (689cc/2 Cyl)	15 ▲	
SR 500 S (3GWS)		98 ▲	XSR 700 ABS (MTM 690-U)	16 ▲	
ST 500 (3GW1/3/4/6/7)		96-98 ▲	CK2310 ▲=CT008	YZ 400 FK/FL	98-99 ▲
TT 500 G/H		80-81 ▲		WR 400 FK/FL/FM	98-00 ▲
XT 500		77-81 ▲	XT 550	82 ▲	
CK2297 CKF2297 ▲=CT008	SRX 400 (1JL)	▲	CK2311 ▲=CT054SP	YZ 125 W/A	89-90 ▲
	SRX 400 (3VN1/3VN2/3VN5)	90-96 ▲		CK2312 ▲=CT054SP	YZ 125 U
	XT 550	83 ▲	CK2313 CKF2313 ▲=CT010		DT 125 R
	SRX 600	86-87 ▲		DT 125 X	05-06 ▲
	SRX 600 (1JK/3SX)	85-91 ▲		DT 125 RE	04-07 ▲
	TT 600 L (Kick Start Only)	84 ▲		TDR 125 (3HS1/3XD0/3HS3/3XD1)	89-93 ▲
	TT 600 N (59X) Frame # 59X			TDR 125 (4GH/GW1/2/3/4)	93-03 ▲
	000101-59X 007852 (Kick Start Only)	85-88 ▲		TDR 125 R Lightburner (3SH2/3XE2)	93-94 ▲
	TT 600 W (2JT/3SW1) Frame #			TZR 125 RR (4DL3)	94-95 ▲
	59X 007853- (Kick Start Only)	89-92 ▲		TZR 125 (3JB/4JB/HHW/4HX)	93-95 ▲
	TT 600 K (Kick Start Only)	93-01 ▲		YAMAHA	
	TT 600 E (Electric Start)	94-95 ▲		TZR 150 R (4AP20)	00 ▲
	TT 600 R (5CH1) (Kick Start Only)	97 ▲	DT 200 (2LR)	87 ▲	
	TT 600 R (5CH2) (Kick Start Only)	98-99 ▲	DT 200 WR 3XP	92-93 ▲	
	TT 600 R (5CH3/4) (Kick Start Only)	00-02 ▲	SDR 200	▲	
	TT 600 RE (5CH5) (Electric Start)	04 ▲	YFS 200 B/F/G/H/J/K/L/M/N/P /R/S/T/V 'Blaster'	91-06 ▲	
	YAMAHA		WR 200 D/E/F	92-94 ▲	
	XT 600 (Kick Start Only)	84-87 ▲	DT 230 (4TP1/2) Lanza	97-98 ▲	
	XT 600 Z/E (Kick Start Only)	84-03 ▲	CK2315 ▲=CT010	FZR 400 RSP (2TK-EXUP)	87 ▲
	XT 600 Z (Kick & Electric Start)	86-90 ▲		FZR 400 RRSP (3TJ2/6/7)	▲
	XT 600 E (Electric Start Only)	90-03 ▲	FZR 600	89-93 ▲	
SZR 660	96-97 ▲	CK2316 ▲=CT008	XV 125 Virago	97-02 ▲	
YFM 660 RN/RP/RR/RS/RT Raptor	01-05 ▲		XVS 125 Drag Star (5XJ1)	00 ▲	
XTZ 660 "Tenere"	91-97 ▲				
DERBI					
Mulhacen 659	06-07 ▲				
CK2299 ▲=CT020	XVS 400	96 ▲			
	XV 535/535 S "Virago"	88-03 ▲			

Part No.	Make/Model	Year	Part No.	Make/Model	Year
CK2316 ▲=CT008 Contd	XVS 125 Drag Star (5XJ3/5XJ5/5XJ7) SRV 250 'Soulful Twin/Renaissa' XV 250 Virago XV 250 S "Virago"	01-04 ▲ 96-97 ▲ 89-94 ▲ 95-00 ▲	CK2348 4 plate kit Contd.	RS 50 RX 3-5 Marce RX 50 All models Tuono 50	93-05 91-94 03-04 03-04
CK2317 ▲=CT010	FZR 400 RR FZR 400 Genesis (1WG) FZR 400 (3EN1/3EN2) FZR 400 RR (3TJ1)	92 ▲ 86 ▲ 88-89 ▲ ▲	CK2349 5 plate kit	TZR 50 (5 plate kit)	97-03
CK2318 CKF2318 ■=CT008SP	YZF R6 FZR 750 R OW01 YZF 750 R/SP TDM 850 TRX 850 TDM 900 Non ABS/5PS TDM 900 A (2B0 ABS)	06-18 ■ 89-90 ■ 93-97 ■ 96-08 ■ 96-98 ■ 02-14 ■ 05-13 ■	CK2350 ▲=CT017	YZF R1	99-03 ▲
CK2319 ▲=CT005 ■=CT025	YZ 125 B/D TDR 250 (3CK1/3CK2 Europe) TT 250 RM (4PX6) TY 250 Z TZR 250 (2MA/2XW1/2XW2 Europe) TZR 250 (1KT/2AW Japan) TZR 250 (2XT1 Japan) TZR 250 R (3XV1/3X4/3XV6) R1-Z (250cc/3XC) WR 250 XX/XY WR 250 R	91-92 ▲ 88-92 ■ 00 ▲ 93-96 ▲ 87-92 ■ 87 ■ 88 ■ 91-93 ▲ 90-92 ▲ 08-15 ▲ 08-20 ▲	CK2351 ▲=CT050SP	XV 1600 A	99-03 ▲
CK2321 ■=CT008SP	FZR 1000	89-92 ■	CK2352 CKF2352 ▲=CT020	YZ 426 FM WR 450 FS YZ 450 FR/FS/FT/FV MT-09 (1RC/Non ABS/847cc/3 Cyl Engine) MT-09 Tracer ABS (847cc/3 Cyl Engine) MT-09A (2DR/ABS/847cc/3 Cyl Engine) MT-09A Sport Tracker ABS (847cc/3 Cyl Engine) MT-09A Street Rally ABS (847cc/3 Cyl Engine) YZF-R1	00 ▲ 04 ▲ 03-06 ▲ 14-16 ▲ 15-20 ▲ 14-20 ▲ 14-20 ▲ 14-20 ▲ 09-14 ▲
CK2324 ▲=CT039	XT 225 (3RW4) Serrow (1KH 080101-) XT 225 (3RW1/2/4/5) Serrow (1KH-) XT 225 S (3RW3) (1KH- 202101-109000) XT 225 W (4JG1/2/3/4) Serrow XT 225 WE (4JG5/6) Serrow XT 225 (4WW1/3/5/7/9) (4VWA/B/D/G/J/L) (Brasil) ST 225 (5BT) Bronco	92 ▲ 89-93 ▲ 92 ▲ 93-96 ▲ 97-98 ▲ 97-06 ▲ 97 ▲	CK2353 ▲=CT020	YZF R7	99-00 ▲
CK2325 CKF2325 ▲=CT005	YZ 125 E/F/G/H/J/K/L/M/N/P/R /S/T/N/W/X/Y/Z/A/B/D/E/F/G	93-16	CK2354	TT-R 90 M/N/P/R/ES/S/ET/T/EV/EW T 90 N/D (4NM1-9) Mate T 105/105 E Crypton V 110 ZE/ZK/ZHE/ZHK FIZR/FIZR Sporty T 105 E (5ER1/2) Crypton-R	00-07 00- 96 96 99
CK2327 ■=CT008SP	GTS 1000 FZR 1000 YZF 1000 Thunder Ace	93-96 ■ 93-95 ■ 96-02 ■	CK2355 CKF2355 ▲=CT005 ■=CT020	YZ 250 FN/FP/FR/FT/FV/FW /FX/FY/FZ/FA/FB/FD/FE/FF (4T) WR 250 FN/FP/FR/FT/FV/FW /FX/FY/FZ/FA/FB/FD WR 250 FF/FG (4T/Reverse Cylinder) YZ 250 FG (270mm Disc) YZ 250 FGY (60th Anniversary Edition/270mm Disc)	01-15 ▲ 01-13 ▲ 15-16 ▲ 16-18 ■ 16 ■
CK2331 ▲=CT010	FZR 250 FZR 250 R FZX 250 Zeal (3YX1/2/4)	87 ▲ 91-92 ▲	CK2356 CKF2356 ▲=CT020	YZ 426 FN/FP WR 426 FN/FP WR 450 FR YZF R1 YZF R1SP FZ1 Naked (2D11) FZ1 Fazer (3C3) Non ABS Half Fairing FZ1 Fazer (Half fairing - ABS - 5D0) FZ1 N/NA Naked (Non ABS/ABS)	01-02 ▲ 01-02 ▲ 03- ▲ 04-08 ▲ 06 ▲ 06-09 ▲ 06-15 ▲ 08-15 ▲ 10-15 ▲
CK2332 CKF2332 ▲=CT054SP	FZR 600 R YZF 600 Thunder Cat	94-95 ▲ 96-03 ▲	CK2358 ■=CT008SP	FZS 1000 Fazer YZF-R6	01-05 ■ 18-20 ■
CK2334 ▲=CT008	XT 500 C	76 ▲	CK2361 CKF2361	YAMAHA YZ 250 F (4T)	16-21 ■
CK2335 CKF2335 ▲=CT010	YAMAHA YZ 80 G/H/J/K/L/M/N YZ 85 (2T / Small Wheel F 17" / R 14") YZ 85 (2T / Big Wheel F 19" / R 16")	95-01 ▲ 02-20 ▲ 02-20 ▲	CK2362 ▲=CT017	XTZ 1200 Super Tenere (ABS/UBS Brake System) XT 1200 ZE Super Tenere (ABS/UBS Brake System) FJR 1300 A (ABS) (Manual G/Shift) FJR 1300 AS (ABS/Electric Shift) FJR 1300 AE (Electronic Suspension Adjustment/USD Forks) FJR 1300 (Non ABS) XVS 1300 A Midnight Star XVS 1300 CU Custom	10-16 ▲ 14-16 ▲ 03-15 ▲ 06-15 ▲ 14-15 ▲ 01-04 ▲ 07-16 ▲ 14-16 ▲
CK2342 ▲=CT008	TZR 250 (3MA1 Reverse Cylinders) TZR 250 (3MA3/3MA5 Reverse Cylinders)	87 ▲ 90 ▲	CK2363 ▲=CT050SP	XV 1700 PCR	03-05 ▲
CK2347 ▲=CT054SP	FZS 600 Fazer	98-03 ▲	CK2364 CKF2364 ▲=CT020	YZF 450 S/T/N/W/X YZF 450 RY/RZ (Quad) YZF 450 B/D YFM 700 RV/RW/RD/RE YFM 700 RSE	04-08 ▲ 09-10 ▲ 13-14 ▲ 06-14 ▲ 13-14 ▲
CK2348 4 plate kit	DT 50 R DT 50 X Supermotard TZR 50 (4 plate kit) APRILIA AF1 Futura 50 Classic 50 Europa 50 MX 50 Pegaso 50	97-08 04-08 04-15 90-92 92-01 90-92 03-05 92-94			

Part No.	Make/Model	Year	Part No.	Make/Model	Year
CK2364 CKF2364 ▲=CT020 Contd.	FZ8 N-800cc (Naked/Single Headlight/Non ABS) FZ8 NA-800cc (Naked/Single Headlight/ABS) Fazer 8 S-800cc (Top Fairing/Twin Headlight/Non ABS) Fazer 8 SA-800cc (Top Fairing/Twin Headlight/ABS)	11-15 ▲ 11-15 ▲ 11-15 ▲ 11-15 ▲	CK3311 ▲=CT051	AP 50	-78 ▲
CK2365 ▲=CT044	DT 175 (3TS4)	96 ▲	CK3312 ▲=CT051	A 100 L/M/N	74-80 ▲
CK2366 ▲=CT017	MT-01 (1670cc) MT-01S (5YUR)	05-10 ▲ 09 ▲	CK3313 ▲=CT046	GT 250 K/L T 250 I/R/J T 350 1/2/R/J	73-74 ▲ 70-72 ▲ 69-72 ▲
CK2368 ▲=CT020	XT 660 R Model Code 5VK1/3/4/6/8/3S62/3S63 XT 660 X (Model Code - ID21/ID23 /ID24/ID26/3S72/10S1/11B1/10S7) XT 660 R (Model Code 5VKE) XT 660 R (5VKA/5VKC) XT 660 Z Tenere (Non ABS) XT 660 ZA Tenere (ABS) MT 03 APRILIA 650 Pegaso Trail	04-07 ▲ 04-16 ▲ 10-16 ▲ 08-09 ▲ 08-16 ▲ 11-16 ▲ 06-12 ▲ 05-06 ▲	CK3314 ▲=CT046	T 500 1/2/3 (18 ears)	68-70 ▲
CK2370 CKF2370 ▲=CT005	XT 250 Serrow (3C51/2) TT 250 R (4GY1 Japan) TT 250 R (4RR1/2 Japan) TT 250 R (4MR2 UK) TT 250 RL (4PX5) TT 250 R (4GY3/4GY5/4WA1) Raid XG 250 Tricker (5XT1) XT 250 X (5C1) YFM 250 RX/RV Raptor YFM 250 R (338) YFM 250 R (IBT)	05-08 ▲ 93-94 ▲ 95-97 ▲ 96 ▲ 99 ▲ 94-96 ▲ 04-06 ▲ 06-08 ▲ 08-09 ▲ 09-11 ▲ 12-13 ▲	CK3315 ▲=CT022	TS 250 K-M/A-C TS 250 ERN/ERT/ERX GT 250 M/A/B/C RL 250 L/M GT 380 K-M/A/B RM 400 C GT 250 X7 EN/ET/EX	73-78 ▲ 79-81 ▲ 75-78 ▲ 74-75 ▲ 73-77 ▲ 78 ▲ 79-81 ▲
CK2371 ▲=CT010	FZ 400 (4YR1)	96 ▲	CK3316 ▲=CT022	GT 500 A/B T 500 R/J/K/L/M (12 ears)	76-77 ▲ 71-75 ▲
CK2375	TT-R 110 E	08-20	CK3318 CKF3318 ▲=CT011	RM 80 B/C/N/XT/XX RM 80 XE/XF/HF RM 80 K/L/M/N/P/R/S/T/V/W/X/Y/K1 RM 85 K2/LK2/K3/LK3/K4/LK4 RM 85 (Small Wheel F 17"/ R 14") RM 85 (Big Wheel F 19"/ R16") TS 100 C TS 100 ERN (Up to E/No 300563) TS 100 ERZ/ERH DF 125 DR 125 SZ/SD/SE/SF/SH/SJ DR-Z 125 DR-Z 125 L FX 125 GN 125 Z/D/K GN 125 Z/M/R/N/W/X/Y/K1 GN 125 ER/EV/EW/EX/EY/EK1 GN 125 HS GS 125 Z/D/ESZ/ESD/ESF/ESK/ ESM/ESR/ESX GSX-R 125 GSX-S 125 GT 125 L/M/A/B/C/EC GZ 125 W/X/Y/K1-K9 RV 125 K2-K9/L0/L3/L4 (Van-Van) TF 125 Farm Bike (All models) TS 125 ERZ TS 125 K/L/M/A/B/C/C2 TS 125 ERN (Up to E/No.-: 302345) TS 125 N (Up to F/No 178871) DR 125 SEX/SEY GSX 150 L6/DZAL6 Gixxer GSX 150 DEAL8/DZAL8/DXAL8 Gixxer GSX-R 150 FRFAL7/FRZAL7 GSX-R 150 RF-Q/RFX-Q GSX-R 150 GSX-S 150 KLX 125 A1/A2/A3/A6F KLX 125 L (B1/B2/B3/B6F) SACHS XTC 125 X Road 125	78-81 ▲ 84-85 ▲ 89-01 ▲ 02-04 ▲ 05-20 ▲ 05-20 ▲ 78 ▲ ▲ 79 ▲ 82 ▲ ▲ 82-94 ▲ 03-20 ▲ 03-20 ▲ ▲ 82-90 ▲ 94-01 ▲ 94-01 ▲ 00-11 ▲ 82-00 ▲ 18-20 ▲ 18-20 ▲ 74-78 ▲ 98-11 ▲ 02-15 ▲ 78-05 ▲ 82 ▲ 73-78 ▲ ▲ 79 ▲ 84 ▲ 99-01 ▲ 16 ▲ 18 ▲ 17-18 ▲ 17-18 ▲ 18-20 ▲ 18-20 ▲ 03-06 ▲ 03-06 ▲ 00-07 ▲ 06-07 ▲
CK2377 ▲=CT017	XVS 950 A Midnight Star XV 950 - XVS 950 (Non ABS/Standard Rear Shocks) XV 950 CU - XVS 950 (1XC1/ABS/Standard Rear Shocks) XV 950 R - XVS 950 R (2DE/Remote Reservoir Rear Shocks) XV 950 Racer (Remote Reservoir Rear Shocks)	09-13 ▲ 14 ▲ 14-15 ▲ 14-15 ▲ 15-16 ▲	CK3319 ▲=CT011	GP 100 N/UN GP 100 C/UC RM 100 A RM 100 N/T/X GP 125 C/N RG 125 CG/CH/J Gamma RG 125 UCG/UH/UJ/UAJ/BUJ Gamma RG 125 FN/FP/FR Gamma RG 125 FUN/FUP/FUR Gamma RG 125 UN Wolf Naked RM 125 N/T	79 ▲ 78 ▲ 76 ▲ 79-81 ▲ 78-79 ▲ 86-90 ▲ 86-90 ▲ 92-94 ▲ 92-94 ▲ 92-94 ▲ 92-94 ▲ 79-80 ▲
CK2378	XP 500 (T-Max Scooter - All models)	01-11			
CK2380 ▲=CT017	YAMAHA XV 1700 V-Max	09-16 ▲			
CK2382	T Max 530 ABS T Max 530 DX ABS T Max 530 SX ABS T Max 530 Black Max ABS T Max 530 Bronze Max ABS T Max 530 Iron Max ABS	12-19 17-19 17-19 13 14 15			
CK2387 CKF2387	YZ 250 F	19-21			
CK2388	XSR 900 ABS	18-20			
CK2389	YAMAHA YFZ 450 R	14-21			
CK3306 ▲=CT052	SUZUKI B 120 T 125/T 125 -11/R 'Stinger'	▲ 69-71 ▲			
CK3310 ▲=CT038SP	T 20 Super Six	66-68 ▲			

Part No.	Make/Model	Year	Part No.	Make/Model	Year				
CK3319 ▲=CT011 Contd.	RM 125 G/H	86-87 ▲	CK3333 ▲=CT022 Contd.	GS 500 EK/EL/EM/EN/EP/ER/ES/ET /EV/EW/EX/EY/K1/K2/K3/K4/FK4 /FK5/K5/FK6/K6/FK7/K7/K8/FK8 APRILIA	89-08 ▲				
	TS 125 X (all models)	84-90 ▲		RS 250	95-02 ▲				
	TS 125 RK/RL/RM/RN/RR	90-94 ▲		CK3334 ▲=CT022	RM 250 A-C	76-78 ▲			
	TU 125 X/TUX/XTX	99 ▲			SP 370 C/N	78-79 ▲			
	TS 250 XE/XG/XH/XJ/XK	85-89 ▲		PE 250 B/C/N	77-79 ▲				
	GT 185 (K/L/M/A/B/C/EC)	73-79 ▲		CK3335 ▲=CT024	GS 1000 GT/GX	80-81 ▲			
	TS 185 K/L/M/B/C/ERN/ERT/ERX	73-81 ▲			GSX 1000 SZ	82 ▲			
	DF 200 EV/EW/EY (SH42A)	98-00			GS 1100 GZ	82 ▲			
	DR 200 G/H/J	86-89 ▲			GSX 1100 ET/EX/EZ/SZ	80-82 ▲			
	DR 200 SE Trojan	▲			GSX 1100 EFE/EF/ESF	84-86 ▲			
	DR 200 SEK1-SEK8	01-08 ▲			VL 1500 W/X/Y/K1/K2/K3	98-03 ▲			
	DR 200 SEP/SER/SES/SEV/SEW /SEX/SEY (SH42A) Djebel	93-00 ▲			VL 1500 K5/K6/K7/K8 (C 1500 Intruder)	05-08 ▲			
	RV 200 K2/K3	02-03 ▲			CK3337 ▲=CT011	TS 100 ERN/ERT/ERX (From F/No300564)	80-81 ▲		
	GT 200 EN/EX 'X5'	79-80 ▲				DR 125 SMK8/SMK9/SML0	08-12 ▲		
	SB 200 N/X	79-80 ▲				TS 125 ERN (From F/No 302346)	79 ▲		
	SX 200 R/R-Z/RJ/RM	90-91 ▲		TS 125 N (From F/No 178872)		84 ▲			
	GSF 250 N/ZM/P/NP/ZP/N/NR	92-96 ▲		TS 125 ERT/ERX		80-81 ▲			
	GSX 250 R CH/H (GJ72A)	▲		GT 125 EN		79 ▲			
	GSXR 250 J (GJ72A)	▲		CK3338 ▲=CT011		GP 125 X/XD	81-84		
	GSXR 250 CK	▲				CK3339 ▲=CT011	GP 100 X/UX/D/UD/UL GSXR 250 RK (GJ73A) GSX 250 SSM Katana (GJ76A)	81-92 ▲ ▲ 91 ▲	
SACHS		CK3340 ▲=CT011	DS 80 T/X/Z/D/F/G/H/J/K/L/M/N /P/R/S/T/V/W/X/Y JR 80 K1/K2/K3/K4/K5/K6/K7 RM 80 XZ/XD/HD				80-00 ▲ 01-07 ▲ 82-83 ▲		
XTC 125	00-04 ▲		CK3343 ▲=CT018SP				RL 250 Beamish Model Reed Valve Engine	78-82 ▲	
CK3321 ▲=CT035SP	GT 550 J/K/L/M/A/B				72-77 ▲		RL 325 Beamish Model Reed Valve Engine	78-82 ▲	
	CK3324 ▲=CT018SP				GT 750 J/K/L/M/A/B		72-77 ▲	GS 400 B/C	77-78 ▲
GS 750 B/DB/DC/EC/EN					77-79 ▲		GS 425 EN	79 ▲	
CK3326 ▲=CT051	TS 100 K/L/M/A/B				73-77 ▲		CK3344 ▲=CT018SP	GS 550 (all models)	77-82 ▲
	CK3328 ▲=CT011				ZR 50 SKE/SKH			84-87 ▲	GSX 550 (all models)
GS 50 K5 (NA41A)					05 ▲		CK3345 ▲=CT035SP	GS 1000 HC/EC/EN/SN/ET	78-80 ▲
GT 50 KB/KEN				77-80 ▲	CK3346 ▲=CT024SP			GSX 1100 SD/ESD	83 ▲
OR 50 ET				80 ▲		CK3347 ▲=CT018	XN 85 D 'Turbo'	83 ▲	
RM 50 C/N/T/X/Z		78-82 ▲		CK3348 ▲=CT047SP ■=CT022	SUZUKI RM 465 X/Z RM 500 D/E GSF 600 Y/K1/K2/K3/K4 (Naked Bandit) GSF 600 SY/SK1/SK2/SK3/SK4 (Faired Bandit) GSX 600 FJ/FK/FL/FM GSF 650 S/T/V/W/X Naked Bandit GSX 650 ST/SV/SW/SX Faired Bandit GSX R 750 F/G/H		81-82 ■		
TS 50 KN/ERKT/ERKX/ERKZ/ERKD		79-83 ▲	83-84 ■						
ZR 50 KEN/KEX/SLKX/SKX	79-81 ▲	00-04 ▲							
LT 125 D/E/F/G/H	84-86 ▲	00-04 ▲							
LT 185 E/F	84-85 ▲	88-91 ▲							
CK3329 ▲=CT011	RM 100 B/C	77-78 ▲	95-99						
	RM 125 A/B/C	76-78 ▲	95-99 ▲						
CK3330 ▲=CT018	RM 125 X/Z/D	81-83 ▲	85-87 ▲						
	RM 125 F	85 ▲	CK3349 ▲=CT011	TS 50 X (all models)	84-02 ▲				
	PE 175 C/N/T/X/Z	78-82 ▲		RG 50 EW	▲				
	TS 200 RK/RL/RM/RN/RR/R	89-94 ▲		CK3351 ▲=CT022	RG 250 WE/FG/FH/CH/FCH	84-88 ▲			
	GSX 250 ET/EX/EZ	80-82 ▲			RGV 250 J	88 ▲			
	GS 250 TT/TX	80-81 ▲			RGV 250 K/L	89-90 ▲			
CK3331 ▲=CT022	GS 650 GX/GZ 'Katana'	81-82 ▲			TV 250 J/K/AK/L (VJ21A) Wolf	88-90 ▲			
	GS 650 GTX/GTZ/GTD	81-83 ▲	CK3356 ▲=CT011	RM 125 E	84 ▲				
GS 700 EF/ESF	85 ▲	RM 125 J/K/L/M		88-91 ▲					
GSX 750 ET/EX/ESD/EFE/ESG/ESE/FFF	80-86 ▲	LT-F 300 FX/FY/FK1		99-01 ▲					
GSX 750 SE 'Katana'	84 ▲	ARCTIC CAT							
GSX 750 S/SS Katana (GS75X-106815-)	84 ▲	300 (2 x 4/4 x 4)	98-04 ▲						
GSX 750 S-2/S-2C (GS75X-114747-) Katana	84 ▲	300 (4 x 4)	05 ▲						
GS 850 (all models)	79-85 ▲	CK3332 ▲=CT022	CK3332 ▲=CT022	RG 250 WD	83 ▲				
CK3332 ▲=CT022	SUZUKI PE 250 T/X/Z RM 250 N/T/X/Z/D/E/F			DR 400 ST/SX	80-81 ▲				
		GN 400 TT	80 ▲						
CK3333 ▲=CT022	RGV 250 M/N/P/R/S GSX 400 ET/EX/EZ GSX 400 TX/LX GS 450 ET/EG/EJ	GSX 400 FEX/FZ/FD	81-83 ▲						
		GSX 400 FW/FWS/FWS-2	81-83 ▲						
		PE 400 T/X	80-81 ▲						
		RM 400 N/T	79-80 ▲						
		SP 400 T	80 ▲						
			80 ▲						

Part No.	Make/Model	Year	Part No.	Make/Model	Year
CK3357 CKF3357 ▲=CT029	GSX 600 FW/FX/FY/FK1/FK2/FK3 /FK4/FK5/FK6 GR 650 D/XD GSF 650 K5/K6 Naked Bandit - Non ABS GSF 650 AK5/AK6 Naked Bandit - ABS GSF 650 SAK5/SAK6 Faired Bandit - ABS GSF 650 SK5/SK6 Faired Bandit - Non ABS GSX 750 FW/W/FX/X/FY/Y/FK1-FK6 GSX 750 W/X/Y/K1	98-06 ▲ 83 ▲ 05-06 ▲ 05-06 ▲ 05-06 ▲ 05-06 ▲ 98-06 ▲ 98-03 ▲	CK3377 ▲=CT022 ■=CT029 ●=CT033SP Contd.	/CL1/CL2/CL3) Intruder (Cast wheel) VL 800 BTL4 - C800 Intruder VX 800 L/M/N/P/R/T VS 800 GLN/GLP/GLR/GLS/GLT/GLV VZ 800 V/W/X/Y/K1/K2 Marauder M 800 (VZ 800 K5-K9/L0/L1/L3Intruder M800) VZ 800 L4/L5 Intruder M 800/T M 800 (VZ 800 K9Z Intruder)	07-15 ■ 14 ■ 90-96 ■ 92-97 ■ 97-03 ■ 05-13 ■ 14-15 ■ 09-12 ■
CK3358 ▲=CT029	SW-1 (NJ45A) GN 250 F/J/M/R/T GW 250 L3/ZL5 Inazuma GW 250 FL5 Inazuma GZ 250 X/Y/K1-K8 Marauder TU 250 XV/XW TU 250 S/T/XS/XT/X-ST/X-SV/XT-W (NJ47A 100001-115972) Volty TU 250 XTX/XXTY (NJ47A-115-) Volty TU 250 GY/GBK1 Grass Tracker Big Boy (NJ47A-117/123) VL 250 Y/K1/K5/K6/K7 Intruder	92 ▲ 87-97 ▲ 13-15 ▲ 15 ▲ 99-08 ▲ 97-00 ▲ 92-97 ▲ 99-00 ▲ 00-01 ▲ 00-01/07 ▲	CK3378 CK3380 ▲=CT051 CK3381 ▲=CT048SP CK3382 CK3384 ▲=CT022	FR 80 M/B/N/X/Z/D RB 50 H GSX 1100 FJ/FK/FL/FM/FN/FP/FR GSXR 1100 G/H/J VS 1400 All Models RG 250 WD	76-83 87 ▲ 88-94 ▲ 86-88 ▲ 87-03 83 ▲
CK3359 ▲=CT047SP ■=CT029SP	GSX 400 FSV/FSK1 (GK7BA) Inazuma ST 400 Tempter V/W/X/Y/K1/K2/K3 DR 500 X/Z/D DR 600 RG/RH/RJ/RK (SN41A) DR 600 SF/SG/SH/SJ/SK (SN41A) LS 650 'Savage' FG/PK/PM/PR/PS/PT/PV	00 ▲ 97-03 ■ 81-83 ■ 86-89 ■ 85-89 ■ 87-97 ■	CK3385 ▲=CT011 CK3386 ▲=CT024 CK3387 ▲=CT036SP CK3388 ▲=CT029 CK3390 ▲=CT011	GSX 400 R2/R3 (GK71B/F) GSX R 400 H GSX 400 X/XA/XS 'Impulse' DR 650 SET/SEV XF 650 V/W/X/Y 'Freewind' DR 750 SJ/SK DR 800 SL (SR43A)/SM/SN/SP/SR/SS (SR43B) DR 800 ST/SV (SR43B) CCM 644 DS/Supermoto R30 (Suzuki 644cc engine) GSX 600 FN/FP/FR/FS/FT/FV GSX 750 FK/FL/FM/FN/FP/FR/FS/FT/FV GSX R 750 J/K GSX R 750 L/M/WN/WP/WR/WS GV 1400 'Cavalcade' (All models)	▲ 87 ▲ ▲ 96-97 ▲ 97-02 ▲ 88-89 ▲ 90-95 ▲ 96-97 ▲ 04 ▲ 02-04 ▲ 92-97 ▲ 89-97 ▲ 88-89 ▲ 90-95 ▲ 85-88 ▲
CK3364 ▲=CT011	LT 160 EK/EL/EM/EN LT-F 160 L/M/N/P/R/S/T/V/W /X/Y/K1/K2/K3 LT 160 K3/K4 QuadSport LT 230 GEF/GEG LT-F 230 G/H LT-F 250 K2 Ozark	89-92 ▲ 90-03 ▲ 03-04 ▲ 85-86 ▲ 86-87 ▲ 02 ▲	CK3392 ▲=CT055SP CK3393 CK3397 ▲=CT011 CK3399 CKF3399 ▲=CT022 CK3400 ▲=CT022	SUZUKI LT-F 4WDH/J/K/L/M/N/P/R/S/T/V/W LT-F 250 J/K/L/M/N/P/R/S/T/V/W/Y/K1 LT-F 250 FX/FY/FK1/FK2 LT-F 250 K3/K5/K6/K7/K8/K9 /L2/L3/L4 Ozark LT 250 EEF/EGF LT-F 300 J/K ARCTIC CAT 250 (2 x 4/4 x 4) GSX 1100 GM/GN GSX R 1100 K/L/M/N FR 50 GSF 400 M/N/P GSF 400 S/VS/V-V/VZ-V Bandit (GK7AA) GSX 400 FJ/FK/FAK/FL (GK74A) GSXR 400 J/RR/RAK (GK73A) GSF 400 K/NK/Z/VN/VZM/P/NP /VP/VZP/VR (GK75A) 'Bandit' GSXR 400 RL/RM/RN/RS (GK76A) DR 250 SL/SM/SN/SEP /SER/SES (SJ44A) DR 350 SL/SM/SN/SP/SER/SES/ SET/SEV/SEW/SEX SG 350 N 'Goose' QUADZILLA WK 300 RM 250 N/P RMX 250 N/P	87-98 ▲ 89-01 ▲ 99-02 ▲ 03/05-14 ▲ 85-86 ▲ 88-89 ▲ 01-05 ▲ 91-94 ▲ 89-92 ▲ 81- 91-95 ▲ 95-97 ▲ 88-90 ▲ 88-90 ▲ 89-94 ▲ 90-95 ▲ 90-95 ▲ 90-99 ▲ 92 ▲ 06 ▲ 92-93 ▲ 92-93 ▲
CK3366	JR 50 (All models) KDX 50 A1/A2/A3/A6F	78-07 03-06			
CK3367	RM 80 XG/XH/XJ	86-88			
CK3372 ▲=CT022	LT 250 RH/RJ/RK RM 250 G/H	86-90 ▲ 86-87 ▲			
CK3373 ▲=CT035SP	RE5M/A	75-76 ▲			
CK3374 CKF3374 ▲=CT022	SUZUKI RM 250 J/K/L/M RMX 250 K/L RMX 250 M RMX 250 R/S/T/V/W RMX 250 ST/SV/SW/SX (SJ14A) RM 250 R/S LT 500 RL/RM	88-91 ▲ 89-90 ▲ 91 ▲ 94-98 ▲ 96-99 ▲ 94-95 ▲ 90-91 ▲			
CK3375 ▲=CT029	GV 1200 GLF/GLF2/GLG 'Madura'	85-86 ▲			
CK3376 ▲=CT072SP	GSXR 750 RG (Dry Clutch - Sintered Friction)	86 ▲			
CK3377 ▲=CT022 ■=CT029 ●=CT033SP	VS 400 VR/FR/VTR/FTR/VT/FT 'Intruder' SV 400 N (VK53A) SV 400 SN (VK53A) SV 400 X/Y/K1/K2 SV 400 SX/SY/SK1/SK2 VS 600 GLS/GLT/GLV SV 650 X/Y/K1/K2 Naked - Non ABS SV 650 SX/SY/SK1/SK2 Top Fairing - Non ABS VS 700 GLFG/GLEPP/GLPH/GLEPH VS 750 GLF/GLFG/GLFH/GLPG/ GLEFH/GLEPH/GLPK/GLPM Intruder Volusia (VL 800 K1-K5) C 800 Intruder - Spoke Wheels VL 800 K6/K7/K8/K9/L0/L1/L2/L3/L5 C 800 C (VL 800 CK7/CK8/CK9/CLO	94- 98 98 00-02 ● 00-02 ● 95-97 ■ 99-02 ▲ 99-02 ▲ 86-87 ■ 85-91 ■ 01-05 ■ 06-15 ■			

Part No.	Make/Model	Year	Part No.	Make/Model	Year
CK3401 ▲=CT003	RM 125 N/P/R/S/T/V/W/X/Y/K1	92-01 ▲	CK3441 CK3443 CKF3443 ▲=CT021	GSX 400 SSN (GK77A) Katana DL 1000 K2-K9/L0 DL 1000 V-Strom (ABS) DL 1000 V-Strom Adventure ABS SV 1000 K3/K4/K5//K6/K7 Naked SV 1000 SK3/SK4/SK5/SK6/SK7 (Faired model) GSX 1300 RK2/RZK3/RK3/RK4/RK5/K6/K7 GSX 1300 RK8/RK9/RL0/RL1/RL2 /RAL3/RAL4/RAL5 Hayabusa GSX 1300 BKK8/BKK9/BKL0/BKL1 B-King	92 02-10 ▲ 14-20 ▲ 14-20 ▲ 03-08 ▲ 03-07 ▲ 02-07 ▲ 08-15 ▲ 08-12 ▲
CK3402 ■=CT029SP	DR 650 RL/RM (SP41A) DR 650 RSL/RSM (SP42A) DR 650 RUN/RN/RUP/RP (SP44A/B) DR 650 RER/RES (SP45A/B) DR 650 RSEM/RSEN/RSEP (SP45A/B)	90-91 ■ 90-91 ■ 92-93 ■ 94-95 ■ 91-93 ■	CK3445 ▲=CT009	KAWASAKI KLV 1000 (LV 1000 A1H/A2H) GSX 1400 K1	04-05 ▲ 01 ▲
CK3408 CKF3408 ▲=CT036SP	RF 600 RP/RR/RS/RT	93-96 ▲	CK3447 CKF3447 ▲=CT006	LT-Z 400 K5-K9/L0/L1/L2/L3 Quadport KAWASAKI KSF 400 A3/A6F ARCTIC CAT 400 DVX	05-15 ▲ 05-06 ▲ 04-06 ▲
CK3417 ▲=CT014 ■=CT055SP	GSR 750 L1/L2/L3 GSR 750 AL2/AL3/AL4/AL5 GSXR 750 T/V/W/X GSXR 750 K4/K5 RF 900 RS/R2S/RT/RV/RW TL 1000 SV/SW GS 1200 SSK1/ZK1 (GV78A) GSF 1200 SAV ABS Bandit GSF 1200 T/V/W/X/Y (Naked bandit) 4 piston caliper GSF 1200 ST/SV/SW/SX/SY (Faired bandit) 4 piston caliper SUZUKI GSX 1200 FSW/FSX Inazuma GSF 1200 K1/K2/K3/K4/K5 (Naked Bandit - 6 piston caliper) GSF 1200 SK1/SK2/SK3/SK4/SK5 (Faired Bandit - 6 piston caliper) GSF 1200 K6/AK6 (Naked Bandit - 4 piston caliper) ABS & Non ABS Version GSF 1200 SK6/SAK6 (Faired Bandit - 4 piston caliper) ABS & Non ABS Version	11-14 ▲ 12-15 ▲ 97-99 ■ 04-05 ▲ 95-98 ▲ 97-98 ▲ 01 ■ 97 ■ 96-00 ■ 96-00 ■ 98-99 ■ 01-05 ■ 01-05 ■ 06 ■ 06 ■	CK3448 ▲=CT011	LT-F 250 K4 Ozark LT-Z 250 K4-K9/L0 Quadport	04 ▲ 05-12 ▲
CK3418 ■=CT055SP	RF 900 RR GSXR 1100 WP/WR/WS/WT	94 ■ 93-96 ■	CK3450 CKF3450 ▲=CT045	RMX 450 ZL0/ZL2 RM-Z 450 K5/K6/K7/K8/K9/L0/L1-L5 LT-R 450 K6/K7/K8/K9/L0/L1	10-15 ▲ 05-19 ▲ 06-12 ▲
CK3428 ▲=CT009	TL 1000 RW/RX/RV/SW/SX/SY TL 1000 SX/SY SUZUKI	98-00 ▲ 99-00 ▲	CK3451 CKF3451 ▲=CT015	GSXR 1000 K5/K6/K7/K8 GSX-S 1000 (Naked/Non ABS) GSX-S 1000 (Naked/ ABS) GSX-S 1000 F (Faired/Non ABS) GSX-S 1000 F (Faired/ ABS) Katana	05-08 ▲ 18-20 ▲ 18-20 ▲ 18-20 ▲ 18-20 ▲ 19-20 ▲
CK3430 ▲=CT021	GSX 1300 RY/RK1 'Hayabusa' GSX 1300 RX	00-01 ▲ 99 ▲	CK3452 ▲=CT006	LT-F 500 FK3-FK7 ARCTIC CAT 500 (4 x 4 Manual) 500 (Manual 4 x 4)	03-07 ▲ 03-04 ▲ 05-09 ▲
CK3432 ▲=CT029	VL 125 Y/K1-K7 "Intruder"	00-08 ▲	CK3453 ▲=CT016	SUZUKI RM 250 K6/K7/K8/K9 RM 250 XCK8	06-12 ▲ 09 ▲
CK3433 CKF3433 ▲=CT006 ■=CT009	HONDA CRF 450 RB/RC/RD/RE/RF/RG CRF 450 RE (Limited Road Use) SUZUKI DR-Z 400 SEY/EY/Y/SK1/EK1/K1 /SK2/EK2/K2/SK3/EK3/K3/SK4 /EK4/K4/SK5/K5/K6/EK6/SK6 /SK7/EK7/K7/SK8/SK9 DR-Z 400 SMK5/6/7/8/9 LT-Z 400 K3/K4 ARCTIC CAT 400 DVX CCM R 35/R 35 S CR 40 S Cafe Racer CR 40 Street SR 40 Street Scrambler 404 E/DS/Supermoto KAWASAKI KSF 400 A1/A2 (KFX 400)	11-16 ■ 16 ■ 00-09 ▲ 05-09 ▲ 03-04 ▲ 04-06 ▲ 06-07 ▲ 07 ▲ 07 ▲ 07 ▲ 03-04 ▲ 03-04 ▲	CK3454 ▲=CT016	RM 250 K3/K4/K5	03-05 ▲
CK3435 ▲=CT009	TL 1000 SK1/RK1	01-02 ▲	CK3455 CKF3455 ▲=CT015	GSXR 600 K6/K7	06-07 ▲
CK3437 ▲=CT022	RMX 250 SN/SR/SS (SJ13A)	95-97 ▲	CK3456 CKF3456 ▲=CT015	GSX-R 600 GSX-R 750 GSX-S 750	08-20 ▲ 06-20 ▲ 15-20 ▲
CK3439 ▲=CT009	GSX 1400 K2/K3/K4/K5/K6/K7	02-07 ▲	CK3457	M 1800 R (VZR 1800 K6/K7/K8 /K9 Intruder handlebar cowlings) M 1800 R2 (VZR 1800 NK8/NK9) Intruder - No handlebar cowlings M 1800 RZ (VZR 1800 ZK7/ZK8 /ZL1/ZL2) intruder - With handlebar cowlings with central tape strip VZR 1800 BZL4/BZL5 - M1800 RB	06-09 08-09 07-13 14-15
			CK3458	DR-Z50 DR-70	19 08-17
			CK3459 ▲=CT021	GSF 1250 K7/K8/K9/OL0 (Naked Bandit 4 Piston Caliper) Non ABS GSF 1250 SAK7/SAK8/SAK9/SAZK9 /SALO (Faired bandit - 4 Piston Caliper) ABS Model GSF 1250 AK7/AK8 (Naked bandit - 4 piston caliper) ABS Model GSX 1250 FAL0/FAL1/FAL2 GSX 1250 FAL0ST/FAL1ST Sport Touring M 1500 (VZ 1500 K9/L0 - Intruder) VL 1500 BTL3/BTL4/BTL5 (CT 1500 BT Intruder)	07-11 ▲ 07-15 ▲ 07-08 ▲ 10-15 ▲ 10-14 ▲ 09-12 ▲ 13-15 ▲

Part No.	Make/Model	Year	Part No.	Make/Model	Year
CK3462 CKF3462 ▲=CT009	SUZUKI GSXR 1000 K9/L0/L1/L2/L3/ZL3/L4 /ZL4/L5/AL5/AL6	09-16 ▲	CK4424 CKF4424 ▲=CT016 Contd.	KLE 500 B1P/B6F/B7F Z 500 A1-A3/B1-B2 Z 550 C1-C2 (Ltd) GT 550 G1-G9 GPZ 550 D1/H1-H2/A1-A4 ZR 550 A1-A2 (Z550 F) ZR 550 B2/B3/B4/B5/B6 "Zephyr" KL 600 A1 (KLR 600) KLR 600 B1/B2/B4/B6-B9 GPZ 600 R A1-A6 GPX 600 R C1-C3/C6-C7 ZL 600 B1 ZZR 600 D1/D2/D2A/D3 ZZR 600 (ZX 600 E1-E13) ZZR 600 (ZX 600 E6F) 650 Vulcan S (EN 650 AFF/AGF/Non ABS) 650 Vulcan S (EN 650 BFF/BGF/ ABS) ER-6F (EX 650) ER-6f (ABS Model) ER-6n (ER 650) ER-6n (ABS) ER 650 KLE 650 A7F/A8F/A9F/CAF/CBF /CCF/CDF/CEF Versys KLE 650 B7F/B8F/B9F/DAF/DBF /DCF/DDF Versys ABS KLE 650 Verseys (KLE 650 EFF/EGF/Non ABS) KLE 650 Verseys (KLE 650 FFF/EGF/ABS) KLR 650 A1-A3 KL 650 B1/B2/B3 Tengai KLX 650 C1/C2/C3 ZXR 750 H1/H2	05-07 ▲ 79-81 ▲ 80-81 ▲ 83-01 ▲ 81-87 ▲ 83-84 ▲ 91-99 ▲ 84 ▲ 85-94 ▲ 85-89 ▲ 86-96 ▲ 95-97 ▲ 90-92 ▲ 93-05 ▲ 06-07 ▲ 15-16 ▲ 15-16 ▲ 06-11 ▲ 06-11 ▲ 06-11 ▲ 06-11 ▲ 07-14 ▲ 07-14 ▲ 15-16 ▲ 15-16 ▲ 87-89 ▲ 89-92 ▲ 93-97 ▲ 89-90 ▲
CK3463	C 1800 R (VLR 1800 K8/K9/L0/L1) (C 1800 R Intruder) C 1800 RT Touring Intruder VLR 1800 K8RT/K9RT	08-13 08-10	CK4425 ▲=CT004	KAWASAKI KX 125 K4-K5/L1-L4/M1-M3/M6F/M7F/M8F KX 125 K1/K2/K3 Z 200 A1 (From E/No 005063) Z 200 A2-A6 KL 250 A1-A4/C1/C2 KSF 250 A1-A18 (KXF 250 Mojave) Z 250 C1/C2/G1/G2 KLT 250 C1-C3 HI 500 Mach III HI-A 500 S Mach III HI-B/C 500 Mach III HI-D/E/F 500 KH 500 A8	97-08 ▲ 94-96 ▲ 78 ▲ 79-83 ▲ 78-84 ▲ 87-04 ▲ 80-83 ▲ 83-85 ▲ 69-70 ▲ 71 ▲ 72 ▲ 73-75 ▲ 76 ▲
CK3465 ▲=CT014	GSXR 750 K1/K2/K3	00-03 ▲	CK4433 ▲=CT006	KDX 250 B2/B3 KXT 250 A1 'Tecatē' Z 250 A1-A3/B1-B2 ER 250 B1-B3 'Scorpion' GPZ 305 A1/B2-B10 KX 500 A1/A2	82-83 ▲ 84 ▲ 79-81 ▲ 83-88 ▲ 83-96 ▲ 83-84 ▲
CK3466 ▲=CT014	GSXR 600 K1/K2/K3/SK3	01-03 ▲	CK4434 ▲=CT016	ZL 900 A1/A2 'Eliminator' GPZ 1000 RX A1-A3 1000 GTR (AG 1000 A1-A18) Z 1000 E1/E2 (ST Shaft) Z 1000 J1/J2/J3 Z 1000 K1/K2 LTD Z 1000 R1/R2 (Eddie Lawson Replica) ZL 1000 A1 GPZ 1100 B1/B2 GPZ 1100 A1-A3 Z 1100 A1-A3 Z 1100 D1/D2 'Spectre' Z 1100 R1 ZR 1100 A1/A2/A3/A4/B1 ZR 1100 B5 (Zephyr 1100 RS) ZX 10 B1/B2/B3 ZRX 1100 (ZX 1100 C1/C2/C3/C4) ZRX 1200 A1/A2/A3/A4/A5/A6F ZRX 1200 B1-B3	85-86 ▲ 86-88 ▲ 89-03 ▲ 79-80 ▲ 81-83 ▲ 81-82 ▲ 82-83 ▲ 87 ▲ 81-82 ▲ 82-85 ▲ 81-83 ▲ 82-83 ▲ 84 ▲ 92-97 ▲ 02 ▲ 88-90 ▲ 97-00 ▲ 01-07 ▲ 01-08 ▲
CK3468 ▲=CT009	GSX-R 1000 ABS	17-20 ▲	CK4435 CKF4435 ▲=CT016	KX 250 J1/J2/K1-K4/K5/L1-L4/M1 /M2/R1/R6F/R7F/R8F EJ 650 A1/C3-C7 (W650) KLR 650 C1-C10 KLR 650 (KL 650 E8F/E9F) VN 700 A1 'Vulcan'	92-08 ▲ 99-05 ▲ 95-04 ▲ 08-09 ▲ 85 ▲
CK4409 ▲=CT019	KAWASAKI Z1/Z1A/Z1B Z 900 A4/A5 Z 1000 D1-D3 'ZIR' Z 1000 A1/A2/A3/A4 Z 1000 H1	74-76 ▲ 76-77 ▲ 78-80 ▲ 77-80 ▲ 80 ▲			
CK4411 ▲=CT058	KE 125 A7-A12 KH 125 A1-A4 KE 175 B1/B2/B3 KE 175 D2-D5 KT 250 A/A2	80-85 ▲ 77-81 ▲ 79-83 ▲ 79-83 ▲ 75-76 ▲			
CK4413 ▲=CT019	KAWASAKI Z 650 B1/B2/B3/D2-D3/F1-F4 Z 650 C1/C2/C3 Custom Z 650 F1/F2/F3/F4 Z 700 A1 'Ltd' ZN 700 A1/A2 'Ltd' ZN 750 N1/N2 'Spectre' Z 750 E1/H1-H2/L1-L4 GT 750 P1-P5 GPZ 750 R1 GPZ 750 A1-A5	77-79 ▲ 77-79 ▲ 80-83 ▲ 84 ▲ 84-85 ▲ 82-83 ▲ 80-84 ▲ 82-90 ▲ 82 ▲ 83-87 ▲			
CK4415 ▲=CT004	H2/H2-A Mach IV (750cc)	72-73 ▲			
CK4419 ▲=CT006	KX 250 KX 250 A/A3/A4/A5 KEF 300 B1/B2/B3 Lakota Sport KLF 300 A1/A2/B1-B17/C1-C17 ARCTIC CAT 400 (2 x 4/4 x 4)	74 ▲ 75-79 ▲ 01-03 ▲ 87-05 ▲ 00-02 ▲			
CK4421	Z 400 B1/B2 Z 400 G1 Z 440 A2 LTD Z 440 A2/C1-C2/H1/H2 Z 440 D4-D6 (Ltd)	78-79 79 80-83 82-84			
CK4424 CKF4424 ▲=CT016	Z 400 J1-J3 ZR 400 A1/B1 (Z400 F) ZX 400 C2 (Z400 F11) ZL 400 A 'Eliminator' ZL 400 'B' Eliminator' 400 SE ZL 400 D1/D2 FX 400 R (ZX 400 E1-E3) GPZ 400 R (ZX400 D1/D2/D3/D3A) GPZ 400 R (ZX 400 F1) ZR 400 Zephyr (G2/G3/G3A/G4/G5) ZRX 400 (ZR 400 E1-E7) ZZR 400 (ZX 400 K1/K2/K3) ZZR 400 (ZX 400 N1-N7) EN 450 A1-A5 (Ltd 450) EX 500 A1-A6/D1-D7 (GPZ 500 S) KLE 500 A1-A12 EN 500 A1-A4/B1/B2/C1-C9 ER-5 (ER 500 A1/A2/A3/A4/C1-C5P) GPZ 500 (S) (EX 500 B1-B5) GPZ 500 S (EX 500 E1-E10)	80-83 ▲ 83-84 ▲ 85 ▲ 86-87 ▲ 88 ▲ 94-95 ▲ 86-88 ▲ 85-87 ▲ 87 ▲ 97-01 ▲ 94-01 ▲ 90-92 ▲ 93-99 ▲ 86-89 ▲ 87-01 ▲ 91-04 ▲ 90-04 ▲ 97-07 ▲ 88-93 ▲ 94-04 ▲			

Part No.	Make/Model	Year	Part No.	Make/Model	Year
CK4435 CKF4435 ▲=CT016 Contd.	Z 750 Y1 (Ltd)	82 ▲	CK4442	AE 50 A1-A2	81-84
	GPZ 750 R G2/G3	85-86 ▲		AR 50 A1/C2-C10	81-97
	GPZ 900 R A1-A8	84-96 ▲	KSR I (KMX 50 B1/B2)	90-91	
	ZX-7 RR (ZX 750 N1/N2)	96-99 ▲	CK4443 ▲=CT019	ZX 750 E1/E2 'Turbo'	84-87 ▲
	GPX 750 F1/F2/F3/F2A	87-89 ▲		Z 200 A1 (Up to Eng No.005062)	77 ▲
	VN 750 A2/A3/A4/A5/A10	86-94 ▲	CK4446 ▲=CT004	KLR 250 D2-D22	84-05 ▲
	ZXR 750 J1/J2/L1/L2/L3/P1-P7	91-03 ▲		ZXR 400 L1-L5/L8/L9	91-03 ▲
	ZXR 750 R (ZX 750 K1/K2/M1/M2)	91-94 ▲		ZXR 400 H1/H2	89 ▲
	Z 750 B1/B2	77-78 ▲		ZXR 400 R (ZX 400 M1-M4)	91-94 ▲
	Z 750 D1	76 ▲		ZX 400 J1/J2	89-90 ▲
	EJ 800 ABF/ACF (W 800/Solid F Disc)	11-12 ▲	Xanthus (ZR 400 D1/D3/D4)	92-95 ▲	
	EJ 800 (W 800 Cafe style/Cockpit fairing)	11 ▲	CK4452	Z 1300 A1-A3	79-81
	EJ 800 ACFA (W 800 Special Edition Black Exhaust/Gold Rims)	12 ▲		CK4453 CKF4453 ▲=CT002	KX 80 W1/W2/W3
	EJ 800 ADF/AEF/AFF/AGF (W 800)	13-16 ▲	KX 85 Small Wheel (17" Front/14" Rear)		01-20 ▲
	EJ 800 ADFA/AEFA/AFFA/AGFA (W 800 Special Edition)	13-16 ▲	KX 85 Big Wheel (19" Front/16" Rear)		01-20 ▲
	VN 800 A1-A3/B1-B10/B6F/C1/C2/E1-E3	95-06 ▲	KX 100 C1/C2/C3		98-00 ▲
	VN 900 AF6 Classic	06 ▲	AR 125 A1A-A7/B1-B8		83-94 ▲
	VN 900 BBFA/BCFA/BDF/BEFA/BFFA Classic Special Edition	11-19 ▲	KMX 125 A1/A2/B1/B2		86-87 ▲
	VN 900 C7F/C8F/C9FA/CAF/CBF/CCFA /CDF/CEFA/CFFA Custom (Cast wheel)	07-19 ▲	(From E/No MX 125 AE 000001-013436)		
	VN 900 B7F/B8F/B9F/BAF/BBF/BCF /BDF/BEF/BFF Classic (Spoke wheel)	07-19 ▲	SUZUKI		
ZX-9R (ZX 900 B1-B4)	94-97 ▲	RM 100 K3	03 ▲		
SUZUKI		CK4455 ▲=CT032	KAWASAKI		
RM 250 T	96 ▲		ZG 1300 A1-A3	84-86 ▲	
RM 250 V/W/X/Y/K1/K2	97-02 ▲		VN 1500 B2/C1/C2/D1	88-96 ▲	
CK4436 ▲=CT058	KAWASAKI			VN 1500 C1/C2/D1/D2	94-98 ▲
	KX 125 B1		82 ▲	VN 1500 E1/E2 'Classic'	98-99 ▲
	KDX 175 A1-A3		80-82 ▲	VN 1500 B2-B6	88-92 ▲
KH 250 B4-B5	79-80 ▲		VN 1500 G1/G2	98-99 ▲	
CK4438 CKF4438 ▲=CT070SP	KX 60 A1-A2/B1-B19		83-03 ▲	VN 1500 J1/J2/R1/R2/R3	99-04 ▲
	KX 65		00-20 ▲	VN 1500 N1/N2/N3 "Classic Fi"	00-04 ▲
	KX 80 E1/E2		83-84 ▲	VN 1500 P1/P2	02-04 ▲
	KLX 110	02-20 ▲	VN 1500 L1/L2/L3/L4 "Nomad Fi"	00-03 ▲	
	KH 125 K2-10	82-98 ▲	M 1600 (VZ 1600 K4/K5 Intruder)	04-05 ▲	
	KH 125 L1 (KH 125 EX)	83 ▲	VN 1600 A1/A2/A3/A6F	03-08 ▲	
	Z 125	16-20 ▲	VN 1600 B1 Mean Streak	04 ▲	
	Z 125 Pro	16-20 ▲	VN 1600 B2H/B6F/B7F (Mean Streak)	05-08 ▲	
	MODENAS		VN 1600 D1H/D6F Classic Tourer	05-08 ▲	
	Kriss 110/115	▲	CK4457 ▲=CT058	KX 125 B2/C1	83-84 ▲
SUZUKI		KDX 200 A1-A3		83-85 ▲	
Smash 110cc	03 ▲	S3/S3A (400cc)		74-75 ▲	
DR-Z 110 K3/K4/K5	03-05 ▲	S2/S2-A (350cc)	72-73 ▲		
RM 60 K3	03 ▲	KH 400 A3-A5	76-78 ▲		
RM 65 K3/K4/K5	03-05 ▲	CK4458	Z 1300 A4/A5	82-83	
CK4439 CKF4439 ▲=CT006	KDX 250 B1		81 ▲	CK4459 ▲=CT006	KX 250 D1/D2
	KX 250 A6/A7	80-81 ▲	KXT 250 B1/B2 (Tecate - 3 wheel model)		86-87 ▲
	KLX 400 B1/B3/B3A/B4/B5/B6/B7	93-98 ▲	KX 500 B1/B2		85-86 ▲
	KX 420 A1/A2	80-81 ▲	CK4465 ▲=CT006	KX 250 B1/C1/C2	82-84 ▲
	SUZUKI			KXT 250 A2 (Tecate - 3 wheel model)	85 ▲
LT-F 400 K2 Eiger	02 ▲	CK4468	KX 80 E3/G1/G2/J1/J2	85-87	
LT-F 400 K3-K7 Eiger 2WD	03-07 ▲		CK4469 ▲=CT042	KX 125 D1/E1/E2	85-87 ▲
LT-F 400 FK2-FK7 Eiger 4WD	02-07 ▲	KDX 200 C1/C2/C3		86-88 ▲	
LT-F 400 FK8/FK9/FLO/FL1 King Quad 4WD	09-12 ▲	KL 250 H1		98 ▲	
LT-F 500 FW/FX/FY/FK1/FK2	98-02 ▲	KL 250 J1 Stockman		▲	
ARCTIC CAT		KLX 250 D1/D2/F1-F4		93-97 ▲	
400 (2 x 4/4 x 4)	98-▲	KLX 250 G1		94 ▲	
400 (2 x 4)	98 ▲	KLX 250 J1-J6 D-Tracker		98-03 ▲	
400 (2 x 4/4 x 4)	03-04 ▲	KLX 250 H6F/H7F		06-07 ▲	
400 (4 x 4/Manual)	05-08 ▲	KLX 250 S9F/SAF/SBF/SCF/SDF/SEF/SFF/SGF		09-16 ▲	
Bearcat 454 (4 x 4)	96-98 ▲	KLX 300 A2-A10/A6F/A7F		97-07 ▲	
Bearcat 454 (2 x 4)	97-98 ▲	SUZUKI			
500 (4 x 4)	98-02 ▲	250 S BK2 (LX 250L)	02 ▲		
CK4440	AE 80 A1/B1	81-83	CK4473 ▲=CT016	GPX 250 F2 (ZX250 F2/F3/F6/F8/F9)	88-95 ▲
	AR 80 A1/C1-C8	81-91		GPX 250 RII (EX 250 G)	88 ▲
	KSR II (KMX 80 B1/B2)	90-91		EL 250 D1-D5	90-94 ▲
	KC 100 C1-C4	81-83		EL 250 B1-B3 'Eliminator'	87-89 ▲
	KE 100 A8-A10	79-81		KLE 250 A1/A1A/A2 (Anhelu)	
	KE 100 B1-B15	82-98		GPZ 250 R (EX 250 E)	86 ▲
	KH 100 A2-A4/G2-G8	78-87		ZZR 250 (EX 250 H1-H13)	90-03 ▲
	KM 100 A4-A6	79-80		EL 252 (EL 250 F2/F3/F5/F6)	96-03 ▲
	KH 125 K1	82			

Part No.	Make/Model	Year	Part No.	Make/Model	Year	
CK4475 ▲=CT006	KX 250 E1/F1/G1/H1/H2 KXF 250 A1/A2 KDX 250 D1 KX 500 C1/D1/E1-E16	87-91 ▲ 87-88 ▲ 91-93 ▲ 87-04	CK4509	KDX 250 SR (KDX 250 F1)	91	
CK4477	KX 80 L1 KX 100 N1	88 88	CK4510 CKF4510 ▲=CT004 ■=CT079SP	Z 900 (ZR 900 A) Z 900 ABS (ZR 900 B) Z 900 RS (ZR 900 C) Z 900 RS Café (ZR 900 E) ZX9R (ZX 900 C1/C2/E1/E2/F1/F2) KLZ 1000 ACF/ADF/AEF Versys Z 1000 (ZR 1000 A1/A2/A3/A6F) Z 1000 (ZR 1000 B7F/B8F) Z 1000 ABS (ZR 1000 C7F/C8F/C9F) Z 1000 DAF/FAS/DBF/DCF/DCFA /DDF/DDFA (5 Spring Clutch) Z 1000 EAF/EBF/ECF/ECFA/EDF/EDFA (5 Spring Clutch) Z 1000 FEF/FEFA/FFF (5 Spring Clutch)	17-19 ▲ 17-19 ▲ 18-19 ▲ 18-19 ▲ 98-04 ▲ 12-14 ▲ 03-06 ▲ 07-08 ▲ 07-09 ▲	
CK4478	KX 80 L2/L3/R1-R7 KX 100 A1/A2/B1-B7	89-97 89-97		Z 1000 DAF/FAS/DBF/DCF/DCFA /DDF/DDFA (5 Spring Clutch) Z 1000 EAF/EBF/ECF/ECFA/EDF/EDFA (5 Spring Clutch) Z 1000 FEF/FEFA/FFF (5 Spring Clutch)	10-13 ▲ 10-13 ▲ 14-15 ▲	
CK4482	KX 125 F1/G1 KDX 200 E1/E2/E3/E4/E5/E6	88-89 89-94		KAWASAKI Z 1000 GEF/GEFA/GFF (5 Spring Clutch) Z 1000 SX (ZX 1000 GBF/GCF/GDF) (Non ABS) Z 1000 SX (ZX 1000 HBF/HCF/HDF) (ABS) Z 1000 (ZR 1000 EAF/EBF/ECF/EDF/GEF/GFF) Z 1000 Performance Z 1000 SX Tourer ZX 1000 SX (ZX 1000 LEF/LFF) Non ABS ZX 1000 SX (ZX 1000 MEF/MFF) ABS ZX 1000 SX Tourer ZX 1000 Special Edition (ZR 1000 GEFA)	14-15 ▲ 14-15 ▲ 11-13 ▲ 11-13 ▲ 10-15 ▲ 16-19 ▲ 11-19 ▲ 14-15 ▲ 14-15 ▲ 14 ▲ 14 ▲	
CK4484 ▲=CT016	KR1 (250 cc) (KR 250 B2/C2/C3)	89-92 ▲		ZR 1000 DAF/DBF/DCF/DDF ZR 1000 DCFA/DDFB ZX 10R (ZX 1000 C1/C2/D6F/D7F) ZX 10R (ZX 1000 E8F/E9F/FAF) ZX 10R ABS (ZX 1000 KBF/KCF/KDF/KEF/KFF) ZX 10R (ZX 1000 JBF/JCF/JDF/JEF/JEF) ZX 10R 30th Anniversary Edition (ZX 1000 JFFA Non ABS) ZX 10R 30th Anniversary Edition (ZX 1000 KFFA ABS) ZX 10R (ZX1000 SGF) ZX 10R Winter Test Edition (ZX1000 SGFB) ZX 10R Ninja KRT Replica (ZX1000 SGFA) ZX-10RR ZX-10RR Performance	10-13 ▲ 14-15 ▲ 14-15 ▲ 10-13 ▲ 12-13 ▲ 05-07 ▲ 08-10 ▲ 11-15 ▲ 11-15 ▲ 15 ▲ 15 ▲ 16-19 ▲ 16 ▲ 16-19 ▲ 17-19 ▲ 17-19 ▲	
CK4485	KX 125 H1/H2/J1	90-92		SUZUKI GSXR 1000 K1/K2/K3/K4 GSX-S 1000 ABS GSX-S 1000 F ABS	01-04 ▲ 15-17 ▲ 15-17 ▲	
CK4486 ▲=CT002	KAWASAKI KMX 125 B2-B12 (From E/No MX 125AE 013437) KMX 125 A3/A4/A5 KMX 200 A2/A3 KTM Duke 200 RC 200	87-03 ▲ 88-89 ▲ 88-92 ▲ 12-19 ▲ 14-19 ▲		YAMAHA YZF-R1 YZF-R1 M YZF-R1 (60th Anniversary Edition) MT-10 (998cc)	15-20 ■ 15-20 ■ 16 ■ 16 ■	
CK4488 ▲=CT021	ZZR 1100 C1/C2/C2A/C3/D1-D9 ZX 1100 E1/E2/F1 ZZR 1200 C1H/C2H	90-01 ▲ 95-98 ▲ 02-04 ▲		CK4511	BN 125 A1-A5/A6F/A7F Eliminator	98-07
CK4489	KDX 125 A1/A2/B1/B2	90-94		CK4513 ▲=CT009	ZX12R (ZX 1200 A1)	00 ▲
CK4493 ▲=CT019	GT 750 P7/P9 ZR 750 C1/C2/C3/C4/C5/D1 'Zephyr' ZR-7 (ZR 750 F1/F3/F5) ZR-7S (ZR 750 H1/H3)	92-96 ▲ 91-98 ▲ 99-04 ▲ 01-04 ▲		CK4514 CKF4514 ▲=CT003 ■=CT004	SUZUKI RM 125 K2/K3/K4/K5/K6/K7/K8/K9 RM 125 XCK8 RM-Z 250 K4/K5/K6/K7/K8/K9 /L0/L1/L2/L3/L4/L5/L6/L7/L8/L9 KAWASAKI KX 250 F (KX 250 N1/N2/T6F/T7F/T8F) KX 250 F ZX-6R (ZX 600 P7F/P8F/R9F/RAF /RBF/RCF/RDF/REF/RFF/RGF) ZX-6R (ZX 636 C1/C6F) ZX-6R EDF/EEF/EFF/EGF/EHF (Non ABS 636cc) ZX-6R FDF/FEF/FFF/FGF/FHF (ABS 636cc) ZX-6R (ZX 636 EGFA/EHFA - Non ABS/KRT Edition - 636cc) ZX-6R (ZX 636 FGFA/FHFA - ABS/KRT Edition - 636cc) ZX6 R 30th Anniversary Edition (ZX 636 EFFA- Non ABS -636cc) ZX6 R 30th Anniversary Edition (ZX 636 FFFA- ABS -636cc)	02-12 ▲ 09 ▲ 04-19 ■ 04-08 ■ 09-20 ■ 07-16 ■ 05-06 ■ 13-17 ■ 13-17 ■ 16-17 ■ 16-17 ■ 15 ■ 15 ■
CK4498	KX 125 J2	93		CK4505	KDX 200 H1/H2/H3/H4/H5 KDX 220 R A4-A12/A6F KDX 220 SR	95-99 97-06
CK4503 ▲=CT004 ■=CT037SP	ZX-6R F1/F2/F3/G1/G2/J1/J2 ZX6RR (ZX 600 K1) ZX6R (636cc) (ZX636A1P/B1/B2) Z 750 S (ZR 750 K1/K6F) Z 750 J1/J2/J6F Z 750 R (ZR 750 NBF/NCF) Z 750 R ABS (ZR 750 PBF/PCF) ZR 750 L7F/L8F/L9F/LAF/LAS ZR 750 M7F/M8F/M9F/MAF/MAS Z 800 ADS/AEF/AFF/AGF (Non ABS) Z 800 BDS/BEF/BFF/BGF (ABS Model) Z 800 E CDS/CEF/CFE/CGF (Non ABS) Z 800 E DDS/DEF/DFE/DGF (ABS Model) KLZ 1000 BFF/BGF Versy Z 1000 (ZR1000 GGF) 3 Spring Clutch Z 1000 (ZR1000 FGF) 3 Spring Clutch Z 1000 SX ABS (ZX1000 MGF) (3 Spring Clutch) Z 1000 SX Non ABS (ZX1000 LGF) (3 Spring Clutch) KLZ 1000 BFF/BGF/BGFAS Versys SUZUKI RG 400 EWF/EW-2G/EWH Walter Wolf (Type 1&2) RG 500 G/CH	95-01 ▲ 03 ▲ 02-04 ▲ 05-06 ▲ 04-07 ▲ 11-12 ▲ 11-12 ▲ 07-10 ▲ 07-10 ▲ 13-16 ▲ 13-16 ▲ 13-16 ▲ 13-16 ▲ 15-16 16 ▲ 16 ▲ 16 ▲ 16 ▲ 15-19 85-87 ■ 85-87 ■	CK4508	SUZUKI BJ 250 B1-B7A 'Estrella' BJ 250 C1-C7/D1-D7/F1/F2 BJ 250 E1-E4A Estrella-RS Custom ZR 250 A1-A5 ZR 250 B6 (Ballius II) ZXR 250 C1-C5/D1 ZXR 250 (ZX 250 A1/A2) ZXR 250 R (ZX 250 B1/B2) GSX 250 FXK2	92-99 95-03 96-99 91-95 02 91-95 89-90 89-90 02	

Part No.	Make/Model	Year	Part No.	Make/Model	Year
CK4514 CKF4514 ▲=CT003 ■=CT004 Contd.	ZX-6RR (ZX 600 M1) ZX-6RR (ZX 600 N1/N6F) ZX-6RR (ZX 600 N1/N6F)	04 ■ 05-06 ■ 05-06 ■	CK5588 CKF5588 ▲=CT021	TRIUMPH Adventurer Trophy 3 cyl 900 Trophy 4 cyl 1200 Trident 750/900 Legend TT Thunderbird/Sport Speed Triple Sprint Daytona 900/Cyl Daytona 1200 4 cyl Daytona 750 3 cyl Daytona 1000 4 cyl Tiger 900cc (Up to VIN 71698) Carb Models Daytona Super 3	96-01 ▲ 92-01 ▲ 92-01 ▲ 92-98 ▲ 98-01 ▲ 95-04 ▲ 94-99 ▲ 94-98 ▲ 93-96 ▲ 93-98 ▲ 92 ▲ 92 ▲ 93-96 ▲ 94-97 ▲
CK4515 ▲=CT009	ZX12R (ZX 1200 A2-A4/B1-B4/B6F)	01-06 ▲	CK5589 CKF5589 ▲=CT009	TRIUMPH T595/955i Daytona T509 'Speed Triple' 885/955cc Sprint ST Upto VIN 139235 Sprint RS Upto VIN 138656 Tiger 955cc Tiger 900cc (From VIN 71699) Injection Models	97-00 ▲ 97-01 ▲ 98-01 ▲ 98-01 ▲ 99-06 ▲ 97-98 ▲
CK4516 ▲=CT032	KAWASAKI VN 1700 DAF/DBF/DCF/DDF/DEF Classic Tourer ABS VN 1700 B9F/BAF/BBF/BCF/BDF/BEF /BFF/BGF Voyager ABS VN 1700 C9F Classic Tourer VN 1700 DFF/DGF - Vulcan 1700 Nomad VN 1700 Classic ABS VN 1700 E9F Classic VN 1700 Voyager Custom VN 2000 A1/A2/A6F VN 2000 H8F/H9F Classic	10-14 ▲ 09-16 ▲ 09 ▲ 15-16 ▲ 10-17 ▲ 09 ▲ 11-17 ▲ 04-07 ▲ 08-09 ▲	CK5594 CKF5594 ▲=CT027 ■=CT057SP	KTM SX 60 SX 65 SX 65 HUSQVARNA TC 65	98-00 ▲ 98-08 ▲ 09-15 ■ 17-21 ■
CK4517 ▲=CT016	KR 250 A1/A2	84-86 ▲	CK5595 CKF5595 ▲=CT007 ■=CT049	KTM 250 EGS 250 EXC (2T) EXC 250 (2T) Six Days 250 MXC SX 250 (2T) XC 250 (USD) XC 250 (2T) 250 SXS Reklus Aftermarket Clutch Kit SX 250/300 (2T) 24T Steel Plate Reklus Aftermarket Clutch Kit EXC 250/300 (2T) 24T Steel Plate EXC 300 (2T) 300 E-GS 300 EXC EXC 300 (2T) Six Days 300 MXC 300 Six Days SX 300 XC 300 (USD) 360 EGS 360 MXC 360 SXC 360 SX 360 Six Days 380 EXC SX 380 RXC-E 400 EXC-E 620	94-99 ▲ 94-12 ▲ 11-12 ▲ 98-99 ▲ 94-12 ▲ 11 ▲ 11-12 ▲ 01-03 ▲ 03-11 ■ 03-11 ■ 00-12 ▲ 94-99 ▲ 94-07 ▲ 11-12 ▲ 94-05 ▲ 96 ▲ 94 ▲ 11-12 ▲ 96-97 ▲ 96-01 ▲ 96-97 ▲ 96-97 ▲ 96 ▲ 98-02 ▲ 98-02 ▲ 95 ▲ 95 ▲
CK4518 ▲=CT021 ■=CT004	ZX 1400 A6F/A7F ZZR 1400 ABS (ZX 1400 B6F/B7F D8F/D9F/DAF/DBF) ZX 1400 Special Edition (ZX 1400 FCF/FDF/FDFA/FEF/FEFA/FFF/FFFA/HGF) ZZR 1400 Performance Sport (ZX1400 JGF) ZZR 1400 ABS Performance	06-07 ▲ 08-11 ▲ 12-16 ▲ 14-19 ■ 12-19 ■	CK5596 ▲=CT075	KTM 350 MX (2T) 350 Enduro (2T) 500 MX (2T) 500 MX (4T) LC 500 Enduro (2T) 500 Enduro (4T) LC 600 MX (4T) LC 600 Enduro (4T) LC	89 ▲ 89 ▲ 89 ▲ 89 ▲ 89 ▲ 89 ▲ 89 ▲ 89 ▲
CK4519 ▲=CT006	KXF 450 R (KSF 450 B8F/B9F/BAF /BFD/BEF/BBF/BCS)	07-14 ▲	CK5597 ■=CT009SP	TRIUMPH Bonneville (790cc) Speedmaster 800 (790cc) Bonneville T100	01-05 ■ 03-04 ■ 02-04 ■
CK4520 ▲=CT021	GTR 1400 (ZG 1400 A8F/A9F/CAF /CBF/CCF/CD/CE/EEF/EGF)	08-16 ▲			
CK4521 ▲=CT009	EX 250 K8F/K9F/KAF/KBF/KCF Ninja 250 R	08-12 ▲			
CK4522 ▲=CT012SP	KLX 125 CAF/CBF/CCF/CCS/CD/CF /CDS/CE/CF/CGF KLX 125 DAF/DBF/DCF/DDF/DEF D-Tracker KLX 150 L (KLX 150 EFF) KLX 150 D-Tracker (KLX150 HGF) KTM Duke 125 RC 125	10-16 ▲ 10-14 ▲ 14-15 ▲ 16 ▲ 11-19 ▲ 14-19 ▲			
CK4523 ▲=CT004	H2-B/H-C Mach IV (750cc)	74-75 ▲			
CK4524 ▲=CT009	EX 300 ADF/AEF/AFF Ninja 300 (Non ABS) EX300 AEFA/AFFA Ninja 300 Special Edition (Non-ABS) EX300 BDF/BEF/BFF/BGF Ninja 300 (ABS) EX300 BEFA/BFFA/BGFA Ninja 300 Special Edition (ABS) Versys-X 300 ABS Z 300 Non ABS (ER 300 AFF) Z 300 ABS (ER 300 BFF) - Ninja 300 (ABS)- Floating Disc Conversion	13-15 ▲ 13-15 ▲ 13-16 ▲ 13-16 ▲ 13-16 ▲ 17-20 ▲ 15 ▲ 15-16 ▲			
CK4527	KAWASAKI Ninja 650 (EX 650) Ninja 650 ABS (EX 650 ABS) Z 650 (ER 650) Z 650 ABS (ER 650 ABS)	12-18 12-18 12-18 12-18			
CK4528	KAWASAKI Ninja H2	15-20			
CK4529	KAWASAKI Ninja H2R	15-20			
CK4530	KAWASAKI Ninja 400 Z 400	17-21 17-21			

Part No.	Make/Model	Year	Part No.	Make/Model	Year
CK5598 ▲=CT034SP	APRILIA AF1 125 Classic 125 MX 125 Pegaso 125 Red Rose 125 RS 125 (2T) RX 125	87-91 ▲ 95-01 ▲ 04-06 ▲ 91-95 ▲ 87-94 ▲ 92-14 ▲ 92-98 ▲	CK5611 CKF5611 ▲=CT001	KTM 125 EGS 125 EXC EXC 125 EXC 125 (2T) Six Days 125 EXE SX 125 125 Supermoto 125 SXS SX 150 XC 150 (USD) 200 EGS 200 EXC 200 MXC SX 200 SX 125 XC-W 150 SX 125 HUSQVARNA TC125 TE125 TX 125	98-99 ▲ 98-05 ▲ 07-15 ▲ 11-15 ▲ 00-01 ▲ 98-18 ▲ 00-01 ▲ 01-02 ▲ 08-18 ▲ 11-12 ▲ 98-99 ▲ 97-14 ▲ 98-03 ▲ 03/06-07 ▲ 15-18 ▲ 17-18 ▲ 15-18 ▲ 14-18 14-16 17-18
CK5599 CKF5599 ▲=CT009	TRIUMPH Speed Triple (from VIN 141872 to 210444) Speed Triple 1050 Daytona (from VIN 132513) RS Sprint (from VIN 139277) ST Sprint (from VIN 138277) Sprint ST (From VIN 208167) Sprint GT 1050 Tiger 1050cc Tiger 1050cc SE	05-08 ▲ 01-06 ▲ 02-04 ▲ 02-04 ▲ 05-09 ▲ 10-12 07-12 ▲ 10-12 ▲	CK5612 CKF5612 ▲=CT023	KTM 250 EXC Racing 250 EXC-G Racing Freeride 250 R (2T) 400 EXC Racing 400 EXC-G Racing 400 EXC 400 SX Racing 400 MXC 450 EXC Racing 450 EXC-G Racing 450 LXC-G Racing 450 MXC-G Racing MXC 450 450 SMS SMR 450 SX 450 (4T) SX 450 XC 450 Quad 520 SX Racing 525 MXC Desert Racing 525 EXC-G Racing 525 EXC 525 EXC Racing 525 MXC Desert Racing 525 SMR 525 SX Racing MXC 525 SX 525 XC 525 (Quad) 540 SXS Racing SMR 560 SX-F 250 (4T) SX-F 250 Factory (4T) XC-F 250 (4T) XC-F 350	02-03/05 ▲ 03 ▲ 14-17 02/05-06 ▲ 02/05-06 ▲ 06-09 ▲ 02 ▲ 02 ▲ 03/05-07 ▲ 03 ▲ 05 ▲ 03 / 05 ▲ 06 ▲ 04 ▲ 04-07 ▲ 03-06 ▲ 06 ▲ 08-09 ▲ 02 ▲ 03 ▲ 03 / 05 ▲ 03 ▲ 05 ▲ 05 ▲ 04-05 ▲ 03 ▲ 06 ▲ 06 ▲ 08-12 ▲ 02 ▲ 06-07 ▲ 16-20 ▲ 16-20 ▲ 16-20 ▲ 16-20 ▲
CK5602 ▲=CT059 ■=CT023	KTM 250 EXC-G Racing 250 EXC Racing 400 EXC 400 MXC SX 400 450 EXC Racing 450 EXC-G Racing 450 MXC-G Racing 520 EXC SX 520 525 EXC Racing 525 EXC-G Racing 525 MXC Desert Racing 525 MXC-G Racing 525 SX Racing 526 SX Racing	04 ▲ 04 ▲ 00-02 ▲ 01 ▲ 00-01 ▲ 04 ▲ 04 ▲ 04 ▲ 00-01 ▲ 00-01 ▲ 04 ▲ 04 ▲ 04 ▲ 04 ▲ 04 ▲ 04 ▲ 05 ■	CK5604 ▲=CT026	APRILIA RS 50 RX 50 SX 50 DERBI GPR 50 Nude GPR 50 R GPR 50 Racing GPR 50 Replica Senda (Most models) 4 plate clutch	06-11 ▲ 06-10 ▲ 06-10 ▲ 04-05 ▲ 97-00 ▲ 04-05 ▲ 99-05 ▲ 99-05 ▲
CK5605	BMW F 650/93/97 (K60/0161/0162) F 650 (E169/0161 Standard) F 650 (E169/0162) (Funduro /High Screen) (19" front wheel) F 650 ST (K60/0163) F 650 ST (E169/0163/168) Strada (18" front wheel/low screen)	93-03 09/93-96 97-00 96-00 97-00	CK5624 ▲=CT021	TRIUMPH Rocket 111 (2300cc) Rocket 111 (Touring) (2300cc) Rocket 111 Classic Rocket 111 Roadster ABS Rocket 111 Touring	04-09 ▲ 08-12 ▲ 07-09 ▲ 10-12 ▲ 08-12 ▲
CK5608	TRIUMPH America (Cast wheel) Scrambler (865cc) Speedmaster (865cc) Bonneville T100 (865cc) Bonneville 800 Bonneville America Bonneville/Bonneville Black Bonneville - Steve McQueen SE Speedmaster 865cc Thrupton 900	07-09 06-09 03-09 01-09 01-04 02-06 07-08 12 03-08 04-12	CK5628 ▲=CT040SP	CCM 604 Trial/SM/RS/R30 (Rotax engine)	98-03
CK5610 ▲=CT028	KTM SX 85 (17"/14" Wheels) SX 85 (19"/16" Wheels) HUSQVARNA TC85 (F 17"/R 14") TC85 (F19"/R 16")	11-17 ▲ 03-17 ▲ 14-18 14-18	CK5631 CKF5631 ▲=CT030	KTM 350 EXC 350 Super Comp 380 EGS 400 Duke 400 EGS-E 400 EGS 400 EXC-E 400 EXC 400 LC-4	94 ▲ 94-95 ▲ 98-99 ▲ 94-95 ▲ 97 ▲ 94/96-97 ▲ 96-97 ▲ 94/96 ▲ 98 ▲

Part No.	Make/Model	Year	Part No.	Make/Model	Year			
CK5631 CKF5631 ▲=CT030 Contd.	400 LC4-E	00-01 ▲	CK5639 ▲=CT030	KTM	99 ▲			
	LC4 R 400	99 ▲		620 LC4 Super Moto	98 ▲			
	400 LSE	97 ▲		620 TXC	04-06 ▲			
	400 LS-E	4 ▲		625 SMC	03-04 ▲			
	400 Super Comp	95 ▲		625 SXC	98-02 ▲			
	400 Super Comp/EXC	96-99 ▲		640 Adventure-R	98 ▲			
	SXC 400	97 ▲		640 Duke-E	99-04 ▲			
	400 SX	99 ▲		640 Duke II	98 ▲			
	KTM			Duke-E 610	99-04 ▲			
	400 SX-C	98 ▲		Duke II 640	98 ▲			
	400 SXC	00 ▲		640 LC4	99-07 ▲			
	400 TXC	98 ▲		640 LC4 Adventure	99-00 ▲			
	540 SX-C	98-99 ▲		640 LC4 Supermoto	03-06 ▲			
	620 Duke	94/97 ▲		640 LC4 Supermoto	03-04 ▲			
	620 EGS	94-95 ▲		640 LC4-E	00-02 ▲			
	620 EGS-E	97 ▲		640 LC4 Six Days	99 ▲			
	620 EGS/Adventure	96-97 ▲		660 LC4 Rallye	99-00 ▲			
	620 Enduro Ltd	97 ▲		660 SM Factory Replica	02-03 ▲			
	620 EXC	94-95 ▲		660 SMC	03-04 ▲			
	620 LC-4	98 ▲						
	620 LC4 Competition	99 ▲		CK5641 ▲=CT030	KTM 690 Rally Factory Replica	07-09 ▲		
	620 LSE	97 ▲		CK5642 ▲=CT069	KTM 690 Duke 690 Duke R 690 Enduro 690 R Enduro 690 SMR 690 SM 690 SMC 690 SMC-R 690 SM-LE (Limited Edition)	08-18 ▲		
	620 RXC-E	96-97 ▲				10-11/13-18 ▲		
	620 SC	00-01 ▲				08-18 ▲		
	620 Six Days	96 ▲				08-18 ▲		
	620 Super Comp	94-95 ▲				09-18 ▲		
	620 Super Moto	98 ▲				07-11 ▲		
	SX 620	94 ▲				07-09 ▲		
	SXC 620	97 ▲				08-11 ▲		
	625 SC	02 ▲				12-18 ▲		
640 LC Rallye Dakar	97 ▲	10-11 ▲						
660 LC4	97 ▲	18-20 ▲						
660 SMS	04 ▲	18-20 ▲						
		16-20 ▲						
		16-20 ▲						
		18-20 ▲						
		18-20 ▲						
CK5632 ▲=CT075	EXC 400 (LC4 Engine)	93-95 ▲	CK5643 ▲=CT009			GAS-GAS EC 200/250/300 (2T) EC 450 FSR/FSE (4T) Enduro SM 450 FSR (4T) Supermotard Wild HP 450 Quad EC 515 FSR/FSE (4T) Enduro SM 515 FSR (4T) Supermotard	00-08 ▲	
	400 RXC-E	95 ▲		05-08 ▲				
	SC 400 (LC4 Engine)	95 ▲		07-08 ▲				
	620 RXC-E	95 ▲		04-08 ▲				
CK5633 ▲=CT030	KTM				05-08 ▲			
	660 Rallye	01-03 ▲		CK5644 ▲=CT021	KTM RC8 (1190cc) RC8 R Track (1190cc)		07-08 ▲	
	660 Rallye Factory	04 ▲					08-10 ▲	
CK5634 ▲=CT015	KTM			CK5648 CKF5648 ▲=CT041	KTM EXC 400 (4T) EXC-R 450 (4T) EXC 450 (4T) EXC 450 (4T) Six Days EXC 530 EXC 530 (4T) Six Days EXC-R 530		07-08 ▲	
		950 Adventure S					03-04 ▲	09-11 ▲
		950 Adventure					06 ▲	08 ▲
		950 Superenduro R					07-08 ▲	09-11 ▲
		990 Adventure/S					06-08 ▲	11 ▲
		990 Adventure Dakar Edition (ABS)					11 ▲	09-11 ▲
		990 Adventure R					09-12 ▲	11 ▲
		990 Adventure (ABS Model)					09-12 ▲	09-11 ▲
		990 Supermoto T (SM-T)					08-13 ▲	11 ▲
		990 Supermoto R (SM-R)					08-13 ▲	09-11 ▲
990 Superduke	05-11 ▲	11 ▲						
990 Superduke R	07-13 ▲	08 ▲						
CK5635 ▲=CT083	BMW		CK5651 CKF5651 ▲=CT023	HUSQVARNA FC 250 TC 250 TE 250 2T TE 250i 2T TE 300 2T TE 300i 2T TX 300i FC 350 FE 350 FX 350 FC 450 FC 450 FE 450 FS 450 FX 450 FE 501 FE 501 FE 501S	18-20 ▲			
		F 650 CS Scarver (K17/0177/0187 Belt drive/17" cast wheels)			04-07	14-17 ▲		
		F 650 GS (R13/0175/0185) Single cylinder/19" front wheel)			04-07	14-21 ▲		
		F 650 GS Dakar (R13/0176/0186) 21" front wheel			04-07	14-17 ▲		
		G 650 GS (R13)			08-16 ▲	18-21 ▲		
		G 650 GS Sertao (R13)			10-14 ▲	18-21 ▲		
G 650 XCountry (K15)	08-10 ▲	17-18 ▲						
CK5636	BMW			14-17 ▲				
		F 650 CS Scarver (K14/0174/0184 Belt drive/17" cast wheels)	00-03	14-17 ▲				
		F 650 GS (R13/0172/0182) 19" front wheel	99-03	14-17 ▲				
		F 650 GS Dakar (R13/0173/0183) 21" front wheel	99-03	17-18 ▲				
CK5638 ▲=CT009	KTM			14-17 ▲				
		SX-F 450	07-10 ▲	15-18 ▲				
		450 SX (Quad)	09-11 ▲	17				
		SX-F 505	07-09 ▲	14-16				
	505 SX-F (Quad)	09-12 ▲		17-21 ▲				
				16 ▲				

Part No.	Make/Model	Year	Part No.	Make/Model	Year	
CK5651 CKF5651 ▲=CT023 Contd.	KTM		CK5667 ▲=CT085	BMW		
	SX 250 (2T/Diaphragm Spring)	13-21 ▲		F800 GT (Early type plates 14mm ears)	04-06 ▲	
	SX-F 250 (4T/Coil Spring)	13-15 ▲		F800 GS (Early type plates 14mm ears)	08-11 ▲	
	EXC 250 (2T)	13-17 ▲		F800 S (Early type plates 14mm ears)	04-06 ▲	
	EXC 250 Tpi (2T)	18-21 ▲		F800 ST (Early type plates 14mm ears)	04-06 ▲	
	EXC 250 Six Days (2T/Diaphragm Spring)	13-15 ▲		CK5668 CKF5668 ▲=CT087SP	HUSQVARNA	
	EXC-F 250 (4T)	14-19 ▲			TC85	18 ▲
	EXC-F 250 Six Days (4T)	14-19 ▲		KTM		
	XC 250 (2T/Diaphragm Spring)	13 ▲		SX 85 (17 Inch/14 Inch Wheels)	18-20 ▲	
	XC-F 250 (4T/Coil Spring)	13-17 ▲		SX 85 (19 Inch/16 Inch Wheels)	18-20 ▲	
	EXC 300 Six Days (2T/Diaphragm Spring)	13-15 ▲		CK5669 ▲=CT086SP	KTM	
	EXC 300 Six Days (2T)	16-18 ▲			790 Duke	17-20
	350 Freeride (4T)	12-15 ▲			790 Adventure	17-20
	EXC-F 350 (Coil Spring)	11 ▲			890 Duke	21
	EXC-F 350 (4T/Diaphragm Spring)	12-17 ▲			890 Adventure	21
	EXC-F 350 Six Days (4T/Diaphragm Spring)	12-17 ▲			TRIUMPH	
	SX-F 350	11-15 ▲			Bonneville T100	
	SX-F 350	16-18 ▲			(900cc/Liquid Cooled/Spoke Wheel)	16-18 ▲
	XC-F 350	12 ▲			Bonneville T100 Black (900cc/Liquid Cooled/Spoke Wheel)	16-18 ▲
	XCF-W 350 (4T)	16 ▲			Street Cup (900cc Liquid Cooled)	16-20 ▲
	XCF-W 350 Six Days (4T)	16 ▲			Street Scrambler (900cc Liquid Cooled)	16-20 ▲
	EXC 450 (4T/Diaphragm Spring)	12 ▲			Street Twin (900cc Liquid Cooled)	16-18 ▲
	EXC 450 Six Days (4T/Diaphragm Spring)	12 ▲			Bonneville T120 (1200cc Liquid Cooled)	16-18 ▲
	EXC 450 Six Days (4T/Diaphragm Spring)	13-15 ▲			Bonneville T120 Black (1200cc Liquid Cooled)	16-18 ▲
	EXC-F 450 (4T/Diaphragm Spring)	12-16 ▲			Bonneville Bobber (1200cc Liquid Cooled)	17-20 ▲
	SX-F 450 (4T/Diaphragm Spring)	12-13 ▲			Bonneville Bobber Black (1200cc Liquid Cooled)	18-20 ▲
	SX-F 450 (4T/Diaphragm Spring)	13-17 ▲			Thruxton 1200 (Liquid Cooled)	16-20 ▲
	EXC 500 (4T/Diaphragm Spring)	12 ▲			Thruxton R 1200 (Liquid Cooled)	16-20 ▲
	EXC 500 (4T/Diaphragm Spring)	13-16 ▲				
	EXC 500 Six Days (4T/Diaphragm Spring)	12 ▲				
	EXC 500 Six Days (4T/Diaphragm Spring)	13-16 ▲				
	EXC-F 500	17 ▲				
XC-W 500	16 ▲					
CK5656	HUSQVARNA		CK5670	DUCATI		
	TC 450	02-07		959 Panigale	17-18	
	TE 450	02-07	CK5672	BETA		
	SMR 570	03-04		Enduro RR 250 2T	18-20	
	TC 570	03-04		Enduro RR 300 2T	18-20	
TE 570	03-04	Enduro RR 350 4T		18-20		
TE 610	05-12	Enduro RR 390 4T		18-20		
CK5657	HUSQVARNA			Enduro RR 430 4T	18-20	
	TC 250	03-08		Enduro RR 480 4T	18-20	
	TE 250 2T	03-09				
CK5658 ▲=CT085	HUSQVARNA		CK5674	HUSQVARNA		
	TC 250	03-08		TC 50	17-19	
CK5660 ▲=CT085	BMW			KTM		
	F650 GS (Late type plates 2 x 13mm/7 x 14mm ears)	07-17 ▲		SX 50	13-19	
	F700 GS (Late type plates 2 x 13mm/7 x 14mm ears)	11-17 ▲	CK5675	DUCATI		
	F800 GS (Late type plates 2 x 13mm/7 x 14mm ears)	12-19 ▲		Monster 620 IE	01-06	
	F800 GS Adventure (Late type plates 2 x 13mm /7 x 14mm ears)	12-19 ▲	CK5676	BMW		
	F800 GT (Late type plates 2 x 13mm /7 x 14mm ears)	07-19 ▲		R 1200 GS	13-18	
	F800 S (Late type plates 2 x 13mm /7 x 14mm ears)	07-19 ▲		R 1200 GS Adventure	13-18	
	F800 ST (Late type plates 2 x 13mm /7 x 14mm ears)	07-19 ▲		R 1200 R	13-18	
	F800 R (Late type plates 2 x 13mm /7 x 14mm ears)	05-19 ▲		R 1200 RS	14-18	
				R 1250 GS	19-20	
				R 1250 GS TE	19-20	
				R 1250 GS Rallye	19-20	
		R 1250 GS Rallye TE		19-20		
		R 1250 GS Adventure		19-20		
		R 1250 GS Adventure TE	19-20			
		R 1250 GS Adventure Rallye	19-20			
		R 1250 GS Adventure Rallye TE	19-20			
CK5664	TRIUMPH		CK5679	PIAGGIO VESPA		
	Daytona 675	13-		V 50	63-90	
Daytona 675 R	13-	SS 50		65-73		
CK5665	KTM			PK 50	82-93	
	Duke 390	13-14		PK 50 HP	82-93	
	RC 390	14-17		PK 50 S	82-93	
CK5666	KTM			PK 50 SS	82-93	
	EXC-F 450 (4T/Diaphragm Spring)	13-18		PK 50 XL	82-93	
	Duke 250	15-18		PK 80	82-86	
	RC 250	15-18		PK 80 S	82-86	
	Duke 390	15-17	SS 90	65-71		
RC 390	16-17	V 90	63-86			
			P 125 ETS	84-85		

Part No.	Make/Model	Year	Part No.	Make/Model	Year
CK5679 Contd.	PIAGGIO VESPA Contd. PL 125 S PK 125 XL PX 125 Primavera ET3 125	82-90 86-93 77-82 76-83	CK6603 Contd.	BMW Contd. R 75/7 R 80 R 80 TIC R 100 R 100/7T R 100 RS R 100 RT R 100 S	76-79 77-09/80 78-09/80 76-77 77-09/80 76-09/80 78-09/80 76-80
CK5681	TRIUMPH Tiger 800 XR (from VIN674842)	>18			
CK5682	BMW K 1300 GT K 1300 R K 1300 S	08-11 08-12 08-16	CK6604	BMW K 75 K 75/2 K 75 C K 75 RT K 75 S	84-96 84-96 85-88 89-96 85-95
CK5683	KTM 1050 Adventure 1090 Adventure 1090 Adventure L 1090 Adventure R 1090 Adventure S RC8R/Track (1190cc/3 Spring Clutch) 1190 Adventure 1190 Adventure R 1290 Super Adventure R 1290 Super Adventure S 1290 Super Adventure T 1290 Super Duke GT 1290 Super Duke R	15-16 17-18 19 17-19 19 13-14 13-16 13-16 17-21 17-21 17-21 17 17-19 16-19	CK6605	BMW K 100 K 100/2 K 100 LT K 100 RS K 100 RT (Valve models) K1 K 100 RS K 1100 LT K 1100 RS	82-88 87-90 86-91 83-89 83-89 88-93 89-92 89-99 92-96
	BMW F 750 GS F 850 GS F 850 GS Adventure	16-21 16-21 16-21	CK6680	APRILIA RSV 1000 Mille/R Mille RSV 1000 SP RSV 1000 R Factory RSV 1000 R RSV 1000 R Tuono SL 1000 Falco	00-02 99-00 04-08 04-08 02-06 00-04
CK6601	BMW R 45 R 45/N R 45 T R 45 T/N R 65 R 65 LS R 65 T R 65 GS R 65 RT R 80 GS R 80 ST R 80 R 80 RT R 80 TIC R 100/7 T R 100 CS R 100 RS R 80 R 80 RT R 80 GS R 80 PD/CH R 80 MYS R 80 R R 80 GS R 100 MYS R 100 R	09/80-85 09/80-85 09/80-85 09/80-85 09/80-85 81-85 80-85 87-92 85-88 80-87 82-84 09/80-84 82-84 09/80-85 09/80-84 80-84 09/80-84 84-95 84-95 87-90 90 94-95 91-94 96 93-96 91-95	CK6681 ▲=CT041	APRILIA RSV4R RSV4R Factory SBK Racing RSV4 Factory APRC RSV4R APRC	10 ▲ 09-10 ▲ 11-13 ▲ 11-13 ▲ ²
			CK7001	INDIAN Octane Scout Scout 1200 Scout Bobber Scout Sixty	17 15-20 17-20 18 16-20
CK6602	BMW R 100 GS R 100 PD R 45 R 45 R 45 N R 65	86-90 89-90 -09/80 78-09/80 -09/80 78-09/80	CK7002 CT702SP	HARLEY DAVIDSON FLHTCUTG Tri Glide Ultra Classic FLRT Freewheeler FLHTK 103 CVO Limited FLHTCUL Ultra Classic Low FLHTCUL TC Ultra Classic Low Twin-Cooled FLHTKL Ultra Limited Low FLHR Road King FLHRC Road King Classic FLHTCU Electra Glide Ultra Classic FLHTK Ultra Limited FLHTKL Ultra Limited Low FLHX Street Glide FLHXS Street Glide Special FLTRU Road Glide Ultra FLTRX Road Glide FLTRXS Road Glide Special FLHRXS Road King Special FLHTK Ultra Limited Shrine Edition FLHTK Ultra Limited Anniversary FLHX Street Glide Anniversary FLHXS Street Glide Special Anniversary FLSS Softail Slim S FLSTFBS Fat Boy S FLSS Slim S FLSTFBS Fat Boy S	14-16 15-16 14 15-16 15-16 15-16 17-20 17 17-20 17-20 17-20 17-20 17-20 17-20 17-20 17-20 17-20 17-20 17-20 18 18 18 18 18 16 16-17 17 17
CK6603	BMW R 50/5 R 60/5 R 60/6 R 75/5 R 75/6 R 90/6 R 90 S R 60/7 R 60 TIC	69-73 69-73 73-76 69-73 73-76 73-79 73-76 76-09/80 78-09/80	CK7003	INDIAN Chief Classic Chief Dark Horse Chief Vintage	14-20 16-20 14-20

Part No.	Make/Model	Year	Part No.	Make/Model	Year
CK7003 Contd.	INDIAN Contd.		CK7008 CT703SP Contd.	HARLEY DAVIDSON Contd.	
	Chieftain	14-18		FXSTS Springer Softail	98-03 ▲
	Chieftain Dark Horse	16-20		FLD 103 Dyna Switchback	12-16 ▲
	Chieftain Elite	17-20		FLHR 103 Road King	11-13 ▲
	Chieftain Limited	17-18		FLHR Road King	04-05 ▲
	Roadmaster	15-18		FLHR ANV Road King ANV	2013 ▲
	Roadmaster Classic	17-20		FLHRC 103 Road King Classic	11-13 ▲
	Roadmaster Elite	18-20		FLHRCI Road King Classic	04-05 ▲
	Springfield	16-20		FLHT Electra Glide Standard	04-05 ▲
	Springfield Dark Horse	18		FLHTC 103 Electra Glide Classic	11-13 ▲
CK7004	HARLEY DAVIDSON		FLHTC Electra Glide Classic	04-05 ▲	
	XG500	15-20	FLHTCI Ultra Classic	05 ▲	
XG750	15-20	FLHTCU 103 Ultra Classic	11-13 ▲		
CK7005 CT706SP	HARLEY DAVIDSON		FLHTCUI Ultra Classic	04 ▲	
	VRSCAW 1HFH V-Rod Wide Tire	08 ▲	FLHTI Electra Glide Standard	04-05 ▲	
	VRSCAWA 1HKH W/ABS	08 ▲	FLHTK Electra Glide Ultra Limited	10-13 ▲	
	VRSCD 1HDH Night Rod	08 ▲	FLHTK ANV Electra Glide Ultra Limited ANV	13 ▲	
	VRSCDA 1HLH Night Rod W/ABS	08 ▲	FLHX 103 Street Glide	11-13 ▲	
	VRSCDXA 1HMH Night Rod	08 ▲	FLS 103 Softail Slim	12-15 ▲	
	Special W/ABS	08 ▲	FLS Slim	17 ▲	
	VRSCDX 1HHH Night Rod Special	08-17 ▲	FLS Softail Slim	16 ▲	
	VRSCAW 1HFH V-Rod	09-10 ▲	FLSTC 103 Heritage Softail Classic	13-15 ▲	
	VRSCF 1HPH V-Rod Muscle	09-17 ▲	FLSTC 103 ANV Heritage Softail Classic ANV	13 ▲	
	VRSCDX ANV 1HHH_ANV		FLSTC Heritage Softail Classic	04-05 ▲	
	Night Rod Special Anv	12 ▲	FLSTC Heritage Softail Classic	16-17 ▲	
	CK7006 CT707SP	HARLEY DAVIDSON		FLSTCI Shrine Heritage Softail Classic Shrine	05 ▲
		VRSCA 1HAZ V-Rod	02-07 ▲	FLSTF 103 Fat Boy	12-15 ▲
		VRSCSE CVO V-Rod	05-06 ▲	FLSTF Fat Boy	04-05 ▲
VRXSE 7RC7 CVO VR Destroyer		06 ▲	FLSTF Fat Boy	16-17 ▲	
VRSCR 1HCZ Street Rod		06-07 ▲	FLSTFB 103 Fat Boy LO	12-17 ▲	
VRSCX 1HJG Screamin' Eagle V-Rod		07 ▲	FLSTFB 103 ANV Fat Boy LO ANV	13 ▲	
CK7007 CT708SP	HARLEY DAVIDSON		FLSTFI Shrine Fat Boy Shrine	05 ▲	
	FLHTCUTG Tri Glide Ultra	17-20 ▲	FLSTN 103 Softail Deluxe	12-15 ▲	
	FLRT Freewheeler	17-18 ▲	FLSTN Softail Deluxe	05 ▲	
	FLHTCUTG Tri Glide Ultra Anniversary	18 ▲	FLSTN Softail Deluxe	16-17 ▲	
	FLHP Road King Police	17 ▲	FLSTSC Springer Classic	05-06 ▲	
	FLHTP Electra Glide Standard Police	17 ▲	FLTRI Road Glide	04-05 ▲	
	FLFBS Fat Boy 114 Anniversary	18-20 ▲	FLTRU Road Glide Ultra	11-13 ▲	
	FLHCS Heritage Classic 114	18-20 ▲	FLTRX 103 Road Glide Custom	11-13 ▲	
	FLHCS Heritage Classic 114 Anniversary	18 ▲	FXD Dyna Super Glide	04-05 ▲	
	FXFBS Fat Bob 114	18 ▲	FXDB 103 Dyna Street Bob	14-16 ▲	
	FLFBS Fat Boy 114	18 ▲	FXDB 103 Dyna Street Bob 103	17 ▲	
	FXBRS Breakout 114	18-20 ▲	FXDBA 103 Dyna Street Bob (H-D1)	13-15 ▲	
	FXBRS Breakout 114 Anniversary	18 ▲	FXDBC 103 Dyna Street Bob Limited	16 ▲	
	CK7008 CT703SP	HARLEY DAVIDSON		FXDC 103 Dyna Super Glide Custom	14 ▲
		FLHR Road King	15-16 ▲	FXDC Dyna Super Glide Custom	05 ▲
FLHR Road King		98-03 ▲	FXDF 103 Dyna Fat Bob	12-17 ▲	
FLHRC Road King Classic		14-16 ▲	FXDI Dyna Super Glide	04-05 ▲	
FLHRCI Road King Classic		98-99 ▲	FXDL 103 Dyna Low Rider	14-16 ▲	
FLHT Electra Glide Standard		98-03 ▲	FXDL 103 Low Rider 103	17 ▲	
FLHTC Electra Glide Classic		98-03 ▲	FXDL Dyna Low Rider	04-05 ▲	
FLHTCU Ultra Classic		14-16 ▲	FXDWG 103 Dyna Wide Glide	12-16 ▲	
FLHTCU TC Ultra Classic Twin-Cooled		14-16 ▲	FXDWG 103 Dyna Wide Glide 103	17 ▲	
FLHTCUI Ultra Classic		98-03 ▲	FXDWGI Dyna Wide Glide	04-05 ▲	
FLHTK Ultra Limited		14-16 ▲	FXDX Dyna Super Glide Sport	04-05 ▲	
FLHX Street Glide		14-16 ▲	FXS 103 Blackline	11-13 ▲	
FLHXS Street Glide Special		14-16 ▲	FXSB 103 Softail Breakout	13-16 ▲	
FLSTC Heritage Softail Classic		98-03 ▲	FXSB Breakout	17 ▲	
FLSTF Fat Boy		98-03 ▲	FXST 1BH Softail Standard	04-06 ▲	
FLSTS Heritage Springer		98-03 ▲	FXST Softail Standard	12-15 ▲	
FLTR Road Glide		98-03 ▲	FXSTB Night Train	04-05 ▲	
FLTRU Road Glide Ultra		15-16 ▲	FXSTD Softail Deuce	04-05 ▲	
FLTRX Road Glide		15-16 ▲	FXSTS Springer Softail	04-05 ▲	
FLTRXS Road Glide Special		15-16 ▲	FLD Dyna Switchback	12-16 ▲	
FXD Dyna Super Glide		98-03 ▲	FLHR Road King	06-11 ▲	
FXDL Dyna Low Rider		98-03 ▲	FLHRC Road King Classic	06-11 ▲	
FXDS-CONV Dyna Glide Convertible		99-00 ▲	FLHRS Road King Custom	06-07 ▲	
FXDWG Dyna Wide Glide		98-05 ▲	FLHT Electra Glide Standard	06-10 ▲	
FXDX Dyna Super Glide Sport		99-03 ▲	FLHTC Electra Glide Classic	06-11 ▲	
FXDXT Dyna Super Glide T-Sport		01-03 ▲	FLHTCU Ultra Classic	06-11 ▲	
FXST Softail Standard		99-03 ▲	FLHX Street Glide	06-11 ▲	
FXSTB Night Train		99-03 ▲	FLS Softail Slim	12-15 ▲	
FXSTC Softail Custom		98-99 ▲	FLST Heritage Softail	06-09 ▲	
FXSTD Softail Deuce		00-03 ▲	FLSTC 103 Heritage Softail Classic	06-15 ▲	
FXSTI Softail Standard		01-03 ▲	FLSTC ANV Heritage Softail Classic ANV	13 ▲	
			FLSTF Fat Boy	06-15 ▲	
			FLSTFB Fat Boy LO	10-15 ▲	
			FLSTFB ANV Fat Boy LO ANV	13 ▲	
			FLSTN Softail Deluxe	06-15 ▲	
		FLSTSB Cross Bones	08-11 ▲		

Part No.	Make/Model	Year	Part No.	Make/Model	Year		
CK7008 CT703SP Contd.	HARLEY DAVIDSON Contd.		CK7010 CT705SP	HARLEY DAVIDSON			
	FLSTSC Springer Classic	06-07 ▲		FLH Electra Glide	84-88 ▲		
	FLTR Road Glide	06-09 ▲		FLH Electra Glide Shrine Shovelhead	84 ▲		
	FLTRX Road Glide Custom	10-11 ▲		FLHS Electra Glide Sport	84-89 ▲		
	FXCW Rocker	08-09 ▲		FLHT Electra Glide Classic	84-89 ▲		
	FXCWC Rocker C	08-11 ▲		FLHTCU Electra Glide Classic Ultra	89 ▲		
	FXD Dyna Super Glide	07-10 ▲		FLST Softail Heritage	86-89 ▲		
	FXD35 Dyna 35th Anniversary Super Glide	06 ▲		FLSTC Softail Heritage Classic	87-89 ▲		
	FXDB Dyna Street Bob	07-17 ▲		FLT Tour Glide Classic	84-89 ▲		
	FXDBC Dyna Street Bob Limited	16 ▲		FLT Tour Glide	84 ▲		
	FXDC ANV Dyna Super Glide Custom ANV	13 ▲		FLTCU Tour Glide Classic Ultra	89 ▲		
	FXDC Dyna Super Glide Custom	07-14 ▲		FXE Super Glide	84 ▲		
	FXDCI Dyna Super Glide Custom	06 ▲		FXEF Super Glide Fat Bob	85 ▲		
	FXDF Dyna Fat Bob	08-17 ▲		FXSB Low Rider	84-85 ▲		
	FXDI Dyna Super Glide	06 ▲		FXST Softail Standard	84-89 ▲		
	FXDL Dyna Low Rider	06-17 ▲		FXSTC Softail Custom	86-89 ▲		
	FXDWG Dyna Wide Glide	06-16 ▲		FXSTS Softail Springer	88-89 ▲		
	FXDWG ANV Dyna Wide Glide 105th Anniversary	08 ▲		FXSTS Softail Springer	88-89 ▲		
	FXSB Softail Breakout	13-15 ▲		FXWG Wide Glide	84-86 ▲		
	FXST Softail Standard	07-11 ▲					
	FXSTB Night Train	06-09 ▲		CK7011 CT704SP	HARLEY DAVIDSON		
	FXSTC Softail Custom	07-10 ▲		FLH Electra Glide	FLH Electra Glide	Early 84 ▲	
	FXSTD Softail Deuce	06-07 ▲		FLH Electra Glide Shrine Shovelhead	FLH Electra Glide Shrine Shovelhead	Early 84 ▲	
	FXSTS Springer Softail	06 ▲		FLHS Electra Glide Sport	FLHS Electra Glide Sport	Early 84 ▲	
	FLTCU Tour Glide Ultra Classic	91-95 ▲		FLHT Electra Glide	FLHT Electra Glide	Early 84 ▲	
	FLTCU Tour Glide Classic Ultra	90-96 ▲		FLHTC Electra Glide Classic	FLHTC Electra Glide Classic	Early 84 ▲	
				FLT Tour Glide Classic	FLT Tour Glide Classic	Early 84 ▲	
				FLT Tour Glide	FLT Tour Glide	Early 84 ▲	
	CK7009 CT701SP	HARLEY DAVIDSON			CK7012 CT704SP	HARLEY DAVIDSON	
		FLHR Road King		93-97 ▲	FLH Electra Glide Shrine Shovelhead	FLH Electra Glide Shrine Shovelhead	83 ▲
		FLHS Electra Glide Sport		90-94 ▲	FLH Electra Glide	FLH Electra Glide	81-83 ▲
		FLHT Electra Glide Standard		94-97 ▲	FLHC Electra Glide Classic	FLHC Electra Glide Classic	81-82 ▲
		FLHTC Electra Glide Classic		91-97 ▲	FLHC Electra Glide Classic	FLHC Electra Glide Classic	81 ▲
FLHTC Touring Electra Glide Classic		90 ▲	FLHS Electra Glide Sport	FLHS Electra Glide Sport	81-83 ▲		
FLHTCI Electra Glide Classic		96-97 ▲	FLHS Heritage Electra Glide	FLHS Heritage Electra Glide	81 ▲		
FLHTCU Ultra Classic		91-97 ▲	FLHT Electra Glide Standard	FLHT Electra Glide Standard	83 ▲		
FLST Softail Heritage		90 ▲	FLHT Electra Glide Classic	FLHT Electra Glide Classic	83 ▲		
FLSTC Heritage Softail Classic		91-97 ▲	FLHT Electra Glide	FLHT Electra Glide	83 ▲		
FLSTC Softail Heritage Classic		90 ▲	FLHTC Electra Glide Classic	FLHTC Electra Glide Classic	83 ▲		
FLSTF Fat Boy		91-97 ▲	FLT Tour Glide	FLT Tour Glide	81-83 ▲		
FLSTF Softail Fat Boy		90 ▲	FLT Tour Glide Classic	FLT Tour Glide Classic	80-83 ▲		
FLSTN Heritage Softail Nostalgia		93-96 ▲	FLT Tour Glide	FLT Tour Glide	81-83 ▲		
FLSTS Heritage Springer		97 ▲	FLT Tour Glide Classic	FLT Tour Glide Classic	80-83 ▲		
FLTC Tour Glide Classic		90-92 ▲	FXDG Dyna Glide Glide Custom	FXDG Dyna Glide Glide Custom	83 ▲		
FXD Dyna Super Glide		95-97 ▲	FXE Super Glide	FXE Super Glide	81-83 ▲		
FXDB Dyna Daytona		92 ▲	FXEF Super Glide Fat Bob	FXEF Super Glide Fat Bob	81 ▲		
FXDB Dyna Sturgis		91 ▲	FXSB Low Rider	FXSB Low Rider	83-84 ▲		
FXDC Super Glide Custom		92 ▲	FXST Softail Standard	FXST Softail Standard	EARLY 84 ▲		
FXDL Dyna Low Rider		93-97 ▲	FXWG Wide Glide	FXWG Wide Glide	81-84 ▲		
FXDS-CONV Dyna Glide Convertible		93 ▲					
FXDWG Dyna Wide Glide		93-97 ▲	CK7013 CT701SP	HARLEY DAVIDSON			
FXST Softail Standard		90 ▲	XR1200 1LA6 Sportster 1200	XR1200 1LA6 Sportster 1200	08-10 ▲		
FXSTC Softail Custom		90-97 ▲	XR1200X 1LD6 XR1200X	XR1200X 1LD6 XR1200X	10-13 ▲		
FXSTS Springer Softail		90-97 ▲					
XL1200 Sportster 1200		91-03 ▲	CK7014 CT709SP	HARLEY DAVIDSON			
XL1200 Forty Eight Anniversary		18 ▲	XL1200 Sportster 1200	XL1200 Sportster 1200	90		
XL1200C Sportster 1200 Custom		96-20 ▲	XL883 Sportster 883	XL883 Sportster 883	86-90		
XL1200C ANV Sportster			XL883 Sportster 883 Deluxe	XL883 Sportster 883 Deluxe	86-90		
1200 Custom Anniversary		13 ▲	XL883HUG Sportster 883 Hugger	XL883HUG Sportster 883 Hugger	87-90		
XL1200CA Sportster 1200 Custom Limited		13-17 ▲	XLH 1100 Sportster 1100	XLH 1100 Sportster 1100	86-87		
XL1200CP Sportster 1200 Custom (H-D1)		11-16 ▲	XLH Sportster 1000	XLH Sportster 1000	84-85		
XL1200CX 1200 Roadster		16-20 ▲	XLH883DLX Sportster 883 Hugger Deluxe	XLH883DLX Sportster 883 Hugger Deluxe	88-89		
XL1200L Sportster 1200 Low		06-11 ▲	XLS Sportster Roadster 1000	XLS Sportster Roadster 1000	84-85		
XL1200N Nightster		07-12 ▲	XR1000 Sportster	XR1000 Sportster	84		
XL1200R Sportster 1200 Roadster		04-09 ▲					
XL1200S Sportster 1200 Sport		96-03 ▲	CK7015 CT709SP	HARLEY DAVIDSON			
XL1200T SuperLow 1200T		14-20 ▲	XLH Sportster 1000	XLH Sportster 1000	79-84		
XL1200V Seventy-Two		12-16 ▲	XLH Sportster Standard 1000	XLH Sportster Standard 1000	71-80		
XL1200X Forty Eight		10-20 ▲	XLS Sportster Roadster 1000	XLS Sportster Roadster 1000	81-84		
XL50 50th Anniversary Sportster		07 ▲	XR1000 Sportster	XR1000 Sportster	83-84		
XL883 Sportster 883		91-09 ▲					
XL883C Sportster 883 Custom		98-10 ▲	CK7016	HARLEY DAVIDSON			
XL883DLX Sportster 883 Deluxe		91-95 ▲	XLCH-1000 4AH0 Sportster 1000	XLCH-1000 4AH0 Sportster 1000	70		
XL883HUG Sportster 883 Hugger		91-03 ▲	XLH-1000 3AH0 Sportster Standard	XLH-1000 3AH0 Sportster Standard	70		
XL883L Sportster 883 SuperLow		05-20 ▲					
XL883N Iron 883		09-20 ▲	CK7018	INDIAN			
XL883R 883 Roadster		11-15 ▲	FTR 1200	FTR 1200	19-21		
XL883R 883R Sportster		02-10 ▲					

DRC/DRCF CLUTCH KITS BUYERS GUIDE

Part No.	Make/Model	Year	Part No.	Make/Model	Year
DRC001 ■=CT012SP	HONDA CR 80 RF/R2F CR 80 RG/R2G CR 80 RH/RJ/RK/RL/RM/RN/RP/RR/RS /RT/RBT/RV/RBV/RW/RBW/RX/RBX /RY/RBY/R1/RB1/R2/RB2 CR 85 R3/RB3/R4/RB4/R5/RB5 /R6/RB6/R7/RB7	85 ■	DRC021 ▲=CT011	SUZUKI RM 125 G/H	86-87 ▲
		86 ■	DRC022 ▲=CT011	SUZUKI RM 125 J/K/L/M	88-91 ▲
		87-02 ■	DRC023	SUZUKI LT 250 RH/RJ/RK	87-90
		03-07 ■	DRC024 ▲=CT022	SUZUKI RM 250 J/K/L	88-90 ▲
DRC002 ▲=CT001	HONDA CR 125 RG/RH/RJ/RK/RL/RM/RN/RP /RR/RS/RT/RV/RW/RX	86-99 ▲	DRC025 DRCF025 ▲=CT011	SUZUKI RM 80 M/N/P/R/S/T/V/W/X/Y/K1 RM 85 Small Wheel (F 17" / R 14") RM 85 Big Wheel (F 19" / R16")	91-01 ▲ 02-20 ▲ 02-20 ▲
DRC003 ▲=CT009	HONDA CR 250 RD/RE/RF/RG/RH/RJ/RK CR 480 RD CR 500 RE/RG/RH/RJ/RK	83-89 ▲	DRC026 ▲=CT010	SUZUKI LT 500 RL/RM	90-91 ▲
		83 ▲	DRC027	YAMAHA YZ 80 S/T/U/W	86-89
DRC004 ■=CT012SP	HONDA TRX 200 D TRX 200 L/M Fourtrax TRX 200 SX TRX 250 EX1-EX8 (Sportrax 250 EX) TRX 250 X9/XA/XB TRX 250 V/W/X/Y/1/TM Recon TRX 250 EX1/2/3/4/5/6/7/8	91-97 ■	DRC028	YAMAHA YZ 125 S/T	86-87
		90-91 ■	DRC029	YAMAHA YZ 125 U	88
DRC005 ▲=CT013	HONDA TRX 250 RG/RH	86-87 ▲	DRC030	YAMAHA YZ 125 W/A	89-90
DRC006 ■=CT013SP	HONDA TRX 300 FWJ/K/L/T/V/W/X/Y/J /K/L/T/V/W/X/Y TRX 350 G/H/J/K/L/M/N TRX 400 FWS/T/V/W/X/Y TRX 450 ESW/ESX/ESY/ES1	88-00 ■	DRC031	YAMAHA YZ 250 U/W/A/B/D	88-92
		86-93 ■	DRCF032 ▲=CT060	YAMAHA YTZ 250 N/S (TRI Z) YZ 490 J/K/L/N/S/T/U	85-86 ▲ 82-88 ▲
		95-00 ■	DRC033 DRCF033 ▲=CT090SP	YAMAHA YFM 350 FWT/FWU/FWW/FWA /FWE Big Bear YFM 350 XD/XE/XF/XG/XH/XJ/XK /XL/XM/XN/XP/XR/XS YFM 350 ERD/ERE/ERF YFM 350 S/T/V/R-WV/RW /RX/RY/RZ Raptor	86-93 ▲ 92-04 ▲ 92-94 ▲ 04-10 ▲
		98-01 ■	DRC035 ▲=CT060	YAMAHA YZ 250 N/S/T	85-87 ▲
DRC007 ▲=CT070SP	KAWASAKI KX 60 A1/A2/B1-B19 SUZUKI RM 60 K3	83-03 ▲ 03 ▲	DRC036	KAWASAKI KX 125 H1/H2	90-91
DRC008 ▲=CT070SP	KAWASAKI KX 80 E3/G1/G2/J1/J2	85-87 ▲	DRC038	KAWASAKI KXT 250 B1/B2 (Tecate - 3 Wheel Model) KX 50 B1/B2	86-87 85-86
DRC009	KAWASAKI KX 80 L1 KX 100 N1	88	DRC039 ▲=CT011	YAMAHA YZ 125 B/D	91-92 ▲
		88	DRC040 ▲=CT022	SUZUKI RM 250 M	91 ▲
DRC010	KAWASAKI KX 80 L2/L3/R1-R7 KX 100 A1/A2/B1-B7	89-97	DRC041 ▲=CT006	KAWASAKI KX 250 H2 KDX 250 D1	91 ▲ 91-93 ▲
		89-97	DRC042 DRCF042 ▲=CT010	YAMAHA DT 125 R DT 125 RE DT 125 X TDR 125 (4GW/GX1/2/3/4) TZR 125 R/RR SDR 200 (2TV) WR 200 D/E/F	88-03 ▲ 04-07 ▲ 05-06 ▲ 93-03 ▲ 93-95 ▲ 87-89 ▲ 92-94 ▲
DRC011	KAWASAKI KX 125 D1/E1/E2 KDX 200 C3	85-87 88			
DRC013	KAWASAKI KX 125 F1/G1	88-89			
DRC015	KAWASAKI KX 250 E1/F1/G1	87-89			
DRC016	KAWASAKI KX 500 C1/D1 KX 500 E1-E16	87-88			
		89-04			
DRC017	KAWASAKI KX 250 H1	90			
DRC019	SUZUKI RM 80 XH/XJ	87-88			
DRC020 ▲=CT011	SUZUKI RM 80 K/L	89-90 ▲			

Part No.	Make/Model	Year	Part No.	Make/Model	Year
DRC042 DRCF042	YAMAHA Contd. YFS 200 B/F/G/H/J/K/L/M/N /P/R/S/T/V Blaster DT 230 R Lanza (4TP1/2)	91-06 ▲ 97-98 ▲	DRC057 ▲=CT008	YAMAHA TT 600 RE (5CH5) (Electric Start Only) XT 600 (Kick Start Only) XT 600 Z (Kick Start Only)	04 ▲ 84-87 ▲ 84-85 ▲
DRC043 DRCF043 ▲=CT008	YAMAHA YFZ 350 T/U/W/A/B/D/E/F/G/H/J/ K/L/M/N/P/R/S/T/V Banshee	87-09 ▲	DRC058 DRCF058 ▲=CT022	SUZUKI DR 250 SL/SM/SN/SEP/SER/SES (SJ44A) DR 350 SL/SM/SN/SP/SER/SES /SET/SEV/SEW/SEX QUADZILLA WK 300	90-95 ▲ 90-99 ▲ 06 ▲
DRC044 DRCF044 ■=CT013SP	HONDA XR 250 RG/RH/RJ/RK/RL/RM/RN /RP/RR/RS TRX 300 EX P/R/S/T/V/W/X/Y/1-8 TRX 300 X9 XR 350 RD/RE	86-95 ■ 93-08 ■ 09 ■ 83-84 ■	DRC059 ■=CT029SP	SUZUKI DR 650 RL/RM (SP41A) DR 650 RSEM/RSEN/RSEP (SP45A/B) DR 650 RSL/RSM (SP42A) DR 650 RUN/RN/RUP/RP (SP44A/B)	90-91 ■ 91-93 ■ 90-91 ■ 92-93 ■
DRC045 DRCF045 ▲=CT002	KAWASAKI KX 80 W1/W2/W3 KX 85 A1-A5/A6F/A7F/A8F/A9F /AAF/ABF/ACF/ADF/CEF/CFE/CGF/CHF KX 85 II B1-B5/B6F/B7F/B8F/B9F /BAF/BBF/BCF/BDF/DEF/DFE/DGF/DHF KX 100 C1/C2/C3 SUZUKI RM 100 K3	98-00 ▲ 01-17 ▲ 01-17 ▲ 98-00 ▲ 03 ▲	DRC060 ■=CT013SP	HONDA XR 200 R XL 250 RE/RF XLR 250 R Baja (5 Plate) (MD22) XR 250 RE/RF	84-85 ■ 84-85 ■ 84-85 ■ 84-85 ■
DRC046 DRCF046 ▲=CT016	KAWASAKI KX 250 J1/J2/K1-K5/L1-L4 KX 250 M1/M2/R1/R6F/R7F/R8F	92-02 ▲ 03-08 ▲	DRC061	KAWASAKI KDX 200 E1/E2/E3/E4/E5/E6	89-94
DRC048 ▲=CT022	SUZUKI RM 250 N/P	92-93 ▲	DRC062	KAWASAKI KDX 200 H1/H2/H3/H4/H5 KDX 220 R A4-A12/A6F KDX 220 SR	95-99 97-06
DRC049 DRCF049 ■=CT012SP	HONDA CRF 100 F4/F5/F6/R7/F8/F9 XR 100 RP/RR/RS/RT/RV/RW/RX /RY/R1/R2/R3	04-09 ■ 93-03 ■	DRC063	KAWASAKI KLR 250 D2-D22	84-05
DRC051	HONDA AX-1 (NX 250 J/K/R/R3)	89-94	DRC064 ▲=CT016	KAWASAKI KLE 500 A1-A12 KLE 500 B1P/B6F/B7F	91-04 ▲ 05-07 ▲
DRC052	SUZUKI RM 250 H	87	DRC065 ▲=CT016	KAWASAKI KLR 650 A1-A3 KL 650 B1/B2/B3 Tengai KLX 650 C1/C2/C3	87-89 ▲ 89-92 ▲ 93-97 ▲
DRC053 ■=CT013SP	HONDA XL 600 VH/VJ/VK/VM/VN/VP/VR /VT/VV/VW/VX Transalp	87-99 ■	DRC066 ▲=CT010	YAMAHA YZ 80 E/LC/LW/F	93-94 ▲
DRC054 DRCF054 ▲=CT009	HONDA NX 500 J/K/L/M/N/P/R/S/T/V /W/X Dominator XL 600 LMF/RMG/LMH XR 600 RF/RG/RH/RJ/RK/RL/RM /RP/RR/RS/RT/RV/RW/RX/RY FMX 650 5/6 FX 650 X/Y Vigor NX 650 J/K/L/M/N/P/R/S/T/V/W/X SLR 650 V/W XR 650 L	88-99 ▲ 85-87 ▲ 84-00 ▲ 05-08 ▲ 99-03 ▲ 88-02 ▲ 97-98 ▲ 93-12 ▲	DRC067 ▲=CT013	HONDA CR 125 RD/RE	83-84 ▲
DRC055 ▲=CT039	YAMAHA AG 200 E (3G x 6)	93 ▲	DRC068 ▲=CT001	HONDA CR 125 RF	85 ▲
DRC056 ▲=CT008	YAMAHA TT 350 A (3GJ) TT 350 (ITJ) XT 350	90-95 ▲ 85-89 ▲ 85-95 ▲	DRC069	KAWASAKI KX 125 J2	93
DRC057 ▲=CT008	YAMAHA TT 600 L (Kick Start Only) TT 600 N (59X) Frame # 59X 000101-59X 007852 (Kick Start Only) TT 600 W (2JT/3SW1) Frame # 59X 007853- (Kick Start Only) TT 600 K (Kick Start Only) TT 600 E (Electric Start Only) TT 600 R (5CH1) (Kick Start Only) TT 600 R (5CH2) (Kick Start Only) TT 600 R (5CH3/4) (Kick Start Only)	84 ▲ 85-88 ▲ 89-92 ▲ 93-96 ▲ 94-95 ▲ 97 ▲ 98-99 ▲ 00-02 ▲	DRC070 DRCF070 ▲=CT005	YAMAHA YZ 125 E/F/G YZ 125 J/K/L/M/N YZ 125 T/V/W/X/Y/Z/A/B/D/E/F/G	93-95 ▲ 97-01 ▲ 05-16 ▲
			DRC071	YAMAHA YZ 250 E/F/G/H/J/L	93-99
			DRC072 ▲=CT022	SUZUKI RM 250 R/S RMX 250 R/S/T/V/W RMX 250 ST/SV/SW/SX (SJ14A)	94-95 ▲ 94-98 ▲ 96-99 ▲
			DRC073 ▲=CT004	KAWASAKI KX 125 K4/K5/L1-L4	97-02 ▲
			DRC074	KAWASAKI KDX 200 C1/C2	86-87
			DRC075 ▲=CT009	HONDA CR 250 RL/RM/RN/RP CR 500 RL/RM/RN/RP/RR /RS/RT/RV/RW/RX/RY/R1	90-93 ▲ 90-01 ▲

Part No.	Make/Model	Year	Part No.	Make/Model	Year
DRC076S ▲=CT003	SUZUKI RM 125 P/R/S/T/V/W	93-96 ▲	DRC094 ▲=CT011	SUZUKI DR 200 G/H/J	86-89 ▲
DRC078 ▲=CT010	YAMAHA YZ 80 G/H/J/K/L/M/N	95-01 ▲	DRC095 ▲=CT016	SUZUKI RM 250 V/W/X/Y/K1/K2	97-02 ▲
DRC079 DRCF079 ▲=CT009	HONDA CR 250 RR/RS/RT/RV/RW/RXRY/R1-R7	94-07 ▲	DRC097	YAMAHA YZ 250 M/N	00-01
DRC080 ▲=CT016	SUZUKI RM 250 T	96 ▲	DRC098 DRCF098 ▲=CT070SP	KAWASAKI KX 65 A1/A2/A3/A4/A5/A6/A6F/A7F /A8F/A9F/AAF/ABF/ACF/ADF/AEF/AFF /AGF/AHF SUZUKI RM 65 K3/K4/K5	00-17 ▲ 03-05 ▲
DRC081 ▲=CT013	HONDA TRX 250 RJ/RK	88-89 ▲	DRC099 ▲=CT008	YAMAHA YZ 400 FK/FL WR 400 FK/FL/FM/FN	98-99 ▲ 98-01 ▲
DRC082 ▲=CT090SP	YAMAHA YFM 350 FWF/FWG/FWH/FWJ YFM 350 ERG YFM 350 UH/UJ YFM 400 FWE/FWF/FWG/FWH /FWJ/FWK Kodiak YFM 400 FPR/FPS Big Bear	94-97 ▲ 95 ▲ 96-97 ▲ 93-00 ▲ 03-04 ▲	DRC100 DRCF100 ▲=CT013	HONDA TRX 400 EX/EY/EXX/EYX/EX1-EX8 TRX 400 X9	99-08 ▲ 09 ▲
DRC083	KAWASAKI KX 125 J1	92	DRC101 DRCF101 ▲=CT001	HONDA CR 125 R4/R5/R6/R7	04-07 ▲
DRC084 ■=CT013SP	HONDA XR 250 RT/RV/RW/RX/RY/R1/R2/R3/R4 HONDA DALL ARA XR 250 R XR 250 RM	96-04 ■ 04 ■ 04 ■	DRC102 ▲=CT020	YAMAHA YZ 426 FM	00 ▲
DRC085 DRCF085 ▲=CT005	YAMAHA YZ 125 H (2T) YZ 125 P/R/S (2T)	96 ▲ 02-04 ▲	DRC103 ▲=CT011	SUZUKI LT-F 4WD X M/N/P/R/S/T/V/W 300 Quadrunner LT-F 300 FX/FY/FK1 ARCTIC CAT 300 (2 x 4/4 x 4) 300 (4 x 4)	91-98 ▲ 99-01 ▲ 98-04 ▲ 05 ▲
DRC087	SUZUKI DR 650 SET/SEV CCM R30 (644 Suzuki Engine) 644 DS/Supermoto	96-97 02-04 04	DRC104 ■=CT010SP	YAMAHA YTM 225 DRN YFB 250 D/E/F/G/H/J/K/FWF/FWG /FWH/FWJ/FWK/FWL/FWM YFM 250 W/A/B YFM 250 XN/XP/XR/XS Bear Tracker YFM 250 FN YFM 250 BT/BV Bruin YFM 250 BW/BX/BY Big Bear YFU1W/T YFU1W/TW Pro Hauler Pro 4 (230cc)	85 ■ 92-00 ■ 90-92 ■ 00-04 ■ 01 ■ 05-06 ■ 07-10 ■ 89-90 ■ 89 ■
DRC088 DRCF088 ▲=CT008	YAMAHA XT 600 Z (Kick & Electric Start) XT 600 E (Electric Start Only) SZR 660 XTZ 660 Tenere YFM 660 RN/RP/RR/RS/RT Raptor	86-90 ▲ 90-03 ▲ 96-97 ▲ 91-97 ▲ 01-05 ▲	DRC105 DRCF105 ▲=CT006	KAWASAKI KLX 400 R (KLX 400 B1/B2) KSF 400 A1/A2 (KFX 400) SUZUKI DR-Z 400 SY/EY/Y/SK1/EK1/K1 /SK2/EK2/K2/SK3/EK3/K3/SK4 /EK4/K4/EK5/SK5/K6/SK6/EK6 /SK7/EK7/K7/SK8/SK9 DR-Z 400 SMK5/SMK6/SMK7 /SMK8/SMK9 LT-Z 400 K3/K4 ARCTIC CAT 400 DVX CCM R35/R35S 404 E/DS/Supermoto CR 40 S Cafe Racer CR 40 Street	03-04 ▲ 03-04 ▲ 00-09 ▲ 05-09 ▲ 03-04 ▲ 04-06 ▲ 06-07 ▲ 03-04 ▲ 07 ▲ 07 ▲
DRC089 ▲=CT011	SUZUKI LT-F 250 J/K/L/M/N/P/R/S/T/V/W/Y/K1 LT-F4WDH/J/K/L/M/N/P/R/S/T/V/W LT 250 EFF/EFG LT-F 250 FX/FY/FK1/FK2 LT-F 300 J/K ARCTIC CAT 250 (2 x 4/4 x 4)	89-01 ▲ 87-98 ▲ 85-86 ▲ 99-02 ▲ 88-89 ▲ 01-05 ▲	DRC106 ▲=CT013	HONDA XR 400 RV/RW/RX/RY/R1-R5 HONDA DALL ARA XR 400/440 R XR 400/440 SM	97-05 ▲ 04 ▲ 04 ▲
DRC091 ■=CT012SP	HONDA CTX 200/CTX 200 A Bushlander XR 200 R XR 200 R XR 200 TLR 250 F	04-05 ■ 81-83 ■ 86-02 ■ 80-84 ■ 85- ■	DRC107 DRCF107 ▲=CT027	KTM SX 60 SX 65	98-00 98-08
DRC092 ▲=CT009	HONDA XL 600 RD/LD/RE/LE/RF/RG/RH	83-87 ▲			
DRC093 ▲=CT013	HONDA CRM 250 R (RK) MK1 MD24 (100001-1008385) CRM 250 R (RM) MK2 MD24 #(1200001-1211634) CRM 250 R (RP/RP-11) MK2/2 /MD24#(1300001-) XR 400 RT	89-90 ▲ 91-92 ▲ 93 ▲ 96 ▲			

Part No.	Make/Model	Year	Part No.	Make/Model	Year
DRC108 DRCF108 ▲=CT007	KTM SX 250 (2T) 250 EGS 250 EXC (2T) EXC 250 (2T) Six Days 250 MXC 250 SXS XC 250 (USD) XC 250 (2T) 300 EGS EXC 300 (2T) 300 EXC EXC 300 (2T) Six Days 300 MXC SX 300 300 Six Days XC 300 (USD) 360 EGS 360 EXC 360 MXC 360 SX 360 Six Days 380 EXC 380 MXC SX 380 RXC-E 400 RXC-E 620	94-12 ▲ 94-99 ▲ 94-12 ▲ 11-12 ▲ 98-99 ▲ 01-03 ▲ 11 ▲ 11-12 ▲ 94-99 ▲ 00-12 ▲ 94-07 ▲ 11-12 ▲ 94-05 ▲ 94 ▲ 96 ▲ 11-12 ▲ 96-97 ▲ 96-97 ▲ 96-97 ▲ 96-97 ▲ 96 ▲ 98-02 ▲ 98-01 ▲ 98-02 ▲ 95 ▲ 95 ▲	DRC120 SUZUKI LT-F 400 FK2-FK7 (Eiger 4WD) LT-F 400 FK8/FK9/FL0/FL1 King Quad 4WD LT-F 400 K3-K7 Eiger 2WD ARCTIC CAT 400 (2 x 4/4 x 4) 400 (4 x 4 Manual)	02-07 08-12 03-07 03-04 05-08	
			DRC121 ▲=CT020	YAMAHA YZ 450 FR/FS	03-04 ▲
			DRC122 ▲=CT004	KAWASAKI KX 125 M1/M2/M3/M6F/M7F/M8F	03-08 ▲
			DRC123 DRCF123 ▲=CT004	KAWASAKI KX 250 F (KX 250 N1/N2/T6F/T7F/T8F) KX 250 F (KX 250 W9F/XAFB/YBF/YCF /ZDF/ZEF/ZFF/ZGF/AHF) (4T) SUZUKI RM-Z 250 K4/K5/K6	04-08 ▲ 09-17 ▲ 04-06 ▲
			DRC126 ■=CT013SP	HONDA TRX 350 FMY/1-5 Fourtrax#Rancher/4x4	00-05 ■
			DRC127 ■=CT013SP	HONDA TRX 350 TE/FE Fourtrax #Rancher ES/ES 4x4 FEY/1-5	00-05 ■
DRC109 DRCF109 ▲=CT005	YAMAHA YZ 250 FN/FP/FR/FS/FT/FV/FW	01-07 ▲	DRC128 DRCF128 ▲=CT020	YAMAHA YFM 700 RV/RW/RA/R/RD/RE YFM 700 RSE	06-14 ▲ 13-14 ▲
DRC110 ▲=CT020	YAMAHA WR 426 FN/FP WR 450 FR	01-02 ▲ 03 ▲	DRC129 DRCF129 ▲=CT001	HONDA CRF 250 R4/R5/R6/R7	04-07 ▲
DRC111 DRCF111 ▲=CT010	YAMAHA YZ 85 (2T / Small Wheel F 17" / R 14") YZ 85 (2T / Big Wheel F 19" / R 16")	02-20 ▲ 02-20 ▲	DRC130 DRCF130 ▲=CT003	SUZUKI RM 125 K2/K3/K4/K5/K6/K7/K8/K9 RM 125 XCK8	02-12 ▲ 09 ▲
DRC112 ▲=CT009	HONDA CRF 450 R2/R3 CRF 450 R6/R7/R8	02-03 ▲ 06-08 ▲	DRC131 DRCF131 ▲=CT009	HONDA TRX 450 R4/R5/R6/ER6/R7/ER7 /R8/ER8/R9/ER9	04-09 ▲
DRC113 DRCF113 ▲=CT020	YAMAHA YZ 250 (2T)	02-20 ▲	DRC136 ▲=CT002SP	HONDA CRF 230 F4/F5/F6/F7/F8/F9	04-09 ▲
DRC114 ▲=CT003	SUZUKI RM 125 N	92 ▲	DRC137 DRCF137 ▲=CT006	KAWASAKI KSF 400 A3/A6F (KFX 400) SUZUKI LT-Z 400 K5/K6/K7/K8/K9 /L0/L1/L2/L3 QuadSport ARCTIC CAT 400 DVX	05-06 ▲ 05-15 ▲ 07-08 ▲
DRC115 ▲=CT003	SUZUKI RM 125 X/Y/K1	97-01 ▲	DRC139 ▲=CT028	KTM SX 85 (17"/14" Wheels) SX 85 (19"/16" Wheels)	03-17 ▲ 03-17 ▲
DRC116 ▲=CT020	YAMAHA YZ 426 FN/FP	01-02 ▲	DRC142 ■=CT029SP	SUZUKI DR 650 RER/RES (SP45A/B)	94-95 ■
DRC117 ▲=CT059	KTM 250 EXC Racing 250 EXC-G Racing 400 EXC 400 MXC SX 400 450 EXC-G Racing 450 EXC Racing 450 MXC-G Racing 520 EXC SX 520 525 EXC Racing 525 EXC-G Racing 525 MXC Desert Racing 525 MXC-G Racing 525 SX Racing	04 ▲ 04 ▲ 00-02 ▲ 01 ▲ 00-01 ▲ 04 ▲ 04 ▲ 04 ▲ 04 ▲ 00-01 ▲ 00-01 ▲ 04 ▲ 04 ▲ 04 ▲ 04 ▲ 04 ▲ 04 ▲ 04 ▲	DRC144 ▲=CT001	KTM SX 150 XC 50 (USD) 200 EGS 200 EXC 200 MXC SX 200	08-20 ▲ 11-13 ▲ 98-99 ▲ 97-14 ▲ 98-03 ▲ 03/06-07 ▲
DRC119 DRCF119 ▲=CT005	YAMAHA WR 250 FN/FP/FR/FS/FT/FV/FW /FX/FY/FZ/FA/FB/FD (4T)	01-13 ▲	DRC145 ▲=CT001	KTM 125 EGS 125 EXC 125 EXE 125 Supermoto SX 125 SX 125 (2T) 125 SXS	98-99 ▲ 98-05 ▲ 00-01 ▲ 00-01 ▲ 98-07 ▲ 09-14 ▲ 01-02 ▲

Part No.	Make/Model	Year	Part No.	Make/Model	Year
DRC148 DRCF148 ▲=CT009	HONDA CRF 450 R4/R5 CRF 450 X5/X6/X7/X8/X9 /XB/XC/XD/XF/XG/XH CRF 450 XRL (Road Legal)	04-05 ▲ 05-17 ▲ 14-16 ▲	DRC170 ▲=CT030 Contd.	400 LC-4 400 LC4-E LC4 R 400 400 LSE 400 LS-E 400 Super Comp/EXC 400 RXC-E SXC 400 400 SX-X 400 SX 400 SXC 400 TXC 620 Duke 620 EGS/Adventure 620 EGS-E 620 Enduro Ltd 620 LC-4 620 LSE 620 RXC-E 620 Six Days 620 SC SXC 620 640 LC Rallye Dakar 660 LC4	98 ▲ 00-01 ▲ 99 ▲ 97 ▲ 04 ▲ 96-99 ▲ 96-97 ▲ 97 ▲ 98 ▲ 99 ▲ 00 ▲ 98 ▲ 97 ▲ 96-97 ▲ 97 ▲ 97 ▲ 98 ▲ 97 ▲ 96-97 ▲ 96 ▲ 00-01 ▲ 97 ▲ 97 ▲ 97 ▲
DRC154 ▲=CT023	KTM 250 EXC Racing (2T) 400 EXC Racing 400 EXC-G Racing 450 EXC-G Racing 450 EXC Racing 450 MXC-G Racing 450 SMR SX 450 (4T) 525 EXC Racing 525 EXC-G Racing 525 MXC Desert Racing 525 SMR 525 SX Racing	05 ▲ 05 ▲ 05 ▲ 05 ▲ 05 ▲ 05 ▲ 04-05 ▲ 04-05 ▲ 05 ▲ 05 ▲ 05 ▲ 04-05 ▲ 05 ▲	DRC171 ▲=CT023	KTM 250 EXC-G Racing 250 EXC Racing 400 EXC Racing 400 EXC-G Racing 400 EXC 400 EXC-G Racing 400 MXC 400 SX Racing 450 EXC Racing 450 EXC-G Racing 450 EXC 450 MXC-G Racing MXC 450 SMR 450 SX 450 (4T) SX 450 (4T) XC 450 Quad (4T) 520 SX Racing 525 EXC-G Racing 525 EXC 525 MXC Desert Racing MXC 525 525 SX Racing SX 525 XC 525 (Quad) 540 SXS Racing SMR 560 SX-F 250 (4T) SX-F 250 Factory (4T) XC-F 250 (4T) XC-F 350	03 ▲ 02-03 ▲ 02 ▲ 02 ▲ 07-09 ▲ 06 ▲ 02 ▲ 02 ▲ 03 ▲ 03 ▲ 06-09 ▲ 03 ▲ 06 ▲ 06-07 ▲ 03 ▲ 06-09 ▲ 08-09 ▲ 02 ▲ 03 ▲ 03 ▲ 03 ▲ 06 ▲ 06 ▲ 08-12 ▲ 02 ▲ 06-07 ▲ 16-20 ▲ 16-20 ▲ 16-20 ▲ 16-20 ▲
DRC155 DRCF155 ▲=CT045	SUZUKI RMX 450 ZL0/ZL2 RM-Z 450 K5/K6/K7/K8/K9/L0/L1-L9	10-15 ▲ 05-19 ▲	DRC172	KTM 450 SMS	04
DRC158 DRCF158 ▲=CT006	KAWASAKI KX 450 F (D6F/D7F/D8F/E9F/EAFEBF) KLX 450 R (A8F/A9F/AAF/ABF/ACF /ADF/AEF/AFF/AGF)	06-11 ▲ 08-16 ▲	DRC173 ▲=CT075	KTM 350 MX (2T) 350 Enduro (2T) 500 MX (2T) 500 Enduro (2T) 500 Enduro (4T) C 500 MX (4T) LC 600 MX (4T) LC 600 Enduro (4T) C	89 ▲ 89 ▲ 89 ▲ 89 ▲ 89 ▲ 89 ▲ 89 ▲ 89 ▲
DRC159 DRCF159	YAMAHA YFZ 450 S/T/V Quad	04-06	DRC174 ▲=CT001	KTM EXC 125 EXC 125 (2T) Six Days SX 125	07-15 ▲ 11-15 ▲ 08 ▲
DRC160 ▲=CT016	SUZUKI RM 250 K6/K7/K8/K9 RM 250 XCK8	06-12 ▲ 09 ▲			
DRC161 ▲=CT016	SUZUKI RM 250 K3/K4/K5	03-05 ▲			
DRC162 ▲=CT020	YAMAHA YZ 450 FT/FV	05-06 ▲			
DRC163 DRCF163 ▲=CT001	KTM SX-F 250 (4T) EXC-F 250 (4T) EXC-F 250 (4T) Six Days XC-F 250 (USD) XC-F 250	05-12 ▲ 06-13 ▲ 11-12 ▲ 11-12 ▲ 12 ▲			
DRC164 DRCF164 ▲=CT045	SUZUKI LT-R 450 K6/K7/K8/K9/L0/L1	06-12 ▲			
DRC165 ▲=CT040SP	CCM 604 Trial/SM/RS/R30 (Rotax Engine)	98-03 ▲			
DRC168 ▲=CT016	KAWASAKI KLR 650 C1-C10 KLR 650 (KL 650 E8F/E9F)	95-04 ▲ 08-09 ▲			
DRC169 ▲=CT030	KTM 350 EXC 350 Super Comp 400 Duke 400 EGS 400 EXC 400 Super Comp 620 Duke 620 EGS 620 EXC 620 Super Comp SX 620	94 ▲ 94-95 ▲ 94-95 ▲ 94 ▲ 94 ▲ 95 ▲ 94 ▲ 94-95 ▲ 94-95 ▲ 94-95 ▲ 94-95 ▲ 94 ▲			
DRC170 ▲=CT030	KTM 380 EGS 400 EGS-E 400 EGS 400 EXC	98-99 ▲ 97 ▲ 96-97 ▲ 96 ▲			

Part No.	Make/Model	Year	Part No.	Make/Model	Year
DRC175 ▲=CT030	KTM 660 LC4 Rallye 660 SM Factory Replica 660 SMC	99-00 ▲ 02-03 ▲ 03-04 ▲	DRC196 ▲=CT030 Contd.	KTM Contd. Duke II 640 Duke II 640 640 LC4 640 LC4 640 LC4 Six Days 640 LC4-E 640 LC4 Adventure 640 LC4 Supermoto	99-02 ▲ 03-07 ▲ 99 ▲ 99-00 ▲ 99 ▲ 00-02 ▲ 03-06 ▲ 03-04 ▲
DRC176 ▲=CT030	KTM 660 Rallye 660 Rallye factory	01-03 ▲ 04 ▲	DRC199 ▲=CT030	KTM 690 Rally Factory Replica	07-09 ▲
DRC177 ▲=CT015	KTM 690 Duke R 690 SM-LE (Limited Edition) 950 Adventure S 950 Adventure 950 Superenduro R 990 Adventure/S 990 Adventure Dakar Edition (ABS) 990 Adventure R 990 Adventure (ABS Model) 990 Superduke 990 Superduke R 990 Supermoto T (SM-T) 990 Supermoto R (SM-R)	10-11 10-11 03-04 ▲ 06 ▲ 07-08 ▲ 06-08 ▲ 11 ▲ 09-12 ▲ 09-12 ▲ 05-11 ▲ 07-13 ▲ 08-13 ▲ 08-13 ▲	DRC200 DRCF200 ▲=CT005	YAMAHA YFM 250 RX/RV Raptor YFM 250 R (33B)	08-09 ▲ 09-11 ▲
DRC178 ▲=CT075	KTM EXC 400 (LC4 Engine) 400 RXC-E SC 400 (LC4 Engine) 620 RXC-E	93-95 ▲ 95 ▲ 95 ▲ 95 ▲	DRC201 DRCF201	YAMAHA YFZ 450 W/X Quad YFZ 450 RY/RZ (Quad)	07-08 09-10
DRC179 ▲=CT009	HONDA XR 650 RY/R1-R7	00-07 ▲	DRC205 ▲=CT069	HUSQVARNA Svartpilen 401 Vitpilen 401 701 Enduro R 701 Supermoto Svartpilen 701 Vitpilen 701 KTM 690 Duke 690 Duke R 690 Enduro 690 R Enduro 690 SMR 690 SMC 690 SMC-R 690 SM-LE (Limited Edition)	18-20 ▲ 18-20 ▲ 16-20 ▲ 16-20 ▲ 18-20 ▲ 18-20 ▲ 08-14 ▲ 10-11/13-14 ▲ 08-14 ▲ 09-14 ▲ 07-11 ▲ 08-11 ▲ 12-18 ▲ 10-11 ▲
DRC180 ■=CT012SP	HONDA CRF 150 F3/F4/F5	03-05 ■	DRC206 ▲=CT001	GAS-GAS EC 125 (2T) SM 125 (2T) Supermotard	00-08 ▲ 03-06 ▲
DRC181 ■=CT012SP	HONDA CRF 150 F6/F7	06-07 ■	DRC207 ▲=CT009	GAS-GAS EC200/250/300 (2T) EC 450 FSR/FSE (4T) Enduro SM 450 FSR (4T) Supermotard Wild HP 450 Quad EC 515 FSR/FSE (4T) Enduro SM 515 FSR (4T) Supermotard	00-08 ▲ 05-08 ▲ 07-08 ▲ 04-08 ▲ 05-08 ▲ 07-08 ▲
DRC182 DRCF182 ▲=CT002	HONDA CRF 150 R (Small Wheel F 17" / R 14") CRF 150 RB (Big Wheel F 19" / R 16")	07-20 ▲ 07-20 ▲	DRC208 DRCF208 ▲=CT001	HONDA CRF 250 R8-R9 CRF 250 X4/X5/X6/X7/X8/X9 /XB/XC/XD/XF/XG/XH CRF 250 XRL (Road Legal) CRF 250 RX	08-09 ▲ 04-17 ▲ 14-16 ▲ 18-20 ▲
DRC184 ▲=CT009	KTM SX-F 450 450 SX-F (Quad) SX-F 505 505 SX-F (Quad)	07-10 ▲ 09-11 ▲ 07-09 ▲ 09-12 ▲	DRC211 ▲=CT012SP	KAWASAKI KLX 125 CAF/CBF/CCF/CCS/CDF CDS/CEF/CFE/CGF KLX 125 DAF/DBF/DCF/DDF/DEF (D-Tracker) KLX 150 L (KLX 150 EFF) KLX 150 D-Tracker (KLX150 HGF)	10-16 ▲ 10-14 ▲ 14-15 ▲ 16 ▲
DRC185 ▲=CT006	KAWASAKI KFX 450 R Quad (KSF 450 B8F/B9F/BAF/BBF/BCS/BFD/BEF)	08-14 ▲	DRC212 ▲=CT042	KAWASAKI KLX 250 H6F/H7F KLX 250 S9F/SAF/SBF/SCF/SDF/SEF /SFF/SGF	06-07 ▲ 09-16 ▲
DRC189 DRCF189 ▲=CT004	SUZUKI RM-Z 250 K7/K8/K9	07-09 ▲	DRC214	ARCTIC CAT 400 (2 x 4) 500 (4 x 4)	98 98-02
DRC194 ▲=CT020	YAMAHA WR 450 FT/FV/FW/FX/FY/FZ /FA/FB/FD/FE/FF	05-15 ▲	DRC215	ARCTIC CAT 400 (2 x 4/4 x 4)	98-02
DRC195 DRCF195 ▲=CT020	YAMAHA YZ 450 FW/FX/FY/FZ/FA WR 450 GF (270mm F/Disc/4T)	07-11 ▲ 16 ▲			
DRC196 ▲=CT030	KTM 540 SX-C 620 LC4 Competition 620 LC4 Super Moto 620 Super Comp SX 620 620 Supermoto 620 TXC 625 SC 625 SMC 625 SXC 640 Adventure-R 640 Duke-E Duke-E 640	98-99 ▲ 99 ▲ 99 ▲ 96-99 ▲ 97-99 ▲ 98 ▲ 98 ▲ 03 ▲ 04-06 ▲ 03-04 ▲ 98-02 ▲ 98 ▲ 98 ▲			

Part No.	Make/Model	Year	Part No.	Make/Model	Year
DRC216 ▲=CT006	ARCTIC CAT Bearcat 454 (4 x 4) Bearcat 454 (2 x 4) 500 (4 x 4 Manual) 500 (Manual 4 x 4)	96-98 ▲ 97-98 ▲ 03-04 ▲ 05-09 ▲	DRC236 ■=CT013SP	HONDA TRX 500 FE5/FE6/FE7/FE8/FE9 /FEA Fourtrax Foreman 4WD-ES TRX 500 FE8/FE9 Fourtrax Foreman 4x4 EPS TRX 500 FPE8/FPE9/FPEA Fourtrax Foreman - Power Steering	05-10 ■ 08-09 ■ 08-10 ■
DRC217 ▲=CT006	SUZUKI LT-F 500 FW/FX/FY/FK1/FK2	98-02 ▲	DRC237 ■=CT013SP	HONDA TRX 500 FM5/FM6/FM7/FM8/FM9 /FMA Fourtrax Foreman 4WD TRX 500 TM5/TM6 Fourtrax Foreman	05-10 ■ 05-06 ■
DRC218 ▲=CT011	SUZUKI LT 160 EK/EL/EM/EN LT-F 160 L/M/N/P/R/S/T/V/W/X/Y/K1-K3 LT 160 K3/K4 QuadSport LT 230 GEF/GEG LT-F 230 G/H	89-92 ▲ 90-03 ▲ 03-04 ▲ 85-86 ▲ 86-87 ▲	DRC238 ■=CT013SP	HONDA TRX 420 FE7/FE8/FE9/FEA/FEB 4WD - Fourtrax ES TRX 420 TE7/TE8/TE9 Fourtrax ES - 2WD	07-11 ■ 07-09 ■
DRC220 ▲=CT011	SUZUKI LT-F 250 K2 Ozark (Up to F/No JSAAJ51A22100696)	02 ▲	DRC239 ■=CT013SP	HONDA TRX 420 FM7/FM8/FM9/FMA/FMB 4WD - Fourtrax TRX 420 FPM9/FPMA/FPMB Fourtrax - 4WW - Power Steering TRX 420 TM7/TM8/TM9/TMA/TMB Fourtrax 2WD	07-11 ■ 09-11 ■ 07-11 ■
DRC221 ▲=CT011	SUZUKI LT-F 250 K3 Ozark LT-F 250 K5-K9/L2-L4 Ozark	03 ▲ 05-14 ▲	DRC240 DRCF240 ▲=CT009	HONDA TRX 700 XX8/XX9/XXB	08-11 ▲
DRC222 ▲=CT011	SUZUKI LT-F 250 K4 Ozark LT-Z 250 K4/K5/K6/K7/K8/K9/L0 QuadSport	04 ▲ 04-12 ▲	DRC241 DRCF241 ▲=CT057SP	KTM SX 65 HUSQVARNA TC 65	09-15 ▲ 17-21 ▲
DRC223	SUZUKI LT-F 400 K2 (Eiger)	02	DRC244 DRCF244 ▲=CT009	HONDA CRF 450 R9/RA (4 spring type clutch)	09-10 ▲
DRC224	KAWASAKI KLF 220 A1-A15 KLF 250 A1/A2/A3/A6F/A78F/A8F /A9F/AAF/ABF (Bayou 250)	88-02 03-11	DRC247 ▲=CT034SP	APRILIA AF1 125 Classic 125 MX 125 Pegaso 125 Red Rose 125 (Cast Wheel) Red Rose 125 (Spoke Wheel) RS 125 (2T) RX 125 Tuono 125	87-91 ▲ 95-01 ▲ 04-06 ▲ 91-95 ▲ 87 ▲ 88-94 ▲ 92-14 ▲ 92-98 ▲ 03-04 ▲
DRC225 ▲=CT004	KAWASAKI KSF 250 A1-A18 (KXF 250 Mojave)	87-04 ▲	DRC249 ■=CT012SP	HONDA CRF 230 L CRF 230 M Supermoto	08-10 ■ 09-10 ■
DRC226 ▲=CT005	YAMAHA TT 250 RM (4PX6) WR 250 R WR 250 XX/XY (Supermoto/32D2/4)	00 ▲ 08-20 ▲ 08-10 ▲	DRC250 ▲=CT009	MONTESSA-HONDA 315R (2T)	97-04 ▲
DRC227 DRCF227 ▲=CT005	YAMAHA YZ 250 FX/FY/FZ/FB/FD (4T)	08-13 ▲	DRC252 ▲=CT041	KTM EXC 400 (4T) EXC-R 450 (4T) EXC 450 (4T) EXC 450 (4T) Six Days EXC 530 EXC 530 (4T) Six Days EXC-R 530	09-11 ▲ 08 ▲ 09-11 ▲ 11 ▲ 09-11 ▲ 11 ▲ 08 ▲
DRC228 ▲=CT008	YAMAHA YFM 350 FX Wolverine All models	95-04 ▲	DRC254 DRCF254 ▲=CT045	SUZUKI RM-Z 450 K5/K6/K7	05-07 ▲
DRC229 ▲=CT039	YAMAHA XT 225 (3RW4) Serrow (1KH 080101-) XT 225 W (4JG1/2/3/4) Serrow XT 225 WE (4JG5/6) Serrow ST 225 (5BT) Bronco	92 ▲ 93-96 ▲ 97-98 ▲ 97 ▲	DRC255 DRCF255 ▲=CT004	SUZUKI RM-Z 250 L0/L1/L2/L3/L4/L5/L6/L7/L8/L9	10-20 ▲
DRC230 DRCF230 ▲=CT044	YAMAHA TT-R 125 (All models)	00-20 ▲	DRC256 DRCF256 ▲=CT001	HONDA CRF 250 RA	10 ▲
DRC231 ▲=CT039	YAMAHA TW 200 (2JL/4CS1/2/3/5) TW 200 E (4CS4/6/5LB1/2) TW 225 E (5VC1/2) XT 225 (3RW1/2/4/5) Serrow (1KH-) XT 225 S (3RW3) (1KH- 202101-109000)	91-98 ▲ 98-01 ▲ 02-03 ▲ 89-93 ▲ 92 ▲			
DRC232 ■=CT010SP	YAMAHA YFM 200 DKW/DX/DXA	86-90 ■			
DRC233	KAWASAKI KEF 300 B1/B2 Lakota Sport KLF 300 A1/A2/B1-B17/C1-C17	01-02 87-05			
DRC234 ▲=CT006	KAWASAKI KLF 400 B1-B7	93-98 ▲			

Part No.	Make/Model	Year	Part No.	Make/Model	Year
DRC259 DRCF259 ▲=CT009	HONDA CRF 450 RB/RC	11-12 ▲	DRC275 ▲=CT023 Contd.	EXC 300 (2T) Diaphragm Spring EXC 300 (2T) Six Days EXC-F 350 (4T/Diaphragm Spring) EXC-F 350 Six Days (4T/Diaphragm Spring) EXC 450 (4T) Diaphragm Spring EXC 450 (4T) Six Days EXC-F 450 (4T/Diaphragm Spring) SX-F 450 (4T) Diaphragm Spring EXC-F 500 (4T) EXC-F 500 Six Days (4T) EXC 300 (2T) EXC 300 Six Days (2T)	13-15 ▲ 13-15 ▲ 18-20 ▲ 18-19 ▲ 13-15 ▲ 13-18 ▲ 18-19 ▲ 13 13-20 ▲ 13-20 ▲ 16-18 ▲ 16-18 ▲
DRC260 ▲=CT023 DRC260 ▲=CT023	KTM SX-F 250 (2T) Coil Spring XC-F 250 (4T) Coil Spring SX-F 350 (USD Forks) EXC-F 350 (USD Forks) XC-F 350 XCF-W 350 (2T) XCF-W 350 Six Days (2T)	13-15 ▲ 13 ▲ 11-20 ▲ 11 ▲ 12-13 ▲ 16 ▲ 16 ▲	DRC276 DRCF276 ▲=CT009	HONDA CRF 450 RD/RE/RF/RG (6 spring) CRF 450 RE (Limited Road Use)	13-16 ▲ 16 ▲
DRC261 DRCF261 ▲=CT001	HONDA CRF 250 R CRF 250 RE (Limited Road Use)	11-20 ▲ 16 ▲	DRC277 DRCF277 ■=CT081SP	HONDA CRF 250 L (Non ABS) / LA (ABS) CRF 250 ME Supermoto CRF 250 RL/RLA Rally (non ABS & ABS models) CBF 300 NA CBR 300 RA	13-20 ■ 14-15 ■ 17-20 ■ 18-19 ■ 14-19 ■
DRC262 DRCF262 ▲=CT001	HONDA CR 125 RY/R1/R2/R3	00-03 ▲	DRC280 ▲=CT013	SUZUKI DR-Z 250 K1-K7 (DJ43A)	01-07 ▲
DRC263 ▲=CT020	YAMAHA WR 450 FS	04 ▲	DRC281 ▲=CT023	KTM SX-F 450 (4T) Diaphragm Spring EXC-F 500 XC-W 500	14-20 ▲ 17 ▲ 16 ▲
DRC264 ▲=CT264	HUSQVARNA CR 125 SMS 125 WR 125 WRE 125	00-11 ▲ 00-11 ▲ 00-11 ▲ 00-11 ▲	DRC287 DRCF287 ▲=CT020	YAMAHA YZ 450 FE/FF (4T) YZ 450 FG (270mm Disc) YZ 450 FGY (60th Anniversary Edition/270mm Disc)	14-15 ▲ 16-20 ▲ 16-20 ▲
DRC265 ▲=CT008	YAMAHA YZ 400 FK/FL	98-99 ▲	DRC288 DRCF288 ▲=CT005 ■=CT020	YAMAHA YZ 250 FE/FF (4T) YZ 250 FG (270mm Disc) YZ 250 FGY (60th Anniversary Edition/270mm Disc)	14-15 ▲ 16-18 ■ 16 ■
DRC266 ▲=CT013	HONDA XR 400 R5/R6 Motard (NC38E) XR 400 M Supermotard (ND08/NC38E)	05-06 ▲ 06-08 ▲	DRC293 ▲=CT023	HUSQVARNA FC 250/FC 350 FX 350	14-20 ▲ 17-20 ▲
DRC267 ▲=CT009	XL 1000 VX/VY/V1/V2 Varadero Non ABS Model/10 Plate Kit	99-02 ▲	DRC296 ▲=CT023	HUSQVARNA FC 450 FC 450 Rockstar Edition	14-20 ▲ 20 ▲
DRC268 ▲=CT009	XL 1000 V3/V4/V5/V6/V7/V8/V9/VA/VB Varadero Non ABS Model/8 Plate Kit XL 1000 V6/VA6/VA7/VA8/VA9/VAA/VAB Varadero ABS Model/8 Plate Kit	03-11 ▲ 06-11 ▲	DRC297 ▲=CT011	SUZUKI LT-F 250 K2 Ozark (From F/No # JSAAJ51A22100697-	02 ▲
DRC269 DRCF269 ▲=CT006	KAWASAKI KX 450 F	12-20 ▲	DRC298 DRCF298 ▲=CT020	YAMAHA WR 450 FG/FH (270mm F/Disc/4T)	16-20 ▲
DRC270 ▲=CT013SP	HONDA TRX 500 FEC TRX 500 FPEC	12 ▲ 12 ▲	DRC299 DRCF299 ▲=CT092	HONDA CRF 450 RH (6 Spring Type) CRF 450 RXH (18" Rear Wheel) CRF 450 X	17-20 ▲ 17-20 ▲ 18-19 ▲
DRC271 ▲=CT013SP	HONDA TRX 500 FMC	12 ▲	DRC300 ▲=CT091	AJP PR5 250 Trials PR5 250 Supermoto PR5 250 Enduro PR5 250 Extreme	13-17 ▲ 13-17 ▲ 13-17 ▲ 13-17 ▲
DRC273 ▲=CT023	KTM EXC-F 350 Six Days EXC-F 350 (Diaphragm Spring) 350 Freeride EXC 450 EXC 450 (4T) Six Days EXC 450 Six Days EXC-F 450 (4T) SX-F 450 (4T) Diaphragm Spring EXC 500 EXC 500 Six Days EXC 500 (4T) EXC 500 (4T) Six Days Diaphragm Spring	12-18 ▲ 12-18 ▲ 12-15 ▲ 12 ▲ 12 ▲ 12 ▲ 12 ▲ 12 ▲ 12 ▲ 12 ▲ 12 ▲ 12 ▲ 12 ▲	DRC301 DRCF301 ▲=CT009	HONDA CRF 450 RD/RE/RF/RG (6 Spring type)	14-17 ▲
DRC274 ▲=CT011	SUZUKI DF 200 EV/EW/EY DR 200 SE Trojan DR 200 SEK1-SEK9 RV 200 K2/K3	97-99 ▲ ▲ 01-09 ▲ 02-03 ▲			
DRC275 ▲=CT023	KTM EXC 250 (2T) EXC 250 (2T) Six Days EXC-F 250 (4T) EXC-F 250 Six Days (4T) SX 250 (2T) Diaphragm Spring	13-20 ▲ 13-18 ▲ 14-20 ▲ 14-20 ▲ 13-20 ▲			

Part No.	Make/Model	Year	Part No.	Make/Model	Year
DRC303 DRCF303 ▲=CT001	KTM SX 125 XC-W 150	15-18 ▲ 17-18 ▲			
DRC304 DRCF304 ▲=CT087SP	HUSQVARNA TC85 KTM SX 85 (17 Inch/14 Inch Wheels) SX 85 (19 Inch/16 Inch Wheels)	18▲ 18-20▲ 18-20▲			
DRC306 DRCF306 ▲=CT009	HONDA CRF 1000 LAG (Manual Clutch/ABS) CRF 1000 L (Manual Clutch/Non ABS)	16-19 ▲ 16 ▲			
DRC311	METRAKIT GP50	All			
DRC313 DRCF313	YAMAHA YZ 250 F (4T)	16-20			
DRC315 DRCF315	YAMAHA YZ 250 F (4T)	19			
DRC320	KTM Duke 790 Adventure 790 Duke 890 Adventure 890	17-21 17-21 21 21			
DRC322	YAMAHA YFZ 450 R	14-21			
DRC333	BETA Enduro 400 RR Enduro 450 RR	10-15 10-15			
DRC335	HONDA CRF 250 F	19-21			
DRC336	KAWASAKI KX-F 250	21			
DRC337	KAWASAKI KX-F 450	21			

SRC CLUTCH KITS BUYERS GUIDE

Part No.	Make/Model	Year	Part No.	Make/Model	Year
SRC002	HONDA VF 750 FD/FE	83-85	SRC017 ▲=CT036SP	SUZUKI GSX 600 FN/FP/FR/FS/FT/FV GSXR 750 L/M/WN/WP/WR/WS	92-97 ▲ 90-95 ▲
SRC003 ▲=CT014	HONDA VFR 750 FG/FH/FJ/FL/FMFN/FP /FR/FS/FT/FV	86-97 ▲	SRC019 ▲=CT014 ●=CT014SP	HONDA CB 600 Hornet FW/FX/FY/F2-Y/ F1/F21/F2/F22/F3/F4/F5/F6 CBF 600 N4/N5/N6 (Non ABS) CBF 600 NA4/NA5/NA6 (ABS) CBF 600 S4/S5/S6 (Non ABS) CBF 600 SA4/SA5/SA6 (ABS) CBR 600 FM/FN/FP/FR/FS/FT/FV/FW CBR 900 RRY/RR1 (929cc Fireblade) CBR 900 RR2/RR3 (954cc) Fireblade	98-06 ● 04-06 ● 04-06 ● 04-06 ● 04-06 ● 91-98 ● 00-01 ▲ 02-03 ▲
SRC004 ■=CT009	HONDA CB 1000 FP/FR/FS/FT/FV CBR 1000 FH/FJ/FK/FL/FM/FN/FP /FR/FS/FT/FV/FW/FX	93-97 ■ 87-99 ■	SRC020 ▲=CT016	KAWASAKI ZL 900 A1/A2 Eliminator Z 1000 E1/E2 (ST-Shaft) GPz 1000 RX A1-A3 1000 GTR (ZG 1000 A1-A18) ZX 10 B1/B2/B3 ZL 1000 A1 GPz 1100 A1-A3 Z 1100 R1 Z 1100 A1-A3 Z 1100 D1/D2 Spectre ZR 1100 A1/A2/A3/A4/B1 ZRX 1100 (ZX 1100 C1/C2/C3/C4)	85-86 ▲ 79-80 ▲ 86-88 ▲ 86-03 ▲ 88-90 ▲ 87 ▲ 82-85 ▲ 84 ▲ 81-83 ▲ 82-83 ▲ 92-97 ▲ 97-00 ▲
SRC005 ▲=CT014	HONDA VFR 750 RJ/RK/RL (RC30)	88-92 ▲	SRC021 ▲=CT004	KAWASAKI ZXR 400 (ZX 400 L1-L5/L8/L9)	91-02 ▲
SRC006 ▲=CT010	YAMAHA FZR 400 RR (4DX) FZR 400 Genesis (1WG) FZR 400 (3EN1/3EN2) FZR 400 RR (3TJ1)	92 ▲ 86 ▲ 88-89 ▲ ▲	SRC022 ▲=CT016	KAWASAKI ZL 400 A Eliminator ZL 400 B Eliminator 400 SE ZZ-R 600 D1/D2/D2A/D3 650 Vulcan S (EN 650 AFF/AGF/Non ABS) 650 Vulcan S (EN 650 BFF/BGF/ ABS) ER-6f (EX 650 A6F/A7F/A8F/CF/CAF/CBF) ER-6f (ABS Model) (EX 650 B6F/B7F/B8F) ER-6f (ECF/EDS/EEFEFF) (Non ABS) ER-6f (FCF/FDS/FEF/FFF/FGF) (with ABS) ER-6n (ER 650 A6F/A7F/A8F) ER-6n (ABS) ER 650 B6F/B7F/B8F ER-6n (ECF/EDS/EEF/EFF) (non ABS) ER-6n (FCF/FDS/FEF/FFF/FGF) (with ABS) KLE 650 A7F/A8F/A9F/CAF/CBF /CCF/CDF Versys KLE 650 B7F/B8F/B9F/DAF/DBF /DCF/DDF Versys ABS	86-87 ▲ 88 ▲ 90-92 ▲ 15-16 ▲ 15-16 ▲ 06-08 ▲ 06-08 ▲ 12-15 ▲ 12-16 ▲ 06-11 ▲ 06-08 ▲ 12-15 ▲ 12-16 ▲ 07-13 ▲ 07-13 ▲
SRC007 ▲=CT010	YAMAHA FZR 400 RSP (2TK-EXUP) FZR 400 RRSF (3TJ2/6/7) FZR 600	87 ▲ ▲ 89-93 ▲	SRC024 ▲=CT016	KAWASAKI ZXR 750 J1/J2/L1-L3/P1-P7 ZXR 750 R (ZX 750 K1/K2/M1/M2)	91-03 ▲ 91-94 ▲
SRC008 ■=CT008	YAMAHA FZR 750 FZR 1000	87 ■ 87-88 ■	SRC025 ▲=CT021	KAWASAKI ZZ-R 1100 C1/C2/C2A/C3/D1-D9 ZX 1100 E1/E2/F1 ZZR 1200 C1H/C2H	90-01 ▲ 95-98 ▲ 02-04 ▲
SRC009 ■=CT008SP	YAMAHA FZR 750 R OW01 YZF 750 R/SP TDM 850 TRX 850	89-90 ■ 93-97 ■ 96-98 ■ 96-98 ■	SRC029 ■=CT008SP	YAMAHA FZR 1000 GTS 1000 YZF 1000 Thunder Ace	93-95 ■ 93-96 ■ 96-02 ■
SRC010 ▲=CT055SP	SUZUKI GSX 1100 GM/GN GSXR 1100 K/L/M/N	91-94 ▲ 89-92 ▲	SRC031 ■=CT008SP	YAMAHA FZR 1000	89-92 ■
SRC011 ▲=CT016	KAWASAKI Z 400 J1-J3 ZR 400 A1/B1 (Z 400 F) ZX 400 C2 (Z 400 F 11) EN 450 A1-A5 (Ltd 454) EN 500 A1/A2/A3/A4/B1/B2/C1-C9 ER-5 (ER 500 A1/A2/A3/A4/C1-C5P) EX 500 A1-A6/D1-D7 (GPz 500 S) GPZ 500 (S) (EX 500 B1-B5) GPZ 500 S (EX 500 E1-E10) Z 500 A1-A3/B1/B2 GT 550 G1-G9 GPz 550 D1/H1/H2/A1-A4 ZR 550 A1/A2 (Z 550 F) ZR 550 B2-B6 Zephyr Z 550 C1/C2 (Ltd) KL 600 A1 (KLR 600) KLR 600 B1/B2/B4/B6-B9 GPz 600 R A1-A6 GPX 600 R (C1-C3/C6-C7)	80-83 ▲ 83-84 ▲ 85 ▲ 86-89 ▲ 90-04 ▲ 97-07 ▲ 87-02 ▲ 88-93 ▲ 94-04 ▲ 79-81 ▲ 83-01 ▲ 81-87 ▲ 83-84 ▲ 91-99 ▲ 80-81 ▲ 84 ▲ 85-94 ▲ 85-89 ▲ 88-96 ▲	SRC033 ▲=CT054SP	YAMAHA YZF 600 Thunder Cat	96-03 ▲
SRC013 ▲=CT029	SUZUKI GSX 600 FJ/FK/FL/FM GSXR 750 F/G/H (GR75A)	88-91 ▲ 85-87 ▲	SRC034 ▲=CT010	YAMAHA FZR 250 FZR 250 R (3LN1/3/5/6/7) FZX 250 Zeal (3YX1/2/4)	87 ▲ ▲ 91-92 ▲
SRC014 ▲=CT036SP	SUZUKI GSXR 750 J/K	88-89 ▲			
SRC015 ▲=CT048SP	SUZUKI GSX R 1100 G/H/J	86-88 ▲			
SRC016 ▲=CT009SP	HONDA CBR 500 FH/FJ/FK/FL CBR 600 FH/FJ	87-90 ▲ 87-88 ▲			

Part No.	Make/Model	Year	Part No.	Make/Model	Year
SRC038 ▲=CT004	KAWASAKI ZX-6R F1/F2/F3 ZX-6R (ZX 600 J1/J2) ZX6R (ZX 636 A1P) 636cc ZX6R (ZX 636 B1/B2)	95-97 ▲	SRC048 ▲=CT009SP	HONDA CBX 550 FC/F2C/FD/F2D	82-85 ▲
		00-01 ▲	SRC049 ■=CT013SP	HONDA CBR 400 RRL/RRN/RRR (NC29)	90-94 ■
02 ▲	SRC050 ■=CT024SP	SUZUKI GS 1000 GT/GX GSX 1000 SZ GS 1100 GZ GSX 1100 ET/EX/EZ GSX 1100 SZ GSX 1100 EFE/EFG/ESF			
03-04 ▲	SUZUKI RF 900 RR GSXR 1100 WP/WR/WS/WT	94 ▲	SRC051 ■=CT008SP	YAMAHA YZF 600 R R6 (8 plate) FZ6 Naked/Non ABS 2 piston caliper (IB3/IB3D) FZ6-NS Naked/Non ABS (2 piston caliper) (IB35/6) FZ6-Fazer (Half Fairing/Non ABS) /2 piston caliper (5VX/5VXL) FZ6-Fazer (ABS/Half Fairing) /2 piston caliper FZ6 Fazer S2 (ABS/Half Fairing) /4 piston caliper FZ6 Fazer S2 (Non ABS/Half Fairing/4 piston caliper) FZ6 S2 (Naked/Non ABS) /4 piston caliper (5S51/5S5) FZX 700 S/SC/T/TC Fazer FZ 750	99-02 ■ 04-07 ■ 05-06 ■ 04-07 ■ 06-07 ■ 08 ■ 07-09 ■ 07-09 ■ 86-87 ■ 85-86 ■
93-96 ▲		SRC053 ▲=CT016			
SRC039 ▲=CT055SP	SUZUKI GSXR 750 T/V/W/X GS 1200 SSK/ZK1 (GV78A) GSF 1200 SAV ABS Bandit GSF 1200 K1/K2/K3/K4/K5 (Naked Bandit - 6 piston caliper) GSF 1200 SK1/SK2/SK3/SK4/SK5 (Faired Bandit) (6 piston caliper) GSF 1200 T/V/W/X/Y (Naked Bandit) piston caliper GSF 1200 ST/SV/SW/SX/SY (Faired Bandit) piston caliper GSX 1200 FSW/FSX Inazuma GSF 1200 K6/AK6 (Naked Bandit) (4 piston caliper) Non & Non ABS GSF 1200 SK6/SAK6 (Faired Bandit) (4 piston caliper) Non & Non ABS Version	96-99 ▲	SRC054 ▲=CT016	KAWASAKI Z 1000 R1/R2 (Eddie Lawson Replica) Z 1000 J1/J2/J3 Z 1000 K1/K2 LTD GPZ 1100 B1/B2	82-83 ▲ 81-83 ▲ 81-82 ▲ 81-82 ▲
SRC040 ▲=CT055SP		01 ▲			
97 ▲	01-05 ▲	96-00 ▲	SRC056 ▲=CT017	YAMAHA YZF R1 (4XV1/2)	98 ▲
01-05 ▲	96-00 ▲	SRC057 ▲=CT014			
98-99 ▲	98-99 ▲	98-99 ▲	SRC058 ■=CT055SP	SUZUKI GSXR 600 V/W/X/Y	97-00 ■
06 ▲	06 ▲	SRC059 ▲=CT004			
SRC041 ▲=CT016	KAWASAKI ZX7 RR (ZX 750 N1/N2) ZX-9R (ZX 900 B1-B4)	96-99 ▲ 94-97 ▲	SRC060	HONDA VTR 1000 FV/FW/FX/FY/F1-F6 Firestorm	97-06
SRC042 ▲=CT009	HONDA CBR 600 FK/FL	89-90 ▲	SRC061 ■=CT013SP	HONDA NT 400 Bros NC 25 NV 400 CJ/CK (Steed) NV 400 CS/CV Steed NV 400 DCY/DC1/DC2 (NC40) Shadow Slasher	92-93 ■ 95-97 ■ 00-02 ■
SRC043 ▲=CT016	KAWASAKI ZZR 600 (ZX 600 E1-E13) ZZR 600 (ZX 600 E6F)	93-05 ▲ 06-07 ▲			
SRC044 ▲=CT016	KAWASAKI ZR 400 Zephyr (G2/G3/G3A/G4/G5) GPX 600 R (C1-C3/C6-C7) ZL 600 B1	97-01 ▲ 88-96 ▲ 95-97 ▲			
SRC045 ▲=CT036SP	SUZUKI RF 600 RP/RR/RS/RT	93-96 ▲			
SRC046 ▲=CT016SP	KAWASAKI W 650 (EJ 650 A1/C3-C7) VN 700 A1 Vulcan VN 750 A2/A3/A4/A5/A10 Z 750 B1/B2 EJ 800 ABF/ACF (W 800/Solid F isc) EJ 800 (W 800 Cafe style/Cockpit fairing) EJ 800 ACFA (W 800 Special Edition Black Exhaust/Gold Rims EJ 800 ADF/AEF/AFF/AGF (W 800) EJ 800 ADFA/AEFA/AFFA/AGFA (W 800 Special Edition) VN 800 A1-A3/B1-B10/B6F VN 800 C1/C2/E1/E2/E3 Drifter W 800 AEFA W800 Special Edition GPZ 900 R (ZX 900 A12-15) VN 900 A6F Classic VN 900 Custom (Cast wheel) VN 900 Classic (Spoke wheel) VN 900 Classic Special Edition	99-05 ▲			
		85 ▲			
		86-94 ▲			
		77-78 ▲			
		11-12 ▲			
		11 ▲			
		12 ▲			
		13-16 ▲			
		13-16			
		95-06 ▲			
		99-04 ▲			
		14 ▲			
		99-02 ▲			
06 ▲					
07-20 ▲					
07-20 ▲					
11-20 ▲					
SRC047 ■=CT012SP	HONDA CB 250 FT/FV/FX/FY/F1 (MC31) Hornet CBR 250 FG/RH/RJ/RK/RK2 (MC14/17/19) CBR 250 RRL/RRN/RRR (MC22/100/105/110) VT 250 CR/CT/CV Magna (MC29) VTZ 250 H/J/K VTR 250 W/Y (MC33)/1-7	96-01 ■ 86-89 ■ 90-94 ■ 95-97 ■ 86-88 ■ 98-07 ■			

Part No.	Make/Model	Year	Part No.	Make/Model	Year
SRK062 ■=CT013SP	HONDA Contd. /VA8/VA/VAA Deauville NC 750 S NC 750 S (ABS) NC 750 X NC 750 X (ABS)	06-12 ■ 14-15 ■ 14-18 ■ 14-15 ■ 14-19 ■	SRC079 ▲=CT004	KAWASAKI ZX 10R (ZX 1000 C1/C2/D6F/D7F) ZX10R (ZX 1000 E8F/E9F/FAF/KBF /KCF/JBF/JCF/KDF/JDF/JEF/KEF/JFF/KFF) ZX10R 30th Anniversary Edition (ZX 1000 KFFA/ABS) ZX10R 30th Anniversary Edition (ZX 1000 JFFA/Non ABS) ZX 10R (ZX1000 SGF) ZX 10R Winter Test Edition (ZX1000 SGFB) ZX 10R Ninja KRT Replica (ZX1000 SGFA) ZX-10RR ZX-10RR Performance	04-07 ▲ 08-15 ▲ 15 ▲ 15 ▲ 16 ▲ 16 ▲ 16 ▲ 17-19 ▲ 17-19 ▲
SRC063 ▲=CT002	HONDA VFR 400 R3K/R3L/R3M/R3N (NC30)	89-92 ▲	SRC080 ■=CT009	HONDA CBR 1000 RR4/RR5/RR6/RR7 # Fireblade CB 1000 R9/RA/RB/RC/RD/RE/RF Non ABS Model CB 1000 RA9/RAA/RAB/RAC/RAE /RAF/RAG (ABS Model)	04-07 ■ 09-15 ■ 09-16 ■
SRC064 ■=CT013SP	HONDA NT 650 J/K/L (BROS) VT 750 CV/C2V/CW/C2W/CX/C2X /CY/C2Y/C1/C1Y/C4/C5/C6/C7/C8 VT 750 S (VT 50 SA/SB) XRV 650 J/K Africa Twin	88-92 ■ 97-09 ■ 10-12 ■ 88-89 ■	SRC081 ▲=CT022 ●=CT033SP	SUZUKI SV 400 N (VK53A) SV 400 SN (VK53A) SV 400 X/Y/K1/K2 SV 400 SX/SY/SK1/SK2 SV 650 A/Y/K1/K2 Naked - Non ABS SV 50 SX/SY/SK1/SK2 Top Fairing Non ABS	98 ● 98 ● 00-02 ● 00-02 ● 99-02 ▲ 99-02 ▲
SRC065	YAMAHA YZF R1 (4XV7/8 5JJ1/8 5PW1/7)	99-03	SRC082 ▲=CT033SP	SUZUKI SV 400 K3/K4/K5 SV 400 SK3/SK4/SK5 DL 650 K4-K6 V-Strom DL 650 AK7/AK8/AK9/ALO V-Strom ABS DL 650 AL1XP V-Strom Xpedition DL 650 AL2/AL3/AL4/AL5 V-Strom DL 650 AK9 GT V-Strom Traveller ABS DL 650 XT V-Strom SFV 650 K9/LO/L1/L2/L3/L4/L5 SFV 650 AK9/ALO/AL1/AL2/AL3/AL4/AL5 (ABS) SV 650 K3/K4/K5/K6/K7/K8/K9/LO Naked - Non ABS SV 650 AK7/AK8/AK9/ALO Naked - ABS SV 650 SAK7/SAK8/SAK9/SALO SV 650 SK3/SK4/SK5/SK6/SK7/SK8 /SK9/SLO Top Fairing - Non ABS SV 650 (ABS)	03-05 ▲ 03-05 ▲ 04-06 ▲ 07-11 ■ 11 ▲ 12-15 ▲ 09-11 ▲ 15-20 ▲ 09-15 ▲ 09-15 ▲ 03-10 ▲ 07-10 ▲ 07-15 ▲ 03-15 ▲ 16-20 ▲
SRC066 ▲=CT014	HONDA CBR 600 FX/FY (Carb Model)	99-00 ▲	SRC083 ▲=CT004	KAWASAKI ZX6RR (ZX 600 M1)	04 ▲
SRC067 ▲=CT021	SUZUKI GSX 1300 RX	99 ▲	SRC084 ▲=CT004	KAWASAKI ZX-6R (ZX 636 C1/C6F) ZX6RR (ZX 600 N1/N6F)	05-06 ▲ 05-06 ▲
SRC068 ▲=CT019	SUZUKI TL 1000 RW/RX/RV TL 1000 SX/SY	98-00 ▲ 99-00 ▲	SRC085 ▲=CT015	SUZUKI GSXR 1000 K5/K6/K7/K8 GSX-S 1000 L8 (Naked/Non ABS) GSX-S 1000 AL8 (Naked/ ABS) GSX-S 1000 FL8 (Faired/Non ABS) GSX-S 1000 FAL8 (Faired/ ABS) Katana	05-08 ▲ 18-20 ▲ 18-20 ▲ 18-20 ▲ 18-20 ▲ 18-20 ▲ 19-20 ▲
SRC070 ▲=CT056SP	HONDA ST 1100 AN/AP/AR/AS Pan European (ABS Model) ST 100 AT/AV/AW/AX/AY/A1/A2 Pan European (ABS model) ST 1100 L/M/N/P/R/S/T/V/W/X/Y Pan European - Non ABS	92-95 ▲ 96-02 ▲ 90-02 ▲	SRC086 ▲=CT015	SUZUKI GSXR 600 K6/K7	06-07 ▲
SRC071 ▲=CT014	SUZUKI GSXR 750 Y	00 ▲	SRC087 ■=CT008SP	YAMAHA YZF R6 (9 plate)	06-18 ■
SRC072 ▲=CT008	YAMAHA XT 550 SRX 600 SRX 600 (1JK/3SX)	83 ▲ 86-87 ▲ 85-91 ▲	SRC088 ▲=CT015	SUZUKI GSXR 600 K8/K9/LO GSXR 750 K6/K7/K8/K9/LO	08-10 ▲ 06-10 ▲
SRC074 ■=CT008SP	YAMAHA YZF-R6 (8 plate)	03-05 ■	SRC089 ▲=CT004	SUZUKI GSXR 1000 K1/K2/K3/K4 ZX9R (ZX 900 E1/E2/F1/F2) Z 1000 (ZR 1000 A1/A2/A3/A6F)	01-04 ▲ 00-03 ▲ 03-06 ▲
SRC075 ▲=CT014	HONDA CB 600 F7/F8/F9/FA/FB/FC Hornet CB 600 FA7/FA8/FA9/FAA/FAB/FAC Hornet CBF 600 N8/N9/NA (Non ABS) CBF 600 NA8/NA9/NA (ABS) CBF 600 S8/S9 (Non ABS) CBF 600 SA8/SA9/SAA (ABS) CBR 600 RR3-RRK CBR 600 RR Hannspree CBR 600 RA9-RAK (C-ABS) VFR 800 XA (Crossrunner/ABS) VFR 800 XA (Crossrunner/ABS)	07-13 ▲ 07-13 ▲ 08-11 ▲ 08-11 ▲ 08-09 ▲ 08-12 ▲ 03-19 ▲ 08 ▲ 09-19 ▲ 11-13 ▲ 15-16 ▲	SRC090	HONDA CRF 50 F	04-20
SRC076 ▲=CT004	KAWASAKI ZX6RR (ZX 600 K1)	03 ▲			
SRC077 ▲=CT020	YAMAHA FZ1 (Naked) (1000cc) (2D11) FZ-1 Fazer Non BS (1000cc) (3C3) FZ-1 Fazer (Half Fairing - ABS - 5D0) FZ1 N/NA Naked (Non ABS/ABS) YZF R1	06-09 ▲ 06-15 ▲ 08-15 ▲ 10-15 ▲ 04-06 ▲			
SRC078 ▲=CT014	SUZUKI GSXR 600 K4/K5	04-05 ▲			

Part No.	Make/Model	Year	Part No.	Make/Model	Year
SRC091	ELSTARS (Pit Bikes) Various models (Check parts before fitting)		SRC120 ▲=CT009	SUZUKI GSXR 1000 L2/L3/ZL3/L4/ZL4L5/AL5/AL6	12-16 ▲
SRC093 ▲=CT020	YAMAHA YZF R1SP YZF R1	06 ▲ 07-08 ▲	SRC121 ▲=CT014	SUZUKI GSXR 750 K4/K5	04-05 ▲
SRC094 ▲=CT014	HONDA CBR 900 RRN/RRP/RRR/RRS	92-95 ▲	SRC122 ▲=CT083SP	HONDA Monkey 125 MSX 125 D/E/F/G/H Grom (Non ABS) MSX 125 AH//AJ/AK Grom (ABS)	19-20 ▲ 13-20 ▲ 17-20 ▲
SRC095 ▲=CT043SP	HONDA CBR 1000 RR Fireblade (Diaphragm Type Clutch) CBR 1000 RR-SP ABS Fireblade (CBR1000 SAE/SAF/SAG) CBR 1000 RR-SP ABS - TT Edition	08-16 ▲ 14-16 ▲ 16 ▲	SRC124 ▲=CT020	YAMAHA MT-09 (1RC/Non ABS/847cc/3 Cyl Engine) MT-09 Tracer ABS (847cc/3 Cyl Engine) MT-09A (2DR/ABS/847cc/3 Cyl Engine) MT-09A Sport Tracker ABS (847cc/3 Cyl Engine) MT-09A Street Rally ABS (847cc/3 Cyl Engine)	14-16 ▲ 15-20 ▲ 14-20 ▲ 14-20 ▲ 14-20 ▲
SRC096 ▲=CT020	YAMAHA YZF R1	09-14 ▲	SRC125 ▲=CT020	YAMAHA MT-07 Non ABS (689cc/2 Cyl) MT-07A ABS (689cc/2 Cyl) MT-07 Motocage ABS (689cc/2 Cyl) XSR 700 ABS (MTM 690-U)	14-20 ▲ 14-20 ▲ 15 ▲ 16 ▲
SRC097 ▲=CT009	SUZUKI GSXR 1000 K9/L0/L1/L2	09-12 ▲	SRC126 ▲=CT020	YAMAHA FZ8 N-800cc (Naked/Single Headlight/Non ABS) FZ8 NA-800cc (Naked/Single Headlight/ABS) Fazer 8 S-800cc (Top Fairing/Twin Headlight/Non ABS) Fazer 8 SA-800cc (Top Fairing/Twin Headlight/ABS)	11-15 ▲ 11-15 ▲ 11-15 ▲ 11-15 ▲
SRC098 ▲=CT021	KTM RC8 (1190cc) RC8 R Track (1190cc)	08-10 ▲ 10-12 ▲	SRC127 ■=CT008SP	YAMAHA XJ6-N 600 (Naked - Non ABS & ABS Model - 20S) XJ6-F Diversion 600 (Full Fairing Diversion - Non ABS & ABS Models - 1CW) XJ6-S Diversion 600 (Top Fairing Diversion - Non ABS & ABS Models - 36C) XJ6-SP Diversion 600 (Non ABS & ABS Models)	09-15 ■ 10-15 ■ 09-15 ■ 13 ■
SRC099	YAMAHA XP 500 (T-Max Scooter - All models)	01-11	SRC128 ■=CT080	YAMAHA YZF-R3 (321cc/ABS) MTN 320 A (MT-03 321cc) MT-10 (998cc)	15-20 ■ 16 ■ 12-20 ■
SRC101 ▲=CT004	KAWASAKI ZX6R (ZX 600 P7F/P8F/R9F/RAF /RBF/RCF/RDF/REF/RFF/RGF) (599cc)	07-16 ▲	SRC129 ■=CT079SP	YAMAHA YZF- R1 YZF- R1 M YZF- R1 (60th Anniversary Edition) MT-10 (998cc)	15-20 ■ 15-20 ■ 16 ■ 16 ■
SRC103	HONDA VFR 1200 FA (Manual Gearbox Model)	10-15 ▲	SRC130 ▲=CT085	BMW F650 GS (Late type plates 2 x 13mm/7 x 14mm ears) F700 GS (Late type plates 2 x 13mm/7 x 14mm ears) F800 GS (Late type plates 2 x 13mm/7 x 14mm ears) F800 GS Adventure (Late type plates 2 x 13mm/7 x 14mm ears) F800 GT (Late type plates 2 x 13mm/7 x 14mm ears) F800 S (Late type plates 2 x 13mm/7 x 14mm ears) F800 ST (Late type plates 2 x 13mm/7 x 14mm ears) F800 R (Late type plates 2 x 13mm/7 x 14mm ears)	07-17 ▲ 11-17 ▲ 12-19 ▲ 12-19 ▲ 07-19 ▲ 07-19 ▲ 07-19 ▲ 07-19 ▲ 05-19 ▲
SRC110 ▲=CT015	SUZUKI GSX-R 600 GSX-R 750 GSX-S 750	11-20 ▲ 11-20 ▲ 15-20 ▲	SRC131 ▲=CT017	YAMAHA XT 1200 Z Super Tenere (ABS/UBS Brake System) XT 1200 ZE Super Tenere (ABS/UBS Brake System) FJR 1300 N/P FJR 1300 R/AR/S/AS/AT (ABS) FJR 1300 A (1CY/Manual G/Shift)	10-16 ▲ 14-16 ▲ 01-02 ▲ 03-05 ▲ 06-15 ▲
SRC111 ▲=CT014	SUZUKI GSXR 750 K1/K2/K3	01-03 ▲			
SRC112 ▲=CT014	SUZUKI GSXR 600 K1/K2/K3/ZK3	01-03 ▲			
SRC113 ▲=CT041	APRILIA RSV4 Factory SBK Racing RSV4 Factory APRC RSV4R RSV4R APRC	09-10 ▲ 11-13 ▲ 10 ▲ 11-13 ▲			
SRC115 ▲=CT035SP	SUZUKI GS 1000 HC/EC/EN/SN/ET	78-80 ▲			
SRC117	APRILIA ETV 1000 Caponord/Rally (PS00/PSB0) (Non ABS Models) ETV Caponord (PS004) (ABS Model)	01-03 04-08			
SRC118 ▲=CT009	KAWASAKI EX 300 ADF/AEF/AFF Ninja 300 (Non ABS) EX300 AEFA/AFFA Ninja 300 Special Edition (Non-ABS) EX300 BDF/BEF/BFF/BGF Ninja 300 (ABS) EX300 BEFA/BFFA/BGFA Ninja 300 Special Edition (ABS) Versys-X 300 ABS Z 300 Non ABS (ER 300 AFF) Z 300 ABS (ER 300 BFF)	13-15 ▲ 13-15 ▲ 13-16 ▲ 13-16 ▲ 17-20 ▲ 15 ▲ 15-16 ▲			
SRC119 ▲=CT012SP	HONDA CBR 125 RW7/RW8/RW9/RWA/RWB/RC/RD/RF	07-16 ▲			

Part No.	Make/Model	Year	Part No.	Make/Model	Year
SRC131 ▲=CT017	YAMAHA FJR 1300 AE (Electronic Suspension Adjustment/USD Forks) XVS 1300 A Midnight Star XVS 1300 CU Custom	14-15 ▲ 07-16 ▲ 14-16 ▲	SRC149 ▲=CT014	HONDA CB 650 F (Non ABS) CB 650 FA (ABS) CBR 650 F (Non ABS) CBR 650 FA (ABS)	14-20 ▲ 14-20 ▲ 14-20 ▲ 14-20 ▲
SRC133 ▲=CT009	SUZUKI GSX 1400 K2/K3/K4/K5/K6/K7	02-07 ▲	SRC150	KAWASAKI Z 750 (ZR 750 L9F/LAF/LAS) Z 750 ABS (ZR 750 M9F/MAF/MAS) Z 750 R Non ABS (ZR 750 NBF/NCF) Z 750 R Black Edition (ZR 750 NBFA) Z 750 R ABS (ZR 750 PBF/PCF) Z 800 ADS/AEF/AFF/AGF (Non ABS) Z 800 BDS/BEF/BFF/BGF (ABS Model) Z 800 E CDS/CEF/CFE/CGF (Non ABS) Z 800 E DDS/DEF/DFE/DGF (ABS Model)	09-10 09-10 11-12 12 11-12 13-16 13-16 13-16 13-16
SRC139	KTM 390 Duke RC 390	13-17 14-17	SRC151 ▲=CT013	BMW G 310 GS G 310 R	17-20 ▲ 17-20 ▲
SRC140	KTM Duke 250 RC 250 Duke 390 RC 390	15-19 15-18 15-17 16-17	SRC153	KTM Duke 200 RC 200	12-19 14-19
SRC141 ■=CT014SP	BENELLI Leoncino 500 Leoncino Trail 500 TRK 502 ABS Euro 4 TRK 502 X BN 600 GT BN 600 i BN 600 R BN 600 S	17-19 ▲ 18-19 ▲ 17-18 ▲ 18-19 ▲ 14-17 ■ 14-17 ■ 14-15 ■ 14-15 ■	SRC154	KTM Duke 125 RC 125	11-19 14-19
SRC142 ▲=CT009	SUZUKI GSXR 1000 ABS	17-20 ▲	SRC155	KAWASAKI Ninja 650 (EX 650) Ninja 650 ABS (EX 650 ABS) Z 650 (ER 650) Z 650 ABS (ER 650 ABS)	12-18 12-18 12-18 12-18
SRC143 ▲=CT014	HONDA GSXR 1000 AL7 CBR 600 FR1/FR2 (Rossi Injection Model) CBR 600 FS1/FS2 (CBR600 S Injection Model)	17 ▲ 01-02 ▲ 01-02 ▲	SRC160 ▲=CT008SP	YAMAHA YZF-R6	18-20 ▲
SRC144 ▲=CT085	BMW F800 GS (Early type plates 14mm ears) F800 GT (Early type plates 14mm ears) F800 S (Early type plates 14mm ears) F800 ST (Early type plates 14mm ears)	08-11 ▲ 04-06 ▲ 04-06 ▲ 04-06 ▲	SRC161	HONDA CB 1100 EX	16-19
SRC145 ▲=CT083	BMW G 650 GS (R13) G 650 GS Sertao (R13) G 650 XCountry (K15)	08-16 ▲ 10-14 ▲ 08-10 ▲	SRC162	YAMAHA XSR 900 ABS	18-20
SRC146 ▲=CT086SP	TRIUMPH Bonneville T120 (1200cc Liquid Cooled) Bonneville T120 Black (1200cc Liquid Cooled) Bonneville Bobber (1200cc Liquid Cooled) Bonneville Bobber Black (1200cc Liquid Cooled) Thruxton 1200 (Liquid Cooled) Thruxton R 1200 (Liquid Cooled)	16-18 ▲ 16-18 ▲ 17-20 ▲ 18-20 ▲ 16-20 ▲ 16-20 ▲	SRC163	KAWASAKI Ninja H2	15-20
SRC147 ▲=CT086SP	TRIUMPH Bonneville T100 (900cc/Liquid Cooled/Spoke Wheel) Bonneville T100 Black (900cc/Liquid Cooled/Spoke Wheel) Street Cup (900cc Liquid Cooled) Street Scrambler (900cc Liquid Cooled) Street Twin (900cc Liquid Cooled)	16-18 ▲ 16-18 ▲ 16-20 ▲ 16-20 ▲ 16-18 ▲	SRC164	KAWASAKI Ninja H2R	15-20
SRC148 ▲=CT011	SUZUKI GSX-R 125 GSX-S 125 GSX 150 L6/DZAL6 Gixxer GSX-R 150 RF-Q/RFX-Q GSX-R 150 GSX-S 150	18-20 ▲ 18-20 ▲ 16 ▲ 17-18 ▲ 18-20 ▲ 18-20 ▲	SRC165	BMW R 1200 GS R 1200 GS Adventure R 1200 R R 1200 RS R 1250 GS R 1250 GS TE R 1250 GS Rallye R 1250 GS Rallye TE R 1250 GS Adventure R 1250 GS Adventure TE R 1250 GS Adventure Rallye R 1250 GS Adventure Rallye TE	13-18 13-18 13-18 14-18 19-20 19-20 19-20 19-20 19-20 19-20 19-20 19-20 19-20
			SRC166 CT014	TRIUMPH Tiger 800 Tiger 800 XC Tiger 800 XR	11-12 11-12 2018-
			SRC167	KAWASAKI Ninja 400 Z 400	17-21 17-21
			SRC168	KTM 1050 Adventure 1090 Adventure 1090 Adventure L 1090 Adventure R	15-16 17-18 2019 17-19

Part No.	Make/Model	Year	Part No.	Make/Model	Year
SRC168 Contd.	KTM Contd.		SRC7008 ▲=CT708SP	HARLEY DAVIDSON	
	1090 Adventure S	2019		FLFBS Fat Boy 114	18 ▲
	1190 Adventure	13-16		FLFBS Fat Boy 114 Anniversary	18-20 ▲
	1190 Adventure R	13-16		FLFBS Fat Boy 114 Anniversary	18 ▲
	1290 Super Adventure	13-16		FLHCS Heritage Classic 114	18-20 ▲
1290 Super Adventure R	17-21	FLHCS Heritage Classic 114 Anniversary	18 ▲		
1290 Super Adventure S	17-21	FLHP Road King Police	17 ▲		
1290 Super Adventure T	17	FLHTCUTG Tri Glide Ultra	17-20 ▲		
			FLHTCUTG Tri Glide Ultra Anniversary	18 ▲	
			FLHTP Electra Glide Standard Police	17 ▲	
			FLRT Freewheeler	17-18 ▲	
			FXBRS Breakout 114	18-20 ▲	
			FXBRS Breakout 114 Anniversary	18 ▲	
			FXFBS Fat Bob 114	18 ▲	
SRC169	SUZUKI GSX-S 750	15-21	SRC7009 ▲=CT703SP	HARLEY DAVIDSON	
SRC170	BMW			FLHP Road King Police	11-16 ▲
	F 750 GS	16-21		FLHPE Road King Police	11 ▲
	F 850 GS	16-21		FLHTCUTG Tri Glide Ultra Classic	09-13 ▲
F 850 GS Adventure	16-21	FLHTCUTG ANV Tri Glide Ultra Classic Anv		13 ▲	
SRC7001	INDIAN Octane Scout Scout Sixty	17 15-16 16-17	FLHTP Electra Glide Standard Police	11-16 ▲	
			FLHXXX Street Glide Trike	10-11 ▲	
			FXDLS Dyna Low Rider S	16-20 ▲	
SRC7002	INDIAN Scout Scout 1200 Scout Bobber Scout Sixty	17-20 17-20 18 17-20	SRC7010 ▲=CT702SP	HARLEY DAVIDSON	
SRC7003 ▲=CT702SP	FLHTCUTG Tri Glide Ultra Classic	14-16 ▲		FLHR Road King	17-20 ▲
	FLRT Freewheeler	15-16 ▲		FLHRC Road King Classic	17 ▲
	FLHTK 103 CVO Limited	14 ▲		FLHRXS Road King Special	18 ▲
	FLHTCUL Ultra Classic Low	15-16 ▲		FLHTCU Electra Glide Ultra Classic	17-20 ▲
	FLHTCUL TC Ultra Classic Low Twin-Cooled	15-16 ▲	FLHTK Ultra Limited	17-20 ▲	
	FLHTKL Ultra Limited Low	15-16 ▲	FLHTK Ultra Limited Shrine Edition	18 ▲	
	FLSS Softail Slim S	16 ▲	FLHTK Ultra Limited Anniversary	18 ▲	
	FLSTFBS Fat Boy S	16-17 ▲	FLHTKL Ultra Limited Low	17-20 ▲	
	FLSS Slim S	17 ▲	FLHX Street Glide	17-20 ▲	
	FLSTFBS Fat Boy S	17 ▲	FLHX Street Glide Anniversary	18 ▲	
			FLHXS Street Glide Special	17-20 ▲	
			FLHXS Street Glide Special Anniversary	18 ▲	
			FLTRU Road Glide Ultra	17-20 ▲	
			FLTRX Road Glide	17-20 ▲	
			FLTRXS Road Glide Special	17-20 ▲	
SRC7004	INDIAN Chief Classic Chief Dark Horse Chief Vintage Chieftain Chieftain Dark Horse Chieftain Elite Chieftain Limited Roadmaster Roadmaster Classic Roadmaster Elite Springfield Springfield Dark Horse	14-20 16-20 14-20 14-18 16-20 17-20 17-18 15-18 17-20 18-20 16-20 18	SRC7011 ▲=CT703SP	HARLEY DAVIDSON	
SRC7005	HARLEY DAVIDSON			FLHR Road King	15-16 ▲
	XG500	15-20		FLHR Road King	98-03 ▲
XG750	15-20	FLHRC Road King Classic		14-16 ▲	
SRC7006 ▲=CT706SP	VRSCAW V-Rod Wide Tire	08 ▲		FLHRCI Road King Classic	98-99 ▲
	VRSCAWA W/ABS	08 ▲	FLHT Electra Glide Standard	98-03 ▲	
	VRSCD Night Rod	08 ▲	FLHTC Electra Glide Classic	98-03 ▲	
	VRSCDA Night Rod W/ABS	08 ▲	FLHTCU Ultra Classic	14-16 ▲	
	VRSCDXA Night Rod Special W/ABS	08 ▲	FLHTCU TC Ultra Classic Twin-Cooled	14-16 ▲	
	VRSCDX Night Rod Special	08-17 ▲	FLHTCUI Ultra Classic	98-03 ▲	
	VRSCAW V-Rod	09-10 ▲	FLHTK Ultra Limited	14-16 ▲	
	VRSCF V-Rod Muscle	09-17 ▲	FLHX Street Glide	14-16 ▲	
	VRSCDX ANV Night Rod Special Anv	12 ▲	FLHXS Street Glide Special	14-16 ▲	
	SRC7007 ▲=CT707SP	HARLEY DAVIDSON		FLSTC Heritage Softail Classic	98-03 ▲
		VRSCA V-Rod	02-06 ▲	FLSTF Fat Boy	98-03 ▲
		VRSCAW V-Rod	07 ▲	FLSTS Heritage Springer	98-03 ▲
		VRSCB V-Rod	04-05 ▲	FLTR Road Glide	98-03 ▲
		VRSCR Street Rod	06-07 ▲	FLTRU Road Glide Ultra	15-16 ▲
VRSCSE CVO V-Rod		05 ▲	FLTRX Road Glide	15-16 ▲	
VRSCSE2 CVO V-Rod		06 ▲	FLTRXS Road Glide Special	15-16 ▲	
VRSCX Screamin' Eagle V-Rod		07 ▲	FXD Dyna Super Glide	98-03 ▲	
VRXSE CVO VR Destroyer		06 ▲	FXDL Dyna Low Rider	98-03 ▲	
			FXDS-CONV Dyna Glide Convertible	99-00 ▲	
		FXDWG Dyna Wide Glide	98-05 ▲		
		FXDX Dyna Super Glide Sport	99-03 ▲		
		FXDXT Dyna Super Glide T-Sport	01-03 ▲		
		FXST Softail Standard	99-03 ▲		
		FXSTB Night Train	99-03 ▲		
		FXSTC Softail Custom	98-99 ▲		
		FXSTD Softail Deuce	00-03 ▲		
		FXSTI Softail Standard	01-03 ▲		
		FXSTS Springer Softail	98-03 ▲		

Part No.	Make/Model	Year	Part No.	Make/Model	Year	
SRC7012 ▲=CT703SP	HARLEY DAVIDSON		SRC7013 ▲=CT703SP	HARLEY DAVIDSON		
	FLD 103 Dyna Switchback	12-16 ▲		FLSTFB Fat Boy LO	10-15 ▲	
	FLHR 103 Road King	11-13 ▲		FLSTFB ANV Fat Boy LO ANV	13 ▲	
	FLHR Road King	04-05 ▲		FLSTN Softail Deluxe	06-15 ▲	
	FLHR ANV Road King ANV	13 ▲		FLSTSB Cross Bones	08-11 ▲	
	FLHRC 103 Road King Classic	11-13 ▲		FLSTSC Springer Classic	06-07 ▲	
	FLHRCI Road King Classic	04-05 ▲		FLTR Road Glide	06-09 ▲	
	FLHRI Road King	04-05 ▲		FLTRX Road Glide Custom	10-11 ▲	
	FLHRS Road King Custom	04-05 ▲		FXCW Rocker	08-09 ▲	
	FLHT Electra Glide Standard	04-05 ▲		FXCWC Rocker C	08-11 ▲	
	FLHTC 103 Electra Glide Classic	11-13 ▲		FXD Dyna Super Glide	07-10 ▲	
	FLHTC Electra Glide Classic	04-05 ▲		FXD35 Dyna 35th Anniversary Super Glide	06 ▲	
	FLHTCI Ultra Classic	05 ▲		FXDB Dyna Street Bob	07-17 ▲	
	FLHTCU 103 Ultra Classic	11-13 ▲		FXDBC Dyna Street Bob Limited	16 ▲	
	FLHTCUI Ultra Classic	04 ▲		FXDC Dyna Super Glide Custom	07-14 ▲	
	FLHTI Electra Glide Standard	04-05 ▲		FXDC ANV Dyna Super Glide Custom ANV	13 ▲	
	FLHTK Electra Glide Ultra Limited	10-13 ▲		FXDCI Dyna Super Glide Custom	06 ▲	
	FLHTK ANV Electra Glide Ultra Limited ANV	13 ▲		FXDF Dyna Fat Bob	08-17 ▲	
	FLHX 103 Street Glide	11-13 ▲		FXDI Dyna Super Glide	06 ▲	
	FLS 103 Softail Slim	12-15 ▲		FXDL Dyna Low Rider	06-17 ▲	
	FLS Slim	17 ▲		FXDWG Dyna Wide Glide	06-16 ▲	
	FLS Softail Slim	16 ▲		FXDWG ANV Dyna Wide Glide 105th Anniv.	08 ▲	
	FLSTC 103 Heritage Softail Classic	13-15 ▲		FXSB Softail Breakout	13-15 ▲	
	FLSTC 103 ANV Heritage Softail Classic ANV	13 ▲		FXST Softail Standard	07-11 ▲	
	FLSTC Heritage Softail Classic	04-05 ▲		FXSTB Night Train	06-09 ▲	
	FLSTC Heritage Softail Classic	16-17 ▲		FXSTC Softail Custom	07-10 ▲	
	FLSTCI Shrine Heritage Softail Classic Shrine	05 ▲		FXSTD Softail Deuce	06-07 ▲	
	FLSTF 103 Fat Boy	12-15 ▲		FXSTS Springer Softail	06 ▲	
	FLSTF Fat Boy	04-05 ▲				
	FLSTF Fat Boy	16-17 ▲		SRC7014	HARLEY DAVIDSON	
	FLSTFB 103 Fat Boy LO	12-17 ▲		▲=CT701SP	FLHR Road King	93-97 ▲
	FLSTFB 103 ANV Fat Boy LO ANV	13 ▲			FLHS Electra Glide Sport	91-94 ▲
	FLSTFI Shrine Fat Boy Shrine	05 ▲			FLHT Electra Glide Standard	94-97 ▲
	FLSTN 103 Softail Deluxe	12-15 ▲			FLHTC Electra Glide Classic	91-97 ▲
	FLSTN Softail Deluxe	05 ▲			FLHTCU Ultra Classic	91-97 ▲
	FLSTN Softail Deluxe	16-17 ▲			FLTC Tour Glide Classic	91-96 ▲
	FLSTSC Springer Classic	05-06 ▲				
	FLTRI Road Glide	04-05 ▲		SRC7015	HARLEY DAVIDSON	
	FLTRU Road Glide Ultra	11-13 ▲		▲=CT701SP	FLHS Touring Electra Glide Sport	90 ▲
	FLTRX 103 Road Glide Custom	11-13 ▲			FLHTC Touring Electra Glide Classic	90 ▲
	FXD Dyna Super Glide	04-05 ▲			FLHTCU Touring Electra Glide Classic Ultra	90 ▲
	FXDB 103 Dyna Street Bob	14-16 ▲			FLTC Touring Tour Glide Classic	90 ▲
	FXDB 103 Dyna Street Bob 103	17 ▲			FLTCU Touring Tour Glide Classic Ultra	90 ▲
	FXDBA 103 Dyna Street Bob (H-D1)	13-15 ▲				
	FXDBC 103 Dyna Street Bob Limited	16 ▲		SRC7016	HARLEY DAVIDSON	
	FXDC 103 Dyna Super Glide Custom	14 ▲		▲=CT705SP	FLH Touring Electra Glide	84 ▲
	FXDC Dyna Super Glide Custom	05 ▲			FLH Touring Electra Glide Shrine Shovelhead	84 ▲
	FXDF 103 Dyna Fat Bob	12-17 ▲			FLHS Touring Electra Glide Sport	84-89 ▲
	FXDI Dyna Super Glide	04-05 ▲			FLHT Touring Electra Glide Standard	88 ▲
	FXDL 103 Dyna Low Rider	14-16 ▲			FLHT Electra Glide Classic	84 ▲
FXDL 103 Low Rider 103	17 ▲		FLHT Electra Glide	84 ▲		
FXDL Dyna Low Rider	04-05 ▲		FLHTC Touring Electra Glide Classic	84-89 ▲		
FXDWG 103 Dyna Wide Glide	12-16 ▲		FLHTCU Touring Electra Glide Classic Ultra	89 ▲		
FXDWG 103 Dyna Wide Glide 103	17 ▲		FLST Softail Heritage	86-89 ▲		
FXDWGI Dyna Wide Glide	04-05 ▲		FLSTC Softail Heritage Classic	87-89 ▲		
FXDX Dyna Super Glide Sport	04-05 ▲		FLT Classic Tour Glide Classic	84 ▲		
FXS 103 Blackline	11-13 ▲		FLT Tour Glide	84 ▲		
FXSB 103 Softail Breakout	13-16 ▲		FLTC Touring Tour Glide Classic	84-89 ▲		
FXSB Breakout	17 ▲		FLTCU Touring Tour Glide Classic Ultra	89 ▲		
FXST 1BHY Softail Standard	04-06 ▲		FXE FX Super Glide	84 ▲		
FXST Softail Standard	12-15 ▲		FXEF FX Super Glide Fat Bob	85 ▲		
FXSTB Night Train	04-05 ▲		FXSB FX Low Rider	84-85 ▲		
FXSTD Softail Deuce	04-05 ▲		FXST Softail Standard	84-89 ▲		
FXSTS Springer Softail	04-05 ▲		FXSTC Softail Custom	86-89 ▲		
			FXSTS Softail Springer	88-89 ▲		
			FXWG FX Wide Glide	84-86 ▲		
SRC7013 ▲=CT703SP	HARLEY DAVIDSON		SRC7017 ▲=CT704SP	HARLEY DAVIDSON		
	FLD Dyna Switchback	12-16 ▲		FLH Touring Electra Glide	EARLY 84 ▲	
	FLHR Road King	06-11 ▲		FLH Touring Electra Glide Shrine Shovelhead	EARLY 84 ▲	
	FLHRC Road King Classic	06-11 ▲		FLHS Touring Electra Glide Sport	EARLY 84 ▲	
	FLHRS Road King Custom	06-07 ▲		FLHT Electra Glide	EARLY 84 ▲	
	FLHT Electra Glide Standard	06-10 ▲		FLHT Electra Glide Classic	EARLY 84 ▲	
	FLHTC Electra Glide Classic	06-11 ▲		FLT Classic Tour Glide Classic	EARLY 84 ▲	
	FLHTCU Ultra Classic	06-11 ▲		FLT Tour Glide	EARLY 84 ▲	
	FLHX Street Glide	06-11 ▲				
	FLS Softail Slim	12-15 ▲				
	FLST Heritage Softail	06-09 ▲				
	FLSTC 103 Heritage Softail Classic	06-15 ▲				
	FLSTC ANV Heritage Softail Classic ANV	13 ▲				
	FLSTF Fat Boy	06-15 ▲				

Part No.	Make/Model	Year	Part No.	Make/Model	Year
SRC7018 ▲=CT704SP	HARLEY DAVIDSON		SRC7023 ▲=CT701SP	HARLEY DAVIDSON	
	FLH Touring Electra Glide Shrine Shovelhead	83 ▲		XL1200 Sportster 1200	91-03 ▲
	FLH Electra Glide	81-83 ▲		XL1200C Sportster 1200 Custom	96-03 ▲
	FLHC Touring Electra Glide Classic	81-82 ▲		XL1200S Sportster 1200 Sport	96-03 ▲
	FLHC Electra Glide Classic	81 ▲		XL883 Sportster 883	91-03 ▲
	FLHS Touring Electra Glide Sport	81-83 ▲		XL883C Sportster 883 Custom	98-03 ▲
	FLHS Heritage, Electra Glide	81 ▲		XL883DLX Sportster 883 Deluxe	91-95 ▲
	FLHT Touring Electra Glide Standard	83 ▲		XL883HUG Sportster 883 Hugger	91-03 ▲
	FLHT Electra Glide Classic	83 ▲		XL883R Sportster 883R	02-06 ▲
	FLHT Electra Glide	83 ▲			
	FLHTC Touring Electra Glide Classic	83-84 ▲	SRC7024 ▲=CT701SP	HARLEY DAVIDSON	
	FLT Touring Tour Glide	81-83 ▲		XL1200 Sportster 1200	88-90 ▲
	FLT Classic Tour Glide Classic	81-83 ▲		XL883 Sportster 883	86-90 ▲
	FLT Tour Glide	81-83 ▲		XL883 Sportster 883 Deluxe	86-90 ▲
	FLTC Touring Tour Glide Classic	80-84 ▲		XL883HUG Sportster 883 Hugger	87-90 ▲
	FXB Super Glide B80	81-82 ▲		XLH 1100 Sportster 1100	86-87 ▲
	FXDG Dyna Glide Glide Custom	83 ▲		XLH Sportster 1000	84-85 ▲
	FXE FX Super Glide	81-84 ▲		XLS Sportster Roadster 1000	84 ▲
	FXEF FX Super Glide Fat Bob	81 ▲		XR-1000 Sportster	84 ▲
	FXS FX Super Glide	81-82 ▲			
FXSB FX Low Rider	83-84 ▲	SRC7025	HARLEY DAVIDSON		
FXST Softail Standard	84 ▲		XLCH-1000 Sportster 1000	71-84 ▲	
FXWG FX Wide Glide	81-84 ▲		XLH-1000 Sportster 1000	79-80 ▲	
			XLH-1000 Sportster Standard	71-78 ▲	
			XLS 1000 Sportster Roadster	81-84 ▲	
			XR 1000 Sportster	83-84 ▲	
SRC7019 ▲=CT701SP	HARLEY DAVIDSON				
	FLST Softail Heritage	90 ▲			
	FLSTC Heritage Softail Classic	90-97 ▲			
	FLSTF Fat Boy	91-97 ▲			
	FLSTF Softail Fat Boy	90 ▲			
	FLSTN Heritage Softail Nostalgia	93-96 ▲			
	FLSTS Heritage Springer	97 ▲			
	FXD Dyna Super Glide	95-97 ▲			
	FXDB Dyna Daytona	92 ▲			
	FXDB Dyna Sturgis	91 ▲			
	FXDC Super Glide Custom	92 ▲			
	FXDL Dyna Low Rider	93-97 ▲			
	FXDS-CONV Dyna Glide Convertible	93 ▲			
	FXDWG Dyna Wide Glide	93-97 ▲			
	FXST Softail Standard	90 ▲			
FXSTC Softail Custom	90-97 ▲				
FXSTS Springer Softail	90-97 ▲				
SRC7020 ▲=CT701SP	HARLEY DAVIDSON				
	XL1200 Forty Eight Anniversary	18 ▲			
	XL1200C Sportster 1200 Custom	04-20 ▲			
	XL1200C Sportster 1200 Custom ANV	13 ▲			
	XL1200CA Sportster 1200 Custom Limited A	13-16 ▲			
	XL1200CB 1200 Custom Limited B	17 ▲			
	XL1200CB Sportster 1200 Custom Limited A	13-16 ▲			
	XL1200CP Sportster 1200 Custom (H-D1)	11-16 ▲			
	XL1200CX 1200 Roadster	16-20 ▲			
	XL1200L Sportster 1200 Low	06-11 ▲			
	XL1200N Nightster	07-12 ▲			
	XL1200R Sportster 1200 Roadster	04-09 ▲			
	XL1200T SuperLow 1200T	14-20 ▲			
	XL1200V Seventy-Two	12-16 ▲			
	XL1200X Forty Eight	10-20 ▲			
XL50 50th ANV Sportster	07 ▲				
SRC7021 ▲=CT701SP	HARLEY DAVIDSON				
	XL883 Sportster 883	04-09 ▲			
	XL883C Sportster 883 Custom	04-10 ▲			
	XL883L Sportster XL883 Low	05-11 ▲			
	XL883L SuperLow	14-16 ▲			
	XL883L SuperLow	12-20 ▲			
	XL883N Iron 883	09-20 ▲			
	XL883R 883 Roadster	11-15 ▲			
XL883R Sportster 883R	07-10 ▲				
SRC7022 ▲=CT701SP	HARLEY DAVIDSON				
	XR1200 Sportster 1200	08-10 ▲			
	XR1200X XR1200X	10-13 ▲			

SRK CLUTCH KITS BUYERS GUIDE

SRK002	HONDA VF 750 FD/FE	83-85	SRK019 ●=CT014SP	HONDA CB 600 Hornet FW/FX/FY/F2-Y /F1/F21/F2/F22/F3/F4/F5/F6 CBR 600 FM/FN/FP/FR/FS/FT/FV/FW CBF 600 N4/N5/N6 (Non ABS) CBF 600 NA4/NA5/NA6 (ABS) CBF 600 S4/S5/S6 (Non ABS) CBF 600 SA4/SA5/SA6 (ABS)	85-86 ● 91-98 ● 04-06 ● 04-06 ● 04-06 ● 04-06 ●
SRK003 ▲=CT014	HONDA VFR 750 FG/FH/FJ/FL/FMFN/FP /FR/FS/FT/FV	86-97 ▲	SRK020 ▲=CT016	KAWASAKI ZL 900 A1/A2 Eliminator Z 1000 E1/E2 (ST-Shaft) GPz 1000 RX A1-A3 1000 GTR (ZG 1000 A1-A18) ZL 1000 A1 GPz 1100 A1-A3 Z 1100 A1-A3 Z 1100 D1/D2 Spectre Z 1100 R1 ZR 1100 A1/A2/A3/A4/B1 ZRX 1100 (ZX 1100 C1/C2/C3/C4)	85-86 ▲ 79-80 ▲ 86-88 ▲ 86-03 ▲ 87 ▲ 82-85 ▲ 81-83 ▲ 82-83 ▲ 84 ▲ 92-97 ▲ 97-00 ▲
SRK004 ■=CT009	HONDA CB 1000 FP/FR/FS/FT/FV CBR 1000 FH/FJ/FK/FL/FM/FN/FP /FR/FS/FT/FV/FW/FX	93-97 ■ 87-99 ■	SRK021 ▲=CT004	KAWASAKI ZXR 400 (ZX 400 L1-L5/L8/L9)	91-02 ▲
SRK005 ▲=CT014	HONDA VFR 750 RJ/RK/RL (RC30)	88-92 ▲	SRK022 ▲=CT016	KAWASAKI ZL 400 A Eliminator ZL 400 B Eliminator 400 SE ZZ-R 600 D1/D2/D2A/D3 650 Vulcan S (EN 650 AFF/AGF/Non ABS) 650 Vulcan S (EN 650 BFF/BGF/ ABS)	86-87 ▲ 88 ▲ 90-92 ▲ 15-16 ▲ 15-16 ▲
SRK006 ▲=CT010	YAMAHA FZR 400 RR (4DX) FZR 400 Genesis (1WG) FZR 400 (3EN1/3EN2) FZR 400 RR (3TJ1)	92 ▲ 86 ▲ 88-89 ▲ ▲	SRK024 ▲=CT016	KAWASAKI ZXR 750 J1/J2/L1-L3/P1-P7 ZXR 750 R (ZX 750 K1/K2/M1/M2)	91-03 ▲ 91-94 ▲
SRK007 ▲=CT010	YAMAHA FZR 400 RSP (2TK-EXUP) FZR 400 RRP (3TJ2/6/7) FZR 600	87 ▲ ▲ 89-93 ▲	SRK025 ▲=CT021	KAWASAKI ZZ-R 1100 C1/C2/C2A/C3/D1-D9 ZX 1100 E1/E2/F1 ZZR 1200 C1H/C2H	90-01 ▲ 95-98 ▲ 02-04 ▲
SRK008 ■=CT008SP	YAMAHA FZR 750 FZR 1000	87 ■ 87-88 ■	SRK029 ■=CT008SP	YAMAHA FZR 1000 GTS 1000 YZF 1000 Thunder Ace	93-95 ■ 93-96 ■ 96-02 ■
SRK009 ■=CT008SP	YAMAHA FZR 750 R OW01 YZF 750 R/SP TDM 850 TRX 850	89-90 ■ 93-97 ■ 96-98 ■ 96-98 ■	SRK031 ■=CT008SP	YAMAHA FZR 1000	89-92 ■
SRK010 ▲=CT055SP	SUZUKI GSX 1100 GM/GN GSXR 1100 K/L/M/N	91-94 ▲ 89-92 ▲	SRK033 ▲=CT054SP	YAMAHA YZF 600 Thunder Cat	96-03 ▲
SRK011 ▲=CT016	KAWASAKI Z 400 J1-J3 ZR 400 A1/B1 (Z 400 F) ZX 400 C2 (Z 400 F 11) EN 450 A1-A5 (Ltd 454) EN 500 A1/A2/A3/A4/B1/B2/C1-C9 ER-5 (ER 500 A1/A2/A3/A4/C1-C5P) EX 500 A1-A6/D1-D7 (GPz 500 S) GPZ 500 (S) (EX 500 B1-B5) GPZ 500 S (EX 500 E1-E10) Z 500 A1-A3/B1/B2 GT 550 G1-G9 GPz 550 D1/H1/H2/A1-A4 ZR 550 A1/A2 (Z 550 F) Z 550 C1/C2 (Ltd) KL 600 A1 (KLR 600) KLR 600 B1/B2/B4/B6-B9 GPz 600 R A1-A6	80-83 ▲ 83-84 ▲ 85 ▲ 86-89 ▲ 90-04 ▲ 97-07 ▲ 87-02 ▲ 88-93 ▲ 94-04 ▲ 79-81 ▲ 83-01 ▲ 81-87 ▲ 83-84 ▲ 80-81 ▲ 84 ▲ 85-94 ▲ 85-89 ▲	SRK034 ▲=CT010	YAMAHA FZR 250 FZR 250 R (3LN1/3/5/6/7) FZX 250 Zeal (3YX1/2/4)	87 ▲ ▲ 91-92 ▲
SRK013 ▲=CT029	SUZUKI GSX 600 FJ/FK/FL/FM GSXR 750 F/G/H (GR75A)	88-91 ▲ 85-87 ▲	SRK038 ▲=CT004	KAWASAKI ZX-6R (ZX 600 J1/J2) ZX6R (ZX636A1P) 636cc ZX6R (ZX 636 B1/B2)	00-01 ▲ 02 ▲ 03-04 ▲
SRK014	SUZUKI GSXR 750 J/K	88-89	SRK039 ▲=CT055SP	SUZUKI RF 900 RR GSXR 1100 WP/WR/WS/WT	94 ▲ 93-96 ▲
SRK015 ▲=CT048SP	SUZUKI GSX R 1100 G/H/J	86-88 ▲	SRK040 ▲=CT055SP	SUZUKI GSXR 750 T/V/W/X GS 1200 SSK/ZK1 (GV78A) GSF 1200 SAV ABS Bandit GSF 1200 K1/K2/K3/K4/K5 (Naked Bandit - 6 piston caliper) GSF 1200 SK1/SK2/SK3/SK4/SK5 (Faired Bandit) (6 piston caliper) GSF 1200 T/V/W/X/Y (Naked Bandit) piston caliper GSF 1200 ST/SV/SW/SX/SY (Faired Bandit) piston caliper	96-99 ▲ 01 ▲ 97 ▲ 01-05 ▲ 01-05 ▲ 96-00 ▲
SRK016 ■=CT009SP	HONDA CBR 500 FH/FJ/FK/FL CBR 600 FH/FJ	87-90 ■ 87-88 ■			
SRK017	SUZUKI GSX 600 FN/FP/FR/FS/FT/FV GSXR 750 L/M/WN	92-97 90-92			

Part No.	Make/Model	Year	Part No.	Make/Model	Year
SRK040 ▲=CT055SP Contd.	SUZUKI Contd. GSX 1200 FSW/FSX Inazuma GSF 1200 K6/AK6 (Naked Bandit) (4 piston caliper) Non & Non ABS Version GSF 1200 SK6/SAK6 (Faired Bandit) (4 piston caliper) Non & Non ABS Version	98-99 ▲ 06 ▲ 06 ▲	SRK051 ■=CT008SP Contd.	YAMAHA Contd. FZ6-Fazer (Half Fairing/Non ABS /2 piston caliper) (5VX/5VXL) FZ6-Fazer (ABS/Half Fairing /2 piston caliper) FZ6 Fazer S2 (ABS/Half Fairing /4 piston caliper) FZ6 Fazer S2 (Non ABS/Half Fairing/4 piston caliper) FZ6 S2 (Naked/Non ABS /4 piston caliper) (5S51/5S5) FZX 700 S/SC/T/TC Fazer FZ 750	04-07 ■ 06-07 ■ 08 ■ 07-09 ■ 07-09 ■ 86-87 ■ 85-86 ■
SRK041 ▲=CT016	KAWASAKI ZX7 RR (ZX 750 N1/N2) ZX-9R (ZX 900 B1-B4)	96-99 ▲ 94-97 ▲	SRK053 ▲=CT016	KAWASAKI VN 700 A1 Vulcan Z 750 Y1 (Ltd) VN 800 C1/C2/E1/E2/E3 Drifter GPz 900 R A1-A8 GPZ 900 R (ZX 900 A11) GPZ 900 R (ZX 900 A12-15)	85 ▲ 82 ▲ 99-04 ▲ 84-96 ▲ 98 ▲ 99-02 ▲
SRK042 ■=CT009SP	HONDA CBR 600 FK/FL	89-90 ■	SRK054 ▲=CT016	KAWASAKI Z 1000 R1/R2 (Eddie Lawson Replica) Z 1000 J1/J2/J3 Z 1000 K1/K2 LTD GPZ 1100 B1/B2	82-83 ▲ 81-83 ▲ 81-82 ▲ 81-82 ▲
SRK043 ▲=CT016	KAWASAKI ZZR 600 (ZX 600 E1-E13) ZZR 600 (ZX 600 E6F)	93-05 ▲ 06-07 ▲	SRK055 ▲=CT014	HONDA CBR 900 RRT/RRV	96-97 ▲
SRK044 ▲=CT016	KAWASAKI ZR 400 Zephyr (G2/G3/G3A/G4/G5) ZL 600 B1 ZR 550 B2-B6 Zephyr GPX 600 R (C1-C3/C6/C7)	97-01 ▲ 95-97 ▲ 91-99 88-96	SRK056 ▲=CT017	YAMAHA YZF R1 (4XV1/2)	98 ▲
SRK045	SUZUKI RF 600 RP/RR/RS/RT	93-96	SRK057 ▲=CT014	HONDA CBR 600 FS1/FS2 Sport CBR 600 FB/FAB/FC/FAC CB 900 F2/F3/F4/F5/F6/F7 Hornet CBR 900 RRW/RRX (918cc)	01-02 ▲ 11-12 ▲ 02-07 ▲ 98-99 ▲
SRK046 ▲=CT016	KAWASAKI W 650 (EJ 650 A1/C3-C7) GPX 750 F1/F2/F2A/F3 VN 750 A2/A3/A4/A5/A10 Z 750 D1 Z 750 B1/B2 EJ 800 ABF/ACF (W 800/Solid F isc) EJ 800 (W 800 Cafe style/Cockpit fairing) EJ 800 ACFA (W 800 Special Edition Black Exhaust/Gold Rims EJ 800 ADF/AEF/AFF/AGF (W 800) EJ 800 ADFA/AEFA/AFFA/AGFA (W 800 Special Edition) VN 800 A1-A3/B1-B10/B6F W 800 AEFA W800 Special Edition VN 900 A6F Classic VN 900 C7F/C8F/C9FA/CAF/CBF/CCFA /CDF/CEFA/CFFA Custom (Cast wheel) VN 900 B7F/B8F/B9F/BAF/BBF/BCF /BDF/BEF/BFF Classic (Spoke wheel) VN 900 BBFA/BCFA/BDFA/BEFABFFA Classic Special Edition	99-05 ▲ 87-89 ▲ 86-94 ▲ 76 ▲ 77-78 ▲ 11-12 ▲ 11 ▲ 12 ▲ 13-16 ▲ 13-16 95-06 ▲ 14 ▲ 06 ▲ 07-15 ▲ 07-15 ▲ 11-15 ▲	SRK058 ▲=CT014	SUZUKI GSXR 600 X/Y	99-00 ▲
SRK047 ■=CT012SP	HONDA CB 250 FT/FV/FX/FY/F1 (MC31) Hornet CBR 250 FG/RH/RJ/RK/RK2 (MC14/17/19) CBR 250 RRL/RRV/RRR (MC22 100/105/110) VT 250 CR/CT/CV Magna (MC29) VTZ 250 H/J/K VTR 250 W/Y (MC33)/1-7	96-01 ■ 86-89 ■ 90-94 ■ 95-97 ■ 86-88 ■ 98-07 ■	SRK059 ▲=CT004	KAWASAKI ZX9R (ZX 900 C1/C2)	98-99 ▲
SRK048 ■=CT009SP	HONDA CBX 550 FC/F2C/FD/F2D	82-85 ■	SRK060	HONDA VTR 1000 FV/FW/FX/FY/F1-F6 Firestorm	97-06
SRK049 ■=CT013SP	HONDA CBR 400 RRL/RRV/RRR (NC29)	90-94 ■	SRK061 ■=CT013SP	HONDA NT 400 Bros NC 25 NV 400 CJ/CK (Steed) NV 400 CS/CV Steed NV 400 DCY/DC1/DC2 (NC40) Shadow Slasher	92-93 ■ 95-97 ■ 00-02 ■
SRK050 ▲=CT024SP	SUZUKI GS 1000 GT/GX GSX 1000 SZ GS 1100 GZ GSX 1100 ET/EX/EZ GSX 1100 SZ GSX 1100 EFE/EFG/ESF	80-81 ▲ 82 ▲ 82 ▲ 80-82 ▲ 82 ▲ 84-86 ▲	SRK062 ■=CT013SP	HONDA NTV 650 J/K/L/M/P/S/T/V NT 650 VW/VX/VY/V1-V5 Deauville NC 700 SC/SD (Manual Gearbox) NC 700 XC/XD (Manual Gearbox) NT 700 VA6/VA7/VA7/V8 /VA8/VA9AA Deauville NC 750 S NC 750 S (ABS) NC 750 X NC 750 X (ABS)	88-97 ■ 98-05 ■ 12-13 ■ 12-17 ■ 06-12 ■ 14-15 ■ 14-18 ■ 14-15 ■ 14-19 ■
SRK051 ■=CT008SP	YAMAHA YZF 600 R R6 (8 plate) FZ6 Naked/Non ABS 2 piston caliper (IB3/IB3D) FZ6-NS Naked/Non ABS (2 piston caliper) (IB35/6)	99-02 ■ 04-07 ■ 05-06 ■	SRK063 ▲=CT002	HONDA VFR 400 R3K/R3L/R3M/R3N (NC30)	89-92 ▲
			SRK064 ■=CT013SP	HONDA NT 650 J/K/L (BROS) VT 750 CV/C2V/CW/C2W/CX/C2X /CY/C2Y/C1/C1Y/C4/C5/C6/C7/C8 VT 750 S (VT 50 SA/SB) XRV 650 J/K Africa Twin	88-92 ■ 97-09 ■ 10-12 ■ 88-89 ■
			SRK065	YAMAHA YZF R1 (4XV7/8 5JJ1/8 5PW1/7)	99-03
			SRK066 ▲=CT014	HONDA CBR 600 FX/FY (CARB MODEL)	99-00 ▲

Part No.	Make/Model	Year	Part No.	Make/Model	Year
SRK067 ▲=CT021	SUZUKI GSX 1300 RX	99 ▲	SRK082 ▲=CT033SP Contd.	SUZUKI Contd. DL 650 AL2/AL3/AL4/AL5 V-Strom DL 650 AK9GT V-Strom Traveller DL 650 XT V-Strom SFV 650 K9/L0/L1/L2/L3/L4/L5 SFV 650 AK9/AL0/AL1/AL2/AL3/AL4/AL5 (ABS) SV 650 K3/K4/K5/K6/K7/K8/K9/L0 Naked - Non ABS SV 650 SK3/SK4/SK5/SK6/SK7/SK8 /SK9/SLO Top Fairing - Non ABS SV 650 AK7/AK8/AK9/AL0 Naked - ABS SV 650 SAK7/SAK8/SAK9/SALO (ABS) SV 650 (ABS)	12-14 ▲ 09-11 ▲ 15-20 ▲ 09-15 ▲ 09-15 ▲ 03-10 ▲ 03-15 ▲ 07-10 ▲ 07-15 ▲ 16-20 ▲
SRK068 ▲=CT009	SUZUKI TL 1000 RW/RX/RV TL 1000 SX/SY	98-00 ▲ 99-00 ▲	SRK083 ▲=CT004	KAWASAKI ZX6RR (ZX 600 M1)	04 ▲
SRK070 ▲=CT056SP	HONDA ST 1100 AN/AP/AR/AS Pan European (ABS Model) ST 100 AT/AV/AW/AX/AY/A1/A2 Pan European (ABS Model) ST 1100 L/M/N/P/R/S/T/V/W/X/Y Pan European - Non ABS	92-95 ▲ 96-02 ▲ 90-02 ▲	SRK084 ▲=CT004	KAWASAKI ZX-6R (ZX 636 C1/C6F) ZX-6RR (ZX 600 N1/N6F)	05-06 ▲ 05-06 ▲
SRK071 ▲=CT014	SUZUKI GSXR 750 Y	00 ▲	SRK085 ▲=CT015	SUZUKI GSXR 1000 K5/K6/K7/K8 GSX-S 1000 (Naked/Non ABS) GSX-S 1000 (Naked/ ABS) GSX-S 1000 F (Faired/Non ABS) GSX-S 1000 F (Faired/ ABS) Katana	05-08 ▲ 18-20 ▲ 18-20 ▲ 18-20 ▲ 18-20 ▲ 19-20 ▲
SRK072 ▲=CT008	YAMAHA XT 550 SRX 600 SRX 600 (1JK/3SX)	83 ▲ 86-87 ▲ 85-91 ▲	SRK086 ▲=CT015	SUZUKI GSXR 600 K6/K7	06-07 ▲
SRK074 ■=CT008SP	YAMAHA YZF-R6 (8 plate)	03-05 ■	SRK087 ▲=CT008SP	YAMAHA YZF R6 (9 plate)	06-18 ■
SRK075 ▲=CT014	HONDA CB 600 F7/F8/F9/FA/FB/FC Hornet CB 600 FA7/FA8/FA9/FAA/FAB /FAC Hornet (ABS) CBF 600 N8/N9/NA (Non ABS) CBF 600 NA8/NA9/NAA (ABS) CBF 600 S8/S9 (Non ABS) CBF 600 SA8/SA9/SA (ABS) CBR 600 RR3/RR4/RR5/RR6/RR7 /RR8/RR9/RAA/RRB/RRC/RRD RRE/RRF/RRG/RRH/RRJ/RRK CBR 600 RR Hannspree CBR 600 RA9/RAA/RAB /RAC/RAD/RAG/RAH/RAJ/RAK (C-ABS) CBR 600 FB/FC VFR 800 XA (Crossrunner/ABS) VFR 800 XA (Crossrunner/ABS) VFR 800 F (ABS Model)	07-13 ▲ 07-13 ▲ 08-11 ▲ 08-11 ▲ 08-09 ▲ 08-12 ▲ 03-19 ▲ 08 ▲ 09-19 ▲ 11-13 ▲ 11-13 ▲ 15-16 ▲ 14-16 ▲	SRK088 ▲=CT015	SUZUKI GSXR 750 K6/K7	06-07 ▲
SRK076 ▲=CT004	KAWASAKI ZX6RR (ZX 600 K1)	03 ▲	SRK089 ▲=CT004	SUZUKI GSXR 1000 K1/K2/K3/K4 ZX9R (ZX 900 E1/E2/F1/F2) Z 1000 (ZR 1000 A1/A2/A3/A6F)	01-04 ▲ 00-03 ▲ 03-06 ▲
SRK077 ▲=CT020	YAMAHA FZ1 (Naked) (1000cc) (2D11) FZ-1 Fazer Non ABS (1000cc) (3C3) FZ-1 Fazer (Half Fairing - ABS - 5D0) FZ1 N/NA Naked (Non ABS/ABS) YZF R1	06-09 ▲ 06-15 ▲ 08-15 ▲ 10-15 ▲ 04-06 ▲	SRK093 ▲=CT020	YAMAHA YZF R1SP YZF R1	06 ▲ 07-08 ▲
SRK078 ▲=CT014	SUZUKI GSXR 600 K4/K5	04-05 ▲	SRK094 ▲=CT014	HONDA CBR 900 RRN/RRP/RRR/RRS	92-95 ▲
SRK079 ▲=CT004	KAWASAKI ZX 10R (ZX 1000 C1/C2) ZX-10RR ZX-10RR Performance	04-05 ▲ 17-19 ▲ 17-19 ▲	SRK095 ▲=CT043SP	HONDA CBR 1000 RR Fireblade CBR 1000 RR-SP ABS Fireblade CBR 1000 RR-SP ABS -TT Edition	08-16 ▲ 14-16 ▲ 16 ▲
SRK080 ■=CT009	HONDA CBR 1000 RR4/RR5/RR6/RR7 # Fireblade CB 1000 R9/RA/RB/RC/RD/RE/RF Non ABS Model CB 1000 RA9/RAA/RAB/RAC/RAE /RAF/RAG (ABS Model)	04-07 ■ 09-15 ■ 09-16 ■	SRK096 ▲=CT020	YAMAHA YZF R1	09-14 ▲
SRK081 ▲=CT022 ●=CT033SP	SUZUKI SV 400 N (VK53A) SV 400 SN (VK53A) SV 400 X/Y/K1/K2 SV 400 SX/SY/SK1/SK2 SV 650 A/Y/K1/K2 Naked - Non ABS SV 50 SX/SY/SK1/SK2 Top Fairing Non ABS	98 ● 98 ● 00-02 ● 00-02 ● 99-02 ▲ 99-02 ▲	SRK097 ▲=CT009	SUZUKI GSXR 1000 K9/L0/L1/L2	09-12 ▲
SRK082 ▲=CT033SP	SUZUKI SV 400 K3/K4/K5 SV 400 SK3/SK4/SK5 DL 650 K4-K6 V-Strom DL 650 AK7/AK8/AK9/AL0 V-Strom ABS DL 650 AL1XP V-Strom Xpedition	03-05 ▲ 03-05 ▲ 04-06 ▲ 07-11 ▲ 11 ▲	SRK098 ▲=CT021	KTM RC8 (1190cc) RC8 R Track (1190cc)	08-10 ▲ 10-12 ▲
			SRK099	YAMAHA XP 500 (T-Max Scooter - All models)	01-11
			SRK100 ▲=CT014	HONDA CBR 900 RRY/RR1 (929cc Fireblade) CBR 900 RR2/RR3 (954cc) Fireblade	00-01 ▲ 02-03 ▲
			SRK101 ▲=CT004	KAWASAKI ZX-6R (ZX 600 P7F/P8F/R9F/RAF /RBF/RCF/RDF/REF/RF/RGF) (599cc)	07-16 ▲
			SRK102 ▲=CT016	KAWASAKI ER-6f (EX 650 A6F/A7F/A8F) ER-6f (ABS Model) (EX 650 B6F/B7F/B8F) ER-6n (ER 650 A6F/A7F/A8F) ER-6n (ABS) ER 650 B6F/B7F/B8F /C9F/CAF/CBF ER-6f (ECF/EDS/EEF/EFF) (non ABS)	06-08 ▲ 06-08 ▲ 06-08 ▲ 06-08 ▲ 06-08 ▲ 12-15 ▲

Part No.	Make/Model	Year	Part No.	Make/Model	Year
SRK102 ▲=CT016	KAWASAKI ER-6f (FCF/FDE/FEF/FFF/FGF) (with ABS) ER-6n (ECF/EDF/EEF/EFF) (non ABS) ER-6n (FCF/FDF/FEF/FFF/FGF) (with ABS) KLE 650 A7F/A8F/A9F/CAF/CBF /CCF/CDV Versys KLE 650 B7F/B8F/B9F/DAF/DBF DCF/DDF Versys ABS	12-16 ▲ 12-15 ▲ 12-16 ▲ 07-13 ▲ 07-13 ▲	SRK125 ▲=CT020	YAMAHA MT-07 Non ABS (689cc/2 Cyl) MT-07A ABS (689cc/2 Cyl) MT-07 Motocage ABS (689cc/2 Cyl) XSR 700 ABS (MTM 690-U)	14-20 ▲ 14-20 ▲ 15 ▲ 16 ▲
SRK103 ▲=CT009	HONDA VFR 1200 FA (Manual Gearbox Model)	10-15 ▲	SRK126 ▲=CT020	YAMAHA FZ8 N-800cc (Naked/Single Headlight/Non ABS) FZ8 NA-800cc (Naked/Single Headlight/ABS) Fazer 8 S-800cc (Top Fairing/Twin Headlight/Non ABS) Fazer 8 SA-800cc (Top Fairing/Twin Headlight/ABS)	11-15 ▲ 11-15 ▲ 11-15 ▲ 11-15 ▲
SRK104 ▲=CT036SP	SUZUKI GSXR 750 WP/WR/WS	93-95	SRK127 ■=CT008SP	YAMAHA XJ6-N 600 (Naked - Non ABS & ABS Model - 20S) XJ6-F Diversion 600 (Full Fairing Diversion - Non ABS & ABS Models - 1CW) XJ6-S Diversion 600 (Top Fairing Diversion - Non ABS & ABS Models - 36C) XJ6-SP Diversion 600 (Non ABS & ABS Models)	09-15 ■ 10-15 ■ 09-15 ■ 13 ■
SRK106 ▲=CT014	SUZUKI GSXR 600 V/W	97-98 ▲	SRK128 ■=CT080	YAMAHA YZF-R3 (321cc/ABS) MT-03 ABS	15-20 ■ 12-20 ■
SRK107 ▲=CT004	KAWASAKI ZX-6RR (ZX 600 N1/N6F)	05-06 ▲	SRK129 ■=CT079SP	YAMAHA YZF- R1 YZF- R1 M YZF- R1 (60th Anniversary Edition) MT-10 (998cc)	15-20 ■ 15-20 ■ 16 ■ 16 ■
SRK108 ▲=CT004	KAWASAKI ZX-6R (ZX 600 F1/F2/F3) ZX-6R (ZX 600 G1/G2)	95-97 ▲ 98-99 ▲	SRK130 ▲=CT085	BMW F650 GS (Late type plates 2 x 13mm/7 x 14mm ears) F700 GS (Late type plates 2 x 13mm/7 x 14mm ears) F800 GS (Late type plates 2 x 13mm/7 x 14mm ears) F800 GS Adventure (Late type plates 2 x 13mm/7 x 14mm ears) F800 GT (Late type plates 2 x 13mm/7 x 14mm ears) F800 S (Late type plates 2 x 13mm/7 x 14mm ears) F800 ST (Late type plates 2 x 13mm/7 x 14mm ears) F800 R (Late type plates 2 x 13mm/7 x 14mm ears)	07-17 ▲ 11-17 ▲ 12-19 ▲ 12-19 ▲ 07-19 ▲ 07-19 ▲ 07-19 ▲ 07-19 ▲ 05-19 ▲
SRK109 ▲=CT015	SUZUKI GSXR 600 K8/K9/L0 GSXR 750 K8/K9/L0	08-10 ▲ 08-10 ▲	SRK131 ▲=CT017	YAMAHA XT 1200 Z Super Tenere (ABS/UBS Brake System) XT 1200 ZE Super Tenere (ABS/UBS Brake System) FJR 1300 N/P FJR 1300 R/AR/S/AS/AT (ABS) FJR 1300 A (1CY/Manual G/Shift) FJR 1300 AE (Electronic Suspension Adjustment/USD Forks) XVS 1300 A Midnight Star XVS 1300 CU Custom	10-16 ▲ 14-16 ▲ 01-02 ▲ 03-05 ▲ 06-15 ▲ 14-15 ▲ 07-16 ▲ 14-16 ▲
SRK110 ▲=CT015	SUZUKI GSXR 600 GSX-R 750 GSX-S 750	11-20 ▲ 11-20 ▲ 15-20 ▲	SRK133 ▲=CT009	SUZUKI GSX 1400 K2/K3/K4/K5/K6/K7	02-07 ▲
SRK111 ▲=CT014	SUZUKI GSXR 750 K1/K2/K3	01-03 ▲	SRK138 ▲=CT072SP	SUZUKI GSXR 750 RG (Dry Clutch Sintered Friction)	86 ▲
SRK112 ▲=CT014	SUZUKI GSXR 600 K1/K2/K3/ZK3	01-03 ▲	SRK139	KTM 390 Duke RC 390	13-14 14-15
SRK113	APRILIA RSV4 Factory SBK Racing RSV4 Factory APRC RSV4R RSV4R APRC	09-10 11-12 10 11-12	SRK140	KTM Duke 250 RC 250 Duke 390 RC 390	15-18 15-18 15-17 16-17
SRK115 ▲=CT035SP	SUZUKI GS 1000 HC/EC/EN/SN/ET	78-80 ▲			
SRK117	APRILIA ETV 1000 Caponord/Rally (PS00/PSB0) (Non ABS Models) ETV Caponord (PS004) (ABS Model)	01-03 04-08			
SRK118 ▲=CT009	KAWASAKI EX 300 ADF/AEF/AFF Ninja 300 (Non ABS) EX300 AEFA/AFFA Ninja 300 Special Edition (Non-ABS) EX300 BDF/BEF/BFF/BGF Ninja 300 (ABS) EX300 BEFA/BFFA/BGFA Ninja 300 Special Edition (ABS) Versys-X 300 ABS Z 300 Non ABS (ER 300 AFF) Z 300 ABS (ER 300 BFF)	13-15 ▲ 13-15 ▲ 13-16 ▲ 13-16 ▲ 13-16 ▲ 17-20 ▲ 15 ▲ 15-16 ▲			
SRK119 ▲=CT012SP	HONDA CBR 125 RW7/RW8/RW9/RWA/ RWB/RW9/RC/RD/RF (No judder spring)	07-16 ▲			
SRK121 ▲=CT014	SUZUKI GSXR 750 K4/K5	04-05 ▲			
SRK122 ▲=CT083SP	HONDA Monkey 125 MSX 125 Grom MSX 125 A Grom ABS	19-20 ▲ 13-20 ▲ 17-20 ▲			
SRK124 ▲=CT020	YAMAHA MT-09 (1RC/Non ABS/847cc/3 Cyl Engine) MT-09 Tracer ABS (847cc/3 Cyl Engine) MT-09A (2DR/ABS/847cc/3 Cyl Engine) MT-09A Sport Tracker ABS (847cc/3 Cyl Engine) MT-09A Street Rally ABS (847cc/3 Cyl Engine)	14-16 ▲ 15-20 ▲ 14-20 ▲ 14-20 ▲ 14-20 ▲			

Part No.	Make/Model	Year	Part No.	Make/Model	Year	
SRK141 ▲=CT014SP	BENELLI Leoncino 500	17-19 ▲	SRK153	KTM Duke 200 RC 200	12-19	
	Leoncino Trail 500	18-19 ▲			14-19	
	TRK 502 ABS Euro 4	17-18 ▲	SRK154	KTM Duke 125 RC 125	11-19	
	TRK 502 X	18-19 ▲			14-19	
	BN 600 GT	14-17 ■				
	BN 600 i	14-17 ■				
BN 600 R	14-15 ■					
BN 600 S	14-15 ■					
SRK142 ▲=CT009	SUZUKI GSXR 1000 AL7	17-20 ▲	SRK155	KAWASAKI Ninja 650 (EX 650) Ninja 650 ABS (EX 650 ABS) Z 650 (ER 650) Z 650 ABS (ER 650 ABS)	12-18 12-18 12-18 12-18	
SRK143 ▲=CT014	SUZUKI CBR 600 F1/F2/F3/F4/F5/F6 (CARB MODEL)	01-06 ▲	SRK160 ▲=CT008SP	YAMAHA YZF-R6	18-20 ▲	
	CBR 600 FR1/FR2 (ROSSI INJECTION MODEL)	01-02 ▲	SRK161	HONDA CB 1100 EX	16-19	
	CBR 600 FS1/FS2 (CBR600 S INJECTION MODEL)	01-02 ▲	SRK162	YAMAHA XSR 900 ABS	18-20	
SRK144 ▲=CT085	BMW F800 GS (Early type plates 14mm ears)	08-11 ▲	SRK163	KAWASAKI Ninja H2	15-20	
	F800 GT (Early type plates 14mm ears)	04-06 ▲	SRK164	KAWASAKI Ninja H2R	15-20	
	F800 S (Early type plates 14mm ears)	04-06 ▲	SRK165	BMW R 1200 GS R 1200 GS Adventure R 1200 R R 1200 RS R 1250 GS R 1250 GS TE R 1250 GS Rallye R 1250 GS Rallye TE R 1250 GS Adventure/ Adventure TE R 1250 GS Adventure Rallye/Rallye TE	13-18 13-18 13-18 14-18 19-20 19-20 19-20 19-20 19-20 19-20 19-20	
	F800 ST (Early type plates 14mm ears)	04-06 ▲			19-20	
SRK145 ▲=CT083	BMW G 650 GS (R13)	08-16 ▲	SRK166 CT014	TRIUMPH Tiger 800 Tiger 800 XC Tiger 800 XR	11-12 11-12 18-	
	G 650 GS Sertao (R13)	10-14 ▲	SRK167	KAWASAKI Ninja 400 Z 400	17-21 17-21	
	G 650 XCountry (K15)	08-10 ▲				
SRK146 ▲=CT086SP	TRIUMPH Bonneville T120 (1200cc Liquid Cooled)	16-18 ▲	SRK170	BMW F 750 GS F 850 GS F 850 GS Adventure	16-21 16-21 16-21	
	Bonneville T120 Black (1200cc Liquid Cooled)	16-18 ▲	SRK168	KTM 1050 Adventure 1090 Adventure 1090 Adventure L 1090 Adventure R 1090 Adventure S 1190 Adventure 1190 Adventure R 1290 Super Adventure 1290 Super Adventure R 1290 Super Adventure S 1290 Super Adventure T	15-16 17-18 19 17-19 19 13-16 13-16 15-17 17-21 17-21 17	
	Bonneville Bobber (1200cc Liquid Cooled)	17-20 ▲				
	Bonneville Bobber Black (1200cc Liquid Cooled)	18-20 ▲				
	Thruxton 1200 (Liquid Cooled)	16-20 ▲				
	Thruxton R 1200 (Liquid Cooled)	16-20 ▲				
SRK147 ▲=CT086SP	TRIUMPH Bonneville T100 (900cc/Liquid Cooled/Spoke Wheel)	16-18 ▲	SRK169	SUZUKI GSX-S 750	15-21	
Bonneville T100 Black (900cc/Liquid Cooled/Spoke Wheel)	16-18 ▲	SRK7001	INDIAN Octane Scout Scout Sixty	17 15-16 16-17		
Street Cup (900cc Liquid Cooled)	16-20 ▲					
Street Scrambler (900cc Liquid Cooled)	16-20 ▲					
Street Twin (900cc Liquid Cooled)	16-18 ▲					
SRK148 ▲=CT011	SUZUKI GSX-R 125			18-20 ▲		
GSX-S 125	18-20 ▲					
GSX 150 L6/DZAL6 Gixxer	16 ▲					
GSX-R 150 RF-Q/RFX-Q	17-18 ▲					
GSX-R 150	18-20 ▲					
GSX-S 150	18-20 ▲					
SRK149 ▲=CT014	HONDA CB 650 F (Non ABS)	14-20 ▲				
	CB 650 FA (ABS)	14-20 ▲				
	CBR 650 F (Non ABS)	14-20 ▲				
	CBR 650 FA (ABS)	14-20 ▲				
	SRK150	KAWASAKI Z 750 (ZR 750 L9F/LAF/LAS)	09-10			
Z 750 ABS (ZR 750 M9F/MAF/MAS)	09-10					
Z 750 R Non ABS (ZR 750 NBF/NCF)	11-12					
Z 750 R Black Edition (ZR 750 NBFA)	12					
Z 750 R ABS (ZR 750 PBF/PCF)	11-12					
Z 800 ADS/AEF/AFF/AGF (Non ABS)	13-16					
Z 800 BDS/BEF/BFF/BGF (ABS Model)	13-16					
Z 800 E CDS/CEF/CFE/CGF (Non ABS)	13-16					
Z 800 E DDS/DEF/DFE/DGF (ABS Model)	13-16					
SRK151 ▲=CT013	BMW G 310 GS	17-20 ▲				
	G 310 R	17-20 ▲				

Part No.	Make/Model	Year	Part No.	Make/Model	Year
SRK7002	INDIAN		SRK7010 ▲=CT702SP	HARLEY DAVIDSON	
	Scout	17-20		FLHR Road King	17-20 ▲
	Scout 1200	17-20		FLHRC Road King Classic	17▲
	Scout Bobber	18		FLHRXS Road King Special	18▲
	Scout Sixty	17-20		FLHTCU Electra Glide Ultra Classic	17-20▲
SRK7003 ▲=CT702SP	HARLEY DAVIDSON			FLHTK Ultra Limited	17-20▲
	FLHTCUTG Tri Glide Ultra Classic	14-16 ▲		FLHTK Ultra Limited Shrine Edition	18▲
	FLRT Freewheeler	15-16▲		FLHTK Ultra Limited Anniversary	18▲
	FLHTK 103 CVO Limited	14▲		FLHTKL Ultra Limited Low	17-20▲
	FLHTCUL Ultra Classic Low	15-16▲		FLHX Street Glide	17-20▲
	FLHTCUL TC Ultra Classic Low Twin-Cooled	15-16▲		FLHX Street Glide Anniversary	18▲
	FLHTKL Ultra Limited Low	15-16▲		FLHXS Street Glide Special	17-20▲
	FLSS Softail Slim S	16▲		FLHXS Street Glide Special Anniversary	18▲
	FLSTFBS Fat Boy S	16-17▲		FLTRU Road Glide Ultra	17-20▲
	FLSS Slim S	17▲		FLTRX Road Glide	17-20▲
	FLSTFBS Fat Boy S	17▲		FLTRXS Road Glide Special	17-20▲
SRK7004	INDIAN		SRK7011 ▲=CT703SP	HARLEY DAVIDSON	
	Chief Classic	14-20		FLHR Road King	15-16▲
	Chief Dark Horse	16-20		FLHR Road King	98-03▲
	Chief Vintage	14-20		FLHRC Road King Classic	14-16▲
	Chieftain	14-18		FLHRCI Road King Classic	98-99▲
	Chieftain Dark Horse	16-20		FLHT Electra Glide Standard	98-03▲
	Chieftain Elite	17-20		FLHTC Electra Glide Classic	98-03▲
	Chieftain Limited	17-18		FLHTCU Ultra Classic	14-16▲
	Roadmaster	15-18		FLHTCU TC Ultra Classic Twin-Cooled	14-16▲
	Roadmaster Classic	17-20		FLHTCUI Ultra Classic	98-03▲
	Roadmaster Elite	18-20		FLHTK Ultra Limited	14-16▲
	Springfield	16-20		FLHX Street Glide	14-16▲
	Springfield Dark Horse	18		FLHXS Street Glide Special	14-16▲
				FLSTC Heritage Softail Classic	98-03▲
				FLSTF Fat Boy	98-03▲
SRK7005	HARLEY DAVIDSON			FLSTS Heritage Springer	98-03▲
	XG500	15-20		FLTR Road Glide	98-03▲
SRK7006 ▲=CT706SP	HARLEY DAVIDSON			FLTRU Road Glide Ultra	15-16▲
	VRSCAW 1HFH V-Rod Wide Tire	08▲		FLTRX Road Glide	15-16▲
	VRSCAWA W/ABS	08▲		FLTRXS Road Glide Special	15-16▲
	VRSCD Night Rod	08▲		FXD Dyna Super Glide	98-03▲
	VRSCDA Night Rod W/ABS	08▲		FXDL Dyna Low Rider	98-03▲
	VRSCDXA Night Rod Special W/ABS	08▲		FXDS-CONV Dyna Glide Convertible	99-00▲
	VRSCDX Night Rod Special	08-17▲		FXDWG Dyna Wide Glide	98-05▲
	VRSCAW V-Rod	09-10▲		FXDX Dyna Super Glide Sport	99-03▲
	VRSCF V-Rod Muscle	09-17▲		FXDXT Dyna Super Glide T-Sport	01-03▲
	VRSCDX ANV Night Rod Special Anv	12▲		FXST Softail Standard	99-03▲
				FXSTB Night Train	99-03▲
				FXSTC Softail Custom	98-99▲
				FXSTD Softail Deuce	00-03▲
			FXSTI Softail Standard	01-03▲	
			FXSTS Springer Softail	98-03▲	
SRK7007 ▲=CT707SP	HARLEY DAVIDSON		SRK7012 ▲=CT703SP	HARLEY DAVIDSON	
	VRSCA V-Rod	02-06▲		FLD 103 Dyna Switchback	12-16▲
	VRSCAW V-Rod	07▲		FLHR 103 Road King	11-13▲
	VRSCB V-Rod	04-05▲		FLHR Road King	04-05▲
	VRSCR Street Rod	06-07▲		FLHR ANV Road King ANV	13▲
	VRSCSE CVO V-Rod	05▲		FLHRC 103 Road King Classic	11-13▲
	VRSCSE2 CVO V-Rod	06▲		FLHRCI Road King Classic	04-05▲
	VRSCX Screamin' Eagle V-Rod	07▲		FLHRI Road King	04-05▲
VRXSE CVO VR Destroyer	06▲	FLHRS Road King Custom	04-05▲		
SRK7008 ▲=CT708SP	HARLEY DAVIDSON			FLHT Electra Glide Standard	04-05▲
	FLFBS Fat Boy 114	18		FLHTC 103 Electra Glide Classic	11-13▲
	FLFBS Fat Boy 114 Anniversary	18-20		FLHTC Electra Glide Classic	04-05▲
	FLFBS Fat Boy 114 Anniversary	18		FLHTCI Ultra Classic	05▲
	FLHCS Heritage Classic 114	18-20		FLHTCU 103 Ultra Classic	11-13▲
	FLHCS Heritage Classic 114 Anniversary	18		FLHTCUI Ultra Classic	04▲
	FLHP Road King Police	17		FLHTI Electra Glide Standard	04-05▲
	FLHTCUTG Tri Glide Ultra	17-20		FLHTK Electra Glide Ultra Limited	10-13▲
	FLHTCUTG Tri Glide Ultra Anniversary	18		FLHTK ANV Electra Glide Ultra Limited ANV	13▲
	FLHTP Electra Glide Standard Police	17		FLHX 103 Street Glide	11-13▲
	FLRT Freewheeler	17-18		FLS 103 Softail Slim	12-15▲
	FXBRS Breakout 114	18-20		FLS Slim	17▲
	FXBRS Breakout 114 Anniversary	18		FLS Softail Slim	16▲
	FXFBS Fat Bob 114	18		FLSTC 103 Heritage Softail Classic	13-15▲
			FLSTC 103 ANV Heritage Softail Classic ANV	13▲	
SRK7009 ▲=CT703SP	HARLEY DAVIDSON			FLSTC Heritage Softail Classic	04-05▲
	FLHP Road King Police	11-16▲		FLSTC Heritage Softail Classic	16-17▲
	FLHPE Road King Police	11▲		FLSTCI Shrine Heritage Softail Classic Shrine	05▲
	FLHTCUTG Tri Glide Ultra Classic	09-13▲		FLSTF 103 Fat Boy	12-15▲
	FLHTCUTG ANV Tri Glide Ultra Classic Anv	13▲		FLSTF Fat Boy	04-05▲
	FLHTP Electra Glide Standard Police	11-16▲			
	FLHXXX Street Glide Trike	10-11▲			
	FXDLS Dyna Low Rider S	16-20▲			

Part No.	Make/Model	Year	Part No.	Make/Model	Year	
SRK7012 ▲=CT703SP Contd.	HARLEY DAVIDSON		SRK7014 ▲=CT701SP	HARLEY DAVIDSON		
	FLSTF Fat Boy	16-17 ▲		FLHR Road King	93-97 ▲	
	FLSTFB 103 Fat Boy LO	12-17 ▲		FLHS Electra Glide Sport	91-94 ▲	
	FLSTFB 103 ANV Fat Boy LO ANV	13 ▲		FLHT Electra Glide Standard	94-97 ▲	
	FLSTFI Shrine Fat Boy Shrine	05 ▲		FLHTC Electra Glide Classic	91-97 ▲	
	FLSTN 103 Softail Deluxe	12-15 ▲		FLHTCU Ultra Classic	91-97 ▲	
	FLSTN Softail Deluxe	05 ▲		FLTC Tour Glide Classic	91-96 ▲	
	FLSTN Softail Deluxe	16-17 ▲				
	FLSTSC Springer Classic	05-06 ▲		SRK7015 ▲=CT701SP	HARLEY DAVIDSON	
	FLTRI Road Glide	04-05 ▲			FLHS Touring Electra Glide Sport	90 ▲
	FLTRU Road Glide Ultra	11-13 ▲			FLHTC Touring Electra Glide Classic	90 ▲
	FLTRX 103 Road Glide Custom	11-13 ▲	FLHTCU Touring Electra Glide Classic Ultra		90 ▲	
	FXD Dyna Super Glide	04-05 ▲	FLTC Touring Tour Glide Classic		90 ▲	
	FXDB 103 Dyna Street Bob	14-16 ▲	FLTCU Touring Tour Glide Classic Ultra		90 ▲	
	FXDB 103 Dyna Street Bob 103	17 ▲				
	FXDBA 103 Dyna Street Bob (H-D1)	13-15 ▲	SRK7016 ▲=CT705SP		HARLEY DAVIDSON	
	FXDBC 103 Dyna Street Bob Limited	16 ▲			FLH Touring Electra Glide	84 ▲
	FXDC 103 Dyna Super Glide Custom	14 ▲			FLH Touring Electra Glide Shrine Shovelhead	84 ▲
	FXDC Dyna Super Glide Custom	05 ▲		FLHS Touring Electra Glide Sport	84-89 ▲	
	FXDF 103 Dyna Fat Bob	12-17 ▲		FLHT Touring Electra Glide Standard	88 ▲	
	FXDI Dyna Super Glide	04-05 ▲		FLHT Electra Glide Classic	84 ▲	
	FXDL 103 Dyna Low Rider	14-16 ▲		FLHT Electra Glide	84 ▲	
	FXDL 103 Low Rider 103	17 ▲		FLHTC Touring Electra Glide Classic	84-89 ▲	
	FXDL Dyna Low Rider	04-05 ▲		FLHTCU Touring Electra Glide Classic Ultra	89 ▲	
	FXDWG 103 Dyna Wide Glide	12-16 ▲		FLST Softail Heritage	86-89 ▲	
	FXDWG 103 Dyna Wide Glide 103	17 ▲		FLSTC Softail Heritage Classic	87-89 ▲	
	FXDWGI Dyna Wide Glide	04-05 ▲		FLT Classic Tour Glide Classic	84 ▲	
	FXDX Dyna Super Glide Sport	04-05 ▲		FLT Tour Glide	84 ▲	
	FXS 103 Blackline	11-13 ▲		FLTC Touring Tour Glide Classic	84-89 ▲	
	FXSB 103 Softail Breakout	13-16 ▲		FLTCU Touring Tour Glide Classic Ultra	89 ▲	
	FXSB Breakout	17 ▲		FXE FX Super Glide	84 ▲	
	FXST 1BHY Softail Standard	04-06 ▲		FXEF FX Super Glide Fat Bob	85 ▲	
	FXST Softail Standard	12-15 ▲	FXSB FX Low Rider	84-85 ▲		
	FXSTB Night Train	04-05 ▲	FXST Softail Standard	84-89 ▲		
	FXSTD Softail Deuce	04-05 ▲	FXSTC Softail Custom	86-89 ▲		
	FXSTS Springer Softail	04-05 ▲	FXSTS Softail Springer	88-89 ▲		
			FXWG FX Wide Glide	84-86 ▲		
	SRK7013 ▲=CT703SP	HARLEY DAVIDSON		SRK7017 ▲=CT704SP	HARLEY DAVIDSON	
		FLD Dyna Switchback	12-16 ▲		FLH Touring Electra Glide	EARLY 84 ▲
		FLHR Road King	06-11 ▲		FLH Touring Electra Glide Shrine Shovelhead	EARLY 84 ▲
		FLHRC Road King Classic	06-11 ▲		FLHS Touring Electra Glide Sport	EARLY 84 ▲
FLHRS Road King Custom		06-07 ▲	FLHT Electra Glide		EARLY 84 ▲	
FLHT Electra Glide Standard		06-10 ▲	FLHT Electra Glide Classic		EARLY 84 ▲	
FLHTC Electra Glide Classic		06-11 ▲	FLT Classic Tour Glide Classic		EARLY 84 ▲	
FLHTCU Ultra Classic		06-11 ▲	FLT Tour Glide		EARLY 84 ▲	
FLHX Street Glide		06-11 ▲	SRK7018 ▲=CT704SP		HARLEY DAVIDSON	
FLS Softail Slim		12-15 ▲			FLH Touring Electra Glide Shrine Shovelhead	83 ▲
FLST Heritage Softail		06-09 ▲		FLH Electra Glide	81-83 ▲	
FLSTC 103 Heritage Softail Classic		06-15 ▲		FLHC Touring Electra Glide Classic	81-82 ▲	
FLSTC ANV Heritage Softail Classic ANV		13 ▲		FLHC Electra Glide Classic	81 ▲	
FLSTF Fat Boy		06-15 ▲		FLHS Touring Electra Glide Sport	81-83 ▲	
FLSTFB Fat Boy LO		10-15 ▲		FLHS Heritage, Electra Glide	81 ▲	
FLSTFB ANV Fat Boy LO ANV		13 ▲		FLHT Touring Electra Glide Standard	83 ▲	
FLSTN Softail Deluxe		06-15 ▲		FLHT Electra Glide Classic	83 ▲	
FLSTSB Cross Bones		08-11 ▲		FLHT Electra Glide	83 ▲	
FLSTSC Springer Classic		06-07 ▲		FLHTC Touring Electra Glide Classic	83-84 ▲	
FLTR Road Glide		06-09 ▲		FLT Touring Tour Glide	81-83 ▲	
FLTRX Road Glide Custom		10-11 ▲		FLT Classic Tour Glide Classic	81-83 ▲	
FXCW Rocker		08-09 ▲		FLT Tour Glide	81-83 ▲	
FXCWC Rocker C		08-11 ▲		FLTC Touring Tour Glide Classic	80-84 ▲	
FXD Dyna Super Glide		07-10 ▲		FXB Super Glide B80	81-82 ▲	
FXD35 Dyna 35th Anniversary Super Glide		06 ▲		FXDG Dyna Glide Glide Custom	83 ▲	
FXDB Dyna Street Bob		07-17 ▲	FXE FX Super Glide	81-84 ▲		
FXDBC Dyna Street Bob Limited		16 ▲	FXEF FX Super Glide Fat Bob	81 ▲		
FXDC Dyna Super Glide Custom		07-14 ▲	FXS FX Super Glide	81-82 ▲		
FXDC ANV Dyna Super Glide Custom ANV		13 ▲	FXSB FX Low Rider	83-84 ▲		
FXDCI Dyna Super Glide Custom		06 ▲	FXST Softail Standard	84 ▲		
FXDF Dyna Fat Bob		08-17 ▲	FXWG FX Wide Glide	81-84 ▲		
FXDI Dyna Super Glide		06 ▲				
FXDL Dyna Low Rider		06-17 ▲				
FXDWG Dyna Wide Glide		06-16 ▲				
FXDWG ANV Dyna Wide Glide 105th Anniversary		08 ▲				
FXSB Softail Breakout		13-15 ▲				
FXST Softail Standard		07-11 ▲				
FXSTB Night Train		06-09 ▲				
FXSTC Softail Custom		07-10 ▲				
FXSTD Softail Deuce		06-07 ▲				
FXSTS Springer Softail		06 ▲				

Part No.	Make/Model	Year	Part No.	Make/Model	Year
SRK7019 ▲=CT701SP	HARLEY DAVIDSON				
	FLST Softail Heritage	90 ▲			
	FLSTC Heritage Softail Classic	90-97 ▲			
	FLSTF Fat Boy	91-97 ▲			
	FLSTF Softail Fat Boy	90 ▲			
	FLSTN Heritage Softail Nostalgia	93-96 ▲			
	FLSTS Heritage Springer	97 ▲			
	FXD Dyna Super Glide	95-97 ▲			
	FXDB Dyna Daytona	92 ▲			
	FXDB Dyna Sturgis	91 ▲			
	FXDC Super Glide Custom	92 ▲			
	FXDL Dyna Low Rider	93-97 ▲			
	FXDS-CONV Dyna Glide Convertible	93 ▲			
	FXDWG Dyna Wide Glide	93-97 ▲			
	FXST Softail Standard	90 ▲			
FXSTC Softail Custom	90-97 ▲				
FXSTS Springer Softail	90-97 ▲				
SRK7020 ▲=CT701SP	HARLEY DAVIDSON				
	XL1200 Forty Eight Anniversary	18 ▲			
	XL1200C Sportster 1200 Custom	04-20 ▲			
	XL1200C Sportster 1200 Custom ANV	13 ▲			
	XL1200CA Sportster 1200 Custom Limited A	13-16 ▲			
	XL1200CB 1200 Custom Limited B	17 ▲			
	XL1200CB Sportster 1200 Custom Limited A	13-16 ▲			
	XL1200CP Sportster 1200 Custom (H-D1)	11-16 ▲			
	XL1200CX 1200 Roadster	16-20 ▲			
	XL1200L Sportster 1200 Low	06-11 ▲			
	XL1200N Nightster	07-12 ▲			
	XL1200R Sportster 1200 Roadster	04-09 ▲			
	XL1200T SuperLow 1200T	14-20 ▲			
	XL1200V Seventy-Two	12-16 ▲			
	XL1200X Forty Eight	10-20 ▲			
XL50 50th ANV Sportster	07 ▲				
SRK7021 ▲=CT701SP	HARLEY DAVIDSON				
	XL883 Sportster 883	04-09 ▲			
	XL883C Sportster 883 Custom	04-10 ▲			
	XL883L Sportster XL883 Low	05-11 ▲			
	XL883L SuperLow	14-16 ▲			
	XL883L SuperLow	12-20 ▲			
	XL883N Iron 883	09-20 ▲			
XL883R 883 Roadster	11-15 ▲				
XL883R Sportster 883R	07-10 ▲				
SRK7022 ▲=CT701SP	HARLEY DAVIDSON				
	XR1200 Sportster 1200	08-10 ▲			
XR1200X XR1200X	10-13 ▲				
SRK7023 ▲=CT701SP	HARLEY DAVIDSON				
	XL1200 Sportster 1200	91-03 ▲			
	XL1200C Sportster 1200 Custom	96-03 ▲			
	XL1200S Sportster 1200 Sport	96-03 ▲			
	XL883 Sportster 883	91-03 ▲			
	XL883C Sportster 883 Custom	98-03 ▲			
	XL883DLX Sportster 883 Deluxe	91-95 ▲			
	XL883HUG Sportster 883 Hugger	91-03 ▲			
XL883R Sportster 883R	02-06 ▲				
SRK7024 ▲=CT701SP	HARLEY DAVIDSON				
	XL1200 Sportster 1200	88-90 ▲			
	XL883 Sportster 883	86-90 ▲			
	XL883 Sportster 883 Deluxe	86-90 ▲			
	XL883HUG Sportster 883 Hugger	87-90 ▲			
	XLH 1100 Sportster 1100	86-87 ▲			
	XLH Sportster 1000	84-85 ▲			
	XLS Sportster Roadster 1000	84 ▲			
XR-1000 Sportster	84 ▲				
SRK7025 ▲=CT701SP	HARLEY DAVIDSON				
	XLCH-1000 Sportster 1000	71-84 ▲			
	XLH-1000 Sportster 1000	79-80 ▲			
	XLH-1000 Sportster Standard	71-78 ▲			
	XLS 1000 Sportster Roadster	81-84 ▲			
XR 1000 Sportster	83-84 ▲				

CLUTCH TOOL BUYERS GUIDE

Part No.	Make/Model	Year	Part No.	Make/Model	Year
CT001	HONDA		CT004 Contd.	KAWASAKI	
	CR 125 R	85-07		Z 200 A1 (From E.No:-005063)	78
	CRF 250 R	04-20		Z 200 A2-A6	79-83
	CRF 250 RE (Limited Road Use)	16		KL 250 A1-A4/C1/C2	78-84
	CRF 250 RX	18-20		KLR 250 D2-D22	84-05
	CRF 250 X	04-17		KLT 250 C1-C3	83-85
	CRF 250 XRL (Road Legal)	14-16		KSF 250 A1-A18 (KXF250 Mojave)	87-04
	GAS-GAS			KX 250 F (KX 250 N1/N2/T6F/T7F/T8F) (4T)	04-08
	EC 125 (2T)	00-08		KX 250 (W9F/XAFB/YBF/YCF/ZDF/ZEF /ZFF/ZGF/AHF) (4T)	
	SM 125 (2T) Supermotard	03-06		Z 250 C1/C2/G1/G2	09-17
	HUSQVARNA			ZR 400 D1/D3/D4 Xanthus	80-83
	CR 125	00-11		ZXR 400 H1/H2	92-95
	WR 125	00-11		ZXR 400 (ZX 400 L1-L5/L8/L9)	89
	WRE 125	00-11		ZXR 400 R (ZX 400 M1-M4)	91-02
	SMS 125	00-11		ZX 400 J1/J2	91-94
	KTM			H1500 Mach 111	89-90
	125 EGS	98-99		H1-A500 S Mach 111	69-70
	125 EXE	00-01		H1-B/C500 Mach 111	71
	125 Supermoto	00-01		H1-D/E/F500	72
	EXC 125	98-15		H1500 Mach 111	73-75
	EXC 125 Six Days	11-15		KH 500 A8	76
	SX 125	98-20		ZX6 R F1/F2/F3/G1/G2	95-99
	125 SXS	01-02		ZX6 R (ZX 600 J1/J2)	00-01
	SX 150	08-20		ZX6 R (ZX 600 P7F/P8F/RF9/RAF /RBF/RCF/RDF/REF/RFF/RGF (599cc)	07-16
	XC 150	11-13		ZX6 R (ZX 636 A1P) 636cc	02
	XC-W 150	17-20		ZX6 R (ZX 636 B1/B2)	03-04
	200 EGS	98-99		ZX6 R (ZX 636 C1/C6F)	05-06
	200 EXC	97-14		ZX-6R EDF/EEF/FFF/EGF/EHF (Non ABS 636cc)	13-17
	200 MXC	98-03		ZX-6R FDF/FEF/FFF/FGF/FHF (ABS 636cc)	13-17
	SX 200	03/06-07		ZX-6R (ZX 636 EGFA/EHFA - Non ABS /KRT Edition - 636cc)	16-17
	SX-F 250 (4T)	05-12		ZX-6R (ZX 636 FGFA/FHFA - ABS/KRT Edition - 636cc)	16-17
	EXC-F 250 (4T)	06-13		ZX6 R 30th Anniversary Edition (ZX 636 EFFA - Non ABS - 636cc)	15
	EXC-F 250 Six Days (4T)	11-13		ZX6 R 30th Anniversary Edition (ZX 636 FFFA- ABS - 636cc)	15
	XC-F 250 (4T)	11-12		ZX6 RR (ZX 600 K1/M1/N1/N6F)	03-06
	MORIWAKI/HONDA			H2/H2-A Mach IV (750cc)	72-73
	MD 250 H	08-11		H2-B/H2-C Mach IV (750cc)	74-75
	MD 250 S	08-11		Z 750 (ZR 750 J1/J2/J6F)	04-06
				Z 750 S (ZR 750 K1/K6)	05-07
				Z 750 (ZR 750 L7F/L8F/L9F/LAF/LAS)	07-10
				Z 750 ABS (ZR 750 M7F/M8F/M9F/MAF/MAS)	07-10
				Z 750 R Non ABS (ZR 750 NBF/NCF)	11-12
				Z 750 R Black Edition (ZR 750 NBFA)	12
				Z 750 R ABS (ZR 750 PBF/PCF)	11-12
				Z 800 ADS/AEF/AFF/AGF (Non ABS)	13-16
				Z 800 BDS/BEF/BFF/BGF (ABS Model)	13-16
				Z 800 E CDS/CEF/CFE/CGF (Non ABS)	13-16
				Z 800 E DDS/DEF/DFE/DGF (ABS Model)	13-16
		Z 900 (ZR 900 A)	17-19		
		Z 900 ABS (ZR 900 B)	17-19		
		Z 900 RS (ZR 900 C)	18-19		
		Z 900 RS Café (ZR 900 E)	18-19		
		ZX9 R (ZX 900 C1/C2)	98-99		
		ZX9 R (ZX 900 E1/E2/F1/F2)	00-03		
		KLZ 1000 ACF/ADF/AEF - Versys	12-14		
		Z 1000 (ZR 1000 A1/A2/A3/A6F/B7F/B8F)	03-08		
		Z 1000 (ZR 1000)	07-08		
		Z 1000 ABS (ZR 1000 C7F/C8F/C9F)	07-09		
		Z 1000 (ZR 1000 DAF/DBF/DCF/DDF)	10-13		
		Z 1000 Black Edition (ZR 1000 DCFA/DDFA)	12-13		
		Z 1000 (ZR1000 EAF/EBF/ECF/EDF/GEF/ GFF)	10-15		
		Z 1000 Special Edition (ZR1000 GEFA)	14		
		Z 1000 SX ABS Model (ZX 1000 HBF/HCF/HDF)	11-13		
		Z 1000 SX Non ABS Model (ZX 1000 GBF/GCF/GDF/LEF/LFF)	11-15		
		Z 1000 DAF/FAS/DBF/DCF/DCFA/DDF /DDFA (5 Spring Clutch)	10-13		
		Z 1000 EAF/EBF/ECF/ECFA/EDF/EDFA (5 Spring Clutch)	10-13		
		Z 1000 FEF/FEFA/FFF (5 Spring Clutch)	14-15		
		Z 1000 GEF/GEFA/GFF (5 Spring Clutch)	14-15		
CT002	HONDA				
	CR 125 M2-M4	76-78			
	CR 125 RB/RC	81-82			
	CRF 150 R (Small Wheel F 17" / R 14"	07-19			
	CRF 150 RB (Big Wheel F 19" / R 16"	07-19			
	VT 250 FD	83			
	RVF 400 RR/RT/RR-II/RT-II (NC35 -100/110)	94-96			
	VF 400 FD	83-85			
	VFR 400 R3K/R3L/R3M/R3N (NC30)	89-92			
	VFR 400 ZG/ZH/RG/RG-YA (NC21)	85-86			
VFR 400 RH2/RJ (NC24)	87-88				
VF 500 FE/F2E/FF/F2F	84-85				
KAWASAKI					
KX 80 W1/W2/W3	98-00				
KX 85 I (17" Front/14" Rear Wheel)	01-20				
KX 85 II (19" Front/14" Rear Wheel)	01-20				
KX 100 C1/C2/C3	98-00				
AR 125 A1A/A1-A7/B1-B8	83-94				
KMX 125 A1/A2	86-87				
KMX 125 B1/B2 (From E.No. - MX 125 AE 000001-013436)	86-87				
KMX 200 A2/A3	88-92				
SUZUKI					
RM 100 K3	03				
GSX 400 R/S/T/X/ZR/ZS/ZT					
Impulse Type S	94-99				
RF 400 RP/RR/VR/RT/RVT/RV-V (GK78A)					
RV 400 RP/RR	93-				
CT003	SUZUKI				
	RM 125 N/P/R/S/T/V/W/X/Y/K1	92-01			
	RM 125 K2/K3/K4/K5/K6/K7/K8/K9	02-12			
	RM 125 XCK8	09			
CT004	KAWASAKI				
	KX 125 K1/K2/K3/K4/K5/L1-L4	94-02			
	KX 125 M1/M2/M3/M6F/M7F/M8F	03-08			
	Z 200 A1 (Up to E.No:-005062)	77			

Part No.	Make/Model	Year	Part No.	Make/Model	Year		
CT004 Contd.	KAWASAKI		CT006 Contd.	KLX 450 R (A8F/A9F/AAF/ABF/ACF /ADF/AEF/AFF/AGF)	08-16		
	Z 1000 (ZR1000 GGF) 3 Spring Clutch	16		KX 450 F	06-20		
	Z 1000 (ZR1000 FGF) 3 Spring Clutch	16		KX 500 A1/A2	83-84		
	Z 1000 SX ABS Model (ZX 1000 MEF/MFF)	14-15		KX 500 C1/D1/E1-E16	87-04		
	Z 1000 SX Tourer	14-19		SUZUKI			
	Z 1000 SX ABS (ZX1000 MGF) (3 Spring Clutch)	16		DR-Z 400 SY/EY/Y/SK1/EK1/K1 /SK2/EK2/K2/SK3/EK3/K3/SK4 /EK4/K4/EK5/SK5/K6/SK6/EK6 /SK7/EK7/K7/SK8/SK9	00-09		
	Z 1000 SX Non ABS (ZX1000 LGF) (3 Spring Clutch)	16		DR-Z 400 SMK5/SMK6/SMK7/SMK8/SMK9	05-09		
	ZX10R (ZX 1000)	04-05		LT-F 400 K2 (Eiger)	02		
	ZX10R (ZX 1000 C1/C2/D6F/D7F/E8F/E9F/FAF)	04-10		LT-F 400 FK2-FK7 (Eiger 4WD)	02-07		
	ZX10R ABS (ZX 1000 KBF/KCF/KDF/KEF/KFF)	11-15		LT-F 400 FK8/FK9/FL0/FL1 King Quad 4WD	08-12		
	ZX10R (ZX 1000 JBF/JCF/JDF/JEF/JFF)	11-15		LT-F 400 K3-K7 Eiger 2WD	03-07		
	ZX10R 30th Anniversary Edition (ZX 1000 KFFA/ABS)	15		LT-Z 400 K3/K4	03-04		
	ZX10R 30th Anniversary Edition (ZX 1000 JFFA/Non ABS)	15		LT-Z 400 K5/K6/K7/K8/K9/L0/L1/L2/L3 Quadsport	05-15		
	ZX 10R (ZX1000 SGF)	16-19		LT-F 500 FW/FX/FY/FK1/FK2	98-02		
	ZX 10R Winter Test Edition (ZX1000 SGFB)	16		LT-F 500 FK3-FK7	03-07		
	ZX 10R Ninja KRT Replica (ZX1000 SGFA)	16-19		ARCTIC CAT ATV 4 WHEELERS			
	ZX-10RR	17-19		400 (2 x 39906 x 4)	98-		
	ZX-10RR Performance	17-19		400 (2 x 4)	98		
	ZZR 1400 Performance Sport (ZX1400 JGF)	14-19		400 (2 x 39906 x 4)	00-02		
	ZZR 1400 ABS Performance	12-19		400 (2 x 39906 x 4)	03-04		
	SUZUKI			400 (4 x 4 Manual)	05-08		
	RM-Z 250 K4/K5/K6/K7/K8/K9/L0/L1-L9	04-19		400 DVX	04-06		
	GSXR 1000 K1/K2/K3/K4	01-04		400 DVX	07-08		
	GSX-S 1000 L6/L7 (Naked/Non ABS)	16-17		Bearcat 454 (4 x 4)	96-98		
	GSX-S 1000 AL6/AL7 (Naked/ABS)	16-17		Bearcat 454 (2 x 4)	97-98		
	GSX-S 1000 FL6/FL7 (Faired/Non ABS)	16-17		500 (4 x 4)	98-02		
	GSX-S 1000 FAL6/FAL7 (Faired/ABS)	16-17		500 (4 x 4 Manual)	03-09		
	CT005	YAMAHA			CT007	KTM	
		YZ 125 B/D/E/F/G/H/J/K/L/M/N/P/R /S/T/V/W/X/Y/Z/A/B/D/E/F/G (2T)		91-16		SX 250 (2T)	94-12
		RI-Z (250cc/3XC)		90-92		250 EGS	94-99
		XT 250 Serrow (3C51/2)		05-08		EXC 250 (2T)	94-12
		TT 250 R (4GY1 Japan - 6 Plate Clutch)		93-94		EXC 250 Six Days (2T)	11-12
		TT 250 R (4RR1/2 Japan - 6 Plate Clutch)		95-97		250 MXC	98-99
TT 250 R (4GY3/4GY5/4WA1 - Raid - Japan - 6 Plate Clutch)		94-96	250 SXS	01-03			
TT 250 R (4MR2 - UK - 6 Plate Clutch)		96	XC 250 (2T)	11-12			
TT 250 RL (4PX5 - 6 Plate Clutch)		99	300 EGS	94-99			
TT 250 RM (4PX6 - 7 Plate Clutch)		00	EXC 300 (2T)	00-12			
TY 250 Z		93-96	EXC 300 Six Days (2T)	11-12			
TZR 250 R (3XV1/3XV4/3XV6 - V-Twin - Eng/Frame # 3XV 000101-08600)		91-93	300 EXC	94-07			
WR 250 FN/FP/FR/FS/FT/FV/FW /FX/FY/FZ/FA/FB/FD (4T)		01-13	300 MXC	94-05			
WR 250 FF/FG (4T/Reverse Cylinder)		15-16	XC 300 (2T)	11-12			
WR 250 R		08-20	SX 300	94			
WR 250 XX/XY (Supermoto) (32D2/4)		08-15	300 Six Days	96			
XG 250 Tricker (5XT1)		04-06	360 EGS	96-97			
XT 250 X		06	360 EXC	96-97			
YFM 250 R (33B)		09-11	360 MXC	96-97			
YFM 250 R (1BT)		12-13	360 SX	96-97			
YZ 250 FN/FP/FR/FS/FT/FV/FW /FX/FY/FZ/FA/FB/FD/FE/FF (4T)		01-15	360 Six Days	96			
CT006		KAWASAKI		CT008		YAMAHA	
		ER 250 B1/B2/B3 Scorpion	83-88			XV 125 Virago	97-00
	KDX 250 B1/B2/B3	81-83	XVS 125 Drag Star		00-03		
	KDX 250 D1	91-93	DT 250		75-76		
	KX 250	74	IT 250 G/H/J		80-82		
	KX 250 A/A3/A4/A5/A6/A7/B1/C1/C2	75-84	RD 250 A/B/C/D/E/F		74-79		
	KX 250 E1/F1/G1/H1/H2	87-91	RD 250 LC		80-82		
	KXF 250 A1/A2	87-88	RZ 250 R (1AR/1XG)				
	KXT 250 A1/A2/B1/B2 Tecate	84-87	RZ 250 R (29L)				
	Z 250 A1-A3/B1/B2	79-81	RZ 250 RR (51L)				
	KEF 300 B1/B2 Lakota Sport	01-02	RZ 250 (4L3)				
	KLF 300 A1/A2/B1-B17/C1-C17	87-05	SR 250 (US Custom/3Y8/6 Plate Clutch)		80-81		
	GPz 305 A1/B2-B10	83-96	SR 250 SE (Special/3Y8/5 Plate Clutch)		81-83		
	KLF 400 B1-B7	93-98					
	KLX 400 R (KLX 400 B1/B2)	03-04					
	KSF 400 A1/A2/A3/A6F (KFX 400)	03-06					
	KX 420 A1/A2	80-81					
	KFX 450 R Quad (KSF 450 B8F/B9F /BAF/BBF/BCS/BFD/BEF)	08-14					

Part No.	Make/Model	Year	Part No.	Make/Model	Year	
CT008 Contd.	YAMAHA Contd.		CT008 Contd.	YAMAHA Contd.		
	SR 250 (4GR1/2/3/4/5 Plate Clutch)	94-96		XT 600 E (Electric Start Only)	90-03	
	SR 250 (Classic/21L/5 Plate Clutch)	96-00		SZR 660	96-97	
	SRV 250 Soulful Twin/Renaissa (4DN1-6)	92-97		XTZ 660 Tenere	91-97	
	SRX 250			YFM 660 RN/RP/RR/RS/RT Raptor	01-05	
	TYR 250 D/E	77-78		XTZ 750	89-95	
	TZR 250 (3MA1 - Reverse Cylinder - Eng/Frame # 3MA 0001-)	89		TDM 850	91-01	
	TZR 250 (3MA3/3MA5 - Reverse Cylinder - Eng/Frame # 3MA - 0.793103448275862 -)	89-90		TRX 850	96-98	
	XS 250 C/D/E	78-80		TDM 900 (5PS/Non ABS)	02-14	
	XS 250 SE/C	80-81		TDM 900 A (2B0/ABS)	05-13	
	XT 250	80		DERBI		
	XV 250 Virago	89-94		Mulhacen 659	06-07	
	XV 250 S Virago	95-00				
	XVS 250 Dragstar	01-04		CT008SP	YAMAHA	
	YZ 250 D/E/F/G/H (2T)	77-81			XJ 550	81
	YDS7 250cc	72			XJ 550 H/J/K Maxim	81-83
	R5/5A/5B 350cc	70-72			XJ 550 RH/RJ/RK Seca	81-83
	RD 350/A/B	73-75			FZ 600	87-88
	RD 350 LC/YPVS	80-84			FZ6 - Naked - Non-ABS	
	RD 350 N/F/F2/R	85-95	/2 Piston Caliper (1B3/1B3D)		04-07	
	TT 350 A (3GJ)	90-95	FZ6 NS - Naked/Non-ABS			
	TT 350 (ITJ)	85-89	/2 Piston Caliper (1B35/1B6)		05-06	
	XT 350	85-95	FZ6 S2 - Naked/Non ABS			
	YFM 350 FWT/FWU/FWW/FWA /FWE Big Bear	86-93	/4 Piston Caliper (5S51/5S5)		07-09	
	YFM 350 FWF/FWG/FWH/FWJ	94-97	FZ6 Fazer - Half Fairing/Non ABS			
	YFM 350 XD/XE/XF/XG/XH/XJ/XK /XL/XM/XN/XP/XR/XS	92-04	/2 Piston Caliper (5VX/5VXL)		04-07	
	YFM 350 ERD/ERE/ERF	92-94	FZ6 Fazer - Half Fairing/ABS			
	YFM 350 ERG	95	/2 Piston Caliper (4P5)		06-07	
	YFM 350 FX Wolverine All models	95-04	FZ6 Fazer S2 - Half Fairing/Non ABS			
	YFM 350 UH/UJ	96-97	/4 Piston Caliper (4S81/4S8)		07-09	
	YFM 350 S/T/V/R-WV/RW/RX/RY Raptor	04-09	FZ6 Fazer S2 - Half Fairing/ABS			
	YFZ 350 T/U/W/A/B/D/E/F/G/H /J/K/L/M/N/P/R/S/T/V Banshee	87-09	/4 Piston Caliper (5S2)		08	
	DT 400	75-76	XJ 600		84-92	
	DT 400 MX	77-79	XJ 600 S Diversion		92-03	
	FZ 400 N (IFK/33M/46X)	85	XJ 600 N		95-03	
	RD 400 C/D/E/F	76-79	XJ6-N 600 (Naked - Non ABS & ABS Model - 20S)		09-15	
	SR 400 (3HT1)	88	XJ6-F Diversion 600 (Full Fairing Diversion - Non ABS & ABS Models - 1CW)		10-15	
	SR 400 (2RD)	14-16	XJ6-S Diversion 600 (Top Fairing Diversion - Non ABS & ABS Models - 36C)		09-15	
	SRX 400 (1JL)		XJ6-SP Diversion 600 (Non ABS & ABS Models)		13	
	SRX 400 (3VN1/3VN2/3VN5)	90-96	YZF 600 R R6 (8 plate)		99-02	
	XJR 400 (4HM1/4HM2/4HM4/4HM7)	93-96	YZF-R6 (8 plate)		03-05	
	XJR 400 (4HM3/4HM5/4HM6 /4HM9/4HMA/4HMB)	95-99	YZF R6 (9 plate)		06-20	
	XS 400	78-79	XJ 650		80-84	
	XS 400 SE	80	XJ 650 Turbo		82	
	YZ 400 D/E/F (2T)	77-79	XJ 650 G/H/J/K Maxim		80-83	
	YZ 400 FK/FL (4T)	98-99	XJ 650 LH Midnight		81	
	WR 400 FK/FL/FM/FN (4T)	98-01	XJ 650 RJ/LK Seca		82-83	
	IT 425 G	80	FZX 700 S/SC/T/TC Fazer		86-87	
	IT 465 H/J	81-82	FZ 750		85-92	
	YZ 465 G/H	80-81	FZX 750		87	
	SR 500	78-82	FZR 750		87	
	SR 500 S (3GWS)	98	FZR 750 R OW01		89-90	
	SR 500 (3GW1/4/6/7)	96-98	XJ 750		82-83	
	TT 500 G/H	80-81	XJ 750 RF/RJ/RK Seca		81-83	
	XT 500 C	76	XS 750	77-79		
	XT 500	77-81	XS 750 SE	79-80		
XS 500 B/C/D	77-79	YZF 750 R/SP	93-97			
XT 550	82-83	XS 850	80			
XZ 550	82	XJ 900	83/90			
SRX 600	86-87	XJ 900 F	85-92			
SRX 600 (1JK/3SX)	85-91	XJ 900 S Diversion	95-03			
TT 600 L (Kick Start Only)	84	FZR 1000 (2RG - Genesis Non EX-UP)	87-88			
TT 600 N (59X) Frame # 59X 000101-7852 (Kick Start Only)	85-88	FZR 1000 (3GM1/3/5/7/8-3LG1/2/3/4-3LH1 /2/3/4-3LE1/2/3/4 - EX-UP Models)	89-92			
TT 600 W (2JT/3SU1) Frame # 59X 7853 Onwards (Kick Start Only)	89-92	FZR 1000 (3GME/F-3LG5/6-3LH5/6-3LE /5-3LG6-3LJ6-4PM1 - EX-UP Models)	93-95			
TT 600 R (5CH1/2/3/4) (Kick Start Only)	97-02	FZS 1000 Fazer	01-05			
TT 600 RE (5CH5) (Electric Start Only)	04	GTS 1000	93-96			
TT 600 E (Electric Start Only)	94-01	YZF 1000 Thunder Ace	96-02			
TT 600 K (Kick Start Only)	93-96					
XT 600 (Kick Start Only)	84-87					
XT 600 Z (Kick & Electric Start)	84-90					

Part No.	Make/Model	Year	Part No.	Make/Model	Year
CT009	HONDA		CT009 Contd.	HONDA	
	CB 250 K3-K5	73-75		CB 1300 F3/F13	03-04
	CB 250 G5	75-76		CB 1300 5/6/7/8/9 (Superfour)	05-09
	CJ 250 T/T2	77		CB 1300 A5-A8 (Superfour ABS)	05-08
	CR 250 RB/RC/RD/RE/RF/RG/RH/RJ/RK /RL/RM/RN/RP/RR/RS/RT/RV/RW/RX /RY/R1-R7	81-07		CB 1300 SA5/SA6/SA7/SA8 Super Bol-Dor	05-08
	TL 250/TL 250 K1	78-79		HONDA DALL-ARA	
	XL 250 K3/K4	78-79		XR 650 R	04
	CB 350 K4			KAWASAKI	
	CB/CJ 360 all models			EX 250 K8F/K9F/KAF/KBF/KBFA /KCF Ninja 250R	08-12
	CR 450 RB	81		EX 300 ADF/AEF/AFF Ninja 300 (Non ABS)	13-15
	CRF 450 R2/R3	02-03		EX 300 AEFA/AFFA Ninja 300 Special Edition (Non-ABS)	13-15
	CRF 450 R4/R5/R6/R7/R8 (6 Spring Type)	04-08		EX 300 BDF/BEF/BFF/BGF Ninja 300 (ABS)	13-16
	CRF 450 R9/RA (4 Spring type)	09-10		EX 300 BEFA/BFFA/BGFA Ninja 300 Special Edition (ABS)	13-16
	CRF 450 RB/RC	11-12		Z 300 Non ABS (ER 300 AFF)	15
	CRF 450 RD/RE/RF/RG (6 Spring Type)	13-16		Z 300 ABS (ER 300 BFF) - Ninja 300 (ABS)- Floating Disc Conversion	15-16
	CRF 450 RE (Limited Road Use)	16		Versys-X 300 ABS	17-20
	CRF 450 X5/X6/X7/X8/X9/XB/XC/XD/XF/XG/XH	05-17		ZX12 R (ZX 1200 A1/A2/A3/A4/B1-B4/B6F)	00-06
	CRF 450 XRL (Road Legal)	14-16		SUZUKI	
	TRX 450 R4/R5/R6/ER6/R7/ER7 /R8/ER8/R9/ER9	04-09		GSXR 1000 K9/L0/L1/L2/L3/ZL3/L4/Z L4/L5/AL5/AL6/AL7	11-20
	CR 480 RC/RD	82-83		GSXR 1000 AL7	17
	CB 500/K1/K2 (Four)	75-77		TL 1000 RW/RX/RY	98-00
	CR 500 RE/RG/RH/RJ/RK	84-89		TL 1000 SX/SY	99-00
	CR 500 RL/RM/RN/RP/RS /RT/RV/RW/RX/RY/R1	90-01		TL 1000 SK1	01-02
	NX 500 J/K/L/M/N/P/R/S/T/V/W/X Dominator	88-99		TL 1000 RK1	01-02
	XBR 500 F/G/H/SH/SJ	85-89		GSX 1400 K1/K2/K3/K4/K5/K6/K7	01-07
	XR 500 RD/RE	84-85		GAS-GAS	
	XL 600 RD/LD/RE/LE/RF/RG/RH	83-87		EC 200/250/300(2T)	00-08
	XL 600 LMF/RMG/LMH	85-87		EC 450 FSR/FSE (4T) Enduro	05-08
	XR 600 RF/RG/RH/RJ/RK/RL/RM /RP/RR/RS/RT/RV/RW/RX/RY	84-00		SM 450 FSR (4T) Supermotard	07-08
	FMX 650 39968	05-08		Wild HP 450 Quad	04-08
	FX 650 X/Y Vigor	99-03		EC 515 FSR/FSE (4T) Enduro	05-08
	NX 650 J/K/L/M/N/P/R/S/T/V/W/X	88-02		SM 515 FSR (4T) Supermotard	07-08
	SLR 650 V/W	97-98		KTM	
	XR 650 L	93-12		SX-F 450 (4T/Coil Spring)	07-11
	XR 650 RY/R1-R7	00-07		450 SX (Quad)	09-11
	TRX 700 XX8/XX9/XXB	08-11		SX-F 505	07-09
	XRV 750 L/M/N/P/R/S/T/V/W/X/Y	90-03		505 SX-F (Quad)	09-12
	PC 800 Pacific Coast	89-97		MONTESA-HONDA	
	CB 1000 FP/FR/FS/FT/FV	93-97		315R (2T)	97-04
	CB 1000 R9/RA/RB/RC/RD/RE/RF (Non ABS Model)	09-15		TRIUMPH	
	CB 1000 RA9/RAA/RAB/RAC/RAE /RAF/RAG (ABS Model)	09-16		Daytona 955i	98-00
	CBF 1000 6/7/8/9/A (2 Piston Front Caliper/Non ABS)	06-11		Daytona 955i (From VIN 132513)	01-06
	CBF 1000 A A6/A7/A8/A9/AA (3 Piston Front Caliper/ABS)	06-11		SpeedTriple (EF)	97-01
	CBF 1000 S S7/S8/S9/SA (3 Piston Front Caliper/ABS)	07-10		SpeedTriple 955cc (From VIN 141872 to 210444)	02-04
	CBF 1000 T T7/T8/T9/TA (GT) (3 Piston Front Caliper/ABS)	07-16		SpeedTriple (1050cc)	05-08
	CBF 1000 F FA (2 Piston Front Caliper/Non ABS)	10-11		SprintST (1050cc) (From VIN 208167)	05-09
	CBF 1000 FA FAA (3 Piston Front Caliper/ABS)	10-15		SprintRS	99-04
	CBF 1000 FS FSA (3 Piston Front Caliper/ABS)	10-11		SprintST (Up to VIN 139276)	99-01
	CBF 1000 FT FTA (3 Piston Front Caliper/ABS)	10-11		SprintST (From VIN 139277 to 208166)	02-04
	CBR 1000 FH/FJ/FK/FL/FM/FN/FP /FR/FS/FT/FV/FW/FX	87-99		T595 Daytona	97
	CBR 1000 RR4/RR5/RR6/RR7			Tiger 900cc (From VIN71699)	97-98
	Fireblade (Coil Spring Type Clutch)	04-07		Tiger 955cc (Up to VIN 198874)	99-04
	CRF 1000 LAG (Manual Clutch/ABS)	16-20		Tiger 955 (From VIN 198875)	04-06
	CRF 1000 L (Manual Clutch/Non ABS)	16		Tiger 1050	07-12
	VTR 1000 FV/FW/FX/FY/F1-F6 Firestorm	97-06		Tiger 1050 SE	10-12
	XL 1000 VX/VY/V1/V2 Varadero - Non ABS Model/10 Plate Kit	99-02			
	XL 1000 V3/V4/V5/V6/V7/V8/V9/VA/VB Varadero - Non ABS Model/8 Plate Kit	03-11			
XL1000 V6/VA6/VA7/VA8/VA9VAA/VAB Varadero - ABS Model/8 Plate Kit	06-11				
VT 1100 C2 (S/T/V/W/X/Y/1/2/3/4/5)	95-05				
CB 1300 FW/FX/FY/F1 (SC40)	98-01				
CB 1300 DCV/DCW/DCX/DCY (SC38)	97-00				
			CT009SP	HONDA	
				CB-1 (CB 400 F)	89-90
				CB 400 SF (F2N/F2R) (Super Four) (NC31)	92-95
				CB 400 SF (F2V/F3T) Superfour (NC31)	96-97
				CB 400 SF (F3V) Superfour (NC31)	97
				CB 400 Four V/V-II/W/W-II (NC36)	97-98
				CB 400 SFX/SFY/SF1/SF2/SF3 /SF4/5/S5 (NC39) Super Four	99-05
				CBR 400 RG/RHYA (NC23 100/101)	86
				CBR 400 RRJ/RRK (NC23 102/109)	92-93
				CB 500 K3	78
				CBR 500 FH/FJ/FK/FL (Four)	87-90
				CX 500 CA/CB/Z/A/B/EC	79-85
				GL 500 DC	82
				CB 550 F/F1/F2/K3	78-80
				CBX 550 FC/F2C/FD/F2D	82-85
				CBR 600 FH/FJ	87-88

Part No.	Make/Model	Year	Part No.	Make/Model	Year
CT009SP Contd.	HONDA		CT011 Contd.	SUZUKI Contd.	
	CBR 600 FK/FL	89-90		ZR 50 SKE/SKH	84-87
	CB 750 F2N/F2R/F2S/F2T/F2W /F2X/F2Y/F21	92-02		DS 80 T/X/Z/D/F/G/H/J/K/L/M/N/P /R/S/T/V/W/X/Y	80-00
	CB 1100 AD (Cast Wheels/3 Piston Calipers)	13		JR 80 K1/K2/K3/K4/K5/K6/K7	01-07
	CB 1100 AE (Cast Wheels/3 Piston Calipers)	14		RM 80 B/C/N/XT/XX/XZ/XD/HD/XE/XF/HF	77-85
	CB 1100 EX (Spoke Wheels/4 Piston Caliper)	14-16		RM 80 K/L/M/N/P/R/S/T/V/W/X/Y/K1	89-01
	TRIUMPH			RM 85 I (Small Wheel F 17" / R 14")	02-20
	Bonneville 800 (790cc)			RM 85 II (Big Wheel F 19" / R16")	02-20
	Up to Engine no. 211132	01-04		GP 100 C/UC	78
	Bonneville T-100 (790cc)			GP 100 N/UN	79
Up to Engine no. 211132	02-04	GP 100 X/UX/D/UD/UL	81-92		
CT010	YAMAHA		RM 100 A/B/C	76-78	
	YZ 65 J	19-20	RM 100 N/T/X	79-81	
	YZ 80 H/J/K/L/N/S/T/U/W	81-89	TS 100 C	78	
	YZ 80 E/LC/LW/F/G/H/J/K/L/M/N	93-01	TS 100 ERN Upto F 300563	79	
	YZ 85 (2T / Small Wheel F 17" / R 14")	02-20	TS 100 ERN/ERT/ERX From F 300564	80-81	
	YZ 85 (2T / Big Wheel F 19" / R 16")	02-20	TS 100 ERZ/ERH	82	
	DT 125 R	88-03	DF 125		
	DT 125 RE	04-07	DR 125 SZ/SD/SE/SF/SH/SJ	82-94	
	DT 125 X	05-06	DR 125 SEX/SEY	99-01	
	TDR 125 (3HS1/3XD0/3HS3/3XD1)	89-93	DR 125 SMK8/SMK9/SML0	08-12	
	TDR 125 (4GH/GX 1/2/3/4)	93-03	DR-Z 125	03-20	
	TDR 125R (3HS2/3XE2) Lightburner	93-94	FX 125		
	TZR 125 (2RK/3PC1/2/3)	87-92	GN 125 R/V/W/X/Y/K1 (NF41A)	94-01	
	TZR 125 (3JB/4JB/4HW/4HX)	93-95	GN 125 ER/ER/EW/EX/EY/EK1 (NF41A)	94-01	
	TZR 125 R (4DL1/4DL2)	91-93	GN 125 Z/D/K (Gold cast wheel/Aisin caliper)	82-90	
	TZR 125 RR (4DL3)	94-95	GN 125 HS (LC6PCJB1/Chinese Production)	00-11	
	TZR 150 R (4AP2)	00	GP 125 C/N	78-79	
	DT 200 (2LR)	87	GP 125 X/XD	81-84	
	DT 200 WR 3XP	92-93	GS125 Z/D/ESZ/ESD/ESF/ESK/ESM/ESR/ESX	82-00	
	SDR 200 (2TV)	87-89	GSX-R 125	18-20	
	WR 200 D/E/F	92-94	GSX-S 125	18-20	
	YFS 200 B/F/G/H/J/K/L/M/N/P/R/S /T/V Blaster	91-06	GT125 L/M/A/B/C/EC/EN	74-79	
	YTM 200 EL/DX	89	GZ125 W/X/Y/K1-K9 Marauder	98-11	
	DT 230 R Lanza (4TP1/2)	97-98	LT125 D/E/F/G/H	84-86	
	FZR 250	87	RG125 CG/CH/J (NF12A)		
	FZR 250 R (3LN1/3/5/6/7)		(Gamma/Rear Drum Brake Model)	86-90	
	FZX 250 Zeal (3YX1/2/4)	91-92	RG125 UCG/UCH/UCJ/J/BUJ (NF12B) (Gamma/Rear Drum Model)	86-90	
	FZ 400 (4YR1)	96	RG125 FN/FP/FR Gamma (NF13A/Rear Disc Model)	92-94	
	FZR 400 RR (4DX)	92	RG125 FUN/FUP/FUR Gamma (NF13B/Rear Disc Model)	92-94	
	FZR 400 Genesis (1WG)	86	RG125 UN - Wolf (NF13E/Naked)	92-94	
	FZR 400 RSP (2TK-EXUP)	87	RM125 A/B/C/N/T/X/Z/D/E/F/G/H/J/K/L/M	76-91	
	FZR 400 (3EN1/3EN2)	88-89	RV125 K2/K3/K4/K5/K6/K7/K8/K9 /L0/L3/L4 Van-Van	02-15	
	FZR 400 RR (3TJ1)		TF125 Farm Bike (All models)	78-05	
	FZR 400 RRSP (3TJ2/6/7)		TS 125 K/L/M/A/B/C/C2	73-78	
	YFM 400 FWE/FWF/FWG/FWH /FWJ/FWK Kodiak	93-00	TS 125 ERN Up to F No 302345	79	
	YFM 400 FPR/FPS Big Bear	03-04	TS 125 ERN From F No 302346	79	
	FZR 600	89-93	TS 125 ERT/ERX/ERZ	80-82	
	CT010SP	YAMAHA		TS 125 N to Frame No.178871	84
		YFM 200 DKW/DX/DXA	86-90	TS 125 N from Frame No.178872	84
		YFM 225 N/S/T/U	85-89	TS 125 XUE/XUF/XUG/XUH/XUJ	84-90
		YTM 225 DRN	85	TS 125 RK/RL/RM/RN/RR	90-94
		YFU1W/TW Pro Hauler Pro 4 (230cc)	89	TU 125 X/XTUX/XTX	99
		YFB 250 D/E/F/G/H/J/K/FWF/FWG /FWH/FWJ/FWK/FWL/FWM	92-00	GSX 150 L6/DZAL6 Gixxer	16
		YFM 250 W/A/B	90-92	GSX 150 DEAL8/DZAL8/DXAL8 Gixxer	18
		YFM 250 XN/XP/XR/XS Bear Tracker	00-04	GSX-R 150 FRFAL7/FRZAL7	17-18
YFM 250 FN		01	GSX-R 150 RF-Q/RFX-Q	17-18	
YFM 250 BT/BV Bruin		05-06	GSX-R 150 RFL8/RFXL8	18-20	
YFM 250 BW/BX/BY Big Bear		07-10	GSX-S 150 MFL8/MFXL8	18-20	
CT011		KAWASAKI		LT 160 EK/EL/EM/EN	89-92
		KLX 125 A1/A2/A3/A6F	03-06	LT-F160 L/M/N/P/R/S/T/V/W/X/Y/K1-K3	90-03
		KLX 125 L (B1/B2/B3/B6F)	03-06	LT 160 K3/K4 QuadSport	03-04
		SUZUKI		PE175 C/N/T/X/Z	78-82
	GS 50 K5 (NA41A)	05	GT185 K/L/M/A/B/C/EC	73-79	
	GT 50 KB/KEN	77-80	LT185 E/F	84-85	
	OR 50 ET	80	TS185 K/L/M	73-75	
	RG 50 EW		TS185 B/C/ERN/ERT/ERX	77-81	
	TS 50 KN/ERKT/ERKX/ERKZ/ERKD	79-83	DF200 EV/EW/EY (SH42A)	98-99	
	TS 50 XKE/XKG/XKH/XKJ/XKM/XKR	84-02	DR200 G/H/J	86-89	
	TS 50 W		DR200 SEP/SER/SES/SEV/SEW /SEX/SEY (SH42A) Djebel	93-00	
	ZR 50 KEN/KEX	79-81	DR 200 SE Trojan		
	ZR 50 SLKX/SKX	81	DR 200 SEK1-SEK9	01-09	
			GT 200 EN/EX X5	79-80	

Part No.	Make/Model	Year	Part No.	Make/Model	Year
CT011 Contd.	SUZUKI Contd.		CT012SP Contd.	HONDA Contd.	
	RV 200 K2/K3	02-03		MB50	80-82
	SB 200 N/X	79-80		MTX50 SC	83-87
	SX 200 R/R-Z/RJ/RM	90-91		MBX50 SD/SF	83-85
	TS 200 RK/RL/RM/RN/RR	89-94		MT50 SA/SE/SG/SJ/SL	80-93
	LT 230 GEF/GEG	85-86		NSR50 FP/FR/FS	93-95
	LT-F 230 G/H	86-87		NSR50 RV/RW/RX/RY	97-00
	GS 250 TT/TX	80-81		NSR50 SK/SP/SR/SS	89-95
	GSF 250 N/ZM/P/NP/ZP/R/NR (GJ74A)	92-96		NSR50 V (AC10-180)	97
	GSX 250 ET/EX/EZ	80-82		NSR50 X (AC10-190)	99
	GSX 250 RCH/RH (GJ72A)			TLM50 F	85
	GSX 250 SSM Katana (GJ76A)	91		CRM75 RK/RL/RM/RP/RR	89-94
	GSXR 250 CJ/CK (GJ72A)			NSR75 N/P/R/X/Y (NS-1)	92-00
	GSXR 250 RK (GJ73A)	89		CR80 RE/RF/R2F/RG	
	LT-F250 J/K/L/M/N/P/R/S/T/V/W/Y/K1	89-01		/R2G/RH/RJ/RK/RL/RM/RN/RP/RR	
	LT 250 EFF/EEG	85-86		/RS/RT/RBT/RV/RBV/RW/RBW/RX	
	LT-F250 FX/FY/FK1/FK2	99-02		/RBX/RV/RBY/R1/RB1/R2/RB2	80-02
	LT-F250 K2/K3 Ozark	02-03		MBX80 FWDD/FWDF	83-86
	LT-F250 K5/K6/K7/K8/K9/L2/L3/L4 Ozark	05-14		MTX80 RFD/RFF	83-84
	TS250 XE/XG/XH/XJ/XK	85-89		NSR80 J-2/K/L/N/P/R/S (HC06)	88-
	LT-F300 J/K	88-89		NSR80 V (HC06-170)	97
	LT-F4WDXM/N/P/R/S/T/V/W 300 Quadrunner	91-98		NSR80 X (HC06-180)	99
	LT-F300 FX/FY/FK1	99-01		CR85 R3/RB3/R4/RB4/R5/RB5	
	GSF400 M/N/P	91-95		/R6/RB6/R7/RB7	03-07
	GSF400 K/NK/Z/VM/VZM/P/NP			TRX90 P/R/S/T/V/W/X/Y/1-6	
	/VP/VZR/VR Bandit (GK75A)	89-94		/EX/X9/XB/XC	93-14
	GSF400 VVS/V-VVZ-V Bandit (GK7AA)			Astrea Supra NF100	99
	GSX400 R2 (GK71B)			Astrea Grand/Supra (Drum model)	97-98
	GSX400 R3 (GK71F)			CB100 N	78-80
	GSX400 FJ/FK/FAK/FL (GK74A)	88-90		H100 A/SD/SG/SJ	84-92
	GSX400 X/XA/XS Impulse			ATC125 MG	86
	GSXR 400 H	87		CA125 S/T	95-96
	GSXR400 J/RR/RAK (GK73A)	88-90		CA125 Rebel V/W/X	98-00
	GSXR400 RL/RM/RN/RP/RS (GK76A)	90-95		CB125 TDC/TDE/TDJ	83-89
	ARCTIC CAT ATV 4 WHEELERS			CB125 RS	83
	250 (2 x 4/4 x 4)	01-05		CBF 125 6 Stunner	06
	300 (2 x 4/4 x 4)	98-04		CBF 125 M7 Stunner	07
	300 (4 x 4)	05		CBF125 M9/MA/MB/MD/ME	09-15
	SACHS			CBR125 R4/R5/RS5/RW5/RS6/RW6	
	XTC125	00-07		/RW7/RW8/RW9/RWA/RWB/RC/RD/RF	04-16
	XRoad 125	06-07		CD125 TC	78
				CLR125 W City Fly	98-03
				CM125 CC/CF	82-85
				LS125 R	00-
				NX125 K/S/F Transcity	89-97
				TL125 S	76
		TRX125 J	88		
		XL125 K2-K4/SZ/SA	78-79		
		XL125 SB/SC/SZ/SA/RC/RF/RH	79-86		
		XLR125 RW	98-99		
		XR125 L3/L4/L5/L6/L7/L8	03-08		
		CBF 150 5	05		
		CBF 150 M5 Unicorn	05		
		CBF 150 6 (Spoke Wheels)	06		
		CBF 150 M6/M7 Unicorn (Spoke Wheels)	06-07		
		CBF 150 M7/M9/MA Unicorn			
		(Cast Wheels)	07-10		
		CBF 150 MB/MC Unicorn (Cast Wheels)	11-12		
		CBR150 R	00-03		
		CRF150 F	03-19		
		CD185 T	78		
		ATC185 A/SB/SC/SD	80-83		
		XL185 SZ/SA/SB	80-82		
		ATC200 B/ESE/ESF/SE	81-84		
		ATC200 XD	84		
		CD200 TA	79-80		
		CM200 TA/TB	79-80		
		CTX200/CTX 200 A Bushlander	04-05		
		TA200 (TA Shadow)	02-05		
		TL200 J/Y	76-78		
		TLR200 D/E/G/H	83-87		
		TRX200 L/M	90-91		
		TRX200 D	91-97		
		TRX200 SX	86-87		
		XR200 R	81-83		
		XR200 R	86-02		
		XR200	80-84		
		FTR223 Y/2/A2 (MCS4)	00-02		
		CRF230 F4/F5/F6/F7/F8/F9	04-09		
CT012	YAMAHA				
	MT 125 (Non ABS)	14-16			
	MT 125 A (ABS)	14-16			
	XT 125 R (13D3/13D5) - 4 Friction plate type	07-11			
	XT 125 X (13D4/13D6) - 4 Friction plate type	07-11			
	YBR 125 ED (3D91/3D92				
/3D9/51D1/2) - 4 Plate type	06-13				
YBR 125 ED (51D1/2) - 4 Plate type	10-16				
YBR 125 Custom - 4 Friction plate type	08-16				
YZF-R 125 (Radial Mount Front Caliper/Non ABS)	14-16				
YZF-R 125 A (Radial Mount Front Caliper/ABS)	14-16				
HONDA					
XR50 M5 (AD14) Motard	06				
XZ50 39844 APE-AC16	01-02				
CR60 RF/RG	85-86				
XR75 K4/K5	78-79				
CR80 RA/RB/RC/RD					
CRF80 F4/F5/F6/F7/F8/F9/FB/FC	04-12				
XR80 Z/A/B	80-81				
XR80 R	87-88				
CRF100 F4/F5/F6/R7/F8/F9/FA/FB/RC	04-12				
XL100 SZ/SA/SB	78-82				
XR100 RP/RR/RS/RT/RV/RW					
/RX/RV/R1/R2/R3	93-03				
XR100 M5 (HD13) Motard	06				
XZ100 2 APE-HC07	02				
CB125 S/J	75-79				
CB125 T/T2	78-80				
CG125 K1/B/C/E/BR/BR-K/BR-KJ/S/T/W	77-00				
CG125 M1/1/ES4-ES8	01-08				
CT125 C	85				
CT012SP	HONDA				
	CB50 J	81			
	CB50 V/W Dream 50	97-98			
	CR50 RE-RF	84-85			
	CRM50 RN/RP/RR/RT	93-96			

Part No.	Make/Model	Year	Part No.	Make/Model	Year
CT012SP Contd.	HONDA Contd.		CT013SP Contd.	HONDA	
	CRF230 L	08-10		NS125 FG/FH/RH (5 Plate Clutch)	86-87
	CRF230 M (Supermoto)	09-10		NSR125 FJ/FK/FL/FM/FN (6 Plate Clutch)	88-92
	SL230 V/W/X/1	97-01		NSR125 RK/RL/RM/RN (6 Plate Clutch)	89-92
	XL230 2 (MC36)	02		NSR125 RR/RS/RV/RW/RX/RY/R1 (6 Plate Clutch)	93-01
	CB250 N/T/W/X/Y/1/4 Two Fifty	93-05		MTX200 RWD/RWF	83-85
	CB250 FT/FV/FX/FY/F1 (MC31) Hornet	96-01		XR200 R	84-85
	CBR250 FG/RH/RJ/RK/RK2 (MC14/17/19)	86-89		ATC250 RF/RG	85-86
	CBR250 RRL/RRN/RRR (MC22 -100/105/110)	90-94		ATC250 ESF/ESG/ESH/ESJ	85-88
	CD250 UJ/UK	88-92		AX-1(NX 250 J/K/R/R3)	89-94
	CMX250 CT/CV/CW/CX	96-00		CB250 T/N/NA/NB/NDB/NDC	78-82
	TLR 250 F	85-		CB250 RSA/RSD	81-84
	TRX 250 V/W/X/Y/1/TM2 Re Con (Manual Shift)	97-14		CBF250 39967	04-06
	TRX 250 TE2 Re Con ES (Electric Shift)	02-14		CBX250 RSE	84
	TRX250 X9/XA/XB	09-11		CBX250 Twister	
	TRX250 EX1/2/3/4/5/6/7/8	01-08		CL250 SC	81
	VT250 CR Magna			CM250 TB	81
	VT250 FL Spada/Castec	88-90		GB250 E/H/J/L/P/S/V Custom	84-97
	VTZ250 H/J/K	86-88		NX250 J/K/L (MD21)	87-90
	VTR250 W/Y (MC33)/1-7	98-07		NX250 2L/M/P/2P	90-93
	VTR250 9	09-10		TRX250 F/G/H	85-87
	HONDA-DALLARA			XL250 S/SZ/SA/SB/RC	78-82
	KAWASAKI			XL250 RE/RF	84-85
	KLX125 CAF/CBF/CCF/CCS/CDS/CEF/CFF/CGF	10-16		XL250 Degree	
	KLX125 DAF/DBF/DCF/DEF (D-Tracker)	10-14		XLR250 R Baja (5 Plate) (MD22)	
	KLX 150 L (KLX 150 EFF)	14-15		XLR250 R Baja (6 Plate) (MD22)	
KLX 15 D-Tracker (KLX150 HGF)	16	XR250 SZ/SA	79-80		
KLF185 A3	87	XR250 RB/RC/RD/RE/RF/RG/RH/RJ /RK/RL/RM/RN/RP/RR/RS/RT /RV/RW/RX/RY/R1/R2/R3/R4	81-04		
CT013	BMW		XR250 Y/3 (MD30)	00-03	
	G 310 GS	17-20	XR250 39935 (MD30) Motard	03-05	
	G 310 R	17-20	XR250 III Y/3 Baja	00-03	
	HONDA		TRX300 FWJ/K/L/T/V/W/X/Y/J/K /L/T/V/W/X/Y	88-00	
	CR125 RD/RE	83-84	TRX300 EX P/R/S/T/V/W/X/Y/1-8	93-08	
	CRM250 R (RK) MK1 MD24 (100001-1008385)	89-90	TRX300 X9	09	
	CRM250 R (RM) MK2 MD24 (1200001-1211634)	91-92	TRX350 G/H/J/K/L/M/N	86-93	
	CRM250 R (RP/RP-11) MK2/2/MD24 (1300001-)	93	TRX350 FMY/1-5 Fourtrax Rancher/4x4	00-05	
	CRM250 MK3 RR/RR2 (MD24-10)	94-96	TRX350 TE/FE Fourtrax Rancher ES/ES 4x4 FEY/1-5	00-05	
	CRM250 Active Radial ARV/ARW (MD32)	97-98	CB350 SG/SJ	86-88	
	NS250 FE/RE (MC11-100)	84	XR350 RD/RE	83-84	
	NS250 RG (MC11-102)	86	CB400 F/F1/F2	75-79	
	NSR250 RG (MC16-100) - Wet Clutch	86	CB400 T/N/NA/NB/NC	78-82	
	NSR250 R2J (MC18-100)/R4J (MC18-100) - Wet Clutch	88	CBR400 RRL/RRN/RRR (NC29)	90-94	
	NSR250 R5K/R5K-2 (MC18-110) - Wet Clutch	89	NT400 Bros NC 25		
	NSR250 R7L(MC21-100) /R7N (MC21-106) - Wet Clutch	90	NV400 CJ/CK (Steed)	92-93	
	NSR250 RR (MC28-100) - Wet Clutch	94	NV400 CS/CV Steed	95-97	
	TRX250 RG/RH/RJ/RK	86-89	NV400 DCY/DC1/DC2 (NC40) Shadow Slasher	00-02	
	CB400 SS (SS2-NC41)	01-05	TRX400 FWS/T/V/W/X/Y	95-00	
	CL400 (NC38)	97-03	VRX400 T (NC33)	96	
	NS400 RF/RG	85-87	TRX420 TM7/TM8/TM9/TMA/TMB	07-11	
	TRX400 EX/EY/EXX/EXY/EX1-EX8/X9	99-09	TRX420 FE7/FE8/FE9/FEA/FEB		
	XR400 RT/RV/RW/RX/R1-R5	96-05	4WD-Fourtrax ES	07-11	
	XR400 R5/R6 Motard (NC38E)	05-06	TRX420 FM7/FM8/FM9/FMA/FMB		
	XR400 M Supermotard (ND08/NC38E)	06-08	4WD-Fourtrax TRX420 FPMP/FPMA/FPMB	07-11	
	HONDA-DALLARA		Fourtrax - 4WD - Power Steering	09-11	
	XR400/440 R	04	TRX420 TE7/TE8/TE9		
	XR400/440 SM	04	Fourtrax ES - 2WD	07-09	
	SUZUKI		CB450 DX-K	89	
	DR250 RS/RLS/RT/RV/RLV/RW /RLW/R1 (SJ45A/DOHC)	95-00	CMX450 CH/CJ Rebel	02	
	DR250 RXT/RXLT/RXV/RXLV/RXW /RXLW/RXGW/RXGLW/RXY/RXGY (Djebel 250 XC/GPS Ver (SJ45A)		TRX450 ESW/ESX/ESY/ES1	98-01	
	DR-Z250 K1-K7 (DJ 43 A)	01-07	CB500 R/T/V/W/SW/X/SX/Y /SY/2/S2 (Twin)	94-03	
	CT013SP	HONDA		CBF500 4/A4/A5/A6/A7	04-07
		CRM125 RL/RM/RN/RP/RR/RV/RX	90-99	FT500 C	82
		MBX125 FE	84-86	TRX500 FE5/FE6/FE7/FE8/FE9/FEA /FAB Fourtrax Foreman 4WD/ES	05-11
		MTX125 RWD/E/F/H/L	83-95	TRX500 FEC Fourtrax Foreman ES 39904 WD	12
				TRX500 FM5/FM6/FM7/FM8/FM9 /FMA/FMB Fourtrax Foreman 4x4	05-11
				TRX500 FMC Fourtrax Foreman	
				S 39904 WD	12
				TRX500 TM5/TM6 Fourtrax Foreman	05-06

Part No.	Make/Model	Year	Part No.	Make/Model	Year
CT013SP Contd.	HONDA Contd.		CT014 Contd.	HONDA Contd.	
	TRX500 FPE8/FPE9/FPEA/FPEB	08-11		CBR900 RRY/RR1 (929cc Fireblade)	00-01
	Fourtrax Foreman 4x4 ES/EPS			CBR900 RR2/RR3 (954cc Fireblade)	02-03
	TRX500 FPEC Fourtrax Foreman			SUZUKI	
	S 39904 WD	12		GSR 400 K6/K7/K8	06
	VT500 ED/EF	83-85		GSR 600 K6/K7/K8	06-10
	XL500 SZ/SB/RC	80-82		GSXR 600 K1/K2/K3/ZK3/K4/K5	01-05
	XR500 SZ/SA/RB/RC	79-82		GSF 650 K7/K8/K9/L0/L1/L2	
	NTV600 J/K/M	88-91		Naked Bandit - Non ABS	07-12
	VT600 CN/CR/CS/CT/CV/CW/CX	92-00		GSF 650 SK7/SK8/SK9/SLO/SL1	
	XL600 VH/VJ/VK/VM/VN/VP/VR			/SL2 Faired Bandit - Non ABS	07-12
	/NT/VV/VW/VX Transalp	87-99		GSF 650 AK7/AK8/AK9/ALO/AL1	
	NT650 J/K/L (BROS)	88-92		/AL2 Naked Bandit - ABS	07-12
	NTV650 J/K/L/M/P/S/T/V	88-97		GSF 650 SAK7/SAK8/SAK9/SALO	
	NT650 VV/VX/VY/V1-V5 Deauville	98-05		/SAL1/SAL2 Faired Bandit - ABS	07-15
	XL650 VY/V1/V2/V3/V4/V5/V6/V7	00-07		GSX 650 FK8/FK9/FLO/FL1/FL2 (Non ABS)	08-14
	XR650 J/K Africa Twin	88-89		GSX 650 FAK8/FAK9/FALO/FAL1/FAL2 (ABS)	08-15
	NC700 SC/SD (Manual Gearbox)	12-13		GSR 750 L1/L2/L3	11-14
	NC700 XC/XD (Manual Gearbox)	12-17		GSR 750 AL2/AL3/AL4 /AL5 (ABS)	12-15
	NT700 V6/VA7/V7/V8/VA8/VA/VAA Deauville	06-13		GSXR 750 Y	00
	XL700 V8/V9/VA (Transalp			GSXR 750 K1/K2/K3/K4/K5	01-05
	/2 Piston Front Caliper			RF 900 RS/R2S/RT/RV/RW	95-98
	/ABS on Rear Disc)	08-11		TL 1000 SV/SW	97-98
	XL700 VA8/VA9/VAA (Transalp			YAMAHA	
	/3 Piston Front Caliper			XTZ250 Lander (Brasil) (4B41/2/3)	07-09
	/ABS Front & Rear Wheels)	08-11		YBR250 (5D11/3/4)	07-11
	NC 750 S	14-15		YS250 Fazer (Brasil) (1S41/2/3)	06-08
	NC 750 S (ABS)	14-18		TRIUMPH	
	NC 750 X	14-15		Daytona650	05
	NC 750 X (ABS)	14-19		Daytona675	06-12
	VT750 CV/C2V/CW/C2W/CX/C2X			Daytona 675 R	11-16
	CY/C2Y/C1/C1Y/C4/C5/C6/C7/C8	97-09		Street Triple 675	07-16
	VT750 C2BA/C2BB/C2BC/C2BE			Street Triple R 675	09-16
	Shadow Black Spirit	10-15		Street Triple S 765	17-20
	VT750 C2SA/C2SB Shadow			Street Triple R 765	17-20
	(3 Piston Caliper/17" Front			Street Triple RS 765	17-20
	Wheel/Rear disc)	10-12		Tiger 800	11-12
	VT750 DC1/DC2 Black Widow	01-04		Tiger 800 XC	11-12
	VT750 DC7/DC8 Shadow Spirit	07-09		Tiger 800 XR	2018-
	VT750 S (VT 750 SA/SB)	10-12			
	HONDA-DALLARA				
	XR250 R	04			
	XR250 RM	04			
	KAWASAKI				
	KLF220 A1-A15	88-02			
	KLF250 A1/A2/A3/A6F/A7F/A8F				
	/A9F/AAF/ABF (Bayou 250)	03-11			
	MOTOROMA				
	Geko300 Quad	04-06			
	TRIUMPH				
	Daytona600	02-05			
TT600	00-03				
CT014	HONDA		CT014SP	HONDA	
CB600 F7/F8/F9/FA/FB/FC Hornet	07-13	CB600 Hornet FW/FX/FY/F2-Y/F1		CB600 Hornet FW/FX/FY/F2-Y/F1	
CB600 FA7/FA8/FA9/FAA/FAB/FAC Hornet (ABS)	07-13	/F21/F2/F22/F3/F4/F5/F6	98-06		
CBF600 N8/N9/NA	08-11	CBF600 N4/N5/N6	04-06		
CBF600 NA8/NA9/NAA	08-11	CBF600 NA4/NA5/NA6	04-06		
CBF600 S8/S9	08-09	CBF600 S4/S5/S6	04-06		
CBF600 SA8/SA9/SAA	08-12	CBF600 SA4/SA5/SA6	04-06		
CBR600 FX/FY (CARB MODEL)	99-00	CBR600 FM/FN/FP/FR/FS/FT/FV/FW	91-98		
CBR600 FS1/FS2 Sport	01-02	CB 650 F (Non ABS)	14-20		
CBR600 FB/FC	11-13	CB 650 FA (ABS)	14-20		
CBR600 FAB/FAC	11-13	CBR 650 F (Non ABS)	14-20		
CBR600 RR3-RRK	03-19	CBR 650 FA (ABS)	14-20		
CBR600 RR Hannspree	08	BENELLI			
CBR600 RA9-RAK(C-ABS)	09-19	Leoncino 500	17-19		
VF750 CP/CR/CS/CT/CV	93-97	Leoncino Trail 500	18-19		
VFR750 FG/FH/FJ/FK/FL/FM/FN		TRK 502 ABS Euro 4	17-18		
/FP/FR/FS/FT/FV	86-97	TRK 502 X	18-19		
VFR750 RJ/RK/RL (RC30)	88-92	BN 600 GT	14-17		
VFR800 Fi-W/Fi-X/Fi-Y/Fi-1	98-02	BN 600 i	14-17		
VFR800 2/3/4/5/6/8/9	02-09	BN 600 R	14-15		
VFR800 A2/A3/A4/A5/A6/A8/A9	02-13	BN 600 S	14-15		
VFR 800 XA (Crossrunner/ABS)	11-13				
VFR 800 XA (Crossrunner/ABS)	15-16				
CB900 F2/F3/F4/F5/F6/F7 Hornet	02-07				
CBR900 RRN/RRP/RRR (893cc)	92-94				
CBR900 RRS/RRT/RRV/RRW/RRX (918cc)	95-99				
			CT015	SUZUKI	
			GSX-R 600 K6/K7/K8/K9/L0/L1-L9	06-20-	
			GSXR750 K6/K7/K8/K9/L0/L1-L5	06-20	
			GSX-S 750	15-20	
			GSX-R 1000 K5/K6/K7/K8	05-08	
			GSX-S 1000 (Naked/Non ABS)	18-20	
			GSX-S 1000 (Naked/ ABS)	18-20	
			GSX-S 1000 F (Faired/Non ABS)	18-20	
			GSX-S 1000 F (Faired/ ABS)	18-20	
			Katana	19-20	
			KTM		
			950Adventure S	03-04	
			950Adventure	02-06	
			950Superenduro R	07-08	
			950Supermoto	05-07	
			990Adventure S	06-08	
			990Adventure R	09-12	

Part No.	Make/Model	Year	Part No.	Make/Model	Year	
CT015 Contd.	KTM Contd.		CT016 Contd.	KAWASAKI Contd.		
	990Adventure	09-12		ZXR750 R (ZX 750 K1/K2/M1/M2)	91-94	
	990Adventure Dakar Edition	11		ZX7RR (ZX 750 N1/N2)	96-99	
	990Superduke	05-11		VN800 A1-A3/B1-B10/B6F	95-06	
CT016	KAWASAKI			VN800 C1/C2/E1/E2/E3 Drifter	99-04	
	990Superduke R	07-13		EJ800 ABF/ACF (W800 Solid Front Disc)	11-12	
	990Supermoto T (SM-T)	08-13		EJ800 W 800 Cafe Style/Cockpit Fairing)	11	
	990Supermoto R (SM-R)	08-13		EJ800 ACFAW 800 Special Edition		
	EL250 B1/B2/B3 Eliminator	87-89		Black Exhaust/Gold Rims)	12	
	EL250 D1-D5	90-94		EJ 800 ADF/AEF/AFF/AGF (W 800)	13-16	
	EL252 (EL 250 F2/F3F5/F6)	96-03		EJ 800 ADF/AEFA/AFFA/AGFA		
	GPX250 R (ZX 250 F2/F3/F6-F9)	88-95		(W 800 Special Edition)	13-16	
	GPZ250 R (EX 250 E)	86		ZL900 A1/A2 Eliminator	85-86	
	GPX250 R II (EX 250 G)	88		GPz900 R A1-A8	84-96	
	KLE250 A1/A1A/A2 (Anhelo)			GPZ900 R (ZX 900 A11-15)	98-02	
	KR250 A1/A2	84-86		VN900 A6F Classic	06	
	KR-1(KR 250 B2)	89		VN900 B7F/B8F/B9F/BAF/BBF/BCF/BDF		
	KR-1S(KR 250 C2/C3)	90-92		/BEF/BFF (Classic) (Spoke wheel)	07-15	
	KX250 J1/J2/K1-K5/L1-L4	92-02		VN900 BBFA/BCFA/BDF/BEFA/BFFA		
	KX250 M1/M2/R1/R6F/R7F/R8F (2T)	03-08		Classic Special Edition (Spoke wheel)	11-15	
	ZZ-R250 (EX 250 H1-H13)	90-03		VN900 C7F/C8F/C9FA/CAF/CBF/CCFA		
	FX400 R (ZX 400 E1/E2/E3)	86-88		/CDF/CEFA/CFFA (Custom) (Cast wheel)	07-15	
	GPZ400 R (ZX 400 D1/D2/D3/D3A)	85-87		ZX-9R (ZX 900 B1-B4)	94-97	
	GPZ400 R (ZX 400 F1)	87		Z1000 E1/E2 (ST-Shaft)	79-80	
	Z400 J1-J3	80-83		Z1000 K1/K2 (Ltd)	81-82	
	ZL400 A Eliminator	86-87		Z1000 J1/J2/J3	81-83	
	ZL400 B Eliminator 400 SE	88		Z1000 R1/R2 (Eddie Lawson Replica)	83	
	ZR400 A1/B1 (Z 400 F)	83-84		GPz1000 RX A1-A3	86-88	
	ZRX400 (ZR 400 E1-E7)	94-01		1000GTR (ZG 1000 A1-A18)	86-03	
	ZR400 Zephyr (G2/G3/G3A/G4/G5)	97-01		ZX10 B1/B2/B3	88-90	
	ZX400 C2 (Z 400 F 11)	85		ZL1000 A1	87	
	ZZR400 (ZX 400 K1/K2/K3/N1-N7)	90-99		GPz1100 B1/B2	81-82	
	EN450 A1-A5 (LTD 454)	86-89		GPz1100 A1-A3	82-85	
	EN500 A1-A4/B1/B2/C1-C9	90-04		Z1100 R1	84	
	ER-5 (ER 500 A1/A2/A3/A4/C1-C5P)	97-07		Z1100 A1-A3	81-83	
	EX500 A1-A6/D1-D7 (GPz 500 S)	87-02		Z1100 D1/D2 Spectre	82-83	
	GPZ 500 (S) (EX 500 B1-B5/E1-E10)	88-04		ZR1100 A1/A2/A3/A4/B1	92-97	
	KLE 500 A1-A12/B1P/B6F/B7F	91-07		ZR1100 B5 (Zephyr 1100 RS)	02	
	Z 500 A1-A3/B1/B2	79-81		ZRX1100 (ZX 1100 C1/C2/C3/C4)	97-00	
	GT 550 G1-G9	83-01		ZRX1200 R A1/A2/A3/A4/A5/A6F	01-08	
	GPz 550 D1/H1/H2/A1-A4	81-87		ZRX1200 S B1/B2/B3 (ZR 1200)	01-03	
	ZR 550 A1/A2 (Z 550 F)	83-84		SUZUKI		
	ZR 550 B2-B6 Zephyr	91-99		RM250 T/V/W/X/Y/K1-K9	96-12	
	Z 550 C1/C2 (Ltd)	80-81		RM250 XCK8	09	
	KL 600 A1 (KLR 600)	84				
	KLR 600 B1/B2/B4/B6-B9	85-94		CT017	YAMAHA	
	GPz 600 R A1-A6	85-89		XS400	82	
	GPX600 R (C1-C3/C6-C7)	88-96		RD500 LC	84-86	
	ZL 600 B1	95-97		RZV500 R (51X)	85	
	ZZR 600 D1/D2/D2A/D3	90-92		XV 950 Racer (Remote Reservoir Rear Shock)	15-16	
	ZZR 600 (ZX 600 E1-E13/E6F)	93-07		XVS950 A Midnight Star	09-13	
	650 Vulcan S (EN 650 AFF/AGF/Non ABS)	15-16		XV 950 XVS 950 (Non ABS/Standard Rear Shocks)	14	
	650 Vulcan S (EN 650 BFF/BGF/ ABS)	15-16		XV 950 CU - XVS 950		
	ER-6f (EX 650)	06-11		(1XC1/ABS/Standard Rear Shocks)	14-15	
	ER-6f (ABS) (EX 650 A)	06-11		XV 950 R - XVS 950 R		
	ER-6n (ER 650)	06-11		(2DE/Remote Reservoir Rear Shocks)	14-15	
	ER-6n (ABS) (ER 650)	06-11		YZFR1 (4XV1/2 4XV7/8 5JJ1/8 5PW1/7)	98-03	
	KLE650 A7F/A8F/A9F/CAF (Versys)	07-10		FJ1100	84-85	
	KLE650 B7F/B8F/B9F/DAF (Versys ABS)	07-10		FJ1200/1200 A	86-95	
	KLE650 CBF/CCF/CDF/CEF (Versys/Non ABS)	11-14		XT1200 Z Super Tenere (ABS/UBS Brake System)	10-16	
	KLE650 DBF/DCF/DDF/DEF (Versys/ABS)	11-14		XT 1200 ZE Super Tenere (ABS/UBS Brake System)	14-16	
	KLE 650 Verseys (KLE 650 EFF/EGF/Non ABS)	15-16		XJR1200	95-98	
	KLE 650 Verseys (KLE 650 FFF/FGF/ABS)	15-16		FJR1300 N/P	01-02	
	KLR650 A1-A3	87-89		FJR1300 R/AR/S/AS/AT (ABS)	03-05	
	KLR650 (KL 650 E8F/E9F)	08-09		FJR1300 A (1CY/Manual G/Shift)	06-15	
	KL650 B1/B2/B3 Tengai	89-92		FJR1300 AE (Electronic		
	KLX650 C1/C2/C3	93-97		Suspension Adjustment/USD Forks)	14-15	
	KLR650 C1-C10	95-04		FJR1300 AS (Electric G/Shift)	06-15	
	W650 (EJ 650 A1/C3-C7)	99-05		XJR 1300 C / Racer	15-16	
	VN700 A1 Vulcan	85		XJR1300 L 5EA2/5EA3/5EA4	99	
	GPX750 F1/F2/F2A/F3	87-89		XJR1300 M 5EAA/5EAB/5EAC	00	
	GPz750 R G2/G3	85-86		XJR1300 (5EA1/5EA7/5EA9/5EAG)	98-00	
	VN750 A2/A3/A4/A5/A10	86-94		XJR1300 N/P (5EAP/5EAS/5EAT		
	Z750 B1/B2	77-78		/5EAW/5EAV/5EAY)	01-02	
	Z750 D1	76		XJR1300 R/S 5WM1/5WM3/5WM5		
	Z750 Y1 (Ltd)	82		/5WM6/5WM7/5WM9	03-04	
	ZXR750 H1/H2/J1/J2/L1-L3/P1-P7	89-03		XJR1300 T/V/W/X/Y 5WMA/5WMC		
				/5WMD/5WMF	05-14	
				XJR1300 SP (L) (5EA5/5EA6/5EA8)	99	

Part No.	Make/Model	Year	Part No.	Make/Model	Year
CT017 Contd.	YAMAHA Contd.		CT020 Contd.	YAMAHA Contd.	
	XJR1300 SP (M) (5EAD/5EAE/5EAF)	00		XT660 X Supermoto (1D21/1D23 /1D24/1D26/3S72/10S1/11B1)	04-09
	XJR1300 SP (N) (5EAL/5EAM/5EAN)	01		XT660 X Supermoto (10S7)	10-16
	XVS1300 A Midnight Star	07-16		XT660 R (Model Code 5VK1/3/4/6 /8/3S62/3S63)	04-07
	XVS1300 CU Custom	14-16		XT660 R (Model Code 5VKA/5VKC/5VKE)	08-16
	XV1700 V-Max	09-16		XT 660 Z Tenere (Non ABS)	08-16
	XV1900 A Midnight Star (Diaphragm Spring)	06-12		XT 660 ZA Tenere (ABS)	11-16
	MT-01 (1670cc)	05-09		MT-07 (Non ABS /689cc /2 Cyl)	14-20
	MT-01S (1670cc)	09		MT-07A (ABS /689cc /2 Cyl)	14-20
	CT018SP	SUZUKI			CT021
RL250 Beamish Model Reed Valve Engine		78-82	CB750 KZ	80	
RL325 Beamish Model Reed Valve Engine		78-82	CB750 FA/FB/F2C	79-82	
GS400 B/C		77-78	CB900 FZ/FA/FB/F2B/F2C/FD/F2D	80-85	
GS425 EN		79	VTR1000 SPY/SP1 (SC45)	00-01	
GS550 DB/DC/EC/EN/ET/EX/EZ		77-82	CB1100 RB2/RC2/RD2	80-82	
GS550 MX/MZ Katana		81-82	CB1100 SFY/SF1 X11	00-03	
GS550 LT/LX		80-81	CBR1100 XXV/XXW Blackbird	97-98	
GSX550 ESD/ESE/EFF/EFE/ESH/EFG (GN71D)		84-87	CBR1100 XXX/XXY/XX1-XX6 Blackbird	99-08	
GS650 GX/GZ Katana		81-82	ST1300 2/3/4/6/8/9 Pan European -Non ABS	02-09	
GS650 GTX/GTZ/GTD		81-83	ST1300 A2/A3/A4/A6/A8/A9/AA Pan European-ABS Model	02-13	
XN85 D Turbo		83	VT1300 CXA (Fury/Chopper/Non ABS/9 Spoke Cast Wheel)	10-12	
GS700 EF/ESF		85	VT1300 CXAA (Fury/Chopper/ABS /9 Spoke Cast Wheel)	10-11	
GT750 J/K/L/M/A/B		72-77	VTX1300 S3/S4/S5/S6/S7/S8	03-08	
GS750 B/DB/DC/EC/EN		77-79	VTX1800 C2/C3/C4/C15/C16/C17	02-08	
GSX750 ET/EX		80-81	KAWASAKI		
GSX750 ESD/EFE/ESG/ESE/EFF		83-86	KL1000 (LV 1000 A1H/A2H)	04-05	
GSX750 SE Katana		84	ZZ-R1100 C1/C2/C2A/C3/D1-D9	90-01	
GSX750 S/SS (GS75X-106815-)			ZX1100 E1/E2/F1	95-98	
GSX750 S-2/S-2C (GS75X-114747-) Katana			ZZR1200 C1H/C2H	02-04	
GS850 GN/GT/GX/GZ/GF/GG	79-85	GTR1400 (ZG 1400 A8F/A9F/CAF/CBF) ABS	08-11		
CT019	KAWASAKI		GTR1400 ABS (ZG 1400 CCF/CDF/CEF/EEF/EGF)	12-16	
	Z650 B/B2/B3	77-79	ZZR1400 (ZX 1400 A6F/A7F)	06-07	
	Z650 C1/C2/C3 Custom	77-79	ZZR1400 ABS (ZX 1400 B6F/B7F /D8F/D9F/DAF/DBF)	06-11	
	Z650 D2/D3	79-80	ZZR1400 FDF/FEFA/FFFA Special Edition	13-14	
	Z650 F1/F2/F3/F4	80-83	ZZR1400 FCF/FDF/FEF/FFF ABS	12-14	
	Z700 A1 Ltd	84	SUZUKI		
	ZN700 A1/A2 Ltd	84-85	DL1000 K2-K9/LO V-Strom	02-10	
	GPz750 R1	82	DL 1000 V-Strom (ABS)	14-20	
	GPz750 A1-A5	83-87	DL 1000 V-Strom Adventure ABS	14-20	
	GT750 P1-P5	82-90			
	GT750 P7/P9	92-96			
	Z750 N1/N2 Spectre	82-83			
	ZR750 C1/C2/C3/C4 Zephyr	91-95			
	ZR750 C5/D1 Zephyr	95-98			
	ZR7 (ZR 750 F1/F3/F5)	99-04			
	ZR-7S(ZR 750 H1/H2)	01-04			
	Z750 E1/H1/H2/L1-L4	80-84			
	ZX750 E1/E2 (Turbo)	84-87			
	Z1/Z1A/Z1 B	74-76			
	Z900 A4/A5	76-77			
Z1000 D1-D3 Z1R	78-80				
Z1000 A1/A2/A3/A4	77-80				
Z1000 H1	80				
CT020	YAMAHA				
	WR 250 Z (2T)	91-98			
	YZ 250 (2T)	88-20			
	YZ 250 FG (270mm Disc)	16-18			
	YZ 250 FGY				
	(60th Anniversary Edition/270mm Disc)	16			
	XVS400	96			
	WR426 FN/FP (4T)	01-02			
	YZ426 FM/FN/FP (4T)	00-02			
	WR 450 F (4T)	03-15			
	WR 450 F (270mm F/Disc/4T)	16-20			
	YZ 450 F (4T)	03-15			
	YZ 450 FG (270mm Disc)	16-20			
	YZ 450 FGY				
	(60th Anniversary Edition/270mm Disc)	16-20			
	YFZ450 S/T/V/W/X Quad	04-09			
	YFZ450 B/D	13-14			
	YFZ450 RX/RX Quad	09-10			
	YFZ450 RSEA/RSEB/RSED/RSE	11-14			
	XV 535/535 S Virago	88-03			
XVS650 Dragstar	97-04				
XVS650 A Dragstar Classic	98-07				
MT-03 (660cc)	06-12				

Part No.	Make/Model	Year	Part No.	Make/Model	Year
CT021 Contd.	SUZUKI Contd.		CT022 Contd.	SUZUKI Contd.	
	SV1000 K3K4/K5/K6/K7 (Naked)	03-07		PE400 T/X	80-81
	SV1000 SK3/SK4/SK5/SK6/SK7 (Faired)	03-07		RM400 C	78
	GSF1200 SFK7 Bandit Streetfighter	07-09		RM400 N/T	79-80
	GSF1250 K7/K8/K9 (Naked Bandit - Non ABS - 4 Piston caliper)	07-10		SP400 T	80
	GSF1250 AK7/AK8 (Naked Bandit - ABS Model - 4 Piston caliper)	07-10		GS450 ET/EG/EJ	80-88
	GSF1250 SK7/SK8/SK9/SLO (Faired Bandit - ABS Model - 4 Piston Caliper)	07-10		RM465 X/Z	81-82
	GSF1250 SAK7/SAK8/SAK9 /SAZK9/SALO (Faired Bandit - ABS Model - 4 Piston Caliper)	07-15		LT500 RL/RM	90-91
	GSX1250 FAL0/FAL1/FAL2	10-15		GS500 EK/EL/EM/EN/EP/ER/ES/ET /EV/EW/EX/EY/K1/K2/K3/K4/FK4 /F5/FK5/K6/FK6/K7/FK7/K8/FK8	89-08
	GSX1250 FAL0ST/FAL1ST Sports Touring	10-14		SUZUKI	
	GSX1300 RX/RX/RK1 Hayabusa	99-01		GT500 A/B	76-77
	GSX1300 RK2/RZK3/RK3/RK4/RK5/K6/K7	02-07		RM500 D/E	83-84
	GSX1300 RK8/RK9/RL0/RL1/RL2 /RAL3/RAL4/RAL5 Hayabusa	08-15		T500 R/J/K/L/M (12 ears)	71-75
	GSX1300 BKK8/BBK9/BKLO/BKL1 B-King	08-12		SV650 X/Y/K1/K2 (Naked - Non ABS)	99-02
	VL1500 BTL3/BTL4/BTL5 (C 1500BT Intruder)	13-15		SV650 SX/SY/SK1/SK2 (Faired - Non ABS)	99-02
	KTM			APRILIA	
	RC8 (1190cc)	08-10		RS250	95-02
	RC8R/Track (1190cc/6 Spring Clutch)	10-12	QUADZILLA		
	RC8R/Track (1190cc/3 Spring Clutch)	13-14	WK300	06	
	TRIUMPH		CT023		
	Adventurer	96-01	KTM		
	Daytona750 (3cyl)	92	SX250 (2T/Diaphragm Spring)	13-15	
	Daytona900 93cyl)	93-96	SX-F250 (4T/Coil Spring)	13-20	
	Daytona1000 (4cyl)	92	EXC250 (2T)	13-20	
	DaytonaSuper III (3cyl)	94-97	EXC250 Six Days (2T)	13-20	
	Daytona1200 (4cyl)	93-98	EXC-F 250 (4T)	14-20	
	LegendTT	98-01	EXC-F 250 Six Days (4T)	14-20	
	RocketIII 2300cc	04-09	250EXC-G Racing	03	
	RocketIII Classic	07-09	250EXC Racing	02-03	
	RocketIII Roadster ABS	10-12	250EXC Racing (2T)	05	
	RocketIII Touring	08-12	XC250 (2T/Diaphragm Spring)	13	
	SpeedTriple (Carb models)	94-97	XC-F250 (4T/Coil Spring)	13-20	
	RocketIII 2300cc (All models)	04-09	EXC300 (2T/Diaphragm Spring)	13-15	
Sprint(All carb models)	93-98	EXC300 Six Days (2T/Diaphragm Spring)	13-15		
Thunderbird	95-03	350Freeride (4T)	12-15		
ThunderbirdSport	98-04	EXC-F350 (Coil Spring)	11-20		
Tiger900cc (Up to VIN71698)	93-96	EXC-F350 (4T/Diaphragm Spring)	12-20		
Trident750	92-98	EXC-F350 (4T/Six Days/Diaphragm Spring)	12-20		
Trident900	92-98	SX-F350 (USD Forks/Coil Spring)	11-20		
Trophy900 (3cyl)	92-01	XC-F350	12-20		
Trophy1200 (4cyl)	92-01	400EXC Racing	02		
		400EXC-G Racing	02		
		400EXC Racing	05		
		400EXC	07-09		
		400EXC-G Racing	05-06		
		400MXC	02		
		400SX Racing	02		
		450EXC Racing	03/05		
		450EXC-G Racing	03/05		
		450EXC	04-09		
		EXC450 (4T/Diaphragm Spring)	12		
		EXC-F450 (4T/Diaphragm Spring)	13-15		
		EXC450 Six Days (4T/Diaphragm Spring)	12-15		
		450MXC-G Racing	03/05		
		MXC450	06		
		450SMR	04-05		
		SMR450	06-07		
		450SMS	04		
		EXC-F 450 (4T/Diaphragm Spring)	18-19		
		SX450 (4T)	03-06		
		SX-F450 (4T/Diaphragm Spring)	12-20		
		XC450 Quad (4T)	08-09		
		EXC500 (4T/Diaphragm Spring)	12-20		
		EXC500 Six Days (4T/Diaphragm Spring)	12-20		
		520SX Racing	02		
		525EXC-G Racing	03/05		
		525EXC	03		
		525EXC Racing	05		
		525MXC Desert Racing	03/05		
		MXC525	06		
		525SMR	04-05		
		525SX Racing	03/05		
		SX525	06		
		XC525 (Quad)	08-12		
		540SXS Racing	02		
		SMR560	06-07		
CT022	SUZUKI				
	DR250 SL/SM/SN/SEP/SER/SES (SJ 44 A)	90-95			
	GT250 M/A-C/EN/ET/EX X7	75-81			
	LT250 RH/RJ/RK	87-90			
	PE250 B/C/N/T/X/Z	77-82			
	RG250 WD/WE	83-84			
	RG250 FG/FH/CH/FCH	85-88			
	RGV250 J	88			
	RGV250 K/L (VJ21A)	89-90			
	RGV250 M/N/P/R/S (VJ22A)	91-95			
	RL250 L/M	74-75			
	RM250 A/B/C/N/T/X/Z/D/E/F/G/H /J/K/L/M/N/P/R/S	76-95			
	RMX250 K/L/M/N/P/R/S/T/V/W	89-98			
	RMX250 SN/SR/S-S (SJ13A)	95-97			
	RMX250 ST/SV/SW/SX (SJ14A)	96-99			
	TS250 K/L/M/A/B/C/ERN/ERT/ERX	73-81			
	TV250 J/K/RK/L (VJ21A) Wolf	88-90			
	DR350 SL/SM/SN/SP/SER /SES/SET/SEV/SEW/SEX	90-99			
	SG350 N Goose	92			
	SP370 C/N	78-79			
	GT380 K-M/A/B	73-77			
	DR400 ST/SX	80-81			
	GN400 TT	80			
	GSX400 ET/EX/EZ	80-82			
	GSX400 FEX/FZ/FD	81-83			
	GSX400 FW/FWS/FWS-2				
	GSX400 TX/LX	81			

Part No.	Make/Model	Year	Part No.	Make/Model	Year	
CT023 Contd.	HUSQVARNA		CT029 Contd.	SUZUKI		
	FC 250	14-20		TU250 T/XS/XT/X-ST/XSV Volty	92-97	
	TC 250	14-20		TU250 XTX/XXTY (NJ45A-115-) Volty	99-00	
	TE 250	14-20		TU250 GY/GBK1 Grass Tracker		
	TE 300	14-20		Big Boy (NJ47A-117/123)	00-01	
	TX 300i	18-20		VL250 Y/K1/K5/K6/K7 Intruder	00-01/05-07	
	FC 350	14-20		TU250 XV/XW	97-00	
	FE 350	14-20		VS400 VR/FR/VTR/FTR/VT/FT Intruder	94-	
	KTM			VS600 GLS/GLT/GLV	95-97	
	FX 350	17-20		GR650 D/XD	83	
	FC 450	14-20		VS700 GLFG/GLEFG/GLPH/GLEPH	86-87	
	FC 450 Rockstar Edition	20		VS750 GLF/GLFG/GLFH/GLPG		
	FE 450	14-20		/GLPK/GLPL/GLPM/GLPH		
	FS 450	15-20		/GLEFH/GLEPH (VR51A)	85-91	
FX 450	17-20	VS800 GLN/GLP/GLR/GLS/GLT/GLV	92-97			
FE 501	14-20	VL800 K1-K5 Intruder Volusia	01-05			
CT024	SUZUKI		C800 Intruder - Spoke Wheels (VL 800 K6/K7/K8/K9/L0/L1/L2/L3/L5)	06-15		
	DR650 SET/SEV	96-97	C800 C Intruder - Cast Wheels (VL 800 CK7/CK8/CK9/CL0/CL1/CL2/CL3)	07-15		
	XF650 V/W/X/Y Freewind	97-02	C800 Intruder - Cast Wheels (VL 800 BLT4)	14		
	DR750 SJ/SK	88-89	VX800 L/M/N/P/R/T (8 Spring CSK Kit)	90-96		
	DR 800 SL (SR43A)/SM/SN/SP		VZ800 V/W/X/Y/K1/K2 Marauder (8 Spring CSK Kit)	97-02		
	/SR/SS (SR43B)	90-95	M800 (VZ 800 K5-K9/L0/L1/L3)			
	DR 800 ST/SV (SR43B)	96-97	Intruder M800	05-13		
	CCM		M800 T (VZ 800 L4/L5 Intruder M800/T)	14-15		
	R30(644 Suzuki Engine)	02-04	M800 Z (VZ 800 K9Z Intruder M800/Z)	09-10		
	644DS/Supermoto	04	GV1200 GLF/GLF2/GLG Madura	85-86		
CT024SP	SUZUKI		GV1400 Cavalcade (All models)	85-88		
	GS1000 GT/GX	80-81	VS1400 GLPH/GLPJ/GLFH/GLFJ			
	GSX1000 SZ	82	/GLPR/GLPT/GLPV/GLPW			
	GS1100 GZ	82	/GLPY/GLPK1/GLPK2	87-03		
	GSX1100 ET/EX/EZ	80-82	CT029SP	SUZUKI	ST400 V/W/X/Y/K1/K2/K3 Tempter	97-03
	GSX1100 SZ	82			DR500 X/Z/D	81-83
	GSX1100 EFE/EFG/ESF	84-86			DR600 RG/RH/RJ/RK (SN41A)	86-89
	GSX 1100 SD	83			DR600 SF/SG/SH/SJ/SK (SN41A)	85-89
	GSX 1100 ESD	83			DR650 RL/RM (SP41A)	90-91
	VL1500 W/X/Y/K1/K2/K3				DR650 RSL/RSM (SP42A)	90-91
Intruder Legendary Classic	98-03	DR650 RUN/RN/RUP/RP (SP44A/B)			92-93	
VL1500 K5/K6/K7/K8/K9		DR650 RSEM/RSEN/RSEP (SP43A/B)			91-93	
(C 1500 Intruder)	05-09	DR650 RER/RES (SP45A/B)			94-95	
		LS650 Savage FG/PK/PM/PR/PG/PT/PV			87-97	
CT025	YAMAHA		CT030	KTM	350EXC	94
	TDR250				350Super Comp	94-95
	(3CK1/3CK2 Europe - Eng/Frame # 3CK)	88-92			380EGS	98-99
	TZR250				400Duke	94-95
	(2MA/2XW1/2XW2 Europe				400EGS-E	97
	- Eng/Frame # 2MA -)	87-92			400EGS	94/96-97
TZR250		400EXC	94/96			
(1KT/2AW Japan		400LC-4	98			
- Eng/Frame # 1KT - 000/056-)	87	400LC4-E	00-01			
TZR250		LC4R 400	99			
(2XT1 Japan - Eng/Frame # 1KT - 09-)	88	400LSE	97			
		400LS-E	04			
CT026	APRILIA		400Super Comp	95		
	RS50	06-10	400Super Comp/EXC	96-99		
	RX50	06-09	400RXC-E	96-97		
	DERBI		SXC400	97		
	GPR50 Nude	04-05	400SX-X	98		
	GPR50 R	97-00	400SX	99		
	GPR50 Racing	04-05	400SXC	00		
GPR50 Replica	99-05	400TXC	98			
Senda50 (4 Plate Clutch)	99-05	540SX-C	98-99			
CT027	KTM		620Duke	94/97		
	SX60	98-00	620EGS	94-95		
	SX65	98-08	620EGS/Adventure	96-97		
CT028	KTM		620EGS-E	97		
	SX 85 (17"/14" Wheels)	03-17	620Enduro Ltd	97		
	SX 85 (19"/16" Wheels)	03-17	620EXC	94-95		
CT029	SUZUKI		620LC-4	98		
	VL125 Y/K1-K7 Intruder	00-08	620LC4 Competition	99		
	GN250 F/J/M/R/T (NJ41A)	85-97	620LC4 Super Moto	99		
	GW250 L3/ZL5 Inazuma	13-15	620LSE	97		
	GW 250 FL5 Inazuma	15	620RXC-E	96-97		
	GZ250 X/Y/K1-K8 Marauder	99-08				
	SW-1(NJ45A)	92				

Part No.	Make/Model	Year	Part No.	Make/Model	Year		
CT030 Contd.	KTM		CT033SP Contd.	SUZUKI			
	620Six Days	96		DL650 K4-K6 V-Strom	04-06		
	620Super Comp	94-99		DL650 AK7/AK8/AK9/ALO/AL2/AL3			
	620SC	00-01		/AL4/AL5 V-Strom ABS	07-15		
	SX620	94/97-99		DL 650 XT V-Strom	15-20		
	SXC620	97		DL650 AL1XP V-Strom Xpedition ABS	11		
	620Supermoto	98		DL650 AK9GT V-Strom Traveller ABS	09-10		
	620TXC	98		DL650 XK7/XK8/XK9/XLO V-Strom	04-11		
	625SC	02		SFV650 K9/L0/L1/L2/L3/L4/L5			
	625SMC	04/06		Gladius (Non ABS)	09-15		
	625SXC	03-04		SFV650 AK9/ALO/AL1/AL2/AL3/AL4/AL5			
	640Adventure-R	98-02		Gladius (ABS)	09-15		
	640Duke-E	98		SV650 K3/K4/K5/K6/K7/K8/K9/L0			
	Duke-E640	98		(Naked - Non ABS)	03-10		
	Duke II 640	99-07		SV650 SK3/SK4/SK5/SK6/SK7			
	640LC Rallye Dakar	97		/SK8/SK9/SLO (Top Fairing Non ABS)	03-15		
	640LC4	99-00		SV650 AK7/AK8/AK9/ALO			
	640LC4 Six Days	99		(Naked ABS Model)	03-10		
	640LC4-E	00-02		SV650 SAK7/SAK8/SAK9/SALO			
	640LC4 Adventure	03-06		(Top Fairing - ABS Model)	03-15		
	640LC4 Supermoto	03-04		SV 650 (ABS)	16-20		
	660LC4	97					
	660LC4 Rallye	99-00		CT034SP	APRILIA		
	660Rallye	01-03		AF1125	AF1125	87-91	
	660Rallye factory	04		Classic125	Classic125	95-01	
	660SM Factory Replica	02-03		MX125	MX125	04-06	
	660SMC	03-04		Pegaso125	Pegaso125	91-95	
	660SMS	04		RedRose 125 (Cast Wheel)	RedRose 125 (Cast Wheel)	87	
	690Rally Factory Replica	07-09		RedRose 125 (Spoke Wheel)	RedRose 125 (Spoke Wheel)	88-94	
				RS125 (2T)	RS125 (2T)	92-14	
		RX125	RX125	92-98			
		Tuono125	Tuono125	03-04			
CT031	HONDA		CT035SP	SUZUKI			
	CB500 T (Twin)	75-77			RE5 M/A	75-76	
	CBX750 FE	84-85			GT550 J/K/L/M/A/B	72-77	
	VF750 FD/FE	83-85			GS1000 HC/EC/EN/SN/ET	78-80	
	VF750 SC (V45 Sabre)	82					
	VF750 CH	87			CT036SP	SUZUKI	
	VT750 C Shadow	83			GSX600 FN/FP/FR/FS/FT/FV	92-97	
	XLV750 R (RD/RF)	83-88			RF600 RP/RR/RS/RT	93-96	
	VF1000 FE/FF/RE/RF/RG/F2F	84-86			GSX750 FK/FL/FM/FN/FP/FR/FS/FT/FV	89-97	
	VT1100 CH/CJ/CN/CP/CR/CS/CT				GSXR750 J/K/L/M/WN/WP/WR/WS	88-95	
/CV/CW Shadow	87-98						
VT1100 C2 (S/T/N/W/X/Y/1/2/3/4/5)	95-05						
VT1100 C3 (W/X/Y)	98-00						
CT032	KAWASAKI		CT037SP	SUZUKI			
	ZG1300 A1-A3	84-86			RG400 EWF/EW-2G/EWH Walter Wolf	85-87	
	VN1500 B2/C1/C2/D1	88-96			RG500 G/CH	85-87	
	VN1500 B2-B6	88-92					
	VN1500 C1/C2	94-95			CT038SP	SUZUKI	
	VN1500 D1/D2	96-98			T20 Super Six	66-68	
	VN1500 G1/G2	98-99					
	VN1500 E1/E2 Classic	98-99			CT039	YAMAHA	
	VN1500 J1/J2/R1/R2/R3 Drifter	99-04			AG100 E Farm Bike	AG100 E Farm Bike	93
	VN1500 N1/N2/N3 Classic Fi	00-04			AG100 J (3HAA)	AG100 J (3HAA)	82
	VN1500 L1/L2/L3/L4 Classic Tourer Fi	00-03	AS3 125	AS3 125	71-72		
	VN1500 P1/P2 Mean Streak	02-04	DT100	DT100	76-80		
	VN1600 A1/A2/A3/A6F Classic	03-08	RS100 - 478	RS100 - 478	75-76		
	VN1600 B1/B2H/B6F/B7F (Mean Streak)	04-08	YZ100 E/F/G/H/J/K	YZ100 E/F/G/H/J/K	78-83		
	VN1600 D1H/D6F Classic Tourer	05-08	DT125	DT125	74		
	VN1700 B9F/BAFBFB/BCF/BDF		DT125/125 F	DT125/125 F	76-77		
	/BEF/BFF/BGF Voyager ABS	09-16	DT125 E	DT125 E	78-79		
	VN1700 C9F Classic Tourer	09	DT125 MX	DT125 MX	80-81		
	VN1700 DAF/DBF/DCF/DDF/DEF		RD 125	RD 125	73-74		
	Classic Tourer ABS	10-17	RD125 DX	RD125 DX	75-76		
	VN 1700 DFF/DGF - Vulcan 1700 Nomad	15-16	RS125/RS 125 DX	RS125/RS 125 DX	75-76		
	VN1700 E9F Classic	09	SR125 SE	SR125 SE	81-83		
	VN1700 FAF/FBF/FCF/FDF/FEF Classic ABS	10-14	SR125	SR125	89-03		
	VN1700 KBF/KCF/KDF/KEF Voyager Custom	11-17	TW125 (5EK) 4 Friction Plate Type	TW125 (5EK) 4 Friction Plate Type	99-02		
	VN2000 A1/A2/A6F	04-07	TW125 (5RS) 5 Friction Plate Type	TW125 (5RS) 5 Friction Plate Type	03-04		
	VN2000 H8F/H9F Classic	08-09	TY125	TY125	80-82		
	SUZUKI		XT125	XT125	82-83		
	M1600 (VZ 1600 K4/K5)		YZ125 C/D/E/F/G/H (2T)	YZ125 C/D/E/F/G/H (2T)	76-81		
	(M 1600 Marauder)	04-05	DT175	DT175	74-77		
			DT175 MX	DT175 MX	78-81		
		IT175 G/H/J	IT175 G/H/J	80-82			
		TY175	TY175	77-80			
CT033SP	SUZUKI						
SV400 N (VK53A)	98	AG200 E (3GX6)	AG200 E (3GX6)	93			
SV400 X/Y/K1/K2/K3/K4/K5	99-05	IT200 L	IT200 L	84			
SV400 SN (VK53A)	98	RD200 DX	RD200 DX	76-81			
SV400 SX/SY/SK1/SK2/SK3/SK4/SK5	99-05						

Part No.	Make/Model	Year	Part No.	Make/Model	Year
CT039 Contd.	YAMAHA Contd.		CT044 Contd.	YAMAHA Contd.	
	RS200	79-80		RS100 (1Y8 Europe)	77-78
	TW200 (2JL/4CS1/2/3/5)	91-98		RS100 S (1Y8 UK)	77-78
	TW200 (4CS4/6/5LB1/2)	98-01		RS100 DX (1Y8 Europe)	79
	ST225 (5BT) Bronco	97		RS100 (1Y9 UK)	79-81
	TW225 E (5VC1/2)	02-03		RS100 (1Y8 Europe)	80-82
	XT225 (2LN) Serrow (1KH 020101-)	86-87		RT100 E/F/K	93-03
	XT225 (3RW1/2/4/5 Serrow) (1KH 034101-132000)	89-93		RXS 100	83-97
	XT225 S (3RW3 Serrow) (1KH 034101-132000)	92		YB100	78-92
	XT225 (3RW4) Serrow (1KH 080101-)	92		RX115 (5FS3)	99
	XT225 W (4JG1/2/3/4) Serrow	93-95		DT125 LC Type 35A	85-87
	XT225 WE (4JG5/6) Serrow	97-98		DT125 (3TT4)	96
	XT225 (4VW1/3/5/7/9) (4VWA/B/D/G/J/L) (Brasil)	97-06		IT125 G/H/J	80-82
				RD125 DX	78-81
		RD125 LC (MK1-MK3)	82-87		
		RZ125 (1GV 030101-)	85		
		RS125	77-81		
		TT-R 125 LW	00-20		
		XT125 R (3D61/3D63) - 5 Friction plate type	05-06		
		XT125 R (13D1) - 5 Friction plate type	07		
		XT125 X (3D62/3D64) - 5 Friction plate type	05-06		
		XT125 X (13D2) - 5 Friction plate type	07		
		XTZ125 (5RM) (5 plate clutch)	03-10		
		YBR125 E/K (5HH1/2/C/G/J/5LX/5LX9) (Drum Front/Brazil) - 5 Friction plate type	00-06		
		YBR125 ED (5HHB/F/H) (Disc front/Brazil) - 5 Friction plate type	06-08		
		RX135 (13X)	81		
		DT175 (3TS4)	96		
CT040SP	CCM 604Trial/SM/RS/R30 (Rotax Engine)	98-03			
CT041	KTM		CT045	SUZUKI	
	EXC400 (4T)	09-11		LT-R450 K6/K7/K8/K9/L0/L1	06-12
	EXC450 (4T/Coil Spring)	09-11		RM-X450 ZL0/ZL2	10-15
	EXC450 Six Days (4T)	11		RM-Z450 K5-K9/L0/L1-L9	05-20
	EXC-R450 (4T)	08-10			
	EXC-R530 (4T) - (9 Friction plate type)	08			
	EXC530 - (7 Friction Plate Type)	08			
EXC530 - (9 Friction Plate Type)	09-11				
CT042	KAWASAKI		CT046	SUZUKI	
	KDX125 A1/A2/B1/B2	90-94		GT250 K/L	73-74
	KX125 D1/E1/E2/F1/F1/H1/H2/J1/J2	85-93		T250 II/R/J	70-72
	KDX200 C1/C2/C3/E1-E6	86-94		T350 1/2/R/J	69-72
	KL250 H1 Super Sherpa	98		T500 36191 (18 ears)	68-70
	KL250 J1 Stockman				
	KLX250 D1/D2	93-95			
	KLX250 F1-F4 (KLX 250 E)	94-97			
	KLX250 G1	94-			
	KLX250 J1-J6 D-Tracker	98-03			
	KLX250 S H6F/H7F	06-07			
	KLX250 (KLX 250 S9F/SAF/SBF /SCF/SDF/SEF/SFF/SGF)	09-16			
	KLX300 A2-A10/A6F	97-06			
	SUZUKI 250SBK2 (LX 250 L)	02			
CT043SP	HONDA		CT047SP	SUZUKI	
	CBR1000 RR8/RR9/RRA/RRB RRC/RRD/RRE/RA9/RAA/RAB/RAC/RAD /RAE/RRF/RRG/RAF/RAG Fireblade (Diaphragm Type Clutch)	08-16		GSX400 FSV/FSK1 (GK7BA) Inazuma	00
	VFR 1200 FA (Manual Gearbox Model)	10-15		GSF600 S/T/V/W/X (Naked Bandit)	95-99
	CBR1000 RR-SP ABS Fireblade (CBS1000 SAE/SAF/SAG)	14-16		GSF600 ST/SV/SW/SX (Faired Bandit)	96-99
	CBR1000 RR-SP ABS-TT Edition	16		GSF600 Y/K1/K2/K3/K4 (Naked Bandit)	00-04
				GSF600 SY/SK1/SK2/SK3/SK4 (Faired Bandit)	00-04
				GSX600 FJ/FK/FL/FM	88-91
		GSX600 FW/FX/FY/FK1/FK2/FK3 /FK4/FK5/FK6	98-06		
		GSF650 K5/K6 Naked Bandit - Non ABS	05-06		
		GSF650 SK5/SK6 Faired Bandit - Non ABS	05-06		
		GSF650 AK5/AK6 Naked Bandit - ABS Model	05-06		
		GSF650 SAK5/SAK6 Faired Bandit - ABS Model	05-06		
		GSX750 FW/FX/FY/FK1-FK6	98-06		
		GSX750 W/X/Y/K1	98-03		
		GSXR750 F/G/H (GR75A)	85-87		
CT044	YAMAHA		CT048SP	SUZUKI	
	FS1 E/FS 1 DX	74-80		GSX 1100 FJ/FK/FL/FM/FN/FP/FR	88-94
	FS1	87-90	GSXR 1100 G/H/J	86-88	
	FS1 SE	81-82			
	DT50 M	78-79			
	DT50 M/MX	80-95			
	DT50 LC	98			
	RD50 M/MX	78-83			
	RD50	86-87			
	RZ50 (5FC1/2)	02			
	TY50/TY 50 M (1F4/1G7)	77-78			
	TY50 M (2K0)	80			
	YZ50 G/H/J/K	80-83			
	DT80 LC1 (37A) - 4 Plate Clutch	81-84			
	DT80 LC2 (53A) - 5 Plate Clutch	85-92			
	DT80 MX Type 5J2	81-82			
	DT80 MX Type 12X	83			
	DT80 MX Type 36N	83-85			
DT80 MXS	84				
RD80	82				
RD80 LC	82				
TY80	77-83				
YZ80 D/E/F/G	77-80				
			CT049	KTM	
			Reklus After Market Clutch for EXC 250 /300 (2T Models/24 Tooth Steel Plate	03-11	
			Reklus After Market Clutch for SX 250/300 (2T Models/24 Tooth Steel Plate	03-11	
			CT050SP	YAMAHA	
			XVZ12 TD	85	
			V-MAX All models	91-03	
			XVZ13 Royal Star All models	96-01	
			XV1600 A Wild Star	99-04	
			XV1700 PCR Road Star Warrior	03-05	

Part No.	Make/Model	Year	Part No.	Make/Model	Year		
CT051	SUZUKI AP50 RB50 H A100 L/M/N TS100 K/L/M/A/B	-78	CT059 Contd.	KTM Contd. SX 520 525 EXC Racing 525 EXC-G Racing 525 MXC Desert Racing 525 MXC-G Racing 525 SX Racing	00-01		
		87			04		
		74-80			04		
		73-77			04		
CT052	SUZUKI B120 T125/125-11/R Stinger	69-71	CT060	YAMAHA IT250 L TY250 S/R TY250 R YTZ250 N/S (TRI Z) YZ250 J/K/L/N/S/T (2T) IT490 L YZ490 J/K/L/N/S/T/U WR500 ZD	84		
					84-90		
CT053SP	HONDA CX500 Turbo CX650 TD Turbo GL1200 AE/DE/AF	82	CT061	YAMAHA WR125 R WR125 X (Supermoto) YZF-R 125 (Standard Mount Front Caliper)	09-15		
		83			09-16		
		84-85			08-13		
CT054SP	YAMAHA YZ125 K/L/N/S/T/U/W/A (2T) FZR600 R (4JH1/4) FZS600 Fazer FZS600 Fazer/SP YZF600 Thunder Cat	83-90	CT066SP	HONDA CBX1000 Z/B/C	79-81		
		94-95			CT068SP	HONDA GL1500 J/K/L/SEM/SEN/SEP/SER /SES/SEX Goldwing GL1500 CV/CW/CX/CY/C1/C2 F6C GL1500 SEV/SEW/SEX/SEY Goldwing	88-96
		98-99					97-03
		00-03					97-00
CT055SP	SUZUKI GSXR600 V/W/X/Y (SRAD) GSXR750 T/V/W/X (SRAD) RF900 RR GSX1100 GM/GN GSXR1100 K/L/M/N GSXR1100 WP/WR/WS/WT GS1200 SSK/ZK1 (GV78A) GSF1200 T/V/W/X/Y (Naked Bandit - 4 Piston Caliper) GSF1200 K1/K2/K3/K4/K5 (Naked Bandit 6 Piston caliper) GSF1200 ST/SV/SW/SX/SY (Faired Bandit - 4 Piston Caliper) GSF1200 SAV ABS Bandit GSF1200 SK1/SK2/SK3/SK4/SK5 (Faired Bandit 6 Piston caliper) GSF1200 K6/AK6 (Naked Bandit - Non & ABS Version - 4 Piston caliper) GSF1200 SK6/SAK6 (Faired Bandit - Non & ABS Version - 4 Piston caliper) GSX1200 FSW/FSX Inazuma (GV76A)	97-00	CT069	KTM 690 Duke 690 Duke R 690 Enduro 690 R Enduro 690 SMR 690 SM 690 SMC 690 SMC-R 690 SM-LE (Limited Edition) HUSQVARNA Svartpilen 401 Vitpilen 401 701 Enduro R 701 Supermoto Svartpilen 701 Vitpilen 701	08-14		
		96-99			10-11/13-14		
		94			08-14		
		91-94			09-14		
		89-92			07-11		
		93-96			07-09		
		01			08-11		
		96-00			12-18		
		01-05			10-11		
		01-05			18-20		
		06			18-20		
		06			16-19		
		98-99			16-19		
					18-20		
					18-20		
		CT056SP			HONDA ST1100 L/M/N/P/R/S/T/V/W/X/Y/1/2 (Pan European - Non ABS Model) ST1100 AN/AP/AR/AS/AT/AV/AW/AX/AY /A1/A2 (Pan European ABS model)	90-02 92-02	CT070SP
CT057SP	KTM SX65	09-15	CT071SP	HONDA NSR 250 R2R/R3R/R2T/R3T NSR 250 R6K/R6K-2 NSR 250 R8L-3/R9L/R8N/R8N-3 NSR 250 R9N SUZUKI RGV 250 T (RGVR 250 SP) VJ23A Dry Clutch	89 90-92 92 96		
CT058	KAWASAKI KE125 A7-A12 KH125 A1-A4 KX125 B1/B2/C1 KDX175 A1-A3 KE175 B1/B2/B3 KE175 D2-D5 KDX200 A1/A2/A3 KH250 B4/B5 KT250 A/A2 S2/S2A(350cc) S3/S3A(400cc) KH400 A3-A5	80-85	CT059	KTM 250 EXC-G Racing 250 EXC Racing 400 EXC 400 MXC SX 400 450 EXC Racing 450 EXC-G Racing 450 MXC-G Racing 520 EXC	04		
		77-81			04		
		82-84			00-02		
		80-82			01		
		76-78			00-01		
		79-83			04		
		83-85			04		
		79-80			04		
		75-76			04		
		72-73			04		
		74-75			04		
		76-78			00-01		

Part No.	Make/Model	Year	Part No.	Make/Model	Year
CT072SP	SUZUKI GSXR 750 RG (Dry Clutch-Sintered Friction)	86	CT085 Contd.	BMW Contd. F800 GS (Late type plates 2 x 13mm/7 x 14mm ears) F800 GS Adventure (Late type plates 2 x 13mm/7 x 14mm ears) F800 GT (Late type plates 2 x 13mm/7 x 14mm ears) F800 S (Late type plates 2 x 13mm/7 x 14mm ears) F800 ST (Late type plates 2 x 13mm/7 x 14mm ears) F800 R (Late type plates 2 x 13mm/7 x 14mm ears) F800 GT (Early type plates 14mm ears) F800 S (Early type plates 14mm ears) F800 ST (Early type plates 14mm ears)	12-19
CT073	HONDA GL1800 A1-A5 Goldwing GL1800 5-9/A Goldwing	01-05 06-15			12-19
CT074	YAMAHA XS650 XS650 XS650SE	75-79			07-19
		80-81			07-19
		79-81			07-19
CT075	KTM 350 MX (2T) 350 Enduro (2T) EXC 400 (LC4 Engine) 400 RXC-E SC 400 (LC4 Engine) 500 MX (2T) 500 MX (4T) LC 500 Enduro (2T) 500 Enduro (4T) LC 600 MX (4T) LC 600 Enduro (4T) LC 620 RXC-E	89			05-19
		89			04-06
		93-95			04-06
		95			04-06
		89			16-18
		89	16-18		
		89	16-20		
		89	16-20		
		89	16-20		
		89	16-18		
		95	16-18		
CT076SP	HONDA CB 750 K1 (From E.No:-1056080) CB 750 K2/K3/K4/K5 CB 750 K6/K7/F2 GL 1000 K1/K2 (From E.No: -2002384)	70-71	16-20		
		71-75	18-20		
		76-78	16-20		
		77-78	16-20		
CT077SP	YAMAHA XS1100/1100 S	78-81	CT087SP	HUSQVARNA TC 85 KTM SX 85 (17 Inch/14 Inch Wheels) SX 85 (19 Inch/16 Inch Wheels)	18 18-20 18-20
CT078SP	HONDA CB 750 KZ CB 750 FA/FB/F2C CB 900 FZ/FA/FB/F2B/F2C/FD/F2D CB 1100 RB2/RC2/RD2	80	CT088	YAMAHA MT 125 (Non ABS) MT 125 A (ABS) YZF-R 125 (Radial Mount Front Caliper/Non ABS) YZF-R 125 A (Radial Mount Front Caliper/ABS)	14-16
		79-82			14-16
CT079SP	YAMAHA YZF- R1 YZF- R1 M YZF- R1 (60th Anniversary Edition) MT-10 (998cc)	15-16	CT090SP	YAMAHA YFM 350 FWT/FWU/FWW/FWA/FWE Big Bear YFM 350 FWF/FWG/FWH/FWJ YFM 350 XD/XE/XF/XG/XH/XJ/XK/XL/XM /XN/XP/XR/XS YFM 350 ERD/ERE/ERF YFM 350 ERG YFM 350 UH/UJ YFM 350 S/T//R-WV/RW/RX/RY Raptor YFM 400 FWE/FWF/FWG/FWH/FWJ/FWK Kodiak YFM 400 FPR/FPS Big Bear	86-93
		15-16			94-97
		16			92-04
		16			92-94
CT080	YAMAHA YZF-R3 (321cc/ABS) MT-03	15-20	CT091	AJP PR5 250 Trials PR5 250 Supermoto PR5 250 Enduro PR5 250 Extreme	13-17
		12-20			13-17
CT081SP	HONDA CRF 250 L (Non ABS)/ LA (ABS) CRF 250 ME Supermoto CRF 250 RL/RLA Rally (non ABS & ABS) CB 300 FAF/FAG (ABS) CBF 300 NA CBR 300 RA ABS	13-20	CT092	CRF 450 RH (6 Spring) CRF 450 RXH (18" Rear Wheel) CRF 450 X CRF 450 L	17-20
		14-15			17-20
		17-20			18-20
		15			18-19
		18-20			18-19
		14-19			18-19
CT083	BMW G 650 GS (R13) G 650 GS Sertao (R13) G 650 XCountry (K15)	08-16 10-14 08-10	CT701SP	HARLEY DAVIDSON FLHR Road King FLHS Electra Glide Sport FLHT Electra Glide Standard FLHTC Electra Glide Classic FLHTC Touring Electra Glide Classic FLHTCI Electra Glide Classic FLHTCU Ultra Classic FLST Softail Heritage FLSTC Heritage Softail Classic FLSTC Softail Heritage Classic	93-97 90-94 94-97 91-97 90 96-97 91-97 90 91-97 90
CT084SP	HONDA Monkey 125 MSX 125 D/E/F/G/H Grom (Non ABS) MSX 125 AH//AJ/AK Grom (ABS)	19-20			91-97
		13-20			91-97
		17-20	90		
CT085	BMW F650 GS (Late type plates 2 x 13mm/7 x 14mm ears) F700 GS (Late type plates 2 x 13mm/7 x 14mm ears) F800 GS (Late type plates 2 x 13mm/7 x 14mm ears)	07-17	96-97		
		11-17	91-97		
		08-11	90		

Part No.	Make/Model	Year	Part No.	Make/Model	Year
CT071SP Contd.	HARLEY DAVIDSON Contd.		CT703SP Contd.	HARLEY DAVIDSON Contd.	
	FLSTF Fat Boy	91-97		FLHTCU TC Ultra Classic Twin-Cooled	14-16
	FLSTF Softail Fat Boy	90		FLHTCUI Ultra Classic	98-03
	FLSTN Heritage Softail Nostalgia	93-96		FLHTK Ultra Limited	14-16
	FLSTS Heritage Springer	97		FLHX Street Glide	14-16
	FLTC Tour Glide Classic	90-92		FLHXS Street Glide Special	14-16
	FLTCU Tour Glide Ultra Classic	91-95		FLSTC Heritage Softail Classic	98-03
	FLTCU Tour Glide Classic Ultra	90-96		FLSTF Fat Boy	98-03
	FXD Dyna Super Glide	95-97		FLSTS Heritage Springer	98-03
	FXDB Dyna Daytona	92		FLTR Road Glide	98-03
	FXDB Dyna Sturgis	91		FLTRU Road Glide Ultra	15-16
	FXDC Super Glide Custom	92		FLTRX Road Glide	15-16
	FXDL Dyna Low Rider	93-97		FLTRXS Road Glide Special	15-16
	FXDS-CONV Dyna Glide Convertible	93		FXD Dyna Super Glide	98-03
	FXDWG Dyna Wide Glide	93-97		FXDL Dyna Low Rider	98-03
	FXST Softail Standard	90		FXDS-CONV Dyna Glide Convertible	99-00
	FXSTC Softail Custom	90-97		FXDWG Dyna Wide Glide	98-05
	FXSTS Springer Softail	90-97		FXDX Dyna Super Glide Sport	99-03
	XL1200 Sportster 1200	91-03		FXDXT Dyna Super Glide T-Sport	01-03
	XL1200 Forty Eight Anniversary	18		FXST Softail Standard	99-03
	XL1200C Sportster 1200 Custom	96-20		FXSTB Night Train	99-03
	XL1200C ANV Sportster 1200 Custom Anniversary	13		FXSTC Softail Custom	98-99
	XL1200CA Sportster 1200 Custom Limited	13-17		FXSTD Softail Deuce	00-03
	XL1200CP Sportster 1200 Custom (H-D1)	11-16		FXSTI Softail Standard	01-03
	XL1200CX 1200 Roadster	16-20		FXSTS Springer Softail	98-03
	XL1200L Sportster 1200 Low	06-11		FLD 103 Dyna Switchback	12-16
	XL1200N Nightster	07-12		FLHR 103 Road King	11-13
	XL1200R Sportster 1200 Roadster	04-09		FLHR Road King	04-05
	XL1200S Sportster 1200 Sport	96-03		FLHR ANV Road King ANV	2013
	XL1200T SuperLow 1200T	14-20		FLHRC 103 Road King Classic	11-13
	XL1200V Seventy-Two	12-16		FLHRCI Road King Classic	04-05
	XL1200X Forty Eight	10-20		FLHRI Road King	04-05
	XL50 50th Anniversary Sportster	07		FLHRS Road King Custom	04-05
	XL883 Sportster 883	91-09		FLHT Electra Glide Standard	04-05
	XL883C Sportster 883 Custom	98-10		FLHTC 103 Electra Glide Classic	11-13
	XL883DLX Sportster 883 Deluxe	91-95		FLHTC Electra Glide Classic	04-05
	XL883HUG Sportster 883 Hugger	91-03		FLHTCI Ultra Classic	2005
	XL883L Sportster 883 SuperLow	05-20		FLHTCU 103 Ultra Classic	11-13
	XL883N Iron 883	09-20		FLHTCUI Ultra Classic	04
	XL883R 883 Roadster	11-15		FLHTI Electra Glide Standard	04-05
	XL883R 883R Sportster	02-10		FLHTK Electra Glide Ultra Limited	10-13
	XR1200 Sportster 1200	08-10		FLHTK ANV Electra Glide Ultra Limited ANV	13
	XR1200X XR1200X	10-13		FLHX 103 Street Glide	11-13
CT702SP	HARLEY DAVIDSON		FLS 103 Softail Slim	12-15	
	FLHTCUTG Tri Glide Ultra Classic	14-16	FLS Slim	17	
	FLRT Freewheeler	15-16	FLS Softail Slim	16	
	FLHTK 103 CVO Limited	14	FLSTC 103 Heritage Softail Classic	13-15	
	FLHTCUL Ultra Classic Low	15-16	FLSTC 103 ANV Heritage Softail Classic ANV	13	
	FLHTCUL TC Ultra Classic Low Twin-Cooled	15-16	FLSTC Heritage Softail Classic	04-05	
	FLHTKL Ultra Limited Low	15-16	FLSTC Heritage Softail Classic	16-17	
	FLHR Road King	17-20	FLSTCI Shrine Heritage Softail Classic Shrine	05	
	FLHRC Road King Classic	17	FLSTF 103 Fat Boy	12-15	
	FLHTCU Electra Glide Ultra Classic	17-20	FLSTF Fat Boy	04-05	
	FLHTK Ultra Limited	17-20	FLSTF Fat Boy	16-17	
	FLHTKL Ultra Limited Low	17-20	FLSTFB 103 Fat Boy LO	12-17	
	FLHX Street Glide	17-20	FLSTFB 103 ANV Fat Boy LO ANV	13	
	FLHXS Street Glide Special	17-20	FLSTFI Shrine Fat Boy Shrine	05	
	FLTRU Road Glide Ultra	17-20	FLSTN 103 Softail Deluxe	12-15	
	FLTRX Road Glide	17-20	FLSTN Softail Deluxe	05	
	FLTRXS Road Glide Special	17-20	FLSTN Softail Deluxe	16-17	
	FLHRXS Road King Special	17-20	FLSTSC Springer Classic	05-06	
	FLHTK Ultra Limited Shrine Edition	18	FLTRI Road Glide	04-05	
	FLHTK Ultra Limited Anniversary	18	FLTRU Road Glide Ultra	11-13	
	FLHX Street Glide Anniversary	18	FLTRX 103 Road Glide Custom	11-13	
	FLHXS Street Glide Special Anniversary	18	FXD Dyna Super Glide	04-05	
	FLSS Softail Slim S	16	FXDB 103 Dyna Street Bob	14-16	
	FLSTFBS Fat Boy S	16-17	FXDB 103 Dyna Street Bob 103	17	
	FLSS Slim S	17	FXDBA 103 Dyna Street Bob (H-D1)	13-15	
	FLSTFBS Fat Boy S	17	FXDBC 103 Dyna Street Bob Limited	16	
	CT703SP	HARLEY DAVIDSON		FXDC 103 Dyna Super Glide Custom	14
		FLHR Road King	15-16	FXDC Dyna Super Glide Custom	05
		FLHR Road King	98-03	FXDF 103 Dyna Fat Bob	12-17
		FLHRC Road King Classic	14-16	FXDI Dyna Super Glide	04-05
		FLHRCI Road King Classic	98-99	FXDL 103 Dyna Low Rider	14-16
		FLHT Electra Glide Standard	98-03	FXDL 103 Low Rider 103	17
FLHTC Electra Glide Classic		98-03	FXDL Dyna Low Rider	04-05	
FLHTCU Ultra Classic		14-16	FXDWG 103 Dyna Wide Glide	12-16	
			FXDWG 103 Dyna Wide Glide 103	17	
			FXDWGI Dyna Wide Glide	04-05	

Part No.	Make/Model	Year	Part No.	Make/Model	Year	
CT703SP Contd.	HARLEY DAVIDSON Contd.		CT704SP Contd.	HARLEY DAVIDSON Contd.		
	FXDX Dyna Super Glide Sport	04-05		FLHTC Electra Glide Classic	83	
	FXS 103 Blackline	11-13		FLT Tour Glide	81-83	
	FXSB 103 Softail Breakout	13-16		FLT Tour Glide Classic	80-83	
	FXSB Breakout	17		FXB Super Glide B80	81-82	
	FXST 1BHY Softail Standard	04-06		FXDG Dyna Glide Glide Custom	83	
	FXST Softail Standard	12-15		FXE Super Glide	81-83	
	FXSTB Night Train	04-05		FXEF Super Glide Fat Bob	81	
	FXSTD Softail Deuce	04-05		FXSB Low Rider	83-84	
	FXSTS Springer Softail	04-05				
	FLD Dyna Switchback	12-16		CT705SP	HARLEY DAVIDSON	
	FLHR Road King	06-11			FXST Softail Standard	EARLY 84
	FLHRC Road King Classic	06-11			FXWG Wide Glide	81-84
	FLHRS Road King Custom	06-07			FLH Electra Glide	84-88
	FLHT Electra Glide Standard	06-10			FLH Electra Glide Shrine Shovelhead	84
	FLHTC Electra Glide Classic	06-11			FLHS Electra Glide Sport	84-89
	FLHTCU Ultra Classic	06-11	FLHT Electra Glide Classic		84-89	
	FLHX Street Glide	06-11	FLHTCU Electra Glide Classic Ultra		89	
	FLS Softail Slim	12-15	FLST Softail Heritage		86-89	
	FLST Heritage Softail	06-09	FLSTC Softail Heritage Classic		87-89	
	FLSTC 103 Heritage Softail Classic	06-15	FLT Tour Glide Classic		84-89	
	FLSTC Heritage Softail Classic Anv	13	FLT Tour Glide		84	
	FLSTF Fat Boy	06-15	FLTCU Tour Glide Classic Ultra		89	
	FLSTFB Fat Boy LO	10-15	FXE Super Glide		84	
	FLSTFB Fat Boy LO Anv	13	FXEF Super Glide Fat Bob		85	
	FLSTN Softail Deluxe	06-15	FXSB Low Rider		84-85	
	FLSTSB Cross Bones	08-11	FXST Softail Standard		84-89	
	FLSTSC Springer Classic	06-07	FXSTC Softail Custom		86-89	
	FLTR Road Glide	06-09	FXSTS Softail Springer		88-89	
	FLTRX Road Glide Custom	10-11	FXWG Wide Glide	84-86		
	FLXW Rocker	08-09				
	FLXWC Rocker C	08-11	CT706SP	HARLEY DAVIDSON		
	FXD Dyna Super Glide	07-10		VRSCAW V-Rod Wide Tire	08	
	FXD35 Dyna 35th Anniversary Super Glide	06		VRSCAWA V-Rod Wide Tire W/ABS	08	
	FXDB Dyna Street Bob	07-17		VRSCD Night Rod	08	
	FXDBC Dyna Street Bob Limited	16		VRSCDA Night Rod W/ABS	08	
	FXDC Dyna Super Glide Custom	07-14		VRSCDXA Night Rod Special W/ABS	08	
	FXDC ANV Dyna Super Glide Custom ANV	13		VRSCDX Night Rod Special	08-17	
	FXDCI Dyna Super Glide Custom	06		VRSCAW V-Rod	09-10	
	FXDF Dyna Fat Bob	08-17		VRSCF V-Rod Muscle	09-17	
	FXDI Dyna Super Glide	06		VRSCDX ANV Night Rod Special Anv	12	
	FXDL Dyna Low Rider	06-17				
	FXDWG Dyna Wide Glide	06-16	CT707SP	HARLEY DAVIDSON		
	FXDWG ANV Dyna Wide Glide 105th Anniv.	08		VRSCA V-Rod	02-07	
	FXSB Softail Breakout	13-15		VRSCSE CVO V-Rod	05-06	
	FXST Softail Standard	07-11		VRXSE CVO VR Destroyer	06	
	FXSTB Night Train	06-09		VRSCR Street Rod	06-07	
	FXSTC Softail Custom	07-10		VRSCX Screamin' Eagle V-Rod	07	
	FXSTD Softail Deuce	06-07				
	FXSTS Springer Softail	06	CT708SP	HARLEY DAVIDSON		
	FLS 103 Softail Slim	13-15		FLHTCUTG Tri Glide Ultra	17-20	
	FLSTC 103 Heritage Softail Classic	13-15		FLRT Freewheeler	17-18	
FLSTFB Fat Boy LO	13-15	FLHTCUTG Tri Glide Ultra Anniversary		18		
FLSTF 103 Fat Boy	15	FLHP Road King Police		17		
FLS Softail Slim	16	FLHTP Electra Glide Standard Police		17		
FLSTN Softail Deluxe	16	FLFBS Fat Boy 114 Anniversary		18-20		
FLSTC Heritage Softail Classic	16-17	FLHCS Heritage Classic 114		18-20		
FLSTF Fat Boy	16-17	FLHCS Heritage Classic 114 Anniversary		18		
FLSTFB Fat Boy LO	16-17	FXFBS Fat Bob 114		18		
FLS Slim	17	FLFBS Fat Boy 114		18		
FLSTN Deluxe	17	FXBRS Breakout 114		18-20		
		FXBRS Breakout 114 Anniversary		18		
CT704SP	HARLEY DAVIDSON			CT709SP	HARLEY DAVIDSON	
	FLH Electra Glide	EARLY 84	XL1200 Sportster 1200		90	
	FLH Electra Glide Shrine Shovelhead	EARLY 84	XL883 Sportster 883		86-90	
	FLHS Electra Glide Sport	EARLY 84	XL883 Sportster 883 Deluxe		86-90	
	FLHT Electra Glide	EARLY 84	XL883HUG Sportster 883 Hugger		87-90	
	FLHT Electra Glide Classic	EARLY 84	XLCH Sportster 1000		71-80	
	FLT Tour Glide Classic	EARLY-84	XLH 1100 Sportster 1100		86-87	
	FLT Tour Glide	EARLY-84	XLH Sportster 1000		84-85	
	FLH Electra Glide Shrine Shovelhead	83	XLH Sportster 1000		79-84	
	FLH Electra Glide	81-83	XLH Sportster Standard 1000		71-80	
	FLHC Electra Glide Classic	81-82	XLH883DLX Sportster 883 Hugger Deluxe		88-89	
	FLHC Electra Glide Classic	81	XLS Sportster Roadster 1000		84-85	
	FLHS Electra Glide Sport	81-83	XLS Sportster Roadster 1000		81-84	
	FLHS Heritage Electra Glide	81	XR1000 Sportster		84	
	FLHT Electra Glide Standard	83	XR1000 Sportster		83-84	
FLHT Electra Glide Classic	83					
FLHT Electra Glide	83					

BRAKE LINES



APRILIA



		OE Replacement Brake Lines (Front)	Race Standard Brake Lines (Front)	OE Replacement Brake Lines (Rear)
RS 250	94-97	BLM8008-3F	BLMR8008-2F	BLM8008-1R
RS 250	98-99	BLM8009-3F	BLMR8009-2F	BLM8009-1R
RS 250	00-02	BLM8010-3F	BLMR8010-2F	BLM8010-1R
Pegaso 650	93-96	BLM8002-1F		BLM8002-1R
Pegaso 650	97-03	BLM8003-1F		BLM8002-1R
Pegaso Strada 650	97-09	BLM8004-1F		BLM8004-1R
RST 1000 Futura	01-04	BLM8013-3F	BLMR8013-2F	BLM8013-1R
RSV 1000 Mille	98-03	BLM8015-3F	BLMR8015-2F	BLM8015-1R
RSV 1000 Mille R	03-04	BLM8017-3F	BLMR8017-2F	BLM8017-1R
RSV 1000 Mille Tuono	03-09	BLM8018-3F	BLMR8018-2F	BLM8018-1R
RSV 1000 R + RSV4 Non ABS	08-13	BLM8019-3F	BLMR8019-2F	BLM8019-1R
RSV 1000 R Factory My	04-09	BLM8020-3F	BLMR8019-2F	BLM8020-1R
SL 1000 Falco	99-03	BLM8022-3F	BLMR8022-2F	BLM8022-1R
Tuono V4 R + V4 R APRC	11	BLM8023-2F	BLMR8023-2F	BLM8023-1R

BIMOTA

SB6	ALL	BLM8024-3F	BLMR8024-2F	BLM8024-1R
-----	-----	------------	-------------	------------

BMW

F650	94-00	BLM8025-1F		BLM8025-1R
F650 GS/Dakar Non ABS	00-07	BLM8026-1F		BLM8026-1R
K75 C Full Front	86-88	BLM8039-3F		
K75 RT	91-96	BLM8040-3F		BLM8040-1R
K75 S ABS	90-96	BLM8041-2F		BLM8041-2R
K75 S Full Rear	86-90	BLM8042-3F		BLM8042-1R
K100/K100 RS/K100 RT Front	83-88	BLM8027-3F		
K100 LT ABS	90-91	BLM8028-2F		BLM8028-2R
K100 LT Non ABS	87-88	BLM8029-3F		BLM8029-1R
K100 RS Full Front	86-90	BLM8030-3F		BLM8030-1R
K100 RS 16V ABS	90-93	BLM8031-4F		BLM8031-2R
K100 RS ABS	88-90	BLM8032-4F		BLM8032-2R
K100 RS Flexible Front	86-90	BLM8033-3F		BLM8033-1R
K1100 LT ABS	89-99	BLM8034-4F		BLM8031-2R
K1100 RS 16V ABS	94-97	BLM8031-4F		BLM8031-2R
K1100 RS 16V ABS 2	94-97	BLM8036-4F		BLM8036-1R
K1100 RS Non ABS	92-93	BLM8037-3F		
K1200 RS ABS	97-01	BLM8038-6FR		Supplied as front & rear kit complete
R45/R65 Flexible Front	78-80	BLM8074-3F		
R45/R65 Full Front	79-85	BLM8075-3F		
R65 (M/C-Bundy)	85-88	BLM8076-1F		
R65 Flexible Front	81-85	BLM8077-3F		
R65 Flexible Front	85-88	BLM8078-1F		
R65 Full Front	81-85	BLM8079-3F		
R75 Gears	75	BLM8080-2F		
R75/6 Front ATE Calipers	76	BLM8081-1F		
R75/6 Full Front	75	BLM8082-1F		
R75/6 Long Front	74	BLM8083-1F		
R80/7 Flexible Front	77-80	BLM8084-2F		
R80/7 Full Front	77-80	BLM8085-2F		
R80 GS Flexible Front	86-94	BLM8086-1F		
R80 GS Full Front	80-85	BLM8087-1F		
R80 R Flexible Front	94	BLM8088-1F		
R80 RT	84-90	BLM8089-2F		BLM8089-1R
R80 RT Flexible Front	82-84	BLM8090-3F		
R80 ST Flexible Front	82-85	BLM8091-1F		
R100/R100 CS Full Front	80-84	BLM8043-3F		
R100 GS	91-96	BLM8044-1F		
R100 GS Flexible Front	91-96	BLM8044-1F		
R100 RS	87-93	BLM8046-4F		
R100 RS Full Front	77-80	BLM8047-2F		
R100 RS Flexible Front	81-86	BLM8048-3F		BLM8048-1R
R100 RR Flexible Front	80	BLM8049-2F		
R100 RT Full Front	80	BLM8050-2F		

FRONT / AVANT / VORN / FRENTE / ANTERIORE

REAR / ARRIÈRE / HINTEN / POSTERIOR / POSTERIORE

BRAKE
LINES

BRAKE LINES



BMW



		OE Replacement Brake Lines (Front)	Race Standard Brake Lines (Front)	OE Replacement Brake Lines (Rear)
R100 S ATE Flexible Front	77-80	BLM8051-2F		BLM8051-1R
R100 S Flexible Front	76-80	BLM8052-3F		BLM8052-1R
R100 T Flexible Front	79-80	BLM8053-2F		
R1100 GS ABS	94-00	BLM8054-4F		BLM8054-1R
R1100 GS Non ABS	94-00	BLM8055-3F		
R1100 R	95-96	BLM8056-4FR		Supplied as front & rear kit complete
R1100 R	97-01	BLM8057-4FR		Supplied as front & rear kit complete
R1100 RS ABS	93-00	BLM8058-5FR		Supplied as front & rear kit complete
R1100 RT ABS	95-00	BLM8059-5FR		Supplied as front & rear kit complete
R1100 S ABS	98-04	BLM8060-5FR		Supplied as front & rear kit complete
R1100 S Boxer Cup Replica	11/03-	BLM8061-4FR		Supplied as front & rear kit complete
R1100 S Non ABS	01/98-01/01	BLM8062-4FR		Supplied as front & rear kit complete
R1100 S Non ABS	02/01-11/03	BLM8063-4FR		Supplied as front & rear kit complete
R1150 GS ABS (Retaining Hardline)	11/99-02	BLM8064-5FR		Supplied as front & rear kit complete
R1150 GS ABS 2 (Retaining Hardline)	11/99-02	BLM8065-5FR		Supplied as front & rear kit complete
R1150 GS Non ABS (Replacing Hardline)	11/99-02	BLM8066-3F		BLM8066-1R
R1150 GS Non ABS (Retaining Hardline)	11/99-02	BLM8067-3F		BLM8066-1R
R1150 GS Non ABS Evo Brakes	03-04	BLM8068-4F		BLM8066-1R
R1150 GS Non ABS Evo Brakes	11/99-02	BLM8069-4F		BLM8066-1R
R1150 R	00-02	BLM8070-5FR		Supplied as front & rear kit complete
R1150 RT ABS	01	BLM8071-4F		
R1200 C ABS	96-05	BLM8072-4F		BLM8072-1R
R1200 R ABS	11-13	BLM8073-4F		BLM8073-1R
R850 C ABS	00-01	BLM8072-4F		BLM8072-1R
R850 GS ABS	00-01	BLM8054-4F		BLM8054-1R
R850 R ABS	97-01	BLM8094-5FR		Supplied as front & rear kit complete
R850 R	95-96	BLM8056-4FR		Supplied as front & rear kit complete
R850 R	97-01	BLM8057-4FR		Supplied as front & rear kit complete
R90 Flexible Front	76	BLM8097-2F		
R90S Pre Brembo Flexible Front		BLM8098-2F		
R90S Pre Brembo Full Front		BLM8099-2F		
S1000 RR Non ABS	10-14	BLM8100-3F	BLMR8100-2F	BLM8100-1R
CAGIVA				
Raptor 650 (Naked)	03-06	BLM8107-3F		
Elefant 750	87-88	BLM8103-1F		BLM8103-1R
Elefant 900	93-00	BLM8104-3F		BLM8104-1R
Elefant 900 IE	91-92	BLM8103-1F		BLM8103-1R
V-Raptor 1000 (Faired)	03-	BLM8108-3F		BLM8108-1R
DUCATI				
M 400 Monster	94-02	BLM8141-1F		BLM8141-1R
Pantah 500/600SL	80-84	BLM8147-3F		BLM8147-1R
Pantah 600TL	84-85	BLM8148-3F		BLM8148-1R
600 SS	94-98	BLM8116-1F		BLM8116-1R
M 600 Monster	94-02	BLM8141-1F		BLM8141-1R
M 620 Monster	02-04	BLM8143-3F	BLMR8143-2F	BLM8143-1R
M 696 Monster	06-08	BLM8144-2F		BLM8144-1R
748 Biposta/Strada	95-98	BLM8117-3F	BLMR8117-2F	BLM8117-1R
748 Biposta/Strada/SPS	99-03	BLM8111-3F	BLMR8118-2F	BLM8111-1R
748R	99-02	BLM8119-3F	BLMR8119-2F	BLM8119-1R
749	03-05	BLM8109-2F		BLM8109-1R
749S	04-05		BLMR8120-2F	BLM8120-1R
750/906 Paso	86-94	BLM8121-3F		BLM8121-1R
750 GT	74	BLM8122-1F		
750 SS	91-93	BLM8116-1F		BLM8116-1R
750 SS	94-97		BLMR8124-2F	BLM8116-1R
750 SS	98-02		BLMR8125-2F	BLM8125-1R
M 750 Monster	96-02	BLM8141-1F		BLM8141-1R
851 SP/888 Strada	92-93		BLMR8126-2F	BLM8126-1R
851 SP3	91	BLM8127-3F		BLM8127-1R
851 Strada	88-92	BLM8128-3F		BLM8128-1R
848	07-		BLMR8110-2F	

FRONT / AVANT / VORN / FRENTE / ANTERIORE

REAR / ARRIÈRE / HINTEN / POSTERIOR / POSTERIORE

BRAKE
LINES

BRAKE LINES



DUCATI



OE Replacement
Brake Lines (Front)

Race Standard
Brake Lines (Front)

OE Replacement
Brake Lines (Rear)

900 Superlight	94-97		BLMR8129-2F	BLM8129-1R
900 SS	94-97		BLMR8129-2F	BLM8130-1R
900 SS	98-02		BLMR8125-2F	BLM8125-1R
900 SS Supersport	77		BLMR8132-3F	BLM8132-1R
900 SS/Superlight	91-93		BLMR8129-2F	BLM8133-1R
M 900 Monster	93-99	BLM8146-3F	BLMR8146-2F	BLM8146-1R
907 IE	91-94	BLM8134-3F		BLM8134-1R
916 Biposta/SP	98-01	BLM8111-3F	BLMR8118-2F	BLM8111-1R
916 Biposta/Strada	94-97	BLM8117-3F	BLMR8117-2F	BLM8117-1R
ST2	97-03	BLM8151-3F		BLM8151-1R
ST4	98-03	BLM8152-3F		BLM8152-1R
996	98-01	BLM8111-3F	BLMR8111-2F	BLM8111-1R
996 R	00-01	BLM8119-3F	BLMR8119-2F	BLM8119-1R
S4/S4R Monster	00-08		BLMR8149-2F	BLM8146-1R
999 R	03-05	BLM8138-2F	BLMR8138-2F	BLM8138-1R
998	01-03	BLM8111-3F	BLMR8111-2F	BLM8111-1R
999	02-05		BLMR8113-2F	BLM8113-1R
Sport Classic 2006	06	BLM8150-3F		BLM8150-1R
1098/1098R/1098S/1198/1198S	07	BLM8114-3F	BLMR8114-2F	BLM8114-1R

HONDA

CBR 125 R	05-13	BLM1057-1F		BLM1057-1R
NSR 125 RK-R3	90-03	BLM1110-1F		BLM1110-1R
XLR 125	00-03	BLM1159-1F		
MSX125	16-17	BLM1167-1F		BLM1167-1R
MTX 200 RWF	85-86	BLM1105-1F		
CB 250 Hornet Import	96	BLM1010-1F		BLM1010-1R
CBR 250 R	11-13	BLM1058-1F		BLM1058-1R
CBR 250 RRJ-RRJ (MC19)	88-89	BLM1059-1F		
CBR 250 RRM-RRX (MC22)	90-99		BLMR1060-2F	BLM1060-1R
CBX 250 RSE	84-86	BLM1082-1F		
NSR 250 PGM4		BLM1113-2F		BLM1113-1R
VT 250 FD	83-87	BLM1144-1F		
CBR300R	15-17	BLM1170-1F		BLM1170-1R
CB1 (Super 400)	92-96	BLM1000-2F	BLMR1000-2F	BLM1000-1R
CBR 400 RRJ-RRJ (NC23) Triarm	88-89		BLMR1061-2F	BLM1061-1R
CBR 400 RRK-RRT (NC29) Gullarm	89-96	BLM1062-3F	BLMR1062-2F	BLM1062-1R
NS 400 RF-RG	85-87	BLM1109-3F		BLM1109-1R
NT Bros 400/600/650	88-95	BLM1114-1F		BLM1114-1R
RVF 400 RRR-RRT (NC35)	94-96	BLM1120-3F	BLMR1120-2F	BLM1120-1R
VF 400 FD	83	BLM1130-1F		BLM1130-1R
VFR 400 RF-RH (NC21)	85-87	BLM1133-3F	BLMR1133-2F	BLM1133-1R
VFR 400 RH-RK (NC24)	87-89		BLMR1134-2F	BLM1134-1R
VFR 400 RRL-RRM (NC30)	90-92		BLMR1135-2F	BLM1135-1R
CB 450 DXK	89-92	BLM1019-3F		BLM1019-1R
CB 500 V-3	97-03	BLM1024-1F		BLM1024-1R
CBF 500	04-08	BLM1048-1F		BLM1048-1RCX 500 C Custom
82	BLM1088-3F			
CX 500 EC Euro Sport	82	BLM1089-3F		BLM1089-1R
CX 500 TC Turbo	82	BLM1090-3F		BLM1090-1R
CX 500 Z-B	79-81	BLM1091-3F		
FT 500 C	82	BLM1095-1F		BLM1095-1R
GL 500 DC Silverwing	82	BLM1102-3F		
VF 500 F2E-F2F	84-85	BLM1131-3F		BLM1131-1R
VT 500 ED-EF	83-85	BLM1145-1F		
XBR 500 F-SJ	85-88	BLM1151-1F		
CB 550 SC Nighthawk	83	BLM1027-1F		BLM1027-1R
CBX 550 FC-F2D	82-84	BLM1083-3F		BLM1083-1R
CB 600 F5-F8 Hornet	05-08		BLMR1028-2F	BLM1028-1R
CB 600 FW-F4 Hornet	98-05	BLM1029-3F	BLMR1029-2F	BLM1029-1R
CBF 600 S	04-06	BLM1049-3F	BLMR1049-2F	BLM1049-1R
CBR 600 F	11-13		BLMR1063-2F	BLM1063-1R
CBR 600 RR ABS	09-17	BLM1164-4F		BLM1164-4R

FRONT / AVANT / VORN / FRENTE / ANTERIORE

REAR / ARRIÈRE / HINTEN / POSTERIOR / POSTERIORE

BRAKE
LINES

BRAKE LINES



HONDA



		OE Replacement Brake Lines (Front)	Race Standard Brake Lines (Front)	OE Replacement Brake Lines (Rear)
CBR 600 FH-FL	87-90	BLM1064-3F	BLMR1064-2F	BLM1064-1R
CBR 600 FM-FR	91-94	BLM1065-3F	BLMR1065-2F	BLM1065-1R
CBR 600 FS-FW	95-98	BLM1066-3F	BLMR1066-2F	BLM1066-1R
CBR 600 FX-F4/Sport	99-04	BLM1067-3F	BLMR1067-2F	BLM1067-1R
CBR 600 RR Non ABS	08-13		BLMR1068-2F	BLM1068-1R
CBR 600 RR3-RR4	03-04	BLM1069-3F	BLMR1069-2F	BLM1069-1R
CBR 600 RR5	05		BLMR1070-2F	BLM1070-1R
CBR 600 RR6	06		BLMR1071-2F	BLM1071-1R
CBR 600 RR7	07		BLMR1072-2F	BLM1072-1R
NTV 600 J-M	88-91	BLM1116-1F		BLM1116-1R
VT 600 CN-CW Shadow	92-98	BLM1146-1F		
XL 600 LMF Paris Dakar	85	BLM1154-1F		
XL 600 RD-RF	84-85	BLM1155-1F		
XL 600 VH-VT Transalp	87-96	BLM1156-1F		BLM1156-1R
XL 600 WV-VX Transalp	97-99		BLMR1157-2F	BLM1156-1R
CB 650 SC Nighthawk	82	BLM1030-3F		
CB 650 Z-B	79-81	BLM1031-3F		
CX 650 ED	83	BLM1092-3F		BLM1092-1R
CX 650 TD Turbo	83	BLM1093-3F		
NT 650 V Deauville (Nissan Calipers)	98-03	BLM1115-3F		BLM1115-1R
NX 650 J-T Dominator	88-96	BLM1117-1F		BLM1117-1R
NX 650 V-X Dominator	97-99	BLM1118-1F		BLM1117-1R
SLR 650 V-W	97-98	BLM1123-1F		
XL 650 Y-3 Transalp	00-05		BLMR1157-2F	BLM1156-1R
CB 750 F Supersport		BLM1032-3F		BLM1032-1R
CB 750 F1 High Bar	76-78	BLM1033-2F		BLM1033-1R
CB 750 F1 Twin Disc	76	BLM1035-3F		BLM1035-1R
CB 750 F2	77-79	BLM1036-3F		BLM1036-1R
CB 750 F2N-Y	92-02	BLM1037-3F		BLM1037-1R
CB 750 FZ-FD	79-83	BLM1038-3F		BLM1038-1R
CB 750 KZ	78-80	BLM1041-3F	BLMR1041-2F	BLM1041-1R
CBX 750 FE	84	BLM1084-3F		BLM1084-1R
NC750S/SD/SA	17-	BLM1171-2F		BLM1171-2R
NC700SD	17-	BLM1171-2F		BLM1171-2R
RVF 750 RR-RS (RC45)	94-95	BLM1121-3F	BLMR1121-2F	BLM1121-1R
VF 750 FD-FE	83-84	BLM1132-3F		BLM1132-1R
VFR 750 FG-FH	86-87	BLM1136-3F	BLMR1136-2F	BLM1136-1R
VFR 750 FJ-FK	88-89	BLM1137-3F	BLMR1137-2F	BLM1137-1R
VFR 750 FL-FP	90-93	BLM1138-3F	BLMR1138-2F	BLM1138-1R
VFR 750 FR-FV	94-97	BLM1139-3F	BLMR1139-2F	BLM1139-1R
VFR 750 RJ-RL (RC30)	88-90		BLMR1140-2F	BLM1140-1R
VT 750 Shadow	04-10	BLM1147-1F		
VT 750 V-W Shadow	97-98	BLM1148-1F		
XLV 750	84-87	BLM1160-1F		
XRV 750 L-3 Africa Twin	90-03	BLM1161-3F	BLMR1161-2F	BLM1161-1R
Pacific Coast PC800	89-98	BLM1119-3F		
VFR 800 FW-FY Non ABS	98-00	BLM1141-10FR		Supplied as front & rear kit complete
VFR 800 V-TEC ABS	02-10	BLM1142-13FR		Supplied as front & rear kit complete
VFR 800 V-TEC Non ABS	02-10	BLM1143-10FR		Supplied as front & rear kit complete
CB 900 F2-F3 Hornet	02-06	BLM1042-3F	BLMR1042-2F	BLM1042-1R
CB 900 FA-FB	80-81	BLM1043-3F		BLM1043-1R
CB 900 FC-FD	82-83	BLM1044-3F		BLM1043-1R
CB 900 FZ	79	BLM1045-3F		BLM1045-1R
CBR 900 RR2-RR3	02-03		BLMR1073-2F	BLM1073-1R
CBR 900 RRN-RRS Retaining Bundy	92-95	BLM1074-3F		
CBR 900 RRN-S Fireblade	92-95	BLM1075-3F	BLMR1075-2F	BLM1075-1R
CBR 900 RRT-RRX Retaining Bundy	96-99	BLM1076-3F	BLMR1076-2F	BLM1076-1R
CBR 900 RRT-X Fireblade	96-99	BLM1077-3F	BLMR1076-2F	BLM1076-1R
CBR 900 RRY-RR1	00-01		BLMR1073-2F	BLM1078-1R
CB 1000 P-T Big One	93-96	BLM1001-3F	BLMR1001-2F	BLM1001-1R
CB 1000 R	08-14		BLMR1002-2F	BLM1002-1R
CBF 1000	06	BLM1046-3F		BLM1046-1R
CBR 1000 FH-FJ	87-88	BLM1050-3F		BLM1050-1R

FRONT / AVANT / VORN / FRENTE / ANTERIORE

REAR / ARRIÈRE / HINTEN / POSTERIOR / POSTERIORE

BRAKE
LINES

BRAKE LINES



HONDA



OE Replacement
Brake Lines (Front)

Race Standard
Brake Lines (Front)

OE Replacement
Brake Lines (Rear)

CBR 1000 FK-FN	89-92	BLM1051-3F		BLM1051-1R
CBR 1000 FP-FR	93-99	BLM1052-10FR		Supplied as front & rear kit complete
CBR 1000 RR	04-05	BLM1054-2F	BLMR1053-2F	BLM1054-1R
CBR 1000 RR	06-08		BLMR1054-2F	BLM1053-1R
CBR 1000 RR (Non ABS)	09-14		BLMR1055-2F	BLM1055-1R
CBR 1000 RR ABS	09-17	BLM1165-4F		BLM1165-2R
CBX 1000 A	80	BLM1079-3F		BLM1079-1R
CBX 1000 B Pro Link	81	BLM1080-3F		BLM1080-1R
CBX 1000 Z	79	BLM1081-3F		BLM1081-1R
GL 1000 KZ-K1	79-80	BLM1096-3F		BLM1096-1R
VF 1000 FE-FF	84-85	BLM1128-3F		BLM1128-1R
VF 1000 RE-RG	84-86	BLM1129-3F		BLM1129-1R
VTR 1000 SP1-SP2	99-08		BLMR1149-2F	BLM1149-1R
VTR 1000 FV-F4	97-05	BLM1150-3F	BLMR1150-2F	BLM1150-1R
XL 1000 VW-V3 Varedero	98-06	BLM1152-10FR		Supplied as front & rear kit complete
CB 1100 RC-RD	82-83	BLM1003-3F		BLM1003-1R
CB 1100 SF-X11	99-02	BLM1004-10FR		Supplied as front & rear kit complete
CBR 1100 XX Blackbird	96-08	BLM1056-10FR		Supplied as front & rear kit complete
GL 1100 A-B Goldwing	80-81	BLM1097-3F		BLM1097-1R
GL 1100 AD Aspencade	83	BLM1098-2F		BLM1098-1R
GL 1100 DC Deluxe	82	BLM1099-3F		BLM1099-1R
ST 1100 ABS/TCS/CBS	02-03	BLM1124-16FR		Supplied as front & rear kit complete
ST 1100 AN-AS Pan European ABS	92-95	BLM1125-7FR		Supplied as front & rear kit complete
ST 1100 L-2 Pan European Non ABS	90-02	BLM1126-3F		BLM1126-2R
GL 1200 AE-AH Aspencade	84-87	BLM1100-3F		BLM1100-1R
CB 1300 (SL38)	97-03	BLM1007-3F		BLM1007-1R
CB 1300 UK Model	02-03	BLM1008-3F	BLMR1008-2F	BLM1008-1R
CB 1300 SA ABS	05-06	BLM1009-4F		BLM1009-3R
F6C (GL 1500 CV-CW) Valkyrie	96-03	BLM1094-3F		BLM1094-1R
V65 Magna		BLM1127-3F		
GL 1500 J-SEY Goldwing	88-00	BLM1101-4FR		Supplied as front & rear kit complete

HONDA OFF-ROAD

CR 85 R	03-08	BLM6002-1F		BLM6002-1R
CR 85 R Expert	03-08	BLM6002-1F		BLM6003-1R
CR 125 R/250 R	97-07	BLM6000-1F		BLM6000-1R
CRF 230 L	08-	BLM6004-1F		
CRF 250 F/450 F	03-04	BLM6005-1F		BLM6005-1R
CRF 250 L	13-17	BLM6012-1F		BLM6012-1R
CRF 250 R/CRF 450 R	04-08	BLM6006-1F		BLM6006-1R
CRF 250 R/CRF 450 R	09-17	BLM6007-1F		BLM6007-1R
CRF 250 X/CRF 450 X	05-17	BLM6008-1F		BLM6008-1R
XR 400 R	96-04	BLM6009-1F		BLM6009-1R
CR 500	97-04	BLM6000-1F		BLM6000-1R
XR 650 L	04-	BLM6010-1F		BLM6010-1R
XR 650 R	00-03	BLM6011-1F		BLM6011-1R
XR 650 R	04-	BLM6010-1F		BLM6010-1R

KAWASAKI

KDX 125 A1-B2	90-94	BLM4032-1F		BLM4032-1R
KMX 125 A1-A5/B1-B12/KMX 200 A2-A3	86-02	BLM4050-1F		BLM4050-1R
Z 125 Pro	17	BLM4190-1F		BLM4190-1R
KDX 200/220	95-99	BLM4033-1F		BLM4033-1R
KDX 200 E1	90-94	BLM4032-1F		BLM4032-1R
GPX 250 R F2-F9	88-96	BLM4011-1F		BLM4011-1R
KLR 250 D2-D16	84-01	BLM4045-1F		
Z 250 A1-A3	79-82	BLM4091-1F		BLM4091-1R
ZZR 250 H1-H2	90-92	BLM4178-1F		BLM4178-1R
KR1-KR1S	89-92	BLM4051-3F	BLMR4051-2F	BLM4051-1R
KLX 300 R	97-99	BLM4048-1F		BLM4048-1R
EX300 Ninja	13-15	BLM4182-1F		BLM4182-1R
KH 400	77-80	BLM4041-2F		
ZR 400 A1-B1 (Z400F)	83-85	BLM4134-3F		

FRONT / AVANT / VORN / FRENTE / ANTERIORE

REAR / ARRIÈRE / HINTEN / POSTERIOR / POSTERIORE

BRAKE
LINES

BRAKE LINES



KAWASAKI



		OE Replacement Brake Lines (Front)	Race Standard Brake Lines (Front)	OE Replacement Brake Lines (Rear)
ZXR 400 L1-L9	91-03	BLM4169-3F	BLMR4169-2F	BLM4169-1R
GPZ 500 S A1-A6	87-93	BLM4018-1F		
GPZ 500 S D1-E8	94-01	BLM4019-1F		BLM4019-1R
GPZ 500 S E9-E10	02-04	BLM4020-2F	BLMR4020-2F	BLM4019-1R
KH 500	76 -	BLM4042-2F		
KLE 500 A1-A7	91-99	BLM4043-1F		BLM4043-1R
KLE 500 B	05-06	BLM4044-1F		BLM4044-1R
Vulcan 500	96-97	BLM4066-1F		
Z 500	80-83	BLM4099-3F		
GT 550 G1-G9	83-01	BLM4026-3F		
Z 550 A1	1980	BLM4100-3F		
Z 550 D1 (GPZ)	81	BLM4101-3F		BLM4101-1R
Z 550 H1-H2 (Gpz Unitrak)	82-83	BLM4102-3F		BLM4102-1R
Z 550 LTD C1-C2	80-83	BLM4103-3F		
ZR 550 A1-A2 (Z550F)	82-87	BLM4135-3F		
ZR 550 B2-B6 Zephyr	91-98	BLM4136-3F		BLM4136-1R
ZX 550 A1-A4 (GPZ550)	83-91	BLM4150-5F		BLM4150-1R
ER6 F/N	13-14	BLM4008-2F		BLM4008-1R
ER6 F/N	06-09	BLM4009-2F	BLMR4009-2F	BLM4009-1R
ER6 F/N	10-12	BLM4010-2F	BLMR4010-2F	BLM4010-1R
GPX 600 R C1-C7	88-96	BLM4012-3F	BLMR4012-2F	BLM4012-1R
GPZ 600 R A1-A5	85-90	BLM4021-5F		BLM4021-1R
KLR 600 A1/B1-B4	84-90	BLM4046-1F		
ZL 600 B1 Eliminator	95-97	BLM4129-1F		
ZZR 600 D1-D3	90-93	BLM4179-3F	BLMR4179-2F	BLM4179-1R
ZZR 600 D4-E12H	94-06	BLM4180-3F	BLMR4179-2F	BLM4180-1R
ZX6R	07-08	BLM4151-2F	BLMR4151-2F	BLM4151-1R
ZX6R	09-12	BLM4152-3F	BLMR4152-2F	BLM4152-1R
ZX6R	13-14	BLM4153-2F	BLMR4153-2F	BLM4153-1R
ZX6R B1/ZX6RR K1	03	BLM4154-2F	BLMR4154-2F	BLM4154-1R
ZX6R F1-F3	95-97	BLM4155-3F	BLMR4155-2F	BLM4155-1R
ZX6R G1-G2	98-99	BLM4156-3F	BLMR4156-2F	BLM4156-1R
ZX6R J1-J2/A1P (636)	00-02	BLM4157-3F	BLMR4157-2F	BLM4157-1R
ZX6RR 04	04	BLM4158-2F	BLMR4158-2F	BLM4158-1R
ZX6RR ZX636	05-06	BLM4159-2F	BLMR4159-2F	BLM4159-1R
KLR 650 A1-A3/C1-C8	87-02	BLM4047-1F		BLM4047-1R
KLX 650 C1-C2	93-96	BLM4049-1F		BLM4049-1R
Versys 650 ABS	06-10	BLM4052-5FR		Supplied as front & rear kit complete
Versys 650 ABS	11-13	BLM4053-7FR		Supplied as front & rear kit complete
Versys 650 Non ABS	06-10	BLM4054-2F		BLM4054-1R
Versys 650 Non ABS	11	BLM4055-2F		BLM4055-1R
W 650	03-04	BLM4067-1F		
Z 650 B1 Full Front	77	BLM4104-2F		
Z 650 B1 Twin Disc Front	78	BLM4105-3F		
Z 650 B2-B3	78-79	BLM4106-2F		
Z 650 C2-C3	78-80	BLM4107-3F		BLM4107-1R
Z 650 D1(SR)	78	BLM4108-3F		
Z 650 D2-D3 (SR)	79-80	BLM4109-3F		
Z 650 F1	80	BLM4110-3F		
Z 650 F2-F4	81-83	BLM4111-3F		
ZX7R P1-P7/ZX7RR N1	96-03	BLM4160-3F	BLMR4160-2F	BLM4160-1R
GPX 750 R F1-F3	87-91	BLM4013-3F	BLMR4013-2F	BLM4013-1R
GPZ 750 A1-A5/R1 (ZX 750 A/ZX 750 G)	83-89	BLM4022-5F		BLM4022-1R
GPZ 750 E1-E2 Turbo	83-87	BLM4023-5F		BLM4023-1R
GT 750 P1-P9	82-96	BLM4027-3F		BLM4027-1R
VN 750 A Front	86-94	BLM4064-3F		
Z 750	03-05	BLM4112-2F	BLMR4112-2F	BLM4112-1R
Z 750	06-07	BLM4113-2F	BLMR4113-2F	BLM4113-1R
Z 750	08-11	BLM4070-2F	BLMR4070-2F	BLM4070-1R
Z 750 B Full Front	76-79		BLMR4115-2F	BLM4115-1R
Z 750 L2-L4 82-84 Front	82-84	BLM4116-3F		
Z 750 L4 1984 Rear	84			BLM4117-1R
Z 750 Ltd H1-H2	80-83	BLM4118-3F		

FRONT / AVANT / VORN / FRENTE / ANTERIORE

REAR / ARRIÈRE / HINTEN / POSTERIOR / POSTERIORE

BRAKE LINES

BRAKE LINES



KAWASAKI



		OE Replacement Brake Lines (Front)	Race Standard Brake Lines (Front)	OE Replacement Brake Lines (Rear)
Z 750 R	11	BLM4119-2F		BLM4119-1R
Z 750 R1 (GP)	82	BLM4120-3F		BLM4120-1R
Z 750 Y1 Twin Ltd	82	BLM4121-3F		
ZR-7	06	BLM4130-2F		BLM4130-1R
ZR-7 F1-F5/ZR-7S H3	99-03	BLM4131-3F	BLMR4131-2F	BLM4131-1R
ZR 750 C1-C4/D1 Zephyr	91-99	BLM4137-3F	BLMR4137-2F	BLM4137-1R
ZXR 750 H1-H2	89-90	BLM4170-3F	BLMR4170-2F	BLM4170-1R
ZXR 750 J1-J2	91-92	BLM4171-3F	BLMR4171-2F	BLM4171-1R
ZXR 750 K1-L1	91-96	BLM4172-3F	BLMR4172-2F	BLM4172-1R
ZXR 750 M1-M2	92-94	BLM4173-3F	BLMR4173-2F	BLM4173-1R
VN 800 A1-A3/B2-B8 Classic/E1-E2 Drifter	95-03	BLM4065-1F		
W 800 Inc Special Edition	11-13	BLM4068-1F		
Z 800 Non ABS	13	BLM4122-2F	BLMR4122-2F	BLM4122-1R
Z 800 E 2013 2 Pot	13	BLM4123-2F		
GPZ 900 R A1-A6	84-89	BLM4024-5F		BLM4024-1R
GPZ 900 R A7-A8	90-96	BLM4025-3F	BLMR4025-2F	BLM4025-1R
VN 900/VN 900 Custom	06-13	BLM4031-1F		BLM4031-1R
Z 900	-77	BLM4124-3F		
Z 900	78-	BLM4125-3F		
Z 900 Single Disc (Hard Line On Caliper)	74	BLM4126-2F		
ZX9R B1-B2	94-95	BLM4161-3F	BLMR4161-2F	BLM4161-1R
ZX9R B3-B4	96-97	BLM4162-3F	BLMR4161-2F	BLM4161-1R
ZX9R C1-C2	98-99	BLM4163-3F	BLMR4163-2F	BLM4163-1R
ZX9R E1-E2	00-01	BLM4164-3F	BLMR4164-2F	BLM4164-1R
ZX9R F1P-F2P	02-04	BLM4165-3F	BLMR4165-2F	BLM4165-1R
Z1/Z1A/Z1B	73-75	BLM4069-3F		BLM4069-1R
GPZ 1000 RX A1-A3	85-89	BLM4014-5F		BLM4014-1R
GTR 1000 A1	86	BLM4028-3F		BLM4028-1R
GTR 1000 A2-A4	87-89	BLM4029-3F		BLM4029-1R
GTR 1000 A5-A14	90-99	BLM4030-3F		BLM4030-1R
KLZ 1000 Versys	12-14	BLM4191-4F		BLM4191-1R
KLZ 1000 Versys	15-17	BLM4192-4F		BLM4191-1R
Z 1000	07-09	BLM4070-2F	BLMR4070-2F	BLM4070-1R
Z 1000	10-13		BLMR4071-2F	BLM4071-1R
Z 1000	15-	BLM4072-2F		BLM4072-1R
Z 1000 A1	77	BLM4073-3F	BLMR4073-2F	BLM4073-1R
Z 1000 A2	78	BLM4074-3F		BLM4074-1R
Z 1000 J1	81	BLM4075-3F		BLM4075-1R
Z 1000 J2	82	BLM4076-3F		BLM4076-1R
Z 1000 J3	83	BLM4077-3F		BLM4077-1R
Z 1000 K1 LTD	81-83	BLM4078-3F		BLM4078-1R
Z 1000 MK2	78-81	BLM4079-3F		BLM4079-1R
Z 1000 Z 1R	78-81	BLM4080-3F		BLM4080-1R
Z 1000 H	80-81	BLM4081-3F		BLM4081-1R
Z 1000 R2	83	BLM4082-3F		BLM4082-1R
Z 1000 ST (E1)	79	BLM4083-3F		BLM4083-1R
Z 1000 ST (E2)	80	BLM4084-3F		BLM4084-1R
Z 1000 SX	11-13		BLMR4085-2F	BLM4085-1R
Z 1000 SX	14-17	BLM4189-4F		BLM4189-1R
ZL 1000	87-90	BLM4128-3F		BLM4128-1R
ZR 1000 A1-A2	03-06	BLM4132-2F	BLMR4132-2F	BLM4132-1R
ZX10 B1-B3	88-91	BLM4141-3F	BLMR4141-2F	BLM4141-1R
ZX10R	04-05	BLM4142-2F	BLMR4142-2F	BLM4142-1R
ZX10R	06	BLM4143-2F	BLMR4143-2F	BLM4143-1R
ZX10R	07	BLM4144-2F	BLMR4144-2F	BLM4144-1R
ZX10R	08-10		BLMR4145-2F	BLM4145-1R
ZX10R (Non ABS)	11-14	BLM4146-3F	BLMR4146-2F	BLM4146-1R
GPZ 1100 A1-A3 (ZX 1100 A)	83-85	BLM4015-5F		BLM4015-1R
GPZ 1100 S E1-E2	95-99	BLM4016-3F		BLM4016-1R
Z 1100 A1-A3	81-84	BLM4086-3F		BLM4086-1R
Z 1100 A1-A3(GPZ)	81-83	BLM4087-3F		BLM4087-1R
Z 1100 B1-B2(GPZ)	81-82	BLM4088-3F		BLM4088-1R
Z 1100 R	84-86	BLM4089-3F		BLM4089-1R

FRONT / AVANT / VORN / FRENTE / ANTERIORE

REAR / ARRIÈRE / HINTEN / POSTERIOR / POSTERIORE

BRAKE
LINES

BRAKE LINES



KAWASAKI



OE Replacement
Brake Lines (Front)

Race Standard
Brake Lines (Front)

OE Replacement
Brake Lines (Rear)

ZR 1100 A1-A4/B1 Zephyr	92-97	BLM4133-3F	BLMR4133-2F	BLM4133-1R
ZRX 1100 C1-C2	97-01	BLM4138-3F	BLMR4138-2F	BLM4138-1R
ZZR 1100 C1-C3	90-92	BLM4174-3F	BLMR4174-2F	BLM4174-1R
ZZR 1100 D1-D9	92-01	BLM4175-3F	BLMR4175-2F	BLM4175-1R
ZRX 1200 A1-A3P/ZRX 1200S B1-B3P	01-04	BLM4139-3F	BLMR4139-2F	BLM4139-1R
ZRX 1200 R	06	BLM4140-3F		BLM4140-1R
ZX12R A1-B2	99-03	BLM4147-3F	BLMR4147-2F	BLM4147-1R
ZX12R B3-B4	04-05		BLMR4148-2F	BLM4147-1R
ZX12R B6	05-07	BLM4149-3F	BLMR4149-2F	BLM4147-1R
ZZR 1200	02-04	BLM4176-3F		BLM4176-1R
Z 1300 A1-A5	79-84	BLM4090-3F		BLM4090-1R
ZG 1300 A1-A3	87-90	BLM4127-3F		BLM4127-1R
ZZR 1400 (Non ABS)	06-10	BLM4177-3F	BLMR4177-2F	BLM4177-1R
VN 1500 B2-B6 Vulcan/C1-C2 Classic	88-96	BLM4056-1F		BLM4056-1R
VN 1500 D1-D2/E1 Classic/J1-J2 Drifter	96-99	BLM4057-1F		BLM4057-1R
VN 1500 E2 Classic Tourer/Nomad	01-04	BLM4058-3F		BLM4058-1R
VN 1500 E2 Classic/G1-G2 Nomad	98-99	BLM4059-2F		BLM4059-1R
VN 1600 A3H Classic	03-06		BLMR4060-2F	BLM4060-1R
VN 1600 B2H Meanstreak	03-06	BLM4061-3F		BLM4061-1R
VN 1700 Classic	09		BLMR4062-2F	
VN 2000	03-09	BLM4063-3F	BLMR4063-2F	BLM4063-1R

KAWASAKI OFF ROAD

KX 85	00-11	BLM6017-1F		BLM6017-1R
KX 100	97-11	BLM6017-1F		BLM6017-1R
KX 125/250	03-05	BLM6018-1F		BLM6017-1R
KDX 200 R/220 R	05-06	BLM6014-1F		BLM6014-1R
KX 250	06-07	BLM6019-1F		BLM6019-1R
KX 250 F	04-05	BLM6018-1F		BLM6017-1R
KX 250 F	06	BLM6021-1F		BLM6021-1R
KX 250 F	07-08	BLM6022-1F		BLM6022-1R
KX 250 F	09	BLM6023-1F		BLM6023-1R
KX 250 F	11	BLM6024-1F		BLM6024-1R
KLX 300 R	05-08	BLM6015-1F		BLM6015-1R
KLX 450 R	08-09	BLM6016-1F		BLM6016-1R
KX 450 F	06-08	BLM6021-1F		BLM6021-1R
KX 450 F	09-11	BLM6023-1F		BLM6023-1R
KX 500	95-04	BLM6018-1F		BLM6017-1R

KTM OFF ROAD

125/200/250 EXC	00-03	BLM6032-1F		BLM6032-1R
125/200/250 SX	04-05	BLM6033-1F		
125/200 EXC	98-99			BLM6032-1R
125/200 SX/MXC	00-03	BLM6035-1F		BLM6032-1R
125/200 SX/MXC	95-99	BLM6036-1F		BLM6032-1R
125 EXC/SX/SXS	04-09	BLM6038-1F		BLM6038-1R
200 EXC/XC/XCW MXC	00-09	BLM6038-1F		
250 MXC/SXC	00-01	BLM6038-1F		
250 EXC/SX	03-09			BLM6038-1R
250 EXC/XC/XCF	02-09	BLM6038-1F		
250 SX/MXC	00-02	BLM6035-1F		BLM6032-1R
250 SX/MXC	94-99	BLM6036-1F		BLM6032-1R
360/380 EXC	00-03	BLM6032-1F		BLM6032-1R
300/360/380 SX/MXC	00-02	BLM6035-1F		BLM6032-1R
360/380 SX/MXC	94-99	BLM6036-1F		BLM6032-1R
300 EXC/MXC	04-09			BLM6038-1R
300 EXC/XC/MXC	06-09	BLM6038-1F		
380 EXC/MXC/SX	00-02	BLM6038-1F		
400/520 SX/MXC	00-02	BLM6035-1F		
400/540/620 SC/EXC	98-99	BLM6036-1F		
400/540/620 SX	96-99	BLM6032-1F		
400 EXC/MXC	00-09	BLM6038-1F		
450/525 SX	04-05	BLM6033-1F		

FRONT / AVANT / VORN / FRENTE / ANTERIORE

REAR / ARRIÈRE / HINTEN / POSTERIOR / POSTERIORE

BRAKE
LINES

BRAKE LINES



KTM OFF ROAD



		OE Replacement Brake Lines (Front)	Race Standard Brake Lines (Front)	OE Replacement Brake Lines (Rear)
450 EXC/MXC/SXS/XC	03-09	BLM6038-1F		
505 XC	08-09	BLM6038-1F		
520 SC/EXC	00-02	BLM6032-1F		
520 EXC/SX/MXC	00-02	BLM6038-1F		
525 EXC/MXC/SX/XC	03-07	BLM6038-1F		
525 MXC	03	BLM6036-1F		BLM6032-1R
525 SX/450SX	03	BLM6036-1F		BLM6032-1R
530 EXC/XCR/XCW	08-09	BLM6038-1F		
625 SC/SXC	02-07	BLM6038-1F		
660 Rallye	00-03	BLM6038-1F		

LAVERDA

Jota 120/180	78-82	BLM8161-3F	BLMR8161-2F	BLM8161-1R
Montjuic 500	79-83	BLM8163-3F		
750 Formula 750		BLM8159-2F		BLM8159-1R
750 Formula/750 SS	97-02	BLM8160-2F		BLM8160-1R
Mirage 1200	78-79	BLM8162-3F		BLM8162-1R

MOTO GUZZI

V50 Monza MK1	80-81	BLM8184-3FR		Supplied as front & rear kit complete
V50 Monza MK2	82-83	BLM8185-3FR		Supplied as front & rear kit complete
V50 Monza MK3	84-86	BLM8186-4FR		Supplied as front & rear kit complete
V65 Lario	85-88	BLM8187-4FR		Supplied as front & rear kit complete
V65/V65 SP/V65 ST	84-91	BLM8188-4FR		Supplied as front & rear kit complete
V65 TT	85-88	BLM8189-3FR		Supplied as front & rear kit complete
750 Targa	90-94	BLM8176-3FR		Supplied as front & rear kit complete
850 Le Mans MK1	78-79	BLM8179-4FR		Supplied as front & rear kit complete
850 Le Mans MK2-MK3	79-85	BLM8180-4FR		Supplied as front & rear kit complete
850 T3	- 80	BLM8181-5FR		Supplied as front & rear kit complete
850 T3 California	77-82	BLM8182-5FR		Supplied as front & rear kit complete
850 T5	83-88	BLM8183-4FR		Supplied as front & rear kit complete
1000 California MK2	82-87	BLM8165-5FR		Supplied as front & rear kit complete
1000 Le Mans MK4	85-88	BLM8166-4FR		Supplied as front & rear kit complete
1000 Le Mans MK5	88-94	BLM8167-4FR		Supplied as front & rear kit complete
1000 Mille Gt	88-91	BLM8168-4FR		Supplied as front & rear kit complete
1000 Spada MK1-MK2	80-88	BLM8169-4FR		Supplied as front & rear kit complete
1000 Spada MK3	89-95	BLM8170-4FR		Supplied as front & rear kit complete
1000 T3 California		BLM8171-5FR		Supplied as front & rear kit complete
1100 California EV	97-02	BLM8172-2F		
1100 California Jackal	99-01	BLM8173-3FR		Supplied as front & rear kit complete
1100 California MK3	94-97	BLM8174-3FR		Supplied as front & rear kit complete
1100 Sport Carb	96-99	BLM8175-3F		BLM8175-1R

MV AGUSTA

F3 675 Agusta	13	BLM8192-2F		BLM8192-1R
Brutale S 750	04	BLM8191-3F		BLM8191-1R
F4 750	00-04	BLM8194-3F	BLMR8194-2F	
850 Monza	77	BLM8190-3F		BLM8190-1R
F4 1000 S	04	BLM8193-3F		BLM8193-1R

SUZUKI

DDR 125 SF-SJ	85-94	BLM3004-1F		
GP 125 X-D	82-89	BLM3015-1F		
RG 125 FUN-FUR	91-95	BLM3132-1F		BLM3132-1R
TS 125 RK-RR	90-96	BLM3150-1F		BLM3150-1R
GS 250 TT-TX	80-81	BLM3021-1F		
GSX 250 ET-EX	80-81	BLM3063-1F		
GSX 250 EZ Katana	82	BLM3064-2F		
RG 250 FG-FH	85-89	BLM3134-3F		BLM3134-1R
RG 250 WD	83	BLM3135-3F		BLM3135-1R
RG 250 WE	84	BLM3136-5F		BLM3136-1R
RGV 250 K-L	89-90	BLM3138-3F	BLMR3138-2F	BLM3138-1R
RGV 250 M-N	91-92	BLM3139-3F	BLMR3139-2F	BLM3139-1R

FRONT / AVANT / VORN / FRENTE / ANTERIORE

REAR / ARRIÈRE / HINTEN / POSTERIOR / POSTERIORE

BRAKE
LINES

BRAKE LINES



SUZUKI



		OE Replacement Brake Lines (Front)	Race Standard Brake Lines (Front)	OE Replacement Brake Lines (Rear)
RGV 250 P-R	93-97	BLM3140-3F	BLMR3140-2F	BLM3140-1R
DR 350 SES-SEX	95-99	BLM3005-1F		BLM3005-1R
DR 350 SL-SR	90-94	BLM3006-1F		BLM3006-1R
GT 380 M	75	BLM3125-1F		
GS 400/425 (Single Disc)	77-80	BLM3022-2F		
GSF 400 M-R Bandit	91-95	BLM3041-2F		BLM3041-1R
GSX 400 EZ	82	BLM3065-2F		
GSX 400 FX Non Anti-Dive	81	BLM3066-3F		BLM3066-1R
GSX 400 FZ-FD Anti-Dive	82-86	BLM3067-4F		BLM3066-1R
GSZ 400 FZ-FD Twin Anti-Dive	82-86	BLM3068-5F		BLM3066-1R
GSXR 400 RRR-RRN	89-92	BLM3096-3F	BLMR3096-2F	BLM3096-1R
GS 450 EG-EJ	85-89	BLM3023-2F		
GS 500 EK-ER	89-94	BLM3024-1F		BLM3024-1R
GS 500 ES-K4	95-05	BLM3025-1F		BLM3025-1R
GS 500 F	03-09	BLM3026-1F		BLM3026-1R
RG 500 G-CH	85-89	BLM3137-3F	BLMR3137-2F	BLM3137-1R
GS 550 EN	79	BLM3027-3F		BLM3027-1R
GS 550 ET-EX	80-81	BLM3028-3F		BLM3028-1R
GS 550 LT-LX	80-82	BLM3029-3F		BLM3029-1R
GS 550 MX Katana	81	BLM3030-3F		BLM3030-1R
GSX 550 EE/ESF/EFF/EG/ESG	85-88	BLM3069-3F		BLM3069-1R
GSX 550 ESD/EE/ESE/EFE	83-84	BLM3070-5F		BLM3070-1R
GT 550 A	76	BLM3127-1F		
DR 600 SF-RG	84-87	BLM3007-1F		
GSF 600 S Bandit	95	BLM3042-3F	BLMR3042-2F	BLM3042-1R
GSF 600 T-X Bandit	96-99	BLM3043-3F	BLMR3043-2F	BLM3042-1R
GSF 600 Y-K4 Bandit	00-05	BLM3044-3F	BLMR3044-2F	BLM3044-1R
GSR 600	06-10	BLM3049-2F	BLMR3049-2F	BLM3049-1R
GSR 600 ABS	06-11	BLM3050-5FR		Supplied as front & rear kit complete
GSX 600 FJ-FV	88-97	BLM3071-3F	BLMR3071-2F	BLM3071-1R
GSX 600 FW-K3	98-03	BLM3072-3F	BLMR3072-2F	BLM3072-1R
GSXR 600	04-05	BLM3097-2F	BLMR3097-2F	BLM3097-1R
GSXR 600	06-10	BLM3098-2F	BLMR3098-2F	BLM3098-1R
GSXR 600	11-14	BLM3099-2F	BLMR3099-2F	BLM3099-1R
GSXR 600 K1-K3	01-03	BLM3100-2F	BLMR3100-2F	BLM3100-1R
GSXR 600 V-W	97-98	BLM3101-2F	BLMR3101-2F	BLM3101-1R
GSXR 600 X-Y	99-00	BLM3102-2F	BLMR3101-2F	BLM3102-1R
RF 600 RP-RV	93-97	BLM3130-3F	BLMR3130-2F	BLM3130-1R
VS 600 GLS-GLT Intruder	95-97	BLM3155-1F		
DL 650 ABS	13	BLM3003-5FR		Supplied as front & rear kit complete
DR 650 RSEM-SET	91-97	BLM3008-1F		BLM3008-1R
GX 650 GTX-GTD	81-85	BLM3031-3F		BLM3031-1R
GS 650 GX Katana	81	BLM3032-3F		BLM3032-1R
GSF 650 Bandit Non ABS	08	BLM3045-2F		
GSF 650 Bandit Non ABS	05-07	BLM3046-2F	BLMR3046-2F	BLM3046-1R
GSF 650 A Bandit ABS	05-13	BLM3047-7FR		Supplied as front & rear kit complete
GSF 650 S Bandit K5 - K8 Non ABS	05-13	BLM3048-2F	BLMR3048-2F	BLM3048-1R
GSX 650 F Non ABS	07-13	BLM3073-2F	BLMR3073-2F	BLM3073-1R
LS 650 FG/PJ-PT Savage	87-98	BLM3129-1F		
SV 650 Unfaired	03-13	BLM3143-3F	BLMR3143-2F	BLM3143-1R
SV 650 S Faired	03-13	BLM3144-3F	BLMR3144-2F	BLM3143-1R
SV 650 SX-SK2	99-02	BLM3145-3F	BLMR3145-2F	BLM3145-1R
SV 650 X-K1	99-02	BLM3146-3F	BLMR3146-2F	BLM3145-1R
SVF 650 Gladius Non ABS	09-13	BLM3147-2F	BLMR3147-2F	BLM3147-1R
V-Strom 650	04-12	BLM3153-3F	BLMR3153-2F	BLM3153-1R
DR 750 SJ-SL	88-90	BLM3009-1F		BLM3009-1R
GS 750 DB	77	BLM3033-3F		BLM3033-1R
GS 750 EN	79	BLM3034-3F		BLM3034-1R
GSR 750	11-13	BLM3051-2F		
GSX 750 EE/EF/ES	84-89	BLM3074-5F		BLM3074-1R
GSX 750 ESD	83	BLM3075-5F		BLM3075-1R
GSX 750 ET-EX	80-81	BLM3076-3F		BLM3076-1R
GSX 750 FK-FV	89-97	BLM3077-3F	BLMR3077-2F	BLM3077-1R

FRONT / AVANT / VORN / FRENTE / ANTERIORE

REAR / ARRIÈRE / HINTEN / POSTERIOR / POSTERIORE

**BRAKE
LINES**

BRAKE LINES



SUZUKI



			OE Replacement Brake Lines (Front)	Race Standard Brake Lines (Front)		OE Replacement Brake Lines (Rear)
GSX 750 FW-K3	98-03		BLM3078-3F	BLMR3078-2F		BLM3078-1R
GSX 750 R	85		BLM3079-3F			BLM3079-1R
GSX 750 SE Katana	83-86		BLM3080-3F			BLM3080-1R
GSX 750 W-K1	97-02		BLM3081-3F	BLMR3081-2F		BLM3081-1R
GSXR 750	11-14		BLM3099-2F	BLMR3099-2F		BLM3099-1R
GSXR 750	06-10		BLM3098-2F	BLMR3098-2F		BLM3098-1R
GSXR 750 F-H	85-87		BLM3105-3F	BLMR3105-2F		BLM3105-1R
GSXR 750 J	88		BLM3106-3F	BLMR3106-2F		BLM3106-1R
GSXR 750 K	89		BLM3091-3F	BLMR3091-2F		BLM3091-1R
GSXR 750 K4/K5	04-05		BLM3097-2F	BLMR3097-2F		BLM3097-1R
GSXR 750 L	90		BLM3109-3F	BLMR3109-2F		BLM3109-1R
GSXR 750 M	91		BLM3110-3F	BLMR3110-2F		BLM3110-1R
GSXR 750 T-W	96-98		BLM3101-2F	BLMR3101-2F		BLM3101-1R
GSXR 750 WN-WP	92-93		BLM3112-3F	BLMR3112-2F		BLM3112-1R
GSXR 750 WR-WS	94-95		BLM3113-2F	BLMR3113-2F		BLM3113-1R
GSXR 750 X	99		BLM3102-2F	BLMR3101-2F		BLM3102-1R
GSXR 750 Y-K3	00-03		BLM3115-2F	BLMR3115-2F		BLM3115-1R
GSX-S 750	17		BLM3166-3F			BLM3166-2R
GSX-S 750 Z	17		BLM3166-3F			BLM3166-2R
VS 750 GLPG-GLPM Intruder	85-91		BLM3155-1F			
DR 800 SL-SM	90-91		BLM3010-1F			BLM3010-1R
VS 800 GLM-GLV Intruder	91-97		BLM3155-1F			
VX 800 L-R	90-95		BLM3158-1F			BLM3158-1R
VZ 800 V-W Marauder	97-98		BLM3159-1F			
GS 850 GN-GT	79-80		BLM3035-3F			BLM3035-1R
GS 850 GX-GG	81-88		BLM3036-3F			BLM3036-1R
XN 85 D Turbo	83		BLM3161-5F			BLM3161-1R
RF 900 RR-RW	94-98		BLM3131-3F	BLMR3131-2F		BLM3131-1R
DL 1000 V-Strom ABS	2014-		BLM3001-3F			BLM3001-2R
DL 1000 K2 V-Strom	02-06		BLM3002-3F	BLMR3002-2F		BLM3002-1R
DL1000 V Strom	17-		BLM3172-3F			BLM3172-2R
DL1000 V Strom XT	17-		BLM3173-3F			BLM3173-2R
GS 1000 Katana Anti-Dive			BLM3016-5F			BLM3016-1R
GS 1000 ET/GT	80-84		BLM3017-3F			BLM3017-1R
GS 1000 S	79		BLM3018-3F			BLM3018-1R
GSX 1000 SZ-SD Katana	81-84		BLM3052-5F			BLM3052-1R
GSXR 1000	12-14		BLM3082-2F	BLMR3082-2F		BLM3082-1R
GSXR 1000 ABS	15		BLM3083-3F			BLM3082-1R
GSXR 1000 K5/K6	05-06		BLM3084-2F	BLMR3084-2F		BLM3084-1R
GSXR 1000 K7 - K8	07-08		BLM3085-2F	BLMR3085-2F		BLM3085-1R
GSXR 1000 K9 - K11	09-11		BLM3086-2F	BLMR3086-2F		BLM3086-1R
GSXR 1000 ABS	17		BLM3167-3F			BLM3167-2R
GSXR 1000 K1-K2	01-02		BLM3087-2F	BLMR3087-2F		BLM3087-1R
GSXR 1000 K3-K4	03-04		BLM3088-2F	BLMR3088-2F		BLM3088-1R
SV 1000 N	03-06		BLM3141-2F	BLMR3141-2F		BLM3141-1R
SV 1000 SK3-K7	03-07		BLM3142-2F	BLMR3142-2F		BLM3142-1R
TL 1000 RW-RK1	98-02		BLM3148-2F	BLMR3148-2F		BLM3148-1R
TL 1000 SV-SX	97-01		BLM3149-2F	BLMR3149-2F		BLM3149-1R
GS 1100 G	82-84		BLM3019-3F			BLM3019-1R
GSX 1100 EE/EF/EG	84-88		BLM3053-3F			BLM3053-1R
GSX 1100 ESD	83		BLM3054-5F			BLM3054-1R
GSX 1100 ET-EX	80-81		BLM3055-3F			BLM3055-1R
GSX 1100 EZ/SZ Katana	82		BLM3056-5F			BLM3056-1R
GSX 1100 FJ-FR	88-94		BLM3057-3F			BLM3057-1R
GSX 1100 GM-GN	91-94		BLM3058-3F			BLM3058-1R
GSX 1100 SD Katana	83		BLM3059-5F			BLM3059-1R
GSXR 1100 G-H	86-87		BLM3089-3F	BLMR3089-2F		BLM3089-1R
GSXR 1100 J	88		BLM3090-3F	BLMR3090-2F		BLM3090-1R
GSXR 1100 K	89		BLM3091-3F	BLMR3091-2F		BLM3091-1R
GSXR 1100 L	90		BLM3092-3F	BLMR3092-2F		BLM3092-1R
GSXR 1100 M	91		BLM3093-3F	BLMR3093-2F		BLM3093-1R
GSXR 1100 N	92		BLM3094-3F	BLMR3094-2F		BLM3094-1R
GSXR 1100 WP-WT	93-96		BLM3095-2F	BLMR3095-2F		BLM3095-1R

FRONT / AVANT / VORN / FRENTE / ANTERIORE

REAR / ARRIÈRE / HINTEN / POSTERIOR / POSTERIORE

BRAKE
LINES

BRAKE LINES



SUZUKI



		OE Replacement Brake Lines (Front)	Race Standard Brake Lines (Front)	OE Replacement Brake Lines (Rear)
GSF 1200 K1-K5 Bandit	01-06	BLM3037-3F	BLMR3037-2F	BLM3037-1R
GSF 1200 T-Y Bandit	96-00	BLM3038-3F	BLMR3038-2F	BLM3038-1R
GSF 1250 Bandit	06-13	BLM3039-2F	BLMR3039-2F	BLM3039-1R
GSF 1250 A Bandit ABS	07-13	BLM3040-8F		
B-King	07-10	BLM3000-2F		BLM3000-1R
GSX 1300 R Hayabusa	99-06	BLM3060-2F	BLMR3060-2F	BLM3060-1R
GSX 1300 R Hayabusa	07-13	BLM3061-2F	BLMR3061-2F	BLM3061-1R
GSX 1400	01-09	BLM3062-3F	BLMR3062-2F	BLM3062-1R
VS 1400 GLPH-GLPV Intruder	87-99	BLM3154-1F		BLM3154-1R
VZR 1800	06-	BLM3160-3F	BLMR3160-2F	BLM3160-1R

SUZUKI OFF ROAD

DRZ 125/DRZ 125L	03-	BLM6077-1F		
DRZ 250	04-07	BLM6078-1F		BLM6078-1R
RM 250	06-08	BLM6029-1F		BLM6029-1R
RM-Z 250	04-09	BLM6080-1F		BLM6080-1R
RM-Z 250	11	BLM6081-1F		BLM6081-1R
DR-Z 400	05-07	BLM6079-1F		
DR-Z 400 E	00-07	BLM6013-1F		BLM6013-1R
RM-Z 450	05-07	BLM6080-1F		BLM6080-1R
RM-Z 450	08-09	BLM6083-1F		BLM6083-1R
RM-Z 450	11	BLM6084-1F		BLM6084-1R

TRIUMPH

Bonneville/T100 (-Ch 437492)	01-12	BLM8195-1F		
Bonneville America	03-06	BLM8196-1F		BLM8196-1R
Bonneville Thruxton 900	03-13	BLM8197-1F		BLM8197-1R
Daytona 600	03-04	BLM8198-2F	BLMR8198-2F	BLM8198-1R
Daytona 675	06-13	BLM8199-2F	BLMR8199-2F	BLM8199-1R
Daytona 750/1000	91-93	BLM8200-3F	BLMR8200-2F	BLM8200-1R
Daytona 900/1200	92-97	BLM8201-3F	BLMR8201-2F	BLM8201-1R
Daytona 955i	01-03	BLM8202-2F	BLMR8202-2F	BLM8202-1R
Daytona 955i	99-00	BLM8202-2F	BLMR8202-2F	BLM8203-1R
Daytona T595	97-00	BLM8202-2F	BLMR8202-2F	BLM8204-1R
Legend	98-01	BLM8205-1F		BLM8205-1R
Rocket III (Standard Bars)	04-15	BLM8206-3F		BLM8206-1R
Rocket III Classic (Higher Bars)	04-15	BLM8207-3F		BLM8206-1R
Scrambler 865	06-13	BLM8208-1F		
Speed Four	03-06	BLM8209-2F		BLM8209-1R
Speed III	94-96	BLM8210-3F	BLMR8210-2F	BLM8210-1R
Speed III T509	97-03	BLM8211-2F	BLMR8211-2F	BLM8211-1R
Speed Triple 1050	04-10	BLM8212-3F	BLMR8212-2F	BLM8212-1R
Speedmaster	03-11	BLM8213-2F	BLMR8213-2F	BLM8213-1R
Sprint	93-97	BLM8214-3F	BLMR8214-2F	BLM8214-1R
Sprint RS	99-05	BLM8215-2F		BLM8215-1R
Sprint ST 1050 (Non ABS) To Vin 291665	05-12	BLM8216-2F		BLM8216-1R
Sprint ST/Executive	98-03	BLM8217-2F	BLMR8217-2F	BLM8217-1R
Sprint ST/Executive Late 03 On	03-	BLM8218-2F		BLM8218-1R
Street Triple 675	06-15	BLM8219-2F	BLMR8219-2F	BLM8219-1R
Street Triple 675R	09-15	BLM8220-2F	BLMR8220-2F	BLM8220-1R
Street Twin	17-	BLM8240-3F		BLM8240-2R
Thunderbird (Low Bar)	95-02	BLM8221-1F		BLM8205-1R
Thunderbird 900 Sport	98-03	BLM8222-3F		BLM8222-1R
Thunderbird/Adventurer	95-03	BLM8223-1F		BLM8205-1R
Tiger	93-99	BLM8224-3F	BLMR8224-2F	BLM8224-1R
Tiger 1050 (Non ABS)	13	BLM8225-3F		BLM8225-1R
Tiger 800 XC	11-14		BLMR8226-2F	BLM8226-1R
Tiger 955	00-03	BLM8227-2F		BLM8227-1R
Trident 750/900	-91	BLM8228-3F	BLMR8228-2F	BLM8228-1R
Trident 750/900	91-98	BLM8229-3F	BLMR8229-2F	BLM8228-1R
Trophy 900/1200 (From Vin 71699)	03-	BLM8230-2F		BLM8230-1R
Trophy 900/1200 (Up To Vin 71698)	-03	BLM8231-3F	BLMR8231-2F	BLM8231-1R
TT 600	00-03	BLM8232-2F	BLMR8232-2F	BLM8232-1R

FRONT / AVANT / VORN / FRENTE / ANTERIORE

REAR / ARRIÈRE / HINTEN / POSTERIOR / POSTERIORE

BRAKE
LINES

BRAKE LINES



YAMAHA



		OE Replacement Brake Lines (Front)	Race Standard Brake Lines (Front)	OE Replacement Brake Lines (Rear)
DT 125 X	06	BLM2002-1F		BLM2002-1R
TDR 125	93-97	BLM2072-1F		BLM2072-1R
TZR 125	87-97	BLM2079-1F		BLM2079-1R
YZFR 125	08-13	BLM2146-1F		BLM2146-1R
YZF-R125	14-16	BLM2163-1F		BLM2163-1R
FZ1 Fazer	06-13	BLM2010-3F	BLMR2010-2F	BLM2010-1R
TDR 250	88-92	BLM2073-1F		BLM2073-1R
TDM 250	88-90	BLM2068-1F		
RD 250 LC	80-85	BLM2057-1F		
TZ 250	91-		BLMR2078-2F	BLM2078-1R
XS 250 SE	80-85	BLM2101-1F		
RD 350 LC	80-83	BLM2058-3F	BLMR2058-2F	
XT 350	85-96	BLM2116-1F		BLM2116-1R
FZR 400 Exup Import	85-89	BLM2022-3F	BLMR2022-2F	BLM2022-1R
FZR 400 Genesis Import	85-87	BLM2023-3F	BLMR2023-2F	
FZR 400 RR	92-96	BLM2024-3F	BLMR2024-2F	BLM2024-1R
FZR 400 RRSP	91-92	BLM2025-3F	BLMR2025-2F	BLM2025-1R
XS 400 SE Single Disc	80-83	BLM2102-2F		
XS 400 SE Single Disc	78	BLM2103-1F		
SR 500 Single Disc	78-83	BLM2065-2F		
XS 500 C	76	BLM2104-1F		BLM2104-1R
XV 535 (High Bar)	88-03	BLM2131-1F		
XV 535 (Low Bar)	88-02	BLM2132-1F		
XJ 550	81-85	BLM2082-3F		
XZ 550	82-85	BLM2141-3F		
FZ6	04-06	BLM2011-3F	BLMR2011-2F	BLM2011-1R
FZ6 S2	07-08	BLM2012-2F	BLMR2012-2F	BLM2011-1R
FZ 600	87-88	BLM2013-3F	BLMR2013-2F	BLM2013-1R
FZR 600	89-90	BLM2026-3F	BLMR2026-2F	BLM2026-1R
FZR 600 Genesis	91-93	BLM2027-3F	BLMR2027-2F	BLM2027-1R
FZR 600 R	94-96	BLM2028-2F		BLM2028-1R
FZS 600 Fazer	98-03	BLM2032-3F	BLMR2032-2F	BLM2032-1R
R6	08-15		BLMR2049-2F	BLM2049-1R
R6	06-07		BLMR2048-2F	BLM2048-1
R6	05	BLM2047-3F	BLMR2047-2F	BLM2047-1R
R6	03-04	BLM2046-2F		BLM2046-1R
R6	98-02	BLM2045-2F		BLM2045-1R
XJ 600	84-92	BLM2084-3F		BLM2084-1R
XJ 600 N	94-97	BLM2085-1F		BLM2085-1R
XJ 600 N/S Diversion	98-03	BLM2086-2F		BLM2086-1R
XJ 600 S Diversion	92-97	BLM2087-1F		BLM2085-1R
XJ6/XJ6 Diversion/XJ6 SP	09-13	BLM2083-2F	BLMR2083-2F	BLM2083-1R
XT 600 Tenere	86-90	BLM2118-1F		BLM2118-1R
XT 600 E	93-03	BLM2119-1F		BLM2119-1R
YF 600 R Thundercat	96-03	BLM2144-2F		BLM2144-1R
XJ 650	80-84	BLM2088-3F		
XJ 650 Turbo	82-85	BLM2089-3F		
XS 650	77	BLM2105-2F		
XS 650	81-82	BLM2106-3F		
XS 650 (Twin Disc)	75	BLM2107-3F		
XS 650 (2)	72	BLM2108-1F		
XS 650 C	75	BLM2109-3F		
XS 650 E	79-80	BLM2110-3F		
XVS 650 Drag Star	97-03	BLM2137-1F		
XVS 650 A Drag Star Classic	98-03	BLM2138-1F		
SZR 660	96-97	BLM2067-1F		BLM2067-1R
XT 660 R	04-13	BLM2120-1F		BLM2120-1R
XT 660 X	04-13	BLM2121-1F		BLM2121-1R
XT 660 Z	09-13	BLM2122-3F		BLM2122-1R
XTZ 660	91-99	BLM2119-1F		BLM2119-1R
MT-07	14-17	BLM2153-3F		BLM2153-4R
MT-07 Tracer	16-17	BLM2160-3F		BLM2160-4R
XSR 700	16-17	BLM2154-3F		BLM2154-4R

FRONT / AVANT / VORN / FRENTE / ANTERIORE

REAR / ARRIÈRE / HINTEN / POSTERIOR / POSTERIORE

BRAKE
LINES

BRAKE LINES



YAMAHA



		OE Replacement Brake Lines (Front)	Race Standard Brake Lines (Front)	OE Replacement Brake Lines (Rear)
FZ 750	85-86	BLM2014-3F	BLMR2014-2F	BLM2014-1R
FZ 750	87-88	BLM2015-3F	BLMR2015-2F	BLM2015-1R
FZR 750	89-92	BLM2029-3F	BLMR2029-2F	BLM2029-1R
FZR 750 R OW01	89-92	BLM2030-2F		BLM2030-1R
FZS 750	87-89	BLM2033-3F	BLMR2033-2F	BLM2033-1R
XJ 750 Antidive	82-84	BLM2090-5F		
XS 750	78-79	BLM2111-3F		BLM2111-1R
XS 750 E	77-78	BLM2112-3F		BLM2112-1R
XS 750 SE	80-82	BLM2113-3F		BLM2113-1R
XTZ 750 Super Tenere	89-96	BLM2124-3F	BLMR2124-2F	BLM2124-1R
XV 750	92-97	BLM2133-3F		
XV 750 SE	81-83	BLM2134-1F		
YZF 750	93-97	BLM2145-2F		BLM2145-1R
FZ8-Non ABS	10-13		BLMR2016-2F	BLM2016-1R
TDM 850	91-96	BLM2069-3F	BLMR2069-2F	BLM2069-1R
TDM 850	97-02	BLM2070-3F	BLMR2070-2F	BLM2069-1R
TRX 850	96-00	BLM2074-2F		BLM2074-1R
XS 850	80-85	BLM2114-3F		BLM2114-1R
MT-09	13-16	BLM2037-2F		BLM2037-1R
TDM 900 Non ABS	02-13	BLM2071-3F	BLMR2071-2F	BLM2071-1R
XJ 900	83-85	BLM2091-3F		BLM2091-1R
XJ 900 F	85-94	BLM2092-3F		BLM2092-1R
XJ 900 S Diversion	94-96	BLM2093-2F		BLM2093-1R
XJ 900 S Diversion	97-03	BLM2094-3F	BLMR2094-2F	BLM2094-1R
FZR 1000 Ex-Up	95-96	BLM2017-2F		BLM2017-1R
FZR 1000 Ex-Up	89-90	BLM2018-2F		BLM2018-1R
FZR 1000 Ex-Up	91	BLM2019-3F	BLMR2019-2F	BLM2019-1R
FZR 1000 Genesis	87-88	BLM2020-3F	BLMR2020-2F	BLM2020-1R
FZR 1000 RU	92-94	BLM2021-3F	BLMR2021-2F	BLM2021-1R
FZS 1000 Fazer	01-05	BLM2031-3F	BLMR2031-2F	BLM2031-1R
GTS 1000 A	93-96	BLM2034-7FR		Supplied as front & rear kit complete
XV 1000 TR1	81-85	BLM2125-3F		
XV 1000 Virago	86-89	BLM2126-3F		
XV 1000 Virago	89-99	BLM2127-3F	BLMR2127-2F	
YZF 1000 R Thunderace	96-02	BLM2143-2F		
R1	98-01	BLM2039-2F		BLM2143-1R
R1	02-03		BLMR2040-2F	BLM2039-1R
R1	04-05		BLMR2041-2F	BLM2040-1R
R1	06		BLMR2041-2F	BLM2041-1R
R1	07-08		BLMR2043-2F	BLM2042-1R
R1	09-14		BLMR2044-2F	BLM2043-1R
BT 1100 Bulldog	01-03	BLM2000-3F		BLM2044-1R
FJ 1100	85-86	BLM2003-5F		BLM2000-1R
XS 1100	78-80	BLM2099-3F		BLM2003-1R
XS 1100 S	78-84	BLM2100-3F		BLM2099-1R
XVS 1100/A Dragstar	98-06	BLM2135-3F		BLM2100-1R
XVS 1100/A Dragstar Classic	98-06	BLM2136-3F		BLM2135-1R
FJ 1200 (Antidive)	86-87	BLM2004-5F		BLM2135-1R
FJ 1200 (Non Antidive)	88-96	BLM2005-3F	BLMR2005-2F	BLM2004-1R
FJ 1200 ABS	91-96	BLM2006-6F		BLM2005-1R
XJR 1200	95-98	BLM2095-2F		BLM2006-2R
V-MAX	91-04	BLM2081-3F	BLMR2081-2F	BLM2095-1R
FJR 1300	00-02	BLM2007-3F		BLM2081-1R
FJR 1300	03-04	BLM2008-3F		BLM2007-1R
XJR 1300	99-01	BLM2096-3F	BLMR2096-2F	BLM2008-1R
XJR 1300	02-03		BLMR2097-2F	BLM2096-1R
XJR 1300	04-13		BLMR2098-2F	BLM2097-1R
XVZ 1300 A/AT Royal Star/Tour Classic	96-99	BLM2139-3F	BLMR2139-2F	BLM2098-1R
XVZ 1300 TF Venture Star	00-02	BLM2129-3F		BLM2139-1R
XV 1600 Wild Star	98-03	BLM2129-3F		BLM2129-1R
XV 1900 Midnight Star	05-09	BLM2130-3F	BLMR2130-2F	BLM2129-1R
				BLM2130-1R

FRONT / AVANT / VORN / FRENTE / ANTERIORE

REAR / ARRIÈRE / HINTEN / POSTERIOR / POSTERIORE

BRAKE
LINES

How To Make Precision Pilot Jets

Everyone knows how sensitive an engine is to pilot jets in the acceleration stages from 1000 to 3500 rpm and getting fuel mixture right in this area is critical. For this reason jets have to be perfectly accurate in their marked size and incremental size steps. EBC Brakes sister company A-BAX Precision Engineering Ltd in the UK has purchased the most accurate machine on the planet for this work shown below. A-BAX Precision Engineering Ltd pilot jets are precise, clearly marked and reliably gauged using pin gauges, accurate to one tenth of a thousandth of an inch, you can rely on their accuracy.

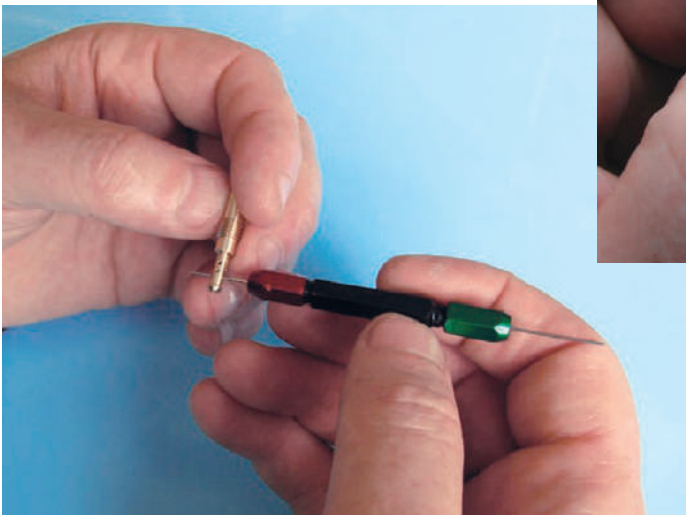
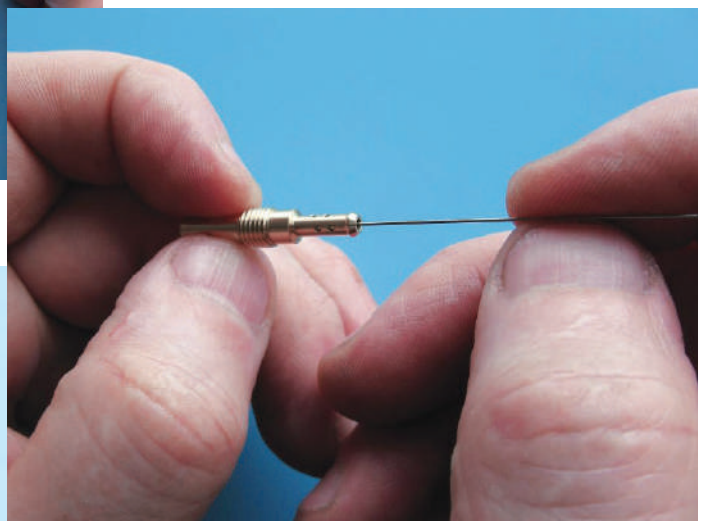
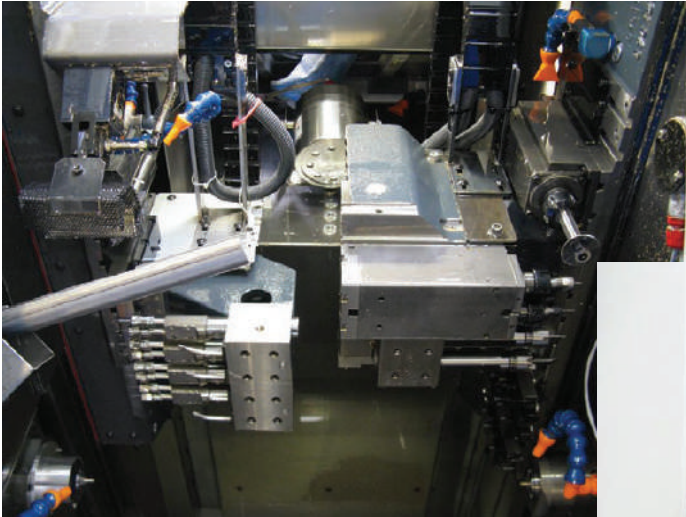

PILOT JETS

A-BAX Precision Engineering Ltd Pilot Jets for Mikuni Carbs (Sold in packs of 4)

Jet Style – VM22/210

8 bleed hole type
VM18 / VM22 / VM26-34 Flange Type
VM26-44 Spigot Type
TM24-38 (No accelerator pump)
Early TMX/TMX Carb Types

Size	Part #
10	EBC22/210-10
12.5	EBC22/210-12.5
15	EBC22/210-15
17.5	EBC22/210-17.5
20	EBC22/210-20
22.5	EBC22/210-22.5
25	EBC22/210-25
27.5	EBC22/210-27.5
30	EBC22/210-30
32.5	EBC22/210-32.5
35	EBC22/210-35
37.5	EBC22/210-37.5
40	EBC22/210-40
42.5	EBC22/210-42.5
45	EBC22/210-45
47.5	EBC22/210-47.5
50	EBC22/210-50
52.5	EBC22/210-52.5
55	EBC22/210-55
57.5	EBC22/210-57.5
60	EBC22/210-60
65	EBC22/210-65
70	EBC22/210-70
75	EBC22/210-75
80	EBC22/210-80
85	EBC22/210-85
90	EBC22/210-90
95	EBC22/210-95
100	EBC22/210-100
105	EBC22/210-105
110	EBC22/210-110
120	EBC22/210-120
130	EBC22/210-130
140	EBC22/210-140



Jet Style – N224.103

2.5mm bleed end
Early TMS/TMX
OEM MX36/38 BSR CV type
Honda / Kawasaki / Suzuki / Yamaha

Size	Part #
10	EBC224-10
12.5	EBC224-12.5
15	EBC224-15
17.5	EBC224-17.5
20	EBC224-20
22.5	EBC224-22.5
25	EBC224-25
27.5	EBC224-27.5
30	EBC224-30
32.5	EBC224-32.5
35	EBC224-35
37.5	EBC224-37.5
40	EBC224-40
42.5	EBC224-42.5
45	EBC224-45
47.5	EBC224-47.5
50	EBC224-50
52.5	EBC224-52.5
55	EBC224-55
57.5	EBC224-57.5
60	EBC224-60
62.5	EBC224-62.5
65	EBC224-65
67.5	EBC224-67.5
70	EBC224-70



Jet Style – N151.067

No bleed holes
Later OEM BS range CV carbs
Kawasaki / Suzuki / Yamaha / Triumph

Size	Part #
30	EBC151-30
32.5	EBC151-32.5
35	EBC151-35
37.5	EBC151-37.5
40	EBC151-40
42.5	EBC151-42.5
45	EBC151-45
47.5	EBC151-47.5
50	EBC151-50
52.5	EBC151-52.5
55	EBC151-55
57.5	EBC151-57.5
60	EBC151-60



Jet Style – VM28/486

2mm bleed hole type
HS40 / HSR42 / 45 / 48 / RS34-40
TM33 / 36 / 40 with accelerator pump
Kawasaki / Suzuki / Yamaha

Size	Part #
10	EBC28/486-10
12.5	EBC28/486-12.5
15	EBC28/486-15
17.5	EBC28/486-17.5
20	EBC28/486-20
22.5	EBC28/486-22.5
25	EBC28/486-25
27.5	EBC28/486-27.5
30	EBC28/486-30
32.5	EBC28/486-32.5
35	EBC28/486-35
37.5	EBC28/486-37.5
40	EBC28/486-40
42.5	EBC28/486-42.5
45	EBC28/486-45
47.5	EBC28/486-47.5
50	EBC28/486-50
52.5	EBC28/486-52.5
55	EBC28/486-55
57.5	EBC28/486-57.5
60	EBC28/486-60
62.5	EBC28/486-62.5
65	EBC28/486-65
67.5	EBC28/486-67.5
70	EBC28/486-70



Jet Style – M28/1001

Yamaha P/No. 260-14142-Size
Blaster/Banshee/LC

Size	Part #
15	EBC1001-15
17.5	EBC1001-17.5
20	EBC1001-20
22.5	EBC1001-22.5
25	EBC1001-25
27.5	EBC1001-27.5
30	EBC1001-30
32.5	EBC1001-32.5
35	EBC1001-35
37.5	EBC1001-37.5
40	EBC1001-40
42.5	EBC1001-42.5
45	EBC1001-45
47.5	EBC1001-47.5
50	EBC1001-50
52.5	EBC1001-52.5
55	EBC1001-55
57.5	EBC1001-57.5
60	EBC1001-60
62.5	EBC1001-62.5
65	EBC1001-65
67.5	EBC1001-67.5
70	EBC1001-70



Jet Style – BS30/96

6 bleed hole type
Various OEM BS range CV carbs
Kawasaki / Suzuki / Yamaha

Size	Part #
30	EBC30/96-30
32.5	EBC30/96-32.5
35	EBC30/96-35
37.5	EBC30/96-37.5
40	EBC30/96-40
42.5	EBC30/96-42.5
45	EBC30/96-45
47.5	EBC30/96-47.5
50	EBC30/96-50
52.5	EBC30/96-52.5
55	EBC30/96-55
57.5	EBC30/96-57.5
60	EBC30/96-60



A-BAX Precision Engineering Ltd Pilot Jets for Keihin Carbs (Sold in packs of 4)

Jet Style – N424-21

Pilot / Slow Running Jet
PB16 / 18 / 20
Yamaha R6 99-07
Various Kawasaki / Suzuki Quads

Size	Part #
35	EBC424-21-35
38	EBC424-21-38
40	EBC424-21-40
42	EBC424-21-42
45	EBC424-21-45
48	EBC424-21-48
50	EBC424-21-50
52	EBC424-21-52
55	EBC424-21-55
58	EBC424-21-58
60	EBC424-21-60
62	EBC424-21-62
65	EBC424-21-65
68	EBC424-21-68
70	EBC424-21-70
72	EBC424-21-72
75	EBC424-21-75
78	EBC424-21-78
80	EBC424-21-80



Jet Style – N424-25

Pilot / Slow Running Jet
FCR 28 / 32 / 33 / 35 / 37 / 39 / 41mm
Harley D Keihin BH (Non CV Type)
Various Kawasaki / Yamaha Models with CVK / FCR / BD style carbs

Size	Part #
35	EBC424-25-35
38	EBC424-25-38
40	EBC424-25-40
42	EBC424-25-42
45	EBC424-25-45
48	EBC424-25-48
50	EBC424-25-50
52	EBC424-25-52
55	EBC424-25-55
58	EBC424-25-58
60	EBC424-25-60
62	EBC424-25-62
65	EBC424-25-65



Dealer Pilot Jet Selection Kits

(Kits include one pilot jet per size)



Part No.	Kit Contents
KPJK-01	Keihin 424-21 Style Carburetor Pilot Jet Selection Kit (19 Pcs)
KPJK-02	Keihin 424-25B Style Carburetor Pilot Jet Selection Kit (13 Pcs)
MPJK-01	Mikuni VM22/210 Style Carburetor Pilot Jet Selection Kit (34 Pcs)
MPJK-02	Mikuni N224.103 Style Carburetor Pilot Jet Selection Kit (25 Pcs)
MPJK-03	Mikuni N151.067 Style Carburetor Pilot Jet Selection Kit (13 Pcs)
MPJK-04	Mikuni BS30/96 Style Carburetor Pilot Jet Selection Kit (13 Pcs)
MPJK-05	Mikuni 28.486 Style Carburetor Pilot Jet Selection Kit (25 Pcs)

Precision machined in the UK A-BAX Dealer selection kits include all the popular sizes for the better selling pilot jets and refills can be purchased from your distributor in packets of four.



MAIN JETS

A-BAX Precision Engineering Ltd MAINJETS

Made in the UK, these high precision BRASS carburettor jets are available in dealer selection kits or in top-up packs of 5 jets or 4 jets. All jets are flow calibrated and extremely accurate in terms of fuel flow rate as stamped.

DEALER SELECTION KITS

PART NO.	DESCRIPTION	PART NO.	DESCRIPTION
CRK030	Hex Main Jets for Keihin Carbs (60 Pcs)	HDJK-12	Keihin Harley Jet Selection Kit
CRK032A	Hex Main Jets for Keihin Carbs (64 Pcs)	SJK36	Mikuni Slot Main Jet (144 Pcs)
CRK032B	Hex Main Jets for Keihin Carbs (60 Pcs)	KJK30	Keihin Slot Main Jets Kit (USA Only)
HJK27A	Mikuni Hex Main Jet (54 Pcs)	KJK36	Keihin Slot Main Jets Kit (144 Pcs)
HJK27B	Mikuni Hex Main Jet (54 Pcs)		
HJK36	Mikuni Hex Main Jet (72 Pcs)		

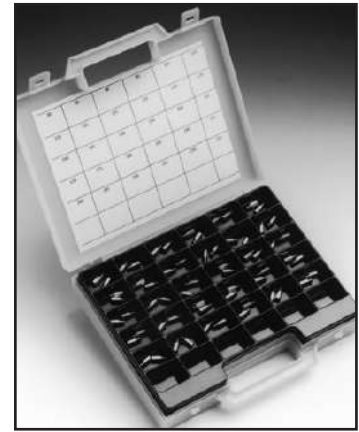

NOTE – Jets listed below only sold in packets of 4pcs (5 pcs on Dell Orto)

<p>ABAX Slot Jets for Mikuni</p>	<p>ABAX Hex Jets for Mikuni</p>	<p>ABAX Slot Jets for Keihin</p>	<p>ABAX Hex Jets for Keihin</p>	<p>ABAX Slot Jets for Dell Orto</p>
<p>(N 100/604) SJ Prefix</p>	<p>(4/042) HJ Prefix</p>	<p>(N102 221) KJ Prefix</p>	<p>(357) CR Prefix</p>	<p>(6413) DO Prefix</p>

SIZES AVAILABLE	SIZES AVAILABLE	SIZES AVAILABLE	SIZES AVAILABLE	SIZES AVAILABLE	SIZES AVAILABLE	SIZES AVAILABLE	SIZES AVAILABLE
SJ70-4	HJ70-4	HJ400-4	KJ72.5-4	KJ190-4	CR080-4	CR198-4	D0070-5
SJ72.5-4	HJ80-4	HJ410-4	KJ75-4		CR085-4	CR200-4	D0075-5
SJ75-4	HJ90-4	HJ420-4	KJ77.5-4		CR090-4	CR202-4	D0080-5
SJ77.5-4	HJ100-4	HJ430-4	KJ80-4		CR095-4	CR205-4	D0085-5
SJ80-4	HJ105-4	HJ440-4	KJ82.5-4		CR100-4	CR208-4	D0090-5
SJ82.5-4	HJ110-4	HJ450-4	KJ85-4		CR102-4	CR210-4	D0095-5
SJ85-4	HJ115-4	HJ460-4	KJ87.5-4		CR105-4	CR212-4	D0100-5
SJ87.5-4	HJ120-4	HJ470-4	KJ90-4		CR108-4	CR215-4	D0105-5
SJ90-4	HJ125-4	HJ480-4	KJ92.5-4		CR110-4	CR218-4	D0110-5
SJ92.5-4	HJ130-4	HJ490-4	KJ95-4		CR112-4	CR220-4	D0115-5
SJ95-4	HJ135-4	HJ500-4	KJ97.5-4		CR115-4	CR222-4	D0120-5
SJ97.5-4	HJ140-4	HJ510-4	KJ100-4		CR118-4	CR225-4	D0125-5
SJ100-4	HJ145-4	HJ520-4	KJ102.5-4		CR120-4	CR228-4	D0130-5
SJ102.5-4	HJ150-4	HJ530-4	KJ105-4		CR122-4	CR230-4	D0135-5
SJ105-4	HJ155-4	HJ540-4	KJ107.5-4		CR125-4	CR232-4	D0140-5
SJ107.5-4	HJ160-4	HJ550-4	KJ110-4		CR128-4	CR235-4	D0145-5
SJ110-4	HJ165-4	HJ560-4	KJ112.5-4		CR130-4	CR238-4	D0150-5
SJ112.5-4	HJ170-4	HJ570-4	KJ115-4		CR132-4		D0155-5
SJ115-4	HJ175-4	HJ580-4	KJ117.5-4		CR135-4		D0160-5
SJ117.5-4	HJ180-4	HJ590-4	KJ120-4		CR138-4		D0165-5
SJ120-4	HJ185-4	HJ600-4	KJ122.5-4		CR140-4		D0170-5
SJ122.5-4	HJ190-4	HJ610-4	KJ125-4		CR142-4		D0175-5
SJ125-4	HJ195-4	HJ620-4	KJ127.5-4		CR145-4		D0180-5
SJ127.5-4	HJ200-4	HJ630-4	KJ130-4		CR148-4		D0185-5
SJ130-4	HJ210-4	HJ640-4	KJ132.5-4		CR150-4		D0190-5
SJ132.5-4	HJ220-4	HJ650-4	KJ135-4		CR152-4		D0195-5
SJ135-4	HJ230-4	HJ660-4	KJ137.5-4		CR155-4		D0200-5
SJ137.5-4	HJ240-4	HJ670-4	KJ140-4		CR158-4		
SJ140-4	HJ250-4	HJ680-4	KJ142.5-4		CR160-4		
SJ142.5-4	HJ260-4	HJ690-4	KJ145-4		CR162-4		
SJ145-4	HJ270-4		KJ147.5-4		CR165-4		
SJ147.5-4	HJ280-4		KJ150-4		CR168-4		
SJ150-4	HJ290-4		KJ152.5-4		CR170-4		
SJ152.5-4	HJ300-4		KJ155-4		CR172-4		
SJ155-4	HJ310-4		KJ157.5-4		CR175-4		
SJ157.5-4	HJ320-4		KJ160-4		CR178-4		
SJ160-4	HJ330-4		KJ165-4		CR180-4		
SJ165-4	HJ340-4		KJ170-4		CR182-4		
SJ170-4	HJ350-4		KJ172-4		CR185-4		
	HJ360-4		KJ175-4		CR188-4		
	HJ370-4		KJ177-4		CR190-4		
	HJ380-4		KJ180-4		CR192-4		
	HJ390-4		KJ185-4		CR195-4		

NOTE: The names Mikuni & Keihin are for description purposes only. These are NOT original Mikuni or Keihin jets, simply a high quality replacement.

MAIN JETS



DEALER SELECTION KIT
PART NO – HDJK-12

A-BAX Precision Engineering Ltd brass main jets for Keihin CVH carburettors, used on most big twins. Sold in packets of 2 pieces and in dealer assortment kits of 12 sizes (2 pieces each size).

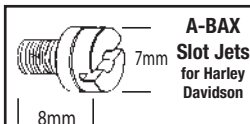

(N424-27)
HDJK Prefix

SIZES AVAILABLE

- EBC424-27-160
- EBC424-27-165
- EBC424-27-170
- EBC424-27-175
- EBC424-27-180
- EBC424-27-185
- EBC424-27-190
- EBC424-27-195
- EBC424-27-200
- EBC424-27-205
- EBC424-27-210
- EBC424-27-220

S&B FILTERS



Made in the USA, S&B Custom Filters are a great choice for all types of carburettor and feature a special man made gauze called "Remay" made by Dupont® which has the benefit of perfectly uniform hole patterns. This enables the S&B filter to catch dust better than an oil soaked filter and to be run DRY. Oiled filters require regular washing and relube which plays havoc with carburettor balance. Available in parallel or cone type design, with high lustre chrome end caps.



DIMENSION CHART

CONICAL TYPES					PARALLEL TYPES				
FILTER No.	A	B	C	D	FILTER No.	A	B	C	D
RC79	35	63	58	51	RC17	40	89	38	74
RC106	48	76	76	51	RC34	44	114	38	114
RC107	43	76	70	51	RU99	(Special Norton Filter)			
RC120	52.5	89	102	51	OVAL TYPES				
RC125	57	86	95	51					
RC135	55	88	104	88	RC059	43	112	70	75
RC234	55	76	70	51	RC069	50	112	70	75
RC311	28	57	57	51	RC84	40	72	51	51
RC312	51	73	63	51	RC098	55	112	70	75
RC313	43	76	60	51					

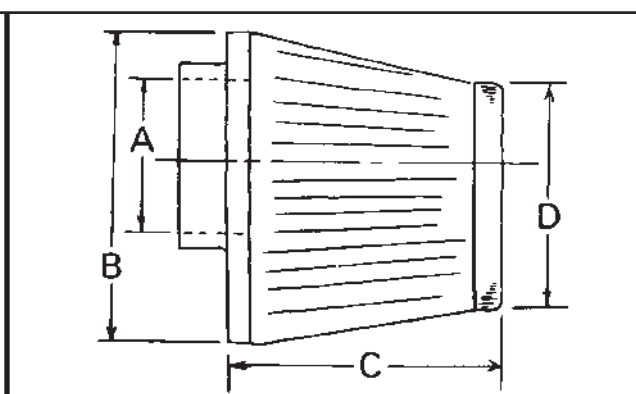
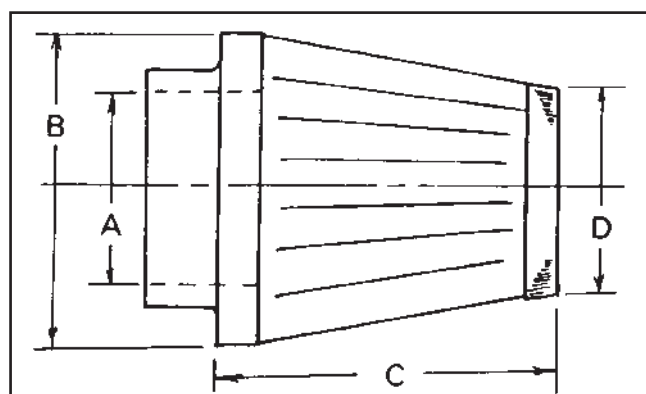

hy-tech racing reeds

For STREET Bikes New CW38 Fibre for higher durability and perfect Reed block seal in high revving 2 stroke motors.

For DIRT Bikes New TWO STAGE Action. By using a lighter fibre on the lower reed block position New Hy-Tech "D" suffix. Reed Kits open earlier and give perfect TWO STAGE response without turbulence or early primary stage reed petal fatigue or New Carbon Fibre CF Series. See below.

CARBON FIBRE REEDS for most Street and Dirt Bike models Prefix CF for Carbon Fibre.

ROAD BIKE REEDS ALSO AVAILABLE IN CARBON FIBRE

CF02, CF11, CF15, CF18, CF81, CF118,
CF201, CF202, CF210, CF215

DIRT BIKE APPLICATIONS		DIRT BIKE APPLICATIONS		STREET BIKE APPLICATIONS	
CAGIVA		SUZUKI Cont.		KAWASAKI	
WMX 125/250 (1985)	HT09D	RM 125 L/M/N/P/R/S	CF78	AE/AR 50	HT05
WMX 500	CF14	RM 125 T/V/W/X/Y/K1-K5	CF93	AE/AR 80	HT05
HONDA		RM 250 X-G (81-86)	CF14	KMX 125 (All Models)	CF06
CR 80 RG-R2 (86-02)	CF48	RM 250 H/J (87-88)	CF06	KDX 125 A1-A2/B1-B2	CF64
CR 85 R3-R7 (03-07)	CF48	RM 250 K/L (89-90)	CF68	KR1/KR1-S	HT81
CR 125 (All Models) up to 01	CF18	RM 250 M/N	CF83	SUZUKI	
CR 125 R1/R2/R3/R4	CF208	RM 250 P/R/S	CF65	TS/ZR 50 (All models)	HT16
CR 250 RC/RD/RE/RF		RM 250 T/V/W/X/Y/K1-K5	CF94	TS 100/125/185/250	
/RG/RH	HT61D	RMX 250 K/L	HT68D	(C&ER Models)	HT12
CR 250 RJ-RW	CF66	LT 250 RF/RG/RH	HT38	RG 125 (All Models up to 91)	CF11
CR 250 RX/RV/R1/R2/R3	CF167	LT 250/500 RJ/RK/RL/RM/RN	HT68D	RG 125 FUN/FUP/UN	CF18
CR 500 RE/RF/RG/RH		RM 465 X/Z	CF57	TS 125 X (All Models)	CF11
/RJ/RK	HT17D	RM 500 D/E	CF57	TS 125 RK/RL/RR/RR	CF18
CR 500 RL-R1	CF77	YAMAHA		GT 250 "X7"	HT216
ATC/TRX 250 (All Models)	CF06	YZ 50 G-K	HT05	RG 250 (All Models)	CF211
HUSQVARNA		YZ 80 N-S	HT32D	RGV 250 K	HT80
125 (82-98)	HT33D	YZ 80 T/U/W/A/B	HT46	RGV 250 L/M/N/P/R	N/A
KTM		YZ 80 E/F/G/H/J/K/L/M/N	CF88	TS 250 XE	HT38
125 (All Models) (84-96)	CF22	YZ 85 P/R/S	CF88	TS 250 XG/XH/XJ	HT09D
250 (All Models) (84-96)	CF22	YZ 125 G-T/E (86-87/93)	CF03	YAMAHA	
495/500 (All Models) (82-96)	HT23D	YZ 125 U-D (88-92)	HT67D	DT/RD 50 M	HT105
KAWASAKI		YZ 125 F/G/H/J/K/L/M (94-00)	CF89	DT/RD 50 MX	HT30
KX 60 B1-B19	HT40D	YZ 125 N/P/R/S/T/V/W/X/Y (01-09)	CF185	RD 80 MX/LC	HT05
KX 65 A1/A2/A3/A4	HT40D	WR 200 (89-96)	CF04	DT 80 MX (81-)	HT30
KX 80 G1/G2/J1/J2	HT54D	YFS 200 Blaster (Quad) (91-06)	HT46D	DT 80 MX (82-)	HT05
KX 80 L1-L3/R1-R7/W1/W3	CF01NC	YZ 250 E-J	CF04	RS 100	HT05
KX 85 A1/B1/A2/B2/A3/B3	CF01NC	YZ 250 K	HT31D	DT/RXS 100	HT01
KX 100 A1/A2/B1-B7/C1-C3	CF01NC	YZ 250 L-U	HT07D	DT 125 MX	HT01
KX 125 (All Models) (82-93)	CF64	YZ 250 W-H	CF04	RD 125/200	HT205
KX 125 K1-K3	CF78	YZ 250 J/K/L/M/N/P/R/S/T/V/W/X	CF150	DT 125 LC/LC2	HT02R
KX 125 K4-M7F	N/A	YZ 465 G/H	CF04	RD 125 LC MK1-3	HT02R
KDX 200 (All Models)	CF64	YZ 490 J to L	CF04	DT 125 R	HT15
KDX 220 A4-A10	CF64	YZ 490 N to U	HT07D	RS 125	HT01
KX 250 C2/D1/D2/E1/F1/G1/H1		IT 125/175/200 "All Models"	CF03	TZR 125/TDR 125	HT15
/H2/J1/J2/K1/K2/K3	CF14	IT 250 D/E/F	CF03	DT 175 MX	HT01
KX 250 K4/K5/L1/L2	CF66	IT 250 E/F/G/H	CF04	DT 250/400	CF18
KX 250 L3/L4/M1/M2	CF184	TY 80/175	HT05	DT 250/400 MX	HT29D
KX 500 A2/B1	HT20D	TY 250	HT01	RD 250/350/400	
KX 500 B2/C1/D1/E1-E15	CF57	TY 250 S/R	HT29D	(Air Cooled)	HT201R
MAICO		WR 250 ZB/ZD/ZE/ZF/ZG/ZH/ZJ	CF04	RD 250/350 LC	HT201R
250/490	CF06	STREET BIKE APPLICATIONS		TDR/TZR 250	HT215
SUZUKI		HONDA		RD 350 YPVS	HT202R
RM 80 G/H/J	HT56D	MB/MT/MTX 50	HT21	CARBON FIBRE REEDS Last longer, work better – increase rev range and performance	
RM 80 K/L/M/N/P/R/S/T/V/W/X/Y/K1	CF48	MBX 50	HT34		
RM 85 K2/K3/K4	CF48	MBX/MTX 80	HT34		
RM 125 H/J	CF18	H 100	HT21		
		MBX 125	HT36		
		MTX 125/200	HT36		
		NS 125 FG/FH/RK/RL	HT210		
		NSR 125 All models	HT118		

BAFFLE PAC

BAFFLE-PAC-Silencer Glass. PART NO. BP001

This material is labelled and conforms to BSAU 193T2. BEWARE of distributors selling cheaper roofing felt in its place. Repackable Tailpipes as the name implies, require regular cleaning and repacking with BSAU approved "SILENCER GLASS" such as Winning BAFFLE PAC. Failure to maintain tailpipes in such a way will lead to clogging of the silencer wool and raised noise output, together with reduced engine performance. Freeman Automotive (nor Dealers) are responsible for noise offences due to lack of maintenance as described above. "Recommended repacking period is every 3000 miles on two-strokes or when bike becomes noisy if sooner".

BRAKE FLUID

DOT 4 – A refined specification polyglycol fluid as fitted to most faster street bikes now produced.

DOT 5 – Silicone fluid as used in Harley Davidson Motorcycles and many special High Performance Brake systems.

NEW BF307 – Highly refined Dot 4 Brake fluid, ideal for Racing or High performance Road bikes. Can be used in all systems specifying Dot 3 or Dot 4 but **NOT** with (Dot 5) silicone fluids.

CAUTION – Please check carefully the type of brake fluid used in your system.

Adding the incorrect fluids could cause major brake failure.

DO NOT EVER mix glycol fluids (DOT3, DOT4 or BF307) with Dot5 Silicone.

EBC Brake Fluid is available in DOT 4 or DOT 5 (Silicone) Grades or BF307 Race Grade.

TO ORDER USE THESE NUMBERS

DOT 4 (Six Pack).....	BF 004	250ml Bottle
DOT 5 (Six Pack) (Silicone)	BF 005	250ml Bottle
BF 307 (Six Pack).....	BF 307	500ml Bottle



BRAKE CALIPER LUBE



These sachets of dedicated, high viscosity greases are perfect for all of your customers' brake service needs. Always use sparingly on caliper slider pins and rails, but do NOT get near the pad surface and do NOT use as anti-squeal as it will not help at all. Each sachet contains 5 grammes of grease.

TO ORDER USE THESE NUMBERS

Ten Sachets	LUBE010
Fifty Sachets.....	LUBE050

GALINDO / BAJA GRIPS



4 1/2" GALINDO SUPERBIKE GRIPS

Made in USA with KRATON G material. Without doubt the highest quality grip sold worldwide for street bikes. All below colours at 4 1/2" with separate spacer ring to accommodate 5" throttle units. Complete with heavy plastic bar end plugs and new high visual "Clamshell" packaging.

COLOUR	PART NO.
BLACK	GX001
RED	GX002
BLUE	GX003

BAJA FOAM GRIPS

BAJA Foam grips made in USA with "reticulated" foam closed cell construction. Sounds fancy, but what it means is Baja foam grips do not "sponge" up water as will other cheap open cell foam rubber units. Complete with bar end caps and mounting glue.

COLOUR	PART NO.
BLACK	BG001
RED	BG002
BLUE	BG003

LEDAR NOZZLES

LEDAR POWER NOZZLES 2 STROKE DETAILS

- Simply change standard OE Nozzle for Immediate Power Boost
- More power through the range
- Better carburation, improved specific fuel consumption
- Less Unburnt Hydro Carbons means cleaner exhaust and less pollution.

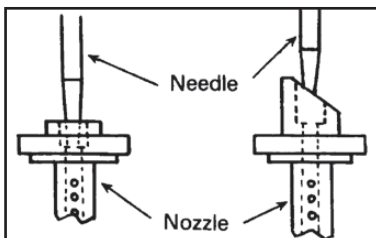

NOZZLE No.	FITMENT
LN43	RD 125 LC Mk 1/Mk 1 2 (Not YPVS), DT 125 MX
LN44	DT 125 LC/RXS 100
LN45	RD 80 LC
LN46	MBX 125/MBX 50
LN59	AR 50/AE 50/AR 80
LN61	AR 125 LC
LN63	RD 125 LC Mk 3 (YPVS)
LN66	GP 100
LN66A	GP 100 Big Bore 125 Conversion
LN67	RG 125
LN68	NS 125 FH/FG/RK

RACING REEDS

hy-tech
racing reeds



See page
870 for
applications

STREET – CW38 fibre still ideal for smaller high revving two strokes but new for track or road Hy-Tech **CARBON FIBRE** reeds, for these designs suffix regular part No with "CF" to order

DIRT – Two stage system with stiffer top reed and standard lower reed gives wider power band + longer reed life on upper reed block position

OR – **NEW** CF Carbon Fibre series now available.

PROMOTIONAL ITEMS



EBC Brakes® Fleece Zip Jacket – Dark Blue

Warm fleece with pockets and full zip to the front. EBC Brakes® logo embroidered in white to the left breast area.

ORDER CODE:

- FLEECE-S (Small)
- FLEECE-M (Medium)
- FLEECE-L (Large)
- FLEECE-XL (X-Large)
- FLEECE-XXL (XX-Large)
- FLEECE-XXXL (XXX-Large)



Water Resistant Side

EBC Brakes® Reversible Jacket – Dark Blue

Reversible jacket with water resistant nylon to one side, warm fleece to the other. Can be worn either way. EBC Brakes® logo embroidered in white to the left breast area on the water resistant side.

ORDER CODE:

- JACKET-M (Medium)
- JACKET-L (Large)
- JACKET-XL (X-Large)
- JACKET-XXL (XX-Large)



Fleece Side



EBC Brakes® Logo Hoodie

Soft, comfortable, quality hoodie made from 80% cotton / 20% polyester, in heather grey with a contrasting navy lined hood and a kangaroo pouch pocket.

ORDER CODE:

- HOODIE-M (Medium)
- HOODIE-L (Large)
- HOODIE-XL (X-Large)
- HOODIE-XXL (XX-Large)

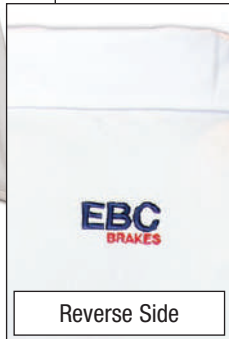

Reverse Side

EBC Brakes® Logo Cool Golf Shirt – White

A lightweight short sleeved sports shirt with three buttons to the neck, self fabric collar and cuffs. Embroidered with EBC Brakes® logo in blue and red, below the collar on reverse side.

ORDER CODE:

- GOLF-M (Medium)
- GOLF-L (Large)
- GOLF-XL (X-Large)
- GOLF-XXL (XX-Large)



EBC Brakes® Logo Golf Shirt – Dk Blue

Short sleeved golf shirt with three buttons to the neck, self fabric collar and cuffed sleeves. Embroidered with EBC Brakes® logo to the left breast in white.

ORDER CODE:

- POLO-M (Medium)
- POLO-L (Large)
- POLO-XL (X-Large)
- POLO-XXL (XX-Large)



EBC Brakes® Snap Back Style Peaked Cap – Marl Grey

100% cotton grey marl peaked snapback style cap with 3D effect EBC Brakes® logo embroidered to front. "Masters of Stopping Power" embroidered to the rear above the snap closure. Mono Union Jack printed under peak. Adjustable to fit all sizes.

ORDER CODE:
CAP

PROMOTIONAL ITEMS



EBC Brakes® Logo Mug

Dark blue china mug with EBC Brakes® logo and website URL on one side – QR code to direct customers to the EBC Brakes website. Perfect giveaway to loyal customers.

ORDER CODE: MUG

EBC Brakes® Logo Performance Sports Vest

100% polyester Cool Plus fabric, in orange with contrasting white insert to the front, back and side bands. EBC Brakes® logo to the white band across the back.

ORDER CODE:

O/VEST-M (Medium)

O/VEST-L (Large)

O/VEST-XL (X-Large)

O/VEST-XXL (XX-Large)



EBC Brakes® Logo Illuminated Clock

Mains powered illuminated clock with EBC Brakes logo and full colour EBC motorcycle brake pad and motorcycle disc rotor images.

ORDER CODE: CLOCK08



EBC Brakes® Logo Cool Vest

In red textured fabric with inherent wickability, the EBC Brakes® logo is printed to the back of the neck.

ORDER CODE:

R/VEST-M (Medium)

R/VEST-L (Large)

R/VEST-XL (X-Large)

R/VEST-XXL (XX-Large)



EBC Brakes® Logo Performance Shorts

Mesh lining with elasticated waist with drawcord, side panels and two side pockets. 100% polyester with breathable properties.

ORDER CODE:

G/SHORT-M (Medium)

G/SHORT-L (Large)

G/SHORT-XL (X-Large)

G/SHORT-XXL (XX-Large)



EBC Brakes® Authorised Dealer Sign

A5 sign printed on both sides of 650 micron PVC with two self adhesive strips applied to one side to affix the sign to your window easily.

ORDER CODE: ASK YOUR DEALER TO ORDER THIS FOR YOU



EBC Brakes® Logo Promotional Banner

Promotional banner printed onto bannergrade vinyl, hem stitched with 6 brass eyelets for easy attachment to any display stand or outside a shop.

ORDER CODE:

BANNERLOGO



EBC Brakes® Logo Illuminated Sign

Great for windows or exhibition displays.

ORDER CODE:

SIGN08

SIZE:

L = 520mm

H = 320mm

D = 110mm

PROMOTIONAL ITEMS



EBC Brakes® Logo Cloth Badge

High quality embroidered cloth badge, perfect for stitching onto racing leathers.

ORDER CODE: CB



EBC Brakes® Band-It Bandana

Blue stretchy multi-purpose tubular bandana with EBC Brakes® logo printed in white. Provides warmth in the winter and in summer, the polyester material wicks moisture away from the skin keeping the wearer cool and protected from the sun. Ideal for all outdoor activities and especially loved by cyclists and motorcyclists to keep the cold air away from the skin.

ORDER CODE: BANDANA

EBC Brakes® Logo Carrier Bag

White polythene bag, 381 x 457 x 50mm with EBC Brakes® logo printed in blue and red on both sides. Reinforced handle.

ORDER CODE:

BAGS 100 (Pack of 100 bags)

BAGS 500 (Pack of 500 bags)



EBC Brakes® Logo Swivel Backrest Stool

Blue vinyl counter stool with EBC Brakes® logo printed in white to the backrest.

ORDER CODE: ST01



EBC Brakes® Logo Umbrella

The EBC Brakes® logo is printed in red and blue onto the four white panels of this navy and white umbrella. The shaft is made from fibreglass and is very strong, the umbrella is storm resistant and perfect for golf or a day watching the racing.

ORDER CODE: UB001



EBC Brakes Instructional DVD – Motorcycle

This DVD gives basic guidelines on fitting our brakes as well as safety instructions. It should be used alongside the vehicle manufacturers handbook and a competent service guide rather than used alone.

ORDER CODE: DVD008/1



EBC Brakes Logo® Scraper Floor Mat

A good looking EBC Brakes® logo slip resistant rubberised floor mat for use indoors or outdoors. Protects your floors by trapping oil, dirt and water. Easy to clean – simply shake out or hose off and dry.

ORDER CODE: FLOORMAT

NOTES

A large empty rectangular box with a black border, intended for handwritten notes.



EBC[®] **BRAKES**

EBC Brakes World Headquarters:

Upton Valley Way East, Pineham, Northampton NN4 9EF United Kingdom. Telephone: +44 (0)1604 583344

The letters EBC form a registered trademark in the USA, Canada, EU, UK, Asia and most countries worldwide.

www.ebcbrakes.com sales@ebcbrakesuk.com